

1³/₈" motorized modern metal and metal traverse systems



R-TEC AUTOMATION®

motorized metal traverse **NEW**

Motorize 1³/₈" Modern Metal and Metal traverse systems, creating smart design solutions for both residential and commercial environments.

The slim drapery motor is designed to install seamlessly behind the drapery panel with quiet start / stop operation, the ability to easily charge without having to remove the motor and up to 500 open and close cycles per charge, providing the ultimate integrated functionality without compromising the look of your window treatment.

Coordinates with 1³/₈" Modern Metal and Metal Collection finials and finishes.

Choose from any of our 50 standard hand painted finishes located on page 34 or your own custom finish.



R-TEC AUTOMATION®

R-TEC smart controls **NEW**

The R-TEC Automation® Hub and App integration allow draperies to be controlled directly from a smartphone or integrated device while at home or away. Now available in the Apple® App store or Google Play™, search for Rowley to find and download the new R-TEC Automation® App.

As an alternative, remotes and wall switches allow for individual, group and all control for a customized solution with 1, 5 and 15 channel options.

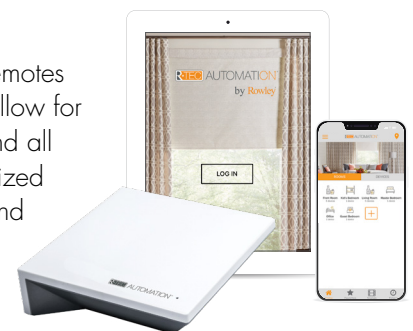

For more R-TEC Automation® window solution options, visit the Rowley Company website to view our compatible shade systems at: bit.ly/R-TEC-Automation-Shades

motorized metal traverse NEW

LI-ION BATTERY OR 110v AC POWER, RIPPLEFOLD OR PINCH PLEAT

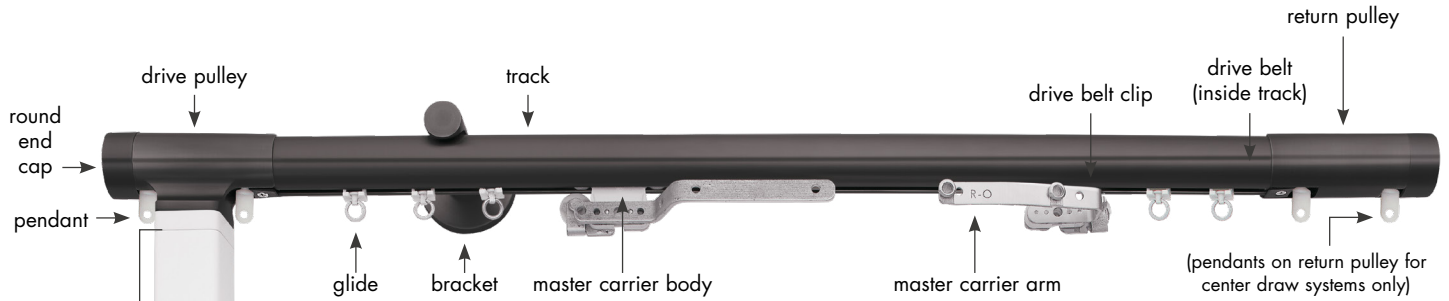

INCLUDED IN SYSTEM: R-TEC AUTOMATION® METAL TRAVERSE TRACK(S), ROUND METAL END CAPS, BRACKETS, COMPONENTS, MOTOR(S), POWER OPTION(S) & 5 CHANNEL HANDHELD REMOTE WITH WALL MOUNT

R-TEC Automation® slim drapery motor

- slim motor, 1 per metal traverse track
- maximum drapery weight: 77 lbs
- maximum track length: 24'
- power option: li-ion battery (includes battery charger & USB cable) or 110v AC power transformer (includes 10' cord with 3 conductor male plug)
- motor can be mounted on right or left for center draw
- available in white
- 5 year warranty

R-TEC metal traverse track

- track sold in 1 foot increments, 4' minimum
- maximum continuous length is 12' (select finishes); spliced lengths up to 24' (maximum of 2 splices per metal traverse track system)
- available in all finishes shown on page 9



R-TEC Automation® handheld remote with wall mount

- (5 channel)
- 4¾"H x 2"W x ¾"D
 - 1 remote control per system
 - range: 65'
 - programmable Favorite Position to set your favorite drapery position
 - available in off-white

motor & power options



RTMLDSS50
slim drapery motor



RTMLDSSB
li-ion battery



RTMLDSSBC
battery charger



RTMLDSSUSB
USB charger cable



RTMDSSPT
110v AC power transformer 10' (plug included)

features



2-way RF communication

integrated radio frequency control allows for easy programming of individual, group or all control across window treatments



adjustable speed

choose from three options to customize the open / close speed of the drapery treatment



preferred open / close limit settings

electronic "autoset" limits accurately program preferred open and close limit settings



favorite position

allows a most used or favorite position to be set between open and close limit settings



obstruction detection

if the drapery motion is obstructed while the motor is running, the motor stops automatically to prevent damage



manual override

permits the drapery to be adjusted manually without the use of a remote or in the event of a power outage



quiet operation

powerful, smooth and quiet operation suitable for both residential and commercial environments

motorized metal traverse NEW

LHON BATTERY OR 110v AC POWER, RIPPLEFOLD OR PINCH PLEAT
AVAILABLE IN 1 3/8" DIAMETER

single



single traverse system, wall mount
• wall bracket: 3 1/2" or 6" return options

double



double traverse system, wall mount
• wall bracket: 3" and 7 1/2" returns



single traverse system, ceiling mount
• ceiling bracket: 2 3/8" drop

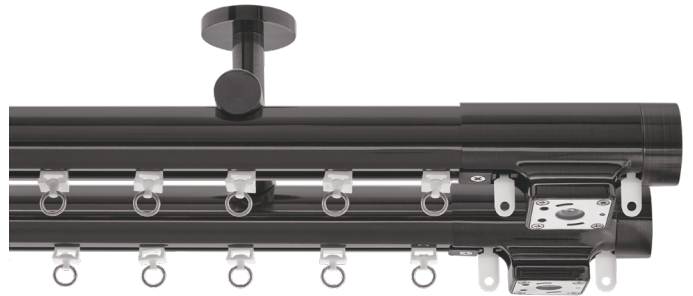

double traverse system, ceiling mount
• ceiling bracket: 2 5/8" drop, 4 1/2" apart



single traverse system, ceiling mount
• low-profile ceiling bracket: 5/32" drop



TFCM138191

- round end caps included
- see below for other end cap options and finial designs to coordinate with your motorized metal traverse system

finials

modern metal 1 3/8" collection

See pages 4 - 6 of the 2018 Drapery Hardware Catalog and website for more information on coordinating finial options. Finials require cuffs or collars to be used with tracks.



end caps

Round End Caps included; order our Bex End Cap pictured for an alternative look.



finials

Modern Metal Collection finials are designed to coordinate 1 3/8" motorized traverse systems.



cuffs & collars

Modern Collection finials coordinate with 1 3/8" cuffs and collars. Select a cuff or collar in any modern finish to attach the finial to your traverse system.

metal 1 3/8" collection

See page 11 of the 2018 Drapery Hardware Catalog and website for more information.



end caps

Round End Caps included; order our Wells End Cap pictured for a more stylized look.



finials

Select from 8 finial designs.

R-TEC smart controls NEW

motorized traverse



R-TEC Automation® App
Our App enables simple, intuitive control and system configuration from your smartphone or tablet.

Free app for iOS and Android



RTMHUB2
R-TEC Hub, 2-way RF; Wi-Fi built in
• 4½"H x 1¼"W x 4½"D
• range: 60'

Pair the R-TEC Hub and App with these systems (not sold by Rowley):



these additional accessories are available for purchase separately



RTMHR1C
handheld remote with wall mount, 1 channel
• 5 5/16"H x 1 1/4"W x 1/2"D
• range: 65'
• available in white



RTMHR5C
handheld remote with wall mount, 5 channel
• 4 3/4"H x 2"W x 3/8"D
• range: 65'
• available in off-white



RTMHR15C
handheld remote with wall mount, 15 channel
• 5 3/16"H x 1 1/4"W x 1/2"D
• range: 65'
• available in white



RTMWSR5C
surface mount wall switch 5 channel
• 4 1/2"H x 2 3/4"W x 7/8"D
• range: 65'
• available in white



RTMWSR15C
wall box mount switch 15 channel
• 4 1/2"H x 2 3/4"W x 1"D
• range: 65'
• available in white



RTMISS
interior sun sensor
• 1 3/4"H x 1 3/4"W x 5/8"D
• range: 65'
• available in white



RTMUSR
ARC USB signal repeater
• 2"L x 2 1/2"L with USB x 1 5/16"W
• extends the wireless range of the R-TEC Hub and remotes up to 60'
• maximum 2 repeaters per system or network
• available in white (color may vary)



RTMLWCW
wall charger for USB signal repeater
• 1 1/16"W x 1 11/16"L
• available in white (color may vary)



RTMSOLAR2
solar panel battery charger
• 4 5/8"H x 12 3/16"W x 1 3/8"D
• includes h-bracket, cables & fastener



motorized traverse

RTFC AUTOMATION®

carriers NEW

COMPONENTS ARE WHITE; TO ORDER COMPONENTS IN BRONZE, ADD /BR



- RTFC138MCB**
RTFC138MCB/BR
master carrier body
- select from different arms to assemble into one master carrier body
 - order two if ordering center draw master carrier arms - sold separately
 - available in white or bronze



- RTFC138CD**
master carrier arms
- stainless steel overlap arms
 - pair
 - pinch pleat or Ripplefold
 - order two master carrier bodies - sold separately



- RTFC138PPOR**
RTFC138PPOL
pinch pleat master carrier arm
- stainless steel arm
 - right (R) or left (L)
 - pinch pleat
 - order one master carrier body - sold separately



- RTMDTCDB**
Ripplefold butt master carrier arms
- stainless steel arms with snaps to accept Ripplefold tape
 - pair
 - Ripplefold
 - butt master carriers do not overlap, allowing some light to filter between draperies on center draw treatments
 - butt master carriers must be specified for substitution
 - order two master carrier bodies - sold separately



- RTFC138OBR**
RTFC138OBL
Ripplefold butt master carrier arm
- stainless steel arm with snaps to accept Ripplefold tape
 - right and left
 - Ripplefold
 - butt master carriers do not overlap, allowing some light to filter between draperies on center draw treatments
 - butt master carriers must be specified for substitution
 - order one master carrier body - sold separately

master carrier body, available in white or bronze, is required for each master carrier arm - sold separately



- CP40** **CP40/BR**
pinch pleat glide
- available in white or bronze

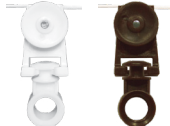

- R4060** | **R4060/BR** 60% fullness
R4080 | **R4080/BR** 80% fullness
R4100 | **R4100/BR** 100% fullness
R4120 | **R4120/BR** 120% fullness
- Ripplefold roller glide
- Ripplefold glides with detachable pendants
 - fullness 60%, 80%, 100% or 120%
 - available in white or bronze



- BT4333**
glide stop
- stainless steel

component colors

	White	Bronze
Master Carrier Body	•	•
Glides	•	•

brackets

EASY TO INSTALL - ATTACH TO TRACK WITH A SET SCREW



- TFCMT138400**
1 3/8" metal wall bracket, single
3 1/2" return, 2 7/16" Dia backplate



- TFCMT138402**
1 3/8" metal wall bracket, double
7 1/2" front and 3" back return, 2 7/16" Dia backplate



- TFCMT138404**
1 3/8" metal ceiling bracket, double
2 5/8" drop, 4 1/2" apart, 1 7/8" Dia ceiling plate

- TFCMT138401**
1 3/8" metal wall bracket, single
6" return, 2 7/16" Dia backplate



- TFCMT138403**
1 3/8" metal ceiling mount bracket
2 3/8" drop, 1 7/8" Dia ceiling plate



- TFCMT138405**
1 3/8" metal ceiling bracket extender
2" drop



- TFCMT138406**
1 3/8" low profile metal ceiling bracket
5/32" drop



- TFCMT138407**
connector/splice
3" L

finishes

1 3/8" modern metal



CH Chrome



BN Brushed Nickel



SG Satin Gold



BBN Brushed Black
Nickel

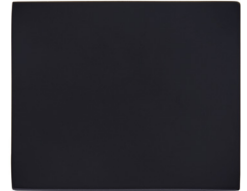

MK Matte Black

- maximum continuous track length in CH and SG is 8', all other finishes available up to 12'
- center draw tracks can be spliced for longer lengths up to 24', see order form on pages 10 - 11 for details

1 3/8" metal



PN Polished Nickel



AP Antique Pewter



AB Antique Brass



BZ Brushed Bronze



ORB Oil Rubbed
Bronze



SK Satin Black



MK Matte Black
coordinates with
VZ & DRB finials



VZ

DRB

- maximum continuous track length in BZ and ORB is 8', all other finishes available up to 12'
- center draw tracks can be spliced for longer lengths up to 24', see order form on pages 10 - 11 for details
- Matte Black (MK) tracks and brackets coordinate with Venetian Bronze (VZ) and Dark Oil Rubbed Bronze (DRB) finials

custom finishes

our 1 3/8" R-TEC Automation® metal traverse is also available in any of our 50 beautifully hand painted standard finishes located on the back cover of the 2018 Drapery Hardware Catalog or your own custom finish; please see retail price list for standard and custom finish surcharges

motorized traverse

how to order your 1 3/8" motorized metal traverse system in 5 easy steps

1 SELECT YOUR TRAVERSE SYSTEM

WALL MOUNT



- single traverse wall mount
- return choice:
 - 3 1/2"
 - 6"



- double traverse wall mount

CEILING MOUNT



- single traverse ceiling mount



- single traverse ceiling clip

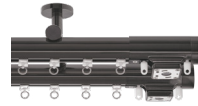

- double traverse ceiling mount

2 SELECT A TRACK WIDTH AND FINISH

MODERN METAL TRAVERSE

	1 3/8" Dia	Track Cut Length (in.)	Max. Length
CH Chrome	<input type="checkbox"/>		192" Center 96" One-Way
BN Brushed Nickel	<input type="checkbox"/>		288" Center 144" One-Way
SG Satin Gold	<input type="checkbox"/>		192" Center 96" One-Way
BBN Brushed Black Nickel	<input type="checkbox"/>		288" Center 144" One-Way
MK Matte Black	<input type="checkbox"/>		288" Center 144" One-Way

METAL TRAVERSE

	1 3/8" Dia	Track Cut Length (in.)	Max. Length
PN Polished Nickel	<input type="checkbox"/>		288" Center 144" One-Way
AP Antique Pewter	<input type="checkbox"/>		288" Center 144" One-Way
AB Antique Brass	<input type="checkbox"/>		288" Center 144" One-Way
BZ Brushed Bronze	<input type="checkbox"/>		192" Center 96" One-Way
ORB Oil Rubbed Bronze	<input type="checkbox"/>		192" Center 96" One-Way
MK Matte Black*	<input type="checkbox"/>		288" Center 144" One-Way
SK Satin Black	<input type="checkbox"/>		288" Center 144" One-Way

*Coordinates with Venetian Bronze (VZ) and Dark Oil Rubbed Bronze (DRB) finials.

3 SELECT YOUR DRAPERY STYLE



PINCH PLEAT

- overlap



RIPPLEFOLD

- overlap
- butt master
- 60%
- 80%
- 100%
- 120% fullness

4 COMPLETE YOUR TRAVERSE SPECIFICATIONS

Power Options:

Li-ion Battery (includes battery charger & USB cable)

110v AC Power Transformer (includes 10' cord with 3 conductor male plug)

Additional Power Options Sold Separately:

Solar Panel Charger
(includes hbracket, cables & fastener)

Additional Power Options Sold Separately:

110v AC Power Transformer (includes 20' cord, requires plug below)
 3 Conductor Male Plug

Direction:

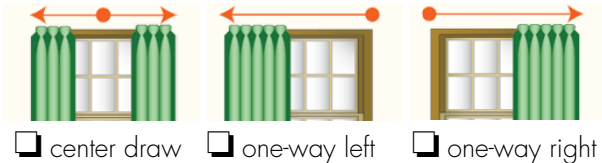

Component Colors:

White Bronze

	White	Bronze
Master Carrier Body	•	•
Glides	•	•

5 ADD ON FINIALS, CUFFS OR COLLARS must be selected with finials

MODERN METAL TRAVERSE

	finial	finial finish	metal modern cuff	metal modern collar	metal transitional collar	cuff/collar finish
TFCM600 Bryant	<input type="checkbox"/>		<input type="checkbox"/>	<input type="checkbox"/>	<input type="checkbox"/>	
TFCM600/CL Bryant Acrylic	<input type="checkbox"/>	-	<input type="checkbox"/>	<input type="checkbox"/>	<input type="checkbox"/>	
TFCM601 Declan	<input type="checkbox"/>		<input type="checkbox"/>	<input type="checkbox"/>	<input type="checkbox"/>	
TFCM601/CL Declan Acrylic	<input type="checkbox"/>	-	<input type="checkbox"/>	<input type="checkbox"/>	<input type="checkbox"/>	
TFCM602 Upton	<input type="checkbox"/>		<input type="checkbox"/>	<input type="checkbox"/>	<input type="checkbox"/>	
TFCM602/CL Upton Acrylic	<input type="checkbox"/>	-	<input type="checkbox"/>	<input type="checkbox"/>	<input type="checkbox"/>	
TFCM603 Delano	<input type="checkbox"/>		<input type="checkbox"/>	<input type="checkbox"/>	<input type="checkbox"/>	
TFCM604 Mercer	<input type="checkbox"/>		<input type="checkbox"/>	<input type="checkbox"/>	<input type="checkbox"/>	
TFCM605 Luca	<input type="checkbox"/>		<input type="checkbox"/>	<input type="checkbox"/>	<input type="checkbox"/>	
TFCM606 Stiles	<input type="checkbox"/>		<input type="checkbox"/>	<input type="checkbox"/>	<input type="checkbox"/>	
TFCM691 Anson	<input type="checkbox"/>		<input type="checkbox"/>	<input type="checkbox"/>	<input type="checkbox"/>	
TFCM691/CL Anson Acrylic	<input type="checkbox"/>	-	<input type="checkbox"/>	<input type="checkbox"/>	<input type="checkbox"/>	
TFCM692 Eason	<input type="checkbox"/>		<input type="checkbox"/>	<input type="checkbox"/>	<input type="checkbox"/>	
TFCM692/CL Eason Acrylic	<input type="checkbox"/>	-	<input type="checkbox"/>	<input type="checkbox"/>	<input type="checkbox"/>	
TFCM138690 Bex 1 ³ / ₈ " End Cap	<input type="checkbox"/>		-	-	-	-

METAL TRAVERSE

	finial	finial finish
TFCM138100 Turner	<input type="checkbox"/>	
TFCM138101 Britton	<input type="checkbox"/>	
TFCM138102 Ashby	<input type="checkbox"/>	
TFCM138103 Abington	<input type="checkbox"/>	
TFCM138104 Harlow	<input type="checkbox"/>	
TFCM138105 Weston	<input type="checkbox"/>	
TFCM138106 Brentford	<input type="checkbox"/>	
TFCM138107 Rothwell	<input type="checkbox"/>	
TFCM138190 Wells End Cap	<input type="checkbox"/>	