



## DC Tubular Motors

DC motorized shades are ideal when designing a new home, motorizing an existing home or planning a commercial project. DC wired shades are maintenance free and the AC power supply adapter keeps installation costs to a minimum.

- 2-way RF communication with ARC™ protocol for simple programming
- Narrow width applications
- 3 operational speed settings
- Leveling control
- Electronic limit setting and adjustment
- Favorite position
- Requires Battery Pack, Battery Tube or Power Supply

### Additional Options:

- Motor End Covers
- R-TEC Smart Controls

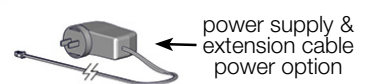
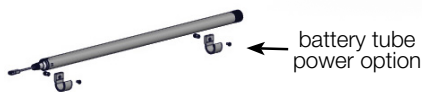
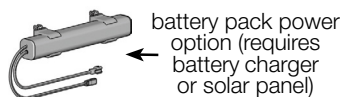
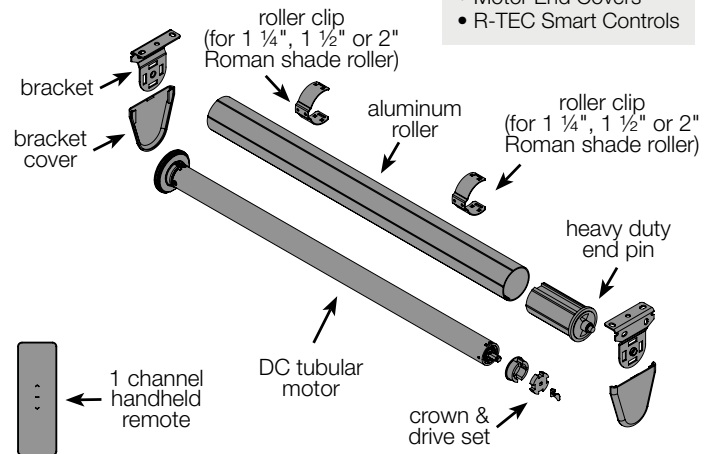

# FEATURES



2-Way RF  
Communication



Adjustable  
Speed



Leveling  
Control

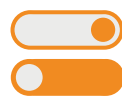

Preferred  
Upper / Lower  
Limit Settings



Favorite  
Position



Quiet  
Operation

## APPLICATIONS



Roman  
Shade



Roller  
Shade



Narrow  
Applications

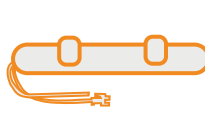

Battery Pack &  
Battery Charger

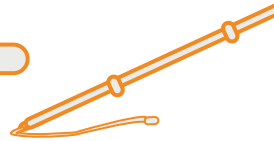

Battery  
Tube



Power  
Supply



Solar Panel  
Battery Charger

## POWER OPTIONS

## SOLAR

# SPECIFICATIONS

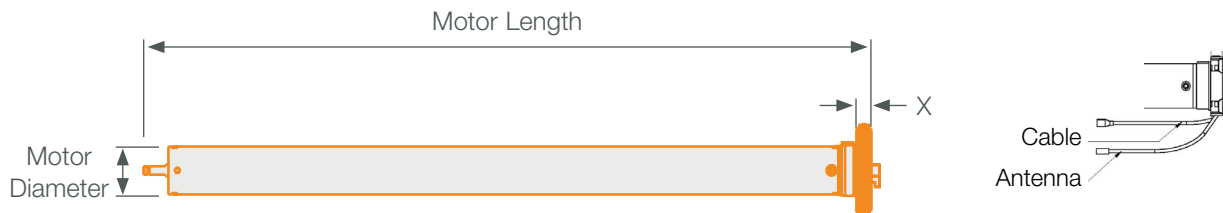

## MOTOR SPECS

Motor Size	Voltage	Torque	Max. Run Time	Speed	Motor Length	Motor Diameter	X	Cable / Antenna	Amps	Sound Level
25 mm	12 V DC	1.1 Nm	6 min.	40 RPM (Adj. to 30 or 20)	13 7/16"	1"	5/16"	-	0.83 A	~36 DB
28 mm		2.0 Nm	10 min.	28 RPM (Adj. to 24 or 20)	19 3/16"	1 1/8"	5/16"	-	1.25 A	~44 DB
35 mm		3.0 Nm	10 min.	28 RPM (Adj. to 24 or 20)	18 1/16"	1 3/8"	3/8"	6"	1.67 A	~53 DB

## SYSTEM SPECS

Item #	Motor Size & Style	Style	Tube Dia.	Max. Size	Min. Roller Shade Width / Roller Tube Length	Min. Roman Shade Width / Dustboard Length	Max. Load
RTMDCZ25	25 mm Skyline Head	Standard	1 1/4"	84" x 84"	16 1/2"	18"	15 1/2 lbs.
			1 1/2"	84" x 84"	16 1/2"	18"	13 lbs.
RTMDCZ28	28 mm Skyline Head	Quiet	1 1/2"	120" x 120"	22"	23 1/2"	23 1/2 lbs.
			2"	120" x 120"	22"	23 1/2"	17 1/2 lbs.
RTMDC35	35 mm	Standard	2"	120" x 120"	23 1/2"	25"	26 1/2 lbs.