

Roller Shade Installation Instructions Using a Skyline Easy Link System & Clutch

Please read all instructions before starting

INTRODUCTION:

The **Skyline Easy Link System** is used with clutch drive shade systems to allow one clutch to drive multiple roller shades or one wide Roman shade.

The total allowable weight will depend on the clutch selected. Please refer to the relevant clutch instructions.



Figure 1A below shows an assembled Manual Clutch system using a Skyline Easy Link System.

PARTS LIST. See Figure 1.

1. Male Drive
2. Bracket
3. Female Drive
4. Bearing
5. 2" Tube Adapter
(if required)

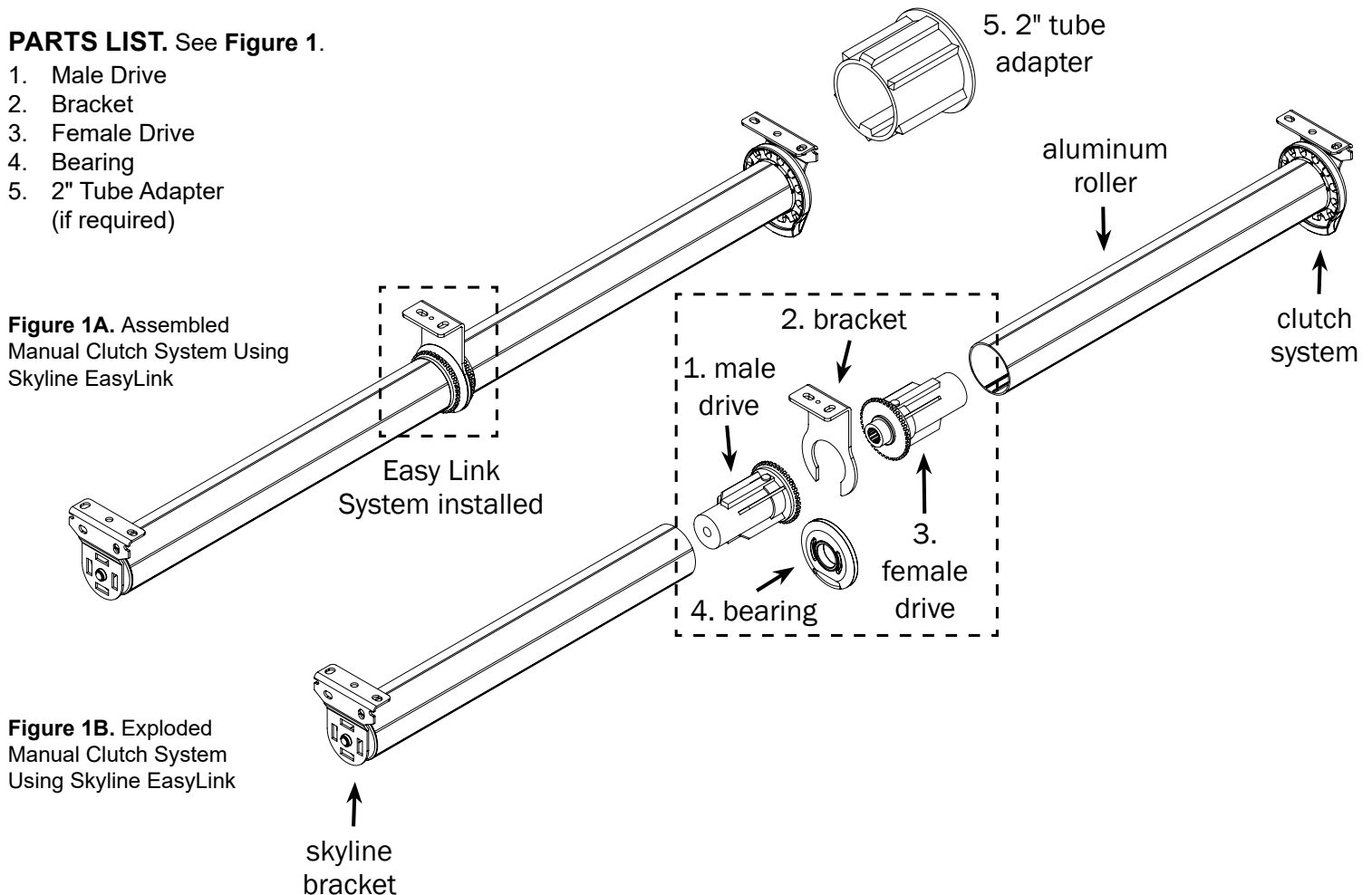

CALCULATIONS:

Step 1. Refer to the relevant instructions for clutches and find Deduction-from-overall-width.



Step 2. Add Easy-Link Deduction of 3/4" to Deduction-From-Overall-Width to get total deduction.

Step 3. Calculate each tube section cut length.

EXAMPLE #1

Designed Roman shade width is 93 1/2", using the Skyline Clutch RSC30112 with 1 1/2" Roller. The Roman shade will be mounted on two tube sections with an Easy Link at the center.

Deduction-from-overall-width is 1 3/8"

One Easy Link deduction is 3/4"

The total deduction is 1 3/8" + 3/4" = 2 1/8", or there needs to be 1 1/16" deduction from each tube section.

Each tube section is 93 1/2" - 2 1/8" divided by 2, or 45 11/16".

EXAMPLE #2

Designed to have two Roller shades to cover a 110 5/8" wide space, using the Skyline Clutch RSG200HD112 with 1 1/2" Roller. Easy Link needs to be placed at 46 1/2" from left end.

Deduction-from-overall-width is 1 7/16"

One Easy Link deduction is 3/4"

The total deduction is 1 7/16"+3/4"=2 3/16", or there needs to be 1 1/8" deduction from each tube section.

The left tube section is 46 1/2" - 1 1/8", or 45 3/8"

The right tube section is 110 5/8" - 46 1/2" - 1 1/8", or 63"

BRACKETS & BRACKET COVERS:

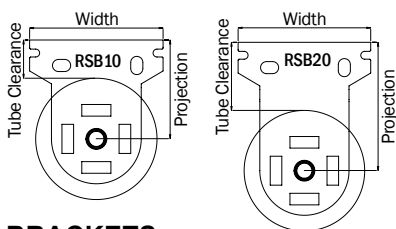

BRACKET COVERS:

Item #	Fits
RSBC10/	RSB10
RSBC20/	RSB20

Available in White /W, Satin Nickel /SN and Black /K. Narrow brackets do not work with covers.

BRACKETS:

Item #	Proj.	Tube Clearance			Width
		1 1/4"	1 1/2"	2"	
RSB10	1 5/8"	1"	7/8"	5/8"	2 1/4"
RSB20	2 1/8"	1 1/2"	1 3/8"	1 1/8"	2 1/4"

Zinc. Work with bracket covers.

Item #	Proj.	Tube Clearance			Width
		1 1/4"	1 1/2"	2"	
RSNB10	1 5/8"	1"	7/8"	5/8"	1 1/2"
RSNB20	2 1/8"	1 1/2"	1 3/8"	1 1/8"	1 1/2"
RSNB30	2 7/8"	2 1/4"	2 1/8"	1 7/8"	1 1/2"

Zinc. Don't work with bracket covers.

MEASUREMENT:

Step 1. See **Figure 2.**

A. Inside Mount: Measure the Width inside the casing (jam-to-jam, or casing-to-casing), where the brackets will be installed; and the Length from the top of the bracket to the bottom of the window. Mark your location.

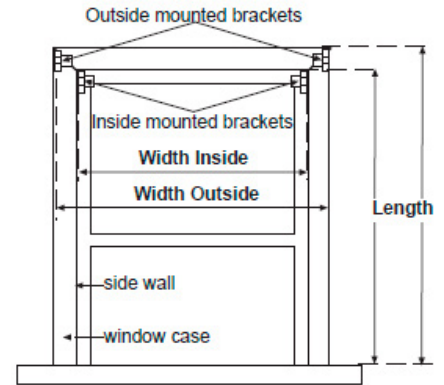

Figure 2. Measurements on a window

B. Outside Mount: Measure the Width outside between the outer edges of the window trim where the brackets will be installed; and the Length from the top of the bracket to the bottom of the window. Mark your location.

NOTE: Measure all windows for accuracy even though they may look the same.

INSTALLATION:

Step 1. Mount the brackets to the window casing according to the marked locations in **Figure 2** (see above). **Figure 3** shows the proper bracket placement options. The left and right Skyline brackets are identical so the motor can be mounted on the left or the right side.

A. To Inside of Window Casing

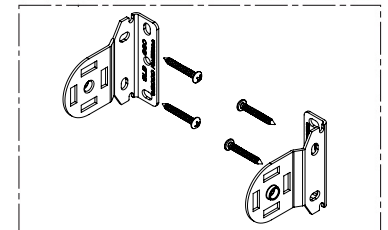

B. To Wall or Front of Window Casing

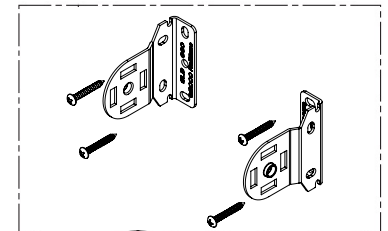

C. To Ceiling or Top of Window Casing

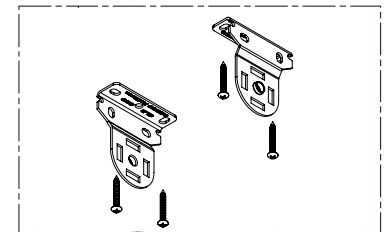
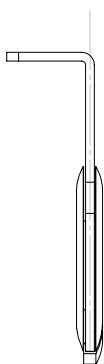

Figure 3. Install Brackets

Step 2. Mark and mount the Easy Link bracket between the two end brackets, determined by the min. and max. allowable shade size and roller tube length. Measure the location of Easy Link bracket using the centerline of the bracket arm, not the mounting holes.



Step 3. Install the Easy Link Bearing into the bracket. The groove on the OD of the bearing will clip into the bracket.



Step 4. Install the Female Drive into the end of the Tube. Make sure to align the groove in the tube with the large spline on the female drive.

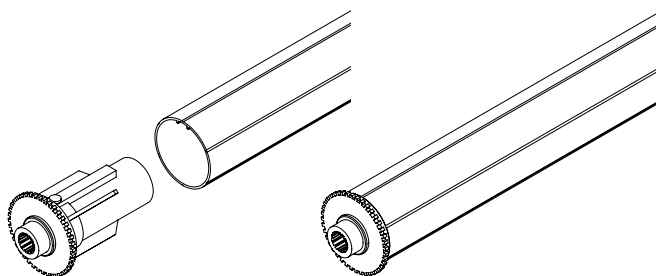

Step 5. Insert the heavy duty end pin side of the tube into the center hole of the wall bracket.

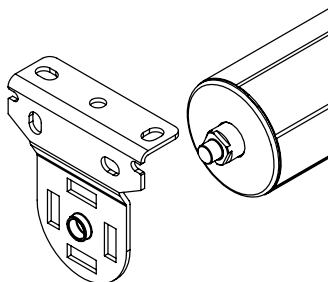

Step 6. Rotate the splined collar on the Female Drive End, which will retract the spring loaded pin to be inserted into the hole in the bearing.

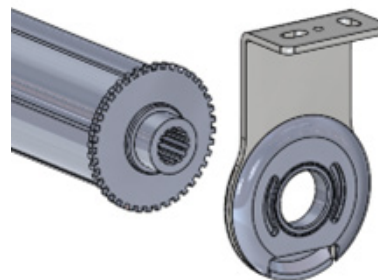

Step 7. Install the Male Drive into the end of the Tube. Make sure to align the groove in the tube with the large spline on the male drive.

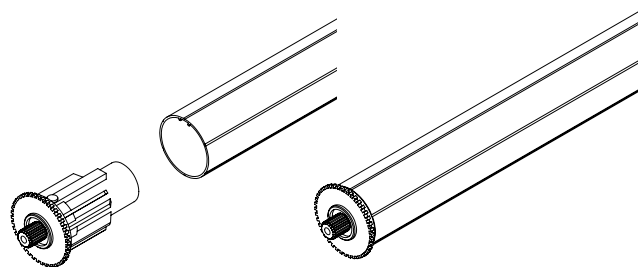

Step 8. Rotate the splined collar on the Male Drive end, this will retract the spring loaded pin to be inserted into the hole in the bearing. Make sure both male and female drives are connected into each other in the bearing.

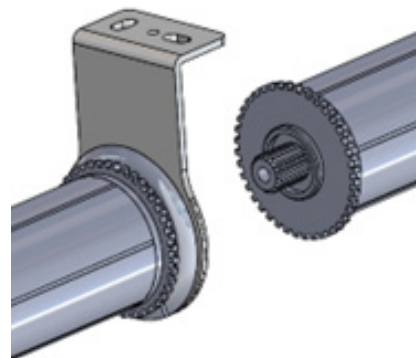

Step 9. Slide the bracket covers onto the brackets.

