

Quick Ship 1 1/8" Inside Mount Single Bracket Installation Instructions

QS118IMBK

1 1/8" Inside Mount Single Bracket

Thank you for purchasing your new Paris Texas Hardware™ Brackets. Proper installation of the brackets will provide you with many years of beauty and trouble free use. Clean with a soft cloth. Do not use harsh or abrasive cleaning supplies or polishes which may damage the finish.

Components Included for each Bracket

- Bracket
- Screws
- Instructions



Tools Needed for Installation (not included)

- Tape Measure
- Pencil
- Level (recommended)
- Phillips screwdriver
- Drill with 3/16" drill bit to pre-drill for plastic expansion anchors

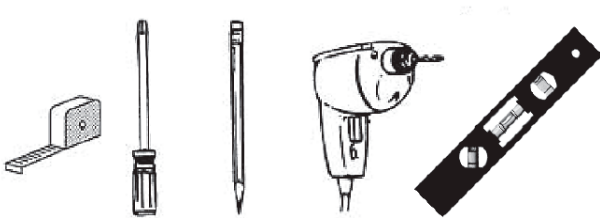

Tips for Successful Installation

Securely attach all Brackets to the mounting surface. If you do not locate and install into wood studs, use the proper wall fasteners and / or plastic anchors designed for your particular mounting surface (fasteners are included). When drilling into metal, use self-tapping screws (not included).

Make certain all Brackets line up evenly by measuring their placement.

1 1/8" Inside Mount Single Bracket Installation

1. Locate correct anchors for your wall type.

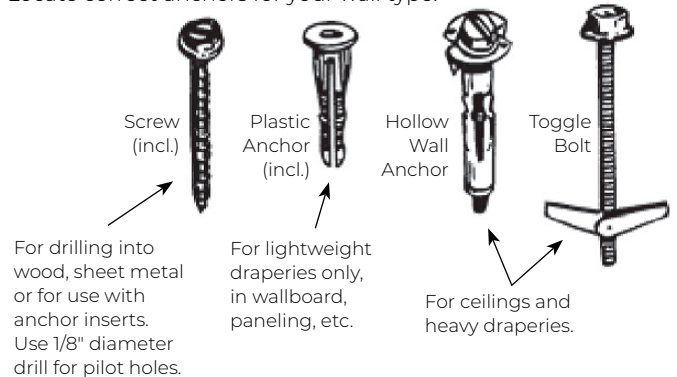

IMPORTANT: We suggest always installing brackets into wall studs for added security. If not installing into wall studs, be sure to use appropriate fasteners for your wall type.

Based on length of pole, width of window and position of wall studs, determine the desired height and width. Be certain to make the appropriate allowance for the decorative hardware. It is recommended that the Bracket be installed approximately 2" or more inches beyond the window frame.

2. Based on length of drapery and installation method (ring, ring with clip or rod pocket), establish distance of bracket from floor, using the template on the next page as a guide.
3. Once template position is established, locate cross-hairs that indicate screw placement. Firmly press pencil into cross-hairs and through paper, leaving a slight mark on the wall.
4. Attach the metal lock plate (B) securely to the wall by drilling into the screw placement marks, through bracket holes (A), using anchor screws (C). See Figure 1 on page 2.
5. Place bracket onto metal key lock plate (B). Twist to secure. NOTE: if bracket is not flush against the wall, remove the bracket from the metal key lock plate and use a screwdriver to adjust the anchor screws (A) until the bracket fits securely into the metal plate.
6. While holding the second bracket in position on the opposite side of the window, place the pole in both cradles. Use a level to find the best height for the second bracket.
7. Once the pole is level, lightly mark the position of the second bracket on the wall.
8. Place the template into position and repeat steps 3-7. Use the same method for center support brackets.

Quick Ship 1 1/8" Inside Mount Single Bracket Template

QS118IMBK

IMPORTANT for Installation

Measurements are to the nearest 1/8". Check printed template for accuracy with ruler before installation!

TIP » For best accuracy when printing this PDF, choose "none" for page scaling. Do not "fit to page."

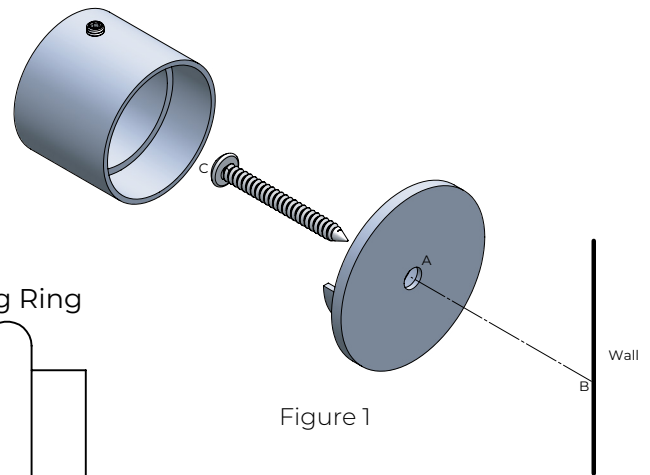
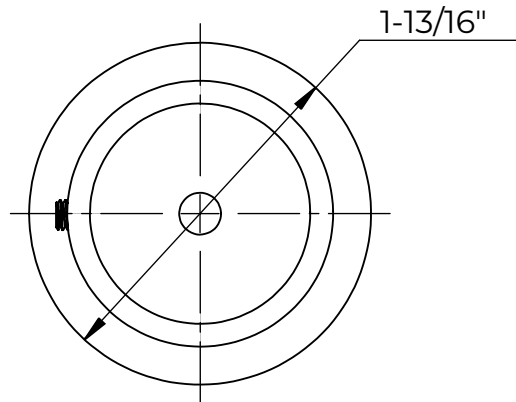

Figure 1

