

# MOTORIZED TRACK CENTER OR ONE-WAY DRAW SYSTEMS INSTALLATION INSTRUCTIONS

Please read all instructions before starting

## INTRODUCTION:

The Motorized Track System is used to electronically control the drapery using a Slim Drapery Motor and Remote Control. By using a Remote Control or the Automate® Pulse 2 App via a smartphone or tablet, the operator can open and close the drapery smoothly and precisely.

The maximum width for this system is 19' continuous and 36' spliced. The minimum width for this system is 37". The maximum drapery weight is 110 lbs. Single or Double System.

## BRACKET ASSEMBLY:

The Motorized Track can be mounted on the wall or ceiling.

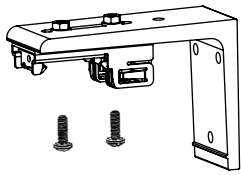

Wall Mount Assembly

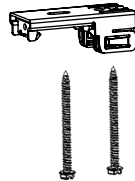

Ceiling Mount Assembly

NOTE: The installer is responsible for selecting the correct fastener for attaching the ceiling mount clip to the ceiling.

## PARTS LIST:

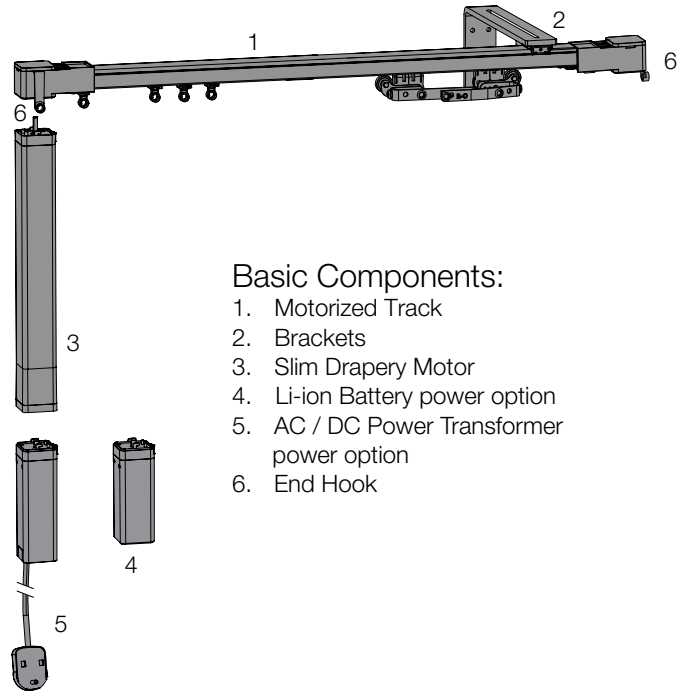

### Basic Components:

1. Motorized Track
2. Brackets
3. Slim Drapery Motor
4. Li-ion Battery power option
5. AC / DC Power Transformer power option
6. End Hook

## BRACKET PLACEMENT:

It's recommended to use 1 bracket beside each pulley. On the remaining part of the R-TEC Automation® Track, bracket-to-bracket distances should be no more than 24". Also, 1 bracket should be placed on each side of a splice if used.

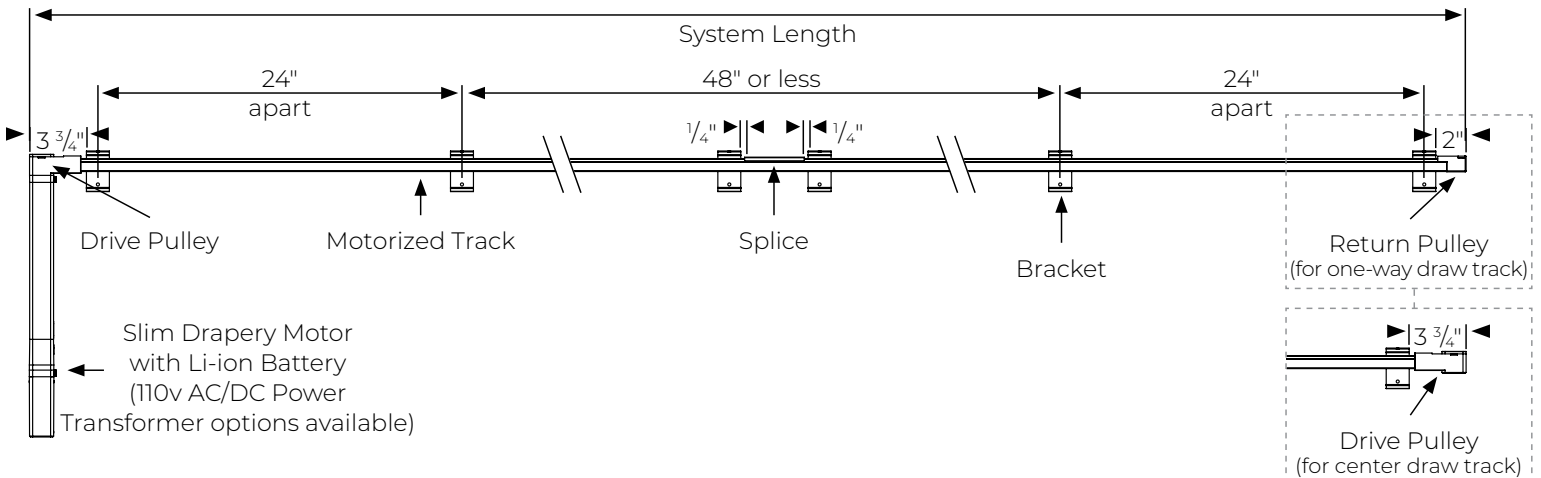

## INSTALLATION:

We recommend using a professional installer. Installation hardware is included. The fasteners (screws and anchors) may not be appropriate for every installation or wall material. Brackets and holdbacks should be installed securely into wall studs when possible. Rowley will not assume responsibility for damages incurred by improperly mounted or inadequately supported hardware.

WALL MOUNT TRACK SYSTEM INSTALL:

NOTE: Installer is responsible for determining the correct mounting fastener and wall location per the wall construction type.

Step 1. Locate brackets.

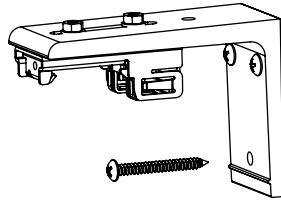

Step 2. Mount brackets to wall.

Step 3. Install system at an angle.

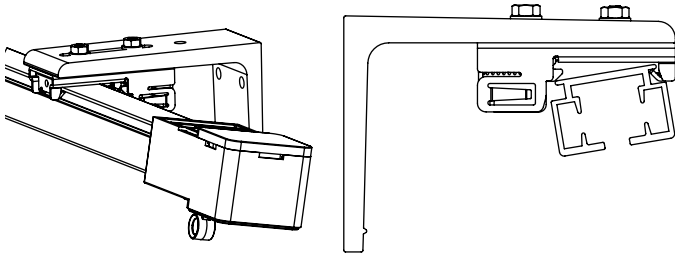

Step 4. Push system upward until system clicks in place.

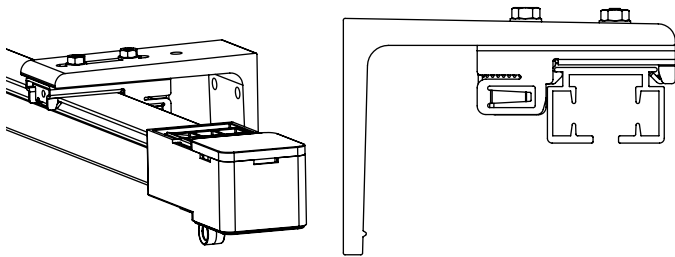

NOTE: To release track, push release lever.

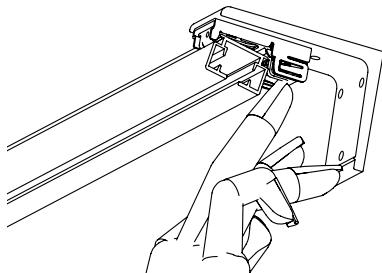

Step 5. Install End Hook on both Drive Pulleys.

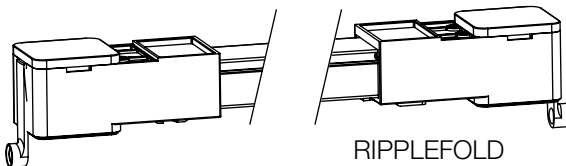
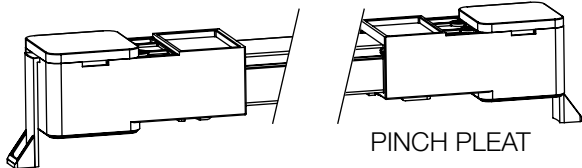

CEILING MOUNT TRACK SYSTEM INSTALL:

NOTE: Installer is responsible for determining the correct mounting fastener and wall location per the wall construction type.

Step 1. Locate ceiling mount brackets.

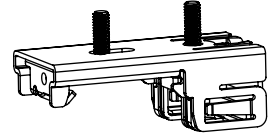

Step 2. Mount bracket to ceiling.

Step 3. Install system at an angle.

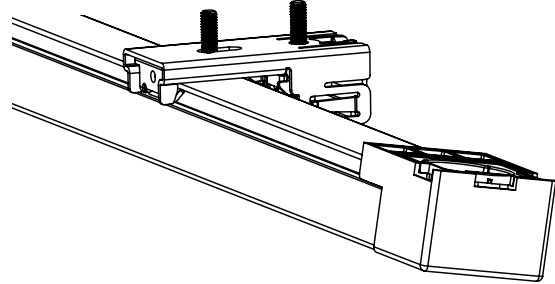

Step 4. Push system upward until system clicks in place.

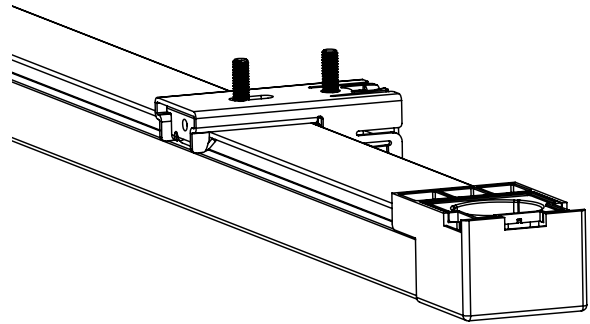

NOTE: To release track, push release lever.

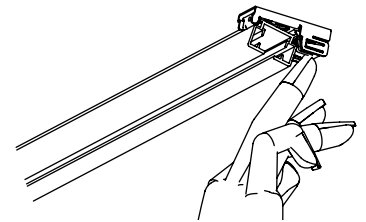

Step 5. Install End Hook only on the Drive Pulley side.

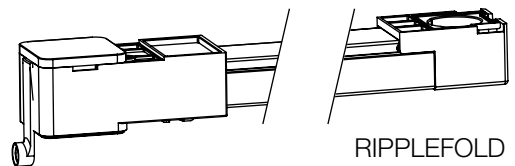
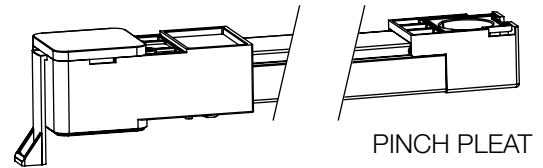

NOTE: Carriers can be added or removed with the Drive Pulley installed.

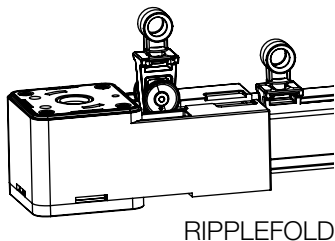
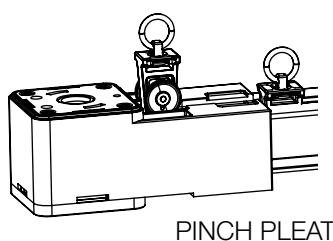

Step 6. Install the End Stops.

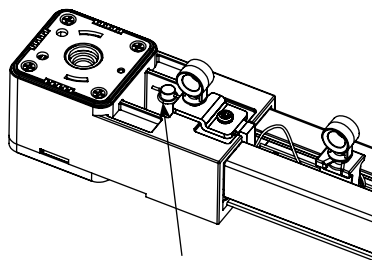
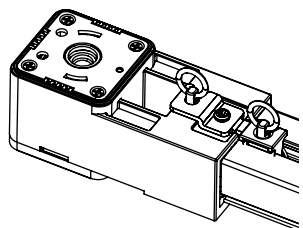

Troubleshooting:

Belt slipping – A popping or grinding sound maybe heard when system is running for the first time.

Step 1. Loosen screw

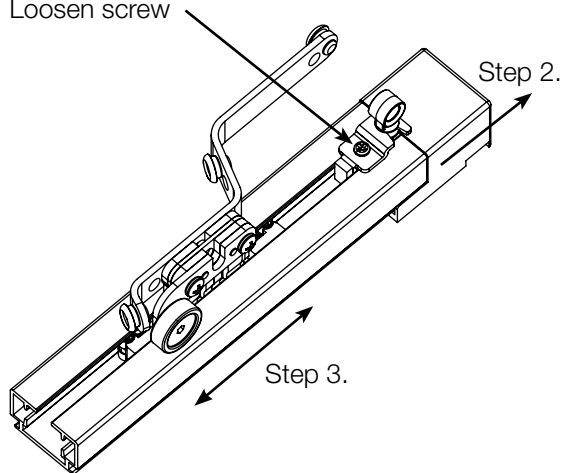

Step 2. Gently pull end pulley forward.

Step 3. Move the master carrier back & forward. If master carrier moves freely, tighten all screws. Attach motor.

NOTE: If the master carrier does not move freely, loosen both end pulleys on the drapery system. Repeat Step 3.

If the system is still having issues, please contact customer service.

How to get started using your Motorized Heavy Duty Track System:

- Please read all the instructions provided with your Slim Drapery Motor.
- Your motor will be shipped in “sleep mode” and must be woken up before using.
- You will need a remote control or a smartphone to set up and control your Slim Drapery Motor.
- Only use power options for your motor that are available through Rowley Company.