



# Instruction Manual HANG ON BRACKET 162984



**Maximum Weight Capacity (User and Equipment) - 300 pounds (136 kg)**

  
**WARNING!**

ONLY FOR USE WITH APPROVED GAME WINNER TREESTAND MODEL 161732 OVERSIZED EZ SET HANG ON TREESTAND. Treestands sold separately.

Failure to follow these instructions can lead to serious injury or death!

 **ATTENTION**

**YOU MUST READ ALL WRITTEN INSTRUCTIONS AND WATCH THIS SAFETY VIDEO BEFORE USING!**



**WATCH THIS SAFETY VIDEO BEFORE USING!**

Scan 



or Visit 

[www.standsafety.com/in1](http://www.standsafety.com/in1)

Scan the QR code with your smart phone, tablet or similar device.

**OR**

Type the website address into your web browser to view an important safety video before using this product.

**HANG-ON STAND SAFETY**

 Every year people are injured from hunting related falls. Most of these injuries could have been prevented by following the instructions and warnings provided with the tree stand and safety harness. Tree stands are used at height and falls can result in serious injury or death. Your own safety, and the safety of any user of this product, should be your first priority. In order to reduce your risk of injury, you **MUST** read and thoroughly understand all of the safety warnings, usage instructions and other information contained within the written and safety video instructions and warnings provided with this product, and any other hunting equipment used. Retain the instructional and warning materials and review them periodically (at least once a year and always with any new user). Failure to follow all instructions and warnings may lead to serious injury or death. **DO NOT USE THIS PRODUCT UNTIL AND UNLESS YOU HAVE READ AND THOROUGHLY UNDERSTAND ALL INSTRUCTIONS, SAFETY WARNINGS AND OTHER MATERIALS.** If you have any questions, do not use the product until you have contacted the manufacturer at 949-262-3416 or email [customerservice@innopower.biz](mailto:customerservice@innopower.biz).

## Business Hours:

**Monday through Friday, 8:00 am to 5:00 pm ET. If you are unable to speak with a representative, please leave a voicemail with your contact information and your call will be returned within one (1) business day.**

**For Customer Service, please call [949-262-3416](tel:949-262-3416) or**

**E-mail: [customerservice@innopower.biz](mailto:customerservice@innopower.biz)**



(Made In China)

Warnings .....	3-8
Parts List .....	9
Product Diagram .....	9
Installation Instructions .....	10-15
Removal Instructions .....	16
Care and Maintenance .....	16
Warranty Information .....	17

Note: Before beginning assembly of product, make sure all parts are present. Compare parts with package content list and hardware contents. If any part is missing or damaged do not attempt to assemble the unit. Contact customer service for replacement parts.

# Warnings

## ATTENTION!

 WHEN YOU SEE A  SYMBOL OR THE WORD "WARNING!" BE SURE TO READ THE MESSAGE! THE INFORMATION CONTAINED IN THESE MESSAGES CAN SAVE YOUR LIFE OR PREVENT SERIOUS INJURY!! BE SAFE! FOLLOW ALL WARNINGS!!

 WARNING! FALLS FROM A TREESTAND CAN OCCUR ANYTIME AFTER LEAVING THE GROUND. THESE FALLS RESULT IN EITHER SERIOUS INJURY OR DEATH! FOR YOUR PERSONAL SAFETY, PLEASE TAKE A MOMENT TO CAREFULLY READ THIS PRODUCT INSTRUCTION MANUAL IN ITS ENTIRETY BEFORE ATTEMPTING TO ASSEMBLE, SET-UP, INSTALL AND/OR OTHERWISE USE THIS GAME WINNER PRODUCT. ANNUALLY REVIEW THE CONTENTS OF THIS INSTRUCTION MANUAL. ADDITIONALLY, KEEP THESE INSTRUCTIONS FOR THE ENTIRE DURATION YOU OWN THIS PRODUCT(S). FAILURE TO FOLLOW THESE INSTRUCTIONS MAY RESULT IN SERIOUS INJURY OR DEATH!

 WARNING! THE SAFE USE AND OPERATION OF THIS PRODUCT(S) IS THE SOLE RESPONSIBILITY OF THE USER. IT IS THE SOLE RESPONSIBILITY OF THE OWNER TO PROVIDE ANY PERSON(S) WHO BORROW OR PURCHASE THIS PRODUCT WITH ALL WRITTEN AND SAFETY VIDEO INSTRUCTIONS AND WARNINGS PRIOR TO USE. DO NOT ALLOW A PERSON TO USE THE PRODUCT THAT HAS NOT REVIEWED ALL WRITTEN AND SAFETY VIDEO INSTRUCTIONS AND WARNINGS PRIOR TO USE. FAILURE TO FOLLOW THESE INSTRUCTIONS MAY RESULT IN SERIOUS INJURY OR DEATH! STORE ALL WRITTEN AND SAFETY VIDEO INSTRUCTIONS AND WARNINGS IN A SAFE LOCATION WHERE THEY CAN BE SHARED WITH POTENTIAL USERS. IF ANY INSTRUCTIONS OR WARNINGS ARE LOST OR DISCARDED, DO NOT USE THE PRODUCT AND DO NOT ALLOW ANY OTHER PERSON TO USE THE PRODUCT.

 WARNING! THIS PRODUCT CARRIES A STRICT WEIGHT LIMITATION. DO NOT USE THIS PRODUCT IF YOU EXCEED THIS TOTAL LIMIT. PLEASE NOTE THIS WEIGHT LIMIT INCLUDES THE USER AND EQUIPMENT. FAILURE TO FOLLOW THESE INSTRUCTIONS MAY RESULT IN SERIOUS INJURY OR DEATH!

 WARNING! Prior to each hunt, make certain you have a signaling device (e.g., mobile phone, cell phone, radio, whistle, signal flare, Personal Locator Device [PLD], etc.) in your possession and on your person in an operable condition. This device must be within easy access should you experience the need to contact emergency assistance. Failure to follow this instruction may result in serious injury or death!

 WARNING! Failure to read and strictly comply with the instructions contained in this Instruction Manual may result in serious injury or death!

 WARNING! Thoroughly inspect this or any other Game Winner product(s) prior to use for signs of wear, rot, corrosion, cracks, fraying, deterioration and/or any other type of damage. DO NOT use this or any other Game Winner product(s) if they show evidence of wear, rot, corrosion, cracks, fraying, deterioration and/or any other type of damage. Failure to follow these instructions may result in serious injury or death!

 WARNING! This product is designed for adult use only. No one under the age of 18 should attempt to use this or any other Game Winner product(s) without direct adult supervision.

# Warnings

 **WARNING!** Do not remove, modify any portion or otherwise mechanically modify this product or its assemblies in any manner. Make certain that all parts are used in the assembly of this product. Parts are designed and tested to work together. Modification, additions, misuse, part omission or substitution shall immediately void your factory warranty and may result in serious injury or death! If you suspect a part(s) is missing and/or damaged, immediately contact Innopower Inc. at (949) 262-3416 for replacement of missing or defective parts. Never modify your stand in any way by making repairs, altering, omitting, adding or attaching anything to it. **ALWAYS USE GENUINE FACTORY AUTHORIZED INNOPOWER INC. REPLACEMENT PARTS. USE OF ANY REPLACEMENT PARTS OTHER THAN GENUINE INNOPOWER INC. PARTS VOIDS YOUR WARRANTY AND RELIEVES INNOPOWER INC. OF ANY RESULTANT LIABILITIES AND MAY RESULT IN SERIOUS INJURY OR DEATH!**

 **WARNING!** Prior to attempting to use this or any Game Winner product(s), you must take a moment and become familiar with its assembly, setup, installation and removal. You must practice setting-up, using and removing the product(s) at ground level prior to attempting to use it at heights above ground-level. Once you have become thoroughly knowledgeable and comfortable with this products set-up, use and removal at ground-level, you are now ready to use it at heights above ground-level. Failure to follow these instructions may result in serious injury or death!

 **WARNING!** When hunting from a treestand, falls can occur any time after leaving the ground causing injury or death. **THIS PRODUCT DOES NOT COME WITH A FULL BODY HARNESS.** Full body harness is integral part of hang-on bracket. This product is never intended to be installed or used without a full body harness with lineman's climbing strap. Full Body Harnesses are provided with those stands that have been certified by a Third Party Testing Facility to meet or exceed industry standards, and are available as after market purchases. Never use without wearing a full body harness with lineman's climbing strap that meets or exceeds industry standards, and ensuring full body harness is attached to the tree at all times after leaving the ground. Always wear a full-body fall arrest system (FAS) comprising a full-body harness, tether, tree belt, lineman's climbing strap and Suspension Relief Device at all times after leaving the ground. You must stay connected at all times after leaving the ground. When using a fixed position stand, this requires the use of a lineman's style belt that will allow you to stay connected until you reach the platform. The use of a lineman's style belt will allow you to climb up to the platform, connect the tether to the tree strap above the platform, and only then release the lineman's style belt. Using this method allows the user to remain connected to the tree at all times after leaving the ground. The use of this double connection technique is explained in the harness instructions. Always remain attached to the tree! Single safety belts and chest harnesses are no longer allowed and should never be used as they put the user at serious risk of injury or death. If you are not wearing your full-body arrest harness properly attached to the tree that is protecting you from a fall, do not leave the ground. Failure to follow these instructions may result in serious injury or death!







 **WARNING!** Never rely on a tree branch for support while climbing. Failure to follow these instructions may result in serious injury or death!

 **WARNING!** You must always inform someone of your hunting location, where the tree stand will be located and the expected duration of the hunt. Failure to follow these instructions may result in serious injury or death!











 **WARNING!** Inspect all safety devices each time before each use. **DO NOT** leave the ground or use these devices if they show signs of wear, damage, deterioration, vandalism, fraying or other damage. Factors such as tree growth, vandals, weather and animals may affect the performance of an unattended tree stand or safety device. Do not store outdoors when not in use. Failure to follow these instructions may result in serious injury or death!

 **WARNING!** Practice using full-body fall arrest harness at ground-level in the presence of a responsible adult to experience the feeling of hanging suspended before using in a hunting environment. Failure to follow these instructions may result in serious injury or death!

# Warnings













-  **WARNING!** The length of the full-body fall arrest tether must be minimized at all times. It should be adjusted so that it is above the head with no slack (snug) in the sitting position and you should have the minimum amount of slack possible when climbing. Failure to follow these instructions may result in serious injury or death!
-  **WARNING!** Failure to follow harness instructions could result in not being able to return to the stand and being suspended in a harness after a fall. If your hunting location is unknown by anyone and communications efforts are unsuccessful, you must have a personal plan for self-recovery/escape should you experience a fall. Prolonged suspension in a harness can be fatal. It is important to exercise the legs by pushing against the tree or doing other forms of continuous leg exercise to avoid blood pooling while being suspended. Varying degrees of physical fitness may require different plans for self-recovery/escape to avoid the effects of prolonged suspension. Have a personal plan and practice it in the presence of a responsible adult before leaving the ground. No one escape/rescue plan will work for every hunter, on every tree, in every circumstance. Only you can determine the best self-recovery/escape plan for your hunting situation and you must have a self-recovery/escape plan for your individual situation before leaving the ground. There is time to make a correct decision on what action to take if a fall occurs while wearing a full-body fall arrest harness. It is important to remember, "DO NOT PANIC." You must only hunt from the ground when self-recovery/escape ability is absent. Failure to follow these instructions may result in serious injury or death!
- Several optional products/systems are available that offer self-recovery or self extraction from a fall when suspended in a harness. Some systems automatically descend the user while others allow user control. One of these products/systems can be considered for use as an additional safety precaution against prolonged suspension and suspension trauma. Be sure to follow the manufacturers' directions on the safe use of these products/systems.
-  **WARNING!** A suspension relief device must be on your person and readily accessible while using your full-body fall arrest harness. These devices allow the user to relieve the load on the lower extremities if suspended in a harness and help maintain circulation in the legs, mitigate suspension trauma (blood pooling) or allow descent to the ground. Be sure to follow the directions on the safe use of any suspension relief device. Failure to follow these instructions may result in serious injury or death!
-  **WARNING!** If you have a limiting physical and/or health condition. DO NOT hunt from heights above ground level. Hunt from ground when self-recovery escape ability is absent. Failure to follow these instructions may result in serious injury or death!
-  **WARNING!** NEVER allow the harness tether to get under your chin or around your neck. This poses a choking hazard that can lead to serious injury or death. Failure to follow these instructions may result in serious injury or death.
-  **WARNING!** Never attempt to climb up or climb down with a weapon and/or gear. ALWAYS unload your weapon and pull it up to hunting height using a pull up rope. When raising or lowering firearms, the chamber must be open and the barrel pointing toward the ground. ALWAYS lower your unloaded weapon down to the ground prior to attempting to climb down. Use this same method when raising or lowering all other gear. Failure to follow these instructions may result in serious injury or death!

# Warnings



-  **WARNING! DO NOT** attempt to use this and/or any other Game Winner product(s) when ice, snow and/or freezing rain has deposited or formed on any portion of the product or tree you intend to climb. Failure to follow these instructions may result in serious injury or death!
-  **WARNING! ALWAYS** maintain three (3) point contact when climbing up/down when using this product. Proper three (3) point contact means having either two (2) feet with one (1) hand on step or one (1) foot with two (2) hands on the step portion of the climbing aids at all time when climbing up or down. Failure to follow these instructions may result in serious injury or death!
-  **WARNING! NEVER** adjust ANY straps, cables, and/or adjustable support bars while standing on treestand. Make all adjustments at ground level. **DO NOT** use any treestand if there is wear, rot, corrosion, cracks, fraying, deterioration and/or any other type of damage on any part of the treestand. Failure to follow these instructions may result in serious injury or death!
-  **WARNING! DO NOT** modify, fix/repair, alter, bend, cut, weld, or heat this product in any way. Failure to follow these instructions may result in serious injury or death!
-  **WARNING! DO NOT** lean out from a treestand for any reason. Never use full-body arrest harness to help you lean out from your treestand to make a difficult shot. Failure to follow these instructions may result in serious injury or death!
-  **WARNING! DO NOT** use this or any other Game Winner product(s) if you have a history of heart problems, back problems, impaired vision, joints that lock-up, spinal fusions, equilibrium problems, high blood pressure, are not well-rested and/or any other physical impairment that may limit your ability to use and/or operate this product(s) in the safe manner outlined in this instruction manual. Additionally, do not use this or any other Game Winner product(s) if you are currently taking any medication (including prescription or over-the-counter [OTC]) and/or using and/or consuming any substance, or consumed any substance, including alcohol, that may limit your ability to use this product as outlined and described in this instruction manual. Never use a tree stand when feeling ill, nauseous or dizzy. Do not use any Game Winner product(s) without consent from your medical doctor. Failure to follow these instructions may result in serious injury or death!
-  **WARNING! DO NOT** attempt to use this or any other Game Winner product(s) when lightning or thunderstorms are threatening and/or present within five (5) miles. Do not attempt to use this or any other Game Winner product(s) during or under threat of any adverse weather condition. This includes weather conditions which have the potential for producing winds, lightning, rain, snow, sleet and/or any other atmospheric condition which may limit the user's ability to operate this product in a safe manner as described in this instruction manual. Should inclement weather conditions arise during your use of this product, return to the ground immediately. Failure to follow these instructions may result in serious injury or death!
-  **WARNING! DO NOT** use this product, or attempt to use a treestand, on a dead, leaning, diseased, loose barked tree (bark that flakes or falls off), irregular shaped trees or utility poles. **DO NOT** use this product on any tree that does not allow for a level standing platform. Failure to follow these instructions may result in serious injury and death!
-  **WARNING!** Never jump or bounce on a treestand for any reason. Failure to follow these instructions may result in serious injury or death!
-  **WARNING!** Never leave this product and/or treestand in a tree for more than two (2) weeks (14 days). Weather, elements, animals, vandalism, and/or other mechanisms could damage the treestand. Tree growth can also stress and damage straps, chains and buckles. Failure to follow these instructions may result in serious injury or death!

# Warnings

## SPECIAL CONSIDERATIONS FOR HANG-ON OR LOCK-ON TREESTAND USAGE

-  **WARNING!** When using this product and when hunting from a treestand, falls can occur any time after leaving the ground causing serious injury or death. Always wear fall arrest system (FAS) comprising of full body harness and lineman's/climbing strap at all times after leaving the ground. You must remain connected to tree at all times after leaving the ground while using this product or any treestand.
-  **WARNING! THIS PRODUCT DOES NOT COME WITH A FULL BODY HARNESS.** Full body harnesses are provided with all treestands that have been certified by an independent testing facility to meet or exceed industry standards and are also available as after market purchases. This product is never intended to be used without a full body harness with lineman's climbing strap. If full body harness with lineman's climbing strap is unavailable, do not install or use this product.
-  **WARNING!** A full body harness is an integral part of this product. Never use without using a full body harness with lineman's/climbing strap that has been tested by a third party testing laboratory to meet or exceed industry standards. Single safety belts and chest harnesses are no longer allowed and should never be used.
-  **WARNING!** If you are not wearing a full body harness with lineman's/climbing strap properly attached to a tree that is protecting you from a fall, do not leave the ground.
-  **WARNING! READ THE MANUAL THAT CAME WITH YOUR FULL-BODY FALL ARREST HARNESS THOROUGHLY AND FOLLOW ALL THE INSTRUCTIONS!** Failure to wear a full-body harness when using this product puts the user at serious risk of injury or death. Failure to follow these instructions may result in serious injury or death!
-  **WARNING!** Correct tightening and adjustments of chains, cables, straps, etc. are critical to stable hang-on or lock-on treestand installation. All treestand contact points must be in contact with the tree before you step onto your stand. Failure to follow these instructions may result in serious injury or death!
-  **WARNING!** Practice the attachment of this product and hang-on or lock-on treestands at ground-level before using in a hunting environment. Failure to follow these instructions may result in serious injury or death!
-  **WARNING!** Never leave this product and/or treestand in a tree for more than two (2) weeks (14 days). Weather, elements, animals, vandalism, and/or other mechanisms could damage the treestand. Tree growth can also stress and damage straps, chains and buckles. Failure to follow these instructions may result in serious injury or death!
-  **WARNING!** Climbing aids (e.g., stick ladders, sectional ladders, steps, etc) must extend above the treestand standing platform (at least 24 inches [61 cm]) to allow the user to step down onto the platform. Never step up to your treestand from a climbing aid. Failure to follow these instructions may result in serious injury or death!
-  **WARNING!** Use a hoist rope to raise and lower this product and the treestand. Never climb with anything on your back. Failure to follow these instructions may result in serious injury or death!
-  **WARNING! ALWAYS** have a second adult present or at least accessible by cell phone or other means when installing/removing or using a treestand. The ability to get help quickly may save your life in the event of a fall. A good non-slip safety boot is important for your safety. Be especially careful that bootlaces do not get hooked on the treestand or climbing aids (tuck shoelaces into boot before climbing). Failure to follow these instructions may result in serious injury or death!
-  **WARNING!** At a minimum, replace tree straps and cables every two years or sooner. If wear, damage, deterioration, rust, cuts, tears, rot, etc. or any other damage is detected or suspected, do not use the treestand and replace immediately. Only replace with official Game Winner replacement parts. The use of unauthorized replacement parts may result in serious injury or death.
-  **WARNING!** Check the cables and all hardware prior to every use to make sure the cables are not corroded, cut, frayed or bent and that no damage has occurred to cables or hardware. **DO NOT USE THIS PRODUCT IF ANY DAMAGE, CORROSION, CUTS, FRAYS OR BENDS IS VISIBLE OR SUSPECTED.**

# Warnings

-  **WARNING!** BEFORE each use, make sure all nuts and bolts are secure. CHECK the treestand and all hardware, cables, attachment points and webbing prior to every use to make sure no damage has occurred. Keep webbing from coming into contact with any sharp edges. DO NOT USE THIS PRODUCT IF ANY DAMAGE IS SEEN OR SUSPECTED ON THE TREESTAND OR ANY OF ITS COMPONENTS. Failure to follow these instructions may result in serious injury or death!
-  **WARNING!** The cables are designed to swivel. DO NOT over tighten the hardware that attaches the cables to the treestand.
-  **WARNING!** DO NOT fold the treestand platform so that the cables bind into the mesh of the platform.

## FULL-BODY FALL ARREST HARNESS SYSTEM (FAS)

-  We are very serious about your personal safety. A full-body fall arrest harness must be used with this product. The full-body fall arrest harness is designed to keep you from experiencing a fall. Remember, the most important part of your hunt is returning home to your family safe and sound.

**READ THE FULL-BODY FALL ARREST HARNESS MANUFACTURERS MANUAL CAREFULLY AND FOLLOW ALL INSTRUCTIONS! FOLLOW FULL-BODY FALL ARREST HARNESS MANUFACTURERS MAXIMUM CAPACITY. ADDITIONALLY FOLLOW FULL-BODY FALL ARREST HARNESS MANUFACTURERS SERVICE LIFE AND REPLACE HARNESS IMMEDIATELY SHOULD YOU EXPERIENCE A FALL WHILE WEARING IT.**

-  **WARNING!** Not to use without a Full Body Harness (Fall Arrest System) that meets the requirements of Test Method F2337. Use only full body harness with lineman's climbing strap that has been tested by a third party testing laboratory to meet or exceed industry standards.  
**NOTE: You must store full-body harness out of direct sunlight and out of any other harsh environmental conditions that may adversely affect its performance.** Failure to follow these instructions may result in serious injury or death! Read and understand the manufacturer's warnings, expiration date and instructions on how to use and how to properly adjust the harness.



# Parts List

1	Hang On Bracket		Qty  1
---	-----------------	---	--------------

# Product Diagram

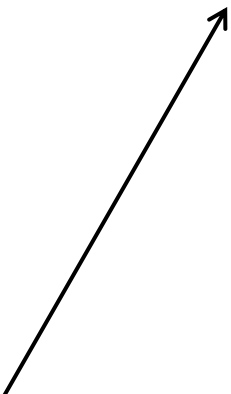

**Product Identification  
Mark for Customer  
Service**

# Installation Instructions

## SELECTING A SAFE TREE:



### WARNING!

**HANG-ON BRACKET MINIMUM AND MAXIMUM TREE SIZE: 9 – 22" DIAMETER!**

Never use this product on a dead, leaning, diseased, loose barked tree, tree with excessive vines or on a utility pole or any other man made structure.

Never use on trees that contain nails, screws, or other sharp objects that may cut, sever, or puncture strap webbing or cables!

Never rely on a tree branch for support!

Failure to follow these instructions can lead to serious injury or death!

- Select a healthy straight tree that fits within size limits larger than 9-inches in diameter and smaller than 22-inches in diameter at attachment height.
- Always thoroughly inspect tree from all sides before installing this product.
- Be sure hang-on bracket allows for level treestand platform. Tree must not lean or have any irregular shapes.
- Do not select a tree with vines or limbs below your desired hunting height.
- Never attach this product to limbs! Always attach this product to main trunk of tree.
- Never use this product on trees with wet, icy, slippery, loose or scaly bark.

## PRACTICE AND BECOME FAMILIAR WITH PRODUCT AT GROUND LEVEL:

Always practice attaching/detaching, adjusting and using hang-on bracket, treestand and full body harness with lineman's climbing strap at ground level prior to using at elevated positions.

Prior to using hang-on bracket and treestand at elevated positions for first use of each season, test operation and use at ground level.

## FULL BODY SAFETY HARNESS (FALL ARREST SYSTEM – FAS):



### WARNING!

Not to use without a Full Body Harness (Fall Arrest System) that meets the requirements of Test Method F2337.

You must wear and use full body harness with lineman's climbing strap that has been tested by third party testing laboratory to meet or exceed industry standards before attempting to install, remove or use this product.

Always remain connected to tree with lineman's climbing strap and tree strap from the moment you leave the ground until you return to ground.

Read and understand manufacturer's Full Body Harness Instructions, Warnings, and watch safety video for instructions on using your full body harness with lineman's climbing strap.

Use of full body harness with lineman's climbing strap is required to stabilize yourself to tree when installing, climbing up/down climbing aid and/or climbing into/out of hang-on treestand.

Never attempt to install this product, install, climb or climb into/out of hang-on treestand without being stabilized by lineman's climbing strap.

Failure to follow these instructions can result in serious injury or death.

Refer to Full Body Harness (FAS) with Lineman's Climbing Strap manufacturers instruction manual for proper wear, adjustment, usage and maintenance.

**THE REST OF THE INSTRUCTIONS IN THIS MANUAL REQUIRE YOU ARE WEARING AND USING A FULL BODY HARNESS WITH LINEMAN'S CLIMBING STRAP THAT HAS BEEN TESTED BY A THIRD PARTY TESTING LABORATORY TO MEET OR EXCEED INDUSTRY STANDARDS.**

# Installation Instructions



## WARNING!

Prior to every use, inspect tree straps, cables, and all hardware for damage, including corrosion. DO NOT USE THIS PRODUCT IF DAMAGE IS SUSPECTED, including but not limited to cuts, frayed portions, corrosion, bends, or other damage to treestand, straps, or cables. If damage is visible or suspected, DO NOT USE THE PRODUCT.

Follow all warnings and expiration dates listed on tree strap warning label and in maintenance section for cables.

Never Rely on a tree branch for support.

Never exceed 18-inches of step spacing between multiple climbing sticks.

CLIMBING STICKS MUST EXTEND MINIMUM OF 24 INCHES ABOVE final position of hang-on platform.

ALWAYS step down from climbing stick onto hang-on platform.

Never attempt to climb up onto a hang-on platform from climbing stick mounted below hang-on platform.

Always attach and tighten tree strap/buckle around tree.

Always check to ensure tree strap hook is attached to treestand bracket.

Never jump or bounce on treestand in an attempt to cause it to dig into tree.

Never hunt at heights you are not completely comfortable. Depending on tree and conditions, choose minimum height that allows for safe and effective hunting.

Always maintain 3 points of contact when climbing up/down climbing sticks and in/out of treestand.

Always use a hoist rope to raise and lower treestand. Never climb with anything on your back.

Always position safety harness tree strap with tether above your head so tether is minimized at all times.

Never allow tether strap to get under your chin or around your neck.

Hunt from ground when self-recovery/escape ability is absent.

Do not jump, bounce, hop, rock back and forth, etc. on treestand. Do not lean out or against treestand. Always stay centered on platform with minimal movement.

Do not stand on treestand seat or footrest (if included).

Do not climb onto or use treestand with another person. This product is designed for and intended for only one person.

Always use hoist rope to pull up bow, crossbow, firearm, backpack, or other gear only after being secured in treestand. Firearm, crossbow, and bow must be pulled up unloaded with firearm chamber open and muzzle down.

Failure to follow these instructions can result in serious injury or death.

- Always inform someone of hunting location, where treestand will be located, and expected duration of hunt.
- Always have second adult present or at least accessible by cell phone or other means when using treestand. Ability to get help quickly may save your life in event of a fall.
- Always take and use signal device (mobile phone, radio, whistle, signal flare, or personal locating device (PLD)) when using this product. Always keep signal device on you and readily available at all times.
- Never hunt out of a treestand at heights you are not completely comfortable. Depending on tree and conditions, choose minimum height that allows for safe and effective hunting.
- Never hurry! While climbing, make slow, even movements and make sure you have proper contact with tree and/or climbing sticks or treestands every time you move.

# Installation Instructions



## WARNING!

**ONLY FOR USE WITH APPROVED GAME WINNER TREESTAND MODEL 161732 OVERSIZED EZ SET HANG ON TREESTAND.** Treestands sold separately.

Follow all warnings and expiration dates listed on tree strap warning label. Always inspect strap for wear, cuts, or damage before use. Never use a damaged strap.

Practice attaching/detaching, adjusting and using at ground level prior to using at elevated positions.

Failure to follow these instructions can result in serious injury or death.

### Step 1:

Double check to assure you are wearing and properly attached to tree with full body harness with lineman's climbing strap. If you are not, STOP and do not leave the ground. Remaining attached to tree with lineman's climbing strap, climb up Climbing Sticks (not included) to desired stand location. Only use Climbing Sticks that are tested by a third party testing laboratory to meet or exceed industry standards and follow Climbing Stick manufacturers' instructions and warnings for proper installation and use.

**Read and understand included Full Body Harness Instructions, Warnings and watch safety video for instructions on using your Full Body Harness with lineman's climbing strap.**



**Always remain connected to tree with lineman's climbing strap and tree strap from moment you leave ground until you return to ground.**

### Step 2:

Install Hang-on Bracket (#1) onto the tree with ratchet strap and post facing up as shown in Figure 1. Attach hook on bracket so hook faces away from tree.

Assemble so Hang-on Bracket is level and post is vertical.

For ratchet strap threading instructions refer to Figure 1.

**WARNING! HANG-ON BRACKET WITH RATCHET STRAP MUST BE INSTALLED. FAILURE TO FOLLOW THESE INSTRUCTIONS CAN RESULT IN SERIOUS INJURY OR DEATH.**

**ALWAYS ATTACH HOOK ON BRACKET SO HOOK FACES AWAY FROM TREE!**

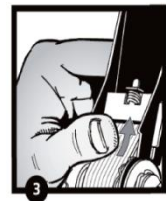
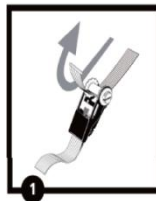
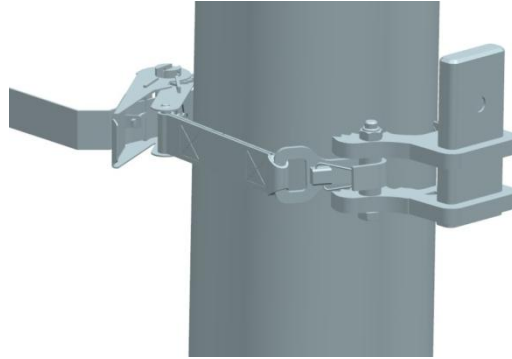

Figure 1

Install Hang-on Stand Bracket to Tree

### Step 3:

With hang-on platform folded up (Figure 2), use pull up rope to lift hang on up tree.

**Model 161732 Oversized EZ Set Hang On Treestand Sold Separately**

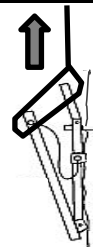

Figure 2

Pull Up Rope

# Assembly Instructions

## Step 4:

With Locking Knob removed from Hang-on Stand hole, install Hang-on Stand onto the Hang-on Bracket which was pre-installed on tree in step 2. Make sure Hang-on Stand fully engages Bracket so holes on Stand and Bracket line up. Secure Hang-on Stand by inserting Locking Knob through Hang-on hole and tightening the Locking Knob onto bracket as shown in Figure 3.

**WARNING! LOCKING KNOB MUST BE ATTACHED AND TIGHTENED TO BOTH HANG-ON STAND AND BRACKET. FAILURE TO FOLLOW THESE INSTRUCTIONS CAN RESULT IN SERIOUS INJURY OR DEATH.**

*Locking Knob is included on Model 161732 Oversized EZ Set Hang On Treestand Sold Separately*

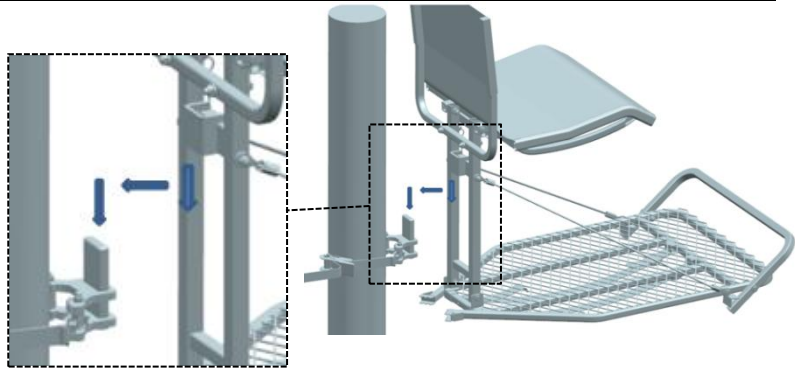
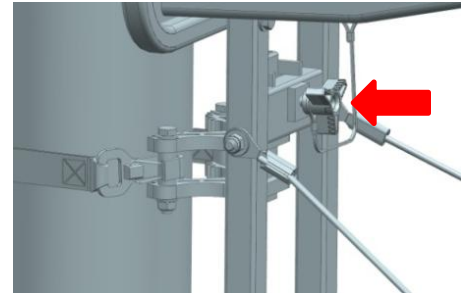

Figure 3

Install Hang-on to the Hang-on Stand Bracket and then Tighten the Knob



## Step 5:

Attach hook on cam buckle strap to the triangle area of back platform. Wrap tree strap around tree and attach hook on other end of tree strap to platform with hook facing away from tree as shown in Figure 4. Do not tighten. For cam buckle threading instructions refer to Figure 5.

**WARNING! CAM BUCKLE STRAP MUST BE INSTALLED. FAILURE TO FOLLOW THESE INSTRUCTIONS CAN RESULT IN SERIOUS INJURY OR DEATH.**

*Cam Buckle Strap is included with Model 161732 Oversized EZ Set Hang On Treestand Sold Separately)*

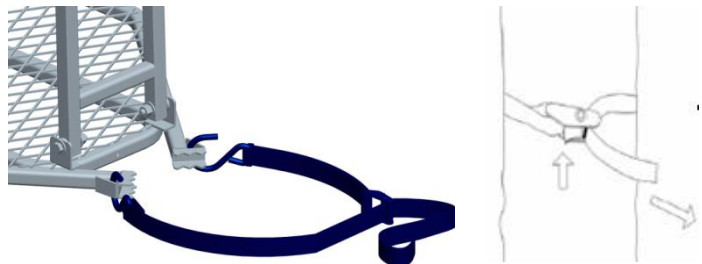

Figure 4

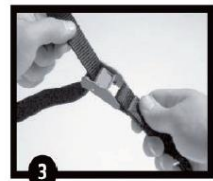
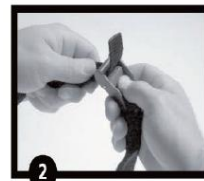

Figure 5

# Installation Instructions

## Step 6:

Rotate hang-on platform down so platform's cam action tightens treestand to tree and prevents shifting. Repeat until a tight contact between treestand and tree is achieved. Tighten the cam buckle strap making sure the treestand is in contact with the tree trunk and the treestand assembly is very tight to the tree. See figure 6.

**WARNING! ALWAYS MAKE SURE PLATFORM IS LEVEL! IF PLATFORM IS LEANING FORWARD, REPOSITION TREESTAND OR SELECT DIFFERENT TREE.**

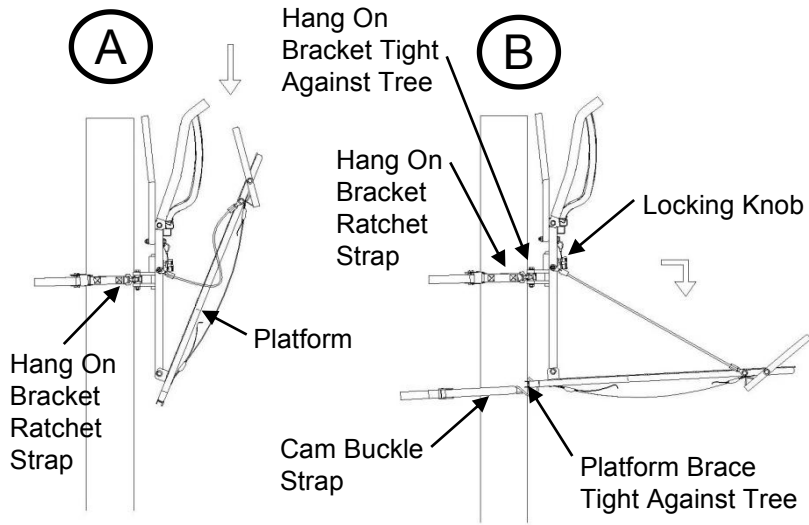

Figure 6

## Step 7:

Double Check. Correct tightening and adjustments of hang on bracket ratchet strap, locking knob and cam buckle strap are critical to stable hang-on treestand installation. Always check to ensure treestand is secure and properly attached to tree. Six contact points (4 treestand points and 2 tree strap points) must be in tight contact with tree and locking knob must be installed. If not, repeat step 2 through step 7 until tight with tree. See figure 7.

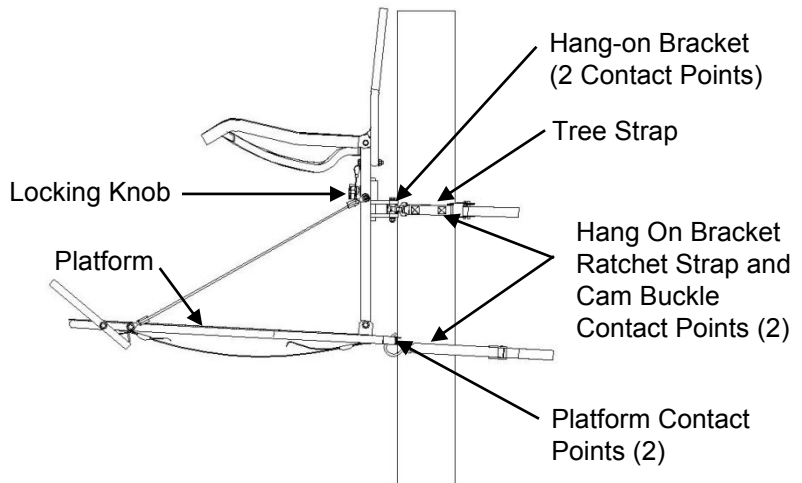

Figure 7



Do not step onto platform until all contact points are tight to tree, hang-on bracket ratchet strap and cam buckle strap are secured to treestand and tree and locking knob is assembled on treestand and Hang-on Bracket. Failure to follow these instructions can result in serious injury or death.

# Installation Instructions

## Step 8:

While remaining connected to lineman's strap and **following included safety harness instructions**, attach harness tether to tree strap above treestand (Figure 8).

**WARNING! ALWAYS FOLLOW INCLUDED SAFETY HARNESS INSTRUCTIONS!**

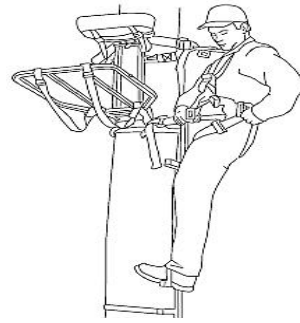

Figure 8

## Step 9:

Once you and your harness are securely connected to harness tree strap, **THEN AND ONLY THEN** disconnect lineman's strap. **CAREFULLY STEP DOWN** onto center of platform (Figure 9).

**WARNING! ALWAYS FOLLOW INCLUDED SAFETY HARNESS INSTRUCTIONS!**

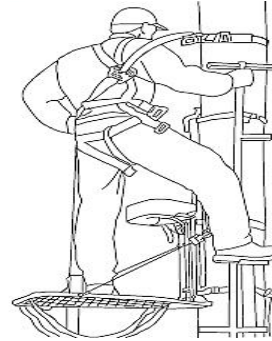

Figure 9

## Step 10:

Adjust tree strap above your head so tether is under tension when sitting (Figure 10).

**WARNING! ALWAYS FOLLOW INCLUDED SAFETY HARNESS INSTRUCTIONS!**

**Your treestand is now ready to be used!**

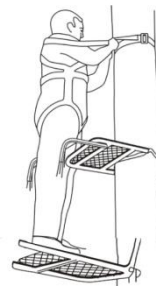

Figure 10



## Step 11:

### Exiting Treestand.

Following full body harness instructions, and with full body harness connected to tree, carefully step up onto climbing aid and climb down so your waist is below platform. Attach lineman's strap to tree below platform, **THEN AND ONLY THEN** disconnect tree strap (Figure 11). Carefully climb down using the climbing aids. Always remain attached to tree until you reach the ground.

**WARNING! ALWAYS FOLLOW INCLUDED SAFETY HARNESS INSTRUCTIONS!**

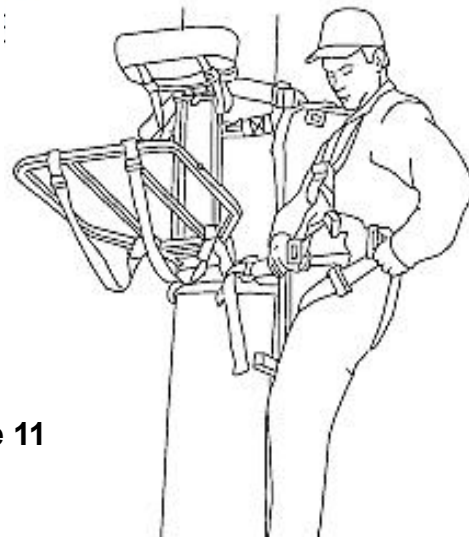

Figure 11

**WARNING!** DO NOT use this or any other Game Winner product(s) to climb utility poles, telephone poles, structural columns or any other manmade structures. Never use this or any other Game Winner product(s) around power generation (e.g., transformers, generators, substations, etc.) and/or power transmission equipment. Failure to follow these instructions will result in serious injury or death!



# Removal Instructions



**WARNING! STOP!** Make sure that you are wearing full-body fall arrest harness! Failure to follow these instructions may result in serious injury or death!



**WARNING!** You must have at least one (1) adult in additional to remove this treestand. Failure to follow these instructions may result in serious injury or death!



**WARNING!** Prior to attempting to remove this or any other Game Winner product(s) you must take a moment and become familiar with its setup, installation and removal at ground-level. You must practice installing, setting-up and removing this product(s) at ground-level prior to attempting to use it at heights above ground-level. Once you have become thoroughly knowledgeable and comfortable with this products setup, installation, use and removal at ground-level, you're now ready to use it at heights above ground-level. Failure to follow these instructions may result in serious injury or death!

**STEP 1:** Using full-body fall arrest system with linesmen belt, climb to your treestand. With your full-body fall arrest still attached to the tree trunk (**DO NOT ATTACH YOUR FULL-BODY FALL ARREST HARNESS TO YOUR CLIMBING STICKS**) connect your hoist rope to your treestand.

**STEP 2:** With your linesman belt securely installed, standing on climbing aid next to stand, remove the cam buckle strap on the treestand and drop it to the ground below. Be certain no one or nothing is in the path of the descending cam buckle strap. Next, unthread and remove the locking knob from the treestand and hanging bracket. **UNDERSTAND THAT ONCE CAM BUCKLE STRAP AND LOCKING KNOB ARE DISCONNECTED, THE TREESTAND IS ALSO DISCONNECTED.** With the treestand disconnected, lift treestand off Hang-on Bracket and gently lower it to the ground below using the previously installed hoist rope. Remove Hang-on Bracket and gently lower it to the ground using hoist rope. Your treestand is now uninstalled.

## Care and Maintenance



**WARNING!**

**This product contains no user serviceable parts except for tree strap, cables, seat cushion and full body harness.**

**Replace tree straps, hang-on bracket strap and cables every two years or sooner if wear, damage, deterioration, rust, cuts, tears, rot, etc. or vandalism is detected or suspected. Only replace with official Game Winner replacement parts.**

**Replace full body harness every three years or sooner if wear, damage, deterioration, cuts, tears, rot, etc. are detected or suspected.**

**Proper maintenance and inspection is required for this product.**

**Always inspect treestand, hang-on bracket, climbing aids and all safety devices for damage including but not limited to corrosion, rust, cracks, deformity, bends, rot, wear, cuts or fraying and other damage to tree strap, cables, crimps, hardware, platform, upright, seat, etc. Do not use or leave the ground if damage is detected or suspected.**

**Failure to follow these instructions can lead to serious injury or death.**

Store treestand and full body safety harness indoors in a clean, dry environment free from direct sunlight, harmful chemicals, excessive heat and dust. Exposure to sunlight, excessive heat and the elements can weaken tree strap or affect its performance.



**WARNING!** Never leave this product and/or hang-on bracket in a tree for more than two weeks (14 days) since weather or animals could cause damage. Tree growth can also stress and damage straps and buckles.



# Warranty Information

## Important Warranty Information

Innopower Inc. warrants this Game Winner product against defect(s) in material and workmanship, under proper use and storage, for the period of one (1) year from the date of purchase. Proof of purchase, plus, the return of your warranty application card to our home office, is required for any warranty claim. In the events this product is found to be defective within the warranty period, Innopower Inc.'s only obligation and your exclusive remedy shall be replacement or repair of any defective parts at our discretion. To obtain warranty service, please contact Innopower Customer Service at (949) 262-3416. Exclusions to this warranty include seat, paint, plastics, webbing and/or defects caused by operator misuse and/or abuse. Limitation to liability include the forgoing warranty is made in lieu of all other warranties, express or implied and Innopower Inc. disclaims any implied warranty of merchantability and fitness. Innopower Inc. shall not be liable for any damages direct, consequential or incidental arising out of the use or inability of this product.

### Warranty Application Card

I have read and understand the safety, assembly and operating instructions provided with my Game Winner product. I have read the warranty information and know that I can call Innopower Inc. at **(949) 262-3416** with any questions or concerns that I may have about this or any other Game Winner product. Mail to: INNOPOWER INC.

PO Box 265, E. Irvine, CA 92650. Email: [customerservice@innopower.biz](mailto:customerservice@innopower.biz)

Name \_\_\_\_\_ Purchase Location \_\_\_\_\_

Address \_\_\_\_\_

City/State/Zip \_\_\_\_\_

Purchase Date \_\_\_\_\_

Product \_\_\_\_\_

Manufactured by Innopower Inc., PO Box 265, E. Irvine, CA 92650