



GAME WINNER™

Instruction Manual TRIPOD ACCESSORY KIT 2.0

ITEM:160408



TRIPOD NOT INCLUDED

Compatible with 161729 and FSGWSF2059, not compatible with other models.



Thank you for your purchase of this quality Game Winner Product! In order to reduce your risk of injury, you **MUST** read and thoroughly understand all of the safety warnings, usage instructions and other information contained within the written and safety video instructions and warnings provided with this product and any other hunting equipment used. Retain the instructional and warning materials and review them periodically (at least once a year and always with any new user). Failure to follow all instructions and warnings may lead to serious injury or death. **DO NOT USE THIS PRODUCT UNTIL AND UNLESS YOU HAVE READ AND THOROUGHLY UNDERSTAND ALL INSTRUCTIONS, SAFETY WARNINGS AND OTHER MATERIALS.** If you have any questions, do not use the product until you have contacted the manufacturer at 949-262-3416 or email customerservice@innopower.biz.

Business Hours:

Monday through Friday, **8:00** am to **5:00** pm ET. If you are unable to speak with a representative, please leave a voicemail with your contact information and your call will be returned within one (1) business day.

For Customer Service, please call **949-262-3416** or

E-mail: customerservice@innopower.biz



(Made In China)

Warnings	3
Parts List	4
Hardware / Tools Required	5
Product Diagram	6
Assembly & Installation Instructions	7-11
Care and Maintenance	11
Warranty Information	12

Note: Before beginning assembly of product, make sure all parts are present. Compare parts with package content list and hardware contents. If any part is missing or damaged do not attempt to assemble the unit. Contact customer service for replacement parts.

Warnings

ATTENTION !

 WHEN YOU SEE A  SYMBOL OR THE WORD "WARNING!" BE SURE TO READ THE MESSAGE! THE INFORMATION CONTAINED IN THESE MESSAGES CAN SAVE YOUR LIFE OR PREVENT SERIOUS INJURY!! BE SAFE! FOLLOW ALL WARNINGS!!

 WARNING! FALLS FROM A TRIPOD STAND CAN OCCUR ANYTIME AFTER LEAVING THE GROUND. THESE FALLS RESULT IN EITHER SERIOUS INJURY OR DEATH! FOR YOUR PERSONAL SAFETY, READ THIS PRODUCTS INSTRUCTION MANUAL ALONG WITH TRIPOD STAND 161729 and FSGWSF2059 (INCLUDED WITH TRIPOD STAND) INSTRUCTION MANUAL IN ITS ENTIRETY BEFORE ATTEMPTING TO ASSEMBLE, SET-UP, INSTALL AND/OR OTHERWISE USE THIS GAME WINNER PRODUCT. ANNUALLY REVIEW THE CONTENTS OF THIS INSTRUCTION MANUAL. ADDITIONALLY, KEEP THESE INSTRUCTIONS FOR THE ENTIRE DURATION YOU OWN THIS PRODUCT(S). FAILURE TO FOLLOW THESE INSTRUCTIONS MAY RESULT IN SERIOUS INJURY OR DEATH!

 WARNING! Assemble with Tripod at ground level! Do not assemble at heights! Failure to follow these instructions may result in serious injury or death!

 WARNING! Thoroughly inspect this or any other Game Winner product(s) prior to use for signs of wear, rot, corrosion, cracks, fraying, deterioration and/or any other type of damage. DO NOT use this or any other Game Winner product(s) if they show evidence of wear, rot, corrosion, cracks, fraying, deterioration and/or any other type of damage. Failure to follow these instructions may result in serious injury or death!





 WARNING! This product is designed for adult use only. No one under the age of 18 should attempt to use this or any other Game Winner product(s) without direct adult supervision.

 WARNING! Do not remove, modify any portion or otherwise mechanically modify this product or its assemblies in any manner. Make certain that all parts are used in the assembly of this product. Parts are designed and tested to work together. Modification, additions, misuse, part omission or substitution shall immediately void your factory warranty and may result in serious injury or death! If you suspect a part(s) is missing and/or damaged, immediately contact Innopower Inc. at (949) 262-3416 for replacement of missing or defective parts. Never modify your stand in any way by making repairs, or altering, omitting, adding or attaching anything to it. ALWAYS USE GENUINE FACTORY AUTHORIZED INNOPOWER INC. REPLACEMENT PARTS. USE OF ANY REPLACEMENT PARTS OTHER THAN GENUINE INNOPOWER INC. PARTS VOIDS YOUR WARRANTY AND RELIEVES INNOPOWER INC. OF ANY RESULTANT LIABILITIES AND MAY RESULT IN SERIOUS INJURY OR DEATH! DO NOT modify, fix/repair, alter, bend, cut, weld, or heat this product in any way. Failure to follow these instructions may result in serious injury or death!



 WARNING! Inspect all safety devices each time before each use. DO NOT leave the ground or use these devices if it (they) shows signs of wear, damage, deterioration, vandalism, fraying or other damage. Factors such as tree growth, vandals, weather and animals may affect the performance of an unattended tree stand or safety device. Do not store these devices outdoors when not in use. Failure to follow these instructions may result in serious injury or death!

 WARNING! DO NOT modify, fix/repair, alter, bend, cut, weld, or heat this product in any way. Failure to follow these instructions may result in serious injury or death!

Parts List

1	Camo Roof (3 roof support bars center sections had been placed through sewn sleeves inside of roof and 2 webbing straps attached to back roof support bar)		Qty 1
2	Middle Roof Support Bar Side Sections		Qty 2
3	Front Roof Support Bar Side Sections (with plastic snap buckle webbing)		Qty 2
4	Rear Roof Support Bar Side Sections		Qty 2
5	Camo Skirt		Qty 1

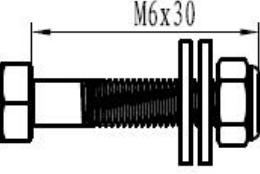
Hardware

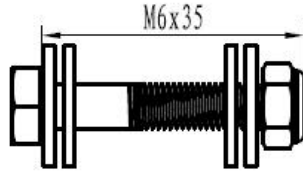
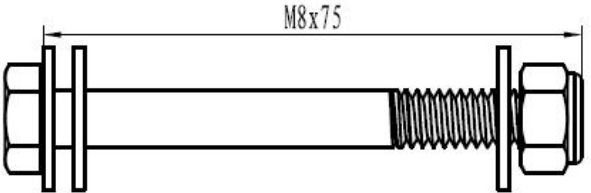
Step 1	M6X12 (with 2 steel washers and 1 locknut)		Qty 4
Step 2	M6X30 (with 2 steel washers and 1 locknut)		Qty 4
Step 3	M6X12 (with 2 steel washers and 1 locknut)		Qty 4
Step 4	M6X35 (with 4 nylon washers and 1 locknut)		Qty 2
Step 5	M8X75 (with 3 nylon washers and 1 locknut)		Qty 2

Tools Required (Provided)

1	Wrench (2 pcs)	
---	-------------------	--

Product Diagram

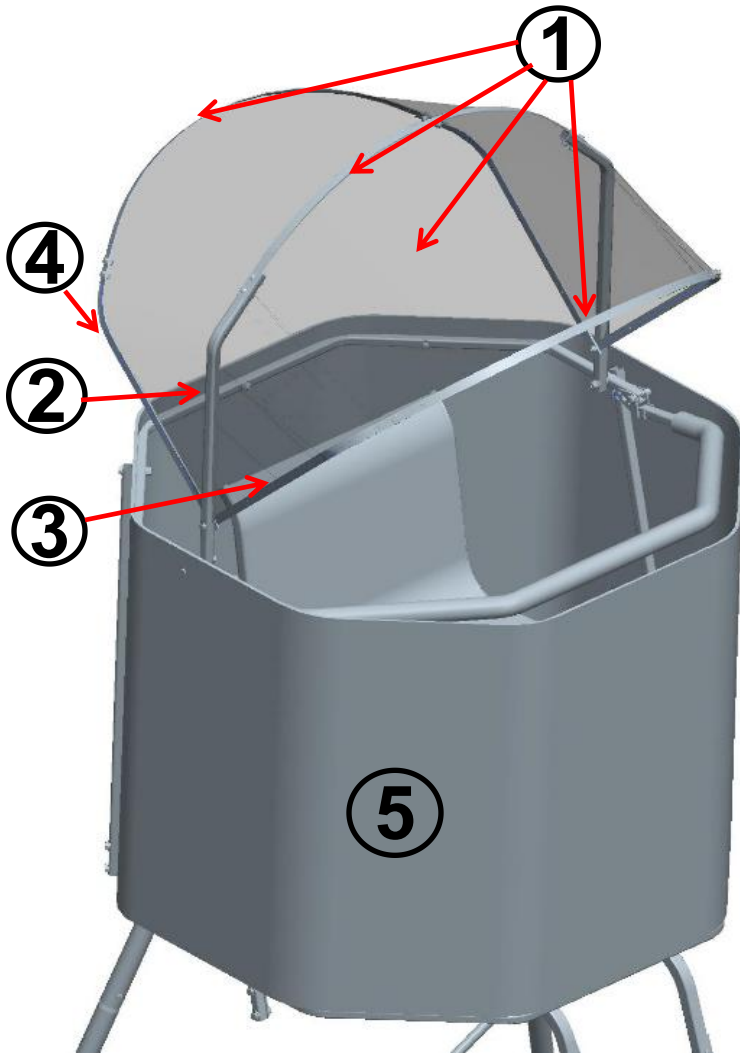

TRIPOD NOT INCLUDED



Camo roof can be folded down and wrapped up using two Hook & Loop Fasteners. Allowing the roof to be folded down when not in use.

Assembly & Installation Instructions

Step 1:

Install two Front Roof Support Side Sections (#3) to the Front Roof Support Center Section of Camo Roof (#1) using four (4) M6x12 Bolts, eight (8) Steel Washers and four (4) Nuts as shown in Figure 1.

WARNING! Do not overtighten the hardware. Over tightening can lead to structural damage and may negatively affect the performance of your product.

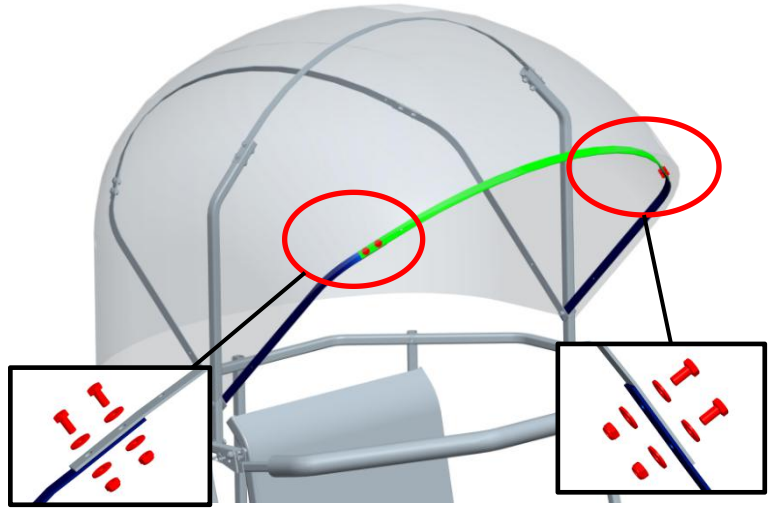

Figure 1 Install Front Roof Support Bar

Step 2:

Install two Middle Roof Support Side Sections (#2) to the Middle Roof Support Center Section of Camo Roof (#1) using four (4) M6x30 Bolts, eight (8) Steel Washers and four (4) Nuts as shown in Figure 2.

WARNING! Do not overtighten the hardware. Over tightening can lead to structural damage and may negatively affect the performance of your product.

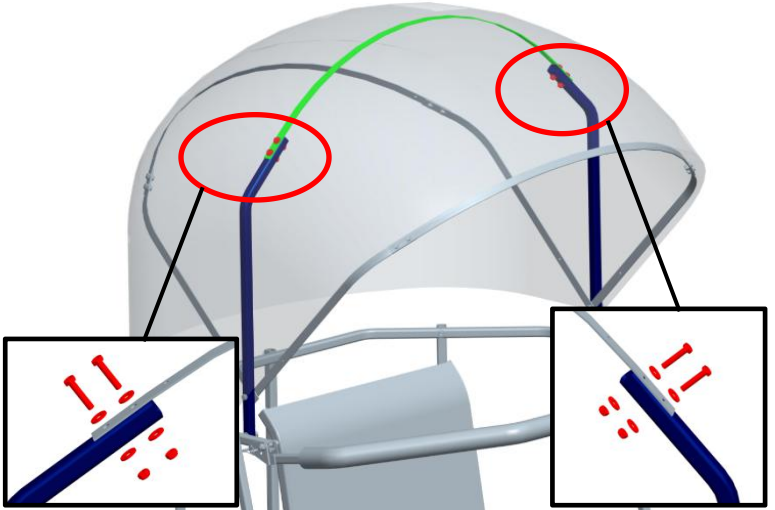

Figure 2 Install Middle Roof Support Bar

Step 3:

Install two Rear Roof Support Side Sections (#4) to the Rear Roof Support Center Section of Camo Roof (#1) using four (4) M6x12 Bolts, eight (8) Steel Washers and four (4) Nuts as shown in Figure 3.

WARNING! Do not overtighten the hardware. Over tightening can lead to structural damage and may negatively affect the performance of your product.

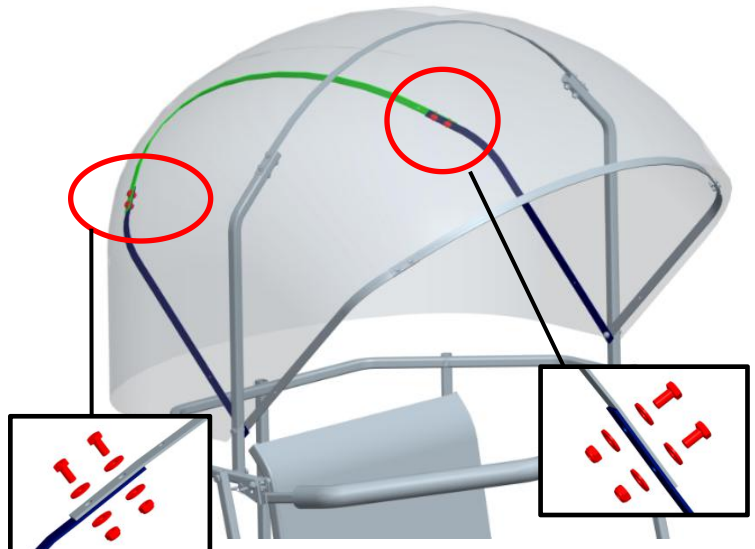

Figure 3 Install Rear Roof Support Bar

Assembly & Installation Instructions

Step 4:

Install assembled Front & Rear Roof Support Bars to the Middle Roof Support Bar using two (2) M6x35 Bolts, eight (8) Nylon Washers and two (2) Nuts as shown in Figure 4 for the left and right side.

Note: Please place one (1) Nylon Washer between the Front & Middle & Rear Roof Support Bars.

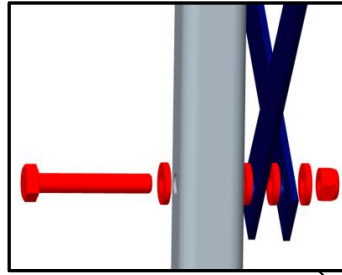
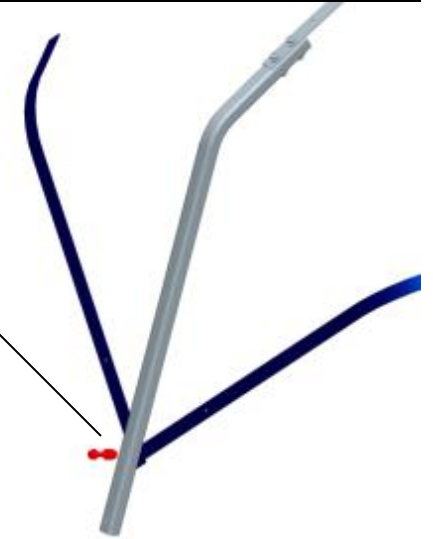

Figure 4

Install Front & Rear Roof Support Bars To The Middle Roof Support Bar



Step 5:

At ground level, install assembled Camo Roof to the tripod by installing the Middle Roof Support Bar to the inside of Tripod Shooting Rail using two (2) M8x75 Bolts, six (6) Nylon Washers and two (2) Nuts as shown in Figure 5 for the left and right side.

Note: Please place one (1) Nylon Washer between the Shooting Rail & Middle Roof Support Bars.

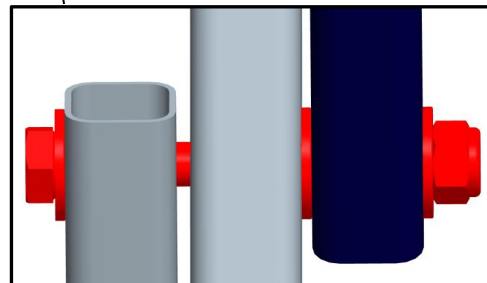
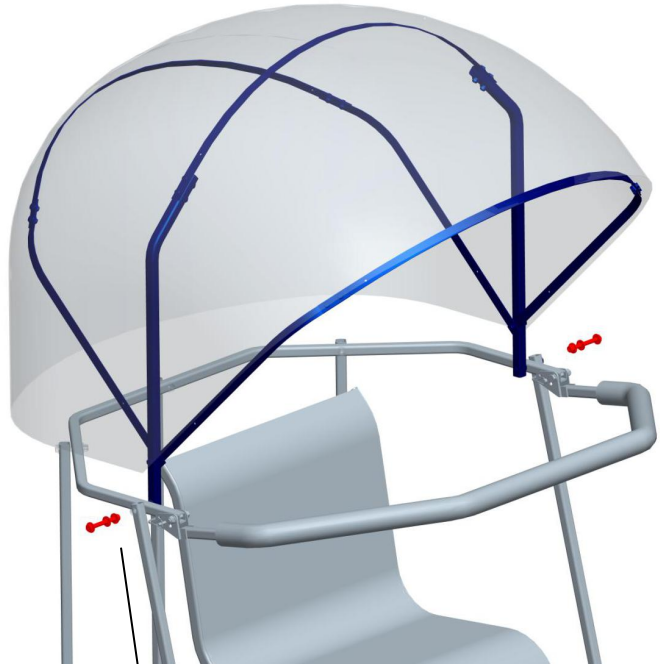

Figure 5 Install Camo Roof To The Tripod

Assembly & Installation Instructions

Step 6:

At ground level, secure the Camo Roof .

A: Attach two (2) plastic snap buckle webbings (on the Rear Roof Support Bar) to the Tripod Shooting Rail and tighten the webbings as shown in Figure 6.

B: Attach two (2) plastic snap buckle webbings (on the Front Roof Support Bar) to the Tripod Platform and tighten the webbings as shown in Figure 6.

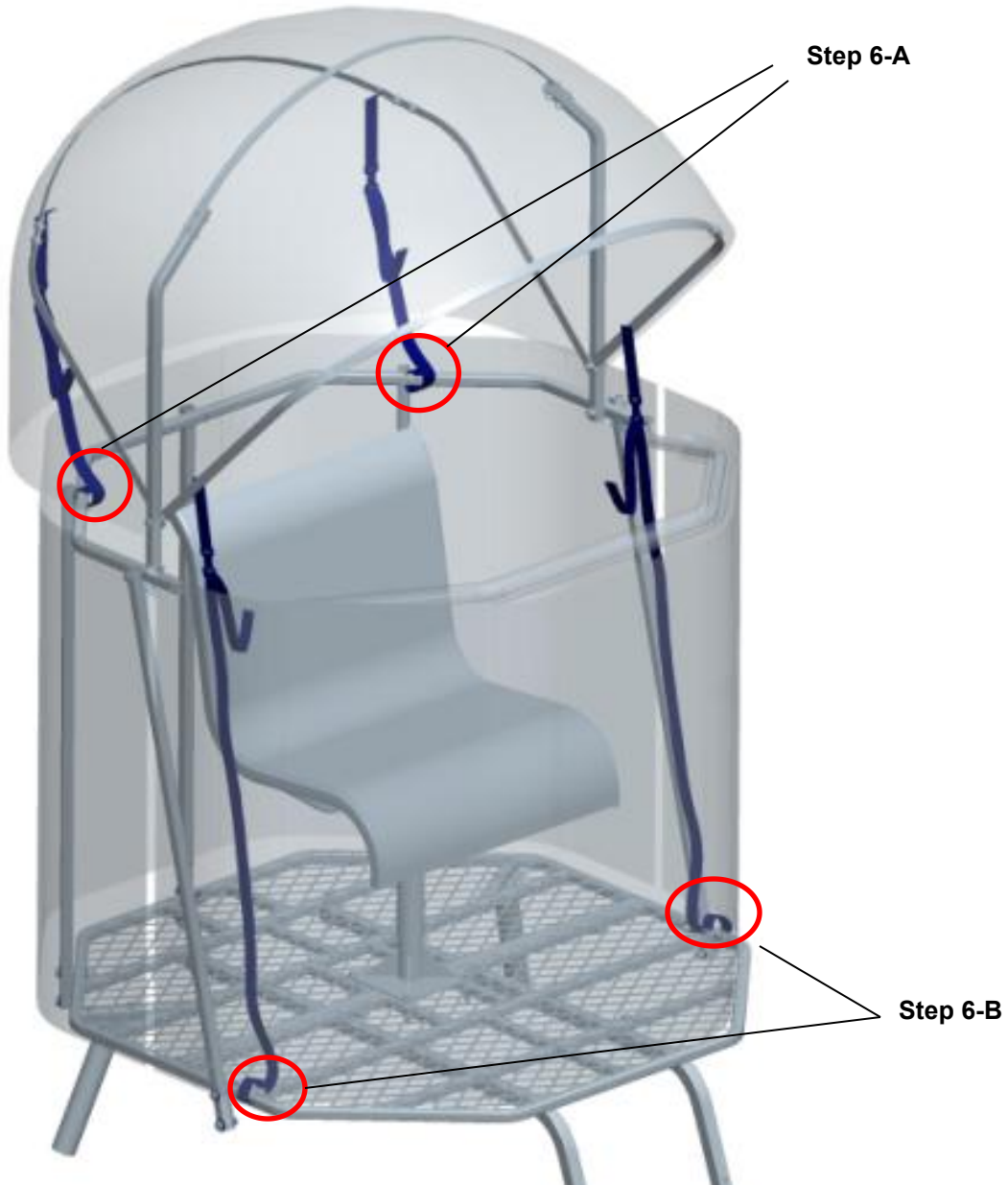

Figure 6 Secure Camo Roof

Assembly & Installation Instructions

Step 7:

At ground level, secure the Camo Roof to the Shoeing Rail and Middle Roof Support Bar Side Sections using Hook & Loop Fasteners as shown in Figure 7.

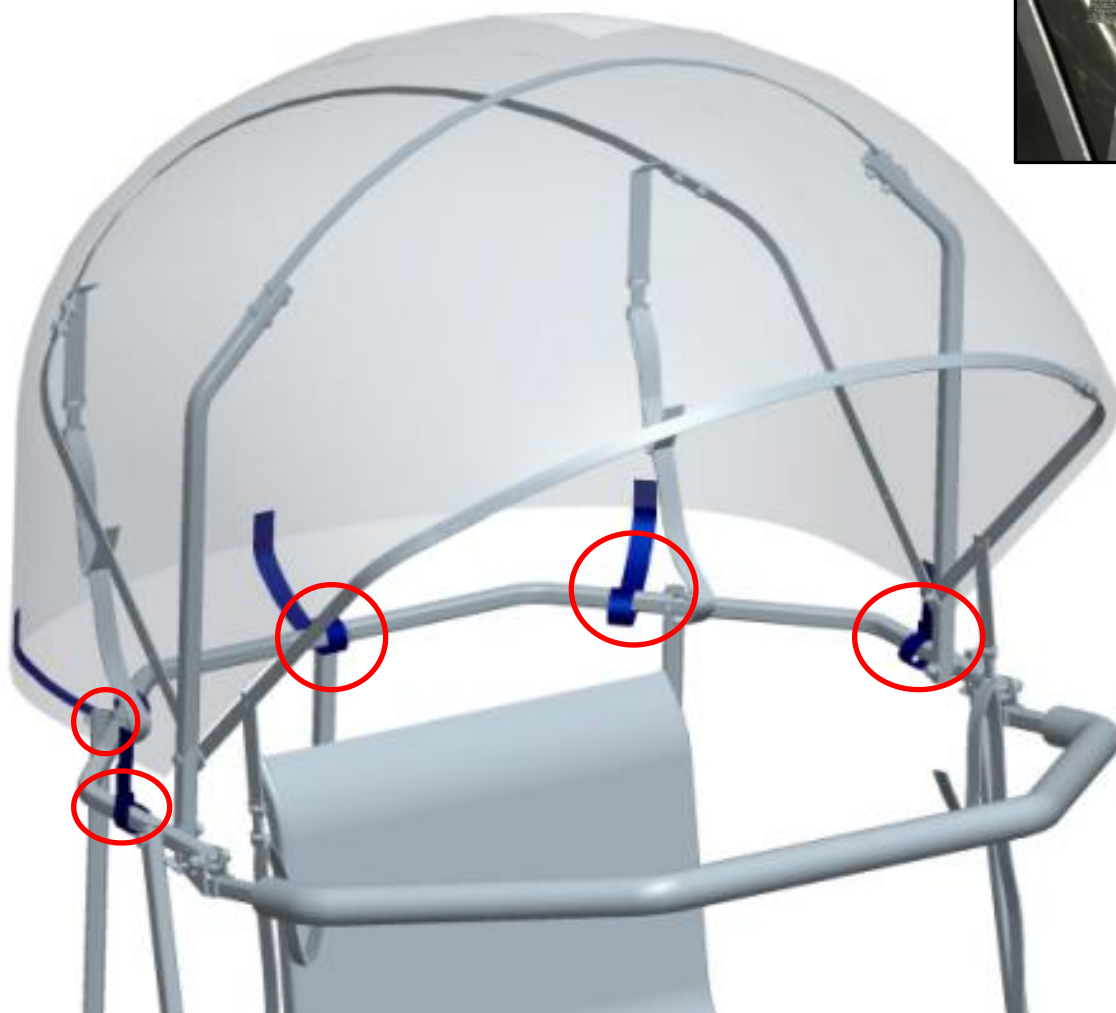

Figure 7 Secure Camo Roof

Assembly & Installation Instructions

Step 8:

At ground level, slip Camo Skirt over and around shooting rail. Secure using Hook & Loop Fasteners (on shooting rail) and cinch cords (along bottom) as shown in Figure 8.



Figure 8 Install Camo Skirt

Care and Maintenance

It is recommended that you store your accessory kit out of sunlight and out of any other harsh environmental condition(s) that may adversely affect its performance.

Warranty Information

Important Warranty Information

Innopower Inc. warrants this Game Winner product against defect(s) in material and workmanship, under proper use and storage, for the period of one (1) year from the date of purchase. Proof of purchase, plus, the return of your warranty application card to our home office, is required for any warranty claim. In the events this product is found to be defective within the warranty period, Innopower Inc.'s only obligation and your exclusive remedy shall be replacement or repair of any defective parts at our discretion. To obtain warranty service, please contact Innopower Customer Service at (949) 262-3416. Exclusions to this warranty include seat, paint, plastics, webbing and/or defects caused by operator misuse and/or abuse. Limitation to liability include the forgoing warranty is made in lieu of all other warranties, express or implied and Innopower Inc. disclaims any implied warranty of merchantability and fitness. Innopower Inc. shall not be liable for any damages direct, consequential or incidental arising out of the use or inability of this product.

Warranty Application Card

I have read and understand the safety, assembly and operating instructions provided with my Game Winner product. I have read the warranty information and know that I can call Innopower Inc. at **(949) 262-3416** with any questions or concerns that I may have about this or any other Game Winner product. Mail to: INNOPOWER INC.

PO Box 265, E. Irvine, CA 92650. Email: customerservice@innopower.biz

Name _____ Purchase Location _____

Address _____

City/State/Zip _____

Purchase Date _____

Product _____

Manufactured by Innopower Inc., PO Box 265, E. Irvine, CA 92650