



E300
SERIES



OWNER'S MANUAL

**Read and understand this entire manual before allowing child to use this product! For assistance contact Razor.
DO NOT RETURN TO STORE.**

**NOTE: Manual illustrations are for demonstration purposes only.
Illustrations may not reflect exact appearance of actual product.
Specifications subject to change without notice.**

Please have your unit and 19 character product I.D. code with you before contacting Razor for warranty assistance and/or replacement parts.

Product I.D. Code: _____ - _____ - _____

CONTENTS

Safety Warnings	1	Usage	6
Before You Begin.....	2	Repair and Maintenance.....	7-9
Assembly and Set-Up.....	3-4	Troubleshooting Guide	10
Charging the Battery.....	5	E300/E300S Electric Scooter Parts.....	11
Pre-Ride Checklist.....	5	Warranty	14

SAFETY WARNINGS

⚠ WARNING: Riding an electric scooter does present potential risks and caution is required. Like any riding product, an electric scooter has inherent hazards associated with its use (for example, falling off or riding it into a hazardous situation). Like any riding product, electric scooters can and are intended to move and it is therefore, of course, possible to lose control or otherwise get into dangerous situations. Both children, and adults responsible for supervising them, must recognize that if such things occur, a rider can be seriously injured or die even when using safety equipment and other precautions. RIDE AT YOUR OWN RISK AND USE COMMON SENSE.

⚠ WARNING: PARENTAL AND ADULT RESPONSIBILITY AND SUPERVISION IS NECESSARY: Because products, like electric scooters, can and do present potential hazards plainly associated with their use, it is well recognized that THE NEED FOR EXERCISE OF PARENTAL RESPONSIBILITY IN SELECTING RIDING PRODUCTS APPROPRIATE TO THE AGE OF A CHILD, OR PARENTAL SUPERVISION IN SITUATIONS IN WHICH CHILDREN OF VARIOUS AGES MAY HAVE ACCESS TO THE SAME RIDING PRODUCTS, IS IMPORTANT. Not every product is appropriate for every age or size of child, and different age recommendations are found within this category of product which are intended to reflect the nature of the hazards and the expected mental or physical ability, or both, of a child to cope with the hazards.

The recommended minimum rider age is 13 and older. Any rider unable to fit comfortably on the scooter should not attempt to ride it. A parent's decision to allow his or her child to ride this product should be based on the child's maturity, skill and ability to follow rules.

Keep this product away from small children and remember that it is intended for use only by persons who are, at a minimum, completely comfortable and competent while operating the scooter.

Persons with any mental or physical conditions that may make them susceptible to injury, impair their physical dexterity or mental capabilities to recognize, understand, and follow safety instructions, and to be able to understand the hazards inherent in scooter use, should not use or be permitted to use products inappropriate for their abilities. Persons with heart conditions, head, back or neck ailments (or prior surgeries to these areas of the body), or pregnant women, should be cautioned not to operate such products.

DO NOT EXCEED THE WEIGHT LIMIT OF 220 lb (100 kg). Rider weight does not necessarily mean a person's size is appropriate to fit or maintain control of the scooter.

CHECK AND MAINTAIN SCOOTER CONDITIONS

Before use, check to confirm that any and all chain guards or other covers and guards are in place and in serviceable condition. Check that the brake is functioning properly, and that the tires are inflated properly and have sufficient tread remaining. The scooter should be maintained and repaired in accordance with the manufacturer's specifications, using only the manufacturer's authorized replacement parts, and should not be modified from the manufacturer's original design and configuration.

ACCEPTABLE RIDING PRACTICES AND CONDITIONS

Always check and obey any local laws or regulations which may affect the locations where the electric scooter may be used. Keep safely away from cars and motor vehicle traffic at all times. Only use where allowed and with caution.

Do not activate the speed control on the hand grip unless you are on the scooter and in a safe, outdoor environment suitable for riding.

The normal powered top speed of this scooter will be approximately 15 mph (24 kmh), which can be affected by conditions, such as rider weight, inclines, tire inflation and battery charge level. Avoid excessive speeds that can be associated with downhill rides.

Maintain a hold on the handlebars at all times. Do not touch the brakes or motor on your scooter when in use or immediately after riding, as these parts can become very hot.

Ride defensively. Watch out for potential obstacles that could catch your wheel or force you to swerve suddenly or lose control. Be careful to avoid pedestrians, skaters, skateboards, scooters, bikes, children or animals who may enter your path, and respect the rights and property of others.

The electric scooter is intended for use on flat, dry surfaces, such as pavement or level ground, without loose debris, such as sand, leaves, rocks or gravel. Wet, slick, bumpy, uneven or rough surfaces may impair traction and contribute to possible accidents. Do not ride your scooter in mud, ice, puddles or water. Watch out for potential obstacles that could catch your wheel or force you to swerve suddenly or lose control. Avoid sharp bumps, drainage grates, and sudden surface changes.

Do not attempt or do stunts or tricks on your electric scooter. The scooter is not made to withstand abuse from misuse, such as jumping, curb grinding or any other type of stunts. Racing, stunt riding, or other maneuvers also enhance risk of loss of control, or may cause uncontrolled rider actions or reactions.

Never allow more than one person at a time to ride the scooter.

Do not ride at night or when visibility is limited.

Never use near steps or swimming pools.

Do not allow hands, feet, hair, body parts, clothing, or similar articles to come in contact with moving parts, wheels, or drive train chain while the motor is running.

Never use headphones, a cell phone or text when riding.

Never hitch a ride with a vehicle.

Do not ride your scooter in wet or icy weather and never immerse the scooter in water, as the electrical and drive components could be damaged by water or create other possibly unsafe conditions. Never risk damaging surfaces, such as carpet or flooring, by use of an electric scooter indoors.

PROPER RIDING ATTIRE

Always wear proper protective equipment, such as an approved safety helmet (with chin strap securely buckled), elbow pads and kneepads. A helmet may be legally required by local law or regulation in your area. A long-sleeved shirt, long pants, and gloves are recommended. Always wear athletic shoes (lace-up shoes with rubber soles) and keep shoelaces tied and out of the way of the wheels, motor and drive system. Never ride barefooted or in sandals.

USING THE CHARGER

The charger supplied with the electric scooter should be regularly examined for damage to the cord, plug, enclosure and other parts. In the event of such damage, the scooter must not be charged until the charger has been repaired or replaced.

Use only with the recommended charger.

Use caution when charging.

The charger is not a toy. Charger should be operated by an adult.

Do not operate charger near flammable materials.

Unplug charger and disconnect from scooter when not in use.

Always disconnect from the charger prior to wiping down and cleaning your scooter with damp cloth.

FAILURE TO USE COMMON SENSE AND HEED THE ABOVE WARNINGS INCREASES RISK OF SERIOUS INJURY. USE WITH APPROPRIATE CAUTION AND SERIOUS ATTENTION TO SAFE OPERATION.

BEFORE YOU BEGIN

Remove contents from box. Remove the separators that protect the components from damage during shipping. Inspect the contents of the box for scratches in the paint, dents or kinked cables that may have occurred during shipping. Because the scooter was 95 percent assembled and packed at the factory, there should not be any problems, even if the box has a few scars or dents.

MAKE SURE POWER SWITCH IS TURNED "OFF" BEFORE CONDUCTING ANY ASSEMBLY OR MAINTENANCE PROCEDURES.

Estimated Assembly and Set-Up Time

Razor recommends assembly by an adult.

Allow up to 10 minutes for assembly, not including initial charge time.

Allow up to 12 hours for charge (see page 5 for charging information).

Charger

(Note: Charger design may vary from one shown)

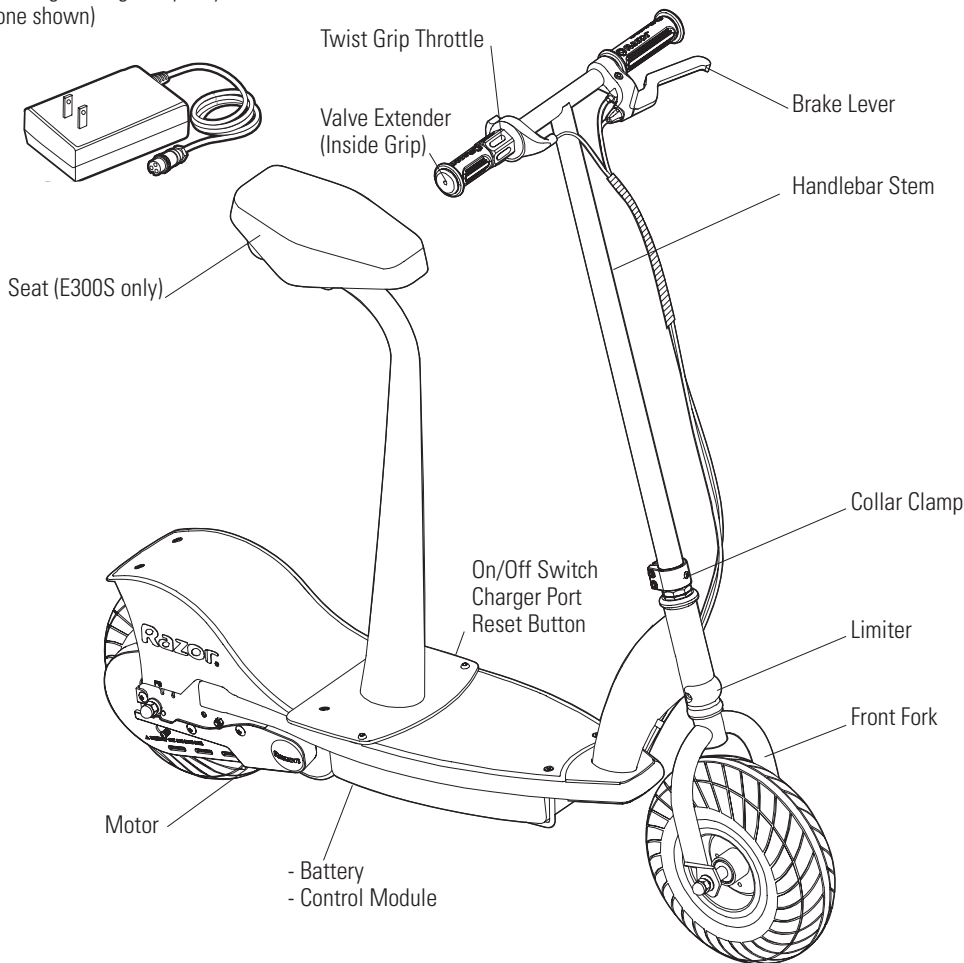

WARNING:
DO NOT USE NON-RAZOR PRODUCTS WITH YOUR RAZOR ELECTRIC SCOOTER. The scooter has been built to certain Razor design specifications. The original equipment supplied at the time of sale was selected on the basis of its compatibility with the frame, fork and all other parts. Certain aftermarket products may not be compatible and will void the warranty.

Product ID Locations:

See locations to the left

1. Handlebar Stem
2. Underneath battery tray
3. Charger
4. UPC side of box (not shown)

Required Tools

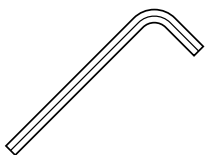

5 mm Allen Wrench

Two (2) 4 mm Allen Wrenches
(E300s only)

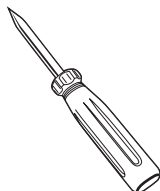

Phillips Screwdriver
(E300s only)

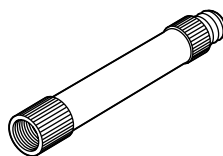

Valve Extender
(Located in right handlebar grip)

Plastic Bag Contents:

- Charger
- Tools
- Owner's Manual

Need Help? Visit our website for replacement parts, product support, a list of authorized service centers in the US and customer service contact information at www.razor.com. Please have the product I.D. code (located on the white label of your product) available for better assistance. Additional Customer Service contact information is listed at the back of this manual.

ASSEMBLY AND SET-UP

□ Attaching the Handlebars

Tool Required: 5 mm Allen wrench

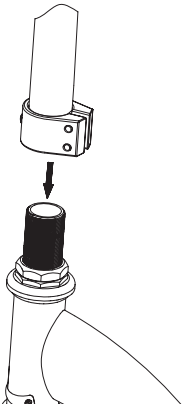

1 Loosen the collar clamp. With a twisting motion, push and twist to slide the handlebar onto the fork.

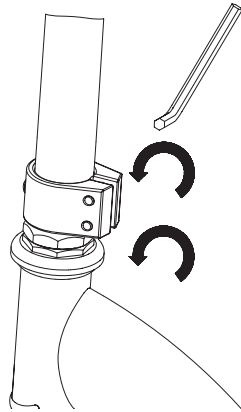

2 With the front wheel pointed straight ahead and the handlebars square to the front wheel, tighten both bolts on the clamp as shown with a 5 mm Allen wrench. Tighten securely.

Note: Make sure any cables/wires are out of the way before inserting the stem into the fork.

⚠ WARNING: Failure to properly tighten the collar clamp may allow the handlebars to dislodge while riding and may cause you to lose control and fall. When correctly tightened, the handlebars will not rotate out of alignment with the front wheel under normal circumstances.

Note: The cable and wire assembly from the handlebar must not wrap around the steering tube or handlebar. Sharp bends or twisting of the brake cable can cause the brakes to malfunction.

□ Inflating the Tires

Tires are inflated when shipped, but they invariably lose some pressure between the point of manufacturing and your purchase. **Always inflate tires to the correct PSI before first time use.**

Rear Tire

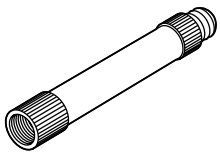

1 Use the valve extender located in the end of the right handlebar grip.

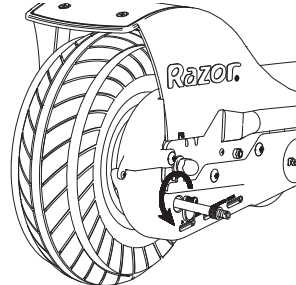

2 Open the round cover located on the chain guard by sliding the cover downward. Align the opening in the sprocket with the valve stem. Thread the valve extender completely onto the valve stem and attach the pump. Inflate to the PSI indicated on the tire sidewall.

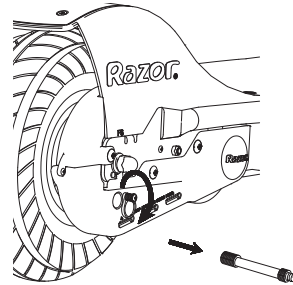

3 Remove valve extender immediately after inflating and close the round cover.

⚠ WARNING: Failure to remove the valve extender after inflating will cause the inner tube and/or adapter to be severed by the rear sprocket.

Note: If you lose the valve extender, contact customer service or one can be purchased at most auto parts stores.

⚠ WARNING: Do not over inflate, as this could damage tire or wheel.

Note: The pressurized air supplies found at gasoline stations are designed to inflate high-volume automobile tires. If you decide to use such an air supply to inflate your electric scooter tires, first make sure the pressure gauge is working, then use very short bursts to inflate to the correct PSI. If you inadvertently over-inflate the tire, release the excess pressure immediately.

Front Tire

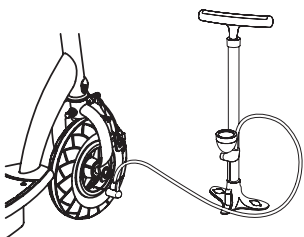

4 Using a bicycle style tire pump equipped for a Schrader-type valve, inflate the front tire to the PSI indicated on the sidewall of the tire.

ASSEMBLY AND SET-UP

□ Attaching the Seat (E300S Series Only)

Tools required: Two (2) 4 mm Allen wrenches and Phillips screwdriver.

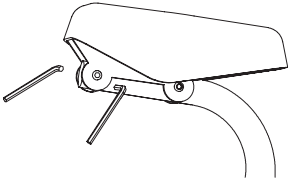

1 Attach the seat to the seat post with two (2) 4mm Allen wrenches. See note below.

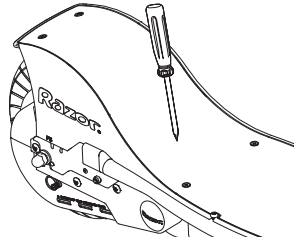

2 Remove the four screws on the middle of the deck with the 4 mm Allen wrench and the Phillips screwdriver.

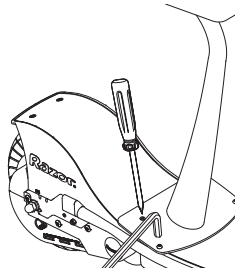

3 Place the seat post on the deck and secure using the same 4 screws.

Note: Do not completely tighten at this time. Adjust the seat tilt approximately level to the ground, or slightly tilted depending on your personal preference. Tighten securely. The seat tilt adjustment should not move when riding.

CHARGING THE BATTERY

Your electric scooter may not have a fully charged battery; therefore you must charge the battery prior to use.

- Initial charge time: 12 hours.
- Recharge time: up to 12 hours, even if the light turns green. Recommended maximum charging time is 24 hours.
- Always charge the battery immediately after riding.
- Fully charge battery before storing for extended periods of time.
- Unplug charger from the wall outlet when not in use.
- Failure to recharge battery periodically may result in a battery that will not accept a charge.
- Make sure the power switch is turned **OFF** when unit is not in use. If the power switch is left on for an extended period of time, the battery may reach a stage at which it will no longer hold a charge.
- To ensure long battery life, never store the product in freezing or below freezing temperatures! Freezing will permanently damage the battery.
- Run time: Up to 40 minutes of continuous ride time. Run time may vary depending on riding conditions, rider weight, climate, and/or proper maintenance.
- Constant starting and stopping may shorten ride time.
- Battery life can vary depending on proper maintenance and usage of the unit.

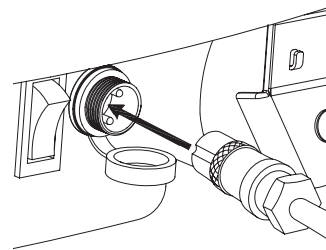
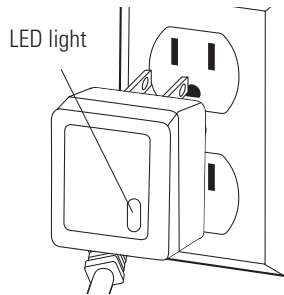
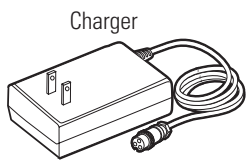

Note: Make sure power is turned **OFF** when unit is not in use. If the power switch is left on for an extended period of time, the battery may reach a stage at which it will no longer hold a charge.

- 1** Plug the charger plug into wall outlet. The light on the charger should be green.
Note: If green light (LED) does not turn on, try a different outlet.

- 2** Plug the charger into the charger port on the product. Make sure the power switch is in the **OFF** position. The light on the charger should turn red during charging. The light will turn green again when charging is complete.

⚠ WARNING: Use **ONLY** with the recommended charger. Batteries are only to be charged under adult supervision. The charger is not a toy. Always disconnect the charger before wiping down and/or cleaning the electric scooter with a damp cloth.

The charger supplied with the electric scooter should be regularly examined for damage to the cord, plug, enclosure and other parts. In the event of such damage, the electric scooter must not be charged until it has been repaired or replaced.

Chargers have built-in overcharge protection to prevent battery from being overcharged.

Note: If the charger gets warm during regular use, this is a normal response and is no cause for concern. If your charger does not get warm during use, it does not mean that it is not working properly.

Wall outlet - Green (stand by)
Wall outlet and unit - Red (charging)
Wall outlet and unit - Green (charged)

Note: Continue charging unit even if light turns green prior to 12 hours.

⚠ WARNING: Battery charge can deplete over time. Failure to recharge the battery at least once a month may result in a battery that will no longer accept a charge.

PRE-RIDE CHECKLIST



Brake

Check the brakes for proper function. When you squeeze the lever, the brake should provide positive braking action. Make sure brake is not rubbing when the lever is released.



Tires

Periodically inspect the tires for excess wear and regularly check the tire pressure. Reinflate as necessary.



Frame, Fork and Handlebars

Check for cracks or broken connections. Although broken frames are rare, it is possible for an aggressive rider to run into a curb or object, and wreck and bend or break a frame. Get in the habit of inspecting your scooter on a regular basis.



Hardware/Loose Parts

Before every ride, check all parts, such as nuts, bolts, cables, fasteners, etc., to ensure they are secure and assembled correctly. There should not be any unusual rattles or sounds from loose parts or broken components. If the unit is damaged, do not ride. **Reference "Safety Warnings" on page 1 of this manual.**



Safety Gear

Always wear proper protective gear, such as an approved safety helmet. Elbow pads and kneepads are recommended. Always wear athletic shoes (lace-up shoes with rubber soles) and keep shoelaces tied and out of the way of the wheels, motor and drive system. **NEVER RIDE BAREFOOTED OR IN SANDALS.**



Laws and Regulations

Always check and obey any local laws or regulations.



Insurance

Do not assume that your existing insurance policies necessarily provide coverage for scooter use. Check with your insurance company for information regarding insurance.

USAGE

□ Starting the Scooter

To start unit, turn on power switch; place both hands on handlebars and use one foot to push scooter forward while applying the throttle with right hand.

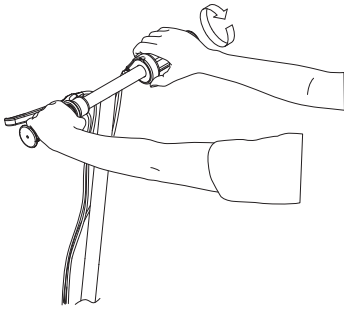

□ Stopping the Scooter

To stop unit, release the throttle and apply the brake until the unit comes to a **complete stop**.

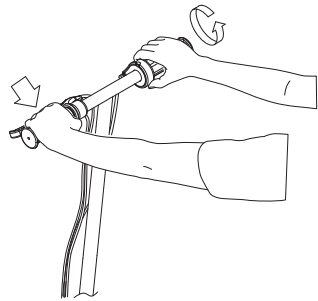

⚠ WARNING:

The brake is capable of skidding the rear tire and throwing an unsuspecting rider. Practice in an open area free from obstacles until you are familiar with the brake function. Avoid skidding to a stop as this can cause you to lose control and/or damage the rear tire.

Note: As an additional safety feature, the scooter is designed to cut power to the motor when the hand brake is applied.

REPAIR AND MAINTENANCE

Turn power switch "OFF" before beginning repair or maintenance:

- Read the instructions
- Remove charger plug
- Turn the power switch off
- Secure the unit under repair
- Exercise caution around exposed parts
- Contact Razor customer service if unsure about any repair or maintenance

□ Adjusting the Brakes

Tool required: 10 mm wrench

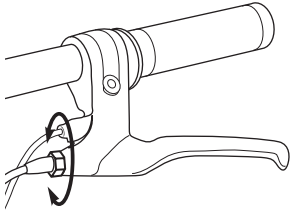

1 To adjust the brake cable tension, thread the brake lever adjuster in or out 1/4 to 1/2 turn until the desired brake adjustment is attained. Most adjustments are complete at this step. If brake still needs further adjustment, proceed to step 2.

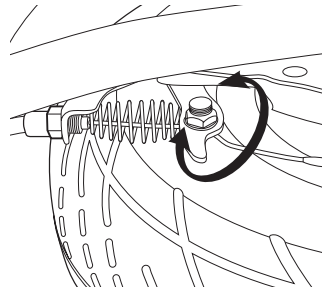

2 If the brake is too tight or too loose, use a 10 mm wrench to loosen the nut for additional adjustment on the brake cable. Securely tighten the nut when finished.

□ Chain and Rear Tire Replacement

Tools required: Phillips screwdriver, 10 mm wrench, two (2) 8 mm wrenches and two (2) 16 mm wrenches.

Disassembly

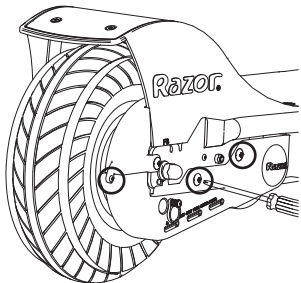

1 With a Phillips screwdriver, loosen the three (3) screws on the chain guard and remove.

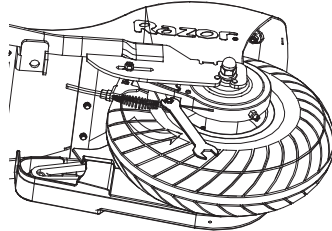

2 With a 10 mm wrench, loosen the brake cable anchor bolt and disconnect the cable.

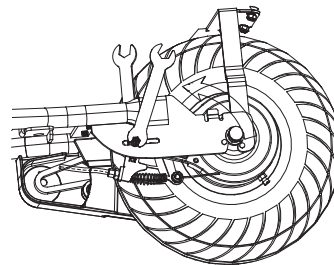

3 With two (2) 8 mm wrenches, remove the cable guide bracket from the frame and brake plate. Keep the bolt, washer, spacer, and nuts together.

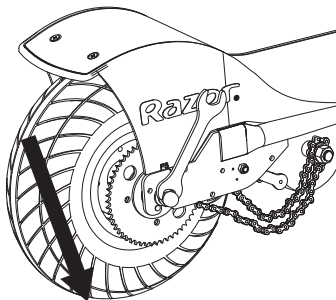

4 With two (2) 16 mm wrenches, loosen the axle locknuts. Push down and remove wheel from the frame. Remove chain from rear sprocket.

⚠ WARNING:

The brake is capable of skidding the rear tire and throwing an unsuspecting rider. Practice in an open area free from obstacles until you are familiar with the brake function. Avoid skidding to a stop as this can cause you to lose control and/or damage the rear tire.

Note: Rear wheel hardware sequence.

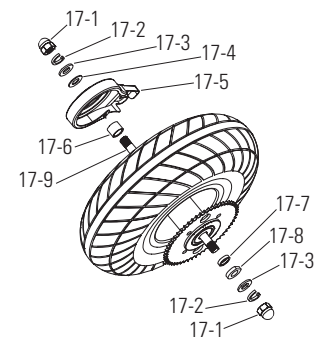

Left Side (Brake)

- 17-1 Locknut
- 17-2 Spring Washer
- 17-3 Washer (thick)

Frame

- 17-4 Washer (thin)
- 17-5 Brake Plate
- 17-6 Spacer

Middle

- 17-9 Rear Axle Bolt

Right Side (Throttle)

- 17-7 Spacer
- 17-8 Washer (plate cut)

Frame

- 17-3 Washer (thick)
- 17-2 Spring Washer
- 17-1 Locknut

REPAIR AND MAINTENANCE

Reassembly

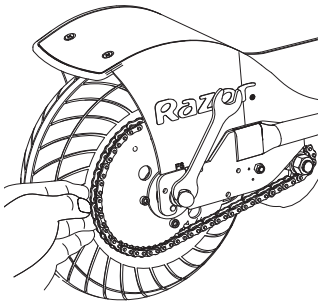

5 Install the chain onto the rear wheel sprocket. Slip wheel axle into the frame slots. See rear wheel hardware sequence on prior page. Push the chain tensioner down to create slack in chain. Hand tighten rear axle locknuts.

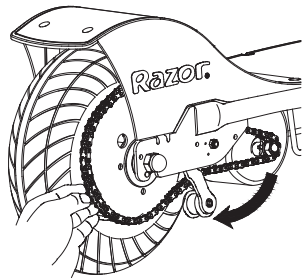

6 Verify chain is properly installed on each sprocket and tensioner is correctly positioned at the bottom of the chain.

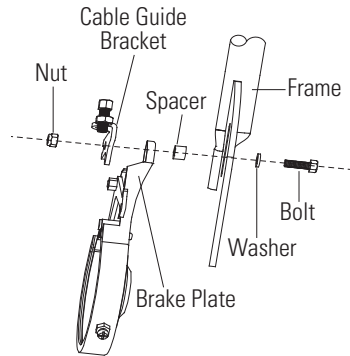

7 Install the cable guide bracket to the frame and brake plate using bolt, washers, and nut. Do not tighten.

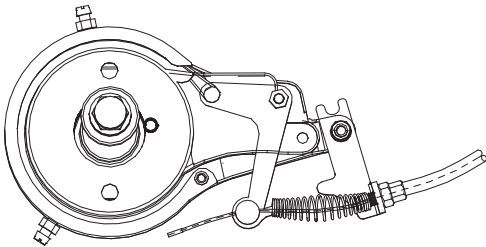

8 Thread the brake cable through the brake adjuster barrel, through the large spring, and into the small hole in the side of the anchor bolt. Position the cable to the original location (as indicated by the slight cable kink) and tighten securely.

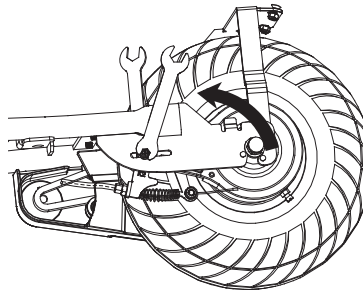

9 Tighten the cable guide bracket bolt. Tighten the locknuts on the rear axle. Test the brake to verify proper function before riding. Readjust as needed.

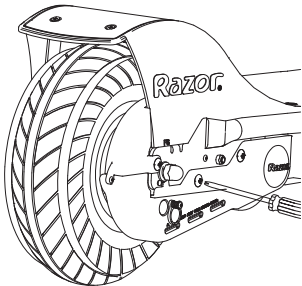

10 Replace the chain guard.

□ Front Tire Replacement

Tools required: Two (2) 16 mm wrenches.

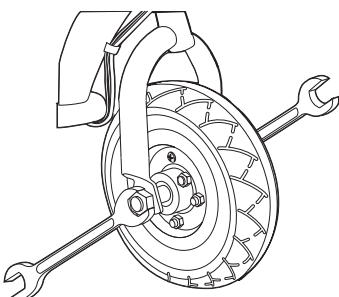

1 Using two (2) 16 mm wrenches, loosen the front axle bolts by turning the wrenches counter clockwise. Remove wheel and install replacement wheel. Note the sequence of the hardware.

Note: Front wheel hardware sequence.

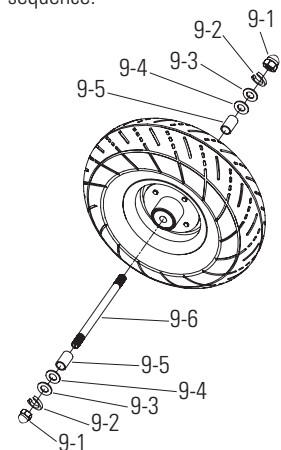

Right Side (Throttle)

9-5 - Spacer

9-4 - Washer

Fork

9-3 - Washer

9-2 - Spring Washer

9-1 - 16 mm Locknut

Middle

9-6 - Front Axle Bolt

Left Side (Brake)

9-5 - Spacer

9-4 - Washer

Fork

9-3 - Washer

9-2 - Spring Washer

9-1 - 16 mm Locknut

REPAIR AND MAINTENANCE

Battery Care and Disposal

Do not store in freezing or below freezing temperatures! To properly maintain your battery and ensure maximum battery life, carefully read the "Charging the Battery" section on page 5 of this owner's manual.



CONTAINS SEALED LEAD ACID BATTERIES. BATTERIES MUST BE RECYCLED.

Disposal: Your Razor product uses sealed lead-acid batteries which must be recycled or disposed of in an environmentally safe manner. Do not dispose of a lead-acid battery in a fire; the battery may explode or leak. Do not dispose of a lead-acid battery in your regular household trash. The incineration, land filling or mixing of sealed lead-acid batteries with household trash is prohibited by law in most areas. Return exhausted batteries to a federal or state approved lead-acid battery recycler or a local seller of automotive batteries. If you live in Florida or Minnesota, it is prohibited by law to throw away lead-acid batteries in the municipal waste stream.

Charger

The charger supplied with the electric scooter should be regularly examined for damage to the cord, plug, enclosure and other parts, and in the event of such damage, the product must not be charged until it has been repaired or replaced.

Use ONLY with the recommended charger.

Wheels

Wheels and drive system are subject to normal wear and tear. It is the responsibility of the user to periodically inspect wheels for excess wear and adjust and replace drive train components as required.

Replacement Parts

The most frequently requested replacement parts are available for purchase at some Razor retail partners. For the complete selection of replacement parts visit shop.razor.com.

Repair Centers

For a list of authorized Razor repair centers:

- Check online at www.razor.com.
- Additional Customer Service contact information is listed on the back of this manual.

⚠ WARNING: If a battery leak develops, avoid contact with the leaking acid and place the damaged battery in a plastic bag. Refer to the disposal instructions at left. If acid comes into contact with skin or eyes, flush with cool water for at least 15 minutes and contact a physician.

⚠ WARNING: Battery posts, terminals and related accessories contain lead and lead compounds. **Wash your hands after handling.**

Need Help? Visit our website for replacement parts, product support, a list of authorized service centers in the US and customer service contact information at www.razor.com. Please have the product I.D. code (located on the white label of your product) available for better assistance. Additional Customer Service contact information is listed at the back of this manual.

TROUBLESHOOTING GUIDE

*Unit(s) should be turned off and fully charged prior to doing any Troubleshooting

NOTE: All troubleshooting steps should be performed by an adult only

Problem	Possible Cause	Solution
Does not work out of the box	Loose connection(s)	Check for loose connections/wires.
No longer works	Loose connection(s)	Check for loose connections/wires.
	Charger not working	Check power to wall outlet and/or try a different outlet Check lights on charger: Plugged into wall - Green Plugged into wall & unit - Red (charging) Plugged into wall & unit - Green (charging complete) No lights/Blinking lights - Replace Charger
	Tripped reset button	Secure unit; turn the power switch on and with no weight on the unit, lift up back end and apply the throttle. If motor engages - Replace Battery The reset button will trip if the motor is overloaded. An excessive overload may be caused, for example, by too heavy a rider, too steep a hill, etc. Wait a few seconds then press reset button. Correct riding conditions to prevent overload
	Battery will not hold a charge	If motor does not engage, but makes a clicking sound - Replace battery. If motor does not engage, no clicking sound - Replace Control Module
Short ride time/runs slow	Rider weight	Do not exceed 220 lb (100 kg) maximum weight limit
	Low tire pressure	Tires will lose some pressure over time. Verify correct tire pressure
	Riding conditions	Use only on flat, dry surfaces. Avoid inclines and areas with heavy debris
	Battery not fully charged	Charge unit for a minimum 12 hours
	Old/damaged battery	Secure unit; turn the power switch on and with no weight on the unit, lift up back end and apply the throttle. If motor engages - Replace Battery Charge battery periodically when not in use
	Improper battery maintenance	Do not store unit in freezing or below freezing temperatures. Freezing will permanently damage the battery and greatly reduce ride time. Refer to page 5 for charging information
	Brake is dragging	Check the brake cable has 2-3 mm of slack at lever. Cables should NOT be wrapped around the handlebar stem. Adjust brake cable slack according to page 7 instructions
Runs intermittently	Loose connection(s)	Check the wires around the throttle and connectors underneath the deck plate for other possible loose connections.
		Replace - twist-grip throttle.

For more troubleshooting tips, a list of available replacement parts or to locate an authorized Service Center in your area, visit our website at www.razor.com or call toll free 866-467-2967 to speak to a live Customer Service Representative

Need Help? Visit our website for replacement parts, product support, a list of authorized service centers in the US and customer service contact information at www.razor.com. Please have the product I.D. code (located on the white label of your product) available for better assistance. Additional Customer Service contact information is listed at the back of this manual.

E300/E300S SERIES ELECTRIC SCOOTER PARTS

Keep your scooter running for years with genuine Razor parts. Visit our website or e-mail us for more information on spare part availability. (Specifications subject to change without notice.)

- | | | |
|-------------------------------------------------------------------------------------------------------------------------------------------------------------------------------------------------------------------------------------------------------------------------------------------------------------------------------------------------------------------------------------------------------------------------------------------------------------------------------|-----------------------------------------------------------------------------------------------------------------------------------------------------------------------------------------------------------------------------------------------------------------------------------------------------------------------------------------------------------------------------------------------|----------------------------------------------------------------------------------------------------------------------------------------------------------------------------------------------------------------------------------------------------------------------------------------------------------------------------------------------------------------------------------------------------------|
| <ol style="list-style-type: none"> 1. Handlebar Grip (right/left) <ul style="list-style-type: none"> 1-1 Handlebar End Cap 1-2 Valve Extender 2. Single Speed Twist Grip Throttle <ul style="list-style-type: none"> 2-1 Sleeve 3. Handlebar Stem 4. Brake Lever Assembly 5. Collar Clamp 6. Headset (upper/lower) 7. Limiter and Cover | <ol style="list-style-type: none"> 8. Front Fork 9. Front Wheel Complete <ul style="list-style-type: none"> (See page 8 for hardware sequence) 10. Control Module 11. Battery Tray 12. Reset Button 13. On/ Off Switch 14. Charger Port 15. Motor (24V/250W) 16. Kickstand | <ol style="list-style-type: none"> 17. Rear Wheel Complete <ul style="list-style-type: none"> (See page 7 for hardware sequence) 18. Chain Tensioner 19. Chain 20. Chain Guard 21. Battery (2x 12V/7Ah) 22. Battery Bracket 23. Deck Plate with Grip Tape 24. Seat Post with Seat (E300S only) |
|-------------------------------------------------------------------------------------------------------------------------------------------------------------------------------------------------------------------------------------------------------------------------------------------------------------------------------------------------------------------------------------------------------------------------------------------------------------------------------|-----------------------------------------------------------------------------------------------------------------------------------------------------------------------------------------------------------------------------------------------------------------------------------------------------------------------------------------------------------------------------------------------|----------------------------------------------------------------------------------------------------------------------------------------------------------------------------------------------------------------------------------------------------------------------------------------------------------------------------------------------------------------------------------------------------------|

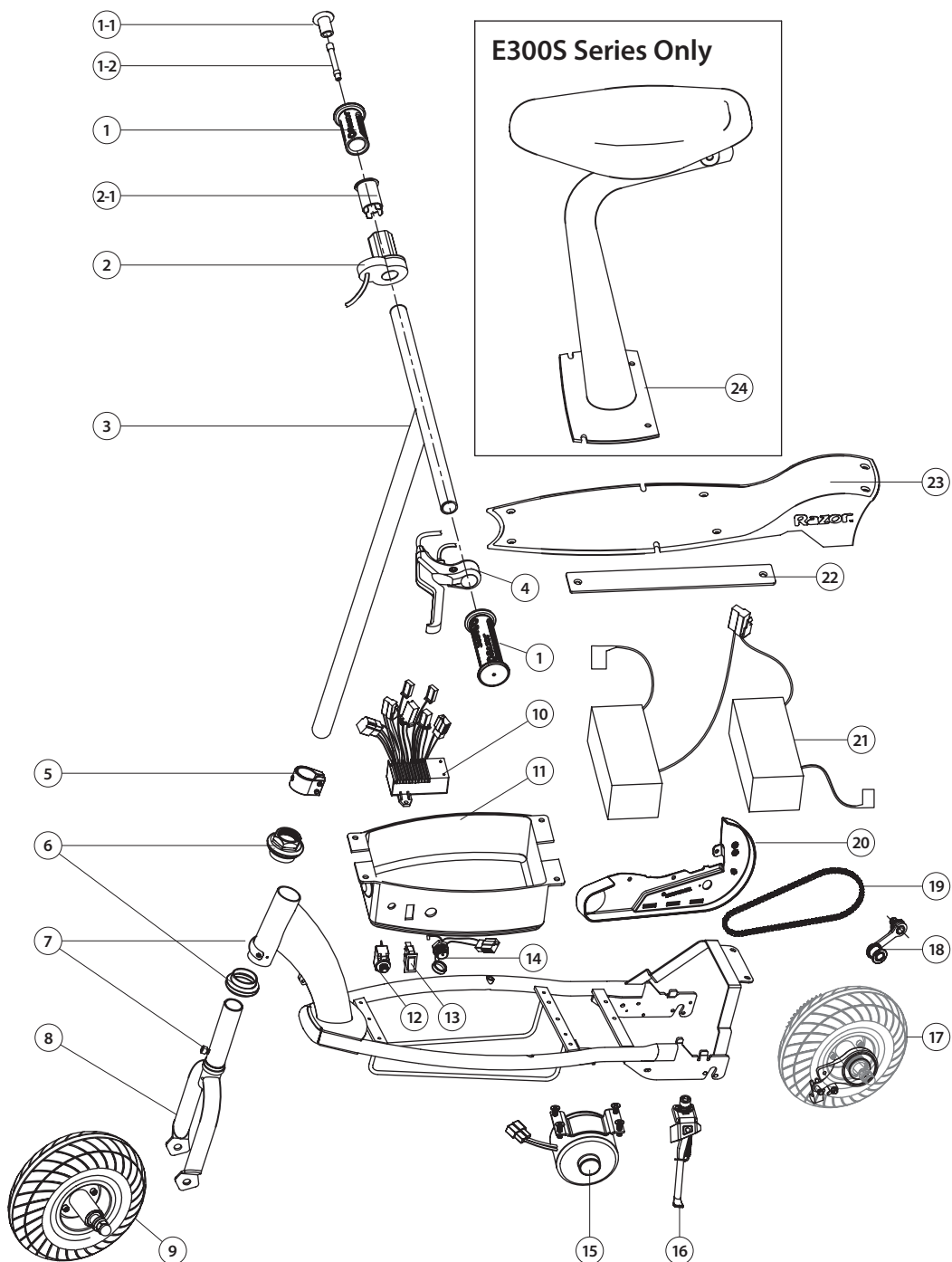

NOTICE: INSURANCE

YOUR INSURANCE POLICIES MAY NOT PROVIDE COVERAGE FOR ACCIDENTS INVOLVING THE USE OF THIS SCOOTER/ELECTRIC RIDE-ON PRODUCT. TO DETERMINE IF COVERAGE IS PROVIDED, YOU SHOULD CONTACT YOUR INSURANCE COMPANY OR AGENT.

FCC COMPLIANCE

This device complies with Part 15 of the FCC Rules. Operation is subject to the following two conditions: (1) This device may not cause harmful interference, and (2) this device must accept any interference received, including interference that may cause undesired operation.

Note: This equipment has been tested and found to comply with the limits for a Class B digital device, pursuant to part 15 of the FCC Rules. These limits are designed to provide reasonable protection against harmful interference in a residential installation. This equipment generates, uses and can radiate radio frequency energy and, if not installed and used in accordance with the instructions, may cause harmful interference to radio communications. However, there is no guarantee that interference will not occur in a particular installation. If this equipment does cause harmful interference to radio or television reception, which can be determined by turning the equipment off and on, the user is encouraged to try to correct the interference by one or more of the following measures:

- Reorient or relocate the receiving antenna.
- Increase the separation between the equipment and receiver.
- Connect the equipment into an outlet on a circuit different from that to which the receiver is connected.
- Consult the dealer or an experienced radio/TV technician for help.

⚠ WARNING: Changes or modifications to this unit not expressly approved by the party responsible for compliance, could void the user's authority to operate the equipment.

WARRANTY

Razor Limited Warranty

The manufacturer warrants this product to be free of manufacturing defects for a period of 90 days from date of purchase. This Limited Warranty does not cover normal wear and tear, tires, tubes or cables, or any damage, failure or loss caused by improper assembly, maintenance, storage or use of the Razor electric scooter.

This Limited Warranty will be void if the product is ever:

- used in a manner other than for recreation or transportation;
- modified in any way;
- rented.

The manufacturer is not liable for incidental or consequential loss or damage due directly or indirectly to the use of this product.

Razor does not offer an extended warranty. If you have purchased an extended warranty, it must be honored by the store at which it was purchased.

For your records, save your original sales receipt with this manual and write the serial number below.

CUSTOMER SERVICE CONTACT INFORMATION

Need Help? Visit our website for replacement parts, product support, a list of authorized service centers in the US and customer service contact information at www.razor.com. Please have the product I.D. code (located on the white label of your product) available for better assistance. Additional Customer Service contact information is listed below:

AMERICAS

Razor USA LLC
P.O. Box 3610
Cerritos, CA 90703
USA

+1 866 467 2967
Monday - Friday
8:00 AM - 5:00 PM Pacific Time
customersupport@razorusa.com

EUROPE, MIDDLE EAST, AFRICA

Razor USA LLC (Europe)
Handelsweg 2
2742 RD Waddinxveen
Netherlands

+44 (0) 120 267 2702
info@razoreu.com

ASIA

Razor USA LLC (Asia)
P.O. Box 3610
Cerritos, CA 90703
USA

+81 50 7579 6622
info@razor-asia.com

DISTRIBUTED IN THE UK AND IRELAND BY:

Re:creation Limited
2 Meadows Business Park
Station Approach, Blackwater
Camberley, Surrey GU17 9AB
United Kingdom

+44 (0) 118 973 6222 *Tel*
+44 (0) 118 973 6220 *Fax*
sales@recreationltd.co.uk

DISTRIBUTED IN AUSTRALIA BY:

Funtastic Limited
2/307 Ferntree Gully Road,
Mount Waverley Vic 3149,
Australia

+1 800 244 543
info@funtastic.com.au

Community Design No. 130919-0001, U.S. Design Patent D497,397 S, U.S. Design Patent D513,629 S, Canadian Design Registration No. 105673

Printed in China for Razor USA LLC.

Copyright © 2003-2018 Razor USA, LLC. All rights reserved. Razor® and the Razor logo design are among the registered trademarks of Razor USA LLC in the United States and/or select foreign countries. The E300 logo design is a registered trademark of Razor USA LLC.

US_180109