

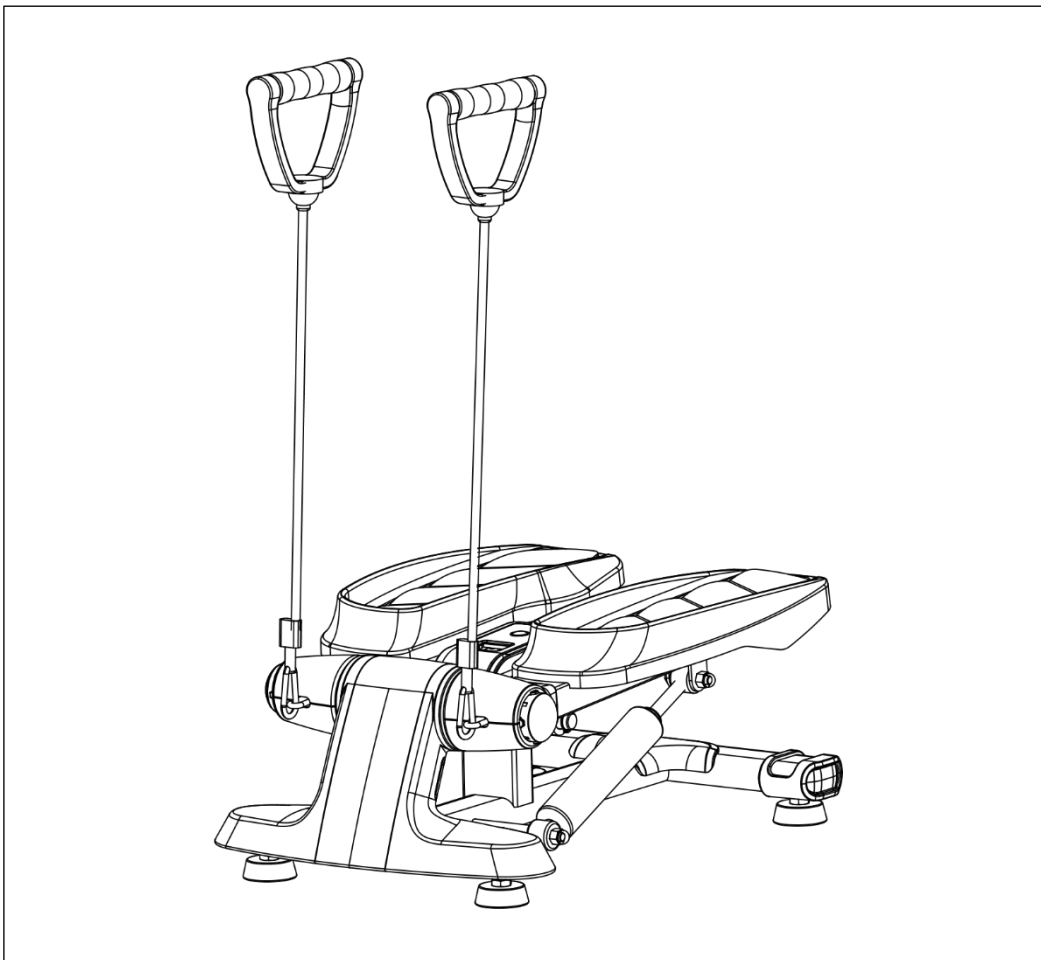

# VERSA STEPPER

## SF-S0870

### USER MANUAL



**IMPORTANT!** Please retain owner's manual for maintenance and adjustment instructions. Your satisfaction is very important to us, **PLEASE DO NOT RETURN UNTIL YOU HAVE CONTACTED US:** [support@sunnyhealthfitness.com](mailto:support@sunnyhealthfitness.com) or 1- 877 - 90SUNNY (877-907-8669).



@SUNNYHEALTHFITNESS



@SUNNYHEALTHFIT



@SUNNYHEALTHFITNESS

SUNNYHEALTHFITNESS.COM/SIGNUP

# **IMPORTANT SAFETY INFORMATION**







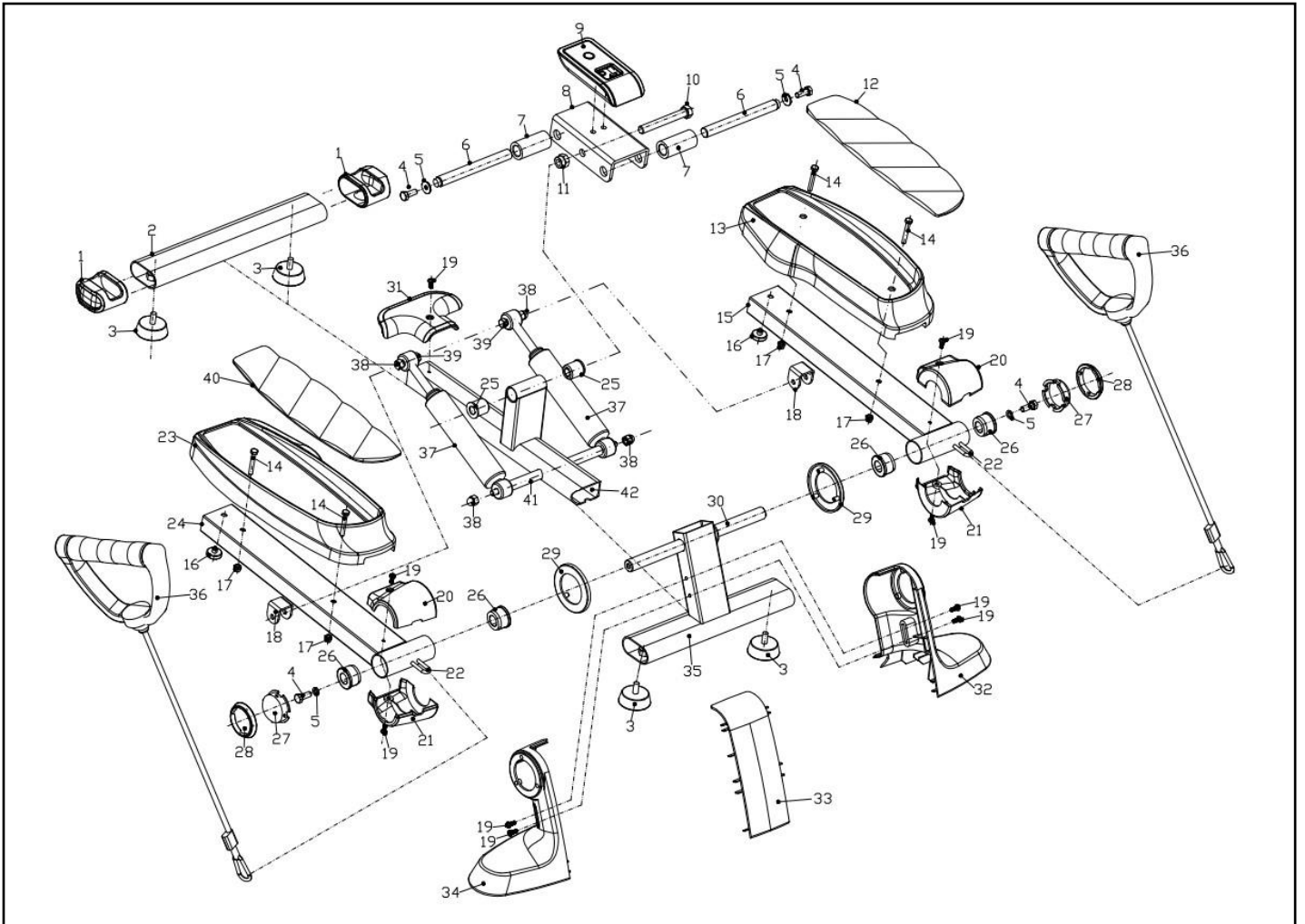

We thank you for choosing our product. To ensure your safety and health, please use this equipment correctly. It is important to read this entire manual before assembling and using the equipment. Safe and effective use can only be achieved if the equipment is assembled, maintained and used properly. It is your responsibility to ensure that all users of the equipment are informed of all warnings and precautions.

1. Before starting any exercise program, you should consult your physician to determine if you have any medical or physical conditions that could put your health and safety at risk or prevent you from using the equipment properly. Your physician's advice is essential if you are taking medication that affects your heart rate, blood pressure or cholesterol level.
2. Be aware of your body's signals. Incorrect or excessive exercise can damage your health. Stop exercising if you experience any of the following symptoms: pain, tightness in your chest, irregular heartbeat, shortness of breath, lightheadedness, dizziness, or feelings of nausea. If you do experience any of these conditions, you should consult your physician before continuing with your exercise program.
3. Keep children and pets away from the equipment. The equipment is designed for adult use only.
4. Use the equipment on a solid, flat level surface with a protective cover for your floor or carpet. To ensure safety, the equipment should have at least 2 feet (60 CM) of free space all around it.
5. Ensure that all nuts and bolts are securely tightened before using the equipment. The safety of the equipment can only be maintained if it is regularly examined for damage and/or wear and tear.
6. Always use the equipment as indicated. If you find any defective components while assembling or checking the equipment, or if you hear any unusual noises coming from the equipment during exercise, discontinue use of the equipment immediately and do not use until the problem has been rectified.
7. Wear suitable clothing while using the equipment. Avoid wearing loose clothing that may become entangled in the equipment.
8. Do not place fingers or objects into the moving parts of the equipment.
9. The maximum weight capacity of this unit is 245 pounds (111 KG).
10. The equipment is not suitable for therapeutic use.
11. To avoid bodily injury and/or damage to the product or property, proper lifting and moving are required.
12. Your product is intended for use in cool, dry conditions. You should avoid storage in extreme cold, hot or damp areas as this may lead to corrosion and other related problems.
13. This equipment is designed for indoor and home use only! It is not intended for commercial use!

# EXPLODED DIAGRAM



# HARDWARE PACKAGE

	#19	M5*10	9PCS		#17	M6*8	4pcs
	#4	M8*1.25*15	4PCS		#10	M12*110	1pc
	#39	M8*35	2PCS		#11	M12	1pc
	#38	M8	4PCS		#14	M6*40	4pcs

**Note: When the hydraulic cylinder is used for 20 minutes, let the hydraulic cylinder cool down. Please do not touch the oil cylinder after use.**

# PARTS LIST

No.	Description	Spec.	Qty.	No.	Description	Spec.	Qty.
1	Rear End Cap	38X57.5X68 V=25.6	2	22	Hook	Ø 5x75	2
2	Rear Stabilizer	60x30x2x350	1	23	Step Right		1
3	Adjust Knob	Ø 49.5*17 V63.7	4	24	Step Support Assembly Right	30x60x1.5x420	1
4	Screw	M8*1.25*15	4	25	Axle Sleeve For Computer Frame		2
5	Washer	Ø8	4	26	Step Tube Axle Sleeve		4
6	Pedal Slide Shaft	Ø 15x245	2	27	Side Cover	Ø 51.2x24.3 V=10	2
7	Sleeve for Shaft	Ø 28x56	2	28	Side Decorative Circle	Ø 56.7x8.8 V=4.9	2
8	Holder of Computer	76x42x5x140	1	29	Intermediate Decorative Circle	Ø 78.5x11.5 V=9.7	2
9	Computer		1	30	Shaft	Ø 16x150	1
10	Outer Hexagon Bolt	M12*110	1	31	Cover For Rear Stabilizer	160.5x92.6x19 V=31.4	1
11	Outer Hexagon Nut	M12	1	32	Front Decorative Cover (Left)	187.7X179X147.3 V=120	1
12	Step Mat Left	98x27.6x323.4 V=178	1	33	Front Decorative Cover (Middle)	211X45X95 V=61.1	1
13	Step Left	171.7x62.9x377.2 V=348	1	34	Front Decorative Cover (Right)	187.7X179X147.3 V=120	1
14	Step Bolt	M6*40	4	35	Front Stabilizer	60x30x2x300	1
15	Step Support Assembly Left	30x60x1.5x420	1	36	Resistance Band		2
16	Crash Pad	Ø 30X9.8	2	37	Hydraulic Cylinder		2
17	Step Fixed Nut	M6*8	4	38	Hexagon Cap Head	M8	4
18	Hydraulic Cylinder Support	25x3x65	2	39	Nut	M8*35	2
19	Screw	M5*10	9	40	Step Mat Right		1
20	Front Decorative Cover (Upper)	76x40.3x83.3 V=25.23	2	41	Hydraulic Cylinder Fixed Shaft	1Ø 5x253.5	1
21	Front Decorative Cover (Lower)	76x44.6x84 V=26	2	42	Middle Frame		1

## Replacement Parts (U.S. and Canadian Customers only)

Please provide the following information in order for us to accurately identify the part(s) needed:

- ✓ The model number (found on cover of manual)
- ✓ The product name (found on cover of manual)
- ✓ The part number found on the Parts List and Exploded Diagram (found near the front of the manual)

Please contact us at [support@sunnyhealthfitness.com](mailto:support@sunnyhealthfitness.com) or 1- 877 - 90SUNNY (877-907-8669).

# **ASSEMBLY INSTRUCTIONS**

We value your experience using Sunny Health and Fitness products. For assistance with parts or troubleshooting, please contact us at [support@sunnyhealthfitness.com](mailto:support@sunnyhealthfitness.com) or 1-877-90SUNNY (877-907-8669).

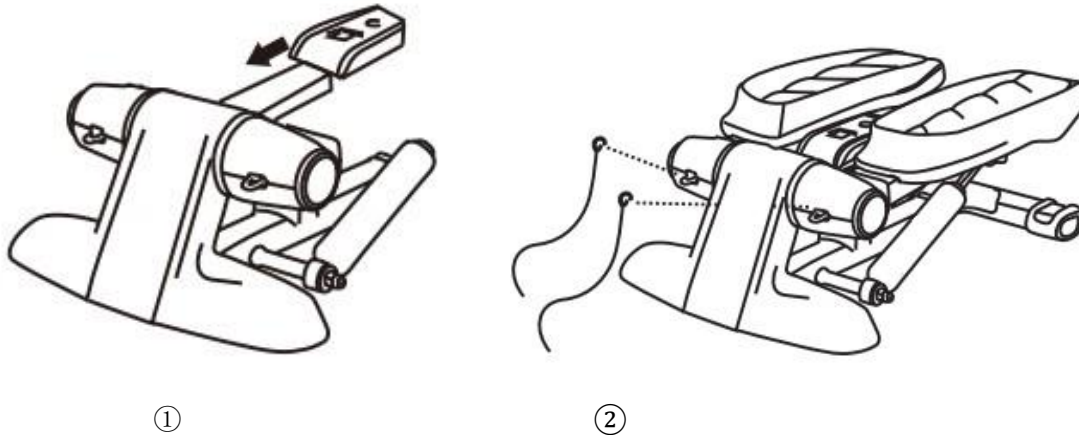

Figure 1: Take out the **Computer (No. 9)** and insert it according to the picture.

Figure 2: Attach 2 **Resistance Bands (No. 36)** to the hooks as shown in the picture.

## **Using the Stepper**

**Important tips:** Please put the stepper on flat, solid ground. It is recommended to place a carpet pad underneath the stepper to prevent damage to the ground after long-term use.

- First, place the stepper in front of you. Put one foot on the pedal completely and keep your legs vertical. Move slowly until your leg touches the end.
- Secondly, maintain the balance and make the other foot follow the previous action on the opposite pedal.

Start practicing with a slow pace and gradually familiarize yourself with the exercise. Speed up the pace and add upper body actions to incorporate exercising other parts of your body. It is recommended to use this stepper at least once every other day. At the beginning, exercise for 5 minutes, then gradually increase to 15 minutes, and then 30 minutes. You can also exercise every day, but remember, do what you can!

**Recovery after exercise:** To reduce muscle pain in the days to follow, movement after exercise is very important. Make sure to drink water, take a deep breath, and relax the body. This will help make you physically and mentally comfortable and provide you with a sense of accomplishment.

# OPERATING INSTRUCTIONS

## COMPUTER DISPLAY:

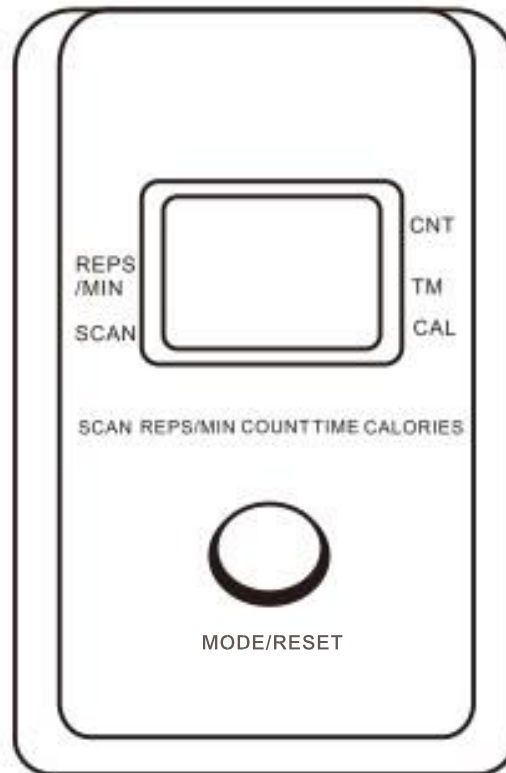

## FUNCTIONS:

**SCAN:** Automatically displays each function value in a sequence.

**TIME:** from 0-99:59.

**CALORIES:** Accumulated calories burned during exercise. This is only a reference value, not for medical reference.

**COUNT:** The number of times accumulated.

**REPS/MIN:** The rate of steps per minute.

**AUTO SCAN:** In this mode the display will automatically show REPS/MIN, TIME, CALORIES, SCAN for 4 seconds.

**AUTO ON/OFF:** If there is no movement for 4 minutes, the display will turn off automatically. You can restart the display by touching the mode button when stepping.

**IMPORTANT:** Any movement will start the display. Pressing the mode button will allow you to select from the following four items (REPS/MIN, TIME, CALORIES, SCAN).

# TROUBLESHOOTING

<b>PROBLEM</b>	<b>POSSIBLE SOLUTION</b>
Pedal rotation is not smooth or stops running	<ol style="list-style-type: none"><li>1. Interlocking is usually caused by movement over time. In this case, the heat produced by the step resistance causes inner dish rotational delay. If you want the pedal to be flexible to rotate, please wait for the cylinder to cool down before use.</li><li>2. If the hydraulic cylinder is damaged, please replace it.</li></ol>
Harsh noise when rotating	<ol style="list-style-type: none"><li>1. First, make sure that all bolts have been tighten. Then, add a small amount of lubricant to reduce friction and noise.</li></ol>
No displays on the meter	<ol style="list-style-type: none"><li>1. If there is no battery installed, please open the display table's back cover and install the battery.</li><li>2. Electronic meter is damaged, please replace it.</li><li>3. The cable is not plugged in, please inspect it.</li><li>4. The step angle is too low, please re-adjust the stepper angle.</li></ol>

Version 1.1

## CONNECT WITH US

FOR FITNESS ARTICLES, VIDEOS & WORKOUTS

[SUNNYHEALTHFITNESS.COM/SIGNUP](https://SUNNYHEALTHFITNESS.COM/SIGNUP)



@SUNNYHEALTHFITNESS



@SUNNYHEALTHFITNESS



@SUNNYHEALTHFIT

