



MAGELLAN
O U T D O O R S®

Instruction Manual

Mag Mission 8P Tent

Style# 153640

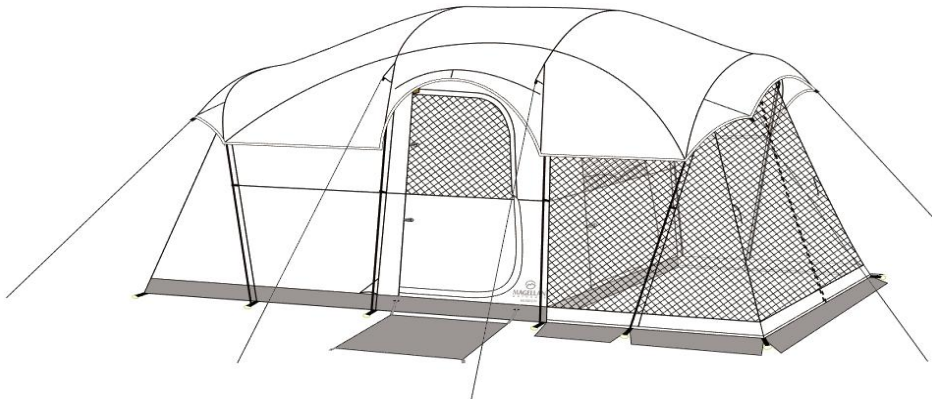

Please keep this instruction manual for future reference

Customer Service: (877) 579-1550

**Business Hours:
Monday thru Friday
8:30am to 5:30pm, EST**

(Made in China)

Table of Contents

Warnings.....	2
Parts List.....	3
Assembly Instructions.....	4-5
Care and Maintenance.....	6

Note: Before beginning assembly of product, make sure all parts are present. Compare parts with package content list and hardware contents. If any part is missing or damaged do not attempt to assemble the unit. Contact customer service for replacement parts.

Warnings



IMPORTANT SAFETY AND TIP INFORMATION

TO MAXIMIZE THE ENJOYMENT OF YOUR PRODUCT PLEASE ASSEMBLE AND USE YOUR PRODUCT AS SAFELY AS POSSIBLE.









THE PURPOSE OF THE SAFETY ALERT SYMBOL  IS TO CALL YOUR ATTENTION TO POSSIBLE HAZARDS RELATING TO THE USE AND ASSEMBLY OF YOUR PRODUCT.

THE PURPOSE OF THE TIP SYMBOL  IS TO CALL YOUR ATTENTION TO SUGGESTIONS THAT WILL ASSIST YOU IN THE ASSEMBLY/DISASSEMBLY PROCESS AND ENHANCE YOUR CAMPING EXPERIENCE. WHEN YOU SEE THESE SYMBOLS, PLEASE CLOSELY FOLLOW THE INFORMATION PROVIDED.

WARNING

- **KEEP ALL FLAME AND HEAT SOURCES AWAY FROM THIS TENT FABRIC.** This fabric is not fireproof! It is made with flame resistant fabric which meets CPAI-84 specifications. The fabric may burn if left in continuous contact with any flame source. The application of any foreign substance to the tent fabric may render the flame resistant properties ineffective.
- Do not erect this product near an open flame.
- Never use any fuel burning, oxygen consuming devices, or any device that produces fumes (including, but not limited to cooking stoves, lanterns, candles, hibachis, or heaters) in or around your product. Inhalation of fumes may result in carbon monoxide poisoning, injury or death.
- Your product is water repellent, however, during heavy rain some leakage may occur. Keep objects from touching the inside, as objects may cause leakage at the point of contact.
- To prevent seam leakage (floor seams in particular), a seam sealer compound must be applied to the seams. Use recommended water repellent compounds on our product. Read the label on any product before using. Questions? Call our Customer Service number.
- Your recreational product is made from synthetic fabric that has been treated and is highly resistant to the sun's Ultraviolet (UV) light. No fabric can withstand prolonged exposure to sunlight.
- Do not spray or apply insecticide or pesticide on your product. It may damage UV resistant or water repellent properties of this product.
- Our recreational products are constructed to rigid specifications. They are not made, however, for extreme weather, climates, or environments. Modification, abuse and extreme weather are conditions that may adversely affect the structural integrity of the tent.
- Additional precautions may be necessary during inclement or unexpected weather conditions. Here are some tips that may help during these times.
 -  Use guy lines to help secure your structure during periods of heavy winds.
 -  Storms or steady rains may cause water to collect in pockets on the roof. This will add weight, which can weaken the overall structure, causing the tent to collapse. Maintain a watchful eye and remove any water accumulation that may occur.

Parts List

	Part	Image	Qty
A	Tunnel Tent Body and Separate Tent Rainfly		1
B	Fiberglass Pole & Steel Pole set		1
C	Carry bag		1
D	Pole Bag		1
E	Stake bag		1
F	Guy rope		8
G	Steel stake		23
H	Detachable mud mat		1
I	Tablet Entertainment Pocket		1

Assembly Instructions

Step 1:

1. Verify package contents listed on Page 3 by emptying contents of bag(s) and confirming all parts are undamaged.

 **Tip: Do this at home prior to your first use of the product.**

2. Remove tent and poles from carry bag. Extend all poles and sort into groups based on color tape (yellow/white/blue) and by pole type (steel leg poles, fiberglass roof poles).

1. Black Fiberglass Roof Poles 8.5mm

73.62in

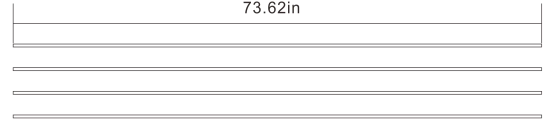

2. Steel Leg Pole 16mm

59.45in

55.71in

70.47in

67.52in

68.11in

65.16in

White

Yellow

Blue

3. Black Fiberglass Eave Poles 6.0mm

73.23in

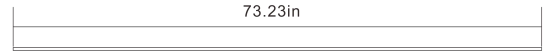

Step 2:

3. Select a smooth, level site and spread out the tent body. Place tent body in the correct orientation on the camp site and secure the main four corners of the tent into the ground using the included tent stakes. Place stakes into rope loops and hammer them into the ground.

4. Begin set up on the roof first. Slide one of the four black fiberglass roof poles through each of the pole sleeves located on roof of tent.

5. Starting at the end of the tent begin attaching the leg poles to the roof poles. Insert the end of each fiberglass roof pole into its color coded steel leg pole.

6. Once the roof pole is attached place the pin with color coded indicator located at the base of the tent into the other end of the steel pole.

REPEAT PROCESS FOR REMAINING POLES

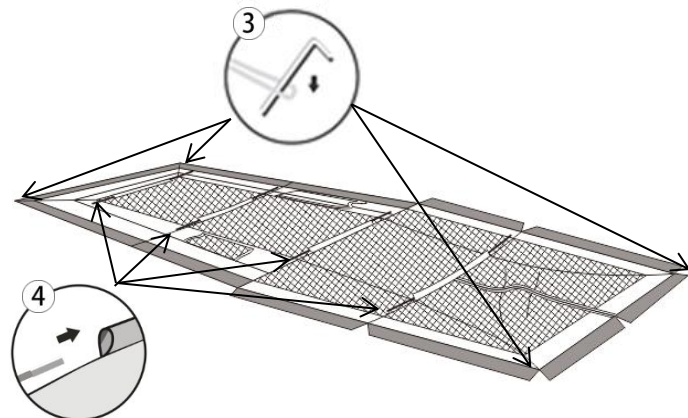

****Assemble starting from back to front**

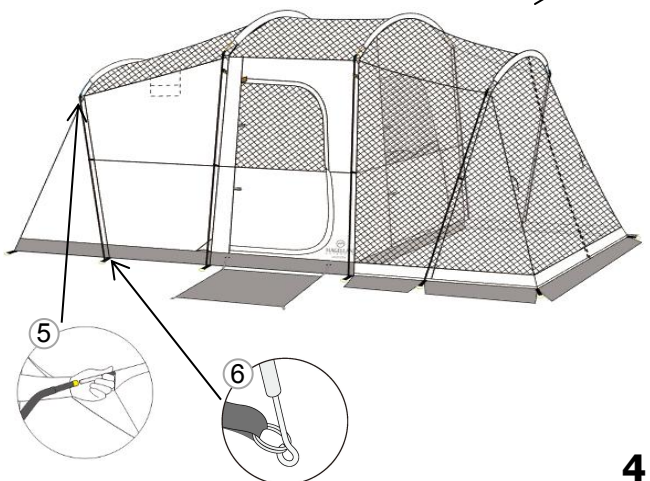

Assembly Instructions

Step 3:

7. Attach all G hooks to the leg poles to secure and shape the tent.

8. Attach the included mud mat (H) to tent with the toggles.

9. Making sure the base of the tent is fully spread out, pull the floor tight and stake out the rest of the tent.

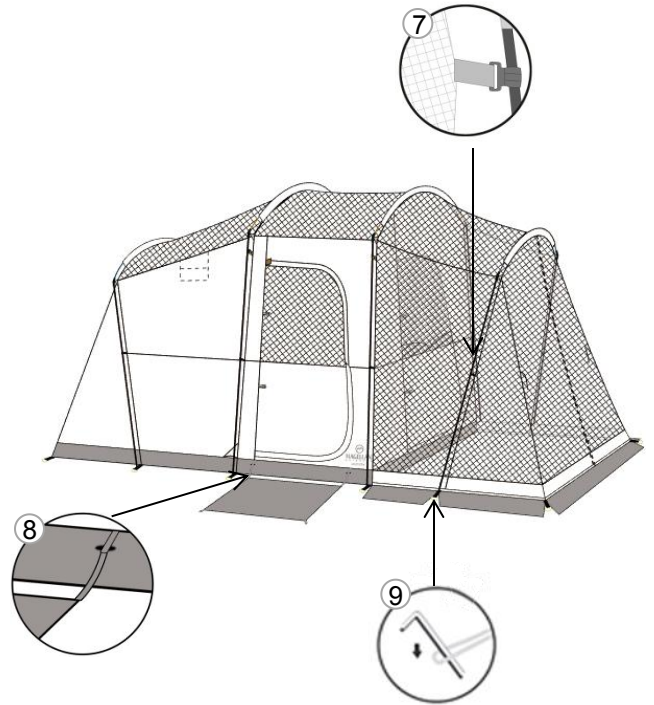

Step 4:

10. Lay out rain fly, place the rain fly over the top of tent body.

11. Push the awning pole through the sleeve of rain fly on top of the side door.

12. Insert the ends of awning pole into the grommets sewn onto the webbing of tent.

13. Attach S hooks on rain fly to the tent.

14. Stake out guy lines (F) away from the tent with lines at roughly a 45° angle to the ground. Adjust using the plastic sliders.

**INCLUDED TABLET

ENTERTAINMENT POCKET

15. The tablet entertainment pocket (I) can be hung on the interior of the tent by fabric loops across the back or side of the tent. Place the adjustable toggles through the fabric loops and adjust the length of the line as needed to fit the space.

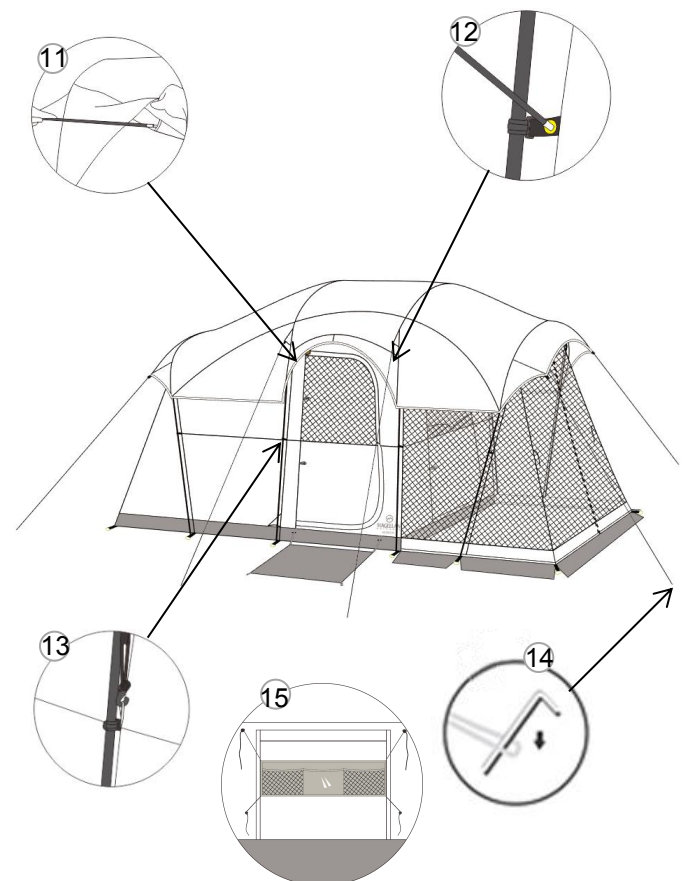

IMPORTANT NOTES BEFORE YOU BEGIN:

- Assemble your tent before camping to become familiar with the assembly.
- Setup is possible for one person, however two people are recommended.
- Select a clean, level area for the campsite free of debris and sharp objects, and away from a natural watercourse.
- Use of a ground cloth is recommended to prolong the life of the tent floor and provide additional insulation and moisture protection.
- To prevent damage to the zippers, unzip the doors and windows of the tent prior to disassembly, allowing air to move freely.
- Seam sealing the inside stitched seams of the tent is recommended. This will improve weather resistance. Discoloration may occur if applied to outside seams. (Seam sealer not included).

Care and Maintenance

-Your product must be stored dry. One of the easiest ways to damage your product is storing it while it is wet. Storing a wet tent as briefly as 24 hours in warm weather is likely to cause mildew on the fabric coatings.

-If you must close camp in the rain, open your product and set it up to allow it to dry as soon as possible. Allow dirt to dry on the fabric after a rainfall before lightly sweeping it off with a brush. For tougher stains, spray the area with water and lightly wipe it off with a few strokes. Do not use washer or dryer. **DO NOT SCRUB THE FABRIC. ALWAYS MAKE SURE TENT IS COMPLETELY DRY BEFORE REPACKING.**

-Do not leave your tent set up for weeks at a time. Exposure to ultraviolet rays from the sun can damage and/or discolor the material.

-Clean the poles with a cloth and lubricate them with a silicone spray to help prevent corrosion and keep from becoming gritty. This is especially important after using the tent around salt water.

-Store the stakes in a separate storage bag. Do not pack the stakes inside the tent.