

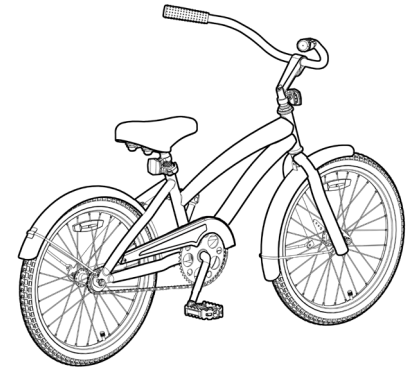

CRUISER BIKE

OWNER'S MANUAL

THIS MANUAL CONTAINS IMPORTANT SAFETY, PERFORMANCE AND MAINTENANCE INFORMATION. READ THE MANUAL BEFORE TAKING YOUR FIRST RIDE ON YOUR NEW BICYCLE, AND KEEP THE MANUAL HANDY OF FUTURE REFERENCE.

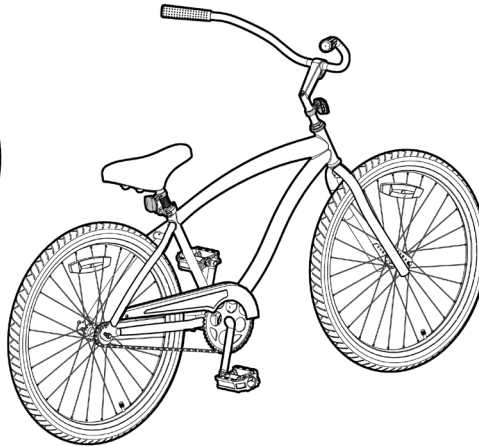
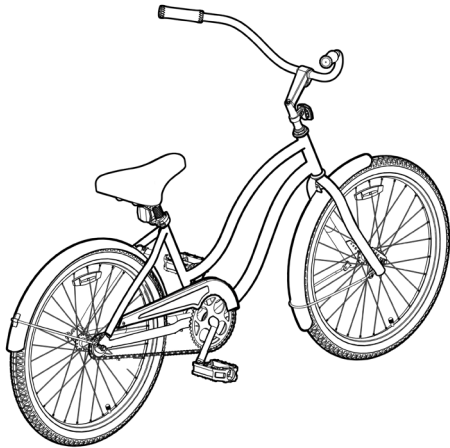

DO NOT return this item to the store.
Questions or comments?
1-800-551-0032

NOTE: Illustrations in this Manual are for reference purposes only and may not reflect the exact appearance of the actual product. Specifications are subject to change without notice.

HELMET USE & GENERAL MANUAL DISCLAIMER

NOTE: The illustrations in this manual are used simply to provide examples; the components of your bicycle might differ. In addition, some of the parts shown might be optional and not part your bicycle's standard equipment.

The following manual is only a guide to assist you and is not a complete or comprehensive manual of all aspects of maintaining and repairing your bicycle. If you are not comfortable, or lack the skills or tools to assemble the bicycle yourself, you should take it to a qualified mechanic at a bicycle shop. Additionally, you can write or call us concerning missing parts or assembly questions.

⚠ WARNING/IMPORTANT: Take notice of this symbol throughout this manual and pay particular attention to the instructions blocked off and preceded by this symbol.



Dynacraft **1-800-551-0032**

89 South Kelly Road, American Canyon, CA 94503

www.dynacraftbike.com

HELMETS SAVE LIVES!

⚠ WARNING: Always wear a properly fitted helmet when you ride your bicycle. Do not ride at night. Avoid riding in wet conditions.



Correct fitting
Make sure your helmet covers your forehead.

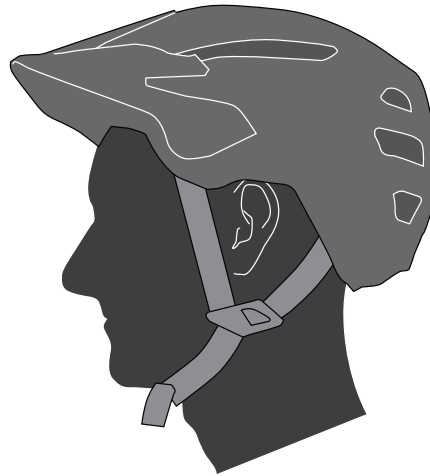

Incorrect fitting
Forehead is exposed and vulnerable to serious injury.

ABOUT THIS MANUAL

This manual was written to help you get the most performance, comfort, enjoyment and safety when riding your new bicycle. It is important for you to understand your new bike. By reading this manual before you go out on your first ride, you'll know how to get the most from your new bicycle. It is also important that your first ride on your new bicycle is taken in a controlled environment, away from cars, obstacles, and other cyclists.

GENERAL WARNING

Bicycle riding can be a hazardous activity even under the best of circumstances. Proper maintenance of your bicycle is your responsibility as it helps reduce the risk of injury. This manual contains many "WARNINGS" and "CAUTIONS" concerning the consequences of failure to maintain or inspect your bicycle. Many of the warnings and cautions say, "you may lose control and fall." Because any fall can result in serious injury or even death, we do not repeat the warning of possible injury or death whenever the risk of falling is mentioned. Dynacraft does not encourage stunting, trick riding, ramp riding, jumping, aggressive riding, riding on severe terrain, riding in severe climates, riding with heavy loads, riding double, commercial activities; such use is inherently dangerous, can cause serious injury to the rider, and if done it is with the rider's express and implied assumption of the risk of such use and Dynacraft shall not have any responsibility for any breakdown of the bicycle, its components or rider injuries that occur during such use.

NOTE TO PARENTS

It is a tragic fact that most bicycle accidents involve children. As a parent or guardian, you bear the responsibility for the activities and safety of your minor child. Among these responsibilities are to make sure that the bicycle that your child is riding is properly fitted to the child; that it is in good repair and safe operating condition; that the play of young children is supervised by an adult; that you and your child have learned, understand and obey not only the applicable local motor vehicle, bicycle and traffic laws, but also the common sense rules of safe and responsible bicycling. As a parent, you should read this manual before letting your child ride the bicycle. Please make sure that your child always wears an approved bicycle helmet when riding.

CONTENTS

| | |
|--|-----------|
| A ABOUT YOUR BIKE | 7 |
| Model/Serial Number Identification | 7 |
| Customer Service | 7 |
| Space to Record Product Information | 7 |
| B BEFORE YOU RIDE | 8 |
| Parts List | 9 |
| Tool List | 9 |
| Frame Sizing | 10 |
| Rules of the Road/Safety Tips | 11 |
| Night Riding | 13 |
| Safety Checklist. | 14 |
| C BICYCLE ASSEMBLY | 16 |
| Getting Started | 16 |
| 1. Pedals. | 17 |
| 2. Seat | 18 |
| 3. Testing Seat Clamp and Post Clamp Tightness | 19 |
| 4. Handlebar/Stem | 20 |
| 5. Testing Handlebar and Stem Tightness | 22 |
| 6. Fender. | 23 |
| 7. Front Wheel. | 24 |
| 8. Brakes | 25 |
| 9. Tire inflation | 26 |
| 10. Reflectors | 27 |
| 11 Accessories. | 28 |

| | |
|---|-----------|
| D BICYCLE ADJUSTMENTS | 31 |
| Seat Adjustment | 31 |
| Stem Adjustment | 32 |
| E MAINTENANCE AND INSPECTION | 33 |
| Tire Removal/Seating. | 34 |
| Lubrication | 35 |
| Bearing Inspection. | 36 |
| F LIMITED WARRANTY | 37 |

ABOUT YOUR BIKE

MODEL/SERIAL NUMBER IDENTIFICATION

Each Dynacraft bicycle has a serial number stamped into the frame. The serial number can be found on the bottom of the crank housing as shown (see diagram below). The model number and production date are found on a sticker on the frame at the bottom of the seat tube. When contacting Dynacraft, please have these two numbers ready.

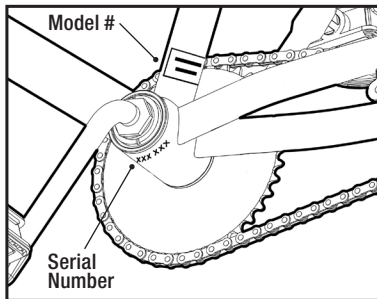

CUSTOMER SERVICE

DYNACRAFT CUSTOMER SERVICE
 1.800.551.0032
 7 AM to 4 PM PACIFIC TIME
 Dynacraft BSC, Inc.

Please retain your sales receipt as proof of purchase. Fill out the information below and keep this manual in a safe place.

Brand/Description _____

Model # _____

Production Date _____

Serial # _____

Date of Purchase _____

Store/Place of Purchase _____

B BEFORE YOU RIDE

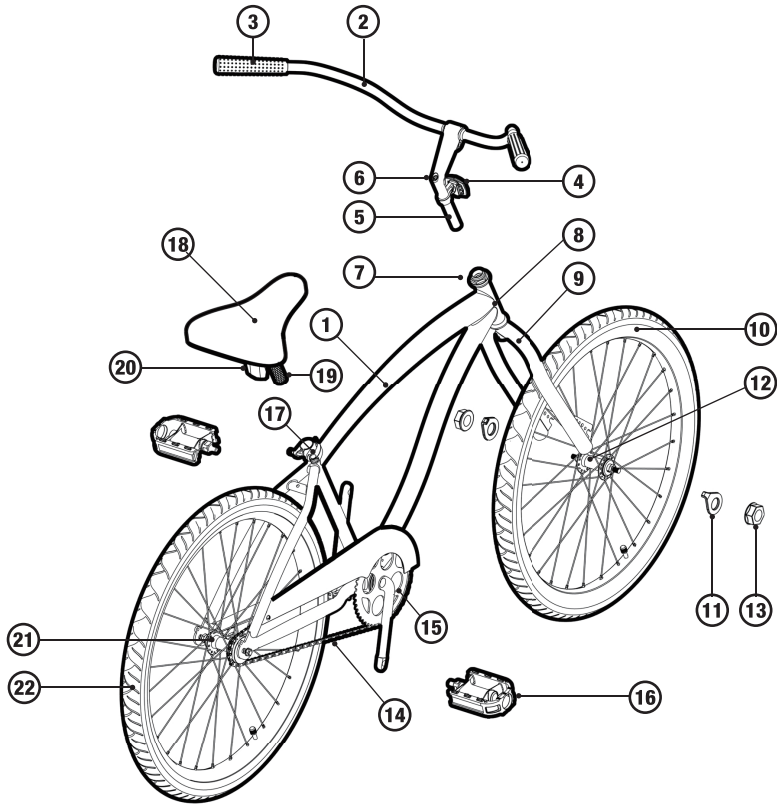

PARTS/TOOLS LISTS

- | | |
|---------------------------|---------------------|
| 1. Frame | 12. Front Wheel |
| 2. Handlebar | 13. Locknut (x4) |
| 3. Grip (L and R) | 14. Chain |
| 4. Front Reflector | 15. Crankset |
| 5. Stem | 16. Pedal (L and R) |
| 6. Stem Bolt | 17. Seat Clamp |
| 7. Headset | 18. Saddle |
| 8. Head Tube | 19. Seat Post |
| 9. Fork | 20. Rear Reflector |
| 10. Tube (x2) | 21. Rear Wheel |
| 11. Retaining Washer (x2) | 22. Tire (x2) |

Tools Required

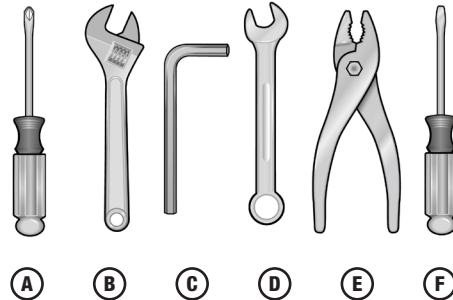

- A. Standard Phillips Head Screwdriver
- B. Adjustable Wrench
- C. 4,5,6,8mm Allen Wrenches
- D. Pedal wrench or 15mm Open End Wrench
- E. Standard Slip Joint Pliers
- F. Standard Flat Head Screwdriver

B

FRAME SIZING

When selecting a new bicycle, the correct choice of frame size is a very important safety consideration. To determine the correct size bicycle for the rider:

- Straddle the assembled bicycle with feet shoulder width apart and flat on the ground
- There must be at least one inch (2.5cm) of clearance between the highest part of the top tube of the bicycle and the crotch of the rider with the tires properly inflated.
- The standover height for each bike is listed in the information center on the product page of every bike on www.dynacraftbike.com
- To measure the inseam, use measuring tape to measure from the ground (with shoes on) to the inseam of your pants.
- Subtract the standover height from the inseam measurement to ensure that you have the recommended amount of clearance. If you have less than one inch or more than three inches (2.5 to 7.5 cm), you may need to move up or down a frame size.
- For more detailed instructions on how to properly adjust your bike to fit you, visit our website at www.dynacraftbike.com, find your bike, and locate the fit video in the Information Center. (Disclaimer: Fit video not available for all products.)

WEIGHT LIMIT

The maximum structural weight recommendations for our bicycles that are 20 inches or larger are:

- 20 inch bicycles: 176 lbs. (80 kg)
- Adult bicycles up to 26 inches: 275 lbs. (125 kg)

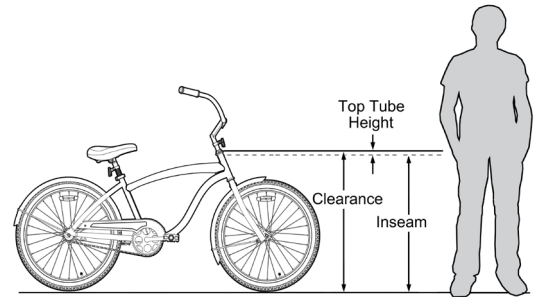

⚠ CAUTION: For safe and comfortable riding there should be a clearance of no less than 1 inch between the inseam area of the intended rider and the top tube of the bicycle frame, while the rider straddles the bicycle with both feet flat on the ground.

⚠ WARNING: If the bicycle is too large the rider cannot reach the pedals easily, or the ground when stopping which may result in loss of control and/or injury.

RULES OF THE ROAD/SAFETY TIPS

NOTE: Like any sport, bicycling involves risk of injury and damage. By choosing to ride a bicycle, you assume the responsibility for that risk; not the people who sold you the bike; nor the people who made it; nor the people who distribute it; nor the people who manage or maintain the roads and trails you ride on. **YOU.** So you need to know – and to practice – the rules of safe and responsible riding.

- 1. IN THE INTEREST OF SAFER CYCLING, MAKE SURE YOU READ AND UNDERSTAND YOUR OWNER’S MANUAL. NOTE AND PERFORM PRE-RIDE SAFETY CHECKS.**
- 2. NOTICE:** Some state and local laws may require that your bicycle be equipped with a warning device such as a horn or bell, and a front and rear light if the bicycle is to be ridden after dark.
- 3. ALWAYS WEAR SHOES** when riding a bicycle and **AVOID LOOSE FITTING CLOTHES.**
- 4. CHECK YOUR BRAKES FREQUENTLY. THE ABILITY TO STOP YOUR BICYCLE IS CRITICAL.** Roads are slippery when wet so avoid sharp turns and allow more distance stopping. Caliper brakes may become less efficient when wet. Leaves, loose gravel, and other debris can also affect stopping.
- 5. ALWAYS RIDE IN THE SAME DIRECTION AS TRAFFIC.** Never ride against traffic.
- 6. STOP AND LOOK BEFORE YOU LEAVE AN ALLEY, DRIVEWAY, OR PARKING LOT.** Stop, look to the left, to the right, and to the left again for traffic. Ride only when it is clear.
- 7. KEEP TO THE RIGHT.** Follow the traffic flow in a straight line and stay close to the curb or in the bike lane, when available. Watch for cars moving in and out of traffic.
- 8. OBEY ALL TRAFFIC LAWS.** Most traffic laws apply to bike riders as well as automobile operators.
- 9. ONE RIDER PER BIKE. NEVER CARRY OTHER RIDERS.** This is dangerous and makes the bike harder to control. The bicycles distributed by Dynacraft BSC, Inc. are intended for one rider only.

- 10. ALWAYS BE ALERT. BE ALERT** – pedestrians have the right of way. **BE ALERT** – when riding near parked cars - ride far enough away from the cars so that you won't get hit if someone opens the car door.
- 11. USE CAUTION AT ALL INTERSECTIONS AND STOP SIGNS. STOP AND LOOK BOTH WAYS BEFORE PROCEEDING.**
- 12. USE HAND SIGNALS.** Communicate by using hand signals to tell other drivers what you are going to do. Signal 100 feet before turning unless your hand is needed to control the bike.
- 13. PROPER LIGHTS ARE RECOMMENDED IF YOU RIDE AT NIGHT.** Be sure to have a strong head-light, a tail light, and a full set of reflectors. **CHECK THAT REFLECTORS ARE CLEAN, STRAIGHT, UNBROKEN, AND SECURELY MOUNTED.**
- 14. NEVER CARRY PACKAGES OR OBJECTS WHICH OBSTRUCT VISION.**
- 15. NEVER HITCH RIDES,** never hold onto a moving vehicle while riding.
- 16. THE KICKSTAND IS DESIGNED TO SUPPORT THE BICYCLE ONLY,** not the bicycle and the rider.
- 17. AVOID THE FOLLOWING HAZARDS:** Drain grates, potholes, soft road edges, gravel, sand, wet leaves, and/or any obstruction in the road. Failure to do so could cause wheel(s) to buckle and result in personal injury to the rider.
- 18. WET WEATHER RIDING** - Riding your bicycle in wet conditions is not recommended. In wet conditions traction and braking power is reduced. Riding in such conditions could result in personal injury.
- 19. PROPER HELMET USE.** A helmet that meets the CPSC (Consumer Product Safety Commission) standard should always be worn when riding a bicycle. The helmet should fit properly and be worn on the crown of the head, not tipped back. Replace your helmet at least every three years to ensure the structural integrity of the foam. Replace after impact, regardless of lack of visible damage to helmet.
- 20. USE BIKE LANES** when available. Also note that in certain states, cars may use bike lanes when turning.
- 21. RESPECT** "Bicycles Are Prohibited" **SIGNS.**

NIGHT RIDING

Riding a bicycle at night is much more dangerous than riding during the day. A bicyclist is very difficult for motorists and pedestrians to see. Therefore, children should never ride at dawn, dusk or at night. Adults who choose to accept the greatly increased risk of riding at dawn, dusk or at night need to take extra care both riding and choosing specialized equipment which helps reduce that risk. Consult your dealer about night riding safety equipment.

⚠ WARNING: Reflectors are not a substitute for required lights. Riding at dawn, at dusk, at night or at other times of poor visibility without an adequate bicycle lighting system and without reflectors is dangerous and may result in serious injury or death.

⚠ WARNING: Do not remove the front or rear reflectors or reflector brackets from your bicycle. They are an integral part of the bicycle's safety system. Removing the reflectors reduces your visibility to others using the roadway. Being struck by other vehicles may result in serious injury or death.

RULES FOR CHILDREN

To avoid an accident, teach children good riding skills with an emphasis on safety from an early age.

1. Always wear a properly fitted helmet.
2. Do not play in driveways or the road.
3. Do not ride on busy streets.
4. Do not ride at night.
5. Obey all traffic laws, especially stop signs and red lights.
6. Be aware of other road vehicles behind and nearby.
7. Before entering a street: Stop, look left, right, and left again for traffic.
8. If riding downhill, be extra careful. Slow down using the brakes and maintain control of steering.
9. Never take your hands off the handlebars, or your feet off the pedals when riding downhill.

⚠ CAUTION: The Consumer Product Safety Commission advises that the riding of small wheel diameter bicycles at excessive speeds can lead to instability and is not recommended.

SAFETY CHECKLIST

Before every ride, it is important to carry out the following safety checks (for information and instructions on performing specific equipment checks, locate the relevant section in the manual referenced on pages 5–6):

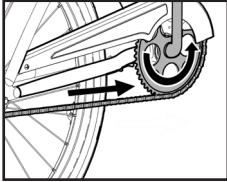

1. BRAKES

- To ensure that the coaster brakes function properly, raise the rear wheel off the ground and spin the wheel forward by hand, and move the pedal backwards.
- If the rear wheel does not come to a full and complete stop when holding the pedal and pedaling backwards, take your bike to a bike mechanic.

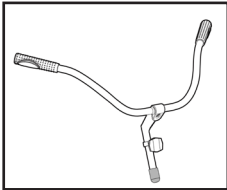

2. STEERING

- Ensure handlebar and stem are correctly adjusted and tightened, and allow proper steering.
- Ensure that the handlebars are set correctly in relation to the forks and the direction of travel.

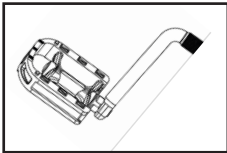

3. CRANKS AND PEDALS

- Ensure pedals are securely tightened to the cranks.
- Ensure cranks are securely tightened to the bottom bracket and are not bent.

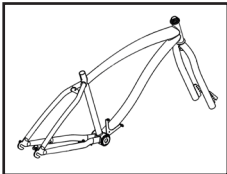

4. FRAME AND FORK

- Check that the frame and fork are not bent, broken, or cracked.
- If either are found to be bent, broken, or cracked, they should be replaced.

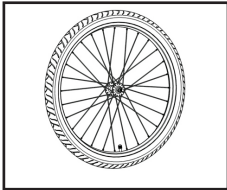
**5. WHEELS AND TIRES**

- Ensure tires are inflated to within the recommended range as displayed on the tire sidewall.
- Ensure tires have tread and have no bulges or excessive wear.
- Ensure rims run true and have no obvious wobbles or kinks.
- Ensure all wheel spokes are tight and not broken.
- Check that axle nuts are tight.
- Do not over inflate.

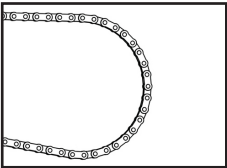
**6. CHAIN**

- Ensure chain is oiled, clean and runs smoothly.
- Extra care is required in wet or dusty conditions.
- On bicycles equipped with coaster brakes, check for proper chain tension.
- Check to make sure your chain guard is tight and not touching the crank or chain.

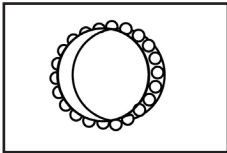
**7. BEARINGS**

- Ensure all bearings are lubricated, run freely and display no excess movement, grinding or rattling.
- Check headset, wheel bearings, pedal bearings and bottom bracket bearings.

GETTING STARTED

Open the box and check that all parts are present. You can check against the list on page 9. If any parts are missing or damaged, or if you have any trouble with the assembly, don't return the item to the store. Call Dynacraft directly at **1-800-551-0032** or visit our website at www.dynacraftbike.com, find your bike, and locate the assembly video in the Information Center. (Disclaimer: Assembly video not available for all products).

We strongly recommend reading the manual before beginning. If you aren't comfortable with the assembly, you should bring your new ride to your local bike shop to have a qualified mechanic put it together for you. In any event, you need to read this entire Owner's Manual before you ride or let anyone else ride it.

⚠ CAUTION: As you assemble the bike, it's a good idea to place a little white grease or anti-seize compound on the seatpost, stem and threads of the bolts to prevent rusting.

You'll see that the frame, handlebars, front wheel, and other components are attached with zip ties. Lift everything out in one piece, and set it down, with the chain facing upwards. Cut the zip ties, and remove any padding or packaging.

First, align the fork. Rotate it, to ensure it moves freely without binding (see Figure 1), making sure the fork is pointing in the right direction, with the fork blades facing forward (see Figure 2).

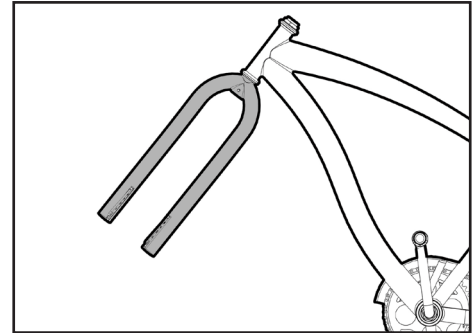

Figure 1

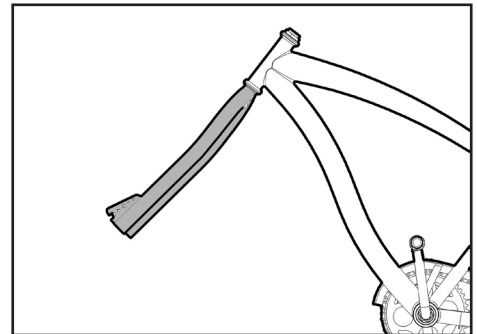

Figure 2

1. PEDALS

⚠ WARNING: Attachment of an incorrect pedal into a crank arm will cause irreparable damage. Unless the shoulder of the pedal spindle is tight to the face of the crank arm, the pedal may back out causing serious injury or death. Make it tight so the shoulder is in complete contact with the surface of the crank arm.

Before your first ride, please check to ensure your pedals are attached correctly.

- There is a right side pedal marked “R” and a left side pedal marked “L”
- The right pedal has a RED sticker, the Left pedal has a GREEN sticker.
- Pedal marked “R” has right hand threads. Tighten in a clockwise direction.
- Pedal marked “L” has left hand threads. Tighten in a counterclockwise direction (see Figure 3).

After putting some white grease on the threads of the pedal, place the pedal into the crank, and use your fingers to get it started. Threading it in can be tricky, so make sure to do it correctly. Regardless of which side you’re working on, the top of the thread will rotate towards the front of the bike to tighten the pedals. Once you’ve finger tightened the pedals, use a 15mm open-ended wrench to snug them down. They are properly tightened when the pedal spindle, which is the axle that the pedal platform spins around, begins to bite into the metal on the crank.

If you have a three piece crank, check the crank bolts to make sure they are tightened (see Figure 4). Re-check the bolts after your first ride.

If you have a one piece crank, firmly grasp the crank arm on the left side of the bicycle and wiggle it gently. If there is any movement or play in the crank, use a 15 mm open-ended wrench to tighten the locknut. Repeat the process until there is no more play in the crank, being careful not to overtighten (see Figure 5).

⚠ WARNING: Never ride your bike if the cranks are loose. This could damage the crank arms beyond repair, and result in a loss of control, injury or death.

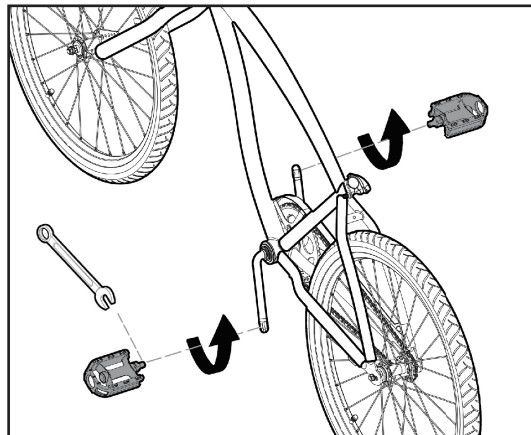

Figure 3

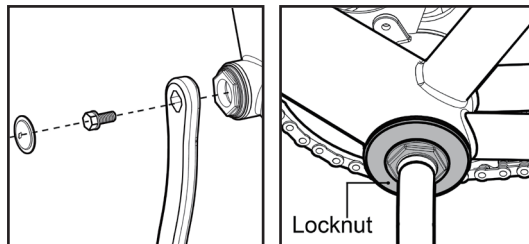

Figure 4

Figure 5

2. SEAT

⚠ WARNING: The seatpost must be inserted far enough so that the minimum insertion marks cannot be seen.

Add some white grease to the inside of the seat tube, and slide the seatpost into the bicycle. Make sure that the minimum insertion mark is completely covered and that the seat is pointing forward in alignment with the bicycle (see Figures 6 and 7).

⚠ CAUTION: Operate the quick release lever by hand only. Do not use a hammer or any other tool to tighten the quick release lever.

⚠ WARNING: If the quick release lever is not tightened properly, the seatpost can loosen while riding. This can cause a loss of control and injury to the rider or others.

To install the seat post reflector, first remove the seatpost and saddle from the bike. Use (A) Standard Phillips Head Screwdriver to loosen the screw on the clamp of the reflector until you can slide the reflector over the seat post. Once the reflector is on the seat post, reinsert the seat post back into the seat tube. Position the reflector so that it is perpendicular to the ground, move it up on the seat post until it can be seen above the tire when viewing the bike from the rear, and re-tighten screw (see Figure 8).

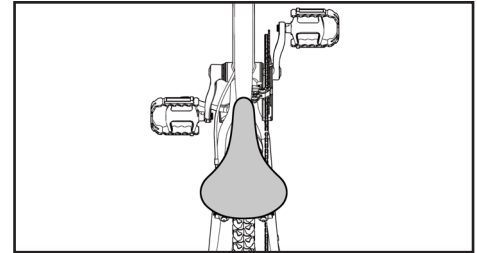

Figure 6

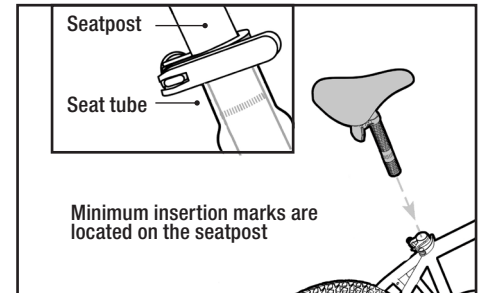

Figure 7

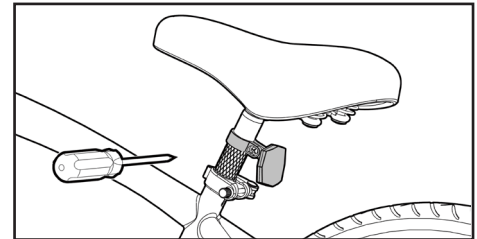

Figure 8

If your bike has a quick release lever (see Figure 9), tighten it by holding the lever in the “open” position and tightening the nut on the opposite side by hand. Slowly close the quick release lever, and you should notice resistance when the lever is half way shut. Firmly continue to push the lever until it is in the “closed” position, and the word “close” is showing. The seat should not be able to move back and forth, up and down, or side to side with the quick release lever in the closed position. Make sure the lever is also parallel with the seat clamp itself. You should only need one hand to close the quick release lever. If you need two hands, the seat clamp is too tight. Loosen the nut on the clamp until only one hand is needed to close the seat clamp.

If your bike has a standard seat clamp (see Figure 10), use (B) an Adjustable Wrench(es) to tighten the nut securely. If your bike has a bolt on seat clamp (see Figure 11), use (C) a 4, 5, or 6 mm Allen Wrench to tighten the bolt securely. The seat should not be able to move back and forth, up and down, or side to side with the seat clamp tightened.

3. TESTING SEAT CLAMP AND POST CLAMP TIGHTNESS

After installing the seatpost into the bicycle and tightening the clamp, test the tightness of the saddle. Hold the saddle firmly with both hands and try to move it side to side. The seatpost should not move at all. The seatpost and saddle also should not move when the rider is seated. Make sure the seat clamp nuts at the top of the seatpost are tight so that the seat does not tip forward or backwards (see Figures 12 & 13).

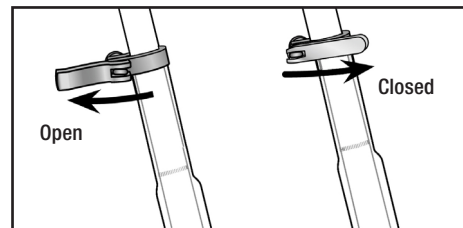

Figure 9

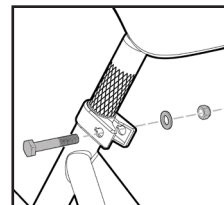

Figure 10

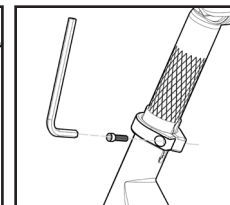

Figure 11

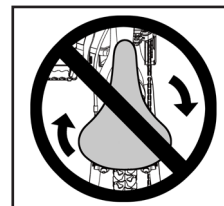

Figure 12



Figure 13

4. HANDLEBAR/STEM

⚠ WARNING: To prevent steering system damage and possible loss of control, the stem must be inserted enough so that the minimum insertion marks are completely covered (see Figure 14).

Add some white grease to the inside of the fork steerer tube. Before installing the stem, ensure that you have all the parts present and installed in the correct order (see Figure 17). For a threaded or quill stem, remove the plastic shipping cap from the bottom of the stem (see Figure 15).

Insert the stem and handlebar assembly into the fork, making sure the stem wedge is loose (see Figure 16).

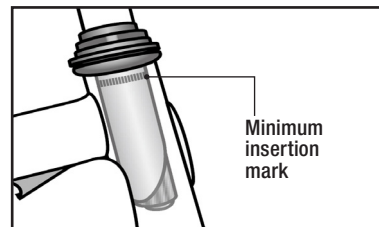

Figure 14

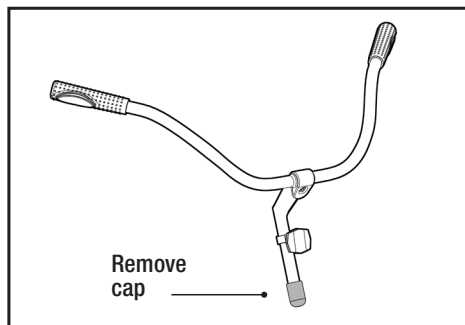

Figure 15

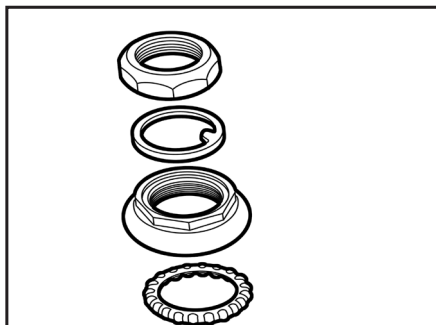

Figure 16

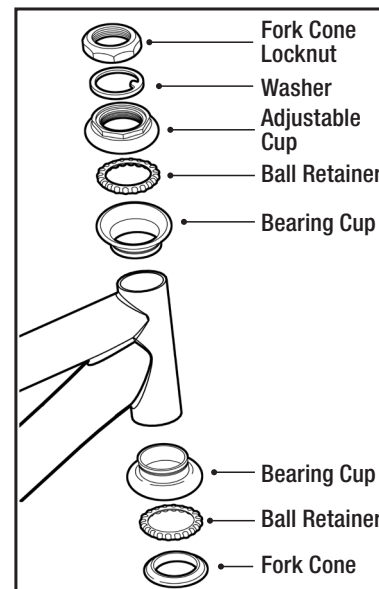

Figure 17

The stem should be pointing towards the front of the bike. Tighten the stem bolt with an adjustable wrench or Allen wrench depending on which style comes on your bike (see Figure 18). Make sure the stem is aligned with the front tire of the bike.

⚠ WARNING: Do not over tighten the stem bolt. Over tightening the stem bolt can damage the steering system and cause a loss of control. If necessary re-adjust the handlebar and tighten the handlebar clamp nut (see Figure 19).

⚠ WARNING: If the handlebar clamp is not tight enough, the handlebar can slip in the stem. This can cause damage to the handlebar or stem, and can cause loss of control and serious injury or even death (see Figure 20).

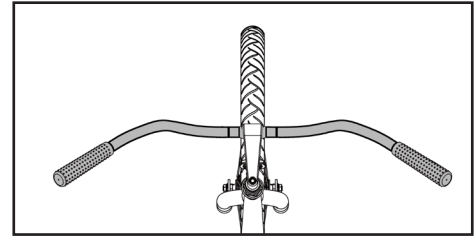

Figure 18

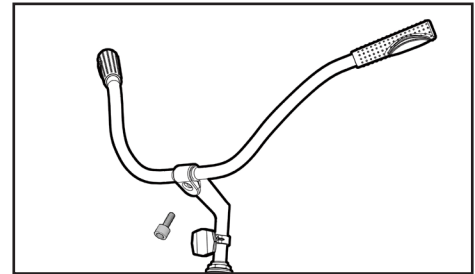

Figure 19

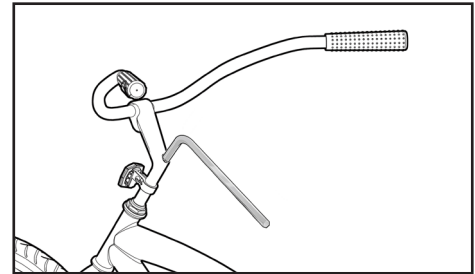

Figure 20

The handlebar may not already be installed on your bike from the factory. In that case you may need to install the handlebars onto the stem itself. To do so, simply remove the grips from one end of the handlebars by firmly gripping and twisting them off bit by bit. After this is done, loosen the stem clamp by unscrewing the stem clamp bolt with (C) an Allen Wrench. Slide the grip free end of the handlebars through the stem clamp until it is centered, aligning the markings on the handlebar with the stem clamp (see Figure 21).

After the handlebar is securely and properly installed, reinstall the grip that was removed earlier. Tip: Hairspray applied to the inside of the grip will ease the difficulty of the installation and ensure the grip remains tightly on the bar.

5. TESTING HANDLEBAR AND STEM TIGHTNESS

To test the tightness of the stem, straddle the front wheel between your legs tightly and try to turn the handlebar back and forth. The handlebar should not slip or move independently of the front wheel at all. If the handlebar does move, re-align the stem with the front wheel and tighten the stem bolt. Re-test to make sure the stem is secure with the same process.

To test the tightness of the handlebar, hold the bike stationary and try to rotate the ends of the handlebar up and down or move the bar forward and back (see Figure 22). If the handlebar moves, loosen the handlebar clamp nut or bolts evenly to re-position and then re-tighten. Repeat the test until the bars will not move.

⚠ WARNING: To prevent steering system damage and possible loss of control, the stem and handlebars must be properly adjusted and tightened. DO NOT OVERTIGHTEN.

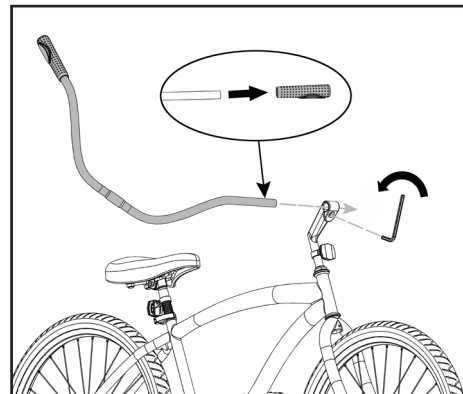

Figure 21

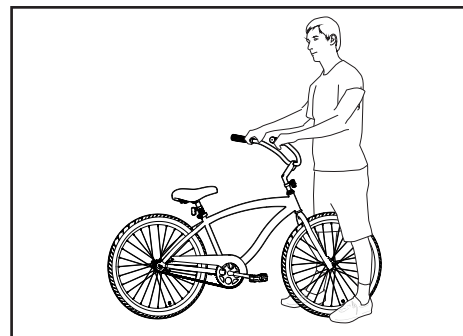

Figure 22

6. FENDER

NOTE: The fender must be installed before the front wheel.

To install the fender, first remove the fender installation hardware from the fender itself. This should include two washers, one locknut, one long bolt to attach the fender to the top of the fork, and two shorter bolts to attach the fender arms to the drop outs.

Then, line up the fender fork mounting tabs with the hole at the top of the fork dropouts. Install the fender hardware as shown in Figure 18, threading a washer onto the long bolt, threading the bolt through the fender fork mounting tabs and the fork, threading another washer onto the long bolt, and tightening it all down with a locknut and (E) a pair of standard slip joint pliers.

Finally, align the eyelets of the fender arms with the fender arm tabs on the bottom of the dropouts. Thread the short bolts through the eyelets, into the fork, to secure the fender arms.

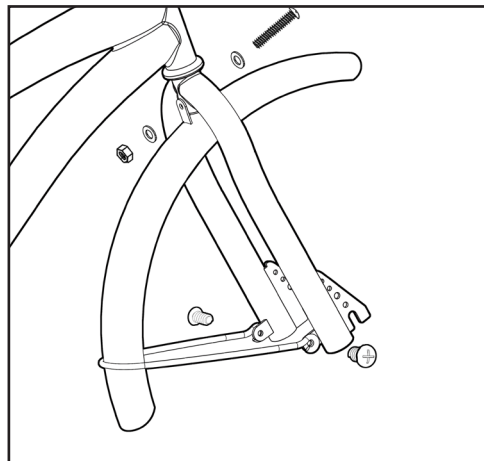

Figure 23

7. FRONT WHEEL

⚠ WARNING: It is very important to check the front wheel connection to the bicycle. Failure to properly tighten may cause the front wheel to dislodge, causing serious injury or death.

Check the side of your tire to see if there is an arrow indicating direction. If an arrow is present, it should point forward. If there is no arrow, the wheel can be installed in either direction.

Loosen or remove the axle nuts and washers from the front wheel. Place the front wheel into the fork, making sure it is completely seated and even. Insert the wheel in the dropouts, place the locking washer on the axle, line up the tab on the retainer clip with the corresponding hole in the drop out. Place the locknut on the axle after the retainer clip and tighten the lock nut with (B) Adjustable Wrench (see Figures 24 & 25).

⚠ WARNING: Put the wheel in the center of the fork and tighten both nuts.

⚠ WARNING: Failure to obey these steps can allow the front wheel to loosen or dislodge while riding. This can cause injury or death to the rider or to others.

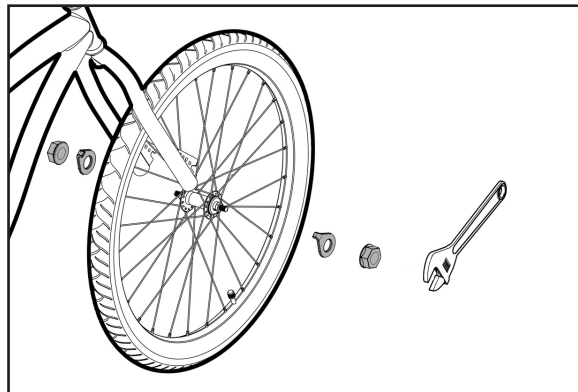

Figure 24

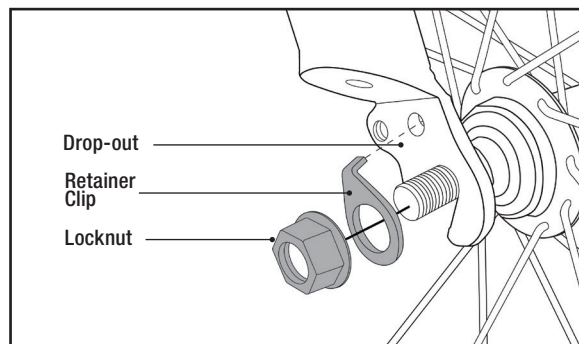

Figure 25

8. BRAKES

Coaster Brakes

If your bike is equipped with a coaster brake, it should come pre-assembled on the bike. You should make sure that the coaster brake arm is secure to the frame by checking the brake arm clamp screw or bolt (see Figure 26).

⚠ WARNING: The chain must remain on the sprockets.
If the chain comes off the sprockets, the coaster brake will not operate.
(See page 34 for chain tension adjustment instructions.)

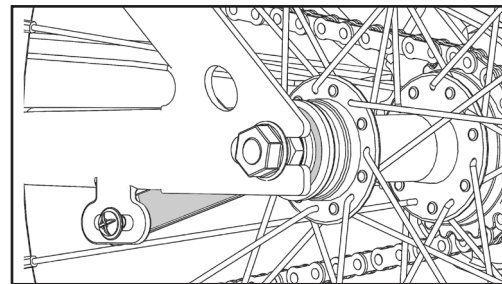

Figure 26

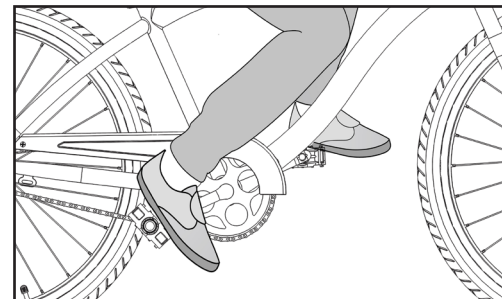

Figure 27

9. TIRE INFLATION

⚠ WARNING: Tires must be properly inflated before riding. Never exceed the maximum pressure (PSI) that is listed on the side of the tire.

⚠ WARNING: Be sure to check that the edge (bead) of both tires are evenly seated the entire way around on both sides of the tire. Failure to do so may result in the tire coming off of the rim, the tube popping (see Figure 29), and a loss of control of the bicycle, causing injury or even death.

⚠ WARNING: Using a service station air hose without a pressure gauge may result in over-inflating of the tire and popping of the tube. This could also cause irreparable damage to the tube and tire.

Use a hand pump, foot pump, or floor pump to properly inflate the tires (see Figure 30). The maximum inflation (PSI) is shown on each tire sidewall (see Figure 28). If your pump does not have a built in gauge, use a separate pressure gauge to ensure the tires are inflated to the correct pressure (see Figure 31).

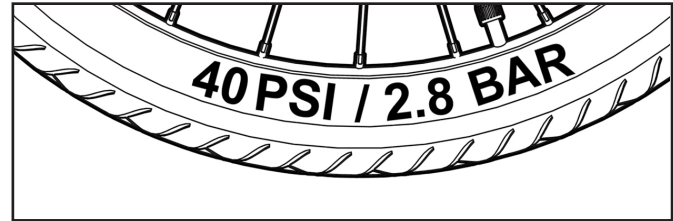

Figure 28

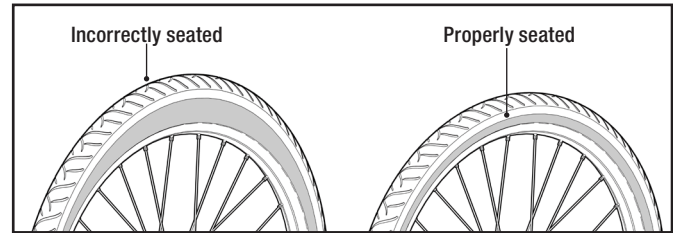

Figure 29

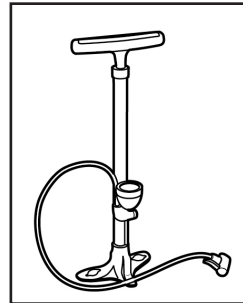

Figure 30

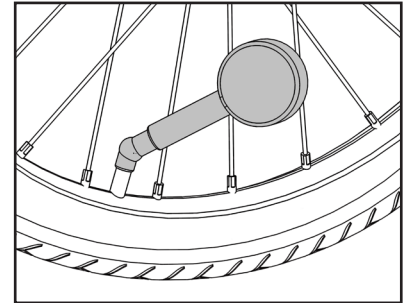

Figure 31

10. REFLECTORS

Reflectors are pre-installed on your bicycle on the pedals, wheels, seatpost, and handlebars. Ensure that the handlebar reflector is pointing straight forward and perpendicular to ground, and position the rear reflector so that it points straight backwards. Use (A) Phillips head screwdriver to loosen and adjust before re-tightening.

NOTE: Now that the initial assembly is complete, the bike needs to be adjusted before it is ready to ride. Follow the steps in the following **Bicycle Adjustments** section to adjust the bike.

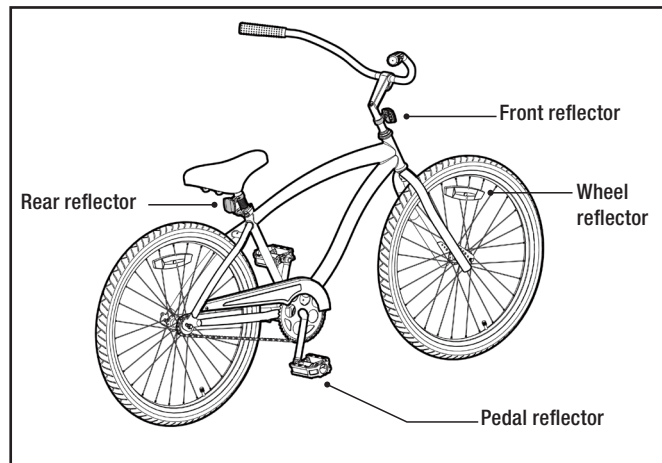

Figure 32

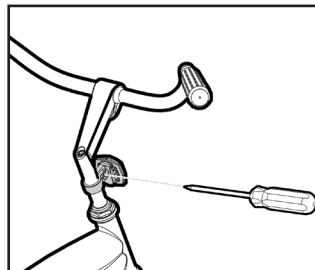

Figure 33

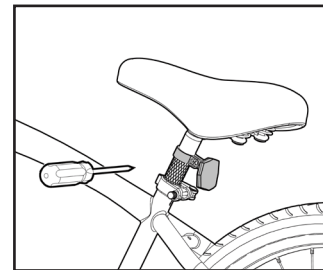

Figure 34

11. ACCESSORIES

Your bike may come with some or all of these accessories that require attachment and/or assembly.

Kick Stands

If the kickstand is not mounted to your bicycle, place the bicycle in an upright position against a wall or have someone hold it upright. Place the kickstand in the bracket mounted on the frame and use a pair of (E) Standard Slip Joint Pliers to secure the fixing bolt to keep the kickstand in place. Be sure to tighten the fixing bolt securely. Some kickstands use a top plate to locate the bolt and secure the kickstand using a fixing bolt. Be sure to tighten the axle nut. The guard will sit between the frame and the axle nut (see Figure 35).

⚠ WARNING: The kickstand is designed to support the **BICYCLE ONLY**; not the bicycle and the rider.

Other Accessories

For all other accessories, either follow the instructions on the packaging in order to install, or bring your bike to a qualified bicycle shop in order to have the part safely installed.

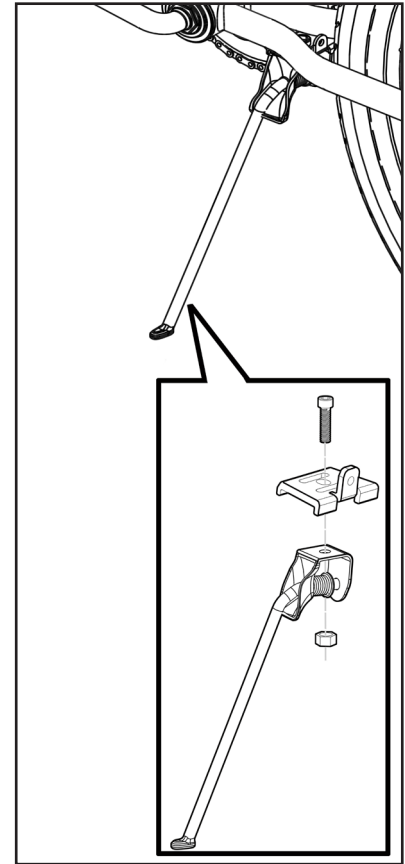

Figure 35

Bell Installation

To install the bell on your bike, use the (A) Standard Phillips Head Screwdriver to remove the two screws from the mount, along with the bottom half of the bell mount. Place the top half of the bell mount within easy reach of your thumb on the handlebars, place the bottom half of the bell mount in place around the handlebars, and reinsert and tighten the screws (see Figure 36).

Cup Holder Installation

To install the cup holder onto your handlebars, loosen and remove the screw on the cup holder mount using the (A) Standard Phillips Head Screwdriver. Gently pull the mount open until it can slide over the grip onto the handlebars, then reinsert and retighten the screw. Line up the holes on the cup holder with the holes on cup holder mount, and then use the appropriate (C) Allen Wrench to insert and tighten the bolts to secure the cup holder to the mount (see Figure 37).

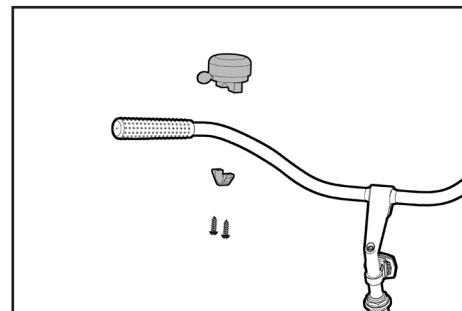

Figure 36

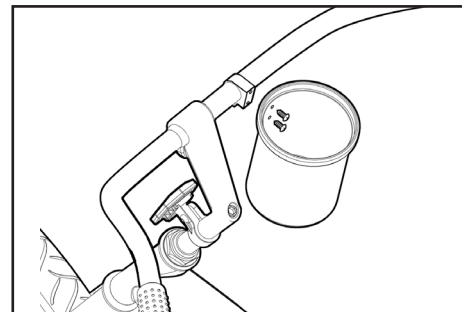

Figure 37

Basket Installation

To install the basket onto the front of your bicycle, first you must remove the stem and handlebars from your bicycle. Use the appropriate (C) Allen Wrench to loosen the stem bolt on the stem, being careful not to unscrew the stem wedge completely from the stem bolt. Once it is loose enough, remove the stem and handlebars by pulling the stem up and out of the headset. Then, use the (E) Standard Slip Joint Pliers to loosen the topmost nut from the headset. Place the stem basket mount around the steer tube, then replace the topmost headset knut, and tighten it with the (E) Standard Slip Joint Pliers. Reinsert the stem and handlebars, line them up correctly with the tire, and retighten the stem bolt. Now, line up the slots on the basket with the slots on the basket mount, insert the basket mount bolts, slide a washer and locknut onto the bolts, and tighten the nut and bolt using the (E) Standard Slip Joint Pliers and (C) Allen Wrench (see Figure 38).

Then, you must install the dropout basket mount. Line up the eyelets on the mount with the appropriate holes (see Figure 38), and insert and tighten the provided bolts to secure the mount to the drop outs. Place the mount bracket around the dropout basket mount, line it up with the holes in the bottom of the basket, and insert the provided bolts through the holes in the basket and the bracket, and fasten a locknut on the bolt on the underside of the basket (see Figure 39).

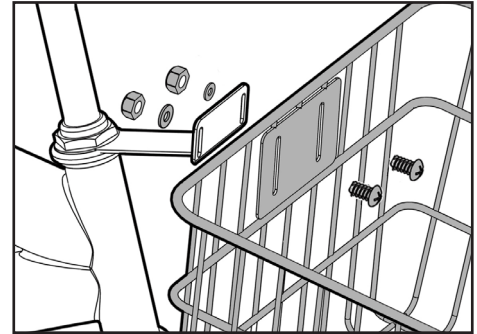

Figure 38

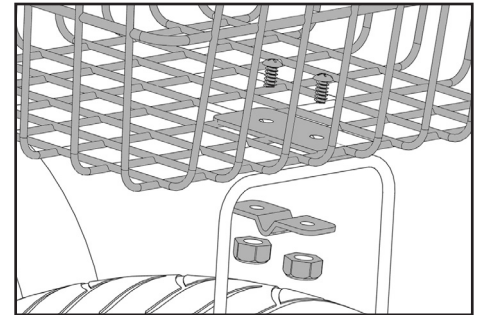

Figure 39

BICYCLE ADJUSTMENTS

SEAT ADJUSTMENT

You can adjust the up and down tilt of your seat as well as the forward and back position by loosening the seatpost hardware at the bottom of your seat (see Figure 40). Be careful not to loosen them all the way so that the nut comes off on either side. Loosen enough to make the adjustments, and re-tighten the nuts. To raise or lower your seat, use the quick release lever (see Figure 41), an adjustable or Allen wrench on the seat clamp (see Figure 41) – depending on the style of clamp your bike comes with. Make sure the minimum insertion marks on the seatpost are completely covered (see Figure 42). Close the quick release lever, or tighten the nut on your seat clamp until it is secure, and the seat will not move side-to-side or sink with the rider seated (see Figures 43 & 44). To ensure that your seat is adjusted to the proper height for you, adjust the saddle so that it's just below your hips. Retighten the seat post clamp and mount your bike. At the bottom of your pedal stroke, your knee should have a slight bend in it, with the ball of your foot centered over the pedal. The saddle should also always be parallel with the top tube. For more detailed instructions on how to properly adjust your bike to fit you, visit our website at www.dynacraftbike.com, find your bike, and locate the fit video in the Information Center. (Disclaimer: Fit video not available for all bikes)

⚠ WARNING The seatpost must be inserted far enough so that the minimum insertion marks cannot be seen.

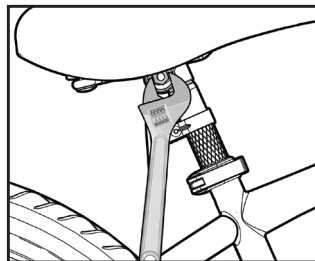

Figure 40

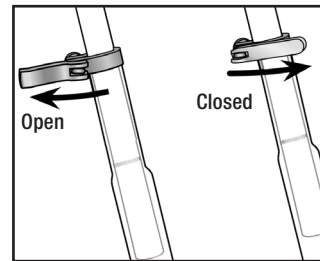

Figure 41

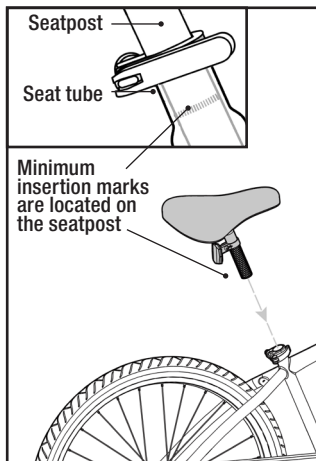

Figure 42

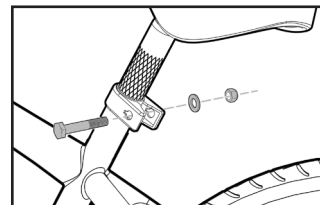

Figure 43

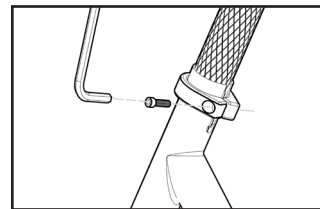

Figure 44

STEM ADJUSTMENT

To raise or lower your stem, use an adjustable wrench or Allen wrench on the stem bolt to loosen the stem (see Figure 45). Do not remove this bolt completely, as the stem wedge may fall inside your frame. Make sure the stem is inserted enough so that the minimum insertion marks on your stem are completely covered (see Figure 46).

⚠ WARNING: To prevent steering system damage and possible loss of control, the stem must be inserted enough so that the minimum insertion marks are completely covered.

⚠ WARNING: Do not over tighten the stem bolt. Over tightening the stem bolt can damage the steering system and cause a loss of control. If necessary re-adjust the handlebar and tighten the handlebar clamp nut.

⚠ WARNING: If the handlebar clamp is not tight enough, the handlebar can slip in the stem. This can cause damage to the handlebar or stem, and can cause loss of control and serious injury or even death. (See pages 20–21 for instructions.)

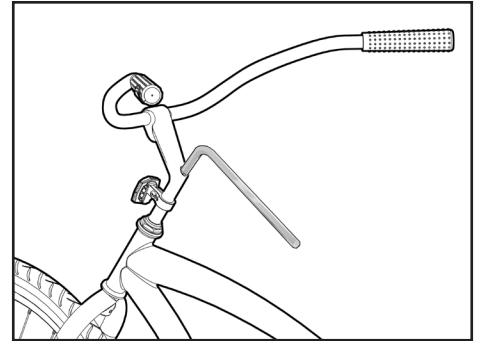

Figure 45

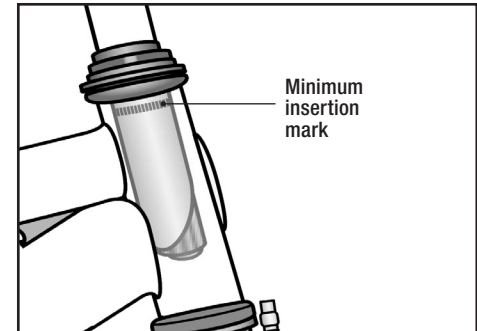

Figure 46

MAINTENANCE AND INSPECTION

⚠ WARNING: Inspect the bicycle frequently. Failure to inspect the bicycle and to make repairs or adjustments, as necessary, can result in injury to the rider or to others. Make sure all parts are correctly assembled and adjusted as written in this manual.

- Immediately replace any damaged, missing, or badly worn parts.
- Make sure all fasteners are correctly tightened as written in this manual. Parts that are not tight enough can be lost or operate poorly. Over tightened parts can be damaged. Make sure any replacement fasteners are the correct size and type.

NOTE: Have a bicycle service shop make any repairs or adjustments for which you do not have the correct tools or if the instructions in this manual are not sufficient for you.

NOTE: Before every ride, it is important to carry out the safety checks detailed on page 14. (For information and instructions on performing specific equipment checks, locate the relevant section in the manual referenced on pages 5–6.)

⚠ WARNING: Do not attempt chain repairs. If there is a problem with the chain, have a bicycle service shop make any repairs.

The chain must be at the correct tightness. If too tight, the bicycle will be difficult to pedal. If too loose, the chain can come off the sprockets. When the chain is at the correct tightness, you can rotate the crank freely and you can pull it no more than one-half inch away from a straightedge as shown (see Figure 47).

Adjust the tightness of the chain as follows:

- Loosen the axle nuts of the rear wheel.
- Move the rear wheel forward or backward as necessary.
NOTE: Make sure the rear wheel is centered in the bicycle frame (see Figure 48).
- Hold the wheel in this position and tighten the axle nuts.

TIRE REMOVAL/SEATING

Before adding air to any tire, make sure the edge of the tire (the bead) is the same distance from the rim, all around the rim, on both sides of the tire. If the tire does not appear to be seated correctly, release air from the inner tube until you can push the bead of the tire into the rim where necessary. Add air slowly and stop frequently to check the tire seating and the pressure, until you reach the correct inflation pressure (see Figure 49).

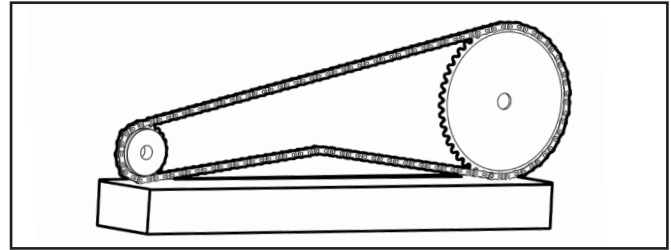

Figure 47



Figure 48

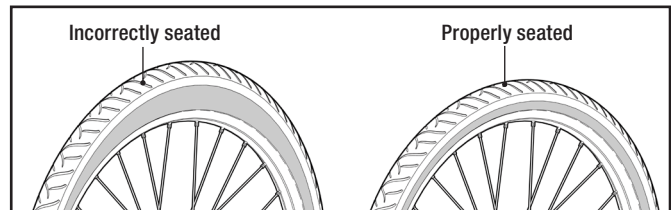

Figure 49

LUBRICATION

| Frequency | Component | Lubricant | How to Lubricate |
|------------------|-----------------------|-------------------------|------------------------|
| Weekly | Chain | Chain lube or light oil | Brush on or squirt |
| | Deraillleur Wheels | Chain lube or light oil | Oil can |
| | Deraillleurs | Oil | 3 drops from oil can |
| | Brake Calipers | Oil | 2 drops from oil can |
| Every Six Months | Freewheel | Oil | 2 squirts from oil can |
| | Brake Cables | Lithium based grease | Disassemble |
| Yearly | Bottom Bracket | Lithium based grease | Disassemble |
| | Headset | Lithium based grease | Disassemble |
| | Hubs (front and rear) | Lithium based grease | Disassemble |

⚠ WARNING: Do not over lubricate. If oil gets in unintended places, it may reduce brake performance and a longer distance to stop the bicycle will be necessary. Injury to the rider or to others can occur.

- The chain can throw excess oil onto the wheel rim. Wipe excess oil off the chain.
- Keep all oil off the surfaces of the pedals where your feet rest.
- Using soap and hot water, wash all oil off the wheel rims, the brake shoes, the pedals, and the tires.
- Rinse with clean water and dry completely before you ride the bicycle.
- Use only a bicycle specific lube, as other common oils will not provide the correct lubrication.

BEARING INSPECTION

- **Maintenance**

Frequently check the bearings of the bicycle. Have a bicycle shop clean and re-grease the bearings once a year or any time they do not pass the following tests:

- **Header Bearings**

The fork should turn freely and smoothly at all times. With the front wheel off the ground, you should not be able to move the fork up, down, or side-to-side in the head tube.

- **Bottom Bracket Bearings**

The crank should turn freely and smoothly at all times and the front sprockets should not be loose on the crank. You should not be able to move the pedal end of the crank from side-to-side.

- **Wheel Hub Bearings**

Lift each end of the bicycle off the ground and slowly spin the raised wheel by hand. The bearings are correctly adjusted if:

- The wheel spins freely and easily.
- The weight of the spoke reflector, when you put it toward the front or rear of the bicycle, causes the wheel to spin back and forth several times.
- There is no side-to-side movement at the wheel rim when you push it to the side with light force.

LIMITED WARRANTY

Although your new Dynacraft bicycle is built tough, it is designed for recreational use only, not commercial use or extreme riding. Subject to the following limitations, all bicycles manufactured for Dynacraft are warranted to the original purchaser to be free of defects in materials and workmanship for a period from the date of purchase until:

Lifetime for the Bicycle Frame and Fork, and Two Years On All Other Bicycle Component Parts. No other express or implied warranty given.

Dynacraft will replace without charge the bicycle frame, fork or those component parts that are determined by Dynacraft to be defective in materials or manufacture under normal use and service during the applicable warranty period. The original purchaser will be responsible for any and all labor charges connected with the repair or replacement of the frame, fork, and/or parts. Component parts subject to wear in use, tires, tubes, seats, grips, and brake shoes are not covered under this warranty.

BEWARE THERE ARE LIMITATIONS ON WHAT WE WARRANTY:

This limited warranty does not apply to normal wear and tear, nor to claimed defects, malfunctions, or failures that result from abuse, neglect, improper assembly, improper maintenance, alteration, collision, crash, misuse, or any damage caused while in an organized competition or commercial activity. The bicycle frame, fork, and component parts have been manufactured for use by average riders, and the bicycles are not intended for trick riding, ramp riding, jumping, aggressive riding or any similar extreme activities; such uses may damage the bicycle frame, fork and/or component parts and will void this warranty. Dynacraft's bicycles are intended for the average rider to

use on streets, roads and bicycle-approved trails and are for non-competition riding that is safe and within the rider's experience and limits. Even in these circumstances bicycle riding can be inherently dangerous such that bodily injury or death can occur, especially if the rider does not make the safety and maintenance checks recommended in this manual, if the rider does not wear a helmet, if the rider does not follow the rules of the road, if the rider goes into traffic, rides double, or engages in aggressive stunts or extreme terrain riding. All riders will assume their own risk of injury while biking, and Dynacraft will not be responsible unless the accident and injury arise out of Dynacraft's sole negligence and such negligence must be affirmatively proven.

THE PURCHASE OF THIS BICYCLE WILL CONFIRM THE BUYER'S AGREEMENT THAT DYNACRAFT'S LIABILITY UNDER THIS WARRANTY SHALL BE NO GREATER THAN THE AMOUNT OF THE ORIGINAL PURCHASE PRICE AND IN NO EVENT SHALL DYNACRAFT BE LIABLE FOR INCIDENTAL OR CONSEQUENTIAL DAMAGES.

This Limited Warranty will be void if the product is ever:

- used in a manner other than for recreation or transportation
- modified in anyway
- used as a rental

Dynacraft does not offer an extended warranty; if you have purchased an extended warranty, it must be honored by the store from which you purchased the bicycle or the appropriate party. For your records, keep your original sales receipt with this manual.

Dynacraft Customer Service

1-800-551-0032

7AM to 4PM Pacific Standard Time



**DO NOT return this item to the store.
Please call Dynacraft for assistance.**

Please have the following information available when you call:

| | |
|------------------|-------------------------|
| Model Number: | (sample: 8802-33) |
| Production Date: | (sample: 03.03.2015) |
| Serial Number: | (sample: DA0233HD00001) |

Having this information will be required and helps us handle your call more effectively.



DYNACRAFT®

Dynacraft BSC, Inc.

89 S. Kelly Rd., American Canyon, CA 94503

Call Toll Free 1-800-551-0032

Monday – Friday 7AM to 4PM PST

www.dynacraftbike.com

©2015 All rights reserved

2016 Printed in China

D008