

INSTRUCTION MANUAL FOR



RUGER® M77® HAWKEYE® & GUIDE GUN BOLT-ACTION RIFLES



M77® Hawkeye® Standard



M77® Hawkeye® African



Ruger® Guide Gun

– RUGGED, RELIABLE FIREARMS® –



**READ THE INSTRUCTIONS AND
WARNINGS IN THIS MANUAL CAREFULLY
BEFORE USING THIS FIREARM**

© 2016 Sturm, Ruger & Co., Inc.

This manual may not be reproduced in whole or in part without the express written permission of Sturm, Ruger & Co., Inc.

**For Service on This Model Please Call:
(336) 949-5200 (See p. 26)**

THIS INSTRUCTION MANUAL SHOULD ALWAYS ACCOMPANY THIS FIREARM AND BE TRANSFERRED WITH IT UPON CHANGE OF OWNERSHIP, OR WHEN THE FIREARM IS LOANED OR PRESENTED TO ANOTHER PERSON

WWW.RUGER.COM

DH 9/16 R10

State-By-State Warnings

Certain states require by law that their own specified warning notices in larger-than-normal type be conspicuously included by the manufacturer, distributor or retailer with firearms sold in that state. Sturm, Ruger & Co., Inc. sells its products in compliance with applicable laws and regulations. Because our products may be sold in these states, we include the following:

California:

⚠ WARNING

“Children are attracted to and can operate firearms that can cause severe injuries or death. Prevent child access by always keeping guns locked away and unloaded when not in use. If you keep a loaded firearm where a child obtains and improperly uses it, you may be fined or sent to prison.”

⚠ ADVERTENCIA

“A los niños los atraen las armas de fuego y las pueden hacer funcionar. Ellos pueden causarse lesiones graves y la muerte. Evite que los niños tengan acceso a las armas de fuego guardándolas siempre con llave y descargadas cuando no las esté utilizando. Si usted tiene un arma de fuego cargada en un lugar en que un niño tiene acceso a ella y la usa indebidamente, le pueden dar una multa o enviarlo a la cárcel.”

Connecticut:

“UNLAWFUL STORAGE OF A LOADED FIREARM MAY RESULT IN IMPRISONMENT OR FINE.”

Florida:

“IT IS UNLAWFUL, AND PUNISHABLE BY IMPRISONMENT AND FINE, FOR ANY ADULT TO STORE OR LEAVE A FIREARM IN ANY PLACE WITHIN THE REACH OR EASY ACCESS OF A MINOR UNDER 18 YEARS OF AGE OR TO KNOWINGLY SELL OR OTHERWISE TRANSFER OWNERSHIP OR POSSESSION OF A FIREARM TO A MINOR OR A PERSON OF UNSOUND MIND.”

Maine:

“ENDANGERING THE WELFARE OF A CHILD IS A CRIME. IF YOU LEAVE A FIREARM AND AMMUNITION WITHIN EASY ACCESS OF A CHILD, YOU MAY BE SUBJECT TO FINE, IMPRISONMENT OR BOTH. KEEP FIREARMS AND AMMUNITION SEPARATE. KEEP FIREARMS AND AMMUNITION LOCKED UP. USE TRIGGER LOCKS.”

Maryland:

“WARNING: Children can operate firearms which may cause death or serious injury. It is a crime to store or leave a loaded firearm in any location where an individual knew or should have known that an unsupervised minor would gain access to the firearm. Store your firearm responsibly!”

Massachusetts:

“WARNING FROM THE MASSACHUSETTS ATTORNEY GENERAL: This handgun is not equipped with a device that fully blocks use by unauthorized users. More than 200,000 firearms like this one are stolen from their owners every year in the United States. In addition, there are more than a thousand suicides each year by younger children and teenagers who get access to firearms. Hundreds more die from accidental discharge. It is likely that many more children sustain serious wounds, or inflict such wounds accidentally on others. In order to limit the chance of such misuse, it is imperative that you keep this weapon locked in a secure place and take other steps necessary to limit the possibility of theft or accident. Failure to take reasonable preventive steps may result in innocent lives being lost, and in some circumstances may result in your liability for these deaths.”

“IT IS UNLAWFUL TO STORE OR KEEP A FIREARM, RIFLE, SHOTGUN OR MACHINE GUN IN ANY PLACE UNLESS THAT WEAPON IS EQUIPPED WITH A TAMPER-RESISTANT SAFETY DEVICE OR IS STORED OR KEPT IN A SECURELY LOCKED CONTAINER.”

New Jersey:

“IT IS A CRIMINAL OFFENSE TO LEAVE A LOADED FIREARM WITHIN EASY ACCESS OF A MINOR.”

New York City:

“THE USE OF A LOCKING DEVICE OR SAFETY LOCK IS ONLY ONE ASPECT OF RESPONSIBLE FIREARMS STORAGE. FOR INCREASED SAFETY, FIREARMS SHOULD BE STORED UNLOADED AND LOCKED IN A LOCATION THAT IS BOTH SEPARATE FROM THEIR AMMUNITION AND INACCESSIBLE TO CHILDREN AND OTHER UNAUTHORIZED PERSONS.”

North Carolina:

“IT IS UNLAWFUL TO STORE OR LEAVE A FIREARM THAT CAN BE DISCHARGED IN A MANNER THAT A REASONABLE PERSON SHOULD KNOW IS ACCESSIBLE TO A MINOR.”

Texas:

“IT IS UNLAWFUL TO STORE, TRANSPORT, OR ABANDON AN UNSECURED FIREARM IN A PLACE WHERE CHILDREN ARE LIKELY TO BE AND CAN OBTAIN ACCESS TO THE FIREARM.”

Wisconsin:

“IF YOU LEAVE A LOADED FIREARM WITHIN THE REACH OR EASY ACCESS OF A CHILD YOU MAY BE FINED OR IMPRISONED OR BOTH IF THE CHILD IMPROPERLY DISCHARGES, POSSESSES, OR EXHIBITS THE FIREARM.”

* * * * *

Please check with your licensed retailer or state police for additional warnings which may be required by local law or regulation. Such regulations change constantly, and local authorities are in the best position to advise you on such legal matters.

FIREARMS SAFETY IS YOUR RESPONSIBILITY
**SAFETY MUST BE THE FIRST AND CONSTANT
CONSIDERATION OF EVERY PERSON WHO HANDLES
FIREARMS AND AMMUNITION.**

This Instruction Manual is designed to assist you in learning how to use and care for your RUGER® M77® HAWKEYE® and GUIDE GUN rifles properly. Please contact us if you have any questions.

Only when you are certain you fully understand the manual and can properly carry out its instructions should you practice loading, unloading, etc. with live ammunition. If you have any doubts about your ability to handle or use a particular type of gun safely, you should seek supervised instruction. Such personalized instruction often is available from local gun retailers, gun clubs or police departments. If none of these sources can help, visit www.nra.org or write to the following address:

National Rifle Association
11250 Waples Mill Road
Fairfax, VA 22030-7400

The person possessing a gun has a full-time job. You cannot guess; you cannot forget. You must know how to use your firearm safely. **Do not use any firearm without having a complete understanding of its particular characteristics and safe use.** Remember: There is no such thing as a foolproof gun.

TABLE OF CONTENTS

	Page
State-By-State Warnings	2
Nomenclature	7
Locking Device Installation Instructions	8
General Information and Mechanical Characteristics	10
Operation of Safety	11
Ammunition	12
Ruger® Muzzle Brake System	13
To Load and Fire	13
To Unload Rifle and Magazine	15
To Clear a Malfunction (“Jam”)	16
To Minimize Malfunctions (“Jams”)	18
Basic Disassembly and Reassembly	18
Care and Cleaning	22
Storage	23
Maintenance of Stainless Steel Rifles	24
Attaching Ruger Scope Rings	24
Length of Pull Adjustment	25
Sight Picture and Adjustment for “African” and Guide Gun Models Only . . .	25
Service and Parts Policy	26
Shipping Firearms for Repair	26
Ordering Parts	27
Parts List	28
Exploded View	33
Muzzle Brake System Parts List & Exploded View	34
Ruger® Guide Gun & FTW Hunter Thread Patterns	34
The Basic Rules of Safe Firearms Handling	35
Warranty Information	40

“Ruger,” “M77,” and “Hawkeye” are registered U.S. trademarks.



**WARNINGS OF GREAT IMPORTANCE ARE
FOUND ON THE FOLLOWING PAGES:**

Locking Devices	8	Unloading	16
Alterations	10	Malfunctions	17
Manual Safety	12	Disassembly	18
Ammunition	12	Lubrication	23
Lead Exposure	13	Storage	23
Loading	14	Shipping	26
Handling	14	Parts Purchasers	27
Firing	15		

**OTHER CAUTIONS AND WARNINGS APPEAR
THROUGHOUT THE MANUAL.**

NOMENCLATURE

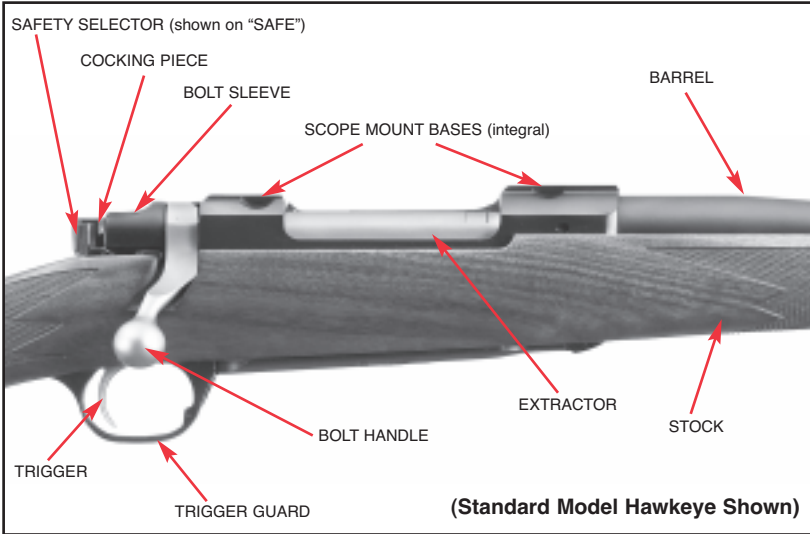

Figure 1. Right-handed version shown. In this illustration the cocking piece is shown cocked (protruding from the rear of the bolt sleeve). *The safety selector should be in the "Load-Unload" position when the bolt is being removed or installed.*

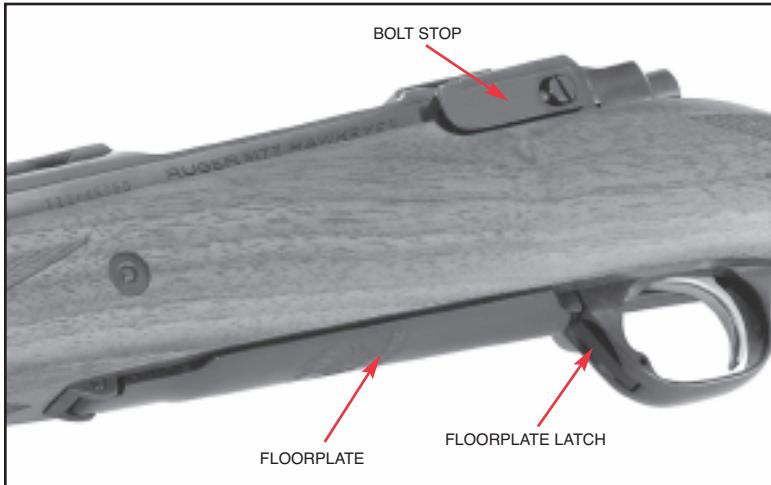

Figure 2. The bolt stop (on the left side of the receiver) permits the bolt to be withdrawn simply by pulling it out to the left.

LOCKING DEVICE INSTALLATION INSTRUCTIONS



WARNING – USE OF LOCKING DEVICES



**Do not store keys
in lock.**

- Always keep your firearm pointed in a safe direction, including when you are installing or removing your locking device.
- Always verify that your firearm is completely unloaded before installing your locking device.
- Do **not** install locking devices in the trigger guard; always keep your fingers and locking device outside the trigger guard during device installation and removal.
- Store firearms, ammunition and keys separately and securely, away from children and careless adults; do **not** store your firearm with the keys in the locking device.
- Do not attempt to work the action of your firearm with the locking device in place; this may damage your firearm.
- While locking devices are an important aid to security measures, they are not a substitute for safe firearm handling and proper storage. Remember that any mechanical device can be bypassed with enough time, knowledge, determination and equipment.

**LOCKING DEVICES MUST BE USED
SAFELY AND RESPONSIBLY**

It is important to use the locking device on your Ruger® firearm!

Keep the muzzle pointed in a safe direction and your fingers outside the trigger guard at all times!

To Install the Factory-Supplied Locking Device:

1. Place the safety selector in the “Load-Unload” position.
2. Open the action completely by drawing the bolt fully to the rear.
3. **Verify that the firearm is completely unloaded and contains no cartridges or cartridge cases!**
4. Remove the bolt from the rifle. See the “Disassembly” section on page 19 for proper removal.

5. Apply the lock directly to your RUGER® M77® HAWKEYE® or RUGER® GUIDE GUN as shown below in Figure 3.
6. To lock: With the key turned to the farthest clockwise position, insert the loose end of the cable into the padlock. Turn the key counterclockwise and remove the key.
7. Once the lock is securely closed, pull firmly on the lock to test the connection and be sure it is locked. **Do not leave or store your firearm with the key in the lock!** Store your locked unloaded firearm and the key in secure, separate locations, away from ammunition, children, and unauthorized adults.



**Correct Installation of Lock For
Ruger® M77® Hawkeye® & Guide Gun Rifles**

**FIREARMS ARE DANGEROUS WEAPONS
READ THE INSTRUCTIONS AND WARNINGS
IN THIS MANUAL THOROUGHLY AND CAREFULLY
BEFORE USING.**

 WARNING—ALTERATIONS	
	This product was designed to function properly in its original condition. Alterations can make it unsafe. Do not alter any part or add or substitute parts or accessories not made by Sturm, Ruger & Co., Inc.
	DO NOT ALTER ANY GUN

GENERAL INFORMATION AND MECHANICAL CHARACTERISTICS

The RUGER® M77® HAWKEYE® and RUGER® GUIDE GUN are bolt-action, magazine fed, repeating rifles. The receiver on the RUGER® M77® HAWKEYE® rifle incorporates integral scope mount bases (see Figure 1, p. 7). A set of two steel one-inch scope rings is included.

Other notable features of the RUGER® M77® HAWKEYE® rifle include: a new LC6™ trigger, three-position safety, a fast lock-time steel trigger mechanism, a patented bedding system, quick release hinged floorplate with a newly designed floorplate latch, a newly contoured cut-checked walnut stock with red rubber recoil pad, and studs to which sling swivels can be attached. An “All-Weather®” version featuring stainless steel construction and a warp-proof synthetic stock is also available.

All mechanical components are made of heat-treated chrome-molybdenum or stainless steel with music wire coil springs throughout the mechanism (except the magazine spring). The rifle is available in short and standard length action.

The RUGER® M77® HAWKEYE® **“African” Model** features a blue matte finish, American walnut stock, red recoil pad, and Ruger® Muzzle Brake System.

The RUGER® M77® HAWKEYE® **Compact Model** has a specially designed stock with a 12-3/4” length of pull, shorter forend, and a 16-1/2” lightweight barrel for ease of carry in dense cover.

The RUGER® GUIDE GUN features a rugged Green Mountain laminate stock with a soft rubber recoil pad with buttpad spacers, and Ruger® Muzzle Brake System.

The RUGER® M77® HAWKEYE® **“Alaskan” Model (no longer in production)** is designed to handle the harshest conditions. The “Alaskan” has a medium-weight 20” hammer forged barrel, matte black weather and abrasion resistant finish, and a Hogue® OverMolded™ synthetic stock.

OPERATION OF SAFETY

These bolt-action rifles have a three-position safety. The safety selector is located at the right of the bolt sleeve (on the left of the bolt sleeve on left-handed versions). The safety selector can be moved from the “Fire” position to its two other positions (“Load-Unload” and “Safe”) only when the firing pin is cocked. Fully raising the bolt handle cocks the firing pin.

The bolt handle can be raised and lowered only when the safety selector is in either the “Fire” or the “Load-Unload” position. When the safety selector is in the “Safe” position, the bolt handle is locked in the closed (full down) position, in order to prevent inadvertent lifting of the bolt handle and to ensure that the rifle will be ready to fire when the safety is moved to the “fire” position.

Practice (with an unloaded rifle) moving the safety selector to the three positions until you know the position of the safety selector for the three modes– “Fire,” “Load-Unload,” and “Safe.” **WARNING: When manipulating the safety selector, DO NOT HAVE ANY FINGER INSIDE THE TRIGGER GUARD! When the safety selector is in the “Fire” position and the trigger is pulled, the rifle will fire.**

The safety selector should always be in the “Safe” position except when the gun user is actually firing or unloading the rifle. The safety selector should unfailingly be moved to the “Safe” position when the gun user ceases firing.

SAFETY POSITIONS

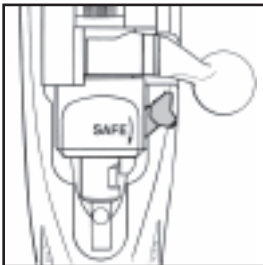

Figure 4. Safety selector in “FIRE” (full forward) position. The safety selector should be moved to this position only when the gun user is actually firing the rifle. When the safety selector is in the fire position, it is referred to as being “off.” (When the safety is in the “SAFE” position, it is referred to as being “on.”)

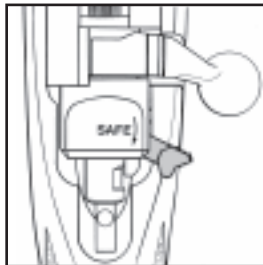

Figure 5. Safety selector in “LOAD-UNLOAD” (middle) position. The safety selector should be in this position when the bolt is being cycled to load a cartridge, or to unload a live round. As soon as a cartridge is chambered, the safety selector should be moved to the “SAFE” position unless the rifle is to be fired immediately.

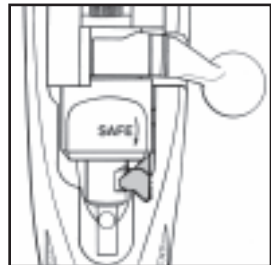

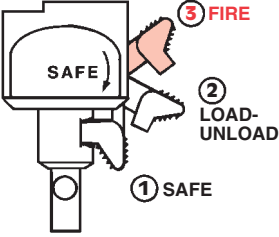

Figure 6. Safety selector in “SAFE” (full rearward) position. The safety selector is fully nested in the groove in the cocking piece. When the safety selector is in this position, the bolt handle cannot be raised. The curved arrow on the bolt sleeve indicates the direction and motion of the safety selector to bring it to the “SAFE” position. **Keep the safety selector in this position except when actually loading, unloading, or firing.**



The safety selector is held in each of its three positions by a plunger that is under spring tension. Therefore, the gun user should frequently check the position of the safety selector to be certain it has not been inadvertently moved. If the safety does not function properly, or if the selector seems to move too easily, or if the safety selector does not seem firmly positioned in any of its three positions, the rifle should be discontinued from use and returned to the Newport Customer Service Department for repair (see p. 26).

 <h2 style="margin: 0;">WARNING – MANUAL SAFETY</h2>	
	<p>Keep the safety on unless actually firing. Always move the safety fully to its intended position and check it. The safety has three positions –“SAFE,” “LOAD-UNLOAD,” and “FIRE.” Never depend on a safety mechanism or any other mechanical device to justify careless handling or permitting the rifle to point in an unsafe direction. The only “safe” rifle is one in which the bolt is open and the chamber and magazine are empty.</p>
<h3 style="margin: 0;">KNOW HOW TO USE THE SAFETY</h3>	

AMMUNITION

RUGER® M77® HAWKEYE® and GUIDE GUN rifles are chambered for many of the most popular factory-loaded cartridges manufactured in accordance with U.S. industry practice. The particular caliber for each rifle is rollmarked on the barrel. Use cartridges only of the designated caliber that is marked on the barrel. Please see “Warning - Ammunition” and “Warning - Loading” on page 14.

<h3 style="margin: 0; color: red;">AMMUNITION (CARTRIDGES) NOTICE</h3> <p style="color: red; text-align: center;"> WE SPECIFICALLY DISCLAIM RESPONSIBILITY FOR ANY DAMAGE OR INJURY WHATSOEVER OCCURRING IN CONNECTION WITH, OR AS A RESULT OF, THE USE IN ANY RUGER® FIREARMS OF FAULTY, OR NON-STANDARD, OR “REMANUFACTURED” OR HAND-LOADED (RELOADED) AMMUNITION OR OF CARTRIDGES OTHER THAN THOSE FOR WHICH THE FIREARM WAS ORIGINALLY CHAMBERED. </p>
--

 <h2 style="margin: 0;">WARNING – AMMUNITION</h2>	
	<p>Death, serious injury, and damage can result from the wrong ammunition, bore obstructions, powder overloads or incorrect cartridge components. Even the strongest gun can be blown up by excess pressure. Only use correct ammunition loaded to U.S. Industry Standards. <u>Always</u> wear shooting glasses and hearing protection.</p>
	<h3 style="margin: 0;">IMPROPER AMMUNITION DESTROYS GUNS</h3>



WARNING – LEAD EXPOSURE



Discharging firearms in poorly ventilated areas, cleaning firearms, or handling ammunition may result in exposure to lead and other substances known to the State of California to cause birth defects, reproductive harm, and other serious physical injury. Have adequate ventilation at all times. Wash hands thoroughly after exposure.

**SHOOTING OR CLEANING GUNS
MAY EXPOSE YOU TO LEAD**

RUGER® MUZZLE BRAKE SYSTEM (FOR RIFLES SO EQUIPPED)

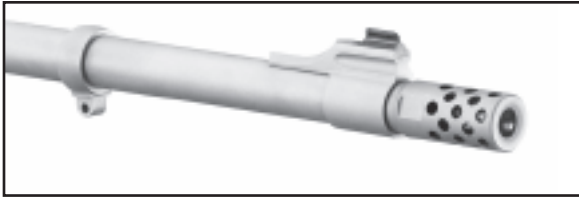

The Ruger® Muzzle Brake System includes a removable, radial-port muzzle brake that significantly reduces felt recoil. For times when the brake is not preferred, it may be replaced by the included dynamically matched muzzle weight. Switching between the brake and the weight will not change the bullet's point of impact for a particular load. The included thread protector may be used if neither the brake nor the tuner is desired.

Before changing the muzzle brake system components, point the rifle in a safe direction and ensure all ammunition is removed from the chamber and magazine. The muzzle brake system components are attached using standard right-hand threads, and should be tightened to 20 foot-pounds once installed.

TO LOAD AND FIRE

Practice the important aspects of gun handling described below (with an unloaded rifle) until you can perform each of the steps with skill and confidence. **But before loading the rifle, please read completely through this manual, and be certain the muzzle is pointing in a safe direction. Do not load the rifle until you are ready to use it!**



(The following procedure assumes a new rifle with the bolt out).

1. Keep the muzzle pointed in a safe direction (See Rule 2, p. 34).
2. Position the safety selector in the “Load-Unload” position (see Figure 5, p. 11).

3. Insert the bolt in the receiver in accordance with “To replace bolt” instructions on Page 21.

4. Draw the bolt fully to the rear.

Loading the magazine: (Safety should be in “Load-Unload” position.) With the bolt open, and the floorplate in its closed and latched position, load cartridges of the correct caliber directly into the magazine from the top by pressing one cartridge at a time into the magazine.

 WARNING – LOADING	
	<p>Know the caliber of your rifle you are loading and load cartridges of only that caliber into it!</p> <p>Before loading, be certain the primer of each cartridge is seated flush with, or below, the surface of the cartridge case base. A cartridge discharged by the closing of the bolt can result in possible serious injury to the shooter and those nearby.</p> <p>If a cartridge does not chamber readily, do not force it. Check the bore and chamber to be certain that each cartridge is the proper caliber and of correct dimensions. If you cannot determine why the cartridge will not fit, clear the rifle of all cartridges and write or call the factory.</p>
	<p>The wrong ammunition can destroy your gun and result in serious injury.</p>
BE SURE WHAT YOU LOAD IS CORRECT	

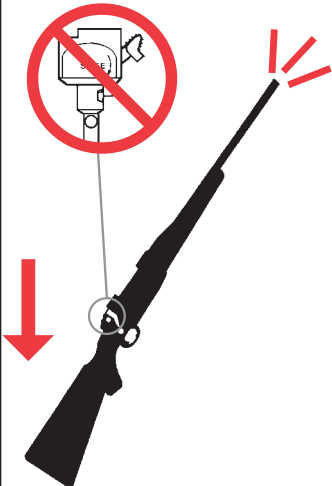
 WARNING – HANDLING	
	<p>Never carry the rifle loaded with the safety selector in the “FIRE” position. If dropped or struck with the safety off, the rifle may fire. Such a discharge can occur with or without the trigger being directly struck or touched.</p> <p>Never rest a loaded rifle against any object (wall, fence, vehicle, tree, etc.) because there is always the possibility that the rifle will be jarred or slide from its position and fall with sufficient force to discharge. Keep safety on unless actually firing.</p> <p>Never lower (uncock) the firing pin with a loaded cartridge in the chamber. Under such circumstances the firing pin will be in direct contact with the primer of the loaded cartridge and a light accidental blow to the firing pin can readily cause the gun to discharge.</p>
ANY GUN MAY FIRE IF DROPPED	

Loading the chamber: (Safety should be in “Load-Unload” position.) Do not chamber a cartridge until you are ready to shoot immediately. After loading the magazine, push the bolt handle forward. This will strip a cartridge from the magazine and push the cartridge ahead of the bolt into the chamber. Close the bolt handle fully downward and put the safety fully rearward to the “Safe” position.

To single-load: (Safety should be in “Load-Unload” position.) Place a cartridge directly into the chamber and close the bolt. If there are cartridges in the magazine and it is desired to single-load a cartridge directly into the chamber, depress the top cartridge and push the bolt forward until the bolt face is well ahead of the rim of the top cartridge in the magazine. Then, close the bolt.

To fire the rifle: When a cartridge is chambered and the rifle is pointed in a safe direction, put the safety in the “Fire” position. Pulling (squeezing) the trigger will discharge the cartridge. Always be certain that you know where the bullet will strike when you fire the rifle. Never allow the thumb to touch the cocking piece when firing as it can be pinched when the cocking piece moves forward to fire the rifle.



WARNING: DO NOT TOUCH THE TRIGGER UNTIL YOU ARE ACTUALLY READY TO FIRE THE RIFLE.



WARNING – FIRING

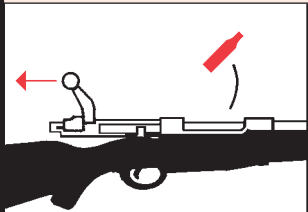

When firing the M77® Hawkeye rifle, be sure that bystanders are well clear of the shooter and standing a safe distance to the rear. Empty cartridge cases are hot and are normally ejected from the rifle to the right. They could cause injury to any person who is standing too closely alongside the shooter. Shooters who fire right-handed rifles from their left shoulder should be particularly cautious concerning ejected cartridge cases and the back of the bolt as it is drawn rearward.

EJECTED BRASS IS HOT

TO UNLOAD RIFLE AND MAGAZINE

(RIFLE MUST BE POINTING IN A SAFE DIRECTION)

UNLOAD THE RIFLE IMMEDIATELY WHEN YOU ARE FINISHED SHOOTING.

1. Move the safety selector to the “Load-Unload” position if the firing pin is cocked.
2. Lift the bolt handle fully and then pull it completely to the rear to eject chambered cartridge.
3. Inspect the chamber to be certain the cartridge has been extracted. Leave bolt open. Do not unload magazine by feeding cartridges into chamber.
4. Push rearward the small latch in the front of the trigger guard to open the hinged floorplate and empty the cartridges from the magazine. Hold the other hand under the floorplate so as to retard the opening of the spring loaded floorplate and catch the cartridges in the palm of the hand.

5. Close the bolt fully.
6. Move the safety selector in the “Fire” position and **with the rifle pointed in a safe direction, pull the trigger.**

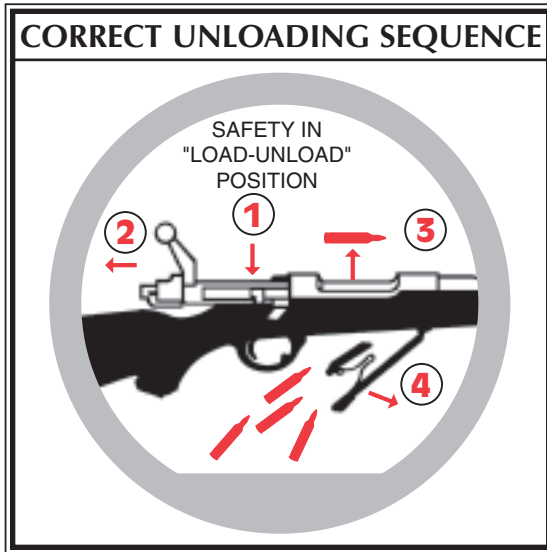



! WARNING – UNLOADING	
	<p>Removing cartridges from the magazine does not prevent the rifle from being fired! When there is a cartridge in the chamber and the safety selector is in the “Fire” position, the cartridge will discharge if the trigger is pulled. It is absolutely essential for the user to know how to completely unload it.</p> <p>“Completely” means emptying the magazine and removing a chambered cartridge. The safety selector should always be in the “Load-Unload” position when the rifle is being unloaded. See the “Operation of Safety” section of this manual.</p>
GUN WILL FIRE WITH EMPTY MAGAZINE	

TO CLEAR A MALFUNCTION (“JAM”)

If a jam occurs, immediately put the safety selector in the “Load-Unload” position and be certain the muzzle of the rifle is at all times pointing in a safe direction.

Then study the situation to determine the nature of the jam and how best to clear it.

- If a cartridge or fired case is caught between the bolt and the barrel, or against a cartridge that is in the chamber, open the hinged floor plate and empty the cartridges from the magazine. Then retract the bolt fully and remove the jammed cartridge or case.
- When attempting to extract a cartridge that is “stuck” in the chamber do not use any type of tool that is likely to act as a “firing pin” and discharge the cartridge should the tool impact on the primer.
- After clearing a jam, inspect the gun mechanism to determine if dirt might be the cause of the problem. Excess lubricant or grease can cause cartridges to feed sluggishly or fail to extract. An accumulation of grease or dirt on the face of the bolt, under the extractor, in the chamber, or in the magazine can contribute to cartridge feeding problems. (See section on “Care and Cleaning” page 22.)
- After clearing a jam, inspect all cartridges that have been removed from the gun. Safely dispose of any cartridges which are in any way damaged.
- If it appears that the rifle is not at fault and that the jam was caused by the type of cartridge being used, then try another type.
- Examine your fired cartridge cases. If they have split, blown or bulged heads, stop using that ammunition and promptly return the rifle to the factory for examination.
- If the above procedures do not result in a smooth and reliable feeding firearm, don’t use the rifle. The RUGER® M77® HAWKEYE® and RUGER® GUIDE GUN can be returned directly to our Newport Customer Service Department for inspection and repair, if required. See the “Service and Parts Policy” section of the manual for packing and shipping information.

 WARNING – MALFUNCTIONS	
	<p>If a cartridge hangs up, jams, or binds when being chambered or when being fed from the magazine into the chamber, do not attempt to force it into the chamber by pushing or striking the bolt handle.</p> <p>Most failures of a cartridge to feed or to chamber are caused by improper loading of the magazine or ammunition that is incorrect or defective.</p> <p>Whatever the cause, the user must, above all, recognize that jams can result in the potentially very dangerous situation of a cartridge discharging before it is chambered. If this occurs, the cartridge case will rupture and its fragments will fly out of the gun with sufficient force to cause injury. Always wear shooting glasses and hearing protection!</p>
	STRIKING PRIMER CAN BURST CARTRIDGE

TO MINIMIZE MALFUNCTIONS (“JAMS”)



Firearms of all makes and types are susceptible to occasional malfunctioning due to a cartridge not feeding from the magazine to the chamber, or due to a cartridge or fired case not being extracted and ejected.

To minimize the possibility of such occurrences the gun user should:

- Use ammunition of the correct caliber and type which is loaded to U.S. Industry Specifications. Do not use cartridges that are deformed or cartridges that have been reloaded.
- Clean and lubricate the gun in accordance with the instructions in this manual.
- Learn to correctly operate the bolt and how to properly load and empty the chamber and magazine.
- If the mechanism shows signs of not functioning correctly, or if a part is damaged or broken – don’t use the rifle. Have it inspected and repaired.

For most repairs we recommend that Ruger guns be returned to the factory. However, if a gun has a cartridge in it which cannot be removed, then it is a violation of Federal Regulations to ship that loaded gun whether it be by U.S. Mail or by common carrier. Contact our Newport Customer Service Department at 336-949-5200.

BASIC DISASSEMBLY AND REASSEMBLY

 WARNING – DISASSEMBLY	
	Always unload a firearm before cleaning, lubrication, disassembly or assembly.
UNLOAD BEFORE CLEANING	

It is preferable to carry out these procedures on a workbench or table which has a covered top. A piece of shallow nap rug or an old, coarse blanket is an ideal covering. Such a covering not only reduces the chances of the rifle slipping and being scratched, but it serves also to trap pins, plungers and springs that may otherwise get lost. It is advisable to have a container – such as a shoebox – in which each part can be placed as it is removed from the gun.

Before attempting to disassemble the rifle for the first time, study the parts drawing and parts list so as to be familiar with the relative position, appearance and name of each part. Carry out the disassembly slowly and carefully note the position of the part in the gun before starting to remove it. If a part is under

spring tension (such as, the Safety Selector, Bolt Stop, Trigger) remove it cautiously and anticipate the direction the spring and plunger are most likely to “jump.”

WARNING: If a spring or plunger become lost do not use a substitute. Springs of correct tension are vital to the safe and reliable performance of firearms. Before starting disassembly, remove the sling, scope and rings and place the rear sight blade in its down flat position.

DISASSEMBLY

(RIFLE MUST BE UNLOADED PRIOR TO DISASSEMBLY)

An on-line video demonstrating the disassembly and reassembly of the RUGER® M77® HAWKEYE® can be viewed by going to Ruger.com/TechTips.

1. **Keep the rifle pointed in a safe direction!** Put the safety in the “Load-Unload” position.
2. **CHECK TO BE CERTAIN THAT THE CHAMBER AND MAGAZINE ARE EMPTY.**
3. **To remove the bolt:** Open bolt and pull to the rear while at the same time pivoting open the bolt stop which is located on the left side of the receiver on the right-handed version and the right side of the receiver on the left-handed version. This is as far as you need to dismantle the rifle for a routine cleaning. It is rarely necessary to proceed further.
4. **To remove firing pin assembly from bolt:** With bolt out of the rifle and firing pin cocked, insert a pin or nail into the “disassembly hole” in the cocking piece.

NOTE: The pin or nail should be as close as possible in size to the hole diameter, and at least 2 inches long so that it can be used to ‘lever’ the firing pin to the rear when reassembling the firing pin assembly into the bolt. Unscrew firing pin assembly and remove from bolt. (Caution: Do not remove the restraining pin until firing pin assembly is reassembled into bolt).



CAUTION: The firing pin assembly is intended to be a permanent assembly and should not be disassembled. The parts are under great spring pressure and if disassembled could fly apart with sufficient force to cause serious injury. Also, special tools are required to correctly reassemble this part.

5. **To remove stock:** Open floorplate and while holding it up out of the way, loosen and remove the screw that holds the floorplate hinge assembly. Next, loosen and remove the screw that is just forward of the trigger guard. Remove trigger guard. Remove magazine box. (If magazine box does not come out readily, do not force it. It can be lifted out with the barrel-receiver assembly, but it must be done with great care.) Lift barrel from the stock very carefully. Lift the receiver at the same time as the barrel is lifted so that the barrel-receiver comes out of the stock level and not at an angle.
6. **To remove the trigger:** (Safety Selector should be in the “Fire” position.) While holding the trigger in place, press out the trigger pivot pin. (Caution: Trigger is spring loaded.)

7. To remove the sear:

- a. Press out the sear pivot pin.
- b. Turn receiver upside down and slide sear forward. Sear will drop out of the top slot in the receiver.

8. To remove safety assembly:

- a. Rotate the safety selector so that the upper section is positioned fully over the center of the receiver tang.
- b. While holding the safety selector in place with thumb and forefinger, slide the retainer up out of receiver. (Caution: Safety Selector is under spring tension from a spring and plunger acting against the lower section of the safety selector. The spring and plunger will jump out if not contained.)
- c. Lift out the safety selector.
- d. Remove the safety selector detent and safety selector detent spring.

REASSEMBLY

(AGAIN, BE SURE RIFLE IS UNLOADED)

1. To replace the safety assembly:

- a. Place the safety selector detent and safety selector detent spring into the hole in the receiver.
- b. Set the safety selector in place with its upper section positioned over the center of the receiver tang.
- c. While holding the safety selector in place with thumb and forefinger while applying downward pressure, slide the safety selector retainer into dovetail from the top. Align the notch in the safety selector retainer with the sear pivot pin hole.

2. To replace the sear:

- a. Place the rear end (the end with the hole in it) of the sear into the slot from the top of the receiver. Swing the rear end of the sear up and slide the sear into position until the hole in the sear is aligned with the mating holes in the receiver.
- b. Insert the sear pivot pin.

3. To replace the trigger:

- a. Place the trigger/sear spring over the dimple in the trigger.
- b. Assemble the trigger while aligning the spring with the dimple on the sear.
- c. While holding the trigger in position, replace the trigger pivot pin.

4. To replace the stock:

- a. Install magazine box on receiver.
- b. Place barrel-action assembly – with magazine box in place – into stock.
- c. Replace trigger guard and loosely install screws.
- d. Install floorplate hinge assembly and tighten the screw to 95 in-lbs. (This screw is angled and draws the barrel-action assembly into the bedding surface of the stock.)
- e. Tighten the two trigger guard screws as follows: Do not tighten one screw all the way and then tighten the other. Instead, alternately tighten each one – a partial turn at a time – so that the screws will be tightened equally until both are snugly tightened.

5. To reassemble firing pin assembly into bolt:

Screw the assembly fully into the bolt. The assembly is properly positioned in the bolt when the flat on the bottom right side of the bolt sleeve (front of bolt facing you) is aligned with the flat on the bottom end of the bolt handle. Note: There is a shallow notch on the rear end of the bolt body – at the end of the cam cut – into which the nose of the cocking piece ‘fits.’ When the firing pin assembly is being turned into the bolt body, it may be necessary to use the restraining pin as a lever to slightly retract the cocking piece nose so it can be moved into the notch. When the firing pin assembly is correctly positioned in the bolt body, the restraining pin can be removed, but not before!

6. To replace bolt:

- a. With bolt handle in an upward position and bolt head away from you, align the extractor with the right hand locking lug in the right-handed version or the left locking lug in the left-handed version. Align the locking lugs with the channels in each side of the rear of the receiver and partially insert the bolt.
- b. Push the bolt fully forward.

REGARDING ACCURACY: The accuracy of any rifle can vary depending upon the make and type of cartridges used in it. Such being the case, if your RUGER® M77® HAWKEYE® or RUGER® GUIDE GUN rifle does not perform to expectations, it is advisable to try several brands and types of cartridges to determine which one delivers the best accuracy, before proceeding further. If your rifle is not as “accurate” as you believe it should be, before concluding that some serious fault exists, run the following checks:

1. Be certain the two trigger guard screws and the floorplate hinge screw are snugly tightened as described in Step 4, p. 20, of the “Reassembly” section of this manual.
2. Be certain the bore is clean and free from accumulated metal fouling (deposited by metal jacketed and lead bullets). See the “Care and Cleaning” section of this manual, p. 22.
3. Check the sights for tightness, setting and alignment.

If everything is tight, the bore is clean, the sights are properly aligned and secure but the accuracy problem persists, DO NOT alter the stock bedding in any way. Do not scrape away wood and do not bed with “glass,” plastic, epoxy, etc. Once a rifle stock has been altered, it cannot be reworked by our Customer Service Department.

If you still have an accuracy problem, write a brief letter to our Customer Service Department in Newport, New Hampshire 03773 and describe the nature of the problem based on the use of factory-loaded cartridges – not reloads. You will receive a prompt response from us and if indicated, detailed instructions with regard to the return of the rifle.

CARE AND CLEANING

BEFORE CLEANING, BE CERTAIN THE RIFLE AND ITS MAGAZINE ARE UNLOADED.

An on-line video demonstrating the proper cleaning procedure of the RUGER® M77® HAWKEYE® can be viewed by going to Ruger.com/TechTips.

A firearm must be free of rust, dirt, grease and firing residues to function safely and reliably. Periodic maintenance, which includes inspection of components to determine if they are in proper working order, is absolutely essential. Firing deposits particles of bullet lubricant and powder in the bore, chamber, bolt, receiver, magazine and other parts of the rifle. There is no fixed rule as to how frequently the cleaning should be carried out, but the alert gun owner soon learns that any firearm functions most reliably and accurately when it is free of accumulations of grease and other firing residues.

Basic cleaning equipment includes: A correct size cleaning rod equipped with bore brushes (fiber and brass) and a tip in which a cloth patch can be inserted, patches, powder solvent, lubricant, small lint-free cloths and a toothbrush. Use correct size patches and brushes. Larger sizes will bind in the bore and can be very difficult to remove! Insert rod from the chamber end of the barrel and push firmly so the patch or brush emerges from the muzzle. Don't reverse the rod when a brush or patch is being used – it may bind. Don't use patches or brushes dripping with solvent or oil. Use rod and brushes with care so as not to damage gun.

1. For routine cleaning it is necessary only to remove the bolt and open the floorplate.
2. Push-pull a properly sized, solvent-wetted patch through the bore several times. Then attach a solvent-wetted bristle brush to a cleaning rod and run it back and forth the full length of the bore as many times as necessary to remove grease and dirt from the bore and chamber. Dry the bore with clean patches and examine it. If bore remains fouled, repeat the brushing. Complete the cleaning by dry-patch wiping of bore and chamber.
3. Use a clean, solvent-wetted patch to remove firing residue and dirt from all "reachable" surfaces inside the receiver. Use the solvent-wetted toothbrush to dislodge caked dirt from all parts of the bolt assembly and from surfaces inside the receiver that can't be reached with a patch. Use cleaning patches or the cloth to remove the solvent.
4. Wipe all surfaces – internal and external – with a very light coat of oil. Oil and similar preparations "collect" dirt particles which can interfere with reliable functioning of the rifle. Therefore, use these preparations very sparingly. A drop of oil applied to the bolt assembly components, the pivot points of the trigger mechanism, the safety, the bolt stop, and the magazine latch, will work into all the parts that need lubrication.
5. Reassemble the rifle and carefully wipe all solvent, lubricating and preservative preparations from the stock.
6. If the rifle is to be stored for an extended period, clean the rifle thoroughly. Disassemble to the extent described elsewhere in this manual, taking care to put pins and similar easily mislaid and "rolling" components in a tray. Rewipe all surfaces with preservative oil. Reassemble and store properly.

! WARNING – LUBRICATION	
	<p>Firing a rifle with oil, grease, or any other material even partially obstructing the bore may result in damage to the rifle and serious injury to the shooter and those nearby. Do not spray or apply lubricants directly on ammunition. If the powder charge of a cartridge is affected by the lubricant, it may not be ignited, but the energy from the primer may be sufficient to push the bullet into the bore where it may become lodged. Firing a subsequent bullet into the obstructed bore may damage the rifle and cause serious injury or death to the shooter and those nearby. Use lubricants properly. You are responsible for the proper care and maintenance of your firearm.</p>
IMPROPER LUBRICATION DESTROYS GUNS	

STORAGE

GUNS SHOULD NOT BE STORED LOADED!

<p>USE THE LOCKING DEVICE SUPPLIED WITH THE RIFLE TO RENDER IT INOPERATIVE FOR SAFE STORAGE.</p> <p>(SEE PAGE 8)</p>
--

Do not store the rifle in a leather case or scabbard. Leather attracts moisture, even though it may appear to be dry.

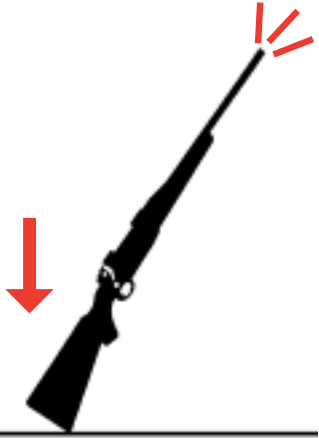
! WARNING – STORAGE	
	<ul style="list-style-type: none"> • Never place or store any firearm in such a manner that it may be dislodged. Firearms should always be stored securely and unloaded, away from children and careless adults. • Use the locking device supplied with the rifle for storage. The use of a locking device or safety lock is only one aspect of responsible firearms storage. • For increased safety, firearms should be stored unloaded in a location that is both separate from their ammunition and inaccessible to children and any other unauthorized person.
STORE SECURELY & UNLOADED	

MAINTENANCE OF STAINLESS STEEL RIFLES

Firearms and components made of stainless steel are relatively more resistant to corrosion than those of blued steel. However, in the interest of proper operation and long life of a stainless steel firearm, inspect it frequently and clean, lubricate and apply an appropriate rust preventative.

Sometimes discoloration occurs from perspiration or from contact with some types of gun cases. Rusting may occur as a result of the firearm being exposed to moisture, salt air or chemicals.

Minor discoloration can usually be removed by rubbing the stainless area with an abrasive ink eraser, crocus cloth, or a "metal polishing" compound. When using any of these abrasives, proceed with care and use light pressure to achieve a blending of "color" with those areas that are not discolored.

External surfaces most subject to rusting from handling, or from exposure to the elements should be cleaned and wiped dry after use or after exposure to adverse conditions. If the rifle is to be stored, coat it with a light film of oil or preservative. Where the rifle is in continuing use, and the presence of oil or grease would be objectionable, then the external surfaces can be coated (after cleaning and drying) with a paste wax formulated for use on metals. Apply the wax sparingly, allow time for it to dry hard, then buff lightly with a soft cloth. When applying the wax, take care that it does not get into the mechanism or on the functioning parts or in the bore.

ATTACHING RUGER SCOPE RINGS

Each Ruger scope ring is a mated assembly of a top and a base. Do not mix the parts of the two ring assemblies as they are not interchangeable. On the underside of each mounting ring assembly there is an integral lug, located off center with respect to the front and back sides of the mount. The lug is nearer to the front surface. By reference to the lug, the mounting ring can be correctly assembled with the front of the ring toward the muzzle of the rifle.

1. Disassemble one ring and reassemble over the scope body between the turret and the eyepiece. Remember - the lug on the base should be on the front side of the scope.
2. Install the four top screws. Do not tighten.
3. Disassemble the other ring and install it on the forward section of the scope tube with the lug forwardly also. Install the four top screws. Again, do not tighten.
4. Assemble the rings to the receiver with the lugs engaging the recesses in the top surface of the receiver. Tighten the clamp nuts so that the rings are locked to the semicircular cuts on the sides of the receiver.
5. Rotate the scope until cross-hairs are aligned properly and slide scope to desired eye relief. Then tighten the eight top screws each a bit at a time to grip the scope body.
6. Sight in according to the directions with your scope.

LENGTH OF PULL ADJUSTMENT

Each RUGER® GUIDE GUN comes from the factory with three 1/2" spacers (one installed on the rifle and two packaged separately) that allow you to adjust the length of pull from 12-3/4" to 14-1/4" in one-half-inch increments. As shipped from the factory with a single spacer installed, the length of pull is set at 13-1/4".

To adjust the length of pull, simply add or remove spacers, as desired. To add or remove spacers, use the allen wrench supplied with the rifle to remove the recoil pad screws affixing the recoil pad to the stock. (See Figure 7). Add (by stacking) or remove spacers to achieve the desired length of pull. Now reattach the recoil pad by installing the recoil pad screws using the allen wrench. Be careful not to overtighten the screws, which should just be snugged in place by turning the screws an additional 1/2 turn after the screw makes contact with the recoil pad.

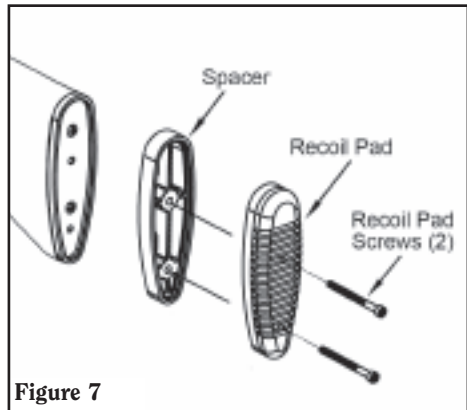

Figure 7

SIGHT PICTURE AND ADJUSTMENT FOR "AFRICAN" AND GUIDE GUN MODELS ONLY

Both the Ruger "African" and Guide Gun bolt action rifles are equipped with a fixed elevation rear sight set for approximately 50 yards.

Lateral (windage) adjustment is made by loosening the rear sight blade lock screw (located in front of the rear sight blade) and carefully moving the blade in the direction you wish to move the bullet's point of impact. Tighten the screw securely before shooting the rifle. Repeat as necessary until the rifle is zeroed.

SIGHT PICTURE FOR "AFRICAN" AND GUIDE GUN MODELS

Front sight bead center in V-notch of rear sight. Target placed directly above bead.



SERVICE AND PARTS POLICY

If you have any question with regard to the performance of your RUGER® M77® HAWKEYE® or GUIDE GUN rifle please write or call (336-949-5200) our Customer Service Department in Newport, New Hampshire 03773, fully describing all circumstances and conditions involved. If you should return your rifle to the factory for repair, or order parts for it, please comply with the following suggestions for prompt service:



WARNING: BEFORE SHIPPING ANY FIREARM, BE ABSOLUTELY CERTAIN THAT IT IS UNLOADED. DO NOT SHIP CARTRIDGES WITH A FIREARM.

SHIPPING FIREARMS FOR REPAIR

RUGER® M77® HAWKEYE® or GUIDE GUN rifles returned to the factory for repair should be sent to: Ruger, Customer Service Department, 411 Sunapee Street, Newport, New Hampshire 03773. **NOTE: You must obtain a Repair Authorization Number before returning your firearm.** An authorization number can be obtained by contacting Customer Service online at www.ruger.com or calling the Customer Service Dept. at 336-949-5200. Guns should be sent prepaid. We will not accept collect shipments.

The Federal Gun Control Act, as well as the laws of most states and localities, do not prohibit an individual (who is not otherwise barred from purchasing or possessing a firearm) from shipping a firearm directly to the manufacturer for repair. However, before you ship your rifle to us, be certain that your state or locality does not have a law or regulation which will prohibit you from receiving the rifle from us after it has been repaired. If such receiving is prohibited, then please have a federally licensed firearms dealer ship the gun to us. If your rifle is sent to us by a dealer, it will be returned to that dealer after being repaired. If a handgun (pistol or revolver) is shipped by an individual who does not hold a Federal Firearms License, it must be shipped for overnight delivery via U.P.S., Federal Express or other, similar private overnight service. NOTE: Handguns may not be shipped via U.S. Mail. Persons who do not hold a Federal Firearms License are prohibited by Federal law from shipping a handgun by Mail. Handguns mailed in violation of the law are impounded by the Post Office. Rifles and shotguns may be shipped via U.S. Mail. **DO NOT SEND GUN BOXES OR LITERATURE THAT YOU CONSIDER TO BE COLLECTOR'S ITEMS – THESE ARE INVARIABLY DAMAGED OR DESTROYED IN SHIPMENT.** Please do not include rifle case, sling, telescopic sights or custom accessories with a firearm being shipped to the factory for service. Always insure your shipment.

Enclose a letter which includes your name, address, telephone number, serial number, model of the firearm, and your repair authorization number. Describe in detail the trouble you have experienced with your firearm, or the work you wish to have done. Merely stating that the firearm “needs repair” is inadequate information.

All work performed is subject to a minimum labor charge and charges for shipping and handling. Most models can be reblued, but custom gunsmithing service or nonstandard alterations are NOT AVAILABLE from Ruger Customer Service Departments. Please contact the Customer Service Department for pricing information.

! WARNING – PARTS PURCHASERS	
	<ul style="list-style-type: none"> • It is the purchaser's responsibility to be absolutely certain that any parts ordered from the factory are correctly fitted and installed. • Firearms are complicated mechanisms and IMPROPER FITTING OF PARTS MAY RESULT IN A DANGEROUS MALFUNCTION, DAMAGE TO THE FIREARM, AND SERIOUS INJURY TO THE SHOOTER AND OTHER PERSONS. • The purchaser and installer of parts must accept full responsibility for the correct adjustment and functioning of the firearm after such installation.
PARTS MUST FIT CORRECTLY	

ORDERING PARTS

Please contact the New Hampshire Customer Service Department for parts availability and current prices. All parts orders for the RUGER® M77® HAWKEYE® or GUIDE GUN rifles should be sent to: Ruger Customer Service Department, 411 Sunapee Street, Newport, New Hampshire, 03773, 336-949-5200. We cannot comply with open account or C.O.D. requests. Payment in full via credit card (Visa or MasterCard only), money order or certified bank check (no personal checks or cash, please) is required before any service will be performed. Please provide your credit card number, your name as it appears on the credit card, the expiration date, and the 3-digit security code. All parts orders are subject to a minimum charge and charges for shipping and handling. Order parts by ***Part Name and specify the model and entire serial number*** of the firearm for which the parts are being ordered. There is a minimum labor charge plus a shipping and handling charge if the parts are factory fitted. All factory fitted parts are fit on an exchange basis only. We will not return the replaced parts. Please contact the Customer Service Department for pricing information.

Because the receiver of the bolt-action rifles is a serial numbered component, it is defined as a "firearm" by Federal law and is not sold as a separate component.

*Parts designated by an asterisk must be factory fitted. These parts are fitted on an exchange basis only. We will not return the replaced parts. We will not return any part that is broken, malfunctioning, badly worn or has been modified. See "Warning — Parts Purchasers," above.

! WARNING:	Firearm users are cautioned that a gun containing broken, malfunctioning, or badly worn parts should not be fired.
-------------------	---

RUGER® M77® HAWKEYE® RIFLE

PARTS LIST

Design, prices and specifications subject to change without notice.

SPECIFY MODEL AND CALIBER WHEN ORDERING

(See Exploded View on Page 33)

NOTE: Component parts for the “Alaskan” and “African” Models are NOT ILLUSTRATED.

Part Name	Part No.	Model
* Barrel		Contact NH Service Dept. for barrel replacement.
* Bolt Assembly, Complete		Contact NH Service Dept. for bolt assembly replacement.
Bolt Stop	D-53	All Blued Models
Bolt Stop	KD-53HM	All Stainless Models
Bolt Stop	D-53AB	“Alaskan” Model
Bolt Stop Plunger	D-56	All Blued Models
Bolt Stop Plunger	KD-56	All Stainless Models
Bolt Stop Plunger	KD-56AB	“Alaskan” Model
Bolt Stop Plunger Spring	D-57	All Models
Bolt Stop Plunger Spring Retaining Pin	D-59	All Blued Models
Bolt Stop Plunger Spring Retaining Pin	KD-59	All Stainless Models
Bolt Stop Stud Bushing	D-55	All Blued Models
Bolt Stop Stud Bushing	KD-55	All Stainless Models
Bolt Stop Screw Stud - Blued Models	D-54	All Blued Models
Bolt Stop Screw Stud	KD-54HM	All Stainless Models
Bolt Stop Screw Stud	KD-54AB	“Alaskan” Model
Center Mounting Screw	D04750	All Blued Models
Center Mounting Screw	KD04700	All Stainless Models

Part Name	Part No.	Model
Cocking Piece, Not Illustrated - Blued	D01810	"African," Standard, Ultra Light, Compact
Cocking Piece, Not Illustrated - Stainless	KD01810HM	Ultra Light, Sporter, Compact
Cocking Piece, Not Illustrated	D01810AB	"Alaskan" Model
Ejector		Contact NH Product Service Dept. for ejector replacement.
Ejector Spring	KD00900	All Models
Extractor		Contact NH Product Service Dept. for extractor.
Extractor Band	KD-15HM	All Models
Extractor Band	KD-15AB	"Alaskan" Model
* Firing Pin Assembly		Contact NH Product Service Dept. for firing pin assembly replacement.
Firing Pin Cross Pin	D-19	All Models
Firing Pin Spring	D01202	All Models
Floor Plate Assembly - Satin Finish,	KD20511	All Models with Laminated Stocks
Long Action		
Floor Plate Assembly		Contact NH Product Service Dept. for floor plate assembly replacement.
Floor Plate Hinge - Blued Models	D-7	"African," Standard, Ultra Light, Compact
Floor Plate Hinge - Stainless Models	KD-7HM	Ultra Light, Sporter, Compact
Floor Plate Hinge	D-7AB	"Alaskan" Model
Floor Plate Latch - Blued Models	D03100	"African," Standard, Ultra Light, Compact
Floor Plate Latch - Stainless Models	KD03100HM	Ultra Light, Sporter, Compact
Floor Plate Latch	D03100AB	"Alaskan" Model
Floor Plate Pivot Pin	D-6	All Blued Models

Part Name	Part No.	Model
Front Plate Pivot Pin	KD-6	All Stainless Models
Front Mounting Screw	D04650	All Blued Models
Front Mounting Screw	KD04601	All Stainless Models
Front Sight Base - Stainless	KS06500	Stainless Models w/Sights
Front Sight Base Set Screw	D-70	Standard & Sporter Models w/Sights
Front Sight Blade	D06713	"African"
Front Sight Blade	D06712	"Alaskan"
Front Sight Plunger Spring	D-69	Standard & Sporter Models w/Sights
Front Sight Retainer Plunger	D-68	Standard & Sporter Models w/Sights
Front Sling Swivel Screw	S-86B	Standard, Ultra Light, Sporter, Compact
Magazine Box - Long Action	D22707	Specify Model & Caliber
Magazine Box - Short Action	D22700	Specify Model & Caliber (except 22-250)
Magazine Box - Short Action	D22710	22-250 Caliber Only
Magazine Follower, with tab - Long Action	KD03023	Specify Model & Caliber
Magazine Follower, with tab - Short Action	KD03025	Specify Model & Caliber (except 22-250)
Magazine Follower - Short Action	D-147	22-250 Caliber Only
Magazine Latch Spring	D-32	All Models
Magazine Spring - Short Action	D-149	22-250 Caliber Only
Magazine Spring	D-148	All Models except 22-250 Caliber
Pistol Grip Cap - Plastic	D08001	"African," Standard, Ultra Light, Sporter, Compact
Pistol Grip Cap Medallion	D-82	Standard, Ultra Light, Sporter, Compact
Pistol Grip Cap Screw	C-96SM	Standard, Ultra Light, Sporter, Compact
Rear Mounting Screw	D04850	"African," Standard, Ultra Light, Compact - Blued Models
Rear Mounting Screw	KD04800HM	Ultra Light, Sporter, Compact - Stainless Models

Part Name	Part No.	Model
Rear Mounting Screw	D04850	"Alaskan" Model
Rear Sight Base	D-151	"African" Model
Rear Sight Base	D-151AB	"Alaskan" Model
Rear Sight Base Screw	D-62	"African" Model
Rear Sight Base Screw	D-62AB	"Alaskan" Model
Rear Sight Blade	D07725	"African" & "Alaskan" Models
Rear Sight Clamp Screw	D-64	"African" Model
Rear Sight Clamp Screw	D-64AB	"Alaskan" Model
Rear Sight Williams Gib Lock Clamp	D-83	"African" Model
Rear Sight Williams Gib Lock Clamp	D-83AB	"Alaskan" Model
Rear Sling Swivel Stud	S-87	All Models
Recoil Pad	D06313	All Blued Models
Recoil Pad (Not Illustrated)	D06318	Synthetic Stock Models
Recoil Pad Screw, 2 Req'd	D-84	All Models
Recoil Pad Screw, 2 Req'd	B-91	Standard & Ultra Light Models with Synthetic Stock
* Safety Selector - Blued Models	J03800HM	Standard, Ultra Light, xCompact
* Safety Selector - Stainless Models	KJ03800HM	Ultra Light, Sporter, Compact
* Safety Selector	J03800AB	"Alaskan" Model
Safety Selector Detent	J04300	All Models
Safety Selector Detent Spring	D-32	All Models
* Safety Selector Retainer - Blued Models	J02100	"African," Standard, Ultra Light, International, Compact

Part Name	Part No.	Model
* Safety Selector Retainer - Stainless Models	KJ02100	Ultra Light, Sporter, Compact
* Safety Selector Retainer	J02100AB	"Alaskan" Model
Scope Base Clamp	D-74	All Blued Models
Scope Base Clamp	KD-74M	All Stainless Models
Scope Base Nut	D-73	All Blued Models
Scope Base Nut	KD-73M	All Stainless Models
Scope Base Torx® Head Screw, 8 Req'd	MPF07602	All Blued Models
Scope Base Torx® Head Screw, 8 Req'd	KMPF07602	All Stainless Models
Scope Ring, Medium, Front	4BHM	All Blued Models
Accommodates 42mm Lens		
Scope Ring, Medium, Rear	5BHM	All Blued Models
Accommodates 42mm Lens		
Scope Ring, Medium, Front	4KHM	All Stainless Models
Accommodates 42mm Lens		
Scope Ring, Medium, Rear	5KHM	All Stainless Models
Accommodates 42mm Lens		
* Sear	KD02309	All Models
Sear Pivot Pin	D04200	All Models
Stock Torx® Key Wrench, Not Illustrated	MPF07601	Contact NH Product Service Dept. for stock replacement.
(for scope base Torx® Head Screw)		All Models
* Trigger	KD02024HM	"African," "Alaskan," Standard, Ultra Light, Sporter, Compact
Trigger Guard Assembly	D20202	"African," Standard, Ultra Light, Compact - Blued Models
Trigger Guard Assembly	KD20201HM	Ultra Light, Sporter, Compact - Stainless Models
Trigger Guard Assembly	D20202AB	"Alaskan" Model
Trigger Pivot Pin	D02100	All Models
Trigger/Sear Spring	J02400	All Models

* PARTS SO MARKED MUST BE FACTORY FIT.

RUGER® M77® HAWKEYE® RIFLE EXPLODED VIEW

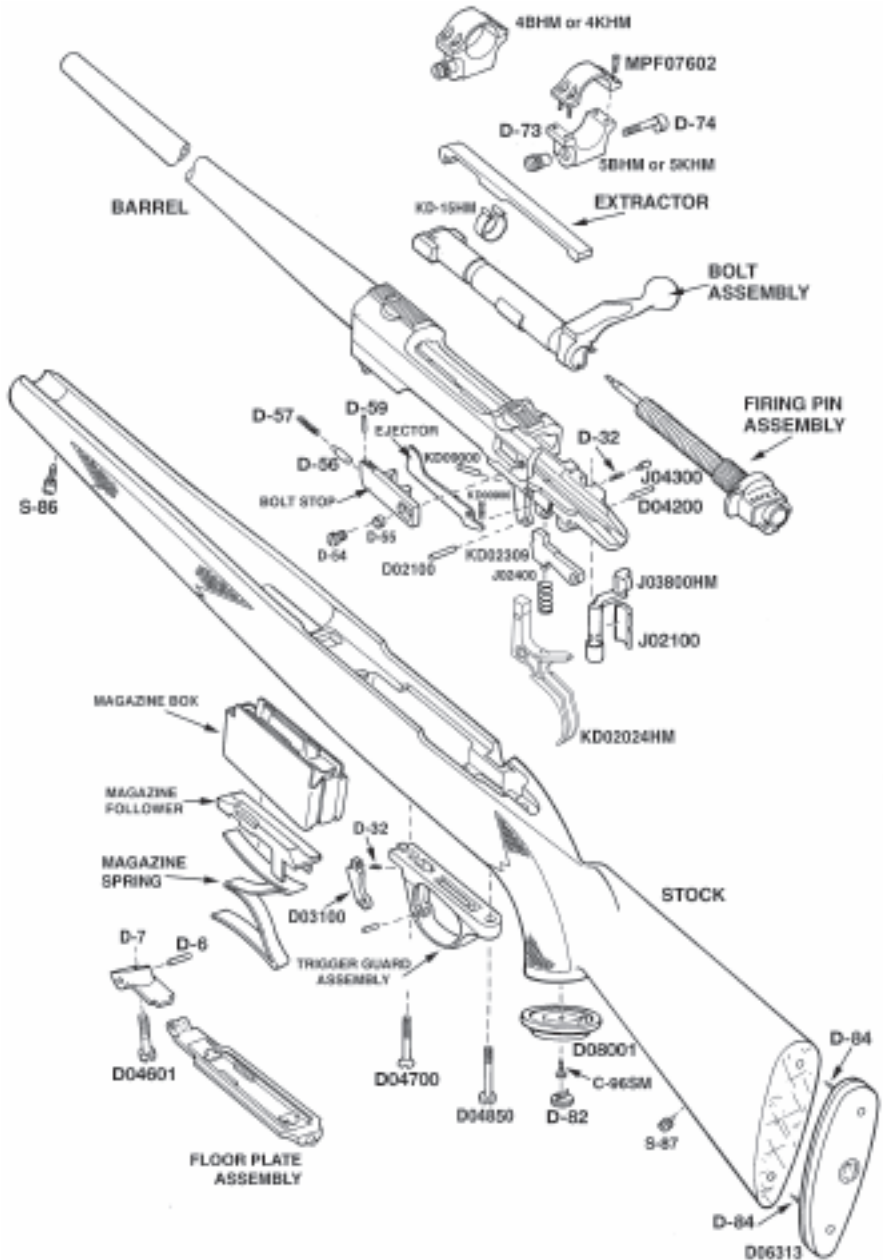

RUGER® MUZZLE BRAKE SYSTEM

SUPPLEMENTAL PARTS LIST

(FOR RIFLES SO EQUIPPED)

Key No.	Part Name
1	Muzzle Cap
2	Muzzle Brake
3	Muzzle Weight

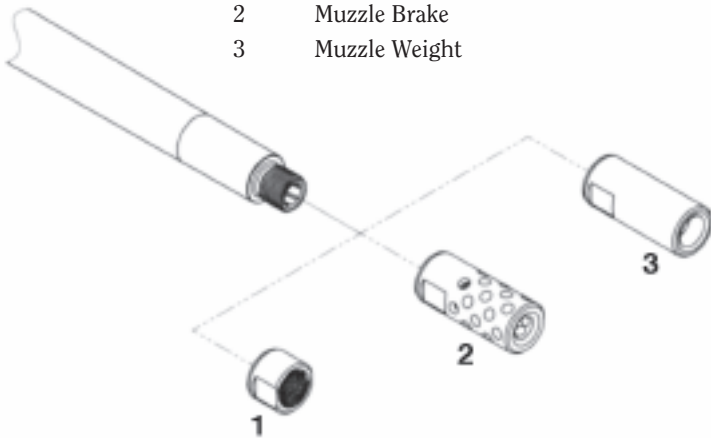

RUGER® GUIDE GUN & FTW HUNTER THREAD PATTERNS

Model	Caliber	Thread Pattern
Guide Gun	300 RCM	1/2"-24
Guide Gun	338 RCM	1/2"-32
Guide Gun & FTW Hunter	300 Win Mag	1/2"-24
Guide Gun	338 Win Mag	1/2"-32
Guide Gun & FTW Hunter	30-06 Sprg	1/2"-24
Guide Gun & FTW Hunter	375 Ruger	5/8"-18
Guide Gun	416 Ruger	5/8"-28
FTW Hunter	308 Win	1/2"-24
FTW Hunter	6.5 Creedmoor	1/2"-24
FTW Hunter	7mm Rem Mag	1/2"-24
FTW Hunter	260 Rem	1/2"-24

THE BASIC RULES OF SAFE FIREARMS HANDLING

We believe that Americans have a right to purchase and use firearms for lawful purposes. The private ownership of firearms in America is traditional, but that ownership imposes the responsibility on the gun owner to use his firearms in a way which will ensure his own safety and that of others. When firearms are used in a safe and responsible manner, they are a great source of pleasure and satisfaction, and represent a fundamental part of our personal liberty.

Firearms do not cause accidents! Firearms accidents are almost always found to have been the result of carelessness or ignorance on the part of the shooter of the basic rules of safe gun handling.

The following rules must be observed by gun users at all times. Safe gun handling is not just desirable, it is absolutely essential to your safety, the safety of others, and the continuation of gun ownership and sport shooting as we know it today.

1. LEARN THE MECHANICAL AND HANDLING CHARACTERISTICS OF THE FIREARM YOU ARE USING.



Not all firearms are the same. The method of carrying and handling firearms varies in accordance with the mechanical provisions for avoiding accidental discharge and the various proper procedures for loading and unloading. No person should handle any firearm without first having thoroughly familiarized himself with the particular type of firearm he is using, and with safe gun handling in general.

2. ALWAYS KEEP THE MUZZLE POINTED IN A SAFE DIRECTION.



Be sure of the bullet stop behind your target, even when dry-firing. Never let the muzzle of a firearm point at any part of your body or at another person. This is particularly important when loading or unloading a firearm. In the event of an accidental discharge, no injury can occur as long as the muzzle is pointing in a safe direction. A safe direction means a direction that will not permit a discharged bullet to strike

A safe direction must take into account the fact that a bullet may penetrate a wall, ceiling, floor, window, etc., and strike a person or damage property. Make it a habit to know exactly where the muzzle of your gun is pointing whenever you handle it, and be sure that you are always in control of the direction in which the muzzle is pointing, even if you fall or stumble. Keep your finger off the trigger until you are ready to shoot.

3. FIREARMS SHOULD BE UNLOADED WHEN NOT IN USE.

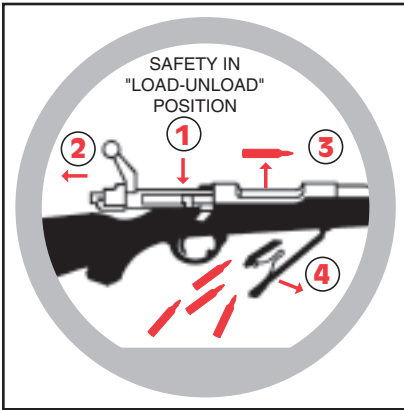

Firearms should be loaded only when you are in the field or on the target range or shooting area, ready to shoot. Firearms and ammunition should be securely locked in safes, racks or cabinets, or by using the locking device supplied with the firearm, when not in use. Ammunition should safely be stored separate from firearms. Store your firearms out of sight of visitors and children. It is the gun owner's responsibility to be certain that children and

persons unfamiliar with firearms cannot gain access to firearms, ammunition, or components.

4. BE SURE THE BARREL IS CLEAR OF OBSTRUCTIONS BEFORE SHOOTING.

Even a bit of mud, snow or excess lubricating oil or grease in the bore may cause the barrel to bulge, or even burst on firing, and can cause serious injury to the shooter and bystanders. Be sure that you are using ammunition of the proper caliber and loading for the gun you are using. If the report or recoil on firing seems weak, or doesn't seem quite right, **CEASE FIRING IMMEDIATELY**, unload your firearm, and check to be sure that no obstruction has become lodged in the barrel. Never try to shoot out an obstruction!





5. BE SURE OF YOUR TARGET BEFORE YOU SHOOT.

Don't shoot unless you know exactly where your bullet is going to strike. Be sure of the bullet stop behind your target, even when dry-firing with an unloaded gun. If you are in the field hunting, do not fire at a movement or noise. Take the time to be absolutely certain of your target before you pull the trigger.

6. WEAR SHOOTING GLASSES AND HEARING PROTECTION WHEN YOU SHOOT.

All shooters should wear protective shooting glasses and adequate hearing protection when shooting. Exposure to shooting noise can damage hearing, and wearing adequate eye protection when shooting is essential.



7. NEVER CLIMB A TREE OR FENCE WITH A LOADED FIREARM.

Put the firearm down carefully before climbing a fence, and unload it before climbing or descending a tree or jumping over a ditch or other obstruction. Never pull or push a loaded firearm toward yourself or another person. When in doubt, or whenever you are about to do anything awkward, unload your gun!

8. DON'T SHOOT AT A HARD SURFACE OR AT WATER.

Bullets can glance off many surfaces like rocks or the surface of water and travel in unpredictable directions with considerable velocity.



9. NEVER TRANSPORT A LOADED FIREARM.

Firearms should always be unloaded before being placed in a vehicle. A suitable carrying case or scabbard should be used to carry an unloaded firearm to and from the shooting area.

10. AVOID ALCOHOLIC BEVERAGES WHEN SHOOTING.

Don't drink until the day's shooting is over. Handling firearms while under the influence of alcohol in any form, or medications that could affect your judgment or coordination, constitutes a criminal disregard for the safety of others.



A BRIEF ACCOUNT OF AN EXTRAORDINARY ACHIEVEMENT: RUGER® FIREARMS

Sturm, Ruger & Company, Inc., had its beginning in a small machine shop occupying a rented frame building in Southport, Connecticut. In January, 1949, with an initial investment of only \$50,000 and an idea, William B. Ruger and Alexander M. Sturm started production of a .22 caliber autoloading pistol—a design which was so successful that it became the cornerstone upon which one of the most comprehensive lines of sporting firearms ever made in America was established. After Alex Sturm's death in 1951, William B. Ruger continued to direct the Company until his death in 2002. William B. Ruger, Jr. continued to provide guidance, which helped make this Company a sound and successful enterprise, until his retirement in 2006. The Company has continued to prosper, under new management and guidance from our Board, with new products and fresh perspectives.

Ruger, in this relatively short time, has established itself as a leading small arms design organization, developing a unique and broad line of fine quality sporting, military and police firearms to become one of the world's most famous producers of revolvers, pistols, rifles and shotguns. Since 1949, Ruger craftsmen have built many millions of firearms.

During its five decades of growth and progress under the leadership of William B. Ruger, the Company developed a business philosophy and implemented policies which represent a constructive influence in the life of modern America. From the beginning, Ruger played a positive role in conservation efforts and has supported the interests of shooters through such groups as the National Rifle Association, National Shooting Sports Foundation, and many regional sportsmen's organizations.

The Company has always endeavored to market its firearms for constructive and recreational purposes, to emphasize the traditional and responsible aspects of shooting, to render meaningful public services, and to encourage shooters in constructive, responsible, and safe participation in the shooting sports. Its motto, "Arms Makers For Responsible Citizens®," exemplifies this Company philosophy.

Today, Ruger® is particularly mindful of those elements which have contributed to the creation of its success, and extends heartfelt thanks to its many loyal employees and customers.

The firearms catalog, and instruction manuals for all Ruger® firearms, can be downloaded from our website at:

www.ruger.com

WHY NO WARRANTY CARD HAS BEEN PACKED WITH THIS NEW RUGER® FIREARM

The Magnuson-Moss Act (Public Law 93-637) does not require any seller or manufacturer of a consumer product to give a written warranty. It does provide that if a written warranty is given, it must be designated as "limited" or as "full" and sets minimum standards for a "full" warranty. Sturm, Ruger & Company, Inc. has elected not to provide any written warranty, either "limited" or "full", rather than to attempt to comply with the provisions of the Magnuson-Moss Act and the regulations issued thereunder. There are certain implied warranties under state law with respect to sales of consumer goods. As the extent and interpretation of these implied warranties varies from state to state, you should refer to your state statutes. Sturm, Ruger & Company wishes to assure its customers of its continued interest in providing service to owners of Ruger® firearms.



STURM, RUGER & COMPANY, INC.
411 SUNAPEE STREET
NEWPORT, NEW HAMPSHIRE 03773 U.S.A.
WWW.RUGER.COM

ARMS MAKERS FOR RESPONSIBLE CITIZENS®

**A COPY OF THE INSTRUCTION MANUAL FOR ANY RUGER®
FIREARM IS AVAILABLE FROM THE FACTORY FREE ON REQUEST, OR IT MAY BE
DOWNLOADED FROM OUR WEBSITE AT WWW.RUGER.COM.**

**THESE INSTRUCTION MANUALS CONTAIN IMPORTANT
WARNINGS WHICH MUST BE UNDERSTOOD
BEFORE USING THESE FIREARMS.**

The Following are Sturm, Ruger & Co., Inc. Trademarks: "BX-Trigger," "Bisley," Eagle Hard "R" logo holding gun, "Elite 452," "Gold Label," "I'm a Ruger American," "LC6," "LCR-357," "LC380CA," "Mark II," "Mark III," "Match Champion," "Model 96," "P345," "P345D," "P345FR," "P85," "P90," "P91," "P93," "P94," "P95," "P97," "R.I.O.S.," "Ruger Marksman Adjustable," "Ruger 77/50," "Ruger 10/17," "Ruger Titanium," "77/357," "Single-Seven," "SR45," "SR-556C," "SR-556VT," "SR-762," "10/22-FS," "This is Ruger. This is America.," "Tri-Flex," "22 Charger," "22/45," and "22/45 RP."

The Following are Registered U.S. Trademarks Belonging to Sturm, Ruger & Co., Inc.: Sturm, Ruger Logo, "AC-556," "AR-556," "Arms Makers For Responsible Citizens," "All-Weather," "Bearcat," "Blackhawk," "BX-15," "BX-25," Eagle 'R' - soft 'R' & hard 'R,' Eagle 'SR'," "Everything you need and nothing you don't.," "GP100," "Hawkeye," "It's Mine and It's American," "It's Mine. And It's American," "LC380," "LC9," "LC9s," "LC9s Pro," "LCP," "LCR," "LCRx," "M77," "Mini Thirty," "Mini-14," "9E," "Old Army," "Power Bedding," "Redhawk," "RUGER," "Ruger American Pistol," "Ruger American Rifle," "Ruger American Rimfire," "Ruger Hunting" - phrase & logo design, "Ruger Inside & Out" - phrase & logo design, "Ruger Precision Rifle," "Ruger 77/17," "Ruger 77/22," "Ruger 77/44," "Ruger SP101," "Ruger 10/22 Takedown" phrase & logo design, "Ruger 22/45 Lite," "Ruger Vaquero," "Rugged, Reliable Firearms," "Security-Six," "Service-Six," "Silent-SR," "Single-Nine," "Single-Six," "Single-Ten," "Speed-Six," the "SR" Design, "SR9," "SR9c," "SR40," "SR40c," "SR-22," "SR22," "SR-556," "SR-556E," "SR-556 Takedown," "SR1911," "Super Redhawk Alaskan," "Target Grey," and "10/22."