

# Lyman®



Dear Black Powder Shooter:

Congratulations on purchasing your new Lyman Black Powder Gun. All of our black powder products are the result of extensive thought and testing. With proper care, your new gun should bring you a lifetime of shooting pleasure. Before firing your gun, there are a few precautions that should be followed. Please read these instructions carefully.

1. If your new rifle is a flintlock, we have function tested the lock assembly, flint and frizzen to ensure that it provides proper ignition. Therefore, please do not be concerned with the resulting marks on the frizzen—it is simply a reminder of our comprehensive factory inspection.
2. The barrel's bore contains a heavy duty preservative that may resemble rusty oil. It is not rust! This preservative must be thoroughly removed before firing to obtain maximum accuracy.

**Directions:**

- A. Swab the bore with some form of solvent or penetrating oil (example: WD-40 or Hoppe's #9). Let soak overnight.
  - B. Brush out the following day using a nylon brush wrapped with 00 steel wool or a brass brush (must be under bore diameter to prevent bristles from jamming at the breech of the barrel).
  - C. Wipe out using soft flannel (avoid t-shirt material—it doesn't work well using cleaning jag and has a tendency to stay down the bore). The brass coloration you see is normal after cleaning.
3. The stock has been stained with oil leaving a dull finish. As with all oil finished stocks, rubbing in additional thin coats of oil (Linseed or Birchwood Casey's Tru-Oil) will further enhance the finish and protect the stock.

If you have any questions on these instructions, please call our customer service department at 1-800-22-LYMAN (except AK, HI, CT and foreign who may call 860-632-2020). We will be glad to provide whatever assistance you require.

Sincerely,

Your friends at Lyman Products

## SPECIAL PRODUCT INFORMATION– PLEASE READ

### Check List for Lyman Black Powder Guns

Upon opening the carton containing your Black Powder Gun you should find the following items.

	<b>Contents</b>
<b>Black Powder Model-Finished</b>	
Great Plains Rifle	Stock
Great Plains Hunter	Ramrod
Trade Rifle	Barrel
Deerstalker	Wedges (One for Trade & Deerstalker two for Great Plains)
	Primitive rear sight (Trade & Great Plains)
	Adjustable rear sight (Trade & Great Plains)
	Lyman 16AML & 37AML Sights (Deerstalker only)
	Cleaning Jag
	Flint (Flint models only)
<hr/>	
Great Plains Rifle Kit	Stock
Great Plains Rifle Flint Kit	Ramrod
	Barrel
	Wedges (One for Trade & Deerstalker two for Great Plains)
	Primitive rear sight
	Adjustable rear sight
	Cleaning Jag
	Flint (Flint Models only)
	Lock Assembly
	Trigger Assembly
	Trigger Guard
	Bag Containing Assembly Hardware
<hr/>	
Plains Pistol Finished	Assembled Gun
	Ramrod
	Polybag Containing: Cleaning Jag
	Lock Screw Bushing
<hr/>	
Plains Pistol Kit	Stock
	Barrel
	Lock Assembly
	Trigger Assembly
	Trigger Guard
	Ramrod
	Bag Containing Assembly Hardware
	Belt Hook
<hr/>	
Mustang Breakaway™ 209 Magnum	Stock
	Barrel
	Forend
	Fiber Optic Front & Rear Sights
	Scope Bases
	Ramrod

## SOME WORDS OF CAUTION

1. All Lyman black powder pistols and rifles are intended for use with black powder or Pyrodex only. Use of any other propellant can cause serious injury to the shooter and damage to the firearm. Never use smokeless powder.
2. Guard against overcharges. Follow the instructions and do not exceed suggested charges in this booklet.
3. Wear safety glasses when shooting black powder firearms. Shatterproof shooting glasses will protect the eyes from sparks, broken percussion caps, hot gases, and lead fragments.
4. Protect your hearing. Use ear plugs or muffs when firing any firearm.
5. Be certain the projectile is seated firmly against the powder charge. Any gap between the projectile and powder charge could cause serious damage to the firearm and injury to the shooter. Hunters, in particular, should check the position of the projectile in the barrel at regular intervals when in the field. Decap/deprime before checking, though.
6. Use only non-synthetic cloth patching of suitable thickness when loading round balls. ***Do not use Poly Patches or any synthetic wad with a round ball. The ball can separate and act as a bore obstruction.***
7. Never charge a muzzleloader directly from a powder flask. A sudden powder ignition from a lingering spark could cause the entire flask to explode. Instead, use an individual charge from a powder measure when loading your Lyman gun.
8. Never smoke when handling black powder.
9. Before each shooting session, check your black powder firearm carefully.
10. ***Before relying on the half-cock position, make sure the hammer will not fall when the trigger is pulled. Note: half-cock is not a "safety!"***
11. While on the firing line, keep all black powder canisters closed.
12. Keep spectators to the rear of the shooter. Standing beside a muzzleloader is not safe enough. Flames, hot gases and percussion cap fragments may fly from the side of the firearm causing injury.
13. Keep clear of the muzzle, particularly during loading.
14. If the gun misfires, keep the muzzle pointed down range for at least a minute before attempting to reprime it. There is always the chance a spark is smoldering in the powder charge and the gun could fire at any second.
15. Treat unprimed flintlocks as loaded weapons. Sometimes the sparks of an unprimed flintlock can fire the gun.
16. Use a non-flammable material to hold the flint in place. Cloth, cardboard or canvas could hold a lingering spark which might set off the next priming charge unexpectedly.
17. Store black powder and percussion caps in separate locations. Use their original containers when possible. Caps are sensitive to static electricity, percussion, heat and flame. Check local fire regulations before storing black powder in the home.
18. Follow the basic rules of firearms safety when handling any black powder firearm.
19. If you sell or give this Lyman black powder gun to someone else, give him this booklet too. Copies of this booklet are available from Lyman.

# FLINTLOCK AND CAPLOCK—HOW THEY WORK

## The Flintlock

Today's flintlock evolved around 1600 in Europe and was the most efficient lock for firearms use until the percussion system was perfected in the early 1800s. Even so, flintlock rifles remained in service in some of America's more rural areas until, perhaps, the turn of the century.

Simplicity of operation typifies the flintlock since all the shooter must have is a bit of priming powder and a flint for the hammer's jaws. This flint must be held securely and wrapping it in a bit of leather or thin sheet of lead gives the upper and lower jaws of the "cock" something to hold onto—and the flint as well.

The flintlock operates in the following manner: The hammer is placed on full cock, the pan is charged with either 4Fg or 3Fg powder and the frizzen is snapped down over the powder pan. Now the lock is ready for firing. Usually the hammer is lowered to half cock unless the shot will be taken immediately.

To fire the gun, the hammer is brought back to the full cock position, the gun raised and aimed—the trigger pulled. The hammer falls and the fireworks begin.

The flint strikes the face of the frizzen and this forceful scraping causes a shower of sparks—which are actually tiny pieces of molten metal from the frizzen face. These sparks drop into the powder pan and—usually—ignite the charge of priming powder. The flash of the igniting primer charge travels through the barrel's touch hole and ignites the main charge. In all cases, successful firing is contingent on having a sharp flint tightly held in the hammer, a clean hard face on the frizzen, fine dry powder in the pan, a clean touch hole and main charge properly loaded in good condition.

That is how the chain of events should go anyway. Sometimes the main charge decides to "play dead" and all the shooter gets is the poof of the igniting primer charge ... hence the old saying of "flash in the pan."

The flintlock isn't perfect but the shooter can go a long way towards minimizing most of the problems if he takes the time to understand the gun's needs. Here are some of the major points:

**Vulnerable Priming**—Wind and water can cause misfires without too much trouble. The solution lies in awareness of the problem and the possible use of a waterproof hood which fits over the lock area. Bullet lube or grease applied to the outer edge of the frizzen and powder pan will help to keep water away from the powder. Flints should be clamped tightly in the hammer's jaws and replaced when they are dull.

**Pan Flash**—This can be a real problem for any flintlock shooter since the eruption of the priming is a very real and spectacular event! The shooter can minimize this distraction by using priming powder sparingly.

**Long Lock Time**—Only practice and experience can teach the shooter to control his particular gun.

To the uninitiated the combination of a heavy hammer striking the springloaded frizzen (which snaps open adding yet another force to confound aiming efforts) and the resultant "whoosh" of the igniting primer charge is more than distracting. By the time the main charge goes off, the sights may be way off target and the shooter's eyes screwed shut while he wonders when all the commotion will stop!

**The solution? Keep practicing. Get to know your flintlock and take care of it. Wear shooting glasses for extra confidence and protection.**

1.

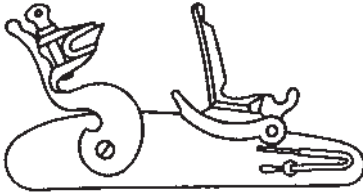

The flintlock is poised at full cock and ready for firing.

2.

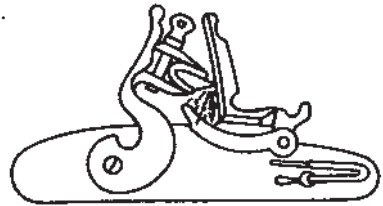

As the hammer falls, the leading edge of the flint makes initial contact with the face of the frizzen. The continuing force of the hammer starts to rock the springloaded frizzen back and up on its pivot. Sparks generated here are minor and probably offer very little to the ignition process.

3.

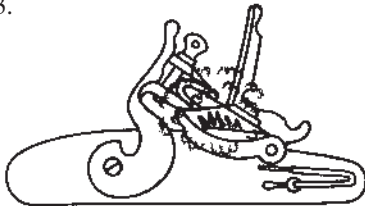

The hammer continues to fall and the direct blow of the flint against the frizzen changes to a heavy scraping of the frizzen by the flint. This produces a shower of sparks which start the ignition of the priming powder.

4.

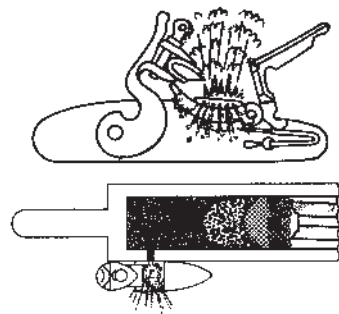

The priming is fully ignited and the main charge has just begun to burn. Typically, there will be a certain amount of the main charge pushed the barrel a ways behind the ball before the powder is consumed.



This Brown Bess was heavily primed and the resulting eruption has seriously distracted the shooter. Remember—use a light priming charge and wear safety glasses for extra confidence and protection.



Bicentennial skirmishers use a shield around the side of their powder pans to prevent touch hole blast from striking the shooter to their right. All flintlock shooters should be extra careful since this jet of gas is very hot and can easily injure someone.

## THE CAPLOCK

While the flintlock was a distinct improvement over the ignition systems it superseded, it did have its problems and, as is usual, experiments were conducted by a variety of people in America and Europe seeking an improved replacement. After several not-so-effective alternatives had been tried, the percussion system as we know it today was devised, proved and accepted. This new system was relatively impervious to the elements and offered the shooter faster lock time and less distracting primer ignition. The percussion lock was widespread by the 1830's/1840's.

The caplock is even simpler than the flintlock and is comprised of only three functioning components: Hammer, nipple and percussion cap. It works like this: With the gun loaded, the hammer is eased back to full cock and a small copper cap is pressed down over the nipple. This little cap contains a dab of fulminate sealed into the top. The cap is held firmly in place by the "skirts" or sides which are sized to grip the outside of the nipple.

To fire the piece, the hammer is brought to full cock and released by the trigger. The falling hammer hits home and crushes the fragile copper cap between the recessed hammer face and nipple, exploding the fulminate. The little spurt of flame is directed down inside the nipple along a flash channel leading through the side of the barrel into the main charge—which is then ignited.

The percussion system flourished only a few decades before the metallic cartridge was perfected and accepted, completely replacing the caplock system on all guns manufactured after the turn of the twentieth century—if not before. Today it is the most preferred muzzle-loading ignition system on the market. The percussion lock guns on today's market are very reliable providing the nipple channel is kept open and dry and the main charge is in good shape.

**Warning: Do not dry fire. This will damage the nipple.**

### HOW THE CAPLOCK WORKS



Draw the hammer to full cock. Firmly press a cap down over the nipple after glancing down the flash channel for obstructions. Lower the hammer to half-cock if the shot will not be made right away. Since your rifle is equipped with a fly, the hammer sear must be lowered past the half-cock notch and then brought back up and into the notch. **Half-cock is not a safety.**



NOTE: If the cap fits a bit loosely squeeze the sides, or skirts, a bit so they will grip the sides of the nipple and the cap will stay securely in place.

Ease the hammer back to full cock when you are ready to fire.

After firing the shot, leave the hammer down over the expended cap. This restricts the flow of air through the barrel and helps smother any sparks lingering after your last shot.

## HOW TO LOAD ... The Patched Roundball

Without a doubt, the most popular and widely used muzzle-loading projectile is the patched roundball. This combination of a soft lead sphere and a scrap of lubricated cloth is peculiarly American and has been with us ever since its worth was proven prior to and during our Revolutionary War.

Over the years different styles of rifling have been devised and used with some degree of success. Characteristics ran from extremely deep grooves to relatively shallow ones; from two or three lands to eight or more. Throughout this period and up through today the most constant single factor has been the patch around the ball—that hasn't changed ... nor has the lead ball, for that matter.

A roundball, whether fired from a rifle or a smoothbore, needs the patch to take up the slack, called "windage", between the ball and barrel walls. A properly fitted ball and patch will seal the bore and keep propellant gases behind the bullet where they do the most good. At the same time the ball is held rigidly in position and not allowed to wander from side to side as it speeds towards the muzzle. In a smoothbore this means the ball leaves the muzzle the same way each shot; it does the same in a rifle plus the ball is stabilized by the rifling and given a high degree of accuracy.

Use of the patched roundball in a single-shot pistol is virtually identical to its use in a long gun in terms of interior ballistics and loading operations.

Loading the patched roundball requires the same techniques regardless whether the gun is rifled or smoothbore, flintlock or caplock. The following preliminaries should be performed before the first charge of the day is poured down the barrel:

Since oil and any other form of moisture is the enemy of the successful black powder shooter, the bore and chamber area should receive a good cleaning just before the gun is loaded. Run fresh patches down the barrel until they come out clean and dry. Clean the flash channels of both flintlocks and caplocks with pipe cleaners—pushing the flexible stem on into the barrel.

Next, while outdoors, place a #11 cap on the nipple of the caplock, hold the muzzle near a blade of grass, bit of dust, etc. and drop the gun's hammer on the cap. Detonation of the fulminate will cause a small but noticeable blast to emanate from the muzzle moving the blade of grass or bit of dust. If the blast does not manifest itself, the shooter must go back over the gun to clear away the obstruction.

Finally, after all is clear, run a last clean patch down the barrel to catch any freshly dislodged lubricant. Now the gun is ready to be loaded.

## LOADING STEPS

1. Set the rifle's butt on the ground with the muzzle inclined in a safe direction—well away from your body. Measure and pour the powder down the barrel using an adjustable measure or pre-weighed charges.
2. Lay your strip of lubricated patching cloth (or pre-cut patch) over the muzzle. Center the ball and press it into the bore until it is flush with the muzzle. Tightfitting combinations can be seated by reversing your ball starter and “rolling” it over the ball.
3. Cut the excess patching from around the ball. Specially designed patch knives are ideal for this task although nearly any sharp object will suffice. This is unnecessary for pre-cut patches.
4. Push the ball into the bore using your ball starter.
5. Seat the ball firmly on the powder with the ramrod. The desired ramming stroke is smooth and uninterrupted. Jabbing or tamping the ball down the bore may result in serious deformation or uneven seating force upon the charge. Make sure the ball is firmly seated since an air space could cause a bulged barrel—or worse. Marking your ramrod at the appropriate level is a handy trick. Return the ramrod to the thimbles.
6. Place the hammer on full cock and prime your piece—either with powder or #11 percussion cap. You are ready to fire. Lower the hammer to half-cock if the shot will not be made right away. Since your rifle is equipped with a fly, the hammer sear must be lowered past the half-cock notch and then brought back up and into the notch. Half-cock is not a safety.

## SAFETY NOTES

**Caplocks:** After firing leave the hammer down over the exploded cap as you reload. This helps smother any sparks left from the preceding shot. Keep your hands and face away from the muzzle.

**Flintlocks:** Before squeezing the trigger at the range, check to your sides and make sure your buddy is not standing in line with your barrel's touch-hole. When a fully loaded flintlock goes off there is a jet of hot gas that shoots out from the side and leaves its mark on unwary bystanders. Warn your companions and take extra care before squeezing the trigger.

Be sure there is no gap between the lockplate/priming pan and the barrel flat beneath the vent hole. Fine priming powder can work through a gap, accumulate in the lock mortise and, when ignited, cause gun damage and injury to the shooter and bystanders. Periodically remove and clean both the lock and the stock's lock mortise.

**All Misfires:** Should your gun fail to fire . . . keep the muzzle pointed in a safe direction until the chance of a hangfire has passed and you are satisfied the charge is truly "dead". Next, inspect the nipple and/or vent, remove any obvious obstruction, reprime and try the shot again. If the charge continues to balk, you may have to work some fine powder into the nipple or vent with your pick, reprime and shoot. At worst, it may be necessary to have a gunsmith dismantle the rifle, unbreech the barrel and drive out the load.

**Balls Seated Without Powder:** This seems to happen to everyone at one time or another. It may be necessary to use a “worm” or similar device—but before you go to those extremes try this: Work some fine powder into the flash channel, prime and shoot. Work more powder into the channel and barrel, seat the ball, prime and shoot. This should do it.



## SHOOTING TIPS ...

### CHOOSING BALL AND PATCH

Accuracy with a roundball rifle is based on a paradox; an underside ball is spun by rifling that it never touches! The secret, if there is one, lies in the cloth patch. It functions as a gas seal and, theoretically at least, completely seals the bore. It also transfers to the ball the grip and the spin of the rifling. To perform its duties, the cloth patch should fill the grooves of the rifle. In other words, it should be under considerable compression not only where it contacts the lands, but also at the bottom of each groove. A tight fitting combination of patch and ball is an absolute must for accuracy and considerable cloth must be packed into each groove to completely seal the bore.

When a perfectly patched roundball is driven through a barrel, it will show cloth marks completely around its circumference, like the ball on the right. These marks will be light where the ball and patch touched the grooves and heavy where they touched the lands.

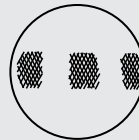

**Incorrect**

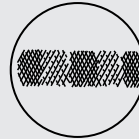

**Correct**

Your selection of the proper cloth patching should be based on an understanding of the relationship between the bore of your rifle and the roundball which will be used. Ball diameter must be less than that of the bore and the cloth must not only fill the grooves but also allow a tight sliding fit between the lands and the patched ball. Follow the suggestions of your rifle's manufacturer concerning projectile diameter. Several companies make specific diameters available either with the purchase of the gun or as a component in a valuable accessory kit. Most other guns will have standardized bore sizes and will be suited for one of the standard roundball diameters such as .490", .495", .530" or .535". To make your final judgment on ball and patch you must measure the bore.

The best way to measure the bore of our rifle is with a soft lead slug which has the rifling engraved on its diameter. Remove the barrel from the stock. Slide a brass rod, which is about 12" long and just under bore diameter (about 3/8" or 7/16"), into the barrel. Start an oversized slug into the muzzle and drive it into the barrel approximately 2" using a brass punch. Now tip the muzzle end of the barrel downwards so that the brass rod slides into the slug. Repeat this procedure several times until the rod drives the slug from the barrel. The engraved slug will have a perfect print of your bore's dimension. Now, with a micrometer, measure both the bore and groove diameter. Here's a sample:

Groove - .526, Bore - .503"

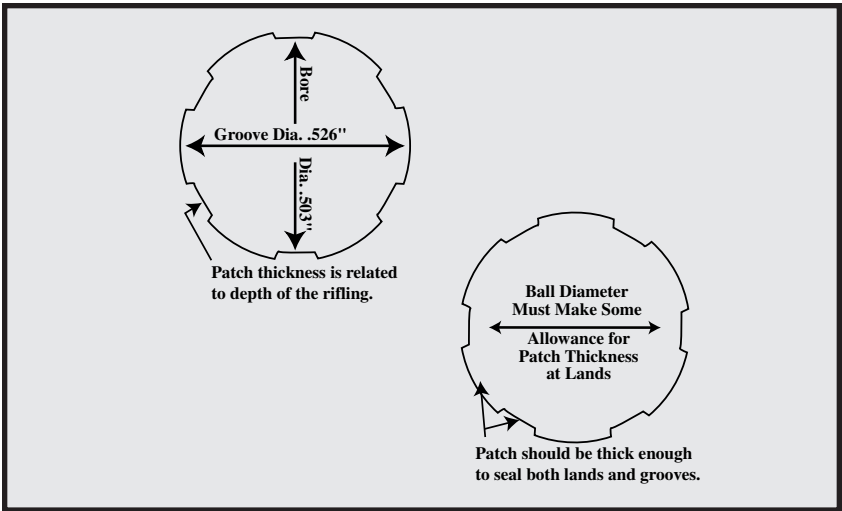

We know the ball must be smaller than the bore diameter so let's select a .498" diameter ball as the best choice for this bore.

With the ball adequately undersize (.005") to fit into the bore we now determine the needed patching thickness to seal the grooves.

Groove	.526"
Ball	<u>-.498"</u>
	.028" difference

Now divide the difference by two and the minimum patching thickness is determined: .014". Remember, there is a thickness of patching on each side of the ball and the difference between the ball and groove diameters must be halved to determine the thickness of cloth needed. Usually it is better to buy cloth that is several thousandths of an inch thicker since the lubricated material will compress upon loading.

Now that you're on the way—keep experimenting with your rifle. Vary the powder charge, cleaning technique, patching or whatever. That's part of the fun of muzzle-loading. But remember to vary only one condition at a time so you can easily keep track of cause and effect.

Lyman suggests that only natural-fiber cloth be used for patching; not synthetics or natural/synthetic blends. The heat of ignition can melt some synthetics resulting in inaccuracy and deposits in your bore. Furthermore, Lyman suggests that plastic cups or patching systems not be used since there can be inadvertent misuse which results in unsafe shooting conditions. Stick with the traditional cloth patch.

## **HOW TO LOAD ... The Minie, Solid-Base Conical, or Sabots in a Rifle**

As for every muzzle-loading gun, there are several operations the wise shooter performs before pouring the first powder charge down the bore. First, he dries the bore and chamber area with clean patches and removes any oil accumulation visible in the nipple and vent. Next, the shooter will snap one or

two caps on the nipple to make sure the channel from the nipple through the barrel wall is open. For a quick visual verification place the muzzle near a leaf, blade of grass or similar object—cap blast will noticeably move it around if the vent is clear. Finally, run the patch down the bore one last time to collect any new debris. Now, you're ready to load and here's how it goes:

Set the gun's butt on the ground with the barrel angled so the muzzle is well away from your body.

Pour the measured charge down the barrel. Many shooters use pre-measured charges loaded into cardboard or plastic tubing. The important thing to remember is not to load directly from a flask or horn. There have been instances where an ember from the preceding shot has remained alive long enough to ignite the next charge as it is dropped down the barrel. The resulting flash touched off the powder within the flask, causing serious injury to the shooter. Use a separate measure.

### **Conical or Minies**

Push the lubricated conical, base-down, into the bore, place the recessed ramrod head over the nose and smoothly ram it home. Strive for a smooth motion that leaves the bullet seated atop the powder without air space or undue compression. Try to avoid jabbing or tamping the bullet for this may cause the skirt/base to become deformed, which will certainly have an adverse affect on the projectile's accuracy. Remember, unless the bullet is seated fully and correctly, an air space may result—and that could mean a bulged or split barrel. Uniformity in loading is the secret to good marksmanship when shooting a Minie or solid-base conical.

Conicals can shift off the powder charge and down towards the muzzle if you carry the gun in even a slight barrel-down position. Hunters are particularly exposed to this and should take special precautions: Stop frequently, deprime/decap and use your ramrod to reseat the conical. Afterward, reprime/recap and continue hunting.

### **Sabots**

Sabot bullets are designed to be seated with the bullet inside of the sabot. Never seat the sabot and bullet separately! Place the base of the sabot with a bullet into the muzzle of the rifle and align it as straight as possible with the bore. Using a ball starter, drive the sabot and bullet several inches into the barrel. Use the recessed end of the ramrod to drive the sabot and bullet the rest of the way down the barrel. Try to do this smoothly and firmly, seating the base of the sabot against the powder charge. Uniformity in loading is key to good accuracy.





Bring the hammer to full cock and press a percussion cap firmly over the nipple—you're ready to fire. Lower the hammer to half-cock if the shot will not be made right away. Since your rifle is equipped with a fly, the hammer sear must be lowered past the half-cock notch and then brought back up and into the notch. **Half-cock is not a safety.**



After firing, leave the hammer down over the exploded cap as you reload. This restricts air circulation and helps smother any sparks left behind by your preceding shot.

**Remember—avoid having your hands or face directly over the muzzle during the loading operation. After the gun is loaded follow the safety rules used for modern firearms.**

## CONICAL BULLET SUITABILITY CHART

1. Bullet No. 454616–Popularly known as the "Maxi-ball," this bullet is designed specifically for the T/C Hawken with 1/48" twist and nominal bore diameter of .45".
2. Bullet No. 457121PH–Designed for Navy Arms Parker-Hale Volunteer rifles with 1/20" twists. Casts a nominal .456/.453" diameter in pure lead.
3. Bullet No. 504617–Designed for the Lyman Trade Rifle, Deerstalker, T/C Hawken and other rifles with nominal .500" bore and 1/48" twist.
4. Bullet No. 508656–This is the .50 cal. version of our new Plains bullets which offer greater bearing surface areas for improved accuracy. It also features a two diameter design for easy loading. Fits most traditional .50 cal. muzzleloaders.
5. Bullet No. 548657–This is the .54 cal. version of our new Plains bullets. Like the .50 cal. design, this is a two diameter bullet with a greater bearing surface area than common Maxi bullet designs. Fits most traditional .54 cal. muzzleloaders.
6. Bullet No. 575213–The standard of .58 shooters. Fits any .58 gun on the market today. Does well with charges up to 70 grains FFg.
7. Bullet No. 575213PH–This is the same bullet as the 510 gr. 575213, but with a shallow base plug which increases the bullet's weight to 566 grains. Designed for Navy Arms .58 cal. Parker-Hale rifles.
8. Bullet No. 577611–This bullet takes up where the 213 leaves off at 70 grains of FFg. Fits any .58 gun on the market today a bit tighter and gun will require cleaning more often.

MUZZLELOADING RIFLES			
.45		.50	
			
454616 220 gr.	457121PH Conical 475 gr.	504617 370 gr.	508656 MAXI 395 gr.

MUZZLELOADING RIFLES			
.54	.58 Orig. & Replica– 58 cal. Rifled Musket		
	Old Style 		
548657 MAXI 450 gr.	575213 OS 460 gr.	575213PH MINIE 566 gr.	577611 MINIE 540 gr.

## DISASSEMBLY AND CLEANING OF RIFLES AND PLAINS PISTOL

You must clean your rifle or pistol after each shooting session to prevent rust and corrosion from damaging the metal parts. The Lyman Great Plains Rifle, Trade Rifle, Deerstalker or Plains Pistol may be easily disassembled for cleaning by removing the ramrod, driving out the barrel wedge in the forearm, drawing the hammer to full cock and lifting the barrel (muzzle first) out of stock. The hooked breech will slip right out of the tang unit with no further disassembly needed. Of course, these Lyman guns can be cleaned without any disassembly but care should be taken to prevent water and solvents from entering the stock or lock mechanism.

### TWO CLEANING TECHNIQUES:

**HOT SOAPY WATER**—The traditional way to clean a muzzleloader.

1. Scrub the bore with a strong solution of hot soapy water. Wipe all powder fouling from other metal parts.
2. Flush the barrel with the hottest clean water available. This not only removes the soap but also heats the steel which helps in the drying process.
3. Dry all parts.
4. Apply a good coat of oil or moisture-displacing lubricant to all metal parts and reassemble. A silicone gun rag is excellent for treating the exterior of the muzzleloader.
5. Inspect for the next few days just to be safe.

**MODERN SOLVENTS**—Just as effective as soapy water if properly done. Solvents designed specifically for black powder guns are now on the market and the old standbys may be used as well. We recommend Butch's Black Powder Bore Shine.

1. Scrub the bore with brass brush and lots of patches. Wipe down all metal parts.
2. Using plenty of clean patches, wipe the bore dry. We recommend Butch's Triple Twill Patches. All guns are supplied with a cleaning jag of the proper size. The jag screws into the end of the ramrod and will securely hold cleaning patches. Dry all metal parts.
3. Apply oil to all metal parts and reassemble. We recommend Butch's Gun Oil. A silicone gun rag is excellent for treating the exterior of the muzzleloader.
4. Inspect for the next few days just to be safe.

### Cleaning Note

**Note:** The powder channel inside the breech plug is smaller than the bore diameter and does not allow the cleaning jag to enter. Lyman recommends the use of a .38 cal. cleaning brush and/or a slotted tip cleaning rod to reach into this area.

## Maximum Loads Lyman Black Powder Guns

The following loads are maximum combinations of propellant and projectile for Lyman Black Powder guns **except for the Mustang Breakaway Rifle which can be found on page 44**. Do Not Exceed!

### Plains Pistol

.50 - .495" RB	40 grs. 3Fg
.54 - .535" RB	50 grs. 3 Fg

### Rifles

.50	.495" RB	110 grs. 2Fg or	90 grs. 3Fg
	240 gr. Sabot	100 grs. 2Fg or	90 grs. 3Fg
	335 gr. Sabot	100 grs. 2Fg or	80 grs. 3Fg
	420 gr. Maxi	100 grs. 2Fg or	80 grs. 3Fg

.54	.535" RB	120 grs. 2Fg or	100 grs. 3Fg
	335 gr. Sabot	110 grs. 2Fg or	90 grs. 3Fg
	450 gr. Maxi	110 grs. 2Fg or	90 grs. 3Fg

### Round Ball Selection Guide

.50 cal. .490"/.495"	.54 cal. .530"/.535"
----------------------	----------------------

**Note:** Equivalent loads of Pyrodex RS, Select, or P are acceptable. Pyrodex pellets are not recommended with Lyman side hammer guns due to difficult ignition.

## Lyman Black Powder Handbook & Loading Manual



### Written by Sam Fadala



Lyman introduces the Black Powder Handbook that muzzleloaders have been waiting for. This manual is entirely new, from the ground up, and includes thousands of pressure tested loads using **Goex** and **Elephant Black Powders, Pyrodex** and **Pyrodex Pellets**. We feature a large assortment of bullets with down range velocities and energies for each load, all developed in our ballistics testing lab. This manual offers the **ultimate in black powder loading and shooting technology.**

**Sam Fadala** brings his well known expertise to this work covering every aspect of muzzleloading, soup to nuts. **Mike Venturino** offers a special section on Cowboy Action and Black Powder cartridge.

**It's the one manual every black powder shooter should own!**

Lyman Products 475 Smith Street, Middletown CT 06457  
Phone: (860) 632-2020 Fax: (860) 632-1699 [www.lymanproducts.com](http://www.lymanproducts.com)

# SHOOTING TIPS

## Black Powder Guide

**Note:** This chart is intended as a guide to show the appropriate uses of Pyrodex and Black Powder. It is not necessary to follow them exactly.

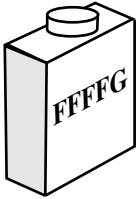

### **FFFFG**

Commonly called “Four F”, this is the finest granulation and is used for priming flintlocks. Due to its rather limited use, it is usually somewhat difficult to obtain. When necessary, FFFFG may be substituted. There is no Pyrodex equivalent.

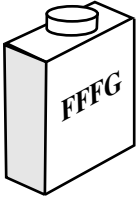

### **FFFG/Pyrodex “P”**

Commonly called “Triple F”, this powder is used in most single shot pistols and all percussion revolvers. It is also popular for all smaller caliber rifles up to and including 50 caliber. When FFFFG is not available, FFFFG may be used to prime a flint lock.

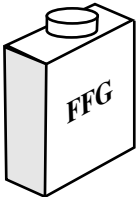

### **FFG/Pyrodex “RS” and “Select”**

Commonly called “Double F”, this is a popular powder for rifles over 50 caliber and up to 75 caliber. Also used in the larger caliber single shot pistols and most shotguns.

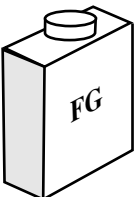

### **FG**

Commonly called “Single F”, this is the coarsest granulation used for small arms. Use is pretty much restricted to rifles over 75 caliber and large bore shotguns. There is no Pyrodex equivalent.

## GETTING STARTED IN CASTING

Making the move into bullet casting is easy and relatively inexpensive, especially considering the satisfaction and enjoyment you will receive by moulding your own minie, maxi and round balls. In addition, the increased per-shot economy will quickly defray the cost of the casting equipment. As a muzzleloader, your start-up costs will also be reduced since you will not need to purchase sizing and lubricating equipment.

## CASTING ACCESSORIES

Lyman offers a complete line of bullet casting accessories including casting furnaces; minie, maxi and round ball moulds and most other casting equipment. For the muzzleloader who is just starting out in casting, we recommend our Mini-Mag Furnace. This 400 watt furnace is designed to perfectly fill the needs of the black powder shooter. In about 30 minutes, this furnace will bring 8 pounds of lead up to casting temperature.

For a complete listing of all Lyman's casting equipment, please see our current catalog which is available by writing to:

Lyman Products, 475 Smith St., Middletown, CT 06457  
or call 1-800-22-Lyman.



**WARNING:** Melting lead and casting lead objects will expose you and others in the area to lead, which is known to cause birth defects, other reproductive harm and cancer.

**REDUCING EXPOSURE:** Lead contamination in the air, in dust, and on your skin is invisible. Keep children and pregnant women away during use and until cleanup is complete.

Risk can be reduced-but not eliminated-with strong ventilation; washing hands immediately after use of these products before eating or smoking; and careful cleaning of surfaces and floors with disposable wipes, after lead dust has had a chance to settle. Use a lead specific cleaner with EDTA, or a high-phosphate detergent (like most detergents sold for electric dishwashers) and bag used wipes for disposal.

Use Strong Ventilation

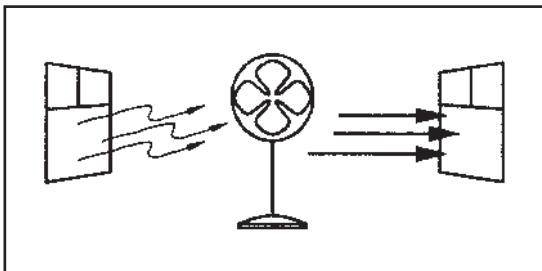



## BULLET CASTING BASICS

The blackpowder shooter is almost always faced with the need to cast his own bullets, be they round, conical or minies. A bullet mould is absolutely necessary and generations of shooters have used—and continue to use—Lyman precision bullet moulds. Other needed supplies include pure lead, melting pot, ladle, fluxing substance, hammer handle/mallet and towel or blanket.

**Caution:** If you are melting lead on the kitchen stove, exercise care to avoid lead contamination of stove, food and food preparation and serving utensils.

First carefully clean all oil and grease from your mould, both the cavity and the precision-ground block faces. Now the mould is ready for casting.

Second, prepare your molten lead, flux and skim off the impurities. When the molten lead is properly cleaned it will be a bright silver.

**Caution:** Breathing or ingestion of lead or vapors constitutes a potentially serious health hazard.

Third, place your ladle in the pot and let it heat to the lead's temperature.

Now arrange your towel to cushion the newly cast bullets as they drop from the mould and place the hammer handle or mallet close by.

You're all set.

Pour molten lead from the ladle into the mould in a rapid continuous manner. Don't interrupt the pour or an imperfect bullet will result. The first few bullets will be flawed regardless of your expertise because the mould itself needs to be brought up to proper temperature. This can best be done by actually casting bullets and returning them to the melting pot.

As you finish pouring each bullet, grasp the mallet and strike the sprue cutter, slicing through the lead in the pouring hole just above the bullet's surface.

**Caution:** Don't drop sprue or flawed bullets directly from the mould into the pot.

Molten lead splashes easily. Periodically—and gently—return the scraps to the pot. Lower the mould close to your towel and open the handles. The bullet should drop freely to the pad. If it doesn't—especially after casting for a while—it may well be overheating and due for a minute's rest!

After you've prepared the desired quantity of bullets be sure to close the mould and position the sprue cutter as if you were about to pour. This will allow the mould to cool with both blocks in perfect alignment. After the mould has cooled, oil it well as it is especially susceptible to rust after the lead has driven out most moisture. The mould will draw moisture from your home—similar to a dry sponge.

The smart caster is well-protected from splashes of molten lead by gloves and eye protection and works in a well-lighted and well-ventilated room.

## SIGHT ADJUSTMENT

### Lyman Muzzleloaders

Lyman's Great Plains and Trade Rifles are shipped with two types of rear sights. The shooter can choose the style preferred and save the other as a spare.

**Front Sight**—The sights on these rifles are a combination of traditional appearance and sighting principles proved in more modern times. The front sight is a strong, one-piece, square blade design finished overall in a dark blue/black.

This dark, thick blade permits close holding and fast sight alignment. Blades which are polished brass or silver cause the shooter to "shoot away from the light" due to glare on the blade.

The front sight may be left "as is" or reduced in height, by filing, to raise the point of impact.

Use a cold blue solution to re-blacken the sight after filing.

**Adjustable Rear Sight**—This traditional buckhorn rear sight allows minor elevation adjustments without filing. Turn the screw clockwise to lower the point of impact; counterclockwise to raise the point of impact. Windage adjustments are made by carefully "drifting" the entire rear sight left or right. Remember: move the rear sight in the direction you wish the ball to go.

The best way to "set up" this sight for both hunting and recreational shooting is as follows:

1. Turn the elevation screw clockwise until the elevation arm bottoms in the full "down" position.
2. Load rifle with your hunting charge and sight in at desired hunting range perhaps 100 yards. File down front sight until the rifle shoots to exact point of aim.
3. Since recreational shooting usually involves circular bullseye targets, the rifle can usually be brought into the "ten ring" by using a six o'clock hold and raising the elevator arm slightly.

The front and rear sight combine to produce the very efficient "Partridge" sighting configuration which is perfect for most hunting and target shooting.

Finished Sight



**Primitive Rear Sight**—This is a traditional one piece, fixed sight which allows final shape and elevation adjustments to be filed into it by the shooter.

Windage adjustments are made by tapping the rear sight to the left or right as you wish the bullet's impact to shift.

First, determine what charges work best with ball and conical projectiles. Once you have settled on the bullet and charge level, the filing can begin.

You may find the unaltered rear sight is just fine. However, you may discover that you are shooting high—even with the front sight blade buried in the rear sight notch. If that is the case, then here's what you do:

1. File the top of the sight flat until you reach the correct elevation for your selected load. The correct procedure is to file a bit then shoot; file—shoot and so forth until the rifle shoots to the desired point of impact.
2. With the sights set correctly, now is the time to deepen or widen the rear sight notch if you wish. Use a cold blue solution to re-blacken the sight.

The result is a traditional rear sight which utilizes the very practical and efficient "Patridge" configuration—excellent for hunting or target work.

## **PLAINS PISTOL**

The sights are non-adjustable and the front blade must be filed to adjust the elevation. Windage adjustments may be made by "drifting" the rear sight in the direction you wish to move bullet impact.

The rear sight notch width and front blade width are designed to provide a very fine target sight picture. You may widen the rear notch with a jeweler's file if you wish. Use a cold blue solution to re-blacken the sights after filing to eliminate glare.

## **DEERSTALKER RIFLE**

Front Sight—A special new configuration of Lyman #37 hunting front sight designed to fit the dovetail of Lyman Black Powder Rifles. This sight is equipped with a 3/32" white bead for fast shooting.

Rear Sight—A special new configuration of Lyman # 16 Folding Leaf Sight designed to fit the dovetail of Lyman Black Powder Rifles. This open rear sight is equipped with an adjustable elevation blade which is held firmly in place by two lock screws.

In order to change the point of impact, loosen the two lock screws holding the rear sight elevation blade. Raising the elevation blade will raise the point of impact. Lowering the elevation blade will lower the point of impact.

Tighten the lock screw when the elevation blade is in the desired location. In order to make windage adjustments, the entire rear sight can be carefully "drifted" to the right or left. Use a punch made from a soft material such as brass, and strike the base of the sight only. Never strike the folding leaf. Remember: Windage adjustments are made by moving the sight in the direction you wish the ball to go.

The Deerstalker is drilled and tapped for use with Lyman's 57 SML receiver sight which is described under Black Powder Sight Options.

In adjusting any type of iron sight, the following principles hold true:

1. Adjust the rear sight in the direction you wish to move the bullet's impact.
2. Adjust the front sight exactly opposite the direction you wish the bullet's impact to shift.

## OPTIONAL LYMAN BLACK POWDER SIGHTS

Lyman has been making quality gunsights for shooters for more than 100 years. To meet the needs of today's black powder enthusiast, Lyman offers a number of alternative sight packages which can improve accuracy for the serious target shooter or hunter. All models fit both left and right handed rifles.

### TARGET SIGHTS

#### Lyman #57 SML Receiver Sights

This popular target sight has 1/4 minute micrometer click adjustments for elevation and windage, a quick-release slide and comes with both hunting and target style apertures. The 57 fits the Lyman Trade Rifle, Lyman Deerstalker and most other imported Hawken replicas. Note: Minor drilling and tapping required depending on manufacturer. 57 SMLs made prior to 1989 will not fit T/C Hawkens made after 1988.

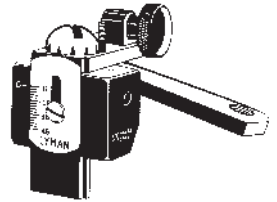

57SML

#### 57 GPR

The 57 GPR fits Great Plains Rifles and Great Plains Hunter Rifles. The 57 GPR has the same specifications as the 57 SML described above, however, is equipped with an adapter base that fits the tang angle of Great Plains rifles.

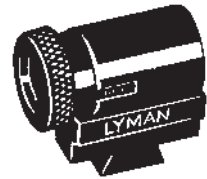

17A

#### Lyman 17 A Front Sight

Teamed with a Lyman #57 Receiver Sight, this target front sight will provide precise accuracy on the range.

Designed for use with dovetail slot mounting, the sight is supplied with seven interchangeable inserts that are locked into place with a threaded cap. The 17 AML and AEU mount low to the barrel for use with our 57 SML. The 17 ATC sits high above the barrel for use with the high, T/C Creedmore type rear sight. The 17 AML and ATC Sights fit T/C Hawken and other rifles with 3/8" dovetails. The Lyman Great Plains, Trade and Deerstalker Rifles use the 17 AEU sight, as the barrel dovetail is .360.



37ML

### HUNTING SIGHTS

Lyman offers both the 16 AML Folding Leaf Sight and the 37 ML Front Sight in a special configuration designed to fit all current Lyman Black Powder Rifles. The 16 Folding Leaf Sight is adjustable for elevation and the leaf can be folded out of the way when the rifle is additionally equipped with a receiver sight. The 37 Front Sight is equipped with a 3/32" white bead for fast shooting. This sight package will fit the Great Plains and Trade Rifle as well as the Deerstalker Rifle.

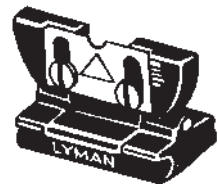

16AML

## FITTING WEDGE PINS

It may sometimes be necessary to adjust the fit of the wedge pins to the escutcheons. The conditions include adjustment to prevent the pin from falling out if the fit is loose, or the removal of a small amount of material if the wedge pins do not enter completely through.

If the wedge pin is too loose (fig. 4) the fit can be tightened up placing an approximately 1" diameter bar over the barrel lug. Gently tap the bar with a hammer while rolling bar back and forth (fig. 4A). Check fit by installing barrel in stock and installing wedge pin. Repeat as necessary.

Warning: Proceed very carefully since this operation can be overdone quickly.

Wedge pins can on occasion hang up on the inside of the left side escutcheon. To correct this, remove RIGHT side escutcheon and secure in a vise. Use a small jewelers file to remove material from the top of the slot in which the wedge pin slides through. Check fit by placing in cavity (it is not necessary to screw in place) and inserting wedge pin. Repeat as necessary.

For a better fit of wedge pin, remove LEFT side escutcheon, turn upside down and file a 45° bevel on the inside of escutcheon where wedge mates (fig. 5). This will ease entry of the wedge pin.

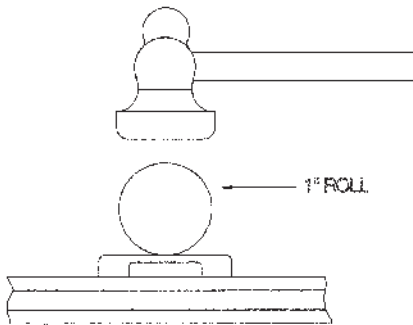

**FIG. 4**



**FIG. 4A**

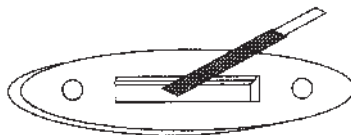

**FIG 5**

# Instructions for Lyman Assembly Kits

## INTRODUCTION

The materials provided in Lyman Kits have been selected for their overall quality and durability. Proper assembly will enable you to create a muzzle-loading firearm having the quality lines of an expensive custom piece.

Read these instructions thoroughly before you actually begin assembly. There are several critical steps - and others that will save considerable time within the instructions. Reading the instructions will give you a better understanding of the task and allow you to mentally sequence the events before beginning work.

## TOOLS REQUIRED

We recommend that you obtain a copy of Brownells Gunsmith Tool Catalog. You will find this book to be a handy tool reference and a good source for the material you cannot find locally.

Brownells Inc., 200 South Front Street, Montezuma, Iowa 50171

**Carving Tools**—The wood work required to complete this kit could be done with ordinary hobby knives, but a set of wood carving tools will simplify any carving required.

**Rasps**—You will need a straight rasp for rough shaping the exterior of the stock to final dimensions. The "Surform" tools produced by Stanley will do a satisfactory job.

**Sand Paper**—Grades 80 through 320.

**Files**— (1) 10 or 12 inch mill file  
(2) 1/4 inch wide pillar file  
(3) 1/4 inch three square file

**Electric Drill and Bits**—

- (1) 3/32 inch
- (2) 1/16 inch
- (3) 1/8 inch

## SPECIAL INSTRUCTIONS - INLETTING

The stock of your Lyman kit is, at least, 95% inletted. You will find that most, if not all, the major parts will fit properly with no additional inletting required. However, we have chosen to be very meticulous and present the inletting of each part with greater detail and emphasis than is likely to be required.

Throughout these instructions you will be instructed to "blacken" the part prior to inletting, then to look for the black transfer marks, indicating where excess material is to be removed. These instructions refer to a technique where a part is coated with a transfer agent (such as soot, Prussian Blue, lipstick or similar substance) then inserted into the semi-inletted stock and lightly tapped into place. When the part is removed, the transfer agent will remain on the stock showing where wood is to be removed or *the fit is perfect*. If you have never inletted a stock before, it is important for you to realize the presence of a black transfer mark does not automatically indicate removal of material.

NOTE: CONSULT THE PARTS DIAGRAM IN THIS GUIDE AS NEEDED.

**Example:** Assume that you are inletting the lock assembly. After you remove the lock for the first time you will note the black transfer marks in the cavity. Little black will be apparent around the edges of the lock. Black marks will be located within the cavity showing where wood is to be removed to allow the working parts of the lock to fit. You will continue to coat the part with transfer agent, reinsert it into the cavity, continue inletting gradually dropping the lock into place. As the lock is lowered into position the edge of the lock plate will come into contact with the stock. At this time you must proceed very slowly. Wood is actually shaved from the cavity where the edge of the lock plate meets the stock. When the lock plate is properly inletted, light transfer marks will be apparent around the edges of the cavity. If these light transfer marks were to be removed you would create gaps between the edge of the lock plate and the surface of the stock, a condition that is not desirable.

There are two simple ways to obtain a suitable transfer agent.

One is to coat the part with soot from a smoking candle. The smoke from the candle flame is played on the part. This technique is very effective when fitting metal to metal. Add a few drops of oil at the wick base if your candle does not smoke enough. The second way to obtain a transfer agent is to purchase a bottle of "inletting black" from a gunsmith supply house.

### **KIT ASSEMBLY INSTRUCTIONS: GREAT PLAINS RIFLE AND PLAINS PISTOL**

The first step in assembly is with the barrel group. The barrel is to be partially finished first so that it can be readily inletted into the stock.

1. **Draw Filing the Barrel**—Draw filing is used primarily to shave away the tool marks left on the barrel by the precision milling operation; secondarily to dress the patent breech to the barrel.

During draw filing, the file is held such that it makes a right angle with the axis of the barrel (refer to Figure 1). Holding the file with both hands, it is lightly drawn down the entire length of the barrel, shaving metal away as it travels.

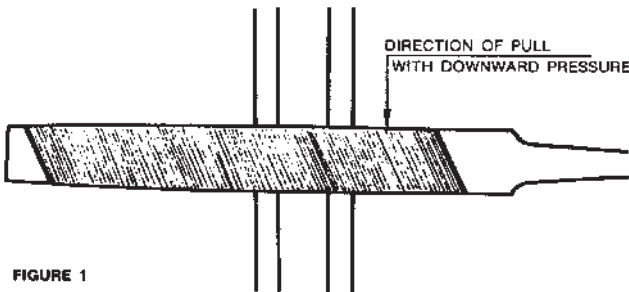

**FIGURE 1**

Begin by securing the barrel in a padded vise and start draw filing the entire barrel, one flat at a time. Start at the muzzle and draw the file towards you, making sure that the file is held flat against the barrel. Do not allow the file to rock side to side during the draw, as this will cause rounded edges.

Continue filing, one flat at a time, until each flat of the barrel is completely free of milling tool marks, and the breech plug is flush with the barrel flats. Take your time.

When the draw file has been completed, lightly oil the entire barrel to prevent rust. The final polishing of the barrel will be done after all inletting has been completed.

2. **Fitting the Tang to the Breech Plug**—The tang and the lug on the breech plug may require hand-fitting to provide the proper fit when the barrel is hooked into position. The fit described below will assure a rigid barrel/stock assembly that will promote excellent accuracy in the finished rifle or pistol.

**Caution:** This step is often unnecessary as it is factory fitted.

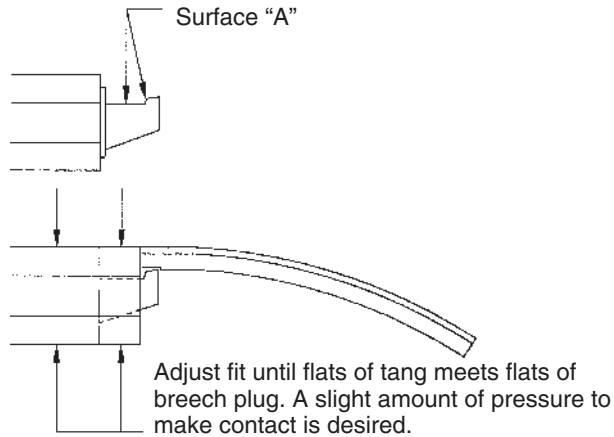

FIGURE 2

You will note that when the tang is first installed onto the breech plug it may not lie flat, in contact with the rear of the breech plug.

The idea now is to carefully file away the surface ("A") of the breech plug lug until the tang mounts flush with the plug with a small amount of pressure applied. Over-cutting of the top surface will cause the tang to fit loosely and may affect accuracy.

Blacken the entire surface of the projecting lug on the breech plug. Hook the tang onto the lug. Remove the tang and examine the upper surface of the lug. White marks (soot rubbed away) will indicate where excess metal is to be filed away. Carefully file away excess metal, reblacken the lug and hook the tang back into position. Repeat the filing and fitting process until the top flat of the tang is parallel with the top flat of the barrel.

3. **Inletting the Stock**—The stock of your Lyman muzzleloader is a very delicate piece of wood, and requires considerable care when metal parts are fitted to it. Pressure incorrectly applied when inletting could well result in a cracked stock.

The areas of the tang, barrel breech and the lock are particularly delicate. Large amounts of wood have been removed from these areas to accommodate hardware. These areas are very likely to be damaged if improper care is taken during the inletting process. The following instructions describe how to proceed during each critical step. With reasonable care, good results will be obtained.

4. **Inletting of the Lock Screw Bushing or Plains Pistol Belt Hook**—The lock screw bushing should be inletted flush with the stock surface. Blacken the underside of the bushing and press it into its stock cavity. Remove the bushing and carefully cut away excess wood within the cavity. Continue the process until the bushing is completely inletted and bottoms in the cavity.

**NOTE:** Should the bushing become stuck in position before inletting is complete, it can be easily removed by inserting the lock screw into the screw hole from the lock cavity side of the stock, and carefully tapping out the bushing.



5. **Inletting the Lock Assembly**—First, draw the hammer back to full cock. Apply transfer agent to plate edges. Position the lock over its cavity in the stock. Insert the lock mounting screw and slowly tighten it, drawing the lock down into position. Draw down only until resistance is met. Remove the lock and examine the cavity for black transfer marks. Carefully cut away excess wood.

**NOTE:** If you remove too much wood from the inner surface where the stock and the edge of the lock plate meet, unsightly gaps will result. Remove only small amounts of wood at a time. Do not over-tighten the lock screw when drawing the lock into position. If the cavity has not been fully inletted, the lock will act as a wedge and a cracked stock will result. Continue the inletting process until the lock has been inletted to a point where the surface of the lock plate is just above the surface of the stock. Final inletting will take place later.

6. **Inletting the Tang and Barrel Assembly**—Remove the forend cap from the stock. Install the lock.

Hook the tang on the breech plug and set the entire tang/ barrel assembly into the stock. Carefully note the position of the bolster (on the breech plug) with regard to the circular cutout on the lock. It should align closely.

Inletting of the tang/barrel assembly must allow the bolster to fit into the circular cutout on the lock when inletting is completed.

If further inletting is needed, blacken the underside of the tang and set it into position, noting with a pencil mark. Carefully tap into place, then remove and cut away excess wood. Continue this process until the tang has been inletted to 90% of its depth in the stock. During the course of this inletting, periodically install the barrel on the tang to check for bolster alignment with the lock.

Once the tang has been inletted to near full depth, proceed by inletting the barrel and tang as an assembly. Blacken the undersides of both the barrel and tang. Cut away any excess wood from both the tang area and the barrel channel until the assembly is fully inletted, and the bolster makes contact with the circular lock plate cutout. When this contact has been made, remove the lock and continue inletting to full depth. The barrel wedge(s) can be inserted into the barrel tenon(s). A slight amount of pressure should be required to insert the wedge(s). Note that on the Great Plains Rifle the longer wedge should be installed closest to breech.

7. **Final Inletting of the Lock and Barrel Assembly**—Great Plains: Set the tang and barrel into position, note the location of the two tang screws. They should line up with the holes in the tang. When complete, mount the tang in position. Hook the barrel to the tang and install. Do not force the barrel down. You may find that additional inletting behind the breech plug is required to clear the breech hook, allowing the barrel to pivot.

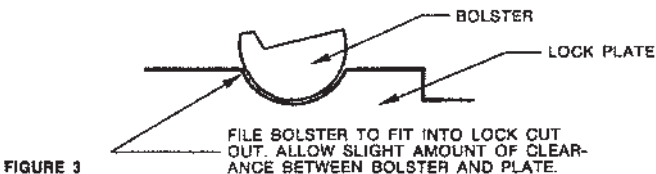

FIGURE 3

Plains Pistol: Set the tang and barrel into position and, when complete, mount the tang in position. The single tang screw goes through a pre-drilled stock hole and anchors in a threaded hole in the top of the trigger plate. Make sure the screw aligns properly so the tang screw threads won't be stripped. Hook the barrel to the tang and install. Do not force the barrel down. You may find that additional inletting behind the breech plug is required to clear the breech hook, allowing the barrel to pivot.

**NOTE:** Gap between lower barrel flat and bottom forend channel should not exceed 1/16".

At this stage you should complete inletting of the lock to its full depth so the inside shoulder of the lock makes solid contact with the side flat of the barrel, and the bolster of the breech plug fits properly into the circular cutout of the lock. Install the lock assembly. Blacken the underside of the bolster and reinsert the barrel assembly in the stock. The barrel may not go back into its fully inletted position.

If not, the interference will be caused by the bolster being slightly out of position with the circular cutout of the lock (refer to figure 3). Remove the barrel and examine the underside of the bolster for interference marks. Carefully file away excess metal on the bolster, using a rotation motion as you file. Repeat the blackening and trial fit process until the barrel has been returned to its fully inletted position. Note: Proper fit is achieved when there is a slight clearance between the bolster and the circular cutout. At final assembly the lock must be able to be removed with the barrel in position.

**Flintlock Note:** The lock must contact flat of barrel to prevent priming powder from collecting inside lock. If ignited, this powder will explode, ruining the rifle and probably causing injury.

Install the barrel using the barrel wedge to hold it in place. Remove the lock assembly and blacken the underside. Continue the inletting of the lock until the inside shoulder of the lock is in full contact with the side flat of the barrel. When the lock has been fully inletted, carefully pull the hammer back to check for interference with internal working parts. The lock should cock freely. If resistance is felt, examine the lock cavity to ensure that all rotating parts have clearance.

**8. Inletting the Trigger Assembly**—Blacken the underside of the trigger assembly. Insert the assembly to the rear of the trigger cavity. Remove the trigger assembly and cut away excess wood. Continue the inletting process until the trigger plate has been inletted slightly below the surface of the stock.

Locate the position of the trigger assembly mount screw. On the Great Plains Rifle use the 1/16 inch drill to drill the pilot hole. Install the trigger assembly.

**FUNCTION TEST:** Make certain that the hammer is in the down position. Check triggers for freedom of movement.

**Great Plains Rifle**—Set the rear trigger and release the set trigger by pulling on the front trigger. If both triggers operate freely, you have adequate clearance. If not, remove the trigger assembly, examine the cavity for black transfer marks and cut away interfering wood.

**Plains Pistol**—Secure the trigger assembly by installing and tightening the tang screw.

**9. Inletting the Trigger Guard**—**Great Plains:** Use a mill file and carefully remove any burrs from around the bottom edges of the two flats of the trigger guard. The outer edges should be completely finished before inletting. The exterior surface of the trigger guard can be finished later. Blacken the underside of the two flats of the guard, and insert the guard into its cavity. Remove and cut away excess wood. Continue the inletting until the trigger guard has been inletted flush with the surface of the stock. Locate the position for the two pilot holes and, using the 3/32 drill, drill the two pilot holes for the trigger guard screws. Install the trigger guard.

**Plains Pistol:** Your Plains Pistol Kit has the trigger guard factory-installed. No holes need be drilled by the builder and little, if any, inletting will be necessary. However, some fitting of the trigger guard over the trigger assembly may be necessary to permit the trigger guard to return to its original position, flush with rifle stock.

If such fitting is necessary, spot and file the underside of the brass trigger guard as needed.

The trigger guard should be left on the stock during all stages of wood shaping and finishing. However, the correct fit is flush with the finished stock. After the stock has received its final sanding, the trigger guard can be removed for final polish and later installation on the stained and finished stock.

**10. Inletting the Butt Plate (Rifles Only) and Forend Cap**—Both the butt plate and nose cap have been factory-installed to protect the exposed ends of the stock. Additional fitting may be necessary for perfect fit.

Remove the butt plate and blacken the underside. Install. Then remove and cut away excess wood. Continue this process until no wood-to-metal gaps are apparent. Final fitting will take place when the stock is shaped. Note: In some instances, only a minor amount of metal prevents an excellent fit. Judicious filing and spotting often causes the butt plate to fit perfectly with little or no wood removal.

The forend cap is inletted in the same manner with an additional operation required. Once the forend cap has been fully inletted, install the barrel. Note any interference between the cap and barrel, and carefully file away excess cap metal. The cap should not make contact with the barrel, a 1/64 inch gap is desirable.

**11. Inletting the Escutcheons**—Place the barrel in the stock. Each escutcheon is inletted separately using the barrel wedge as a locating guide.

Blacken the underside of an escutcheon plate. Place the plate in position over its cavity and insert the barrel wedge. Lightly tap the wedge down to hold the plate in position. Do not overdo this or the plate will be deformed. Check the plate for position and make sure the cavity is completely covered by the plate. Select a knife with a small, thin blade and carefully cut a line around the edge of the plate. Use only the point of the blade and position the knife so the cut is angled toward the center of the plate.

Remove the plate and, using the knife cut as a guide, cut away excess wood directly to the bottom of the cavity. Make certain the cuts stay slightly to the inside of the knife scribe mark. Repeat the process for the second plate. Pilot holes are not required for the escutcheon plate screws. Use the point of a knife or small nail to locate the center of the hole and install the screws.

**12. Finishing the Barrel**—When the barrel has been completely inletted into the stock, work may proceed with final finishing of the barrel. The draw filing operation is now to be followed by successive passes of polishing with abrasive paper. First, select a medium-coarse grit emery paper, followed with successively finer grits up to 240 grit wet or dry paper. Wrap a piece of the grit around the file used to draw-file the barrel. The draw-polishing is accomplished in the same manner used to draw-file the barrel. Polish all flats, including the breech plug, until a satisfactory polish has been achieved.

**13. Metal Coloring**—All steel fittings (except the lock and trigger assembly), including the barrel, of your Lyman muzzleloader require some form of metal finish. These may be polished with successively finer grades of emery paper or left as is prior to finishing depending on the builder's taste.

Traditionally, rifles and pistols of this type had the "iron mountings" browned. The kit builder may choose to cold blue these parts if he prefers a more modern type of finish. Metal finishing can be accomplished by dismounting all the steel parts from the stock and applying the metal finish according to the chemical manufacturer's instructions.

**CAUTION:** The ramrod thimbles on the Great Plains Rifle, and Plains Pistol are soldered to the barrel rib in the same fashion as many originals. Since some browning solutions require the use of heat, caution should be used to assure the part is not heated enough to loosen the soldered bond.

Hot browning requires approximately 212 to 260 degrees and, therefore, should present no problem if the kit builder is careful and tests the part temperature often.

14. **Sight Assembly**—Install the front sight and rear sight by drifting each into place using a brass or nylon punch so as not to damage them. These are installed right to left.

15. **Wood Finishing**—The stock has been machined in the traditional style of the period. However, sufficient wood has been left in most areas to allow individual styling of your kit.

When you have shaped the stock to a point slightly above the surfaces of any inletted metal parts, follow this operation with rough sanding using 80 grit paper. When sanding, follow the wood grain whenever possible. Final sanding should be done using grits 100 through 240, in succession to remove tool and sanding marks.

Sanding: When you have completely sanded the stock using 240 grit paper, carefully examine the stock surface. It will be completely free from scratch marks caused by rougher grits of paper. If all of these marks are not removed at this time, they will show through the finish and detract from the overall quality. When the stock has been completely sanded smooth, wet down the entire surface with a damp cloth and raise the grain of the wood.

Let the stock dry and once again lightly sand the stock surface with 240 grit paper. Sand off only the raised grain. Moisten the stock again and repeat the process, only this time follow the 240 grit paper with a light sanding using 320 grit paper. The stock is now ready for final finishing.

Staining: The European Walnut stock, as supplied, will finish to a nice warm brown color if finished without the use of a darkening stain. The wood of most old muzzleloading rifles and pistols was very dark in color. Select a walnut stain and follow the directions provided with the product. Stain the stock until you achieve the desired color. We recommend the use of a water stain such as produced by the Birchwood Casey Co. These stains can be found in most gun shops.

Sealing: The stock can be sealed by applying a commercial stock finishing solution such as linseed or Birchwood Casey's Tru-Oil. Follow the directions on the container.

### **IMPORTANT!**

Be sure to read this Lyman User's Guide for Black Powder Products—and other literature—packed with this kit. You must read this material in order to use your Lyman muzzleloader in a safe, responsible manner.

If you decide to sell, trade or loan your Lyman muzzleloader, be sure the new operator receives the User's Guide. Free copies are available from Customer Service if the original booklet has been misplaced.