

Owner's Manual

Instruction Book for:

MODELS 700, SEVEN, & 673

BOLT ACTION CENTERFIRE RIFLES

Remington®

IMPORTANT!

READ ALL INSTRUCTIONS
AND WARNINGS IN THIS
BOOK BEFORE USING THE FIREARM.



PAGE 2.....THE TEN COMMANDMENTS OF
FIREARM SAFETY

PAGE 7.....IMPORTANT PARTS OF THE FIREARM

PAGE 10.....HOW TO LOAD AND UNLOAD

PAGE 13.....LUBRICATION AND MAINTENANCE

PAGE 24.....HOW TO OBTAIN PARTS AND SERVICE

A Tradition of Performance and Safety.

In 1816 Eliphalet Remington was confident he could make a flintlock that was as good or better than any he could buy. His confidence was well founded. The barrel he handcrafted set a new standard for firearm accuracy and spawned generations of products that have made Remington® Arms America's leading gunmaker. While performance and style are certainly hallmarks of Remington firearms, one factor ultimately drives their performance. Safety. Eliphalet Remington never lost sight of the fact that his rifles were potentially lethal and could kill someone if handled improperly. And after almost 200 years the same holds true for any firearm, including your new Remington. Eliphalet Remington's first flintlock launched a proud tradition of accuracy and responsibility.



Eliphalet Remington's first flintlock launched a proud tradition of accuracy & responsibility.

Safety is Critical to Performance.

A superbly crafted gun is only as good as the hands that hold it. You can never be too careful. Shooting accidents are often caused by careless oversights such as failing to control the direction of the muzzle, failing to fully engage the safety, leaving ammunition in the chamber or using improper loads. These oversights can result in the destruction of life, limb or property. There's no calling back a bullet once it's been fired, so it's critical that you know the principles of safe gun handling and storage before you ever take your new Remington firearm out of the box.

The proper use and performance of your firearm depends on correct assembly and maintenance, so it's critical that you familiarize yourself with the information in this instruction book. Even if you're a veteran shooter with a collection of Remington firearms, take the time to read this literature. Not all firearms are the same. That means the first step in safe handling is to learn the features and requirements of your new Remington.

THE TEN COMMANDMENTS OF FIREARM SAFETY

The Ten Commandments of Firearm Safety should be etched in your memory forever. Let them govern your action wherever and whenever you're involved with firearms. In the field. On the range. Or in your home. Please take the time to review and understand these rules.

1st COMMANDMENT

Always Keep the Muzzle Pointed in a Safe Direction.

This is the most important gun safety rule. A safe direction is one in which an accidental discharge will not cause injury to yourself or others. Never allow your gun to point at anything you don't intend to shoot. Be especially careful when you're loading or unloading. Treat every gun as if it were loaded. And make it a habit to know where the muzzle is pointed at all times, even when your firearm is unloaded. No one will be injured by an accidental discharge if you keep your firearm pointed in a safe direction. It's as simple as that.



2nd COMMANDMENT

Firearms Should be Unloaded When Not Actually in Use.

Load your firearm only when you're in the field or on the target range and ready to fire. Never let a loaded gun out of your sight or out of your hands. Unload it as soon as you're finished shooting — before you bring it into your car, camp or home. Remember, unloading your firearm means unloading it completely, so there is no ammunition in the chamber or in the magazine. Before handling a firearm or passing it to someone else, visually check the chamber, receiver and magazine to be certain they do not contain ammunition. Always keep the gun's action open when not in use. Never assume a gun is unloaded even if you were the last person to use it. Always check for yourself.

Let common sense rule when you carry a loaded gun. If you're in a situation that could risk accidental discharge – such as crossing a fence, wading through a stream or climbing a tree – always unload your gun. Never pull or push a loaded firearm toward yourself or another person. And never carry a loaded gun in a scabbard, detached holster or gun case.

Certain firearms (including some Remington® rifles and shotguns) are equipped with internal security devices to prevent unauthorized use. In addition, some firearms owners use external devices, such as cable locks and trigger blocks, for the same purpose. Even if you use such a device, you should still keep your firearm unloaded when stored or not in use. And using internal or external devices cannot substitute, however, for securing your firearms and ammunition in a separate, locked location.

Safe storage of firearms is just as critical as safe handling. Never store guns loaded. Be sure to keep your firearms in a secure place where unauthorized persons cannot get their hands on them without your knowledge.

Take special care if there are children around. Children are fascinated by guns. It's a natural curiosity that can have tragic consequences when not properly supervised. Store your firearms in a locked gun safe or some other location that physically bars a child from gaining access.

Ammunition should be stored and locked in a location separate from your firearm. Never leave an unsecured firearm or ammunition in a closet, dresser drawer or under the bed. Remember, it is your responsibility to make sure that children and others unfamiliar with firearms cannot get access to your firearm and ammunition.



Firearms should be stored in a secure place where children cannot access them. A gun safe is an ideal way to secure your firearm.

3rd COMMANDMENT

Don't Rely on Your Gun's Safety.

Treat every gun as if it can fire at any time, whether or not there's pressure on the trigger. Your firearm has been carefully designed to maximize performance and safety. However, because a gun's safety is a mechanical device, it could fail.

Human error is a more likely reason for a gun safety to fail. By mistake, you may think the safety is on when it really isn't. Or the safety may have been disengaged without your knowledge. Or you could think your gun is unloaded when there's actually a cartridge or shell in it. A mechanical safety is not a substitute for common sense. It's merely a supplement to your proper handling of a firearm.

Never touch the trigger on a firearm until you are ready to shoot. Keep your fingers away from the trigger when you're loading or unloading. And don't pull the trigger when the safety is engaged or positioned between safe and fire.

Before using your gun, read this instruction book to understand the exact location and operation of your firearm's safety. Even when the safety is on, maintain control of your loaded firearm and control the direction of the muzzle. In other words, don't rely on your safety to justify careless handling. If your firearm's internal mechanisms are broken or have been altered, your firearm may fire even when the safety is on. Remember, you and your safe gun handling practices are your gun's best safety.

4th COMMANDMENT

Be Sure of Your Target and What's Beyond It.



You can't stop a shot in mid-air, so never fire unless you know exactly where your shot is going and what it will strike. Never fire at a sound, a movement or a patch of color. A hunter in camouflage can easily be mistaken for a target by an impulsive shooter. Before you pull the trigger be absolutely sure of your target and what's behind it. Make sure the shot has a backstop such as a hillside or dense material like sand. Remember, bullets can travel great distances with tremendous velocity. Know how far your shot will go if you miss your target or the bullet ricochets.



Use Proper Ammunition.

Every firearm is designed to use a certain caliber or gauge of ammunition. Using the wrong ammunition, mixing ammunition or using improperly reloaded ammunition can cause serious personal injury or death. And it only takes one cartridge or shotshell of the incorrect caliber or gauge, or which has been improperly reloaded, to destroy your firearm. It's your responsibility to make sure the ammunition you use exactly matches the caliber or gauge of your gun. Refer to this instruction book to find out the specific requirements of your firearm. Always read and heed the instructions on ammunition boxes.

Confusing shells or cartridges can cause serious personal injury or death and destroy your firearm. Examine your shells or cartridges closely and use only the precise caliber or gauge for your specific firearm. For example, suppose you accidentally loaded a 20 ga. shell into a 12 ga. shotgun. Because the 20 ga. shell is too small for the chamber, the 20 ga. shell could travel down the barrel and get lodged in the bore. If you then loaded a standard 12 ga. shell behind it and fired, the 12 ga. shot will slam into the lodged 20 ga. shell and may cause the barrel to explode right in your hand. This is commonly called a 12/20 burst, and it can kill you.

Check all ammunition before you load it to make sure it matches your gun's requirements. Every Remington® cartridge and shell is head-stamped with its caliber or gauge for easy identification. Likewise, you'll find the caliber or gauge of your new Remington firearm imprinted on the barrel.

Reloading Requires Extra Diligence.

If you're an ammunition reloader, you are responsible for personally assuring that the loads and components of your reloaded ammunition meet your gun's factory-tested standards. Never use ammunition which has been reloaded by someone else!

Many shooters handload as a hobby or to save money on commercial, factory-made ammunition. However, it requires a thorough knowledge of reloading procedures and a deep respect for the explosive potential of gunpowder.

Firearms are designed, manufactured and proof-tested to standards based on factory-loaded ammunition. Handloaded or reloaded ammunition that deviates, either intentionally or accidentally, from load or component recommendations can be very dangerous.

Reloaders must observe all possible safety precautions and practices related to the proper handling of explosives. Whether you're a seasoned reloader or just starting out, you should study the subject, watch reloading demonstrations and talk to experienced reloaders.

The first rule of reloading is to always follow the manufacturer's instructions for the components you're using. They'll tell you to follow certain guidelines. Namely:

1. Don't mix or substitute powders or primers.
2. Don't use unknown or substandard components.
3. Use only suitable components that have been factory-tested by reputable ammunition, powder and bullet manufacturers.
4. Always be sure to use the manufacturer's recommended recipe when reloading.

Not following these guidelines could result in severe injury or death to yourself or others or severe damage to your firearm. Dangerously high pressure and explosions can result from an overcharge of powder or other deviations from established reloading guidelines. Be very careful. The process of reloading exposes you to environmentally hazardous material. Lead, which is known to cause cancer and birth defects, is the most common substance in bullets and shot. It is important to handle lead bullets and shot with extreme care. Work only in a well-ventilated area and always wash your hands after exposure and before eating. Never smoke while reloading.

Primers and powders are also highly toxic and flammable. So after reloading be sure to clean up all materials from your work area. Don't leave primer or powder spills anywhere on the floor or bench top. Dispose of all waste material in accordance with the manufacturer's recommendations.

Finally, when reloading or handloading concentrate on what you're doing at all times. Do not be distracted by talking to others, listening to the radio or watching TV while reloading. Never reload after consuming alcoholic beverages or drugs of any kind. You are working with extremely hazardous materials and you can't risk even a few seconds of distraction. Remember, if you reload, you are the ammunition manufacturer and you are responsible for the performance and safety of your reloaded ammunition.

6th COMMANDMENT

If Your Gun Fails to Fire When the Trigger is Pulled, Handle With Care.

If for some reason the ammunition doesn't fire when you pull the trigger, stop and remember the 1st Commandment of Firearm Safety – always keep the muzzle pointed in a safe direction. Keep your face away from the breech, then put the safety on, carefully open the action, unload the firearm and dispose of the cartridge safely. Remember that anytime there's a shell in the chamber, your gun is loaded and ready to use. Even if you tried to shoot and your gun didn't fire, treat your firearm as if it could still discharge.

7th COMMANDMENT

Always Wear Eye and Ear Protection When Shooting.

Your sight and hearing risk injury from shooting and should be protected at all times. Wear protective shooting glasses to guard against falling shot, clay target chips, powder residue, ruptured cartridge cases and even twigs and branches in the field. Also be sure to wear eye protection when you're disassembling or cleaning a gun so that tensioned parts (like springs) and cleaning solvents don't come in contact with your eyes. Continued exposure to shooting noise can permanently damage your hearing. On the range, where shooting volume is the loudest, be sure to use the maximum protection of a headset. And learn to use ear protection in the field, especially in confined locations like duck blinds.



8th COMMANDMENT

Be Sure the Barrel is Clear of Obstructions Before Shooting.

Before loading your gun, open the action and make sure there's no ammunition in the chamber or magazine. Check the barrel for any obstructions or debris. Even a small amount of snow, mud, excess lubricant or grease in the bore can dangerously increase pressure and cause the barrel to bulge or burst when firing. Use a cleaning rod and patch to wipe away anti-rust compounds or any other residues or obstructions in the barrel. Never try to shoot out an obstruction by loading another shell and firing!

When firing, rely on your instincts. If the noise or recoil of your firearm seems weak, stop everything, unload your firearm and be sure nothing is lodged in the barrel. Remember the 12/20 burst? That's what can happen when the barrel is obstructed. So always be sure you're using the correct ammunition in your firearm and that it's free of obstructions.

9th COMMANDMENT

Don't Alter or Modify Your Gun and Have it Serviced Regularly.

Your firearm has been designed to operate according to certain factory specifications. You'll jeopardize your safety and that of others around you by attempting to alter its trigger, mechanical safety or other mechanisms. So never alter or modify your firearm in any way.



Like any mechanical device, a firearm is subject to wear. It must be maintained and periodically serviced to assure optimum safety and performance. Only a qualified service facility should service, repair or modify your Remington® firearm. Consult your instruction book for instructions on how to send your firearm to the factory or for the location of the nearest Remington Authorized Service Center.

Proper cleaning and lubrication are also important to firearm maintenance and are necessary to assure accuracy, safety and reliability. Before cleaning, always make sure that your gun is completely unloaded. And always clean the barrel from the chamber end to the muzzle when possible.

Make it a practice to clean your bore every time you're going to shoot. Be sure to clean your entire gun before and after long-term storage and no less than once a year. It's also important to clean your gun whenever it's been exposed to adverse conditions such as rain, dirt, mud, snow, sleet or saltwater.

For safe and dependable operation of your firearm, all parts of your gun must be properly cleaned and lubricated. Periodically inspect the internal workings of your firearm to be sure they're clean and free of rust, unwanted dirt and debris.

Use recommended lubricants on your gun and do not over-lubricate. Excessive use of a non-recommended lubricant could adversely affect the function and safe operation of your firearm. Remember, you are responsible for the proper care and maintenance of your firearm. Failure to properly maintain your firearm can not only damage or ruin your firearm, it can expose you and others to unnecessary risks of personal injury or death.

Remington® has a wide range of firearm care products and resources for best results when cleaning your gun. Everything from solvents and lubricants to rods and patches. They're all available from your Remington dealer.

10th COMMANDMENT

Learn the Mechanics and Handling Characteristics of Your Firearm.

Not all guns are alike. They have different mechanical characteristics that dictate how you should carry and handle them. Anyone who plans to use a firearm should first become totally familiar with the type of firearm it is and the safe handling procedures for loading, unloading, carrying, shooting and storing it.

Before you even unpack your new Remington firearm, read this instruction book from cover to cover and familiarize yourself with the different component parts of the gun. Then read, understand and follow the Ten Commandments of Firearm Safety in this book.

WARNING! Discharging firearms in poorly ventilated areas, cleaning firearms or handling ammunition may result in exposure to lead, a substance known to cause birth defects, reproductive harm, cancer and other serious physical injury. Have adequate ventilation at all times. Wash hands thoroughly after exposure.



SHOOT SOBER!!

There's one other rule that must be followed when handling firearms. In fact, respect for this rule is necessary in order to effectively practice the Ten Commandments of Firearm Safety. The rule is: SHOOT SOBER! Guns and alcohol or drugs make a deadly combination. Never consume anything that would even mildly impair your judgment or physical coordination when you're using a firearm. A staggering percentage of the shooting accidents that occur every year involve alcohol or drugs. Be smart. Always shoot sober and stay alive.

WARNING! Failure to follow any of these safety rules may cause personal injury or death to the shooter or bystander and damage to property. Do not use a firearm until you fully understand and practice the Ten Commandments of Firearm Safety. If you have any questions about the safe use of a Remington firearm, write to us at Remington Arms Company, Inc., Consumer Service, P.O. Box 700, Madison, NC 27025-0700, or call us at 1-800-243-9700.

DON'T KEEP THIS TO YOURSELF.

Now that you're a gun owner you have the obligation to help ensure that shooting sports are safe for everyone – participants and bystanders alike. You can do that by practicing these principles of firearm safety and passing them on to others – especially new shooters. Set an example for beginners. Be a guide to their safe entry into the exciting world of shooting sports. Invest your time and patience for the love of the sport and for its future. After all, it's your love of the sport that led you to buy a new Remington.

Firearm ownership is a right and privilege. It's a right guaranteed in this nation's Constitution. It's a privilege which carries with it a personal responsibility to use your firearm in a way which will ensure your safety and the safety of others. The preservation of this right and privilege depends on the personal commitment of you and your fellow shooters to the safe and responsible use of firearms. Let the Ten Commandments of Firearm Safety outlined in the book guide you at all times. Teach and promote these rules whenever you can. Remember, firearm safety depends on you! That's the only way to really enjoy your new Remington firearm and to preserve sport shooting as we know it today.

Remington® Bolt Action Centerfire Rifle

Congratulations on your choice of a Remington®. With proper care, it should give you many years of dependable use and enjoyment. For best results, we recommend that you use Remington Ammunition – the ammunition used in factory testing your firearm against our exacting function and performance standards.

PICTURE 1 This picture shows the main parts of a REMINGTON BOLT ACTION RIFLE. The picture will aid in understanding the instructions in this book.

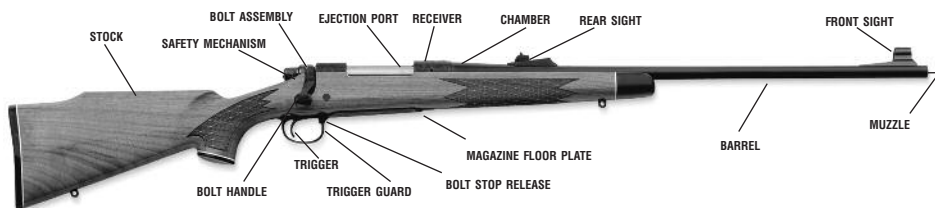

PICTURE 2
This picture shows the parts of the ammunition.

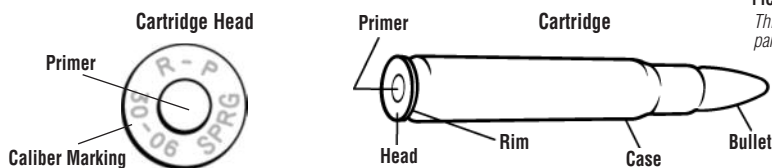

Important Parts of the Firearm The Safety Mechanism

The safety mechanism provides protection against accidental or unintentional discharge under normal usage when properly engaged and in good working order. The safety mechanism is not a substitute for following the rules of safe gun handling.

PICTURE 3

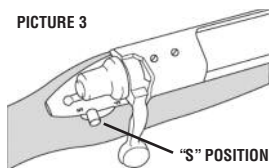

To engage the safety mechanism, pull the safety mechanism fully to the rear towards the 'S' position. See Picture 3.

Always put the safety mechanism in the 'S' position before handling, loading or unloading the firearm.

When you are ready to fire the firearm, push the safety mechanism forward towards the 'F' position to disengage the safety mechanism. See Picture 4.

Do not touch the trigger while moving the safety mechanism. Your fingers and all other objects should be kept outside of the trigger guard and away from the trigger until you are actually ready to fire by pulling the trigger.

Never pull the trigger when the safety mechanism is in the 'S' position.

WARNING! The firearm will fire when the trigger is pulled and the safety mechanism is in the 'F' position. Even when the safety mechanism is in the 'S' position, careless handling can cause the firearm to fire. SEE THE TEN COMMANDMENTS OF FIREARM SAFETY ON PAGE 2.

PICTURE 4

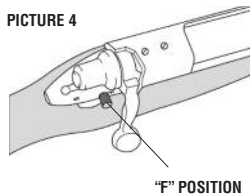

The Security System

A SECURITY SYSTEM DOES NOT ELIMINATE THE NEED FOR SAFE GUN HANDLING AND STORAGE, INCLUDING KEEPING THIS AND EVERY GUN UNLOADED AND LOCKED IN A SECURE PLACE WHEN NOT IN USE. READ AND FOLLOW THESE AND OTHER SAFETY RULES IN THIS INSTRUCTION BOOK. FAILURE TO READ, UNDERSTAND AND OBEY THESE RULES CAN RESULT IN SERIOUS PERSONAL INJURY OR DEATH. SEE THE TEN COMMANDMENTS OF FIREARM SAFETY ON PAGE 2.

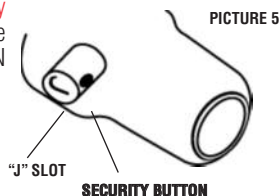

The firearm you have purchased is equipped with either an integrated security system or with a separate locking device.

The separate locking device included with your firearm will be packaged with its own instructions.

The integrated security system locking device instructions are described below.

This security system enables the owner to secure the bolt assembly on the firearm in the action open position with the use of a special key.

The integrated security system provided with this firearm will not allow the bolt to be closed when the security system is engaged.

The existence of the security system does not change the function of the firearm's safety mechanism. See page 7.

Once the bolt assembly is installed, on the left side of the firearm you will see a security button on the bolt plug of the bolt assembly. See Picture 5 on page 7.

On the security button there is a "J" shaped slot. This "J" slot is the key hole for engaging and disengaging the security system. Also on the sides of the security button you will see a RED and a WHITE indicator dot. When the security button is viewed from the rear of the firearm, the dot indicates whether or not the security system is engaged or disengaged. If the RED dot is visible from the rear of the firearm, the security system is disengaged and the bolt can be cammed into the firing position. (See this page and page 9 for instructions on closing and opening the bolt.) If the WHITE dot is visible from the rear of the firearm, the security system is engaged and the bolt cannot be cammed into the firing position.

To engage the security system the bolt must be installed in the firearm. **NEVER ATTEMPT TO ENGAGE OR DISENGAGE THE INTEGRATED SECURITY SYSTEM ("ISS") WHEN THE BOLT IS CAMMED IN THE FIRING POSITION.** With your new firearm you will receive two (2) keys. If your key has a cap, remove the cap before using. See Picture 6.

When the white dot is visible from the rear of the firearm the security system is engaged. To disengage the security system, push the key into the "J" slot with the **bolt assembly in the open position**. BE SURE TO PUSH THE KEY IN AS FAR AS IT WILL GO. Once the key is in place turn it counter-clockwise as far as it will go. From the rear of the firearm you will now see a RED dot. Once the red dot is in place remove the key.

THE SECURITY SYSTEM IS NOW DISENGAGED AND THE BOLT CAN BE CLOSED AND CAMMED INTO THE FIRING POSITION.

To engage the security system, **FIRST ENSURE THAT THE BOLT IS IN THE OPEN POSITION**, then push the key into the "J" slot. Once the key is in place turn it clockwise as far as it will go. From the rear of the firearm you will now see a WHITE dot. See Picture 7. Once the white dot is in place remove the key. **THE SECURITY SYSTEM IS NOW ENGAGED AND THE BOLT CANNOT BE CAMMED INTO THE FIRING POSITION.**

IMPORTANT: ISS will not lock the firearm unless engaged with the bolt open. Do not attempt to engage ISS when bolt is closed.

In operating the security button, NEVER use excessive force to turn the key. If the key will not turn freely, contact a Remington® Authorized Service Center.

Keep your security system engaged when your firearm is not in use. Keep your keys in a secure place, inaccessible to others. DO NOT leave your keys or any ammunition with your firearm, which should be kept unloaded and locked in a safe place. You know you have properly engaged the system when the bolt will not close.

If you lose the keys DO NOT attempt to disengage the security system using a foreign object. This will damage your firearm. Contact your Remington Authorized Service Center for a replacement key. Even if you think the security system is engaged, careless handling can cause the firearm to fire. SEE THE TEN COMMANDMENTS OF FIREARM SAFETY ON PAGE 2.

PICTURE 6



PICTURE 7

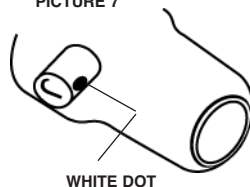

To Install Bolt Assembly: The bolt assembly locks the cartridge into the chamber.



1. Always point the firearm in a safe direction.
2. Put the safety mechanism in the 'S' position.
3. Align the lugs on the bolt assembly with the receiver. See Picture 8.
4. Slide the bolt assembly into the receiver and push all the way in.
5. To place the bolt assembly in closed position, push the bolt handle down.

NOTE: The security system must be disengaged to close the bolt. **Red dot will show.**

To Remove Bolt Assembly:

1. Always point the firearm in a safe direction.
2. Put the safety mechanism in the 'S' position.
3. Do not touch the trigger while moving the safety mechanism.
4. Raise the bolt handle.
5. Pull the bolt handle all the way back.
6. Push bolt stop release in trigger guard. See Picture 8.
7. Slide the bolt assembly from the firearm.

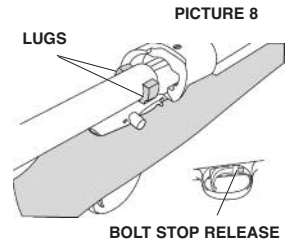

The Trigger Assembly

Pulling the trigger fires the firearm. The trigger assembly on your rifle may permit the adjustment of the trigger pull force by the user (see Picture 9 to determine if your trigger assembly is user adjustable). On rifles that are so equipped, the trigger pull force is adjustable without removing the action from the stock.

WARNING! Only the trigger pull force is adjustable. For safety's sake, **NEVER** make adjustments or alterations to any other parts of the trigger assembly or rifle.

WARNING! NEVER put your finger on the trigger unless you are going to fire the firearm.

TRIGGER PULL FORCE
ADJUSTMENT SCREW

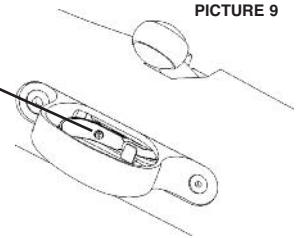

To Adjust Trigger Pull Force:

The trigger of your rifle has been preset at the factory in conformity with industry guidelines to have a trigger pull force of at least 3 pounds. However, for competition target shooters firing the rifle from a secure stationary rest in a controlled environment, the trigger pull force can be adjusted downward by the user or a qualified gunsmith using the procedure set forth below.

WARNING! Adjustment of the trigger pull force in this rifle below 3 pounds should only be made for a rifle to be used in competitive target shooting and fired from a secure stationary rest in a controlled environment. For any other purpose, including use in the field, the trigger pull force on your rifle should **NEVER** be reduced below 3 pounds. Remember – regardless of the amount of trigger pull force, **ALWAYS** keep the muzzle of your rifle pointed in a safe direction to prevent injury or death caused by an unintended or accidental discharge.

WARNING! With the safety mechanism in the **S-SAFE** position, check the chamber and magazine of the rifle to make sure there are no cartridges in the rifle. **NEVER** attempt to adjust the trigger pull force on a loaded rifle.

1. To adjust the trigger pull force, place the provided wrench's hex key in the socket of the adjustment screw. A standard 1/16" hex key can also be used to make this adjustment.
2. Adjust the trigger pull force to the desired setting by turning the adjustment screw. Turning the trigger pull adjustment screw counterclockwise will lighten the trigger pull force. Turning the trigger pull adjusting screw clockwise will increase the trigger pull force. Trigger pull will change by approximately 1 lb for each full turn of

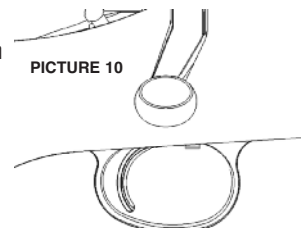

the adjustment screw.

3. After making an adjustment, remove the wrench from the socket of the adjustment screw.
4. Dry fire the rifle several times after making an adjustment to ensure the trigger pull force spring is reseated.
5. Check the trigger pull force with a force gauge or deadweight.
6. Repeat step 5 several times to ensure the proper trigger pull force is maintained.
7. If the setting is satisfactory, the adjustment is complete. If the setting is unsatisfactory, follow the instructions outlined in steps 2–6 until you are satisfied.

WARNING: If proper trigger pull force cannot be maintained from pull to pull, then return the firearm to the factory for service. Do not use your rifle if the trigger pull force can not be maintained.

WARNING: The minimum achievable trigger pull force is preset at the factory and must not be altered.

WARNING: Be sure to note if you have adjusted the trigger pull force below 3 pounds when you store your rifle for any period of time. If you expect at any time to loan or sell your rifle or to use the rifle for anything other than competition target shooting from a secure, stationary rest in a controlled environment, you should readjust the trigger pull force to at least 3 pounds.

The Barrel

The inside of the barrel must be clean and free of obstructions.

I. TO CHECK THE INSIDE OF THE BARREL:

1. Always point the firearm in a safe direction.
2. Put the safety mechanism in the 'S' position.
3. Raise the bolt handle.
4. Pull the bolt all the way back.
5. Remove any ammunition from the chamber or magazine. See page 12.
6. Remove the bolt.
7. Look through the inside of the barrel from the chamber end to the muzzle. See Picture 1 on page 7.

II. TO REMOVE OBJECT FROM INSIDE THE BARREL:

1. Use correct size cleaning rod.
2. Push cleaning rod from the chamber end all the way through the barrel, until the rod comes out of the muzzle.
3. If an object cannot be easily pushed out of the barrel with a cleaning rod, return the firearm to the factory or a REMINGTON AUTHORIZED SERVICE CENTER.

WARNING! NEVER try to remove an object from the barrel by loading another cartridge and firing. This may cause the barrel to burst or a cartridge case to rupture and cause serious personal injury or death.

III. TO CLEAN THE BARREL FOLLOW THE INSTRUCTIONS SHOWN ON PAGE 14.

Before loading the firearm, make sure the inside of the barrel is free of dirt or other obstructions.

To Load the Firearm

There are three types of Model 700 rifles: one with a FLOOR PLATE, one without a FLOOR PLATE and one with a DETACHABLE MAGAZINE BOX.

I. TO LOAD ONE CARTRIDGE ONLY:

1. Always point the firearm in a safe direction.
2. Put the safety mechanism in the 'S' position.
3. Raise the bolt handle.
4. Pull the bolt handle all the way back.

SPECIAL NOTICE

220 SWIFT LOADING INSTRUCTIONS

Unlike other cartridges the 220 SWIFT is a semi-rimmed cartridge. Therefore, to ensure proper feeding, make sure that the rim of the top cartridge is ahead of the rim of the cartridge below.

RIGHT

WRONG

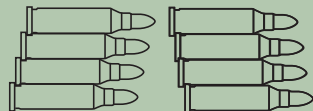

- Put one cartridge of the correct caliber on the magazine follower or in the chamber. See Picture 11.
- Slide the bolt handle forward, then push the bolt handle down to lock the cartridge into the chamber.

THE FIREARM IS NOW LOADED WITH A ROUND IN THE CHAMBER.

- To prepare to fire, put the safety mechanism in the 'F' position.

THE FIREARM IS READY TO FIRE.

II. TO LOAD THE CHAMBER AND MAGAZINE:

- Always point the firearm in a safe direction.
- Put the safety mechanism in the 'S' position.
- Raise the bolt handle.
- Pull the bolt handle all the way back.
- Push four cartridges of the correct caliber, one at a time, into the magazine. If the firearm is a magnum, you can only load three cartridges. If the firearm is a 17, 222, or 223 caliber, the magazine will hold five cartridges. Keep the bullets aligned toward the chamber. See Picture 11.
- Put one cartridge into the chamber.
- Use your fingers to push the cartridges in the magazine all the way down. Slowly slide the bolt assembly forward so that the bolt slides over the top of the cartridges in the magazine.
- Push the bolt handle down.

THE CHAMBER AND MAGAZINE ARE NOW FULLY LOADED.

WARNING! Always check the cartridge for the correct caliber before loading the firearm.

- To fire the firearm put the safety in the 'F' position.

THE FIREARM IS READY TO FIRE.

ALTERNATE METHOD TO LOAD THE CHAMBER AND MAGAZINE: (FOR MODELS 700[®] WITH DETACHABLE MAGAZINE BOX)

- Always point the firearm in a safe direction.
- Put the safety mechanism in the 'S' position.
- Raise the bolt handle.
- Pull the bolt handle all the way back.
- Press both magazine latches inward and pull the magazine box from the firearm. See Picture 12.
- Push four cartridges of the correct caliber, one at a time, into the magazine box, pushing the cartridges to the rear of the magazine. If the firearm is a magnum, you can only load three cartridges. Keep the bullets aligned toward the chamber. See Picture 11.
- Place the magazine box into the trigger guard opening and push it until both latches snap into the fully latched position.

THE MAGAZINE IS NOW FULLY LOADED.

- Put one cartridge of the correct caliber into the chamber. See Picture 11.
- Use your fingers to push the cartridges in the magazine all the way down. Slowly slide the bolt assembly forward so that the bolt slides over the top of the cartridges in the magazine.
- Push the bolt handle down to lock the cartridge into the chamber.

THE CHAMBER AND MAGAZINE ARE NOW FULLY LOADED.

- To prepare to fire, put the safety mechanism in the 'F' position.

THE FIREARM IS READY TO FIRE.

WARNING: Always check the cartridge for the correct caliber before loading the firearm.

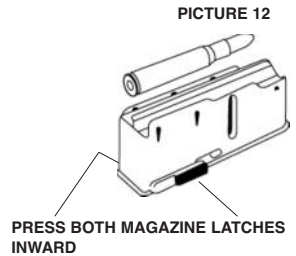
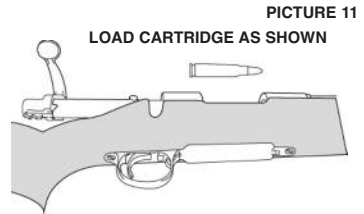

To Unload the Firearm

There are three types of Model 700™ rifles: one with a FLOOR PLATE, one without a FLOOR PLATE and one with a DETACHABLE MAGAZINE BOX.

INSTRUCTIONS FOR THE MODELS WITH A FLOOR PLATE:

1. Always point the firearm in a safe direction.
2. Put the safety mechanism in the 'S' position.
3. Raise the bolt handle.
4. Put one hand over the top of the ejection port.
5. Slowly pull the bolt handle rearward with your other hand to remove the cartridge from the chamber.
6. Hold cartridge and remove it from the firearm.
7. Put the safety mechanism in the 'S' position.
8. Put your hand under the floor plate.
9. Push the floor plate latch to release the floor plate. See Picture 13 for Model 700 or Picture 14 for the Model Seven™ & Model 673™. The magazine spring and follower will be released from the magazine.
10. Remove released cartridges.
11. Push in the magazine follower, then close the floor plate.

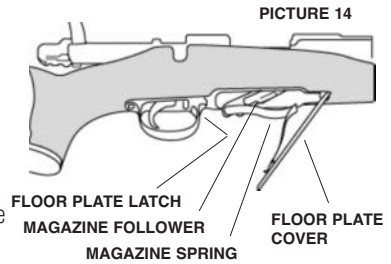
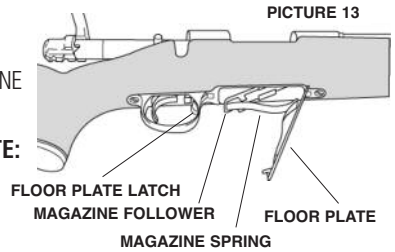

WARNING: Check the chamber and the magazine to make sure there are no cartridges in the firearm.

INSTRUCTIONS FOR THE MODELS WITHOUT A FLOOR PLATE:

1. Always point the firearm in a safe direction.
2. Put the safety mechanism in the 'S' position.
3. Raise the bolt handle.
4. Put one hand over the top of the ejection port.
5. Slowly pull the bolt handle rearward with your other hand to remove the cartridge from the chamber.
6. Hold cartridge and remove it from the firearm.
7. Always keep the muzzle pointed in a safe direction. Push the bolt handle slowly forward until the cartridge is released from the magazine.

CAUTION: The cartridge may slide into the chamber if the bolt is pushed too far forward. See **NOTE** below.

8. Pull the bolt handle fully back and remove the cartridge from the ejection port.
9. Repeat Steps 7 and 8 until the magazine is empty.

WARNING! Check the chamber and the magazine to make sure there are no cartridges in the firearm.

NOTE: If the bolt is pushed all the way forward and a cartridge slides into the chamber, the gun can be fired. Normally, the cartridges will slide out of the chamber when the bolt is pulled back. If the cartridge remains in the chamber, point the muzzle in a safe direction, slide the bolt forward all the way and push the bolt handle down to close the bolt. Then repeat Steps 1 through 9 above.

INSTRUCTIONS FOR THE MODELS WITH A DETACHABLE MAGAZINE BOX:

1. Always point the firearm in a safe direction.
2. Put the safety mechanism in the 'S' position.
3. Raise the bolt handle.

4. Put one hand over the top of the ejection port.
5. Slowly pull the bolt handle rearward with your other hand to remove the cartridge from the chamber.
6. Depress both latches to release magazine box. See Picture 12 on page 11.
7. Remove all cartridges from the magazine box.
8. Replace the magazine box.

WARNING! Check the chamber and the magazine to make sure there are no cartridges in the firearm.

To Adjust Sights



TO ADJUST THE REAR SIGHT:

Move the rear sight in the same direction as you need to move the bullet on the target. See Picture 15.

All models with sights are adjusted at the factory to hit a target at 100 yards.

NOTE: For more on ballistics and trajectory, see the REMINGTON® catalog.

For the Model 673™ ONLY. The rear sight elevation screw is located ahead of the rear sight aperture. The point of aim is adjusted by using a 1/16" hex wrench. To raise the point of impact turn the elevation screw clockwise. See Picture 15a.

The ventilated rib is screwed to the barrel and is isolated through the use of synthetic buffers, both above and below the rib. The design allows the rib to "float". In this way the barrel moves independently of the rib ensuring accuracy. Disassembly is **not** recommended.

TELESCOPIC SIGHTS:

The top of the receiver has holes for the installation of telescopic sights.

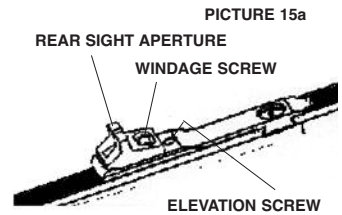
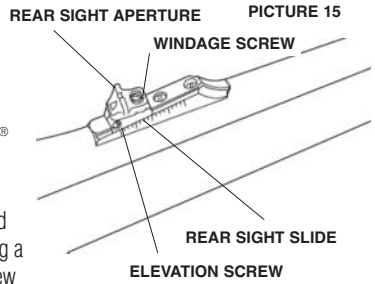

Lubrication and Maintenance



When the firearm is to be stored, it should be carefully cleaned and thoroughly oiled. Outside surfaces should be wiped with a light coat of Rem™ Oil occasionally. When

firearm is to be reused, all excess lubrication must be removed. The chamber and bore must be thoroughly wiped dry.

NOTE: Remington® Rem™ Oil is available from your local dealer. If your dealer is out of stock, ask him to order Rem™ Oil from his Remington distributor.

POSITION ON TARGET	ADJUSTMENT
 Bullet hits above the center.	<ol style="list-style-type: none"> a. Loosen the elevation screw on the right side. b. Slide the rear sight down (backward) on the ramp. c. Tighten the elevation screw.
 Bullet hits below the center.	<ol style="list-style-type: none"> a. Loosen the elevation screw on the right side. b. Slide the rear sight up (forward) on the ramp. c. Tighten the elevation screw.
 Bullet hits to the left.	<ol style="list-style-type: none"> a. Loosen the windage screw on the right side. b. Slide the rear sight aperture to the right. c. Tighten the windage screw.
 Bullet hits to the right.	<ol style="list-style-type: none"> a. Loosen the windage screw on the right side. b. Slide the rear sight aperture to the left. c. Tighten the windage screw.

To Clean the Barrel

WARNING! Check the chamber and magazine to make sure there are no cartridges in the firearm.

1. Use the equipment provided in a good cleaning kit. For recommendations, see your REMINGTON AUTHORIZED SERVICE CENTER.
2. Remove the bolt assembly. See instructions on page 9.
3. Select the correct caliber cleaning brush and attach the brush to the cleaning rod.
4. Put the cleaning brush into the gun cleaning solvent.

NOTE: Barrel should lay horizontally with the ejection port facing down during cleaning. Always clean the barrel from the chamber end to the muzzle.

5. Push the cleaning brush through the barrel several times.
6. Remove brush from rod, attach tip with patch, and push through the bore.
7. Repeat several times, using a new cleaning patch each time, until the patch is not dirty.
8. Push a clean patch saturated with Rem™ Oil through the barrel.
9. Push a clean dry patch through the barrel to remove excess lubricant.
10. Apply a thin coat of Rem™ Oil to the outside of the barrel with a soft clean cloth.
11. After cleaning the barrel, clean the receiver and the trigger assembly.

WARNING! This firearm should be checked periodically by the Remington Arms Company, Inc. or a REMINGTON AUTHORIZED SERVICE CENTER. This will ensure proper inspection and any necessary replacement of worn or damaged parts.

To Clean the Receiver and Trigger Assembly

1. Always point the firearm in a safe direction.
2. Put the safety mechanism in the 'S' position.
3. Remove the bolt assembly. See instructions on page 9.
4. Turn the rifle upside down.
5. Remove the stock screws. See Picture 16.
6. Lift the stock away from the receiver and trigger assembly.

MODELS WITHOUT A FLOOR PLATE ONLY:

Remove the magazine spring and follower from the receiver.

NOTE: Clean and lubricate the receiver and trigger assembly as a unit. Do not remove the trigger assembly from the receiver.

7. Thoroughly spray the receiver inside and out with Rem™ Action Cleaner and allow to dry.
8. Thoroughly spray inside the trigger assembly at the four points specified in Picture 17 with Rem Action Cleaner.
9. Place the safety in the fire "F" position. Pull the trigger rearward and release multiple times.
10. Pull and hold the trigger rearward. Then using a small punch or screwdriver depress the sear (Lubrication Point 1 in Picture 17) and release multiple times.
11. Release the trigger and operate the safety from the fire "F" to the safe "S" position multiple times.
12. Again thoroughly spray inside the trigger assembly at the four points specified in Picture 17 with Rem™ Action Cleaner. Air dry or use compressed air to thoroughly dry the trigger assembly.

PICTURE 16

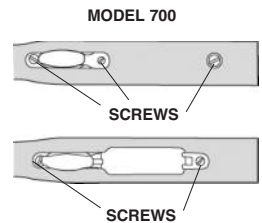

MODEL SEVEN & 673

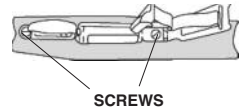

PICTURE 17

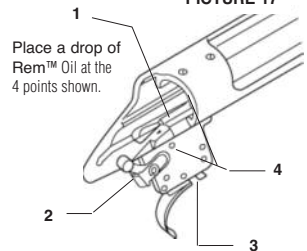

13. Place a drop of Rem™ Oil in each of the four points in the trigger assembly specified in Picture 17.
14. Place the safety in the fire “F” position. Pull the trigger rearward and release multiple times. Ensure the trigger returns completely to the forward position each time. **If the trigger does not completely return, reassemble the rifle and return it to a Remington® Authorized Service Center.**

WARNING! If the trigger does not fully return to the forward position each time it is released, then your rifle is NOT in a safe operating condition and it must NOT be used until you have had it inspected by a Remington Authorized Service Center. Use of a firearm in an unsafe operating condition may result in injury or death to you or a bystander and severe damage to the firearm.

15. If the trigger completely returns as specified in operation 14, pull and hold the trigger rearward and using a small punch or screwdriver depress the sear and release multiple times. The sear must return to the full upward position without hesitation. **If the sear does not freely return, reassemble the rifle and return it to a Remington Authorized Service Center.**

WARNING! If the sear does not return to the full upward position without hesitation, then your rifle is NOT in a safe operating condition and it must NOT be used until you have had it inspected by a Remington Authorized Service Center. Use of a firearm in an unsafe operating condition may result in injury or death to you or a bystander and severe damage to the firearm.

16. If the sear freely returns to the full upward position as specified in operation 15, release the trigger and operate the safety from the fire “F” to the safe “S” position multiple times. The safety must operate freely. The safety detent spring must position the safety in the full safe “S” or fire “F” position. The safety should not remain in a position anywhere between the full safe “S” or fire “F” position. If the safety does not freely return to the full safe “S” or fire “F” position, repeat operations 8 thru 16. **If the safety does not freely return to the safe “S” or fire “F” position after repeating operations 8 thru 16, return the firearm to a Remington Authorized Service Center for an inspection of the safety and trigger assembly.**
17. Place the safety in the safe “S” position and lightly spray Rem™ Oil on all the external surfaces of the trigger assembly and receiver. Wipe off excess oil.

TO ASSEMBLE MODELS WITHOUT A FLOOR PLATE:

1. Always point the firearm in a safe direction.
2. Put the magazine follower and the spring into the magazine.
3. Put the stock over the receiver and trigger assembly.
4. Replace and tighten the trigger guard (stock) screws.

WARNING! Before you replace the bolt assembly, make sure the barrel is free from obstructions.

5. Replace the bolt assembly. See instructions on page 9.

TO ASSEMBLE MODELS WITH A FLOOR PLATE ONLY:

Put the magazine all the way into the bottom of the receiver.

MODELS WITH FLOOR PLATE OR DETACHABLE MAGAZINE:

1. Always point the firearm in a safe direction.
2. Assemble the trigger guard assembly on the stock.
3. Put the stock over the receiver and trigger assembly.
4. Replace and tighten the trigger guard (stock) screws.
5. Close the floor plate or replace detachable magazine.

WARNING! Before you replace the bolt assembly, make sure the barrel is free of obstructions.

6. Replace the bolt assembly. See Instructions on page 9.

WARNING! After cleaning the trigger assembly, check the chamber and magazine to make sure there are no cartridges in the firearm. Put the safety mechanism in the ‘F’ position. Close the bolt smartly. The firing pin must remain cocked. To check, pull the trigger. The firing pin must fall. Repeat the test at least ten times. If the firing pin will not remain cocked when the bolt is closed smartly, return the firearm to the factory or a REMINGTON AUTHORIZED SERVICE CENTER.

Cleaning Frequency

1. Before and after long term storage.
2. When the rifle has been subjected to adverse conditions such as shooting in the rain, snow, sleet or saltwater areas.
3. When the rifle is exposed to dirty conditions such as lying on the ground outdoors, being dropped in mud, etc.

NOTE: While the Model 700™ and Model Seven™ Stainless Synthetic Rifle have been designed and manufactured to provide improved corrosion protection, only proper care will keep your firearm in good operating condition and maintain its appearance. After extensive use, the protective coating on plated parts may be worn sufficiently to reduce corrosion protection. Such worn parts should be replaced to assure the integrity of the corrosion protection.

WARNING! After each use, follow the lubrication and maintenance direction in this instruction book. If the firearm is immersed in water, it must be thoroughly cleaned and lubricated as soon as possible. In case of salt- water immersion, first flush all parts with fresh water, then dry, clean and lubricate the firearm. If the firearm does not function properly, have it corrected by a REMINGTON® AUTHORIZED SERVICE CENTER before further use. Failure to follow this warning may lead to firearm malfunctions which could result in serious personal injuries or death and damage to the firearm.

Instructions for Cleaning the Bolt Assembly

TO DISASSEMBLE THE BOLT ASSEMBLY:

1. Always point the firearm in a safe direction.
2. Remove the bolt assembly from the firearm. See instructions on page 9.
3. Put the notch on the firing pin head over a metal edge. Pull the bolt assembly away from the firing pin. Put a coin into the slot near the back edge of the firing pin head. See Picture 18.
4. Hold the bolt assembly and turn the bolt plug counter-clockwise until the firing pin assembly can be removed from the bolt assembly.

CAUTION: Clean the firing pin assembly as a unit.

5. Clean all parts with gun cleaning solvent. Dry with a clean cloth.
6. Apply a thin coat of Rem™ Oil.

TO ASSEMBLE:

1. Always point the firearm in a safe direction.
2. Put the firing pin assembly into the rear of the bolt assembly.
3. Tighten the bolt plug into the bolt assembly with your hand.
4. Pull the coin from the slot in the firing pin head.
5. Turn the bolt plug until the firing pin head goes into the small notch on the rear rim of the bolt. The bolt is now cocked. See Picture 19.

NOTE: The bolt must be cocked to be assembled into the rifle.

6. Assemble the bolt assembly into the rifle. See instructions on page 9.

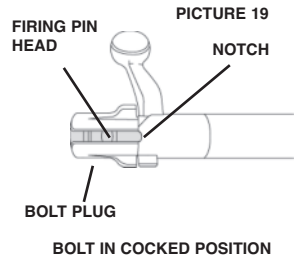
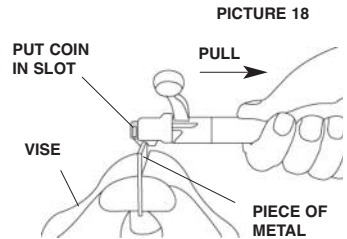

Parts Lists For Models 700, Seven & 673

MODEL 700™

Bolt Action Centerfire Rifle

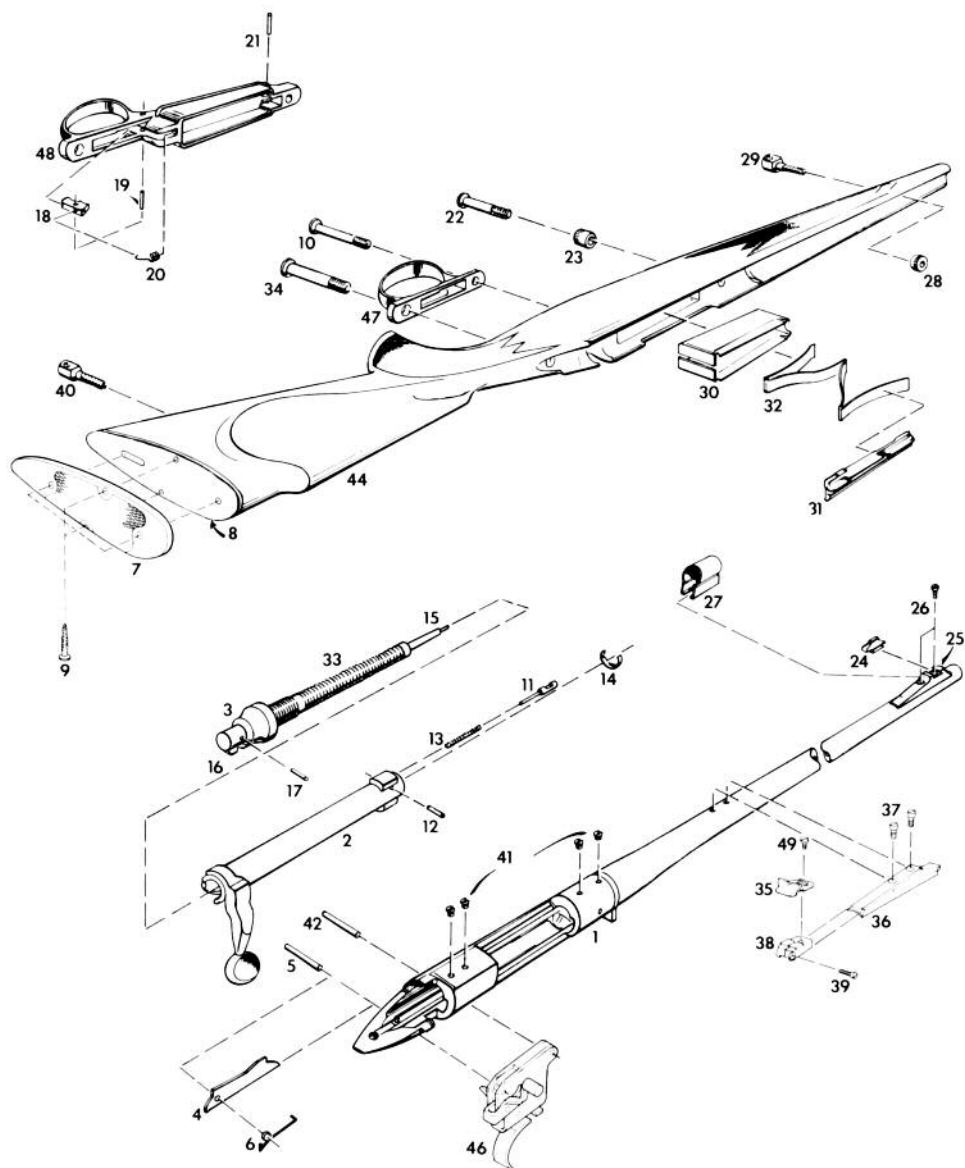

MODEL 700™

Bolt Action Centerfire Rifle

PARTS LIST

VIEW #	PART NAME	VIEW #	PART NAME
1	Barrel Assembly	30	Magazine, ADL Grade
2	Bolt Assembly		Magazine, BDL Grade (Not Shown)
3	Bolt Plug	31	Magazine Follower, ADL – Short Action
4	Bolt Stop (Restricted)		Magazine Follower, BDL
5	Bolt Stop Pin (Restricted)		Magazine Tab Screw, ADL Grade
6	Bolt Stop Spring (Restricted)	32	Magazine Spring, ADL Grade
7	Butt Plate		Magazine Spring, BDL Grade
	Butt Plate Frame (New Style Not Shown)	33	Main Spring
	Butt Plate Insert (New Style Not Shown)	34	Rear Guard Screw
	Butt Plate Frame Screw (New Style)	35	Rear Sight Aperture
8	Butt Plate Spacer		Rear Sight Assembly
9	Butt Plate Screw		Rear Sight Base
10	Center Guard Screw ADL Grade	37	Rear Sight Base Screw (2)
11	Ejector	38	Rear Sight Slide
12	Ejector Pin	39	Elevation Pin
13	Ejector Spring	40	Rear Swivel Screw
14	Extractor	41	Receiver Plug Screw
16	Firing Pin Assembly	42	Sear Pin (Restricted)
17	Firing Pin Cross Pin	44	Stock Assembly, ADL Grade
18	Floor Plate Latch, BDL Grade		Stock Assembly, BDL Grade
19	Floor Plate Latch Pin, BDL Grade		Stock Reinforcing Screw (Not Shown)
20	Floor Plate Latch Spring, BDL Grade		Stock Reinforcing Screw Dowel (Not Shown)
21	Floor Plate Pivot Pin, BDL Grade	46	Trigger Assembly (Restricted)
22	Front Guard Screw	47	Trigger Guard
23	Front Guard Screw Bushing, ADL Grade	48	Trigger Guard Assembly, BDL Grade
24	Front Sight	49	Windage Screw
	Front Sight (Low)		
25	Front Sight Ramp BDL		
26	Front Sight Ramp Screw		
27	Front Sight Hood		
29	Front Swivel Screw		
	Grip Cap, BDL Grade (Not Shown)		
	Grip Cap Screw		
	Grip Cap Spacer (Not Shown)		

MODEL SEVEN™

Bolt Action Centerfire Rifle

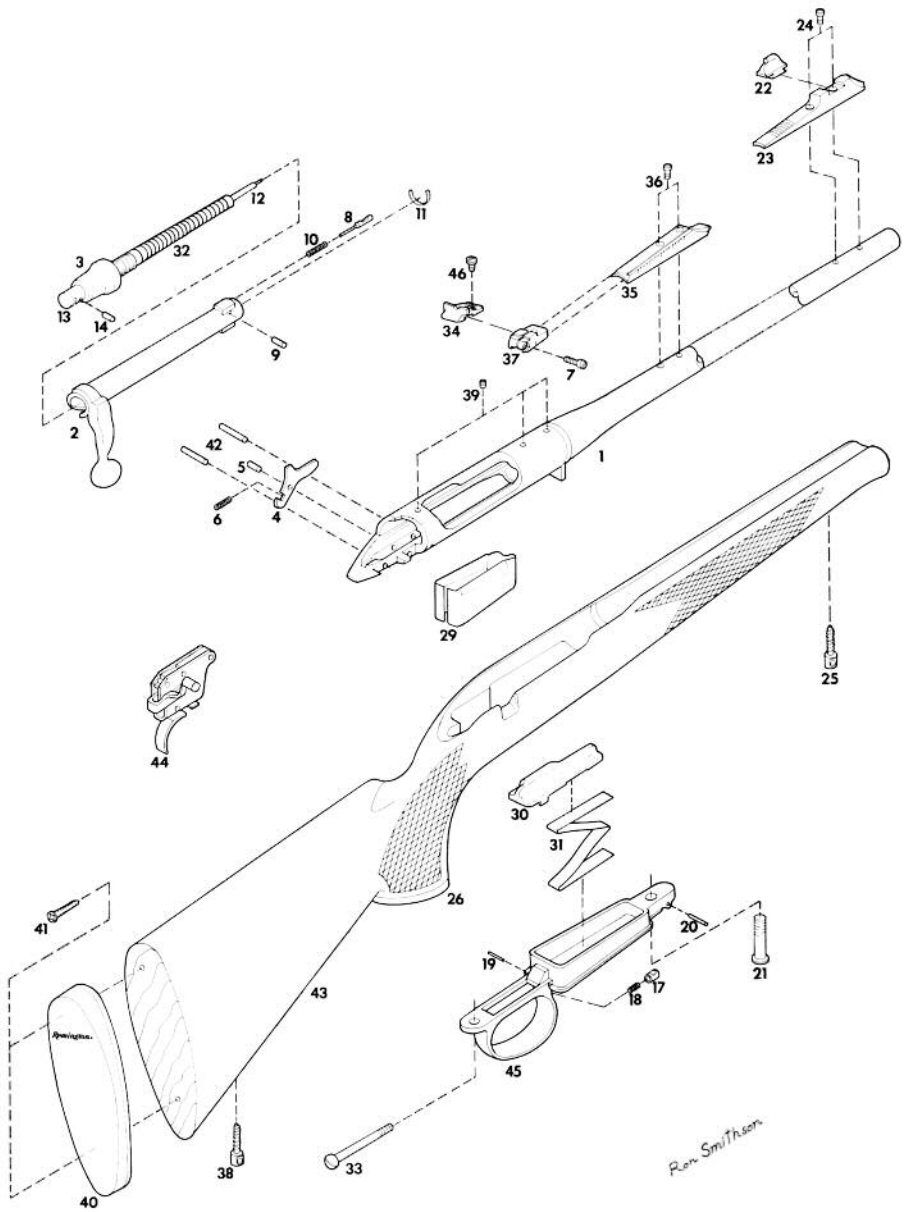

MODEL SEVEN™

Bolt Action Centerfire Rifle

PARTS LIST

VIEW #	PART NAME	VIEW #	PART NAME
1	Barrel Assembly	29	Magazine
2	Bolt Assembly		Magazine 222 Cal.
	Bolt Final Assembly	30	Magazine Follower
3	Bolt Plug		Magazine Follower 222 Cal.
4	Bolt Stop (Restricted)		Magazine Spacer 222 Cal.
5	Bolt Stop Pin (Restricted)	31	Magazine Spring
6	Bolt Stop Spring (Restricted)		Magazine Spring 222 Cal.
7	Elevation Screw	32	Main Spring
8	Ejector	33	Rear Guard Screw
9	Ejector Pin	34	Rear Sight Aperture
10	Ejector Spring		Rear Sight Assembly
11	Extractor	35	Rear Sight Base
	Extractor 222 Cal.	36	Rear Sight Base Screw (2)
12	Firing Pin (Restricted)	37	Rear Sight Slide
13	Firing Pin Assembly	38	Rear Swivel Screw
14	Firing Pin Cross Pin	39	Receiver Plug Screw
17	Floor Plate Latch	40	Recoil Pad
18	Floor Plate Latch Spring	41	Recoil Pad Screw
19	Floor Plate Latch Pin	42	Sear Pin (Restricted)
20	Floor Plate Pivot Pin	43	Stock Assembly
21	Front Guard Spring	44	Trigger Assembly (Restricted)
22	Front Sight	45	Trigger Guard Assembly
	Front Sight (Low)	46	Windage Screw
23	Front Sight Ramp		
24	Front Sight Ramp Screw		
25	Front Swivel Screw		
26	Grip Cap		
	Grip Cap Insert (Not Shown)		
	Grip Cap Screw (Not Shown)		

MODEL 673™

Bolt Action Centerfire Rifle

NOTE: The ventilated rib, synthetic buffers and rib screws are not shown.

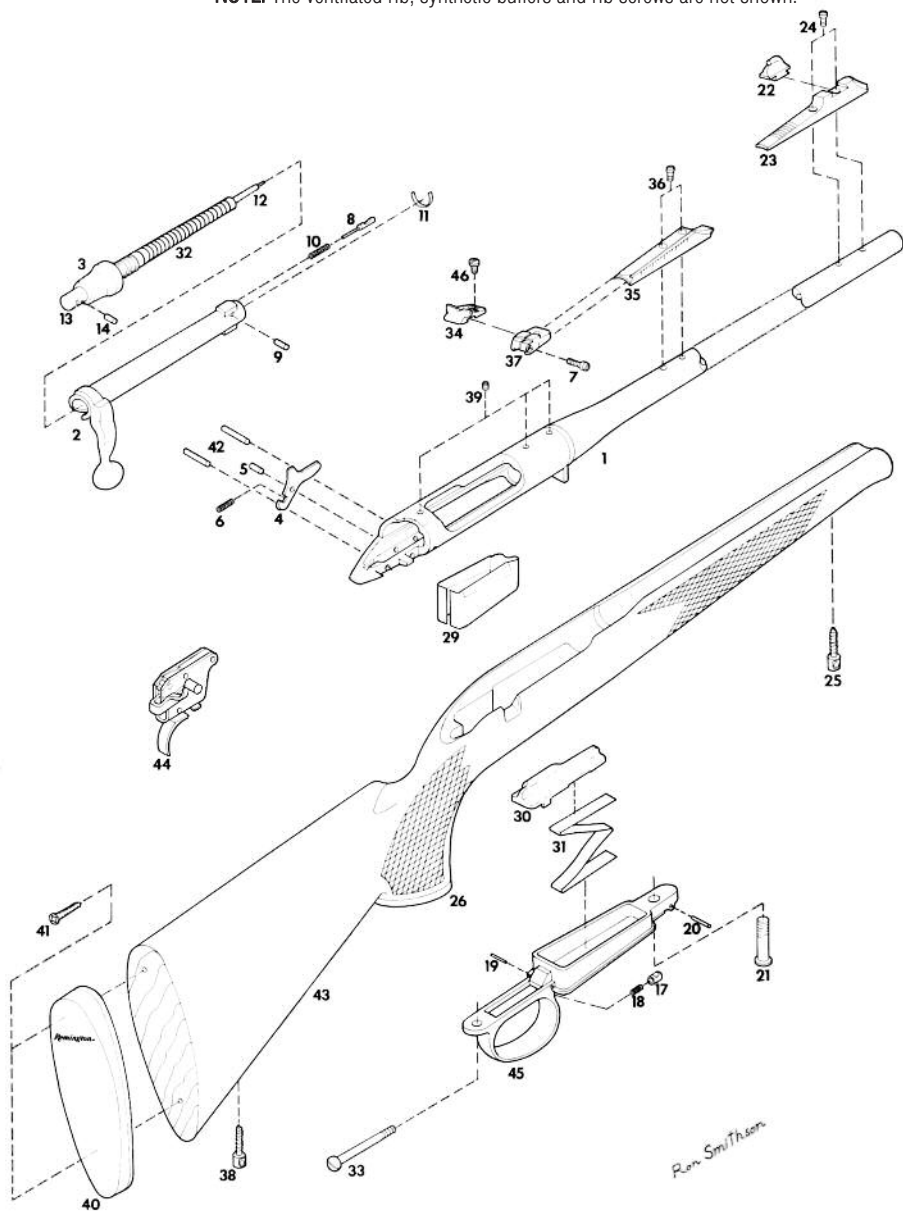

MODEL 673™

Bolt Action Centerfire Rifle

PARTS LIST

VIEW NO.	PART NAME
1	Barrel Assembly
2	Bolt Assembly
	Bolt Final Assembly
3	Bolt Plug
4	Bolt Stop (Restricted)
5	Bolt Stop Pin (Restricted)
6	Bolt Stop Spring (Restricted)
7	Elevation Screw
8	Ejector
9	Ejector Pin
10	Ejector Spring
11	Extractor
12	Firing Pin (Restricted)
13	Firing Pin Assembly
14	Firing Pin Cross Pin
17	Floor Plate Latch
18	Floor Plate Latch Spring
19	Floor Plate Latch Pin
20	Floor Plate Pivot Pin
21	Front Guard Spring
22	Front Sight
23	Front Sight Ramp
24	Front Sight Ramp Screw
25	Front Swivel Screw
26	Grip Cap
	Grip Cap Insert (Not Shown)
	Grip Cap Screw (Not Shown)
29	Magazine
30	Magazine Follower
31	Magazine Spring
32	Main Spring
33	Rear Guard Screw
34	Rear Sight Aperture
	Rear Sight Assembly
35	Rear Sight Base
36	Rear Sight Base Screw (2)
37	Rear Sight Slide
38	Rear Swivel Screw
39	Receiver Plug Screw
40	Recoil Pad
41	Recoil Pad Screw
42	Sear Pin (Restricted)
43	Stock Assembly
44	Trigger Assembly (Restricted)
45	Trigger Guard Assembly
46	Windage Screw

How to Obtain Parts and Service From Remington® Arms Co.

TO ORDER PARTS:

To order parts please visit www.remingtonpartsstore.com or call 1-800-243-9700. For additional information on service enhancements, upgrades, additional barrels and specialty parts visit www.remington.com.

To expedite your PARTS order or request REPAIR SERVICE visit our web site at www.remington.com. Detailed instructions are provided along with parts and/or service order forms. You may also reach Remington by calling our toll free customer service number, 1-800-243-9700, Mon.-Fri., 9:00 AM-5:00 PM Eastern time.

1. Fax completed order form (from the web site) to 1-336-548-7801.
2. To order by phone without the order form call 1-800-243-9700.

Please have the following information ready before you call.

- Firearm model and serial number.
- Part description and quantity. Part descriptions can be found on the parts listing page in this manual.
- Your complete mailing address (P.O. Box and Street Address) including zip code, telephone number and e-mail address.
- Method of payment: Mastercard, Visa, Amex or Discover card number and expiration date. Prepayment may be made by check or money order. A quote may be made to you over the phone. (Sorry, no C.O.D.s.)

WARNING! USE ONLY REMINGTON PARTS IN REMINGTON FIREARMS.

NOTE: SOME PARTS MAY BE RESTRICTED. See parts list for details. Owner's manuals/instruction books may be requested via our web site at: www.remington.com or by calling 1-800-243-9700.

REPAIR SERVICES

1. To locate the Remington Authorized Service Center nearest you visit our web site at www.remington.com and use our Repair Service Locator. If you need additional on-line assistance, e-mail us at info@remington.com to obtain a listing of Authorized Service Centers. Contact the Authorized Service Center of your choice for evaluation of your firearm and/or additional shipping instructions.
2. If your Remington Authorized Service Center cannot provide the service or repair you require and you need further assistance, please call our toll free number 1-800-243-9700, Mon.-Fri., 9:00 AM-5:00 PM Eastern time and select the option for repairs.
3. If shipment of your firearm is required please follow instructions below.
 - Record the serial number of your firearm before shipping.
 - Pack your firearm for safety and to prevent further damage in shipping and handling. Preferably, ship in a firearm box.
 - Remove all accessories from the firearm to prevent loss or damage.
 - Enclose a letter with the firearm detailing the model name or number of your firearm and serial number along with a full description of the problem. Be sure to include your full name and address (P.O. Box and Street Address), including zip code, daytime telephone number and e-mail address.
 - Ship your firearm by either United Parcel Service (UPS) or Parcel Post (US Post Office). Remington is not responsible for damage or loss during shipment, so you may elect to purchase insurance from your carrier.

WARNING! DO NOT SEND LIVE OR SPENT SHELLS IN YOUR FIREARM OR IN THE SAME BOX WITH THE FIREARM. THIS IS A VIOLATION OF FEDERAL LAW. IF YOU FEEL YOU MUST SEND SPENT SHELLS, PLEASE SEND THEM IN A SEPARATE PACKAGE AND INCLUDE NAME, ADDRESS (WITH ZIP CODE), TELEPHONE NUMBER, MODEL AND SERIAL NUMBER OF YOUR FIREARM.

Firearm Owner's Record

Model _____ Serial # _____ Date Purchased _____

Purchased From _____ Price Paid _____

Remember to complete and return the Firearm Warranty Registration Card in order to obtain full benefit of your Limited Two Year Firearm Warranty.

A WORD ON THE MAINTENANCE AND CARE OF YOUR REMINGTON FIREARM

Don't Alter or Modify Your Gun and Have it Serviced Regularly.

Your firearm has been designed to operate according to certain factory specifications. You'll jeopardize your safety and that of others around you by attempting to alter its trigger, mechanical safety or other mechanisms. So never alter or modify your firearm in any way.

*Like any mechanical device, a firearm is subject to wear. It must be maintained and periodically serviced to assure optimum safety and performance. Only a qualified service facility should service, repair or modify your Remington® firearm. Consult your instruction book for instructions on how to send your firearm to the factory or for the location of the nearest Remington Authorized Service Center. Remington recommends that you have your firearm professionally serviced annually. You should also have your firearm professionally serviced after prolonged storage, or if there is ever any question pertaining to the proper functioning characteristics of your firearm. *Proper cleaning and lubrication* are also important to firearm maintenance and are necessary to assure accuracy, safety and reliability. Before cleaning, always make sure that your gun is completely unloaded. And always clean the barrel from the chamber end to the muzzle when possible.*

Remington®

REMINGTON IS A TRADEMARK REGISTERED IN THE UNITED STATES PATENT
AND TRADEMARK OFFICE BY REMINGTON ARMS COMPANY, INC.

PRINTED IN U.S.A.

PART NO. 3509
RD FORM RD 7055 REV. 5/10