

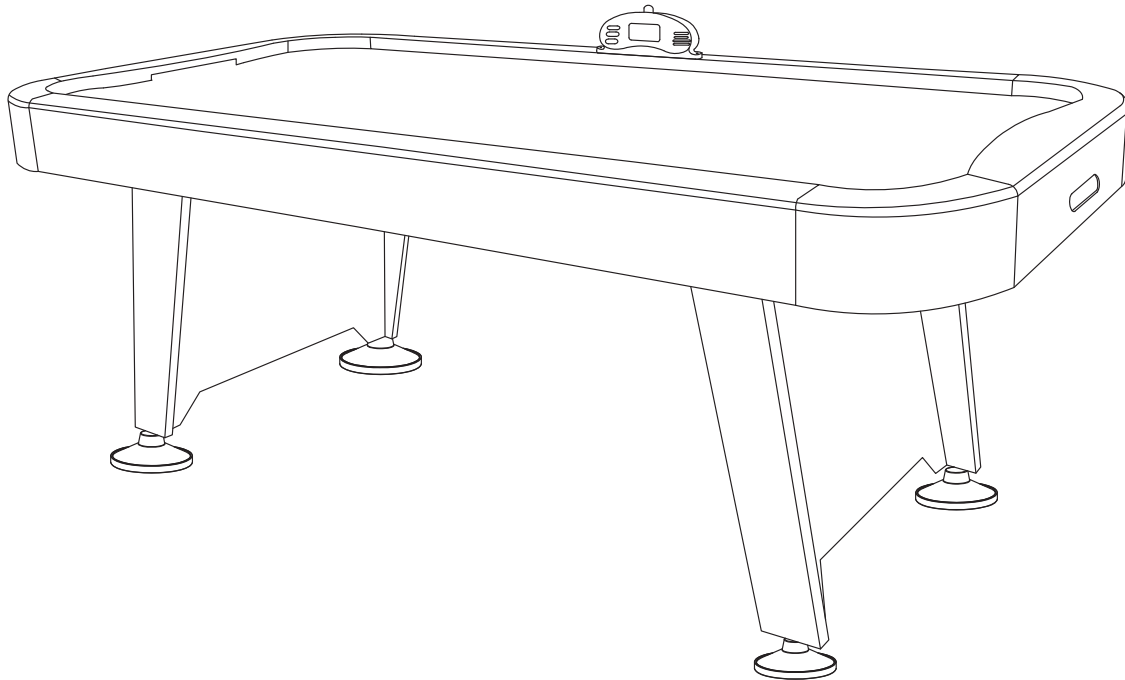

**Storm MMXI Air Powered  
Hockey Table**

Item 64-3011

**STORM MMXI AIR POWERED  
HOCKEY TABLE**



**Replacement Parts**

Order direct at [www.gldproducts.com](http://www.gldproducts.com)  
or call our Customer Service department at  
**(800) 225-7593**  
8 am to 4:30 pm Central Standard Time

**GLD Products**

**Storm MMXI Air Powered  
Hockey Table**

Item 64-3011

**Staple your receipt here.**

**Important:** A copy of your receipt will be needed to activate your warranty (see page 14).

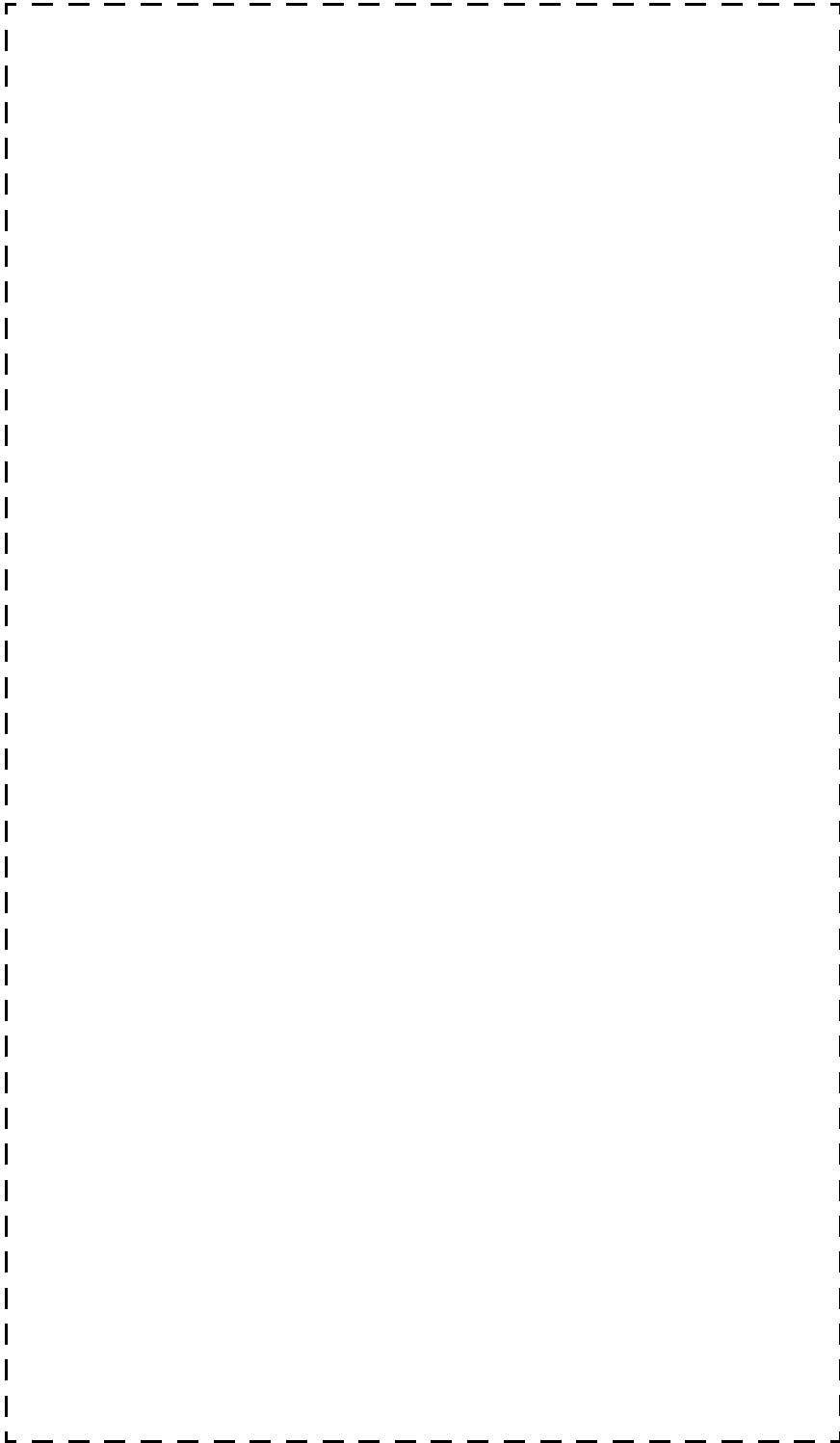

# GLD Products      **Storm MMXI Air Powered Hockey Table**

Item 64-3011

***Congratulations and THANK YOU for purchasing the Storm MMXI Air Powered Hockey Table. You have chosen a product that should provide years of entertainment. To assist you with customer service and warranty claims, staple your receipt to the inside cover, then keep this manual in a safe place for future reference.***

## **GLD Products**











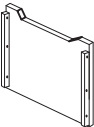

S84 W19093 Enterprise Drive  
Muskego, WI 53150 USA  
1-800-225-7593  
Fax: 1-800-841-6944  
Email: [gld@gldmfg.com](mailto:gld@gldmfg.com)  
Web: [www.gldproducts.com](http://www.gldproducts.com)

This manual may have been updated. For the latest manual visit the GLD Products website.

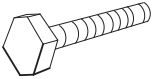
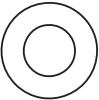
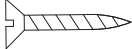
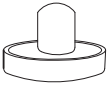
	<p>Place your package near the location where it will be used. Carefully unpack all components and verify you have all the correct pieces.</p> <p>If you notice missing or defective parts, please call us at: <b>1-800-225-7593.</b></p>
---	---

	<p>Please read and understand all instructions before beginning assembly.</p> <p><b>This assembly will require 2 adults.</b></p> <p>This product is not for use by children without adult supervision.</p>
---	--



Part No./ Qty	Illustration/ Order Number	Part No./ Qty	Illustration/ Order Number	Part No./ Qty	Illustration/ Order Number
1 Qty. 2	 Left Leg Order No. 4-109	2 Qty. 2	 Right Leg Order No. 4-110	3 Qty. 2	 Leg End Panel Order No. 4-111
4 Qty. 1	 Scoreboard Order No. 4-112	5 Qty. 4	 Leg Leveler Order No. 4-113	6 Qty. 12	 1/4" x 1-1/4" Bolt Order No. 4-114
7 Qty. 8	 5/16" x 1-1/2" Bolt Order No. 4-115	8 Qty. 16	 1/4" Washer 19 mm Order No. 1-220	9 Qty. 2	 F4 x 3/4" Screw Order No. 4-116
10 Qty. 2	 Goalie Order No. 2-18	11 Qty. 2	 Hockey Felt Order No. 2-19	12 Qty. 2	 Hockey Puck Order No. 4-117
13 Qty. 1	 Wrench Order No. 1-17	14 Qty. 1	 Allen Wrench Order No. 2-116	15 Qty. 1	 Table Top Assembly Order No. 4-118
16 Qty. 8	 5/16" Nut Order No. 2-139				

## **IF YOU HAVE A WARRANTY CLAIM, CALL US FIRST**

Please see page 14.

### **GLD Products**

Available 8 am to 4:30 pm Central Standard Time

S84 W19093 Enterprise Drive  
Muskego, WI 53150 USA  
1-800-225-7593  
Fax: 1-800-841-6944  
Email: [gld@gldmfg.com](mailto:gld@gldmfg.com)  
Web: [www.gldproducts.com](http://www.gldproducts.com)

For all claims, please have your receipt and item number when you call. The product item number can be found on the front cover.

**If you are instructed to return the product for service, you are responsible for shipping the unit at your expense.**

## **PRODUCT REGISTRATION**

**Important: The product registration form on page 15 and a copy of your receipt must be completed and returned within 10 days of purchase to validate your warranty.**

## **Preparing for Assembly**

- Be sure to unpack all of the parts included in this package. Check inside any tubes or sleeves. Save all packing material until the product is fully assembled and functional.
- Compare the parts in your package with the Parts Identifier description on page 5.
- After unpacking large products, some disassembly may be required prior to beginning the assembly.

## **Tools Required**

- Wrench (#13)
- Phillips screwdriver (not included)
- Allen Wrench (#14)
- Level (not included)
- Electric screwdriver may be helpful. **CAUTION:** You must set at LOW TORQUE and use extreme caution because you could overtighten the hardware, strip the screws, or damage the table.

## **Assembly Tips**

Make sure you understand the following before you begin to assemble your game table.

1. READ THIS MANUAL all the way through before beginning assembly.
2. When installing parts that have more than one bolt, start ALL bolts in that part by hand before tightening anything.
3. Some drawings or images in this manual may not look exactly like your product.
4. You may need a second adult to assist with this assembly.

**Note:** Save all packing materials until the parts have been inspected and the table is assembled.

## **Unpack the Pieces**

- Lay the box on a flat surface (floor). You may want this near your area of assembly.
- Unpack the boxes and part bags. Inspect and count the parts. The Parts Identifier page can be used to record your results.
- If any parts are damaged or missing, contact GLD Customer Service.
- Missing fasteners may be purchased at a hardware store using the descriptions on the Parts Identifier page.

## **Games**

This game table includes the equipment and game pieces for Air Powered Hockey. The rules for this game are not discussed in this manual.

**STEP 1 - ASSEMBLE THE LEGS**

Each leg has three main pieces. The two legs (#1 & #2) are not the same.

1. Position leg (#1) to fit against the leg end panel (#3). Use three bolts (#6) to hold the two pieces together.
2. Attach the other leg in the same manner.
3. Repeat the second leg assembly.
4. Screw a leg leveler (#5) into the holes on the bottom of each leg. The levelers should be screwed in half way.

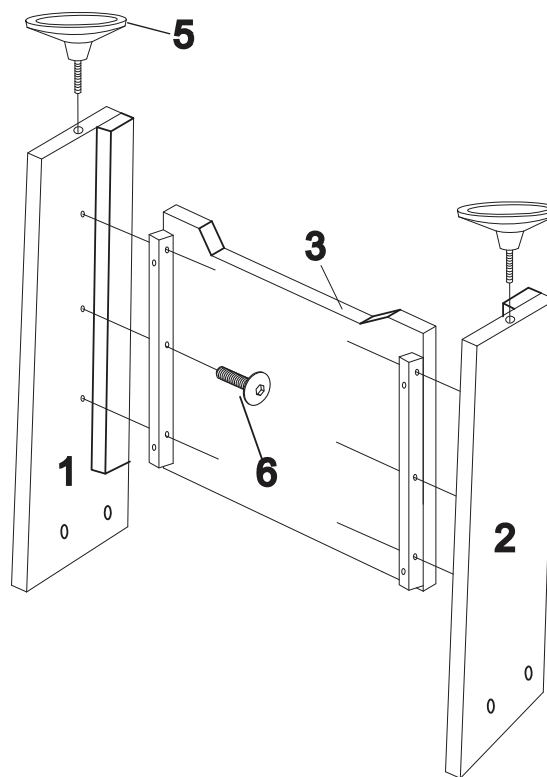



**STEP 2 - ATTACH THE LEGS**

Both of the leg assemblies are the same.

1. Position a leg assembly so the top ends are inside the table top and the bolt holes are lined up.
2. Insert a bolt (#7) and washer (#8) into both holes on each leg. Place a washer (#8) and a nut (#16) on each bolt. Tighten the bolts (#7).
3. Repeat for the remaining legs.

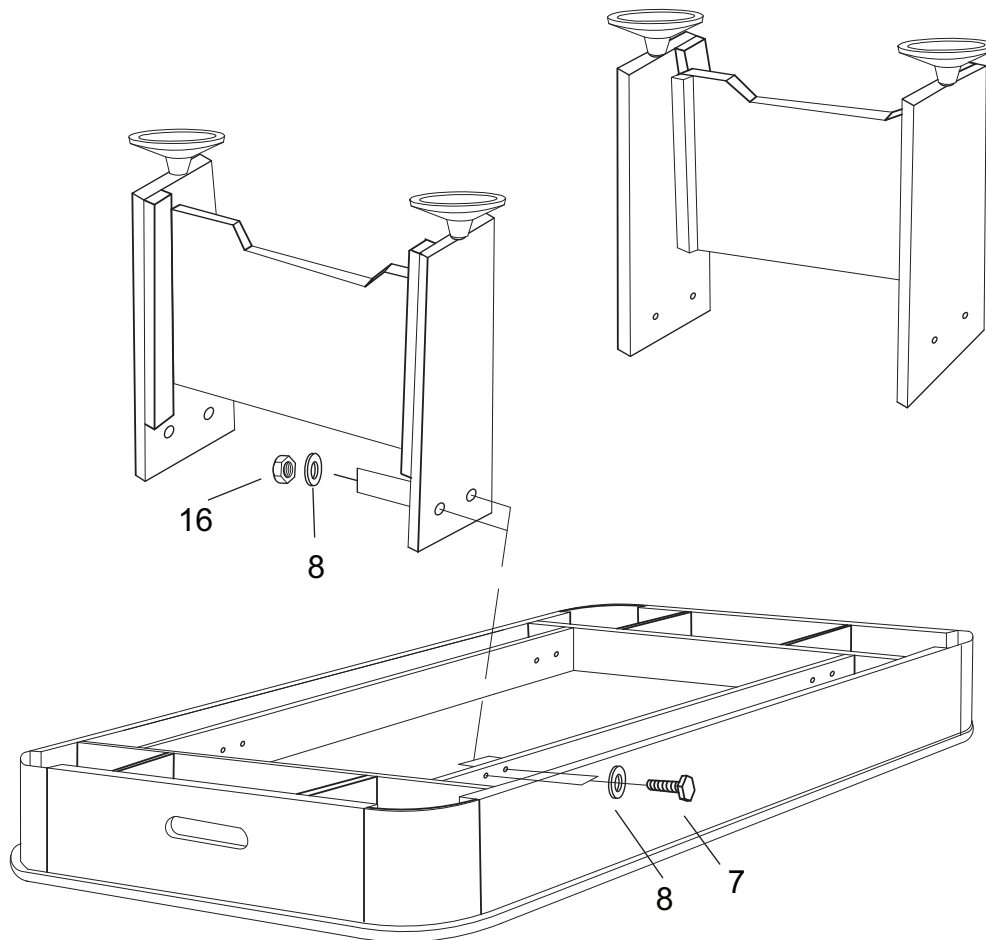

# GLD Products      *Storm MMXI Air Powered Hockey Table*

Item 64-3011

## STEP 3 - TURN THE TABLE OVER

The table is ready to be turned over.

USE AT LEAST TWO PEOPLE TO LIFT THE TABLE ASSEMBLY AND TURN IT OVER TO REST ON THE LEGS.

**DO NOT ROLL THE TABLE OVER.** This will place a sideways force on the legs. The legs should be off the floor until the table assembly is rotated completely. Set the table down.

**DO THIS**

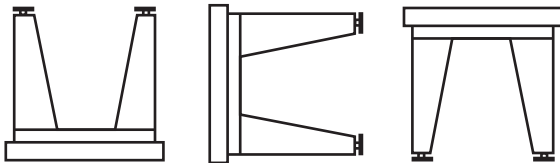

**NOT THIS**

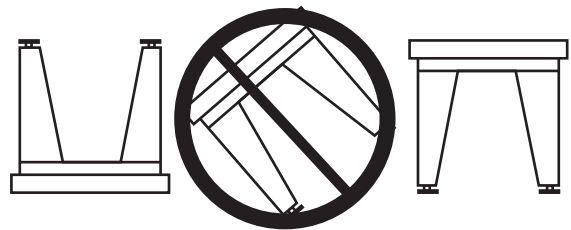

**STEP 4 - MOUNT THE SCOREBOARD**

1. Position the scoreboard (#4) over the hole in the table side rail.
2. Insert the wire from the scoreboard into the hole. Set the scoreboard down on the table side rail.
3. Hold the scoreboard (#4) in position and insert two screws (#9) into the table to hold the scoreboard. Tighten the screws.
4. Under the table top, plug the scoreboard into the connection box.

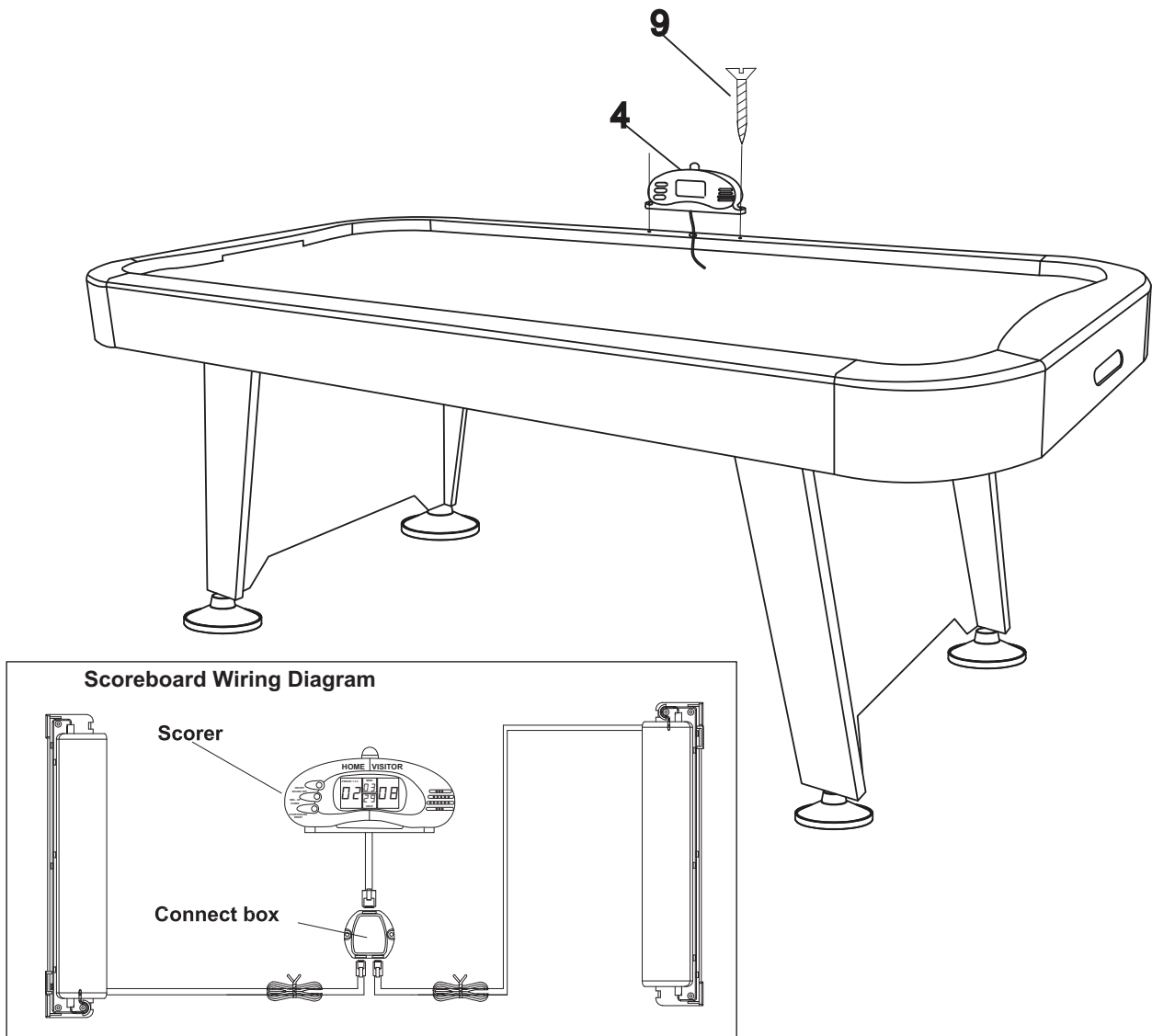

**STEP 5 - OPERATION**

1. Plug the fan electrical cord into a standard wall plug.
2. On the scoreboard, remove the battery cover. Insert three AAA batteries (not included). Follow the polarity shown on the inside cover. To turn the scoreboard on, press the On/Off button once. To turn the scoreboard off, press and hold the On/Off Button for three seconds.
3. The clock will display a game time of 10 minutes. Press the Up/Down button to change the length of the game.
4. Press the start button to begin a game. Scoring is registered automatically. To start a new game, press and hold the start button for three seconds.
5. To turn the sound off, press the On/Off button once. Press again to turn the sound back on.
6. To pause the game, press the pause button once. To continue, press the pause button again.
7. The scoreboard has two periods of play. When a period is over there will be an audible beep.

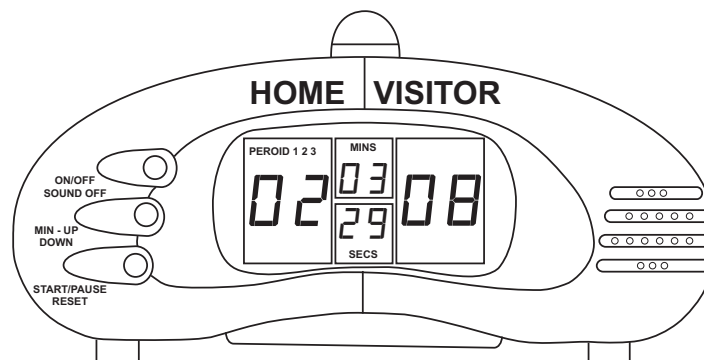
**STEP 6 - LEVEL THE TABLE**

1. Place the table in position.
2. Use a carpenter's level to find the low side of the table.
3. Raise or lower the leg levelers as needed to level the table.
4. Level the table side-to-side and end-to-end. When the game is turned on, the puck will float to a low side. Final leveling can be performed if needed.

## **STEP 7 - ASSEMBLE GOALIE**

1. Peel paper from one of the hockey felt pieces (#11).
2. Attach the felt to the bottom of the goalie (#10).

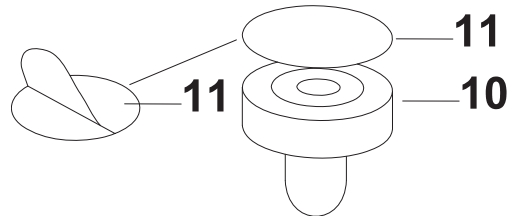

## **Care and Use of your Table**

- This product is intended for INDOOR use only.
- DO NOT sit, climb, or lean on the table.
- DO NOT drag the table when moving it. This will damage the legs.
- Keep your table covered.
- To clean the hard surfaces spray a cloth with a mild cleaner and wipe.
- Pucks that fly off the table may have chipped edges. Inspect the puck and replace if needed.
- The air holes may become plugged, causing the puck to drag. A small drill bit can be used to re-open the holes. DO NOT use a power drill. Instead, hold the drill bit in your fingers and clear the holes.

## **90-DAY LIMITED WARRANTY**

The Manufacturer warrants to the original retail purchaser that this product is free from defects in material and workmanship under normal use and conditions for a period of ninety (90) days from the date of original purchase. The Manufacturer's liability is limited to the repair or replacement, at its option, of any defective product and shall not include any liability for indirect, incidental or consequential damages of any kind. Should this product become defective due to material or workmanship within the warranty period, contact our Customer Service Department. This warranty is not transferable and does not cover normal wear and tear or damage caused by improper usage, negligence, misuse, abuse, transportation damage, acts of nature, or accident (including failure to follow the instructions in this manual). It does not cover expendable items such as batteries, light bulbs, fuses, accessories, cosmetic parts and other items that wear out due to normal usage, including felt covered areas of the playing surface. This warranty is also void if the product is disassembled and reassembled, damaged, modified from its original state, or used for other than indoor personal residential use (no commercial or rental applications).

This warranty gives you specific legal rights, and you may have other rights which vary from state to state.

### **IF YOU HAVE A WARRANTY CLAIM, CALL US FIRST (8 - 4:30 CST)**

**Please have your receipt and item number (found on the front cover) when you call.**

#### ***GLD Products***

S84 W19093 Enterprise Drive

Muskego, WI 53150 USA

1-800-225-7593

Fax: 1-800-841-6944

Email: [gld@gldmfg.com](mailto:gld@gldmfg.com)

Web: [www.gldproducts.com](http://www.gldproducts.com)

**If you are instructed to return the product for service, you are responsible for shipping the unit at your expense to the above address in packaging that will protect against further damage. All warranty or repair requests require a Return Authorization Number prior to returning the item.**

### **PRODUCT REGISTRATION**

**Important:** The product registration form on page 15 must be completed and returned along with a copy of your receipt within 10 days of purchase to validate your warranty.

# REGISTER YOUR PRODUCT

Place postage here

Complete this form, include a copy of your receipt, fold, tape (do not staple) and return within 10 days of purchase. This protects your warranty and will help us develop new products!

Cut here.

**GLD Products**  
Warranty Department  
S84 W19093 Enterprise Drive  
Muskego, WI 53150 USA

Fold here second.



*P R O D U C T S*

[www.gldproducts.com](http://www.gldproducts.com)

GAME TABLES	HOME CASINO
GAMES AND ACCESSORIES	BILLIARD CUES
BILLIARD ACCESSORIES	DARTBOARDS
SOFT-TIP DARTS	STEEL-TIP DARTS
FLIGHTS AND SHAFTS	DART CASES AND ACCESSORIES

Fold here first.

Name	Date of Purchase
Address	Phone-Day
City	Phone-Evening
State                      Zip	Email
Purchase Price:	Item: <b>64-3011 Storm MMXI Air Powered Hockey Table</b>
Store Name:	

1. What are the top two reasons that influenced the purchase of this product? Select two.

<input type="checkbox"/>	Brand reputation	<input type="checkbox"/>	Prior experience with another GLD product
<input type="checkbox"/>	Saw in an advertisement	<input type="checkbox"/>	Color/appearance
<input type="checkbox"/>	Quality/durability	<input type="checkbox"/>	Other
<input type="checkbox"/>	Value for price		

2. How did you become aware of this product? Select two.

Saw in an advertisement  
Saw or used a friend's or relative's  
Received as a gift

Saw it in the store  
Recommended by another person  
Other

3. Rate your satisfaction with each of the following?

Assembly instructions  
Ease of assembly  
Packaging  
Overall product satisfaction

Excellent	Good	Fair	Poor

4. Were there any parts missing?

Yes

No

If so, which ones?

Order No. \_\_\_\_\_

5. Based on your experience, would you buy another GLD product?

Yes

No

6. Is this the first GLD product that you've owned? If No, what other product have you owned?:

Yes

No

\_\_\_\_\_

7. Have you owned products from:

Sportcraft

Harvard

Classic Sport

Other

8. When did you decide to purchase this product?

Before entering the store.

While in the store/impulse purchase

9. How many times per month will you use it?

1 to 3

4 to 8

9 to 15

16 +

10. Are you the intended user of this product?

Yes

No, indicate who: \_\_\_\_\_

11. Where will you use this product?

Home

Other: \_\_\_\_\_

12. Please tell us your gender?

Male

Female

13. And your marital status?

Married

Single

14. Age?

Under 25

25 - 40

40 - 60

Over 60

15. Which best describes your family income?

Under \$25,000

\$25,000 - \$49,999

\$50,000 - \$99,999

\$100,000 - 149,999

\$150,000 - \$199,999

Over \$200,000

16. Education:

Some high school

College degree

Completed high school

Graduate degree

**Remember to attach a copy of your receipt.**



**Mail To: GLD Products**  
 S84 W19093 Enterprise Drive  
 Muskego, WI 53150 USA  
 1-800-225-7593 • FAX 800-841-6944  
 Email: gld@gldmfg.com  
 Web Site: www.gldproducts.com

**Storm MMXI Air Powered  
 Hockey Table**  
 Item 64-3011  
**Parts Re-Order Form**

Name		Date
Address		Phone-Day
City		Phone-Evening
State	Zip	Email

Order No.	Description	Unit Price (each)	Qty.	Total Amount
4-109	Left Leg	30.00		
4-110	Right Leg	30.00		
4-111	Leg End Panel	35.00		
4-112	Scoreboard	25.00		
4-113	Leg Leveler	12.00		
4-114	1/4" x 1-1/4" Bolt	2.00		
4-115	5/16" x 1-1/4" Bolt	2.00		
1-220	1/4" Washer 19 mm	0.20		
4-116	F4 x 3/4" Screw	0.20		
2-18	Goalie	6.00		
2-19	Hockey Felt	1.00		
4-117	Hockey Puck	1.50		
1-17	Wrench	1.00		
2-116	Allen Wrench	1.00		
4-118	Table Top Assembly	150.00		
4-119	Fan - preassembled	25.00		
		Subtotal		
Shipping will be added. If paid by Check or Money Order, call for quote.		S/H		
5.1% Waukesha Wisconsin tax will apply (subject to change).		Tax		
		Total		

**Method of Payment**

\_\_\_\_\_ Check or Money Order  
\_\_\_\_\_ Credit Card

\_\_\_\_\_ Visa \_\_\_\_\_ MasterCard \_\_\_\_\_ Discover \_\_\_\_\_ American Express

Card # \_\_\_\_\_

Security Code # \_\_\_\_\_ Billing Address Zip code \_\_\_\_\_

Signature \_\_\_\_\_ Exp. Date \_\_\_\_\_

**Shipping Address**

Name \_\_\_\_\_

Address \_\_\_\_\_ Phone \_\_\_\_\_

City \_\_\_\_\_ State \_\_\_\_\_ Zip \_\_\_\_\_

**GLD**<sup>®</sup>

*P R O D U C T S*

[www.gldproducts.com](http://www.gldproducts.com)

**GAME TABLES**

**HOME CASINO**

**GAMES AND ACCESSORIES**

**BILLIARD CUES**

**BILLIARD ACCESSORIES**

**DARTBOARDS**

**SOFT-TIP DARTS**

**STEEL-TIP DARTS**

**FLIGHTS AND SHAFTS**

**DART CASES AND ACCESSORIES**



**PROUD MANUFACTURER OF**



S84 W19093 Enterprise Drive • Muskego, WI 53150 USA  
262.679.8730 or 1.800.225.7593 tele  
262.679.8738 or 1.800.841.6944 fax  
262.679.8739 international fax  
Email: [gld@gldmfg.com](mailto:gld@gldmfg.com)  
[www.gldproducts.com](http://www.gldproducts.com)