

**SAMSUNG**

# USER MANUAL

**QLED TV**

QN49Q6FNAF QN55Q6FNAF QN65Q6FNAF  
QN75Q6FNAF QN82Q6FNAF



Thank you for purchasing this Samsung product.

To receive more complete service, please register your product at [www.samsung.com](http://www.samsung.com)



Model \_\_\_\_\_ Serial No. \_\_\_\_\_

If you have any questions, please call us at 1-800-SAMSUNG (1-800-726-7864) for assistance.

# Before Reading This User Manual

This TV comes with this user manual and an embedded e-Manual.

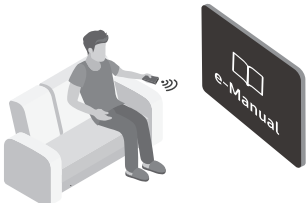

Before reading this user manual, review the following:

	<p><b>User Manual</b></p>	<p>Read this provided user manual to see information about product safety, installation, accessories, initial configuration, and product specifications.</p>
	<p><b>e-Manual</b></p>	<p>For more information about this TV, read the e-Manual embedded in the product.</p> <ul style="list-style-type: none"> <li>To open the e-Manual,           <ul style="list-style-type: none"> <li> &gt;  Settings &gt; Support &gt; Open e-Manual</li> </ul> </li> </ul>





Scan this QR code with your smart device to visit Samsung's online Customer Service Center. You can also visit the site - <http://www.samsung.com/us/support> - on your PC. On the website, you can download the user manual and see its contents on your PC or mobile device.

## Learning the e-Manual's assistance functions

	<p><b>Search</b></p>	<p>Select an item from the search results to load the corresponding page.</p>
	<p><b>Index</b></p>	<p>Select a keyword to navigate to the relevant page.</p>
	<p><b>Recently Viewed Topics</b></p>	<p>Select a topic from the list of recently viewed topics.</p>







- Some menu screens cannot be accessed from the e-Manual.

## Learning the functions of the buttons that appear on e-Manual topic pages

	<p><b>Try Now</b></p>	<p>Access the associated menu item and try out the feature directly.</p>
	<p><b>Link</b></p>	<p>Access an underlined topic referred to on an e-Manual page immediately.</p>

# Warning! Important Safety Instructions

Please read the Safety Instructions before using your TV.

<b>CAUTION</b>			Class II product: This symbol indicates that a safety connection to electrical earth (ground) is not required.
<b>RISK OF ELECTRIC SHOCK. DO NOT OPEN.</b>			
CAUTION: TO REDUCE THE RISK OF ELECTRIC SHOCK, DO NOT REMOVE COVER (OR BACK). THERE ARE NO USER SERVICEABLE PARTS INSIDE. REFER ALL SERVICING TO QUALIFIED PERSONNEL.			AC voltage: Rated voltage marked with this symbol is AC voltage.
	This symbol indicates that high voltage is present inside. It is dangerous to make any kind of contact with any internal part of this product.		DC voltage: Rated voltage marked with this symbol is DC voltage.
	This symbol indicates that this product has included important literature concerning operation and maintenance.		Caution. Consult instructions for use: This symbol instructs the user to consult the user manual for further safety related information.

- The slots and openings in the cabinet and in the back or bottom are provided for necessary ventilation. To ensure reliable operation of this apparatus and to protect it from overheating, these slots and openings must never be blocked or covered.
  - Do not place this apparatus in a confined space, such as a bookcase or built-in cabinet, unless proper ventilation is provided.
  - Do not place this apparatus near or over a radiator or heat register, or where it is exposed to direct sunlight.
  - Do not place vessels (vases etc.) containing water on this apparatus, as this can result in a fire or electric shock.
- Do not expose this apparatus to rain or place it near water (near a bathtub, washbowl, kitchen sink, or laundry tub, in a wet basement, or near a swimming pool, etc.). If this apparatus accidentally gets wet, unplug it and contact an authorized dealer immediately.
- This apparatus uses batteries. In your community, there might be environmental regulations that require you to dispose of these batteries properly. Please contact your local authorities for disposal or recycling information.
- Do not overload wall outlets, extension cords, or adaptors beyond their capacity, since this can result in fire or electric shock.
- Power-supply cords should be placed so that they are not likely to be walked on or pinched by items placed upon or against them. Pay particular attention to cords at the plug end, at wall outlets, and at the point where they exit from the appliance.
- To protect this apparatus from a lightning storm, or when left unattended and unused for long periods of time, unplug it from the wall outlet and disconnect the antenna or cable system. This will prevent damage to the set due to lightning and power line surges.

- Before connecting the AC power cord to the DC adaptor outlet, make sure that the voltage designation of the DC adaptor corresponds to the local electrical supply.
- Never insert anything metallic into the open parts of this apparatus. This may cause a danger of electric shock.
- To avoid electric shock, never touch the inside of this apparatus. Only a qualified technician should open this apparatus.
- Be sure to plug in the power cord until it is firmly seated. When unplugging the power cord from a wall outlet, always pull on the power cord's plug. Never unplug it by pulling on the power cord. Do not touch the power cord with wet hands.
- If this apparatus does not operate normally - in particular, if there are any unusual sounds or smells coming from it - unplug it immediately and contact an authorized dealer or service center.
- Be sure to pull the power plug out of the outlet if the TV is to remain unused or if you are to leave the house for an extended period of time (especially when children, elderly, or disabled people will be left alone in the house).
  - Accumulated dust can cause an electric shock, an electric leakage, or a fire by causing the power cord to generate sparks and heat or by causing the insulation to deteriorate.
- Be sure to contact an authorized Samsung service center for information if you intend to install your TV in a location with heavy dust, high or low temperatures, high humidity, chemical substances, or where it will operate 24 hours a day such as in an airport, a train station, etc. Failure to do so may lead to serious damage to your TV.
- Use only a properly grounded plug and wall outlet.
  - An improper ground may cause electric shock or equipment damage. (Class I Equipment only.)
- To turn off this apparatus completely, disconnect it from the wall outlet. To ensure you can unplug this apparatus quickly if necessary, make sure that the wall outlet and power plug are readily accessible.
- Store the accessories (batteries, etc.) in a location safely out of the reach of children.
- Do not drop or strike the product. If the product is damaged, disconnect the power cord and contact a Samsung service center.
- To clean this apparatus, unplug the power cord from the wall outlet and wipe the product with a soft, dry cloth. Do not use any chemicals such as wax, benzene, alcohol, thinners, insecticide, air fresheners, lubricants, or detergents. These chemicals can damage the appearance of the TV or erase the printing on the product.
- Do not expose this apparatus to dripping or splashing.
- Do not dispose of batteries in a fire.
- Do not short-circuit, disassemble, or overheat the batteries.
- There is danger of an explosion if you replace the batteries used in the remote with the wrong type of battery. Replace only with the same or equivalent type.
- **WARNING - TO PREVENT THE SPREAD OF FIRE, KEEP CANDLES AND OTHER ITEMS WITH OPEN FLAMES AWAY FROM THIS PRODUCT AT ALL TIMES.**
- Use care when touching the TV after it has been on for some time. Some parts can be warm to the touch.
- **State of California Proposition 65 Warning**
  - **WARNING - This product contains chemicals known to the State of California to cause cancer and birth defects or other reproductive harm.**



## Internet security

Samsung takes a number of steps to protect its Internet-compatible Smart TVs against unauthorized incursions and hacking. For example, certain sensitive communications between the TV and the Internet servers are encrypted. In addition, the TV's operating system has adopted controls to prevent the installation of unauthorized applications. Although we take steps to protect your Smart TV and personal information, no Internet-connected device or transmission is completely secure. We therefore encourage you to take additional steps to safeguard your TV, secure your Internet connection, and minimize the risk of unauthorized access. These steps are listed below:

- When Samsung releases software updates to improve the security of your TV, you should promptly install these updates. To automatically receive these updates, turn on **Auto Update** in the TV's menu (Home > Settings > Support > Software Update > Auto Update). When an update is available, a popup message appears on the TV screen. Accept the software download and update by selecting YES when prompted. Take steps to secure your wireless router and network. Your router's manual should provide additional details about how to implement the following measures:
  - Secure your wireless router's management settings with a unique password to prevent unauthorized changes to security related settings.
  - Implement standard encryption (e.g., WPA2 encryption) on your wireless router to secure your wireless network signal.
  - Secure access to your wireless network with a hard-to-guess password.
  - Confirm your router's firewall setting is enabled (if so equipped).
  - Make sure that all your Internet-connected devices are behind your network's firewall.
  - If your router or modem has a standby mode button, use it to disconnect your home network from the Internet when it is not in use.
- Use strong passwords for all your Internet accounts (Netflix, Facebook, etc.). If your TV has a camera, recess the camera into the TV's bezel when it is not in use. Recessing the camera makes it inoperative.
- If any unexpected messages appear on your TV screen requesting permission to link a device or enable a remote session, do NOT accept.
- Do not visit suspicious web sites and do not install any suspicious programs. We recommend that users install only those authorized apps provided by Samsung through Samsung Smart Hub.

Figures and illustrations in this User Manual are provided for reference only and may differ from the actual product appearance. Product design and specifications may change without notice.

# Contents

Before Reading This User Manual	2
Warning! Important Safety Instructions	3
<b>01 TV Installation</b>	
Mounting the TV on a wall	7
Providing proper ventilation for your TV	8
Safety Precaution: Securing the TV to the wall to prevent falling	9
<b>02 The Samsung Smart Remote</b>	
About the Buttons on the Samsung Smart Remote	10
Pairing the TV to the Samsung Smart Remote	11
Installing batteries into the Samsung Smart Remote	11
<b>03 Initial Setup</b>	
Using the TV Controller	12
<b>04 Troubleshooting and Maintenance</b>	
Troubleshooting	13
What is Remote Support?	14
Eco Sensor and screen brightness	15
Caring for the TV	15
<b>05 Specifications and Other Information</b>	
Specifications	16
Environmental Considerations	17
Decreasing power consumption	17
Dimensions	18
Licenses	18
<b>FCC and Warranty Information</b>	
Federal Communication Commission Interference Statement	19
LIMITED WARRANTY TO ORIGINAL PURCHASER	20

# 01 TV Installation

## Mounting the TV on a wall



If you mount this TV on a wall, follow the instructions exactly as set out by the manufacturer. Unless it is correctly mounted, the TV may slide or fall and cause serious injury to a child or adult and serious damage to the TV.

For models providing wall mount adapters, install them as shown in the figure below before installing the wall mount kit.

- Refer to the installation manual included with the Samsung wall mount kit.

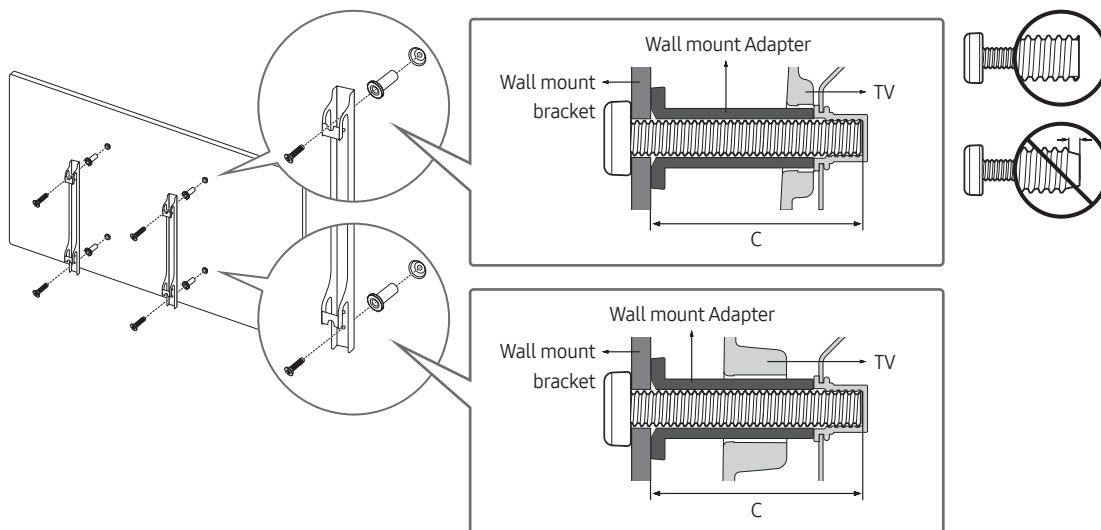

- Samsung Electronics is not responsible for any damage to the product or injury to yourself or others if you choose to install the wall mount on your own.
- To order the wall mount kit, contact Samsung Customer Care at 1-800-SAMSUNG (1-800-726-7864).
- You can install your wall mount on a solid wall perpendicular to the floor. Before attaching the wall mount to surfaces other than plaster board, contact your nearest dealer for additional information. If you install the TV on a ceiling or slanted wall, it may fall and result in severe personal injury.
- When installing a wall mount kit, we recommend you fasten all four VESA screws.
- If you want to install a wall mount kit that attaches to the wall using two top screws only, be sure to use a Samsung wall mount kit that supports this type of installation. (You may not be able to purchase this type of wall mount kit, depending on the geographical region.)
- Standard dimensions for wall mount kits are shown in the table below.
- If you are installing a third-party wall mount, note that the length of the screws you can use to attach the TV to the wall mount is shown in column C in the table below.

TV size in inches	VESA screw hole specs (A * B) in millimeters	C (mm)	Standard Screw	Pitch (mm)	Quantity	
49-55	200 x 200	43-45	M8	1.25	4	
65-75	400 x 400					
82	600 x 400					



Do not install your wall mount kit while your TV is turned on. This may result in personal injury from electric shock.

- Do not use screws that are longer than the standard dimension or do not comply with the VESA standard screw specifications. Screws that are too long may cause damage to the inside of the TV set.
- For wall mounts that do not comply with the VESA standard screw specifications, the length of the screws may differ depending on the wall mount specifications.
- Do not fasten the screws too firmly. This may damage the product or cause the product to fall, leading to personal injury. Samsung is not liable for these kinds of accidents.
- Samsung is not liable for product damage or personal injury when a non-VESA or non-specified wall mount is used or when the consumer fails to follow the product installation instructions.
- Do not mount the TV at more than a 15 degree tilt.
- Always have two people mount the TV onto a wall.

## Providing proper ventilation for your TV

When you install your TV, maintain a distance of at least 4 inches between the TV and other objects (walls, cabinet sides, etc.) to ensure proper ventilation. Failing to maintain proper ventilation may result in a fire or a problem with the product caused by an increase in its internal temperature.

When you install your TV with a stand or a wall mount, we strongly recommend you use parts provided by Samsung Electronics only. Using parts provided by another manufacturer may cause difficulties with the product or result in injury caused by the product falling.



## Safety Precaution: Securing the TV to the wall to prevent falling



**Caution:** Pulling, pushing, or climbing on the TV may cause the TV to fall. In particular, ensure your children do not hang on or destabilize the TV. This action may cause the TV to tip over, causing serious injuries or death. Follow all safety precautions provided in the Safety Flyer included with your TV. For added stability and safety, you can purchase and install the anti-fall device as described below.



**WARNING:** Never place a television set in an unstable location. The television set may fall, causing serious personal injury or death. Many injuries, particularly to children, can be avoided by taking simple precautions such as

- Using cabinets or stands recommended by the manufacturer of the television set.
- Only using furniture that can safely support the television set.
- Ensuring the television set is not overhanging the edge of the supporting furniture.
- Not placing the television set on tall furniture (for example, cupboards or bookcases) without anchoring both the furniture and the television set to a suitable support.
- Not placing the television set on cloth or other materials that may be located between the television set and supporting furniture.
- Educating children about the dangers of climbing on furniture to reach the television set or its controls.

If you are retaining and relocating the television set that you are replacing with this new set, you should apply the same precautions to the old set.

- When you have to relocate or lift the TV for replacement or cleaning, be sure not to pull out the stand.

### Preventing the TV from falling

1. Using the appropriate screws, firmly fasten a set of brackets to the wall.  
Confirm that the screws are firmly attached to the wall.
  - You may need additional material such as wall anchors depending on the type of wall.
2. Using the appropriately sized screws, firmly fasten a set of brackets to the TV.
  - For the screw specifications, refer to "Standard Screw" in the table on page 7.
3. Connect the brackets fixed to the TV and the brackets fixed to the wall with a durable, heavy-duty string, and then tie the string tightly.
  - Install the TV near the wall so that it does not fall backwards.
  - Connect the string so that the brackets fixed to the wall are at the same height as or lower than the brackets fixed to the TV.

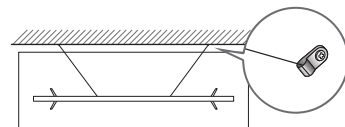
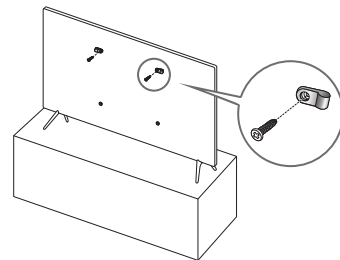

# 02 The Samsung Smart Remote

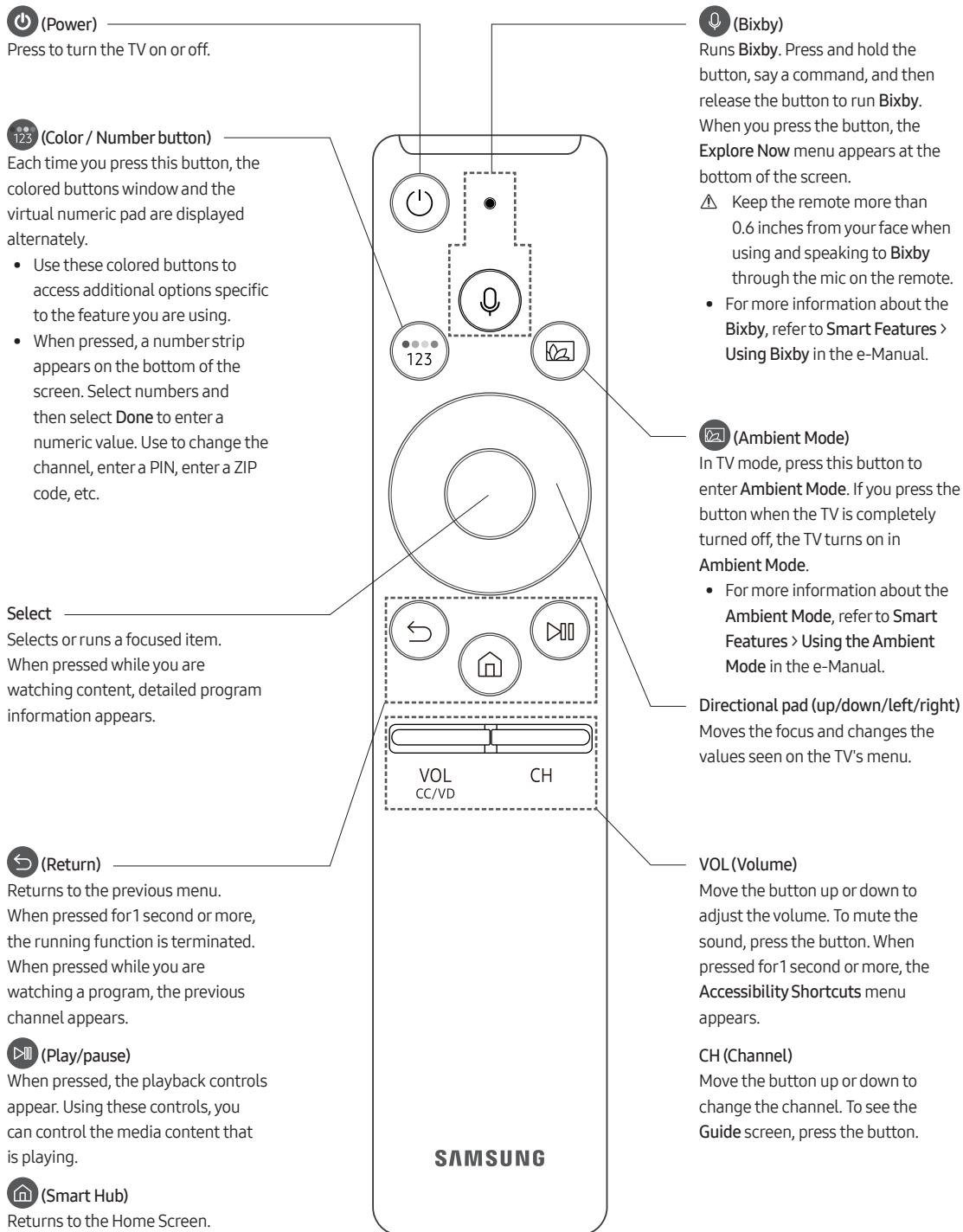

## About the Buttons on the Samsung Smart Remote

- The images, buttons, and functions of the Samsung Smart Remote may differ depending on the model.

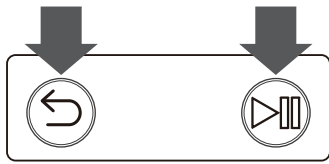

## Pairing the TV to the Samsung Smart Remote



When you turn on the TV for the first time, the Samsung Smart Remote pairs to the TV automatically. If the Samsung Smart Remote does not pair to the TV automatically, point it at the remote control sensor of the TV, and then press and hold the buttons labeled  and  as shown in the figure on the left simultaneously for 3 seconds or more.

## Installing batteries into the Samsung Smart Remote

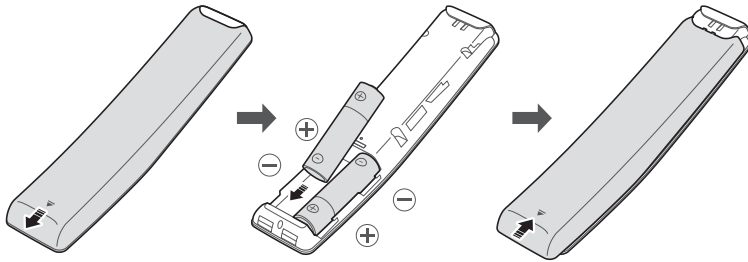

To install the batteries, push the rear cover open in the direction of the arrow in the illustration on the left, and then insert the batteries as shown in the figure. Make sure that the positive and negative ends are facing in the correct direction.

- Alkaline batteries are recommended for longer battery life.

## 03 Initial Setup

When you turn on your TV for the first time, it immediately starts the Initial Setup. Follow the instructions displayed on the screen and configure the TV's basic settings to suit your viewing environment.

- Noise may occur temporarily when the TV communicates with mobile devices.
- The SmartThings app is available on mobile devices for Android 6.0 or higher and iOS10 or higher.
- To perform initialization by using the SmartThings app, the mobile device must have been connected via Wi-Fi.
- When the pop-up for setup does not appear automatically on the SmartThings app of your mobile device, proceed with the process after manually adding the TV using **Add Device** on the dashboard of the SmartThings app.

### Using the TV Controller

You can turn on the TV with the **TV Controller** button at the bottom of the TV, and then use the **Control menu**. The **Control menu** appears when the **TV Controller** is pressed while the TV is On. For more information about its usage, refer to the figure below.

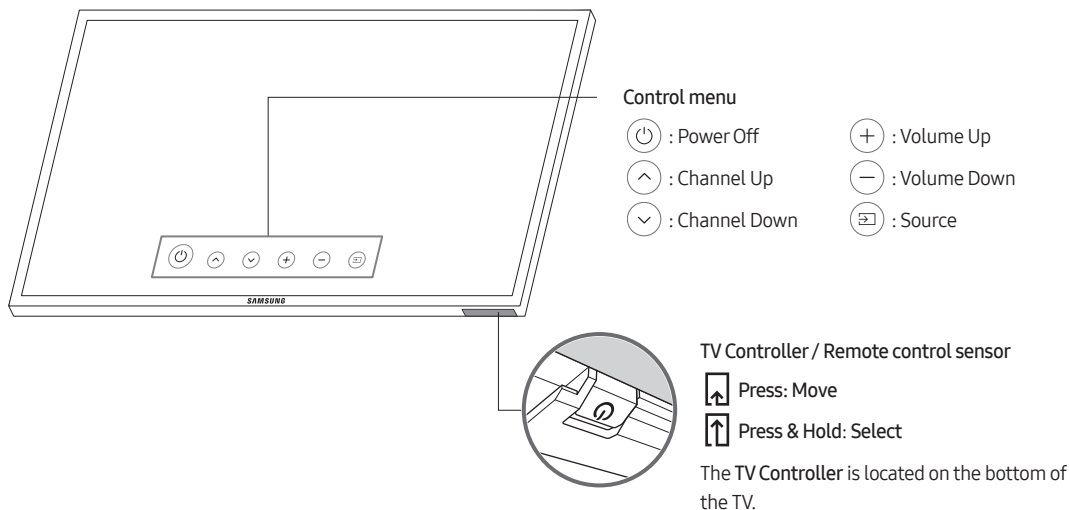

# 04 Troubleshooting and Maintenance

## Troubleshooting

If the TV seems to have a problem, first review this list of possible problems and solutions. Alternatively, review the Troubleshooting Section in the e-Manual. If none of the troubleshooting tips apply, visit [www.samsung.com/support](http://www.samsung.com/support) or call Samsung Customer Service at 1-800-SAMSUNG (1-800-726-7864).

- For detailed information on troubleshooting, watch the troubleshooting videos at [www.samsung.com/spsn](http://www.samsung.com/spsn).
- This TFT LED panel is made up of sub pixels which require sophisticated technology to produce. There may be, however, a few bright or dark pixels on the screen. These pixels will have no impact on the performance of the product.
- To keep your TV in optimum condition, upgrade to the latest software. Use the **Update Now** or **Auto Update** functions on the TV's menu (🏠 > ⚙️ Settings > Support > Software Update > Update Now or Auto Update).

### The TV won't turn on.

- Make sure that the AC power cord is securely plugged in to the TV and the wall outlet.
- Make sure that the wall outlet is working and the power indicator at the bottom of the TV is lit and glowing a solid red.
- Try pressing the Power (⏻) button at the bottom of the TV to make sure that the problem is not with the remote control. If the TV turns on, refer to "Remote control does not work" below.

### There is no picture/video/sound, or a distorted picture/video/sound from an external device, or "Weak or No Signal" is displayed on the TV, or you cannot find a channel.

- Make sure the connection to the device is correct and that all cables are fully inserted.
- Remove and reconnect all cables connected to the TV and the external devices. Try new cables if possible.
- Confirm that the correct input source has been selected (🏠 > Source).
- Perform a TV self diagnosis to determine if the problem is caused by the TV or the device (🏠 > ⚙️ Settings > Support > Self Diagnosis > Start Picture Test or Start Sound Test).
- If the test results are normal, reboot the connected devices by unplugging each device's power cord and then plugging it in again. If the issue persists, refer to the connection guide in the user manual of the connected device.
- If you are not using a cable box or satellite box, and your TV is receiving TV signals from an antenna or a cable wall connector, run **Auto Program** to search for channels (🏠 > ⚙️ Settings > Broadcasting > Auto Program).

### The remote control does not work.

- Check if the power indicator at the bottom of the TV blinks when you press the remote's Power button. If it does not, replace the remote control's batteries.
- Make sure that the batteries are installed with their poles (+/-) in the correct direction.
- Try pointing the remote directly at the TV from 5 ft. to 6 ft. (1.5~1.8 m) away.
- If your TV came with a Samsung Smart Remote (Bluetooth Remote), make sure to pair the remote to the TV.

### The cable box or satellite box remote control doesn't turn the TV on or off or adjust the volume.

- Program the cable box or satellite box remote control to operate the TV. Refer to the cable box or satellite box user manual for the SAMSUNG TV code.

## The TV settings are lost after 5 minutes.

- The TV is in the Retail Mode. Change the Usage Mode in the System Manager Menu to Home Mode (🏠 > ⚙️ Settings > General > System Manager > Usage Mode > Home Mode).

## Intermittent Wi-Fi

- Make sure the TV has a network connection (🏠 > ⚙️ Settings > General > Network > Network Status).
- Make sure the Wi-Fi password is entered correctly.
- Check the distance between the TV and the Modem/Router. The distance should not exceed 50 ft (15.2 m).
- Reduce interference by not using or turning off wireless devices. Also, verify that there are no obstacles between the TV and the Modem/Router. (The Wi-Fi strength can be decreased by appliances, cordless phones, stone walls/ fireplaces, etc.)

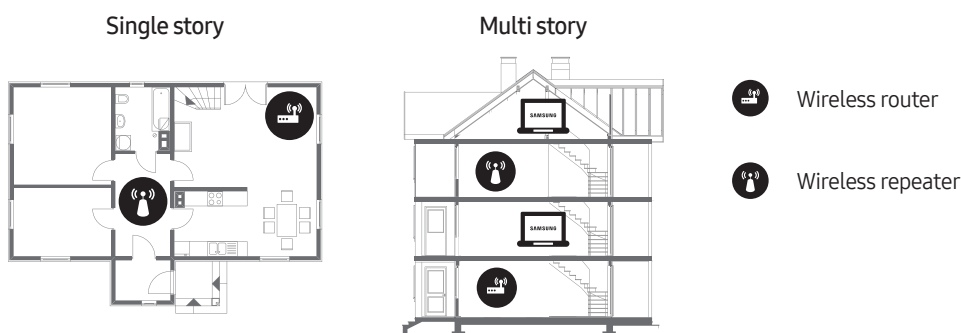

- Contact your Internet Service Provider (ISP) and ask them to reset your network circuit to re-register the Mac addresses of your new Modem/Router and the TV.

## Video App problems (Youtube etc)

- Change the DNS to 8.8.8.8. Select (🏠 > ⚙️ Settings > General > Network > Network Status > IP Settings > DNS Setting > Enter manually > DNS Server > enter 8.8.8.8 > OK).
- Reset by selecting (🏠 > ⚙️ Settings > Support > Self Diagnosis > Reset Smart Hub).

## What is Remote Support?

Samsung Remote Support service offers you one-on-one support with a Samsung Technician who can remotely:

- Diagnose your TV
- Adjust the TV settings for you
- Perform a factory reset on your TV
- Install recommended firmware updates



## How does Remote Support work?

You can easily get Samsung Remote Support service for your TV.

1. Call the Samsung Contact Center and ask for remote support.
2. Open the menu on your TV, and then go to the **Support** section. (🏠 > ⚙️ Settings > Support)
3. Select **Remote Management**, then read and agree to the service agreements. When the PIN screen appears, provide the PIN number to the technician.
4. The technician will then access your TV.

## Eco Sensor and screen brightness



Eco Sensor adjusts the brightness of the TV automatically. This feature measures the light in your room and optimizes the brightness of the TV automatically to reduce power consumption. If you want to turn this off, go to  >  **Settings** > **General** > **Eco Solution** > **Ambient Light Detection**.

- If the screen is too dark while you are watching TV in a dark environment, it may be due to the **Ambient Light Detection** function.
- The eco sensor is located at the bottom of the TV. Do not block the sensor with any object. This can decrease picture brightness.

## Caring for the TV

- If a sticker was attached to the TV screen, some debris can remain after you remove the sticker. Please clean the debris off before watching TV.
- The exterior and screen of the TV can get scratched during cleaning. Be sure to wipe the exterior and screen carefully using a soft cloth to prevent scratches.
- Do not spray water or any liquid directly onto the TV. Any liquid that goes into the product may cause a failure, fire, or electric shock.
- To clean the screen, turn off the TV, then gently wipe away smudges and fingerprints on the panel with a micro-fiber cloth. Clean the body or panel of the TV with a micro-fiber cloth dampened with a small amount of water. After that, remove the moisture with a dry cloth. While cleaning, do not apply strong force to the surface of the panel because it can damage the panel. Never use flammable liquids (benzene, thinner, etc.) or a cleaning agent. For stubborn smudges, spray a small amount of screen cleaner on a micro-fiber cloth, and then use the cloth to wipe away the smudges.

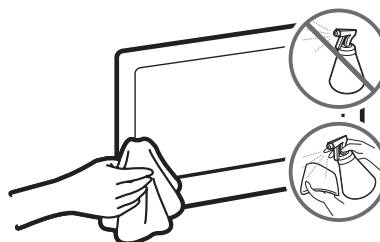

# 05 Specifications and Other Information

## Specifications

<b>Model Name</b>	QN49Q6FNAF	QN55Q6FNAF
<b>Display Resolution</b>	3840 x 2160	3840 x 2160
<b>Screen Size</b>		
<b>Diagonal</b>	49" Class	55" Class
<b>Measured Diagonally</b>	48.5 inches	54.6 inches
<b>Sound (Output)</b>	40 W	40 W
<b>Dimensions (W x H x D)</b>		
<b>Body</b>	43.0 x 25.0 x 2.2 inches (1091.6 x 634.6 x 54.9 mm)	48.3 x 28.0 x 2.2 inches (1227.1 x 710.7 x 54.9 mm)
<b>With stand</b>	43.0 x 27.7 x 9.8 inches (1091.6 x 703.3 x 247.7 mm)	48.3 x 30.7 x 9.8 inches (1227.1 x 779.2 x 247.7 mm)
<b>Weight</b>		
<b>Without Stand</b>	29.5 lbs (13.4 kg)	37.9 lbs (17.2 kg)
<b>With Stand</b>	30.6 lbs (13.9 kg)	39.0 lbs (17.7 kg)
<b>Model Name</b>	QN65Q6FNAF	QN75Q6FNAF
<b>Display Resolution</b>	3840 x 2160	3840 x 2160
<b>Screen Size</b>		
<b>Diagonal</b>	65" Class	75" Class
<b>Measured Diagonally</b>	64.5 inches	74.5 inches
<b>Sound (Output)</b>	40 W	40 W
<b>Dimensions (W x H x D)</b>		
<b>Body</b>	56.9 x 32.8 x 2.2 inches (1446.3 x 833.8 x 54.9 mm)	65.9 x 38.0 x 2.3 inches (1673.8 x 964.1 x 57.6 mm)
<b>With stand</b>	56.9 x 35.8 x 11.2 inches (1446.3 x 909.4 x 285.7 mm)	65.9 x 41.3 x 14.1 inches (1673.8 x 1048.3 x 359.1 mm)
<b>Weight</b>		
<b>Without Stand</b>	53.4 lbs (24.2 kg)	79.4 lbs (36.0 kg)
<b>With Stand</b>	54.7 lbs (24.8 kg)	81.1 lbs (36.8 kg)



Model Name	QN82Q6FNAF
Display Resolution	3840 x 2160
Screen Size Diagonal Measured Diagonally	82" Class 81.5 inches
Sound (Output)	40 W
Dimensions (W x H x D) Body	72.0 x 41.5 x 2.4 inches (1830.0 x 1054.0 x 60.9 mm)
With stand	72.0 x 45.1 x 15.2 inches (1830.0 x 1144.6 x 387.3 mm)
Weight Without Stand	98.1 lbs (44.5 kg)
With Stand	100.8 lbs (45.7 kg)

## Environmental Considerations

Operating Temperature	50°F to 104°F (10°C to 40°C)
Operating Humidity	10% to 80%, non-condensing
Storage Temperature	-4°F to 113°F (-20°C to 45°C)
Storage Humidity	5% to 95%, non-condensing

### Notes

- Design and specifications are subject to change without prior notice.
- This device is a Class B digital apparatus.
- For information about the power supply, and more information about power consumption, refer to the information on the label attached to the product.
  - On most models, the label is attached to the back of the TV. (On some models, the label is inside the cover terminal.)
- Typical power consumption is measured according to Energy Star Program requirements for televisions.
- Your TV and its accessories may look different than the product images presented in this manual, depending on the model.
- All drawings are not necessarily to scale. Some dimensions are subject to change without prior notice. Refer to the dimensions before installing your TV. Not responsible for typographical or printed errors.
- To connect a LAN cable, use a CAT 7 (\*STP type) cable for the connection.
  - \* Shielded Twist Pair

© 2018 Samsung Electronics America, Inc

Dispose unwanted electronics through an approved recycler.

To find the nearest recycling location, go to our website:

[www.samsung.com/recyclingdirect](http://www.samsung.com/recyclingdirect) or call, (877) 278 - 0799

## Decreasing power consumption

When you shut the TV off, it enters Standby mode. In Standby mode, it continues to draw a small amount of power. To decrease power consumption, unplug the power cord when you don't intend to use the TV for a long time.

## Dimensions

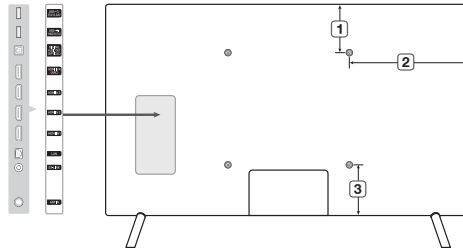

- The displayed image may differ from your TV, depending on the model.

(Unit: inches)

Model name	①	②	③
QN49Q6FNAF	4.8	17.5	11.9
QN55Q6FNAF	7.8	20.1	11.9
QN65Q6FNAF	4.8	20.5	11.9
QN75Q6FNAF	9.9	25.0	11.9
QN82Q6FNAF	15.1	24.1	10.3

## Licenses

**DOLBY AUDIO™**

POWERED BY  
**QUICKSET®**

**HEVC Advance™**  
Covered by Patents at [patentlist.hevcadvance.com](http://patentlist.hevcadvance.com)

**HDMI™**  
HIGH-DEFINITION MULTIMEDIA INTERFACE

The terms HDMI and HDMI High-Definition Multimedia Interface, and the HDMI Logo are trademarks or registered trademarks of HDMI Licensing LLC in the United States and other countries.

# FCC and Warranty Information

## Federal Communication Commission Interference Statement

This equipment has been tested and found to comply with the limits for a Class B digital device, pursuant to Part 15 of the FCC Rules. These limits are designed to provide reasonable protection against harmful interference in a residential installation. This equipment generates, uses and can radiate radio frequency energy and, if not installed and used in accordance with the instructions, may cause harmful interference to radio communications. However, there is no guarantee that interference will not occur in a particular installation. If this equipment does cause harmful interference to radio or television reception, which can be determined by turning the equipment off and on, the user is encouraged to try to correct the interference by one of the following measures:

- Reorienting or relocating the receiving antenna.
- Increasing the separation between the equipment and receiver.
- Connecting the radio or TV to an outlet that is on a different circuit than the equipment.
- Consulting the dealer or an experienced radio/TV technician for help.

**FCC Caution:** Any changes or modifications not expressly approved by the party responsible for compliance could void the user's authority to operate this equipment.

This device complies with Part 15 of the FCC Rules. Operation is subject to the following two conditions: (1) This device may not cause harmful interference, and (2) this device must accept any interference received, including interference that may cause undesired operation.

For products available in the US and Canadian markets, only channels 1~11 are available. You cannot select other channels.

This device and its antenna(s) must not be co-located or operated in conjunction with any other antenna or transmitter.

### **FCC Radiation Exposure Statement:**

This equipment complies with FCC radiation exposure limits set forth for an uncontrolled environment. This equipment should be installed and operated so there is at least 8 inches (20 cm) between the radiator and your body.

## LIMITED WARRANTY TO ORIGINAL PURCHASER

This SAMSUNG brand product, as supplied and distributed by SAMSUNG and delivered new, in the original carton to the original consumer purchaser, is warranted by SAMSUNG against manufacturing defects in materials and workmanship for period of:

Categories	Parts	Labor	Size	Service
LCD/LED TV	1 Year	1 Year	42" and Larger	Carry-In or In Home
			40" and Smaller	Carry-In

- For commercial use, the warranty is 90 Days Parts and Labor.

This limited warranty begins on the original date of purchase, and is valid only on products purchased and used in the United States. To receive warranty service, the purchaser must contact SAMSUNG for problem determination and service procedures.

Warranty service can only be performed by a SAMSUNG authorized service center. The original dated bill of sale must be presented upon request as proof of purchase to SAMSUNG or SAMSUNG's authorized service center.

SAMSUNG will repair or replace this product, at our option and at no charge as stipulated herein, with new or reconditioned parts or products if found to be defective during the limited warranty period specified above. All replaced parts and products become the property of SAMSUNG and must be returned to SAMSUNG. Replacement parts and products assume the remaining original warranty, or ninety (90) days, whichever is longer.

Certain products are eligible for In-home service at Samsung's discretion. To receive in-home service, the product must be unobstructed and accessible to service personnel. If during in-home service, repair cannot be completed, it may be necessary to remove, repair and return the product. If in-home service is unavailable, SAMSUNG may elect, at our option, to provide for transportation of our choice to and from a SAMSUNG authorized service center. Otherwise, transportation to and from the SAMSUNG authorized service center is the responsibility of the purchaser.

This limited warranty covers manufacturing defects in materials and workmanship encountered in normal, and except to the extent otherwise expressly provided for in this statement, noncommercial use of this product, and shall not apply to the following, including, but not limited to: damage which occurs in shipment; delivery and installation; applications and uses for which this product was not intended; altered product or serial numbers; cosmetic damage or exterior finishes; accidents, abuse, neglect, fire, water, lightning or other acts of nature; use of products, equipment, systems, utilities, services, parts, supplies, accessories, applications, installations, repairs, external wiring or connectors not supplied or authorized by SAMSUNG which damage this product or result in service problems; incorrect electrical line voltage, fluctuations and surges; customer adjustments and failure to follow operating instructions, cleaning, maintenance and environmental instructions that are covered and prescribed in the instruction book; reception problems and distortion related to noise, echo, interference or other signal transmission and delivery problems; or brightness related to normal aging or any other issues if the TV is used for commercial or non-normal consumer use. SAMSUNG does not warrant uninterrupted or error-free operation of the product.

THERE ARE NO EXPRESS WARRANTIES OTHER THAN THOSE LISTED AND DESCRIBED ABOVE, AND NO WARRANTIES WHETHER EXPRESS OR IMPLIED, INCLUDING, BUT NOT LIMITED TO, ANY IMPLIED WARRANTIES OF MERCHANTABILITY OR FITNESS FOR A PARTICULAR PURPOSE, SHALL APPLY AFTER THE EXPRESS WARRANTY PERIODS STATED ABOVE, AND NO OTHER EXPRESS WARRANTY OR GUARANTY GIVEN BY ANY PERSON, FIRM OR CORPORATION WITH RESPECT TO THIS PRODUCT SHALL BE BINDING ON SAMSUNG. SAMSUNG SHALL NOT BE LIABLE FOR LOSS OF REVENUE OR PROFITS, FAILURE TO REALIZE SAVINGS OR OTHER BENEFITS, OR ANY OTHER SPECIAL, INCIDENTAL OR CONSEQUENTIAL DAMAGES CAUSED BY THE USE, MISUSE OR INABILITY TO USE THIS PRODUCT, REGARDLESS OF THE LEGAL THEORY ON WHICH THE CLAIM IS BASED, AND EVEN IF SAMSUNG HAS BEEN ADVISED OF THE POSSIBILITY OF SUCH DAMAGES. NOR SHALL RECOVERY OF ANY KIND AGAINST SAMSUNG BE GREATER IN AMOUNT THAN THE PURCHASE PRICE OF THE PRODUCT SOLD BY SAMSUNG AND CAUSING THE ALLEGED DAMAGE. WITHOUT LIMITING THE FOREGOING, PURCHASER ASSUMES ALL RISK AND LIABILITY FOR LOSS, DAMAGE OR INJURY TO PURCHASER AND PURCHASER'S PROPERTY AND TO OTHERS AND THEIR PROPERTY ARISING OUT OF THE USE, MISUSE OR INABILITY TO USE THIS PRODUCT SOLD BY SAMSUNG NOT CAUSED DIRECTLY BY THE NEGLIGENCE OF SAMSUNG. THIS LIMITED WARRANTY SHALL NOT EXTEND TO ANYONE OTHER THAN THE ORIGINAL PURCHASER OF THIS PRODUCT, IS NONTRANSFERABLE AND STATES YOUR EXCLUSIVE REMEDY.

Some states do not allow limitations on how long an implied warranty lasts, or the exclusion or limitation of incidental or consequential damages, so the above limitations or exclusions may not apply to you. This warranty gives you specific legal rights, and you may also have other rights which vary from state to state.

To obtain warranty service, please contact SAMSUNG at:

Samsung Electronics America, Inc.  
85 Challenger Road  
Ridgefield Park, NJ 07660-2112  
1-800-SAMSUNG (726-7864) – [www.samsung.com](http://www.samsung.com)

The benefits of this Limited Warranty extend only to the original purchaser of Samsung products from an authorized Samsung reseller. THIS LIMITED WARRANTY SHALL NOT APPLY TO ANY SAMSUNG PRODUCTS PURCHASED FROM UNAUTHORIZED RESELLERS OR RETAILERS, EXCEPT IN STATES WHERE SUCH RESTRICTION MAY BE PROHIBITED. For a list of Samsung authorized retailers, please go to: [http://www.samsung.com/us/peaceofmind/authorized\\_resellers.html](http://www.samsung.com/us/peaceofmind/authorized_resellers.html).

This page is intentionally  
left blank.

This page is intentionally  
left blank.

# SAMSUNG

## Contact SAMSUNG WORLD WIDE

If you have any questions or comments relating to Samsung products, please contact the SAMSUNG customer care center.

Country	Customer Care Center ☎	Web Site	Address
CANADA	1-800-SAMSUNG (726-7864)	<a href="http://www.samsung.com/ca/support">www.samsung.com/ca/support</a> (English) <a href="http://www.samsung.com/ca_fr/support">www.samsung.com/ca_fr/support</a> (French)	Samsung Electronics Canada Inc. 2050 Derry Road West Mississauga, Ontario L5N 0B9 Canada
U.S.A	1-800-SAMSUNG (726-7864)	<a href="http://www.samsung.com/us/support">www.samsung.com/us/support</a>	Samsung Electronics America, Inc. 85 Challenger Road Ridgefield Park, NJ 07660

accessibility contact information in U.S.A. : [accessibility@sea.samsung.com](mailto:accessibility@sea.samsung.com)

Scan the QR code to view our helpful how-to videos



Scan this QR code with your smart phone to see helpful videos.

If you experience issues, please do not take the TV back to the store.

In the United States of America, call us at 1-800-SAMSUNG (1-800-726-7864) or visit us at [www.samsung.com](http://www.samsung.com) or [www.samsung.com/spsn](http://www.samsung.com/spsn) for support and warranty service.



For more information, see "Troubleshooting" in this manual.

