

SMARTCODE™ 910 DEADBOLT FEATURING ZIGBEE® HA1.2

Model #: 910

Function: Single Cylinder Electronic Deadbolt



Convenience

- Backlit keypad with one-touch locking
- Motorized locking mechanism enables true remote locking & unlocking
- Tapered deadbolt design permits misaligned doors to lock & unlock with ease
- SmartKey® easy re-key backup keyway
- Interior LED status indicator—Locked/Unlocked status & low battery status
- Auto re-lock feature—locks door 30-seconds after unlocking

Security

- 30 user access code capacity, 4-8 digit code length
- 128-bit Advanced Encryption Standard (AES) communication
- Meets BHMA Grade 2 deadbolt operational and security standards
- Drill and pick resistant backup keyway with BumpGuard™ protection
- Independent, local user authentication - No controller connectivity required
- User settings stored on lock memory - settings remain even in case of a power outage

Customizable Features

- Auto re-lock 30-seconds after unlocking - ON/OFF
- Interior LED locked/unlocked status - ON/OFF
- Audible feedback - ON/OFF

Specifications

Electrical:

Input Power 6V (4 x AA alkaline batteries)

Mechanical:

Door Prep 2 1/8" diameter face hole & 1" diameter latch hole

Backset Adjustable 2 3/8" or 2 3/4"

Door Thickness 1 3/8" - 2" automatic adjustment

Faceplates 1" x 2 1/4" round corner standard

Strikes Round corner strike 2 3/4" x 2 1/8"

Latch Round corner adjustable 2 3/8" x 2 3/4"

Bolt 1" throw, steel deadbolt

Door Handing Reversible

Cylinder SmartKey Security™

Environmental:

Temperature Range Exterior: -40°F to 150°F
Interior: 32°F to 140°F

Humidity Exterior: 100% condensing
Interior: 99% non-condensing

SMARTCODE 910
TOUCHPAD ELECTRONIC DEADBOLT

With ZigBee® HA1.2 Wireless Technology



Wireless Communication



- ZigBee® wireless technology
- RF Operation: 2.4 GHz (US)
- Range: Typical 250ft line of sight

Electronic Compliance

- ZigBee: HA1.2
- FCC Part 15
- Industry Canada

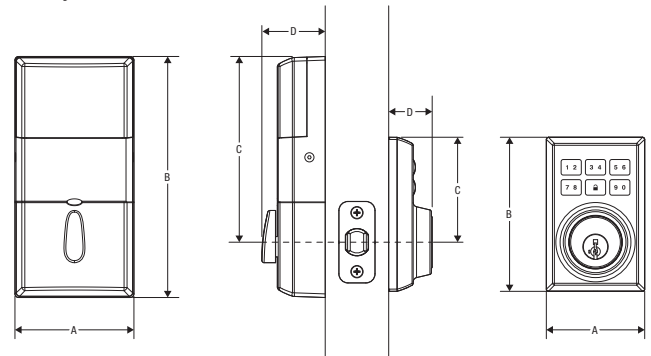

Design	A	B	C	D
Interior	3 9/32" (83.34 mm)	6 21/32" (169.07 mm)	5 1/8" (130.18 mm)	1 3/4" (44.45 mm)
Exterior	2 3/4" (69.85 mm)	4 1/4" (107.95 mm)	3" (76.20 mm)	1 7/32" (30.96 mm)

HA 1.2 Enabled Lock Features:

- Monitor lock status (locked/unlocked)
- Remote locking and unlocking
- Lock jam notification

HA1.2 Enabled Lock Management Features:

- Over the Air Updates
 - ZigBee daughter card and Lock mainboard updates
- Multiple user type settings
 - 24/7 user codes
 - Time limited user codes (up to 7 schedules per user)
 - One-time user codes
- Remote Lock Configuration
 - Add/Remove users
 - Status LED On/Off
 - AutoLock (time is user configurable)
 - Sound on/off
- Remote and local reset to factory default settings
- Remote power status information
- Remotely disable/enable local programming interface
- Tamper detection - Alarm if the device senses lock disassembly
- Audio/Visual enrollment success indicator
- Invalid code entry alarm with lockout state duration (user configurable)