

Kwikset

A Smarter
Kind of
Simple™



RAS Price Book

July 2023

GENERAL INFORMATION

Terms and Conditions	4
----------------------	---

NEW PRODUCTS

HomeConnect 620 Keypad Connected Smart Lock	6
Halo	8

ELECTRONIC LOCKS

Halo	12
Smartcode	13
Home Connect	14
Specifications	16

SERVICE PARTS

Electronics	19
-------------	----

TERMS AND CONDITIONS OF SALE

Standard terms are 2% prompt payment discount for payment within 25 days from date of invoice; net 30 days from the date of invoice. Kwikset® reserves the right to charge and recover on invoices which are not paid within the above terms, a service charge of 1-1/2% a month for each month or fraction thereof during which the invoice remains unpaid, said service charge, however, not to exceed the highest applicable legal rate of interest. All orders, whether solicited or written by our sales representatives or forwarded by our customers are deemed to be mere offers to purchase in accordance with these Terms and Conditions of Sale until actually accepted by us at our home office in Lake Forest, CA. We reserve the right to refuse any order as well as the right to sell or not sell to any firm at our sole discretion. The acceptance of an order is expressly made conditional upon your assent to these Terms and Conditions of Sale. We object to the inclusion of any different or additional terms or conditions, even if the same are included in your order, a contract of sale will result upon the Terms and Conditions of Sale stated herein only. Prices reflected in this book apply to Wholesale customers only.

All sales are final.

PRICES

Pricing based on full-case quantities only; orders for less than full case will be automatically adjusted up to the next full-case quantity. All prices are subject to change without notice and are not guaranteed. All taxes, duties or other charges are the responsibility of the customer.

CLAIMS

Price claims must be submitted in writing to Kwikset, 19701 Da Vinci, Lake Forest, CA 92610 within 30 days from the date of invoice.

CHANGES OR CANCELLATIONS

Beyond 5 working days of our acknowledgement date no changes can be made. Additions to an order will be handled as a separate order and must meet applicable minimum order requirements. Order cancellation on regular stock items only, or any portion thereof is allowed only upon prior written consent from Kwikset, and the payment of cancellation charges deemed appropriate.

MINIMUM CHARGE

No order will be invoiced for less than \$100.00 net plus shipping charges except for lock accessory parts.

MINIMUM ANNUAL SALES VOLUME

The company reserves the right to discontinue direct sales to any customer who does not meet the minimum annual sales volume requirement. The current annual requirement is \$50,000.00. Your annual purchases are determined by accepted, non-cancelled, and shipped orders received during each calendar year. Kwikset reserves the right to change any or all minimum annual sales volume requirements at any time. Any customer who does not meet the annual sales volume requirements may continue to purchase Kwikset products through a Kwikset distributor.

RETURNS

Defective merchandise returned to our factories requires prior written authorization from a Kwikset Sales Rep or the Sales Office. A factory return authorization must accompany the returned shipment. The return authorization must include an itemized listing of the merchandise and an explanation stating the reason for return.

There will be a 20% product restocking fee on all returned merchandise.

FREIGHT

All goods are invoiced FOB to our factory. Upon delivery of shipments to the carrier, title to, and the risk of loss or damage in transit for such shipments, passes to our customer. Kwikset's standard policy is to pay freight charges on all orders over \$1,000.00 net invoice value to a single destination in the continental U.S., by carrier and route of our choice. Shipments less than these quantities will not be shipped on a prepaid basis. If higher freight charges are incurred from customers specifying a carrier or route of their choice the additional cost will be added to that customer's invoice.

DELIVERY CONDITIONS

Shipping schedules are our best estimates, and cannot be guaranteed. Kwikset is not responsible for any direct or consequential loss or damage resulting from an inability or delay in meeting shipping schedules.

KWIKSET LIMITED WARRANTIES

Kwikset products are backed by one of the most comprehensive warranty programs available. You can feel confident that with the purchase of Kwikset you have selected the best quality product, backed by the best customer service available.

MECHANICAL LIMITED WARRANTY

Except as otherwise provided below, Spectrum Brands, Inc., for its Kwikset® brand products ("Kwikset"), warrants to the original residential purchaser (the "Purchaser") that each Kwikset product (the "Product(s)" or "Kwikset Product(s)") will be free from mechanical defects under normal use from the date of purchase for as long as said Purchaser occupies the residential premises upon which the Product was originally installed ("Warranty Period"). This Mechanical Limited Warranty applies only to Products that were purchased from Kwikset or a Kwikset authorized seller, unless otherwise prohibited by law. Kwikset Products are legitimately sold only by authorized sellers who are required to follow Kwikset's policies, procedures, and quality control standards. Kwikset reserves the right to reject warranty claims from purchasers for Products purchased from unauthorized sellers, including unauthorized Internet sites.

FINISH LIMITED WARRANTY

The finish on Kwikset Products is protected by a durable topcoat designed to maintain the beauty and quality of the Kwikset Product. Kwikset warrants to the Purchaser that the finish of the Product shall be free of defects in material and workmanship from tarnishing, flaking, and discoloring from the date of purchase for as long as said Purchaser occupies the residential premises upon which the Product was originally installed ("Warranty Period"). This Finish Limited Warranty applies only to Products that were purchased from Kwikset or a Kwikset authorized seller, unless otherwise prohibited by law. Kwikset Products are legitimately sold only by authorized sellers who are required to follow Kwikset's policies, procedures, and quality control standards. Kwikset reserves the right to reject warranty claims from purchasers for Products purchased from unauthorized sellers, including unauthorized Internet sites.

ELECTRONIC LIMITED WARRANTY

Kwikset warrants to the Purchaser that Kwikset Products will be free from electronic defects under normal use for one (1) year from the date of purchase, as long as said Purchaser occupies the residential premises upon which the Product was originally installed ("Warranty Period"). This Electronic Limited Warranty applies only to Products that were purchased from Kwikset or a Kwikset authorized seller, unless otherwise prohibited by law. Kwikset Products are legitimately sold only by authorized sellers who are required to follow Kwikset's policies, procedures, and quality control standards. Kwikset reserves the right to reject warranty claims from purchasers for Products purchased from unauthorized sellers, including unauthorized Internet sites.

EXCLUSIONS FROM WARRANTY

1. Any Kwikset Product produced prior to January 1, 2006.¹
2. Any Kwikset Product which has been damaged as a result of installation contrary to any of Kwikset's written installation instructions is not covered by these warranties.
3. Any Kwikset Product which has been modified by any non-Kwikset component is not covered by these warranties.
4. Any Kwikset Product having a defect caused by neglect, misuse, abuse or unreasonable or extraordinary use or maintenance, including use in a commercial application, is not covered by these warranties.
5. Any Kwikset Product having a defect due to use of paints, solvents, or other chemicals is not covered by these warranties.
6. Any Kwikset Product that is used in combination with knobs, levers, or trim of other than those manufactured by Kwikset and designated for use with the applicable locks or latches is not covered by these warranties.
7. Any Kwikset Product that was purchased from an unauthorized seller is not covered by these warranties.

These warranties are not transferable. Therefore, no transferee is covered by these warranties.

¹ Kwikset Products produced prior to January 1, 2006, may be eligible for warranty in accordance with the terms and conditions of the applicable warranty program.

WARRANTY CLAIMS

If you wish to make a warranty claim based upon a Product defect, please call us at 1-800-327-LOCK (5625) or contact us at kwikset.com/support.

Please note that you will be required to provide a description of any claimed defect(s) and a dated receipt or other proof of purchase from Kwikset or the Kwikset authorized seller, to verify warranty eligibility.

Certain claimed defect(s) covered by these warranties may be resolved by Kwikset providing you with troubleshooting steps.

Other claimed defect(s) covered by these warranties may require Product replacement. Products may not be returned to Kwikset without prior authorization from Kwikset. If authorized by Kwikset, you will need to mail your Product to:

Spectrum Brands, Inc.

ATTN: Kwikset Consumer Services

19701 Da Vinci

Lake Forest, CA 92610

A prepaid shipping label will be provided to you.

REMEDIES

For certain claimed defect(s) covered by these warranties, as determined by Kwikset, Kwikset will provide you with troubleshooting steps.

For other claimed defect(s) covered by these warranties, as determined by Kwikset, Kwikset will replace the defective Product or part.

If a Kwikset Product, which is the same as the Kwikset Product or any part covered by these warranties, has been discontinued at the time of replacement or if Kwikset determines, in its sole discretion, that such replacement is inappropriate, Kwikset reserves the right to substitute an alternative product. Kwikset also reserves the right to accept or reject an alternative product proposed as a replacement, when the value is higher than that of the Product originally purchased by the Purchaser. Except as expressly provided in these warranties to the contrary, **KWIKSET SHALL NOT BE OBLIGATED OR LIABLE FOR LABOR OR OTHER COSTS RELATED TO INSTALLATION, REPAIR OR REPLACEMENT OF A KWIKSET PRODUCT, OR FOR LOSS OF, OR DAMAGE TO ANY MATERIAL WHICH IS NOT SOLD BY KWIKSET.**

PATENT INDEMNITY

We agree to defend any suit or proceeding brought against our customer so far as based on claim that our products, or any part thereof, made solely to our specifications and furnished to our customer constitute an infringement of any U.S. patent, if notified promptly in writing and given authority, information and assistance at our expense for the defense of same, and we shall pay all damages and costs awarded therein against our customer. In case our products, or any part thereof, is in such suit held to constitute infringement and their use is enjoined, we will, at our expense and discretion, either procure for our customer the right to continue using the products or replace same with non-infringing products, or modify them so they become non-infringing, or remove such products and refund the purchase price (less depreciation, prorated from the purchase date). The foregoing states our entire liability for patent infringement by our products or any part thereof.

INTELLECTUAL PROPERTY

No person or entity may sell, distribute, advertise, market or promote Kwikset branded products distributed by Kwikset Corporation ("Kwikset"), Spectrum Brands Hardware Home Improvement Division, without prior authorization from Kwikset. Customers of Kwikset who are authorized to sell Kwikset branded products are referred to herein as "Customers."

The Kwikset brand and all Kwikset trademarks, trade names, product depictions, colors, graphics or logos, whether or not registered or otherwise protected (the "Marks"), remain the sole and exclusive property of Kwikset and nothing arising out of the relationship between Kwikset and any Customer conveys to Customer any ownership rights in the Marks. Customer may use the Marks and then only in the sale or promotion of authentic Kwikset products in compliance with the terms of this policy. The Marks must be used exactly in the form provided and in conformity with all Kwikset trademark usage policies or guidelines, including, but not limited to, those relating to shape, color match and imprint quality. Any proposed deviation must be approved in writing by Kwikset prior to use. The Marks may not be used in or as part of any Customer domain name on the Internet. Prior to any use of the Marks on goods or services, Customer must submit samples for Kwikset's approval.

Additionally, no Customer may use product depictions, graphics, logos or text relating to Kwikset products that have not been provided by Kwikset in connection with the advertising, promotion or sale of Kwikset products without Kwikset's prior review and written approval of each such use. The Marks may not be used in or as part of any reseller or other third party (i) domain name or VRL on the Internet, (ii) trademark or service mark, or (iii) company or trade name. Any action on the part of a Customer that violates the terms of this policy or otherwise impairs the value of or goodwill associated with the Marks or is otherwise not in conformity with Kwikset's standards may result in the suspension or termination of the Customer's authorization or any other remedy permitted by law.

Kwikset grants to each of its Customers limited, non-transferable, non-sublicenseable licenses of the patents relating to the Kwikset products that the Customer is authorized to sell and of the copyrights in any packaging or other written materials included therewith or related thereto. Said patent and copyright licenses are solely to sell such Kwikset products covered by such patents and to which such copyrights relate only to end-users and other Customers in compliance with the terms of this document. The sale of such patented Kwikset products and the sale or use of such copyrighted materials by a Customer that violate the terms of this document exceed the scope of the licenses herein granted to the Customer and may constitute patent and/or copyright infringement.

STANDARDS

Kwikset meets or exceeds the testing requirements specified for each product grade or rating.

- American National Standards Institute (ANSI)
- Builders Hardware Manufacturers Association (BHMA)
- Underwriters Laboratories, Inc. (UL)
- Americans with Disabilities Act (ADA)

MISCELLANEOUS

Substitution of non-Kwikset components/parts, and any alteration or modification of factory parts, and other lock manufacturer's parts may result in door hardware which does not function properly or will fail and will void all warranties. Orders not specified with keying requirements will be shipped Keyed Differently (KD). Orders with keying requirements of K10 or more must have a "Letter of Release" on file with Kwikset stating that Kwikset Corporation will not be held liable for cost and expense arising from any loss or damage to property utilizing Kwikset products where 10 or more locks have been keyed alike. Contact your Sales Office account representative for a copy of the release form. Kwikset reserves the right to revise or modify products, product information, or pricing without notice. Product specifications and pricing reflect available information at the time of printing. Kwikset is not responsible for typographic or printing errors.

LIMITATION OF LIABILITIES

THERE ARE NO WARRANTIES WHICH EXTEND BEYOND THOSE STATED HEREIN. ANY IMPLIED WARRANTIES THAT MAY BE APPLICABLE TO PRODUCTS, INCLUDING IMPLIED WARRANTIES OF MERCHANTABILITY OR FITNESS FOR A PARTICULAR PURPOSE, ARE LIMITED IN DURATION TO THE DURATION OF THIS WARRANTY. SOME STATES DO NOT ALLOW LIMITATIONS ON HOW LONG AN IMPLIED WARRANTY LASTS, SO THE ABOVE LIMITATION MAY NOT APPLY TO YOU. UNDER NO CIRCUMSTANCES SHALL KWIKSET BE LIABLE FOR ANY SPECIAL, INCIDENTAL, OR CONSEQUENTIAL DAMAGES BASED UPON BREACH OF THIS LIMITED WARRANTY, BREACH OF CONTRACT, OR STRICT LIABILITY. SOME STATES DO NOT ALLOW THE EXCLUSION OR LIMITATION OF INCIDENTAL OR CONSEQUENTIAL DAMAGES, SO THE ABOVE LIMITATION OR EXCLUSION MAY NOT APPLY TO YOU. THIS WARRANTY GIVES YOU SPECIFIC LEGAL RIGHTS, AND YOU MAY ALSO HAVE OTHER RIGHTS WHICH VARY FROM STATE TO STATE.

Effective Date: [July 6th 2020]

HomeConnect 620

KEYPAD CONNECTED SMART LOCK

With Z-Wave® 700 Chipset



Features

- 10-Button keypad with one-touch locking
- Featuring Smartkey® Security Technology
- Sleek, all metal design
- Z-Wave® 700 for enhanced network security, network pre-enrollment, and extended wireless range and battery life
- Backward compatible with existing Z-Wave panels and hubs
- S2 Secure Network Enrollment
- SmartStart Network Pre-Enrollment

User Codes

- 250 user codes
- Control when people have access with customizable user code schedules
- MasterCode security for improved feature management

Connected Benefits

- Lock/Unlock your doors from anywhere
- View lock status and receive notifications of your lock's activity
- Connect to other devices in the home and create scenes driven by the door lock

Specifications

Electrical:

Input Power	6V (4 x AA alkaline batteries)
--------------------	--------------------------------

Mechanical:

Door Prep	1 1/2" & 2 1/8" diameter bore hole & 1" deep latch hole
Backset	Adjustable 2 3/8" or 2 3/4"
Door Thickness	1 3/8" - 2" automatic adjustment
Faceplates	1" x 2 1/4" round corner standard
Strikes	Round corner strike 1 1/8" x 2 3/4"
Latch	Round corner adjustable 2 3/8" x 2 3/4"
Bolt	1" throw, steel deadbolt
Door Handing	Reversible
Cylinder	SmartKey® Keyway

Environmental:

Temperature Range	Exterior: -40°F to 150°F Interior: 32°F to 140°F
Humidity	Exterior: 100% condensing Interior: 30% - 95% non-condensing

Finishes



Satin Nickel 15



Venetian Bronze 11P



Polished Brass 3



Satin Nickel 15



Venetian Bronze 11P



Polished Chrome 26



Matte Black 514

Dimensions

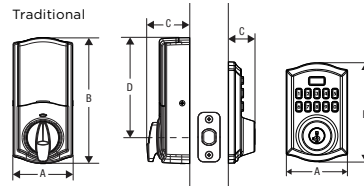

	Interior	Exterior
A	2 23/32" (69.1 mm)	2 15/16" (71.43 mm)
B	5 25/32" (146.6 mm)	4 9/16" (115.887 mm)
C	1 15/16" (49.5 mm)	1 1/4" (31.75 mm)
D	4 19/32" (116.5 mm)	---

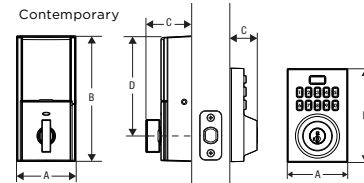

	Interior	Exterior
A	2 23/32" (69.1 mm)	2 25/32" (70.64 mm)
B	5 25/32" (146.6 mm)	4 9/16" (109.53 mm)
C	2 1/8" (53.97 mm)	1 1/4" (31.75 mm)
D	4 1/2" (114.3 mm)	---

Easy Installation

- Replaces existing door hardware with just a screwdriver
- No hard wiring needed
- Operates on 4 x AA alkaline batteries

Innovative Security

- BHMA Grade 2 certified
- Full 128-bit encryption security
- Features SmartKey® Security Re-Key Technology with BumpGuard™ Protection
- Revolutionary tapered deadbolt design—enables misaligned doors to lock without pulling and pushing your door shut
- Supports S2 Secure Network Enrollment

FINISH AND
LIFETIME
MECHANICAL
WARRANTY
ONE YEAR
ELECTRONIC WARRANTY

Kwikset



HALO™



TOUCH

FINGERPRINT SMART LOCK

The Halo Touch Wi-Fi enabled smart lock with fingerprint access technology allows you to simply use your unique fingerprint to lock and unlock your door.



Wi-Fi Enabled



Works with the Kwikset App



HALO™

WI-FI ENABLED SMART LOCKS

Halo smart locks connect directly to your existing home Wi-Fi network and smartphone to create a simple and secure smart home, without a third-party hub, panel or subscription service.

1509572

SMART LOCKS AND KEYLESS ENTRY LOCKS

NON-CONNECTED

Kwikset's electronic door locks offer users the convenience of keyless entry, virtually eliminating the need for keys. All of our electronic locks are easy to install and program while complementing any Kwikset knob, lever or handleset.

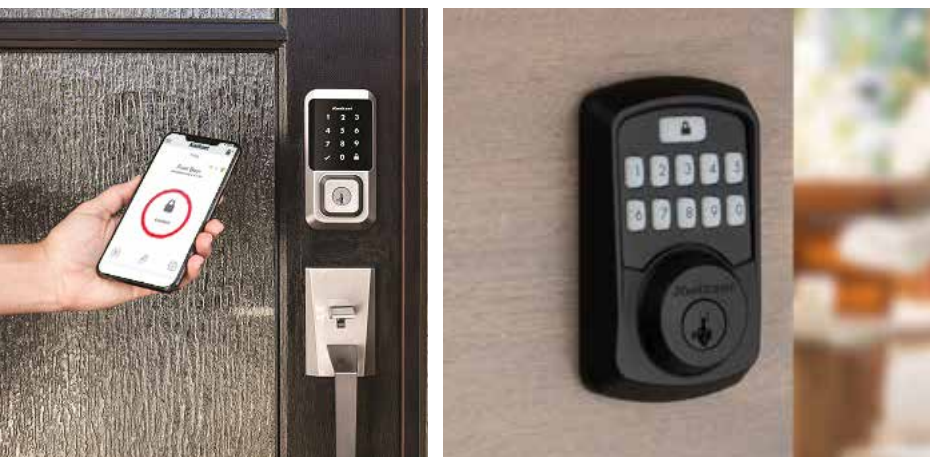

Features

- Smart Locks Replace any Deadbolt for Keyless Entry Convenience
- SmartCode™ Lever Ideal for - Small/Home Office, Utility/Storage Room, Interior Garage/Side Door
- Lock Your Door with the Touch of a Button
- Customizable Access Codes for Increased Security
- Back-Lit Keypad for Increased Visibility
- Customizable Automatic Door Locking After 30 Seconds for Peace Of Mind
- Installs In Minutes with Just a Screwdriver - No Hard Wiring Required
- Fits Standard Doors (1 3/8" - 2") with No Screw Holes Required

Warranty

- 1 Year Electronic Warranty
- Lifetime Finish & Mechanical Warranty

NON-CONNECTED



**Halo™
Touchscreen**



**Halo™
Keypad**



**Halo™ Touch
Traditional**



**Halo™ Touch
Contemporary**



Aura™



**SmartCode™
260 TRL**



**SmartCode™
260 CNT**

**Halo Wi-Fi Enabled
Smart Locks**

Model	Description	Finish				Case Qty
		11P	15	26	514	
939 Halo Touchscreen	WiFi Enabled Deadbolt	\$504.00	\$504.00	\$504.00	\$504.00	1
938 Halo Touchpad	WiFi Enabled Deadbolt	\$438.00	\$438.00			1
959 Halo Touch Traditional	WiFi Enabled Deadbolt	\$517.00	\$517.00			1
959 Halo Touch Contemporary	WiFi Enabled Deadbolt		\$517.00		\$517.00	1

**Aura™
Bluetooth**

Model	Description	Finish								Case Qty		
		3	L03	5	11P	15	15A	26	26D		514	
942 BLE	Touchscreen Electronic Deadbolt				\$328.00	\$328.00					\$328.00	1

**SmartCode™ 260
TRL**

Model	Description	Finish								Case Qty		
		3	L03	5	11P	15	15A	26	26D		514	
260 TRL SMT	Keypad Electronic Deadbolt		\$231.00		\$231.00	\$231.00						2

**SmartCode™ 260
CNT**

Model	Description	Finish								Case Qty		
		3	L03	5	11P	15	15A	26	26D		514	
260 CNT SMT	Keypad Electronic Deadbolt					\$231.00		\$231.00		\$231.00		2

NON-CONNECTED



**SmartCode™
270 TRL**

**SmartCode™
270 CNT**

**SmartCode™
917 TNL**

**SmartCode™
917 HFL**

**Powerbolt™
240 TRL**

**Powerbolt™
240 CNT**

**Powerbolt™
250 TRS**

**SmartCode™
955 TRL**

SmartCode™ 270

TRL	Model	Description	Finish									Case
			3	L03	5	11P	15	15A	26	26D	514	Qty
	270 TRL SMT	Touchscreen Electronic Deadbolt				\$275.00	\$275.00					2

SmartCode™ 270

CNT	Model	Description	Finish									Case
			3	L03	5	11P	15	15A	26	26D	514	Qty
	270 CNT SMT	Touchscreen Electronic Deadbolt					\$275.00				\$275.00	2

SmartCode™ 917

TNL	Model	Description	Finish									Case
			3	L03	5	11P	15	15A	26	26D	514	Qty
	917 TNL	Touchpad Electronic Lever Tustin				\$262.00	\$262.00					2

SmartCode™ 917

HFL	Model	Description	Finish									Case
			3	L03	5	11P	15	15A	26	26D	514	Qty
	917 HFL	Touchpad Electronic Lever Halifax					\$262.00		\$262.00		\$262.00	2

Powerbolt 240®

TRL	Model	Description	Finish									Case
			3	L03	5	11P	15	15A	26	26D	514	Qty
	240 TRL	Keypad Electronic Deadbolt		\$100.00		\$100.00	\$100.00					2

Powerbolt 240®

CNT	Model	Description	Finish									Case
			3	L03	5	11P	15	15A	26	26D	514	Qty
	240 CNT	Keypad Electronic Deadbolt					\$100.00				\$100.00	2

Powerbolt 250®

SMT	Model	Description	Finish									Case
			3	L03	5	11P	15	15A	26	26D	514	Qty
	250 TRS SMT	Keypad Electronic Deadbolt		\$143.00		\$143.00	\$143.00				\$143.00	2

SmartCode™

955 Touchpad

Commercial Grade	Model	Description	Finish									Case
			3	L03	5	11P	15	15A	26	26D	514	Qty
	955	Touchpad Electronic Commercial Deadbolt				\$237.00	\$237.00			\$237.00	\$237.00	



**HOME
CONNECT™**
ELECTRONIC SMART LOCKS

Control your lock from anywhere on your smart phone, tablet, or internet connected device and never worry about forgetting to lock your door again.

- Remotely lock and unlock your door from anywhere
- Receive notifications of your lock's activity
- Control when others have access to your home
- Arm or disarm your security panel
- Wirelessly communicate to other devices in your home



Features

- Full 128-Bit Encryption Security
- Motorized locking mechanism enables true remote locking & unlocking
- Z-Wave Wireless Protocol
- SmartKey Security - providing superior security against advanced break-in techniques.
- Easy Integration
- Fits Standard Doors (1 3/8"-2") with No Screw Holes Required
- 4 AA Alkaline Batteries (no hard wiring) - batteries last for approximately 1 year

Electronic Locks with Home Connect (Z-Wave)

Item Number	Function	Finish						Case Qty.	Price
		L03	11P	15	26	26D	514		
HomeConnect™ 620 Traditional		L03	11P	15	26	26D	514		
98930-001	HC620 TRL ZW700 15 SMT RCALFD RCS BP			•				1	\$297.00
98930-002	HC620 TRL ZW700 11P SMT RCALFD RCS BP		•					1	\$297.00
98930-003	HC620 TRL ZW700 L03 SMT RCALFD RCS BP	•						1	\$297.00
HomeConnect™ 620 Contemporary		L03	11P	15	26	26D	514		
98930-004	HC620 CNT ZW700 15 SMT RCALFD RCS BP			•				1	\$297.00
98930-005	HC620 CNT ZW700 11P SMT RCALFD RCS BP		•					1	\$297.00
98930-006	HC620 CNT ZW700 26 SMT RCALFD RCS BP				•			1	\$297.00
98930-007	HC620 CNT ZW700 514 SMT RCALFD RCS BP						•	1	\$297.00
SmartCode™ 916 Contemporary with Home Connect Z-Wave		L03	11P	15	26	26D	514		
99160-041	916CNT 500 15 SMT CP TPR RCALFD V2			•				1	\$506.00
99160-042	916CNT 500 11P SMT CP TPR RCALFD V2		•					1	\$506.00
99160-043	916CNT 500 26 SMT CP TPR RCALFD V2				•			1	\$506.00
99160-044	916CNT 500 514 SMT CP TPR RCALFD V2						•	1	\$506.00
SmartCode™ 916 with Home Connect Z-Wave		L03	11P	15	26	26D	514		
99160-038	916TRL 500 15 SMT CP TPR RCALFD V2			•				1	\$506.00
99160-039	916TRL 500 11P SMT CP TPR RCALFD V2		•					1	\$506.00
SmartCode™ 912 with Home Connect		L03	11P	15	26	26D	514		
99120-037	912TNL ZW500 15 RCALFD			•				1	\$413.00
99120-038	912TNL ZW500 11P RCALFD		•					1	\$413.00
Home Connect™ 914 Traditional Zigbee 3.0		L03	11P	15	26	26D	514		
99140-029	914TRL ZB 3.0 L03 SMTCD CP TPR RCALFD	•						1	\$435.00
99140-030	914TRL ZB 3.0 15 SMTCD CP TPR RCALFD			•				1	\$435.00
99140-031	914TRL ZB-3.0 11P SMTCD CP TPR RCALFD		•					1	\$435.00
Home Connect™ 914 Contemporary Zigbee 3.0		L03	11P	15	26	26D	514		
99140-134	914CNT ZB 3.0 15 SMTCD CP TPR RCALFD			•				1	\$435.00
99140-135	914CNT ZB 3.0 11P SMTCD		•					1	\$435.00
99140-136	914CNT ZB 3.0 514 SMTCD						•	1	\$435.00
99140-137	914CNT ZB 3.0 26 SMTCD				•			1	\$435.00
Home Connect™ 916 Traditional Zigbee 3.0		L03	11P	15	26	26D	514		
99160-031	916TRL TSCR ZB-3.0 L03 SMTCDTPR RCALFD	•						1	\$506.00
99160-032	916TRL TSCR ZB-3.0 15 SMTCD TPR RCALFD			•				1	\$506.00
99160-033	916TRL TSCR ZB-3.0 11P SMTCDTPR RCALFD		•					1	\$506.00
Home Connect™ 916 Contemporary Zigbee 3.0		L03	11P	15	26	26D	514		
99160-035	916CNT TSCR ZB 3.0 11P		•					1	\$506.00
99160-036	916CNT TSCR ZB 3.0 514						•	1	\$506.00
99160-037	916CNT TSCR ZB 3.0 26				•			1	\$506.00
Home Connect™ 914 Zigbee Convert 3.0		L03	11P	15	26	26D	514		
99140-138	914 ZB 3.0 CONVERT L03	•						1	\$284.00
99140-139	914 ZB 3.0 CONVERT 15			•				1	\$284.00
99140-140	914 ZB 3.0 CONVERT 11P		•					1	\$284.00

*Product must be ordered by item number and not description

1509572

Halo™, Halo™ Touch

Function	Single cylinder deadbolt
Door Prep	2 1/8" diameter bore hole & 1" diameter latch hole
Backset	Adjustable 2 3/8" or 2 3/4"
Door Thickness	1 3/8" - 2" automatic adjustment
Faceplates	1" x 2 1/4" round corner standard
Strikes	Round corner, 4 hole strike, 2 3/4" x 1 1/8"
Latch	Round corner adjustable 2 3/8" x 2 3/4"
Bolt	1" throw, steel deadbolt
Door Handing	Reversible
Cylinder	SmartKeySecurity™

SMARTCODE™ 916/914

Door Prep	2-1/8" diameter face hole & 1" diameter latch hole
Backset	Adjustable to 2-3/8" or 2-3/4"
Door Thickness	1-3/8" to 2" automatic adjustment
Cylinder	SmartKey Security
Faceplate	1" x 2-1/4". Round corner standard
Strikes	Round corner strike 1-1/8" x 2-3/4"
Bolt	1" throw, steel deadbolt
Door Handing	Reversible
Batteries	4 AA Alkaline
Wireless Communication	Z-Wave wireless technology
Operation	908.42 MHz (US)
Range	Typical 100ft line of sight

HomeConnect™ 620

Electrical:	
Input Power	6V (4 x AA alkaline batteries)
Mechanical:	
Door Prep	1 1/2" & 2 1/8" diameter bore hole & 1" deep latch hole
Backset	Adjustable 2 3/8" or 2 3/4"
Door Thickness	1 3/8" - 2" automatic adjustment
Faceplates	1" x 2 1/4" round corner standard
Strikes	Round corner strike 1 1/8" x 2 3/4"
Latch	Round corner adjustable 2 3/8" x 2 3/4"
Bolt	1" throw, steel deadbolt
Door Handing	Reversible
Cylinder	SmartKey® Keyway
Environmental:	
Temperature Range	Exterior: -40°F to 150°F Interior: 32°F to 140°F
Humidity	Exterior: 100% condensing Interior: 30% - 95% non-condensing

Kwikset Convert

Function	Smart Lock Conversion Kit
Backset	Adjustable 2 3/8" or 2 3/4"
Door Thickness	1 3/8" - 1 3/4" automatic adjustment
Door Handing	Reversible
Batteries	4AA required

SMARTCODE™ 912 LEVER

Door Prep	2-1/8" diameter face hole & 1" diameter latch hole
Backset	Adjustable to 2-3/8" or 2-3/4"
Door	1-3/8" to 2" automatic adjustment
Thickness	
Cylinder	SmartKey Security
Faceplate	1" x 2-1/4". Round corner standard
Strikes	2-1/4" full lip. Round corner
Bolt	1/2" throw
Door Handing	Reversible
Batteries	4 AA Alkaline
Wireless	Z-Wave wireless technology
Communication	
Operation	908.42 MHz (US)
Range	Typical 100ft line of sight

SMARTCODE™ 955 LEVER

Function	Keyed entry electronic lever
Door Prep	2 1/8" diameter face hole & 1" diameter latch hole
Latch Backset	Adjustable 2 3/8" or 2 3/4"
Door Thickness	Fits 1 3/8" – 1 3/4" door thickness
Faceplate	1" x 2 1/4" round corner standard
Strike	Round corner, 4 hole strike 2 3/4" x 1 1/8"
Latch	Round corner adjustable 2 3/8" x 2 3/4"
Bolt	1/2" throw, dead latch
Door Handing	Reversible
Cylinder	SmartKey Security™
ADA	Certified
UL Rating	20 min

SMARTCODE™ 916/914

Function	Single cylinder deadbolt
Door Prep	2-1/8" diameter face hole & 1" diameter latch hole
Backset	Adjustable to 2-3/8" or 2-3/4"
Door	1-3/8" to 2-1/8" automatic adjustment
Thickness	
Cylinder	SmartKey Security
Faceplates	1" x 2-1/4" round corner standard
Strikes	Round corner, 4 hole strike, 2-3/4" x 1-1/8"
Latch	Round corner adjustable 2-3/8" or 2-3/4"
Bolt	1" throw, steel deadbolt
Door Handing	Reversible
Batteries	4 AA Required

AURA™ DEADBOLT

Door Prep	2-1/8" diameter face hole & 1" diameter latch hole
Backset	Adjustable to 2-3/8" or 2-3/4"
Door	1-3/8" to 2" automatic adjustment
Thickness	
Cylinder	SmartKey Security
Faceplate	1" x 2-1/4". Round corner standard
Strikes	2-3/4" x 1-1/8". Round corner 4 hole strike
Bolt	1" throw
Door Handing	Reversible
Batteries	4 AA Alkaline

AURA

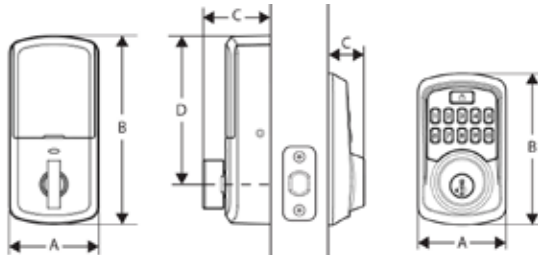

Design	A	B	C	D
Outer Trim	2 3/4"	5 13/16"	2 1/8"	4 9/16"
Inner Trim	2 23/32"	4 5/8"	1 3/16"	---

SMARTCODE™ 916 CNT

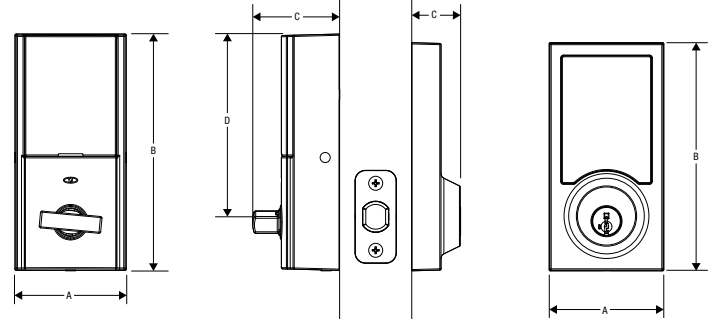

Design	A	B	C	D
Outer Trim	2 11/16"	5 3/4"	2 3/32"	4 9/16"
Inner Trim	2 25/32"	5 7/32"	1 13/16"	---

SMARTCODE™ 912

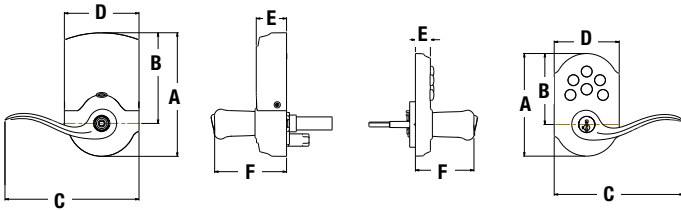

Design	A	B	C	D	E	F
Outer Trim	4 7/16"	3 1/16"	5 19/32"	2 13/16"	2 1/32"	2 17/32"
Inner Trim	5 11/32"	3 15/16"	5 13/16"	3 1/4"	1 5/16"	3 1/8"

SMARTCODE™ 916

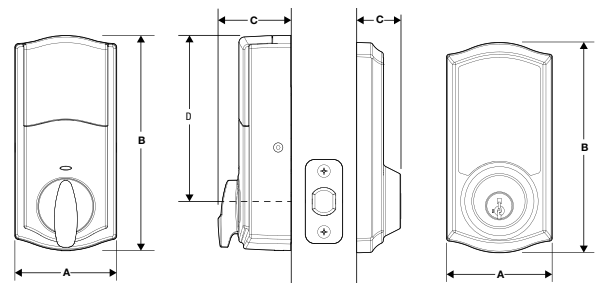



Design	A	B	C	D
Outer Trim	2-13/16"	5-3/8"	1-3/16"	
Inner Trim	2-3/4"	5-3/4"	1-15/16"	4-9/16"

Misc. Parts

	Model	Function	Finish							List Price	
			L03	5	15	15A	26	11P/514	690		NA
	83307	912 Top Battery Holder								•	\$1.90
	83581	916 Battery Pack without Pull Tab (for use with 83580)								•	\$1.90
	83502	888, 938, 939, 942, and HC620 Battery Pack with Pull Tab (For use with: 83813/83814)								•	\$1.90
	85133	938 Halo Exterior Keypad			•				•		\$57.56
	85134	939 Halo Exterior Touchscreen			•			•	•		\$113.01
	85135	942 Aura Exterior Keypad			•				•		\$49.70
	85140	942 Aura Keypad Interior Chassis								•	\$118.30
	85138	938 Halo Keypad Interior Chassis								•	\$180.57
	85139	939 Halo Touchscreen Interior Chassis								•	\$179.54
	83583	Electronics Deadbolt Adapter Ring								•	\$3.05
	83187	Tapered Deadbolt, RC, 2-Way	•		•				•	•	\$5.00
	85137	916, 919, 938, 939, 942, 953, 954, and 959 Interior Mounting Plate								•	\$5.45
	83154	HC620 Interior Mounting Plate								•	\$5.45
	85141	938, 939, and 942 Interior Cover			•			•	•		\$32.10
	83814	Interior Cover, CNT (For use with: Battery Pack with Pull Tab 83502)			•			•			\$32.10
	83813	Interior Cover, TRL (For use with: Battery Pack with Pull Tab 83502)			•			•			\$32.10
	85196	Security Screw for black interior RF Window			•			•			\$0.50
	80435	910 Interior Cover Screws			•						\$1.00
	83585	914, 916, 938, 939, 942, 954, and 959 Interior Cover Screws (For use with 85137)	•		•			•			\$1.15
	83137	HC 620 Interior Cover Screws (For use with 83154)	•		•			•			\$1.15

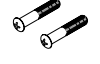
**Misc.
Parts**

	Model	Function	Finish							List Price	
			L03	5	15	15A	26	11P/514	690		NA
	83159	914, 916, 938, 939, 942, and HC620 Mounting Screws & Spindle for 2-1/4" Door Thickness								•	\$5.35
	83651	953, 954 Mounting Screws for 1-3/8" Door Thickness								•	\$5.50
	83653	953, 954 Mounting Screws for 2" Door Thickness								•	\$5.35
	83033	959 Mounting Screws for 2-1/4" Door Thickness								•	\$5.35

Kwikset

www.kwikset.com



[@KwiksetLocks](#)



[@Kwikset](#)



[@Kwikset](#)



[@KwiksetCorp](#)



[@Kwikset](#)