



General Information.....	A1
Ordering Information	A2
■ Functions & Measurements	
Kwikset Signature Series.....	A4
Kwikset	A5
Electronics.....	A6
<hr/>	
■ New Products.....	B7
<hr/>	
■ Kwikset Signature Series	C23
Handlesets	C24-25
Levers	C26-28
Knobs	C29-30
Combo Packs.....	C31
Deadbolts	C32
<hr/>	
■ Kwikset	D33
Handlesets	D34
Levers	D35-36
Knobs	D37-38
Combo Packs.....	D39
Project Packs	D40
Deadbolts	D41
<hr/>	
■ Electronic Locks.....	E43
Deadbolts	E44-45
Home Connect	E46-47
SmartCode 917	E48
Premis.....	E49
<hr/>	
■ Light Commerical	
SmartCode 955	F51
Key Control Deadbolt	F52
<hr/>	
■ Parts & Accessories	
Latches.....	G53
Rekeying Kit & Parts.....	G54
Round Pocket Door Locks & Padlocks	G55
Trims.....	G56



TERMS AND CONDITIONS OF SALE

Standard terms are 2% prompt payment discount for payment within 25 days from date of invoice; net 30 days from the date of invoice. Kwikset® reserves the right to charge and recover on invoices which are not paid within the above terms, a service charge of 1-1/2% a month for each month or fraction thereof during which the invoice remains unpaid, said service charge, however, not to exceed the highest applicable legal rate of interest. All orders, whether solicited or written by our sales representatives or forwarded by our customers are deemed to be mere offers to purchase in accordance with these Terms and Conditions of Sale until actually accepted by us at our home office in Lake Forest, CA. We reserve the right to refuse any order as well as the right to sell or not sell to any firm at our sole discretion. The acceptance of an order is expressly made conditional upon your assent to these Terms and Conditions of Sale. We object to the inclusion of any different or additional terms or conditions, even if the same are included in your order, a contract of sale will result upon the Terms and Conditions of Sale stated herein only. Prices reflected in this book apply to Wholesale customers only.

All sales are final.

PRICES

Pricing based on full-case quantities only; orders for less than full case will be automatically adjusted up to the next full-case quantity. All prices are subject to change without notice and are not guaranteed. All taxes, duties or other charges are the responsibility of the customer.

CLAIMS

Price claims must be submitted in writing to Kwikset, 19701 Da Vinci, Lake Forest, CA 92610 within 30 days from the date of invoice.

CHANGES OR CANCELLATIONS

Beyond 5 working days of our acknowledgement date no changes can be made. Additions to an order will be handled as a separate order and must meet applicable minimum order requirements. Order cancellation on regular stock items only, or any portion thereof is allowed only upon prior written consent from Kwikset, and the payment of cancellation charges deemed appropriate.

MINIMUM CHARGE

No order will be invoiced for less than \$100.00 net plus shipping charges except for lock accessory parts.

MINIMUM ANNUAL SALES VOLUME

The company reserves the right to discontinue direct sales to any customer who does not meet the minimum annual sales volume requirement. The current annual requirement is \$50,000.00. Your annual purchases are determined by accepted, non-cancelled, and shipped orders received during each calendar year. Kwikset reserves the right to change any or all minimum annual sales volume requirements at any time. Any customer who does not meet the annual sales volume requirements may continue to purchase Kwikset products through a Kwikset distributor.

RETURNS

Defective merchandise returned to our factories requires prior written authorization from a Kwikset Sales Rep or the Sales Office. A factory return authorization must accompany the returned shipment. The return authorization must include an itemized listing of the merchandise and an explanation stating the reason for return.

There will be a 20% product restocking fee on all returned merchandise.

FREIGHT

All goods are invoiced FOB to our factory. Upon delivery of shipments to the carrier, title to, and the risk of loss or damage in transit for such shipments, passes to our customer. Kwikset's standard policy is to pay freight charges on all orders over \$1,000.00 net invoice value to a single destination in the continental U.S., by carrier and route of our choice. Shipments less than these quantities will not be shipped on a prepaid basis. If higher freight charges are incurred from customers specifying a carrier or route of their choice the additional cost will be added to that customer's invoice.

DELIVERY CONDITIONS

Shipping schedules are our best estimates, and cannot be guaranteed. Kwikset is not responsible for any direct or consequential loss or damage resulting from an inability or delay in meeting shipping schedules.

KWIKSET LIMITED WARRANTIES

Kwikset products are backed by one of the most comprehensive warranty programs available. You can feel confident that with the purchase of Kwikset you have selected the best quality product, backed by the best customer service available.

MECHANICAL LIMITED WARRANTY

Except as otherwise provided below, Spectrum Brands, Inc., for its Kwikset® brand products ("Kwikset"), warrants to the original residential purchaser (the "Purchaser") that each Kwikset product (the "Product(s)" or "Kwikset Product(s)") will be free from mechanical defects under normal use from the date of purchase for as long as said Purchaser occupies the residential premises upon which the Product was originally installed ("Warranty Period"). This Mechanical Limited Warranty applies only to Products that were purchased from Kwikset or a Kwikset authorized seller, unless otherwise prohibited by law. Kwikset Products are legitimately sold only by authorized sellers who are required to follow Kwikset's policies, procedures, and quality control standards. Kwikset reserves the right to reject warranty claims from purchasers for Products purchased from unauthorized sellers, including unauthorized Internet sites.

FINISH LIMITED WARRANTY

The finish on Kwikset Products is protected by a durable topcoat designed to maintain the beauty and quality of the Kwikset Product. Kwikset warrants to the Purchaser that the finish of the Product shall be free of defects in material and workmanship from tarnishing, flaking, and discoloring from the date of purchase for as long as said Purchaser occupies the residential premises upon which the Product was originally installed ("Warranty Period"). This Finish Limited Warranty applies only to Products that were purchased from Kwikset or a Kwikset authorized seller, unless otherwise prohibited by law. Kwikset Products are legitimately sold only by authorized sellers who are required to follow Kwikset's policies, procedures, and quality control standards. Kwikset reserves the right to reject warranty claims from purchasers for Products purchased from unauthorized sellers, including unauthorized Internet sites.

ELECTRONIC LIMITED WARRANTY

Kwikset warrants to the Purchaser that Kwikset Products will be free from electronic defects under normal use for one (1) year from the date of purchase, as long as said Purchaser occupies the residential premises upon which the Product was originally installed ("Warranty Period"). This Electronic Limited Warranty applies only to Products that were purchased from Kwikset or a Kwikset authorized seller, unless otherwise prohibited by law. Kwikset Products are legitimately sold only by authorized sellers who are required to follow Kwikset's policies, procedures, and quality control standards. Kwikset reserves the right to reject warranty claims from purchasers for Products purchased from unauthorized sellers, including unauthorized Internet sites.

EXCLUSIONS FROM WARRANTY

1. Any Kwikset Product produced prior to January 1, 2006.¹
2. Any Kwikset Product which has been damaged as a result of installation contrary to any of Kwikset's written installation instructions is not covered by these warranties.
3. Any Kwikset Product which has been modified by any non-Kwikset component is not covered by these warranties.
4. Any Kwikset Product having a defect caused by neglect, misuse, abuse or unreasonable or extraordinary use or maintenance, including use in a commercial application, is not covered by these warranties.
5. Any Kwikset Product having a defect due to use of paints, solvents, or other chemicals is not covered by these warranties.
6. Any Kwikset Product that is used in combination with knobs, levers, or trim of other than those manufactured by Kwikset and designated for use with the applicable locks or latches is not covered by these warranties.
7. Any Kwikset Product that was purchased from an unauthorized seller is not covered by these warranties.

These warranties are not transferable. Therefore, no transferee is covered by these warranties.

¹ Kwikset Products produced prior to January 1, 2006, may be eligible for warranty in accordance with the terms and conditions of the applicable warranty program.

WARRANTY CLAIMS

If you wish to make a warranty claim based upon a Product defect, please call us at 1-800-327-LOCK (5625) or contact us at kwikset.com/support.

Please note that you will be required to provide a description of any claimed defect(s) and a dated receipt or other proof of purchase from Kwikset or the Kwikset authorized seller, to verify warranty eligibility.

Certain claimed defect(s) covered by these warranties may be resolved by Kwikset providing you with troubleshooting steps.

Other claimed defect(s) covered by these warranties may require Product replacement. Products may not be returned to Kwikset without prior authorization from Kwikset. If authorized by Kwikset, you will need to mail your Product to:

Spectrum Brands, Inc.

ATTN: Kwikset Consumer Services

19701 Da Vinci

Lake Forest, CA 92610

A prepaid shipping label will be provided to you.

REMEDIES

For certain claimed defect(s) covered by these warranties, as determined by Kwikset, Kwikset will provide you with troubleshooting steps.

For other claimed defect(s) covered by these warranties, as determined by Kwikset, Kwikset will replace the defective Product or part.

If a Kwikset Product, which is the same as the Kwikset Product or any part covered by these warranties, has been discontinued at the time of replacement or if Kwikset determines, in its sole discretion, that such replacement is inappropriate, Kwikset reserves the right to substitute an alternative product. Kwikset also reserves the right to accept or reject an alternative product proposed as a replacement, when the value is higher than that of the Product originally purchased by the Purchaser. Except as expressly provided in these warranties to the contrary, KWIKSET SHALL NOT BE OBLIGATED OR LIABLE FOR LABOR OR OTHER COSTS RELATED TO INSTALLATION, REPAIR OR REPLACEMENT OF A KWIKSET PRODUCT, OR FOR LOSS OF, OR DAMAGE TO ANY MATERIAL WHICH IS NOT SOLD BY KWIKSET.

PATENT INDEMNITY

We agree to defend any suit or proceeding brought against our customer so far as based on claim that our products, or any part thereof, made solely to our specifications and furnished to our customer constitute an infringement of any U.S. patent, if notified promptly in writing and given authority, information and assistance at our expense for the defense of same, and we shall pay all damages and costs awarded therein against our customer. In case our products, or any part thereof, is in such suit held to constitute infringement and their use is enjoined, we will, at our expense and discretion, either procure for our customer the right to continue using the products or replace same with non-infringing products, or modify them so they become non-infringing, or remove such products and refund the purchase price (less depreciation, prorated from the purchase date). The foregoing states our entire liability for patent infringement by our products or any part thereof.

INTELLECTUAL PROPERTY

No person or entity may sell, distribute, advertise, market or promote Kwikset branded products distributed by Kwikset Corporation ("Kwikset"), Spectrum Brands Hardware Home Improvement Division, without prior authorization from Kwikset. Customers of Kwikset who are authorized to sell Kwikset branded products are referred to herein as "Customers."

The Kwikset brand and all Kwikset trademarks, trade names, product depictions, colors, graphics or logos, whether or not registered or otherwise protected (the "Marks"), remain the sole and exclusive property of Kwikset and nothing arising out of the relationship between Kwikset and any Customer conveys to Customer any ownership rights in the Marks. Customer may use the Marks and then only in the sale or promotion of authentic Kwikset products in compliance with the terms of this policy. The Marks must be used exactly in the form provided and in conformity with all Kwikset trademark usage policies or guidelines, including, but not limited to, those relating to shape, color match and imprint quality. Any proposed deviation must be approved in writing by Kwikset prior to use. The Marks may not be used in or as part

of any Customer domain name on the Internet. Prior to any use of the Marks on goods or services, Customer must submit samples for Kwikset's approval.

Additionally, no Customer may use product depictions, graphics, logos or text relating to Kwikset products that have not been provided by Kwikset in connection with the advertising, promotion or sale of Kwikset products without Kwikset's prior review and written approval of each such use. The Marks may not be used in or as part of any reseller or other third party (i) domain name or VRL on the Internet, (ii) trademark or service mark, or (iii) company or trade name. Any action on the part of a Customer that violates the terms of this policy or otherwise impairs the value of or goodwill associated with the Marks or is otherwise not in conformity with Kwikset's standards may result in the suspension or termination of the Customer's authorization or any other remedy permitted by law.

Kwikset grants to each of its Customers limited, non-transferable, non-sublicenseable licenses of the patents relating to the Kwikset products that the Customer is authorized to sell and of the copyrights in any packaging or other written materials included therewith or related thereto. Said patent and copyright licenses are solely to sell such Kwikset products covered by such patents and to which such copyrights relate only to end-users and other Customers in compliance with the terms of this document. The sale of such patented Kwikset products and the sale or use of such copyrighted materials by a Customer that violate the terms of this document exceed the scope of the licenses herein granted to the Customer and may constitute patent and/or copyright infringement.

STANDARDS

Kwikset meets or exceeds the testing requirements specified for each product grade or rating.

- American National Standards Institute (ANSI)
- Builders Hardware Manufacturers Association (BHMA)
- Underwriters Laboratories, Inc. (UL)
- Americans with Disabilities Act (ADA)

MISCELLANEOUS

Substitution of non-Kwikset components/parts, and any alteration or modification of factory parts, and other lock manufacturer's parts may result in door hardware which does not function properly or will fail and will void all warranties. Orders not specified with keying requirements will be shipped Keyed Differently (KD). Orders with keying requirements of K10 or more must have a "Letter of Release" on file with Kwikset stating that Kwikset Corporation will not be held liable for cost and expense arising from any loss or damage to property utilizing Kwikset products where 10 or more locks have been keyed alike. Contact your Sales Office account representative for a copy of the release form. Kwikset reserves the right to revise or modify products, product information, or pricing without notice. Product specifications and pricing reflect available information at the time of printing. Kwikset is not responsible for typographic or printing errors.

LIMITATION OF LIABILITIES

THERE ARE NO WARRANTIES WHICH EXTEND BEYOND THOSE STATED HEREIN. ANY IMPLIED WARRANTIES THAT MAY BE APPLICABLE TO PRODUCTS, INCLUDING IMPLIED WARRANTIES OF MERCHANTABILITY OR FITNESS FOR A PARTICULAR PURPOSE, ARE LIMITED IN DURATION TO THE DURATION OF THIS WARRANTY. SOME STATES DO NOT ALLOW LIMITATIONS ON HOW LONG AN IMPLIED WARRANTY LASTS, SO THE ABOVE LIMITATION MAY NOT APPLY TO YOU. UNDER NO CIRCUMSTANCES SHALL KWIKSET BE LIABLE FOR ANY SPECIAL, INCIDENTAL, OR CONSEQUENTIAL DAMAGES BASED UPON BREACH OF THIS LIMITED WARRANTY, BREACH OF CONTRACT, OR STRICT LIABILITY. SOME STATES DO NOT ALLOW THE EXCLUSION OR LIMITATION OF INCIDENTAL OR CONSEQUENTIAL DAMAGES, SO THE ABOVE LIMITATION OR EXCLUSION MAY NOT APPLY TO YOU. THIS WARRANTY GIVES YOU SPECIFIC LEGAL RIGHTS, AND YOU MAY ALSO HAVE OTHER RIGHTS WHICH VARY FROM STATE TO STATE.

Effective Date: [July 6th 2020]

HANDING

To determine the handing of a door, face the **OUTSIDE** of a door. If the hinge is on the left side of the door, the door is left-handed (LH). If the hinge is on the right side of the door, the door is right-handed (RH).

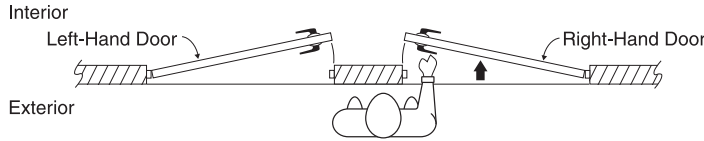

Note: Handing only required for Dummy Kwikset Signature Series levers.

FINISHES

US	Description	BHMA	US	Description	BHMA
L03	Lifetime Polished Brass	605E	26D	Satin Chrome	626
3	Polished Brass	605	514	Matte Black	
5	Antique Brass	609	26	Polished Chrome	
11P	Venetian Bronze	510			
15	Satin Nickel	619			

KEYING

Code	Option
K4, K6	Keyed Alike (4 Locksets, 6 Locksets)

BACKSET

Backset is the length from center edge of door to center of the 2 1/8" (54mm) diameter hole. 2 3/8" or 2 3/4" in most cases.

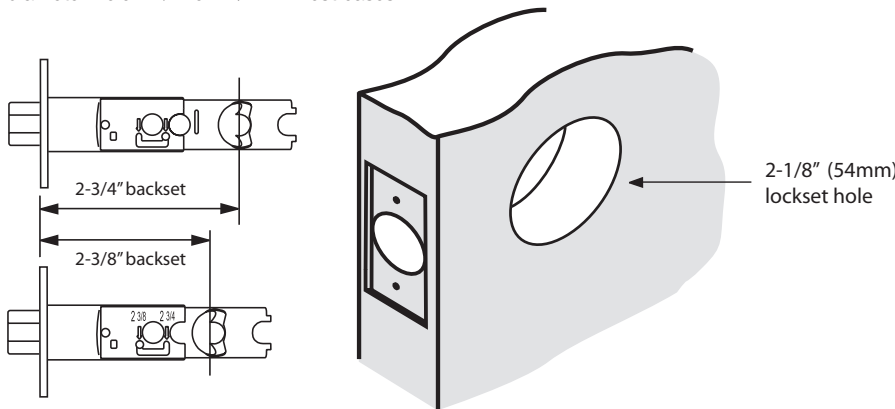

FUNCTIONS

Model	Description	Model	Description
200/720/154	Passage/Hall & Closet	488/788/157	Half Dummy Trim, Surface Mounted
300/730/155	Privacy/Bed & Bath	553/687/800/818	Single Cylinder Handlesets
400/740	Keyed Entry Knob	815	Handle Grip Only
405/740/156	Keyed Entry Lever	801	Double Cylinder Handlesets
		660/816/980/258	Single Cylinder Deadbolts
		665/985	Double Cylinder Deadbolts
		907/909/913/915/925	Electronic Deadbolts
		911	Electronic Levers

KWIKSET SIGNATURE SERIES HANDLESET FUNCTIONS

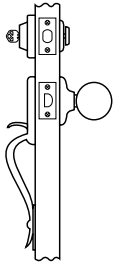

Model
800 / 818

Function
Handleset with Single Cylinder Deadbolt

Description
Latch bolt operated by thumbpiece outside and grip inside. Deadbolt operated by key outside and thumbturn inside.

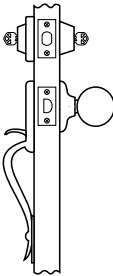

Model
801

Function
Handleset with Double Cylinder Deadbolt

Description
Latch bolt operated by thumb piece outside and grip inside. Deadbolt operated by key both sides.

KWIKSET SIGNATURE SERIES KNOB & LEVER FUNCTIONS

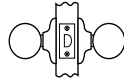

Passage/Hall/Closet: Both knobs always free.
720 F75 / 154

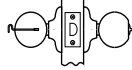

Privacy/Bed/Bath: Both knobs locked or unlocked by turnbutton inside. Outside knob unlocked by emergency key.
730 F76 / 155

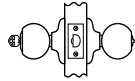

Entry: Both knobs locked or unlocked by key outside or turnbutton inside.
740 F82 / 156



Half Dummy Trim, Surface Mounted: For doors where only a pull is required. No operation.
788 / 157

KWIKSET SIGNATURE SERIES DEADBOLT FUNCTIONS



Single Cylinder: Deadbolt operated by key outside and thumbturn inside.
980 E0151 / 258

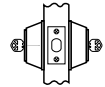

Double Cylinder: Deadbolt operated by key both sides.
985 E0141

Note: ANSI/BHMA functions are listed in italics.

KWIKSET SIGNATURE SERIES HANDLESET FUNCTIONS

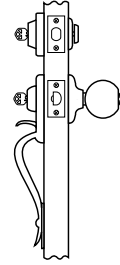

Model
553

Function
Handleset with Single Cylinder Deadbolt

Description
Latch bolt operated by thumb piece outside and grip inside, except when both are locked by key outside or turn button inside. Deadbolt operated by key outside or thumb turn inside.

Kwikset Signature Series Packaging Dimensions									
	Unit Height	Unit Width	Unit Length	Unit Weight	Master Height	Master Width	Master Length	Master Weight	Case Qty
Knobs	9.1	4.6	3.1	1.5	8.4	5.5	13.6	6.5	4
Levers	9.3	6.2	3.2	2.0	9.8	7.1	13.7	8.65	4
Austin Levers	7.6	6.2	3.2	2.7	8.4	7.1	14.3	11.2	4
Contemporary Levers	9.4	6.4	3.1	3.0	9.9	7.2	13.9	12.85	4
Deadbolts	7.8	4.7	4.2	2.5	8.3	5.5	18.2	8.9	4
Knob Combo	9.1	7.9	3.0	3.0	9.6	8.7	13.3	12.8	4
Lever Combo	9.4	9.0	3.0	3.5	9.4	9.0	3.0	14.8	4
Halifax Combo	9.8	3.4	7.7	5.1	10.4	8.5	15.4	20.5	4
992 Combo	8.9	9.0	3.0	3.3	9.2	9.7	13.5	14.0	4
Inactive Knobs	8.7	3.5	3.3	0.3	9.3	4.4	13.3	1.55	4
Inactive Levers	8.7	3.5	3.3	1.0	9.3	4.4	13.3	2.75	4
Handlesets	21.6	8.0	5.5	7.0	11.9	8.6	22.2	15.0	2
Handle Only	16.3	7.3	4.1	4.9	7.9	8.6	16.8	10.4	2

Note: All dimensions in inches. All weights in pounds and based on maximum weights of each function.

KWIKSET HANDLESET FUNCTIONS

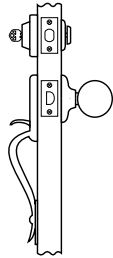

Model

687 Dakota
687 Belleview

Function

Sectional Handleset with Single Cylinder Deadbolt

Description

Latchbolt operated by thumbpiece outside and grip inside.
Deadbolt operated by key outside and thumbturn inside.

KWIKSET KNOB & LEVER FUNCTIONS

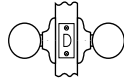

Passage/Hall/Closet: Both knobs always free. **200 F75**

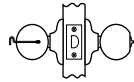

Privacy/Bed/Bath: Both knobs or levers locked or unlocked by turnbutton inside. Outside knob unlocked by emergency key. **300 F76**

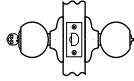

Entry: Both knobs or levers locked or unlocked by key outside or turnbutton inside. **400 F82 - 2 knobs**
405 F82 - 2 levers



Half Dummy Trim, Surface Mounted: For doors where only a pull is required. No operation. **488**

KWIKSET DEADBOLT FUNCTIONS



Single Cylinder: Deadbolt operated by key outside and thumbturn inside. **660/660M E0153**

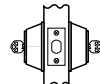

Double Cylinder: Deadbolt operated by key both sides. **665 E0143**



Thumbturn Only: Deadbolt operated by thumbturn one side. No trim on other side. **663 E0193**

Note: ANSI/BHMA functions are listed in italics.

Kwikset Packaging Dimensions										
	Unit Carton Height	Unit Carton Width	Unit Carton Depth	Unit Carton Weight	Master Carton Height	Master Carton Width	Master Carton Depth	Cubic Ft.	Master Carton Weight	Case Count
Knobs	6.5	8	3	1.4	6.875	3.625	8.5	0.581	8.4	6
Levers	6.5	8	3	2.13	6.875	3.625	19.875	1.09	14	6
Deadbolts	6.5	2.906	5.375	1.235	6.688	17.438	6.25	0.422	7.41	6
Combo Packs	10.5	7.875	3.25	2.5	11.4	8.875	18.125	1.061	15	6
Belleview	21.8	8	5.5	4.5	12.5	9	21.625	1.408	9	2
Dakota	21.8	8	5.5	6	12.5	9	21.625	1.408	12	2
Inactive Knobs	8.75	3.5	3.125	0.93	9.313	13.313	4.375	0.314	3.72	4
Inactive Levers	8.75	3	3.5	0.93	9.313	13.313	4.375	0.314	3.72	4

Note: All dimensions in inches. All weights in pounds and based on maximum weights of each function.

ELECTRONIC DEADBOLTS FUNCTIONS

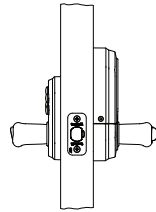
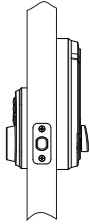

Function

SmartCode™ Deadbolt

Description

Deadbolt operated by key outside or electronic keypad and thumb turn inside.

Kwikset w/ BHMA

N/A

Kwikset Signature Series w/ BHMA

909/913/915/919
E0152

Function

SmartCode™ Lever

Description

Lever operated by key outside or electronic keypad and thumb turn inside.

Kwikset w/ BHMA

N/A

Kwikset Signature Series w/ BHMA

911 F81

Electronic Deadbolts/Levers Packaging Dimensions									
	Quantity	Unit Carton Height	Unit Carton Width	Unit Carton Depth	Unit Carton Weight	Quantity	Master Carton Height	Master Carton Width	Master Carton Depth
905	1	3.5	3.75	8	2	2	4.25	7.5	8.5
907 Powerbolt	1	9.29	3.54	5.51	2.93	2	10.16	7.87	5.75
909 / 910 SmartCode	1	10	3.5	5.5	2.88	2	10.5	6	7.6
911 / 912 SmartCode Lever	1	10	6	3.5	61	2	10.4	12.5	7
913 / 914 SmartCode	1	10	3.5	5.5	2.88	2	10.5	6	7.6
915 / 916 / 919 SmartCode	1	9.88	5.38	3.5	3.14	2	5.94	7.75	10.50
916 / 954	1	4.28	4.0	9.75	3.12	1	4.44	4.63	10.25
Halo Touch	1	9.83	5.4	4.19	3.76	1	10.31	5.63	4.56
Halo Touchscreen	1	9.771	5.313	3.521	3.561	1	3.917	5.688	5.688
Halo Keypad	1	9.834	5.313	3.542	2.413	1	3.917	5.688	10.334

Note: All dimensions in inches. All weights in pounds and based on maximum weights of each function.



Kwikset



**99.9% Cleaner
Than Unprotected Surface**

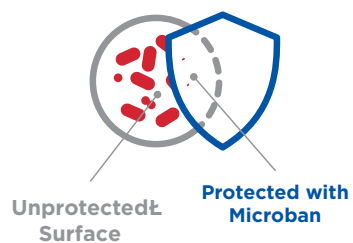

Kwikset® and Microban®, the global leader in built-in antimicrobial protection, have teamed up to improve the standard for door hardware. Kwikset® will now offer antimicrobial protection on select products, inhibiting the growth of bacteria on frequently touched door hardware in your home.

Benefits of Kwikset® Door Hardware with Microban® Technology

Bacteria can double every 20 minutes on unprotected surfaces, but Kwikset Door Hardware with Microban protection works to continuously fight off microbes.

- Door hardware is 99.9% cleaner than knobs without Microban.
- The antimicrobial coating lasts for the lifetime of the hardware finish, so you can worry less and feel more secure in your home.
- 24/7 Antimicrobial product protection.
- Kwikset with Microban protection resists the growth of a broad spectrum of bacteria.

#1 SELLING U.S. LOCK BRAND

*Source: TraQline US quarterly brand unit share report, Q4 2006 through Q1 2022

696532-02/2021

Look for the Microban logo:



Microban is available on select Kwikset® products.



158 SQT



158 RDT



660



660 SQT



660 RDT



780



816 Key Control Deadbolt



816 Key Control Deadbolt SQT



980



Austin



Uptown



Downtown



Abbey



Cameron



Cove



Hancock/Juno



Phoenix



Pismo



Polo



Tylo



Ashfield



Austin



Avalon



Balboa



Brooklane



Commonwelath



Delta



Dorian



Halifax



Ladera



Lido



Lisbon



Milan

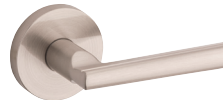

Montreal



Pembroke



Sydney



Tustin



Amador



Arlington



Ashfield



Avalon



Chelsea



Hawthorne



Prescott



San Clemente



Shelburne



Vancouver

Finish availability will vary per product



Polished Brass 3

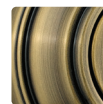

Antique Brass 5



Venetian Bronze 11P



Satin Nickel 15



Antique Nickel 15A



Matte Black 514

Kwikset



Introducing
SAN CLEMENTE

Featuring



**SMARTKEY
SECURITY™**



The San Clemente handleset has a sleek, modern look. With clean lines and a variety of finishes, you can easily upgrade the entry to your home.

- Features New Advanced SmartKey Security™
- Low Profile Contemporary Design
- Handleset Deadbolt has ANSI/BHMA Grade 1 Certified Security
- Lifetime Mechanical and Finish Warranty

#1 SELLING U.S. LOCK BRAND

*Source: TraQline US quarterly brand unit share report, Q4 2006 through Q1 2022

12118-12/2021

Specifications

Door Prep	Cross Bore 2 1/8". Edge Bore 1" Latch Face 1" x 2 1/4"
Backset	Adjustable 2 3/8" or 2 3/4"
Door Thickness	1 3/4" Standard. Thick door service part available for up to 2 1/4"
Faceplates	1" x 2 1/4". Specify square, round, or drive in
Strikes	<ul style="list-style-type: none"> ▪ Deadbolt: 1 1/4" x 3 5/8". Specify square, round, or drive in ▪ Handle: 2 1/4" full lip. Specify square, round, or drive in (Other options available)
Bolt	<ul style="list-style-type: none"> ▪ Deadbolt: 1" throw ▪ Handle: 1/2" throw
Cylinder	SmartKey Security™
Door Handing	Reversible for right or left-hand doors
ANSI/BHMA	Deadbolt is Grade 1 Certified
UL	Optional 20 minute UL fire rating available except for 819 function
ADA	N/A
Warranty	Lifetime mechanical and lifetime finish

Dimensions

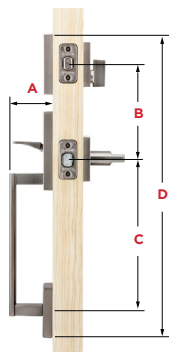

Dimensions	A	B	C	D
San Clemente	2 5/8"	5 1/2"	8 13/32" through 9 1/16"	17 29/32"

Finishes



Satin Nickel 15

Venetian Bronze 11P

Polished Chrome 26

Satin Chrome 26D

Matte Black 514

NEW Adjustable Throughbolt

Vertical and horizontal slide designed for a guaranteed fit

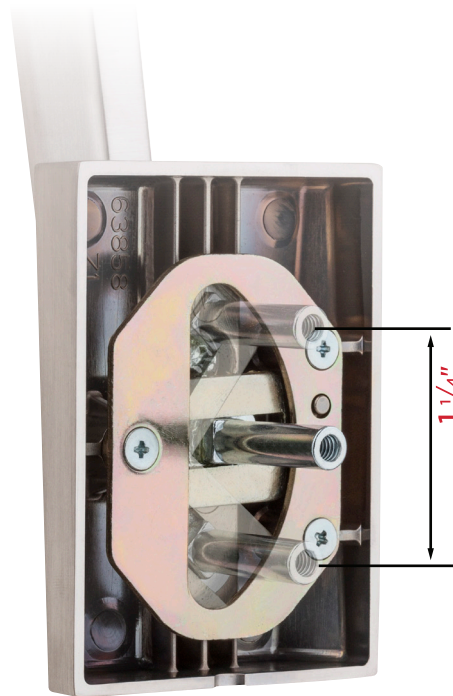

Functions

NEW

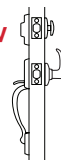

Handleset (Single-Cylinder): Exterior only, Latch bolt operated by thumb piece outside. Deadbolt operated by key outside.
- 818 SCE SMT

NEW

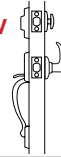

Handleset (Dummy): Exterior only, Handle acts as pull only. For inactive leaf or double doors. No Operation.
- 819 SCE

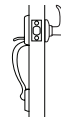

Handle with Lever: Latch bolt operated by thumb piece outside and lever inside. No Deadbolt.
- 815 SCE x HFL
[Available with Halifax (HFL) lever]

NEW



Interior Pack (Single-Cylinder): Interior only, Latch bolt operated by lever inside. Deadbolt operated by thumb turn inside.
- 971___SMT
(Indicate interior lever style)

NEW

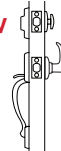

Interior Pack (Dummy): Interior only, Lever acts as a pull only. For inactive leaf or double doors. No operation.
- 973___
(Indicate interior lever style)

No Double-Cylinder Function Available

Kwikset



Introducing
PRESCOTT

Featuring  **SMARTKEY
SECURITY™**



The Prescott handleset has an elegant but modest appearance that will bring charm to any home.

With traditional contours that provide an attractive look and comfortable feel when entering the front door.

- Features SmartKey Security™ Technology
- BHMA Certified Highest Security Deadbolt
- Kwikset with Microban provides 24/7 anti-microbial product protection
- Low Profile Deadbolt Design
- Lifetime Mechanical & Finish Warranty



#1 SELLING U.S. LOCK BRAND

*Source: TraQline US quarterly brand unit share report, Q4 2006 through Q1 2022

579087-06-2020

Specifications

Door Prep	Cross Bore 2 1/8". Edge Bore 1" Latch Face 1" x 2 1/4"
Backset	Adjustable 2 3/8" or 2 3/4"
Door Thickness	1 3/4" Standard. Thick door service part available for up to 2 1/4"
Faceplates	1" x 2 1/4". Square, round and drive-in included
Strikes	▪ Deadbolt: 1 1/8" x 2 3/4" ▪ Handle: 2 1/4" full lip round
Bolt	▪ Deadbolt: 1" throw ▪ Handle: 1/2" throw
Cylinder	SmartKey Security™
Door Handing	Reversible for right or left-hand doors
ANSI/BHMA	Deadbolt - A156.39 Grade AAA Certified
UL	Optional 20 minute UL fire rating available except for 819 function
ADA	N/A
Warranty	Lifetime mechanical and lifetime finish

Dimensions

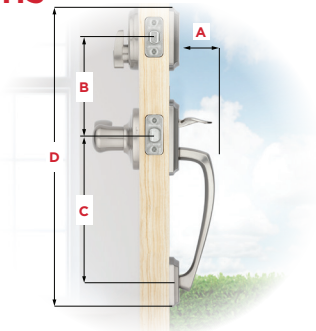

Dimensions	A	B	C	D
Prescott	2 25/32"	5 1/2"	8 13/32" through 9 11/16"	17 3/4"

Finishes



L03
Lifetime
Polished
Brass



15
Satin
Nickel



11P
Venetian
Bronze



514
Matte
Black

NEW Adjustable Throughbolt

Vertical and horizontal slide designed for a guaranteed fit

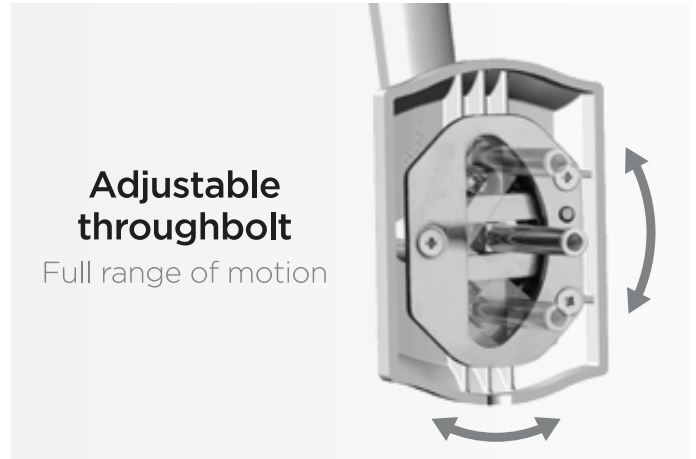

Adjustable throughbolt

Full range of motion

Functions



Handleset (Single-Cylinder)

Latch bolt operated by thumb piece outside and lever inside. Deadbolt operated by key outside and thumb turn inside.

- 818 SMT



Handleset (Dummy)

Handle and lever act as a pull only. For inactive leaf or double doors. No operation.

- 819



Handle Only, LIP

Exterior handle only. No Interior. Pair with 971 or 966 Interior Pack

- 814



Handleset with Interior, no Deadbolt

Latch bolt operated by thumb piece outside and lever/knob inside.

- 815

Kwikset

Introducing

VANCOUVER

Featuring



SMARTKEY
SECURITY™



The Vancouver handleset has a clean, low profile design. With this sleek contemporary style, you make a bold statement right at the front door.

- Features New Advance SmartKey Security™
- Features Microban® antimicrobial finish protection*
- Certified Highest Security Deadbolt
- Lifetime Mechanical and Finish Warranty
- Adjustable Throughbolt for Guaranteed Fit

* Microban® available in the following finishes:
Satin Nickel (15), Venetian Bronze (11p), and Iron Black (514)

#1 SELLING U.S. LOCK BRAND

*Source: TraQline US quarterly brand unit share report, Q4 2006 through Q1 2022

386117-04/2019

Specifications

Door Prep	Cross Bore 2 1/8" . Edge Bore 1" Latch Face 1" x 2 1/4" Deadbolt & Handle bore holes must be 5 1/2" apart
Backset	Adjustable 2 3/8" or 2 3/4"
Door Thickness	1 3/4" Standard. Thick door service part available for up to 2 1/4"
Faceplates	1" x 2 1/4". Square, round and drive-in included
Strikes	<ul style="list-style-type: none"> ▪ Deadbolt: 1 1/8" x 2 3/4" & 2 1/4" full lip (non-graded) ▪ Handle: 2 1/4" full lip round
Bolt	<ul style="list-style-type: none"> ▪ Deadbolt: 1" throw ▪ Handle: 1/2" throw
Cylinder	SmartKey Security™
Door Handing	Reversible for right or left-hand doors
ANSI/BHMA	Deadbolt – A156.39 Grade AAA Certified
UL	N/A
ADA	N/A
Warranty	Lifetime mechanical and lifetime finish

Dimensions

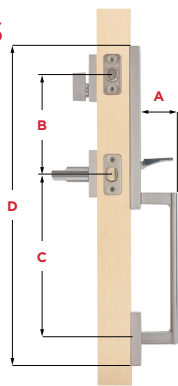

Dimensions	A	B	C	D
Vancouver	2 21/32"	5 1/2"	8 13/32" through 9 11/16"	17 15/16"

Finishes

MICROBAN



Satin Nickel 15



Venetian Bronze 11P



Matte Black 514



Polished Chrome 26

Interior Options



Halifax Square Full Interior
(HFL SQF)



Sectional Interiors
(Other options available)

Functions



Handleset (Single-Cylinder): Latch bolt operated by thumb piece outside and lever inside. Deadbolt operated by key outside and thumb turn inside
- 818 VNH SMT



Handleset (Dummy): Handle and lever act as a pull only. For inactive leaf or double doors. No operation.
- 819 VNH



Interior Pack (Single-Cylinder): Latch bolt operated by thumb piece outside and lever inside. Deadbolt operated by key outside and thumb turn inside.
- 971HFL SQF
(Halifax Only)



Interior Pack (Dummy): Lever acts as a pull only. For inactive leaf or double doors. No operation.
- 973HFL SQFz
(Halifax Only)



Superior Security Features

- ANSI/BHMA Grade 1 Certified 258/980/985 Deadbolt
- SmartKey Security™ to Protect Against Lock Bumping

Elegant Styles And Finishes

- Broad Array of Finishes
- Traditional to Contemporary Styles

Warranty

- Limited Mechanical
- Limited Finish

*Lock Bumping - an attack technique using specially cut keys that can defeat conventional pin & tumbler locks.



Arlington™



Ashfield™



Austin™



Avalon™



Chelsea™



Hawthorne™



Montara™



Prague



Prescott



Prescott



San Clemente™



San Clemente™



Shelburne™



Vancouver

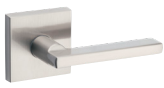

Halifax™



Lido™



Milan™



Singapore



Tustin™



Cameron™



Juno™



Pismo™



Austin Deadbolt



Uptown



Downtown



980/985 Deadbolt



MFG Pro#	Function	Finish								Case Qty.	Price
San Clemente™ Handleset		3	L03	5	11P	15	26	26D	514		
98180-001	818SCEXHFL SQT San Clemente x Halifax SQT				•					2	\$328.30
98180-002	818SCEXHFL SQT San Clemente x Halifax SQT					•				2	\$328.30
98180-020	818SCEXHFL SQT - San Clemente X Halifax SQT							•		2	\$328.30
98150-011	815SCEXHFL SQT San Clemente Handle Only x Halifax SQT							•		2	\$231.00
98150-012	815SCEXHFL SQT San Clemente Handle Only x Halifax SQT					•				2	\$220.70
Montara™ Handleset		3	L03	5	11P	15	26	26D	514		
95530-017	553MNXJ Montara x Juno		•							2	\$293.90
95530-018	553MNXJ Montara x Juno					•				2	\$304.60
95530-019	553MNXJ Montara x Juno				•					2	\$304.60
Ashfield™ Handleset		3	L03	5	11P	15	26	26D	514		
98001-098	800ADHXADL Ashfield x Ashfield				•					2	\$313.30
Austin™ Handleset		3	L03	5	11P	15	26	26D	514		
98001-379	800AUH X AUL Austin x Austin				•					2	\$293.30
Avalon™ Handleset		3	L03	5	11P	15	26	26D	514		
98150-001	815AVHxTNL Avalon Handle Only x Tustin				•					2	\$220.70
98150-002	815AVHxTNL Avalon Handle Only x Tustin					•				2	\$220.70
Vancouver Handleset		3	L03	5	11P	15	26	26D	514		
98180-014	818VNHXHFL SQT 15 SMT CP					•				2	\$339.10
98180-015	818VNHXHFL SQT 514 SMT CP							•		2	\$339.10
Prescott Handleset		3	L03	5	11P	15	26	26D	514		
98150-013	815PTHXTNL 15 RBP Handle Only					•				2	\$220.70
98150-014	815PTHXTNL 11P RBP Handle Only				•					2	\$220.70
98180-021	818PTHXTNL 15 SMT CP					•				2	\$293.90
98180-022	818PTHXTNL 11P SMT CP				•					2	\$293.90
Prague Handleset		3	L03	5	11P	15	26	26D	514		
98180-025	818PGHXPSK RDT Prague x Pismo RDT 15					•				2	\$304.60
98180-026	818PGHXPSK RDT Prague x Pismo RDT 514							•		2	\$304.60



HANDLESETS - all keyed handlesets below have SmartKey only								
<i>MFG Pro#</i>	<i>Function</i>	<i>Finish</i>					<i>Case Qty.</i>	<i>Price</i>
Hawthorne™ Handleset		3	L03	5	11P	15		
98001-104	800HEXJ - Hawthorne x Juno				•		2	\$286.90
Shelburne™ Handleset		3	L03	5	11P	15		
98001-134	800SEXLL - Shelburne x Lido			•			2	\$278.80
98001-133	800SEXLL - Shelburne x Lido				•		2	\$293.90
98001-107	800SXTNL - Shelburne x Tustin					•	2	\$293.90
Arlington® Handleset		3	L03	5	11P	15		
98001-094	800ANXLL - Arlington X Lido					•	2	\$249.80
98001-095	800ANXLL - Arlington X Lido			•			2	\$216.90
98001-096	800ANXLL - Arlington X Lido	•					2	\$228.20
98001-097	800ANXTNL - Arlington X Tustin				•		2	\$260.00
98001-123	800ANXLL - Arlington X Lido				•		2	\$260.00
Chelsea® Handleset		3	L03	5	11P	15		
98001-196	800CEXJ - Chelsea x Juno		•				2	\$181.40
98001-126	800CEXLL - Chelsea x Lido Lever		•				2	\$228.20
98001-124	800CEXCN - Chelsea x Cameron					•	2	\$218.60
98001-369	800CEXJ - Chelsea x Juno					•	2	\$218.60

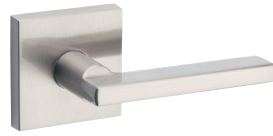

HALIFAX®



MILAN®

LEVERS - all keyed levers below have SmartKey only												
<i>MFG Pro#</i>	<i>Function</i>	<i>Finish</i>								<i>Case Qty.</i>	<i>Keying</i>	<i>Price</i>
Halifax® Reversible Lever		3	L03	5	11P	15	26	26D	514			
97200-854	720HFL SQT - Hall/Closet					•				4		\$51.70
97300-896	730HFL SQT - Bed/Bath					•				4		\$60.30
97402-812	740HFL SQT - Keyed Entry					•				4	K4	\$101.20
97880-902	788HFL SQT - Inactive					•				4		\$26.40
97200-853	720HFL SQT - Hall/Closet				•					4		\$51.70
97300-895	730HFL SQT - Bed/Bath				•					4		\$60.30
97402-811	740HFL SQT - Keyed Entry				•					4	K4	\$101.20
97880-949	788HFL SQT - Inactive								•	4		\$26.40
97402-920	740HFL SQT - Keyed Entry								•	4	K4	\$101.20
97300-949	730HFL SQT - Bed/Bath								•	4		\$60.30
97200-906	720HFL SQT - Hall/Closet								•	4		\$51.70
Milan® Reversible Lever		3	L03	5	11P	15	26	26D	514			
97200-857	720MIL RDT 15 CP					•				4		\$51.70
97300-899	730MIL RDT 15 CP					•				4		\$60.30
97402-815	740MIL RDT 15 SMT CP K4					•				4	K4	\$101.20
97200-856	720MIL RDT 11P CP				•					4		\$51.70
97300-898	730MIL RDT 11P CP				•					4		\$60.30
97402-916	740MIL RDT 11P CP				•					4	K4	\$101.20
97880-904	788MIL RDT 11P CP				•					4		\$26.40

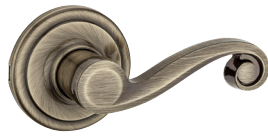

LIDO®



SINGAPORE



TUSTIN®

LEVERS - all keyed levers below have SmartKey only

MFG Pro#	Function	Finish								Case Qty.	Keying	Price
		3	L03	5	11P	15	26	26D	514			
Lido® Reversible Lever		3	L03	5	11P	15	26	26D	514			
97200-780	720LL - Hall/Closet	•								4		\$39.80
97300-820	730LL - Bed/Bath	•								4		\$42.00
97402-728	740LL - Keyed Entry	•								4	K4	\$74.80
97880-682	788LL LH - Inactive	•								4		\$17.80
97880-683	788LL RH - Inactive	•								4		\$17.80
97200-782	720LL - Hall/Closet			•						4		\$40.90
97300-822	730LL - Bed/Bath			•						4		\$43.60
97402-729	740LL - Keyed Entry			•						4	K4	\$75.90
97880-686	788LL LH - Inactive			•						4		\$18.80
97880-687	788LL RH - Inactive			•						4		\$18.80
97200-793	720LL - Hall/Closet				•					4		\$54.40
97300-833	730LL - Bed/Bath				•					4		\$58.70
97402-740	740LL - Keyed Entry				•					4	K4	\$91.50
97880-688	788LL LH - Inactive				•					4		\$23.20
97880-689	788LL RH - Inactive				•					4		\$23.20
97200-781	720LL - Hall/Closet					•				4		\$45.70
97300-821	730LL - Bed/Bath					•				4		\$48.50
97402-730	740LL - Keyed Entry					•				4	K4	\$85.00
97880-680	788LL LH - Inactive					•				4		\$20.40
97880-681	788LL RH - Inactive					•				4		\$20.40
Tustin® Reversible Lever		3	L03	5	11P	15	26	26D	514			
97200-778	720TNL - Hall/Closet				•					4		\$54.40
97300-818	730TNL - Bed/Bath				•					4		\$58.70
97402-733	740TNL - Keyed Entry				•					4	K4	\$91.50
97880-678	788TNL LH - Inactive				•					4		\$23.20
97880-679	788TNL RH - Inactive				•					4		\$23.20
97200-777	720TNL - Hall/Closet					•				4		\$45.70
97300-817	730TNL - Bed/Bath					•				4		\$48.50
97402-732	740TNL - Keyed Entry					•				4	K4	\$85.00
97880-673	788TNL LH - Inactive					•				4		\$20.40
97880-676	788TNL RH - Inactive					•				4		\$20.40
Singapore Lever		3	L03	5	11P	15	26	26D	514			
97200-898	720SAL 15 SQT CP					•				4		\$51.70
97300-941	730SAL 15 SQT CP					•				4		\$60.30
97402-911	740SAL 15 SQT SMT CP K4					•				4	K4	\$101.20
97200-899	720SAL 514 SQT CP							•		4		\$51.70
97300-942	730SAL 514 SQT CP							•		4		\$60.30
97402-912	740SAL 514 SQT SMT CP K4							•		4	K4	\$101.20



PISMO®



CAMERON®

KNOBS - all keyed levers below have SmartKey only											
MFG Pro#	Function	Finish							Case Qty.	Keying	Price
Pismo® Knob		3	L03	5	11P	15	26	514			
97200-888	720PSK - Hall/Closet					•			4		\$46.30
97300-931	730PSK - Bed/Bath					•			4		\$47.40
97402-850	740PSK - Entry					•			4	K4	\$68.90
97880-934	788PSK - Inactive					•			4		\$23.70
97200-887	720PSK - Hall/Closet							•	4		\$46.30
97300-930	730PSK - Bed/Bath							•	4		\$47.40
97402-849	740PSK - Entry							•	4	K4	\$68.90
97880-933	788PSK - Inactive							•	4		\$23.70

KNOBS - all keyed levers below have SmartKey only											
MFG Pro#	Function	Finish							Case Qty.	Keying	Price
Cameron® Knob		3	L03	5	11P	15	26	26D			
97200-795	720CN - Hall/Closet	•							4		\$24.80
97300-835	730CN - Bed/Bath	•							4		\$26.90
97402-742	740CN - Entry	•							4	K4	\$47.40
97200-794	720CN - Hall/Closet					•			4		\$28.50
97300-834	730CN - Bed/Bath					•			4		\$31.20
97402-741	740CN - Entry					•			4	K4	\$53.80
97880-715	788CN - Inactive					•			4		\$14.00



JUNO®

KNOBES - all keyed levers below have SmartKey only											
<i>MFG Pro#</i>	<i>Function</i>	<i>Finish</i>							<i>Case Qty.</i>	<i>Keying</i>	<i>Price</i>
Juno® Knob		3	L03	5	11P	15	26	26D			
97200-787	720J - Hall/Closet	•							4		\$25.80
97300-827	730J - Bed/Bath	•							4		\$28.50
97402-734	740J - Entry	•							4	K4	\$46.80
97880-666	788J - Inactive	•							4		\$13.40
97200-788	720J - Hall/Closet			•					4		\$27.40
97300-828	730J - Bed/Bath			•					4		\$31.20
97402-735	740J - Entry			•					4	K4	\$49.50
97200-790	720J - Hall/Closet				•				4		\$38.70
97300-830	730J - Bed/Bath				•				4		\$39.80
97402-737	740J - Entry				•				4	K4	\$54.40
97880-669	788J - Inactive				•				4		\$16.70
97200-789	720J - Hall/Closet					•			4		\$29.60
97300-829	730J - Bed/Bath					•			4		\$32.80
97402-736	740J - Entry					•			4	K4	\$52.70
97880-668	788J - Inactive					•			4		\$15.00



JUNO®
COMBO PACK



LIDO®
COMBO PACK



TUSTIN®
COMBO PACK



CAMERON®
COMBO PACK



HALIFAX®
COMBO PACK

COMBO PACKS - all keyed levers below have SmartKey only										
MFG Pro#	Function	Finish						Case Qty.	Keying	Price
991 Combo Pack - Cameron® Knob with Single Cylinder Deadbolt										
99910-045	991CN - Single Cylinder	•						4	K4	\$90.90
99910-044	991CN - Single Cylinder					•		4	K4	\$102.80
991 Combo Pack - Lido® Lever with Single Cylinder Deadbolt										
99910-039	991LL - Single Cylinder	•						4	K4	\$119.00
99910-047	991LL - Single Cylinder				•			4	K4	\$141.60
99910-038	991LL - Single Cylinder					•		4	K4	\$134.00
991 Combo Pack - Tustin® Lever with Single Cylinder Deadbolt										
99910-040	991TNL - Single Cylinder					•		4	K4	\$134.00
99910-041	991TNL - Single Cylinder				•			4	K4	\$141.60
991 Combo Pack - Juno® Knob with Single Cylinder Deadbolt										
99910-032	991J - Single Cylinder	•						4	K4	\$96.40
99910-033	991J - Single Cylinder			•				4	K4	\$77.50
99910-035	991J - Single Cylinder				•			4	K4	\$121.60
99910-034	991J - Single Cylinder					•		4	K4	\$116.80
992 Combo Pack - Juno® Knob with Double Cylinder Deadbolt										
99920-006	992J - Double Cylinder					•		4	K4	\$127.60
99920-007	992J - Double Cylinder				•			4	K4	\$129.20
991 Combo Pack Halifax Lever with Halifax Single Cylinder Deadbolt										
99910-062	991HFL SQT - Single Cylinder					•		4	K4	\$143.70
99910-063	991HFL SQT - Single Cylinder				•			4	K4	\$143.70
99910-064	991HFL SQT - Single Cylinder						•	4	K4	\$143.70



980
DEADBOLT



985
DEADBOLT



AUSTIN
DEADBOLT



UPTOWN



DOWNTOWN

DEADBOLTS - all keyed levers below have SmartKey only									
MFG Pro#	Function	Finish					Case Qty.	Keying	Price
Single Cylinder Deadbolt		3	L03	5	11P	15			
99800-120	980 - Single Cylinder	•					4	K4	\$58.10
99800-121	980 - Single Cylinder			•			4	K4	\$63.50
99800-122	980 - Single Cylinder				•		4	K4	\$67.30
99800-123	980 - Single Cylinder					•	4	K4	\$64.00
Double Cylinder Deadbolt		3	L03	5	11P	15			
99850-071	985 - Double Cylinder	•					4	K4	\$78.00
99850-073	985 - Double Cylinder				•		4	K4	\$93.70
99850-074	985 - Double Cylinder					•	4	K4	\$89.40

MFG Pro#	Function	Finish					Case Qty.	Keying	Price
Austin Single Cylinder Deadbolt		3	L03	5	11P	15			
99800-125	980 AUD SMT - Single Cylinder				•		4	K4	\$70.00

DEADBOLTS - all keyed levers below have SmartKey only											
MFG Pro#	Function	Finish							Case Qty.	Keying	Price
Uptown Deadbolt		3	L03	5	11P	15	26	514			
92580-016	258 RDT - Single Cylinder					•			4	K4	\$70.60
92580-020	258 RDT - Single Cylinder							•	4	K4	\$70.60
Downtown Deadbolt		3	L03	5	11P	15	26				
92580-018	258 SQT - Single Cylinder					•			4	K4	\$71.60
92580-019	258 SQT - Single Cylinder				•				4	K4	\$71.60
92580-022	258 SQT - Single Cylinder							•	4	K4	\$71.60



Trusted Security



- ANSI/BHMA Grade 3
- Easy Installation
- Handlesets Now Feature SmartKey Security™ to Protect Against Lock Bumping
- Most Recognized Style

Warranty

- Limited Mechanical
- Limited Finish

*Lock Bumping - an attack technique using specially cut keys that can defeat conventional pin & tumbler locks.



660 RDT Contemporary



660/665 Deadbolt



Balboa®



Amador



Belleview™



Dakota™



Ladera



Cove™



Delta*



Polo*



Dorian*



Tylo*



Amador

BELLEVUE™

DAKOTA™

HANDLESETS - all keyed levers below have SmartKey only											
<i>MFG Pro#</i>	<i>Function</i>	<i>Finish</i>								<i>Case Qty.</i>	<i>Price</i>
Amador Handleset		3	L03	5	11P	15	26D	26	514		
96870-151	687AMDXLRL RDT 15 SMT CP					•				2	\$165.50
Bellevue™ Handleset		3	L03	5	11P	15	26D				
96870-098	687BWXT - Bellevue x Tylo x SMT			•						2	\$139.90
96870-100	687BWXC - Bellevue x Cove SMT				•					2	\$145.30
96870-099	687BWXP - Bellevue x Polo SMT					•				2	\$145.30
Dakota™ Handleset		3	L03	5	11P	15	26D				
96870-088	687DAXP - Dakota x Polo SMT	•								2	\$134.60
96870-091	687DAXT - Dakota x Tylo SMT	•								2	\$134.60
96870-087	687DAXT - Dakota x Tylo SMT			•						2	\$139.90
96870-090	687DAXP - Dakota x Polo SMT					•				2	\$145.30



BALBOA



DELTA®



DORIAN®



LADERA®

LEVERS												
MFG Pro#	Function	Finish								Case Qty.	Keying	Price
Balboa Lever		3	L03	5	11P	15	26	26D	514			
92001-526	200BL - Hall/Closet				•					6		\$38.70
93001-883	300BL - Bed/Bath				•					6		\$40.90
94050-550	405BL - Entry				•					6	K6	\$64.60
94880-518	488BL LH - Inactive				•					4		\$17.30
94880-519	488BL RH - Inactive				•					4		\$17.30
92001-525	200BL - Hall/Closet					•				6		\$36.60
93001-882	300BL - Bed/Bath					•				6		\$38.70
94050-549	405BL - Entry					•				6	K6	\$62.40
94880-495	488BL LH - Inactive					•				4		\$16.20
94880-496	488BL RH - Inactive					•				4		\$16.20
Delta® Lever		3	L03	5	11P	15	26	26D	514			
92001-522	200DL - Hall/Closet							•		6		\$35.50
93001-879	300DL - Bed/Bath							•		6		\$37.70
94050-546	405DL - Entry							•		6	K6	\$57.70
94880-435	488DL - Inactive							•		4		\$15.50
Dorian® Lever		3	L03	5	11P	15	26	26D	514			
92001-523	200DNL - Hall/Closet	•								6		\$33.40
93001-880	300DNL - Bed/Bath	•								6		\$35.40
94050-547	405DNL - Entry	•								6	K6	\$55.20
92001-524	200DNL - Hall/Closet					•				6		\$35.50
93001-881	300DNL - Bed/Bath					•				6		\$37.70
94050-548	405DNL - Entry					•				6	K6	\$57.70
Ladera® Lever		3	L03	5	11P	15	26	26D	514			
92001-578	200LRL RDT - Hall/Closet					•				6		\$38.70
93001-973	300LRL RDT - Bed/Bath					•				6		\$40.90
94880-580	488LRL RDT LH - Inactive					•				4		\$17.30
94880-581	488LRL RDT RH - Inactive					•				4		\$17.30
94050-615	405LRL RDT - SMT Keyed Entry					•				4	K6	\$64.60
92001-587	200LRL RDT - Hall/Closet								•	6		\$41.80
93002-015	300LRL RDT - Bed/Bath								•	6		\$44.00
94050-616	405LRL RDT - RDT SMT Keyed Entry								•	6	K6	\$67.70
94880-597	488LRL RDT - Inactive LH								•	4		\$19.30
94880-598	488LRL RDT - Inactive RH								•	4		\$19.30



COVE™



POLO®

KNOBS											
<i>MFG Pro#</i>	<i>Function</i>	<i>Finish</i>							<i>Case Qty.</i>	<i>Keying</i>	<i>Price</i>
Cove™ Knob		3	L03	5	11P	15	26	26D			
92001-511	200CV - Hall/Closet				•				6		\$24.40
93001-868	300CV - Bed/Bath				•				6		\$25.90
94002-823	400CV - Entry				•				6	K6	\$32.10
94880-488	488CV - Inactive				•				4		\$11.40
92001-509	200CV - Hall/Closet					•			6		\$22.20
93001-866	300CV - Bed/Bath					•			6		\$23.80
94002-821	400CV - Entry					•			6	K6	\$30.00
94880-490	488CV - Inactive					•			4		\$10.40
Polo® Knob		3	L03	5	11P	15	26	26D			
92001-516	200P - Hall/Closet	•							6		\$18.40
93001-873	300P - Bed/Bath	•							6		\$20.20
94002-831	400P - Entry	•							6	K6	\$27.00
94880-367	488P - Inactive	•							4		\$8.30
92001-510	200P - Hall/Closet				•				6		\$21.70
93001-867	300P - Bed/Bath				•				6		\$23.70
94002-822	400P - Entry				•				6	K6	\$30.10
94880-489	488P - Inactive				•				4		\$10.80
92001-518	200P - Hall/Closet					•			6		\$20.70
93001-875	300P - Bed/Bath					•			6		\$22.50
94002-826	400P - Entry					•			6	K6	\$28.80
94880-399	488P - Inactive					•			4		\$10.20
92001-517	200P - Hall/Closet							•	6		\$18.70
93001-874	300P - Bed/Bath							•	6		\$20.80
94002-832	400P - Entry							•	6	K6	\$27.40
94880-369	488P - Inactive							•	4		\$8.50



TYLO®



MOBILE HOME LOCKS

KNOBS											
<i>MFG Pro#</i>	<i>Function</i>	<i>Finish</i>							<i>Case Qty.</i>	<i>Keying</i>	<i>Price</i>
Tylo® Knobs		3	L03	5	11P	15	26	26D			
92001-513	200T - Hall/Closet	•							6		\$16.20
93001-870	300T - Bed/Bath	•							6		\$18.00
94002-828	400T - Keyed Entry	•							6	K6	\$23.50
94880-363	488T - Inactive	•							4		\$7.40
92001-512	200T - Hall/Closet			•					6		\$18.10
93001-869	300T - Bed/Bath			•					6		\$19.60
94002-827	400T - Keyed Entry			•					6	K6	\$26.30
94880-364	488T - Inactive			•					4		\$8.50
92001-508	200T - Hall/Closet					•			6		\$18.30
93001-865	300T - Bed/Bath					•			6		\$20.40
94002-820	400T - Keyed Entry					•			6	K6	\$26.90
94880-520	488T - Inactive					•			4		\$9.20
92001-514	200T - Hall/Closet							•	6		\$16.50
93001-871	300T - Bed/Bath							•	6		\$18.20
94002-829	400T - Keyed Entry							•	6	K6	\$25.20
94880-365	488T - Inactive							•	4		\$7.50
<i>MFG Pro#</i>	<i>Function</i>	<i>Finish</i>							<i>Case Qty.</i>	<i>Keying</i>	<i>Price</i>
Mobile Home Locks		3	L03	5	11P	15	26	26D	<i>Case Qty.</i>	<i>Keying</i>	<i>Price</i>
92001-519	200M - Hall/Closet	•							6		\$15.10
93001-876	300M - Bed/Bath	•							6		\$16.70
94002-825	400M - Entry	•							6	K6	\$22.80
92001-520	200M - Hall/Closet							•	6		\$15.30
93001-877	300M - Bed/Bath							•	6		\$17.00
94002-824	400M - Entry							•	6	K6	\$23.20



COMBO PACK ENTRY KNOB/LEVER WITH DEADBOLT

COMBO PACKS - all combo packs include 660 or 665 deadbolt & keyed entry									
MFG Pro#	Function	Finish					Case Qty.	Keying	Price
690 Combo Pack - Cove™ Knob with Single Cylinder Deadbolt		3	5	11P	15	26D			
96900-332	690CV - Single Cylinder			•			6	K6	\$60.30
96900-366	690CV - Single Cylinder				•		6	K6	\$60.30
690 Combo Pack - Polo® Knob with Single Cylinder Deadbolt		3	5	11P	15	26D			
96900-250	690P - Single Cylinder	•					6	K6	\$55.60
96900-251	690P - Single Cylinder		•				6	K6	\$59.90
96900-333	690P - Single Cylinder			•			6	K6	\$57.80
96900-320	690P - Single Cylinder				•		6	K6	\$57.80
690 Combo Pack - Tylo® Knob with Single Cylinder Deadbolt		3	5	11P	15	26D			
96900-252	690T - Single Cylinder					•	6	K6	\$54.40
96900-253	690T - Single Cylinder	•					6	K6	\$51.00
96900-254	690T - Single Cylinder		•				6	K6	\$57.40
96900-376	690T - Single Cylinder				•		6	K6	\$56.00
690 Combo Pack - Balboa™ Lever with Single Cylinder Deadbolt		3	5	11P	15	26D			
96900-365	690BL - Single Cylinder			•			6	K6	\$89.40
96900-353	690BL - Single Cylinder				•		6	K6	\$89.40
690 Combo Pack - Delta® Lever with Single Cylinder Deadbolt		3	5	11P	15	26D			
96900-312	690DL - Single Cylinder					•	6	K6	\$83.50
695 Combo Pack - Tylo® Knob with Double Cylinder Deadbolt		3	5	11P	15	26D			
96950-163	695T - Double Cylinder	•					6	K6	\$60.90
96950-164	695T - Double Cylinder		•				6	K6	\$65.30
96950-162	695T - Double Cylinder					•	6	K6	\$61.90



242 PROJECT PACK



243 PROJECT PACK

PROJECT PACKS - all 242 project packs include 660 deadbolt & keyed entry									
<i>MFG Pro#</i>	<i>Function</i>	<i>Finish</i>					<i>Case Qty.</i>	<i>Keying</i>	<i>Price</i>
Project Pack - 2 Keyed Tylo® Knobs with 2 Single Cylinder Deadbolts		3	5	11P	15	26D			
92420-031	242T - 2 Keyed Knobs with 2 Single Cylinder Deadbolts	•					6	K2	\$106.00
92420-032	242T - 2 Keyed Knobs with 2 Single Cylinder Deadbolts		•				6	K2	\$114.60
92420-036	242T - 2 Keyed Knobs with 2 Single Cylinder Deadbolts					•	6	K2	\$108.70
92420-051	242T - 2 Keyed Knobs with 2 Single Cylinder Deadbolts				•		6	K2	\$112.00
Project Pack - 2 Keyed Tylo® Knobs		3	5	11P	15	26D			
92430-022	243T - 2 Keyed Knobs	•					6	K2	\$49.00
92430-035	243T - 2 Keyed Knobs					•	6	K2	\$49.70
Project Pack - 2 Keyed Cove Knobs with 2 Single Cylinder Deadbolts		3	5	11P	15	26D			
92420-045	242CV - 2 Keyed Knobs with 2 Single Cylinder Deadbolts			•			6	K2	\$114.60
92420-058	242CV - 2 Keyed Knobs with 2 Single Cylinder Deadbolts				•		6	K2	\$112.90



660 SINGLE CYLINDER



663 ONE SIDED DEADBOLT



665 DOUBLE CYLINDER



660 RDT CONTEMPORARY

DEADBOLTS										
MFG Pro#	Function	Finish						Case Qty.	Keying	Price
Single Cylinder Deadbolt		3	5	11P	15	26D	514			
96600-675	660 - Single Cylinder	•						6	K6	\$26.60
96600-674	660 - Single Cylinder		•					6	K6	\$28.80
96600-673	660 - Single Cylinder			•				6	K6	\$30.10
96600-669	660 - Single Cylinder				•			6	K6	\$28.80
96600-676	660 - Single Cylinder					•		6	K6	\$27.10
One-Sided Deadbolt		3	5	11P	15	26D	514	Case Qty.	Keying	
96630-059	663 - One Sided Deadbolt - RCL RCS	•						4		\$12.70
96630-061	663 - One Sided Deadbolt - RCL RCS		•					4		\$13.50
96630-065	663 - One Sided Deadbolt RCL RCS				•			4		\$12.50
Double Cylinder Deadbolt		3	5	11P	15	26D	514	Case Qty.	Keying	
96650-494	665 - Double Cylinder	•						6	K6	\$34.10
96650-493	665 - Double Cylinder		•					6	K6	\$36.40
96650-492	665 - Double Cylinder				•			6	K6	\$36.40
96650-495	665 - Double Cylinder					•		6	K6	\$34.90
Mobile Home Locks		3	5	11P	15	26D	514	Case Qty.	Keying	
96600-668	660M - Mobile Home	•						6	K6	\$25.10
96600-667	660M - Mobile Home					•		6	K6	\$25.50
Single Cylinder Deadbolt with SmartKey		3	5	11P	15	26D	514	Case Qty.	Keying	
96600-710	660 514 SMT CP						•	6	K6	\$31.90
RDT Contemporary Single Cylinder Deadbolt		3	5	11P	15	26D	514	Case Qty.	Keying	
96600-761	660 RDT - Single Cylinder						•	6	K6	\$35.09
96600-766	660 RDT - Single Cylinder				•			6	K6	\$33.09

Kwikset



HALO™

WI-FI ENABLED SMART LOCKS

Halo smart locks connect directly to your existing Wi-Fi router and smartphone to create a simple and secure smart home, without a third-party hub, panel or subscription service.



Wi-Fi Enabled



Works with the Kwikset App



Control your lock from your smartphone

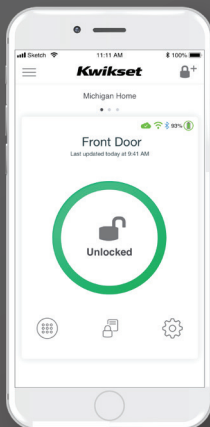

REMOTE ACCESS

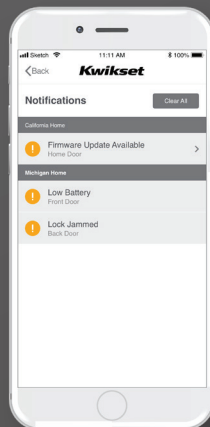

PUSH NOTIFICATIONS

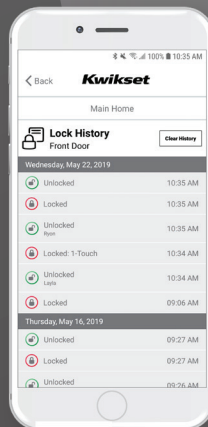

EVENT HISTORY

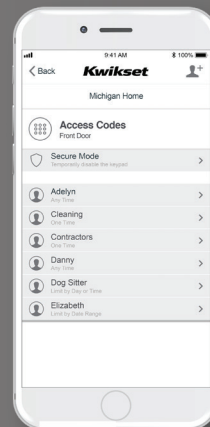

MANAGE ACCESS CODES

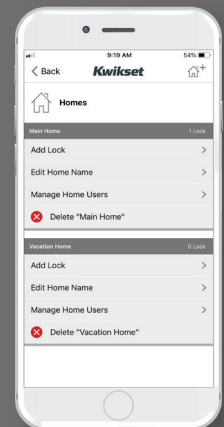

MANAGE MULTIPLE HOMES

#1 SELLING U.S. LOCK BRAND*

*Source: TraQline US quarterly brand unit share report, Q4 2016 through Q1 2021.

Specifications

Function	Single cylinder deadbolt
Door Prep	2 1/8" diameter bore hole & 1" diameter latch hole
Backset	Adjustable 2 3/8" or 2 3/4"
Door Thickness	1 3/8" - 2" automatic adjustment
Faceplates	1" x 2 1/4" round corner standard
Strikes	Round corner, 4 hole strike, 2 3/4" x 1 1/8"
Latch	Round corner adjustable 2 3/8" x 2 3/4"
Bolt	1" throw, steel deadbolt
Door Handing	Reversible
Cylinder	SmartKey Security™

Environmental:

Temperature Range	Exterior: -40°F to 150°F Interior: 32°F to 140°F
Humidity	Exterior: 100% condensing Interior: 30% - 95% non-condensing

Innovative Security

- 250 customizable access codes with optional schedules
- BHMA Grade AAA certified
- 20 Minute fire rating - UL certified
- Full 128-bit encryption security
- Featuring SmartKey Security™ - protecting against advanced break-in techniques
- SecureScreen™ - patented security feature prevents on-screen fingerprint user code identification (Touchscreen only)

Easy Installation

- Installs in minutes with just a screwdriver
- No hard wiring needed
- Operates on 4 AA batteries (included)

Warranty

- Lifetime mechanical and finish warranty
- 1 year electronic warranty

FINISH AND
LIFETIME WARRANTY
MECHANICAL

ONE YEAR
ELECTRONIC WARRANTY



Dimensions

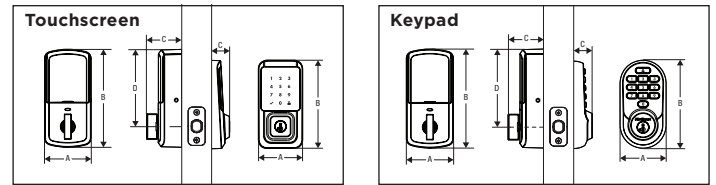

Touchscreen	A	B	C	D
Interior	2 3/4" (70 mm)	5 13/16" (147 mm)	2 1/8" (53 mm)	4 9/16" (116 mm)
Exterior	2 28/32" (73 mm)	5 5/8" (143 mm)	1 3/16" (30 mm)	---

Keypad	A	B	C	D
Interior	2 3/4" (70 mm)	5 13/16" (147 mm)	2 1/8" (53 mm)	4 9/16" (116 mm)
Exterior	2 28/32" (73 mm)	5 13/32" (137 mm)	1 3/16" (30 mm)	---

Finishes



How it Works



Kwikset



HALO

TOUCH

FINGERPRINT SMART LOCK

The Halo Touch Wi-Fi enabled smart lock with fingerprint access technology allows you to simply use your unique fingerprint to lock and unlock your door.



Works with the
Kwikset App



Control your lock from your smartphone

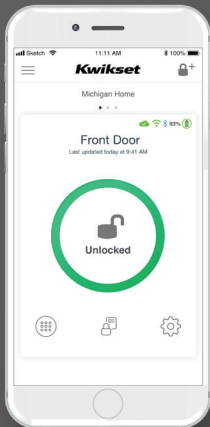

REMOTE
ACCESS

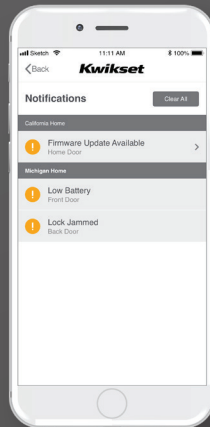

PUSH
NOTIFICATIONS

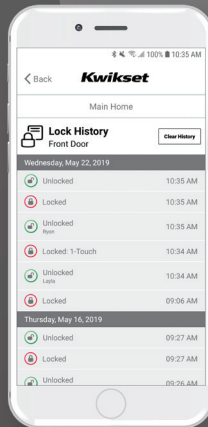

EVENT
HISTORY

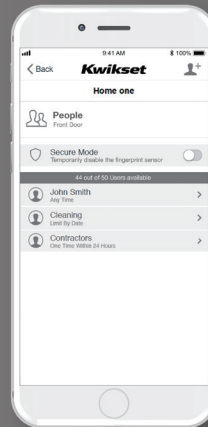

MANAGE
USERS

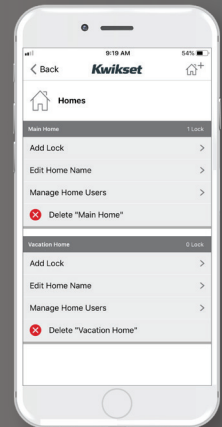

MANAGE MULTIPLE
HOMES

#1 SELLING U.S. LOCK BRAND*

*Source: TraQline US quarterly brand unit share report, Q4 2016 through Q1 2021.

Specifications

Function	Single cylinder deadbolt
Door Prep	2 1/8" diameter bore hole & 1" diameter latch hole
Backset	Adjustable 2 3/8" or 2 3/4"
Door Thickness	1 3/4" - 2" automatic adjustment
Faceplates	1" x 2 1/4" round corner standard
Strikes	Round corner, 4 hole strike, 2 3/4" x 1 1/8"
Latch	Round corner adjustable 2 3/8" x 2 3/4"
Bolt	1" throw, steel deadbolt
Door Handing	Reversible
Cylinder	SmartKey Security™
Temp Range & Humidity	Temperature Range: Exterior: -40F to 150F Interior: 32F to 130F Humidity: Exterior: 100% condensing Interior: 30% - 95% non-condensing

Dimensions

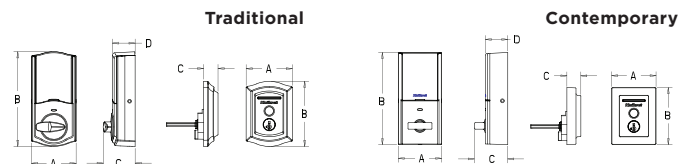

Traditional	A	B	C	D
Interior	2 23/32" (69 mm)	5 25/32" (147 mm)	1 15/16" (49 mm)	1 7/16" (35 mm)
Exterior	2 13/16" (72 mm)	3 31/32" (101 mm)	7/8" (22 mm)	---

Contemporary	A	B	C	D
Interior	2 23/32" (69 mm)	5 25/32" (147 mm)	2 2/32" (53 mm)	1 13/32" (36 mm)
Exterior	2 25/32" (71 mm)	3 9/16" (91 mm)	7/8" (22 mm)	---

Innovative Security

- Up to 100 fingerprints/50 users
- BHMA Grade AAA certified
- 256-bit AES encryption security
- Featuring SmartKey Security™ - protecting against advanced break-in techniques

Easy Installation

- No hub required by connecting directly to your home Wi-Fi network
- Operates on (4) AA batteries
- Installs in minutes using a screwdriver

Warranty

- Lifetime mechanical and finish warranty
- 1 year electronic warranty

How it Works



Finishes



Satin Nickel¹⁵
99590-001



Venetian Bronze™¹⁶
99590-002



Satin Nickel¹⁵
99590-003



Matte Black⁵¹⁴
99590-004

FINISH AND
LIFETIME
WARRANTY
MECHANICAL
ONE YEAR
ELECTRONIC WARRANTY



Kwikset



aura™

BLUETOOTH KEYPAD SMART LOCK

Smarter Living

Aura™ Bluetooth™ smart lock gives you control of your door with your smartphone — it's as simple as that.



Bluetooth Enabled



Works with the Kwikset App

Control your lock from your phone

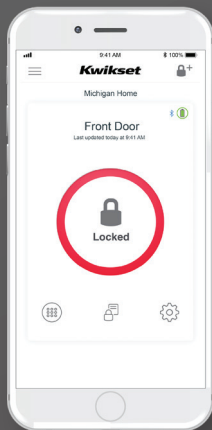

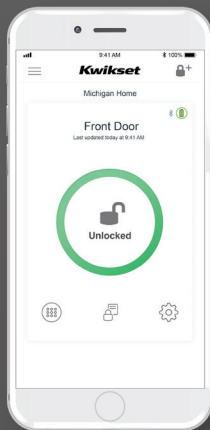

LOCKED



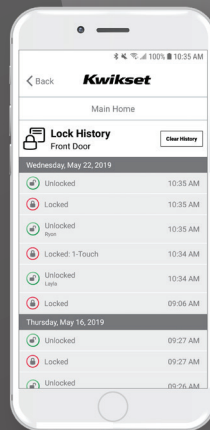

UNLOCKED

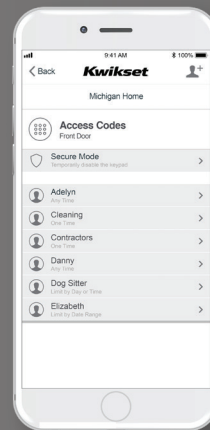

EVENT HISTORY

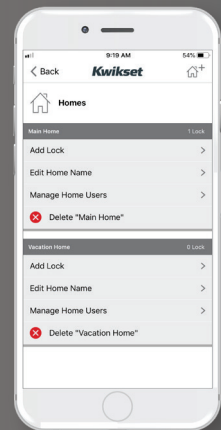

MANAGE ACCESS CODES



MANAGE MULTIPLE HOMES

#1 SELLING U.S. LOCK BRAND*

*Source: TraQline US quarterly brand unit share report, Q4 2006 through Q1 2021.

Specifications

Function	Single cylinder deadbolt
Door Prep	2 1/8" diameter bore hole & 1" diameter latch hole
Backset	Adjustable 2 3/8" or 2 3/4"
Door Thickness	1 3/8" - 2" automatic adjustment
Faceplates	1" x 2 1/4" round corner standard
Strikes	Round corner, 4 hole strike, 2 3/4" x 1 1/8"
Latch	Round corner adjustable 2 3/8" x 2 3/4"
Bolt	1" throw, steel deadbolt
Door Handing	Reversible
Cylinder	SmartKey Security™

Dimensions

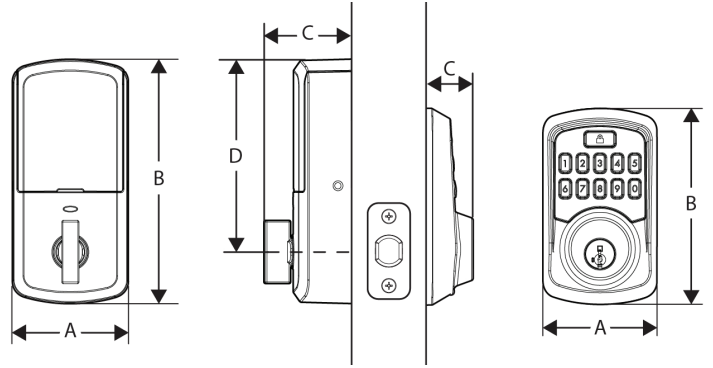

Design	A	B	C	D
Interior	2 3/4" (70 mm)	5 13/16" (147 mm)	2 1/8" (53 mm)	4 9/16" (116 mm)
Exterior	2 23/32" (69 mm)	4 5/8" (117 mm)	1 3/16" (30 mm)	---

Innovative Security

- 250 customizable access codes with optional schedules
- BHMA Grade AAA certified
- 20 Minute fire rating - UL certified
- Full 128-bit encryption security
- Featuring SmartKey Security™ - protecting against advanced break-in techniques

Easy Installation

- Installs in minutes with just a screwdriver
- No hard wiring needed
- Operates on 4 AA batteries

Warranty

- Lifetime mechanical and finish warranty
- 1 year electronic warranty

Finishes



Satin Nickel¹⁵
99420-001

Venetian Bronze^{11P}
99420-002

Matte Black⁵¹⁴
99420-003

How it Works

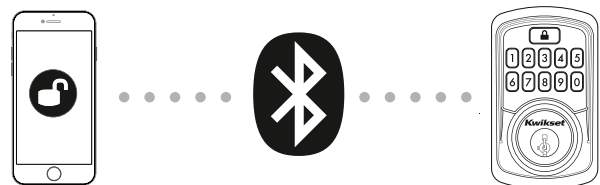

Kwikset

OBSIDIAN

TOUCHSCREEN ELECTRONIC DEADBOLT

With Z-Wave® 500 Chipset

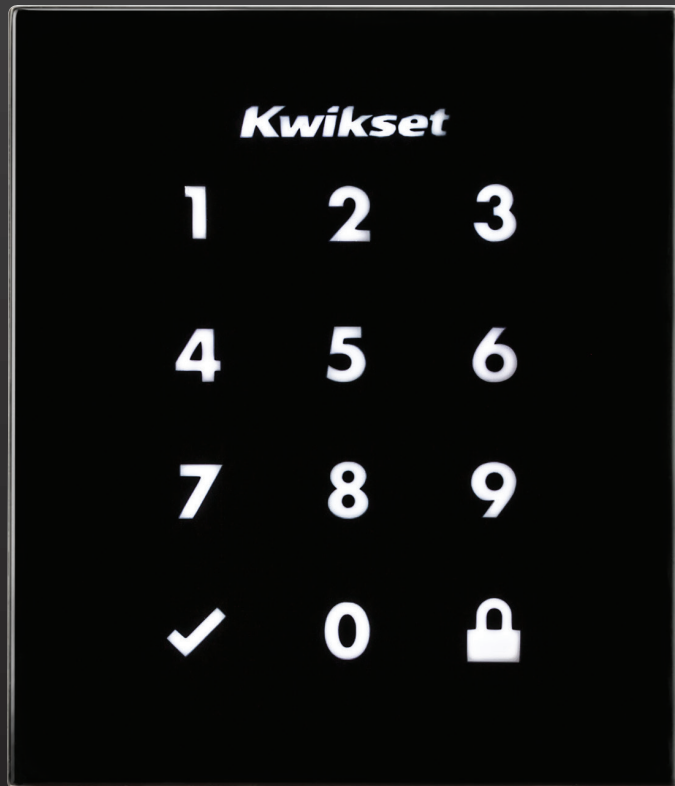

Features

- Sleek, modern design
- 10 digit capacitive touchscreen with SecureScreen™
- Keywayless
- 9V battery backup power
- Z-Wave® 500 for extended wireless range, over-the-air firmware updates and superior wireless encryption

User Codes

- Up to 30 customizable user access codes for family & guests
- Mastercode feature for improved user code management

Connected Benefits

- Lock/Unlock your doors from anywhere
- View lock status and receive notifications of your lock's activity
- Connect to other devices in the home and create scenes driven by the door lock

THE LEADER IN RESIDENTIAL SECURITY

Kwikset

OBSIDIAN

TOUCHSCREEN ELECTRONIC DEADBOLT

Specifications

Function	Touchscreen Deadbolt
Door Prep	1 1/2" and 2 1/8" diameter face hole and 1" diameter latch hole
Backset	Adjustable 2 3/8" or 2 3/4"
Door Thickness	1 3/8" - 2"
Faceplates	1" x 2 1/4" round corner standard
Strikes	Round corner
Latch	Round corner adjustable 2 3/8" x 2 3/4"
Bolt	1" throw, steel deadbolt
Door Handing	Reversible
Batteries	6V (4 x AA alkaline batteries required)
Wireless Protocol	Z-Wave® 500; lock complies with Z-Wave standard of open air, line of sight transmission of 160 feet or more. Compliant with FCC Part 15. Industry Canada. <small>*Range may vary depending on radio frequency environment. Works with your home control platform to optimize range.</small>

Dimensions

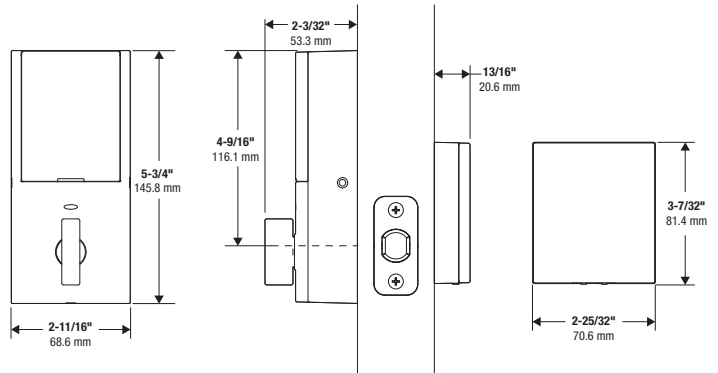

Easy Installation

- Replaces existing door hardware with just a screwdriver
- No hard wiring required
- Operates on 4 AA batteries that will last for approximately 1 year

Innovation Security

- BHMA Grade 2 Certified
- 128-bit Advanced Encryption Standard (AES) communication
- Revolutionary tapered deadbolt design - enables misaligned doors to lock without pulling and pushing your door shut

Finishes



Satin Nickel 15

Venetian Bronze 11P

FINISH AND
LIFETIME WARRANTY
MECHANICAL
ONE YEAR
ELECTRONIC WARRANTY



kwikset.com/wirelesslocks • 866-863-6584 • connected@kwikset.com

© 2017 Spectrum Brands, Inc. • Kwikset is a trademark of Spectrum Brands, Inc., Lake Forest, CA 92610 • 142477

Electronic Locks

Kwikset's electronic door locks offer users the convenience of keyless entry, virtually eliminating the need for keys. All of our electronic locks are easy to install and program while complementing any Kwikset knob, lever or handleset.



Features



- Smart Locks Replace any Deadbolt for Keyless Entry Convenience
- SmartCode™ Lever Ideal for - Small/Home Office, Utility/Storage Room, Interior Garage/Side Door
- Lock Your Door with the Touch of a Button
- Customizable Access Codes for Increased Security
- Back-Lit Keypad for Increased Visibility
- Customizable Automatic Door Locking After 30 Seconds for Peace Of Mind
- Installs In Minutes with Just a Screwdriver - No Hard Wiring Required
- Fits Standard Doors (1 3/8" - 2") with No Screw Holes Required

Warranty

- 1 Year Electronic Warranty
- Limited Finish & Mechanical Warranty

ELECTRONIC LOCKS											
MFG Pro#	Function	Finish								Case Qty.	Price
Obsidian		3	L03	5	11P	15	26	26D	514		
99530-001	953 OBN 15 SMTCD RCALFD					•				2	\$407.00
99530-002	953 OBN 11P SMTCD RCALFD				•					2	\$407.00



SmartCode™ 915											
3	L03	5	11P	15	26	26D	514				
99150-002	SmartCode™ 915 Touchscreen Deadbolt					•				2	\$407.00
99150-003	SmartCode™ 915 Touchscreen Deadbolt				•					2	\$407.00



SmartCode™ 913 Contemporary											
3	L03	5	11P	15	26	26D	514				
99130-008	913CNT 15 SMTCD					•				2	\$275.00
99130-009	913CNT 11P SMTCD				•					2	\$275.00
99130-010	913CNT 26 SMTCD						•			2	\$275.00
99130-011	913CNT 514 SMTCD							•		2	\$275.00



SmartCode™ 913											
3	L03	5	11P	15	26	26D	514				
99130-001	SmartCode™ 913 TRL Deadbolt		•							2	\$275.00
99130-002	SmartCode™ 913 TRL Deadbolt					•				2	\$275.00
99130-003	SmartCode™ 913 TRL Deadbolt				•					2	\$275.00



SmartCode™ 917											
3	L03	5	11P	15	26	26D	514				
99170-001	917TNL 15 SMT CP RCALFD					•				2	\$262.00
99170-002	917TNL 11P SMT CP RCALFD				•					2	\$262.00
99170-003	917HFL 15 SMT CP RCALFD					•				2	\$262.00
99170-004	917HFL 514 SMT CP RCALFD							•		2	\$262.00
99170-005	917HFL 26 SMT CP RCALFD						•			2	\$262.00



SmartCode™ 909											
3	L03	5	11P	15	26	26D	514				
99090-017	SmartCode™ 909 Deadbolt		•							2	\$231.00
99090-018	SmartCode™ 909 Deadbolt					•				2	\$231.00
99090-019	SmartCode™ 909 Deadbolt				•					2	\$231.00



Halo Wi-Fi											
3	L03	5	11P	15	26	26D	514				
99390-001	939 WIFI TSCR 15 SMT TPR RCALFD					•				1	\$504.00
99390-002	939 WIFI TSCR 11P SMT TPR RCALFD				•					1	\$504.00
99390-003	939 WIFI TSCR 26 SMT TPR RCALFD						•			1	\$504.00
99390-004	939 WIFI TSCR 514 SMT TPR RCALFD							•		1	\$504.00
99380-001	938 WIFI KYPD 15 SMT TPR RCALFD					•				1	\$438.00
99380-002	938 WIFI KYPD 11P SMT TPR RCALFD				•					1	\$438.00



Halo Touch Wi-Fi											
3	L03	5	11P	15	26	26D	514				
99590-001	959 TRL FPRT WIFI 15 RCAL RCS					•				1	\$517.00
99590-002	959 TRL FPRT WIFI 11P RCAL RCS				•					1	\$517.00
99590-003	959 CNT FPRT WIFI 15 RCAL RCS					•				1	\$517.00
99590-004	959 CNT FPRT WIFI 514 RCAL RCS							•		1	\$517.00



ELECTRONIC LOCKS



MFG Pro#	Function	Finish								Case Qty.	Price
Powerbolt® 2		3	L03	5	11P	15	26	26D	514		
99070-101	Powerbolt® 2					•				2	\$157.00
99070-102	Powerbolt® 2	•								2	\$157.00
99070-103	Powerbolt® 2				•					2	\$157.00



Kwikset 905		3	L03	5	11P	15	26	26D	514		
99050-003	905 15 CP					•				2	\$110.00
99050-004	905 11P CP				•					2	\$110.00



Premis™		3	L03	5	11P	15	26	26D	514		
99190-001	919 TRL 15					•				1	\$484.00
99190-002	919 TRL 11P				•					1	\$484.00
99190-003	919CNT PREMIS 15					•				1	\$484.00
99190-004	919CNT PREMIS 514								•	1	\$484.00



Aura™		3	L03	5	11P	15	26	26D	514		
99420-001	942 BLE DB 15 SMT TPR RCALFD					•				1	\$328.00
99420-002	942 BLE DB 11P SMT TPR RCALFD				•					1	\$328.00
99420-003	942 BLE DB 514 SMT TPR RCALFD								•	1	\$328.00



Electronic Combo Packs		3	L03	5	11P	15	26	26D	514		
99690-003	909TRL/720H 15 CP					•				2	\$265.00
99690-004	909TRL/720H 11P CP				•					2	\$265.00



Electronic Combo Packs		3	L03	5	11P	15	26	26D	514		
99690-005	909TRL/720TNL 15 CP					•				2	\$279.00
99690-006	909TRL/720TNL 11P CP				•					2	\$279.00



Electronic Combo Packs		3	L03	5	11P	15	26	26D	514		
99690-007	9530BN/154HFL 15 CP					•				2	\$462.00



Commercial Electronic Lever		3	L03	5	11P	15	26	26D	514		
99550-001	955PML 26D SMT CP							•		1	\$237.00
99550-002	955PML 15 SMT CP					•				1	\$237.00
99550-003	955PML 11P SMT CP				•					1	\$237.00
99550-004	955PML 514 SMT CP								•	1	\$237.00



Control your lock from anywhere on your smart phone, tablet, or internet connected device and never worry about forgetting to lock your door again.

- Remotely lock and unlock your door from anywhere
- Receive notifications of your lock's activity
- Control when others have access to your home
- Arm or disarm your security panel
- Wirelessly communicate to other devices in your home



Electronic Locks with Home Connect (Z-Wave)									
<i>Item Number</i>	<i>Function</i>	<i>Finish</i>					<i>Case Qty.</i>	<i>Price</i>	
Obsidian™ with Home Connect		L03	11P	15	26	26D	514		
99540-001	954 OBN ZW500 15 RCALFD			•				1	\$506.00
99540-002	954 OBN ZW500 11P RCALFD		•					1	\$506.00

*Product must be ordered by item number and not description



SmartCode™ 916 Contemporary with Home Connect									
<i>Item Number</i>	<i>Function</i>	L03	11P	15	26	26D	514	<i>Case Qty.</i>	<i>Price</i>
99160-016	916CNT TSCR ZW500 15 SMTCD			•				1	\$506.00
99160-017	916CNT TSCR 11P ZW500 SMTCD		•					1	\$506.00
99160-018	916CNT TSCR 26 ZW500 SMTCD				•			1	\$506.00
99160-028	916CNT ZW500 514 SMT RCALFD						•	1	\$506.00

*Product must be ordered by item number and not description



SmartCode™ 916 with Home Connect									
<i>Item Number</i>	<i>Function</i>	L03	11P	15	26	26D	514	<i>Case Qty.</i>	<i>Price</i>
99160-020	916TRL ZW500 15 RCALFD			•				1	\$506.00
99160-021	916TRL ZW500 11P RCALFD		•					1	\$506.00

*Product must be ordered by item number and not description

Features

- Full 128-Bit Encryption Security
- Motorized locking mechanism enables true remote locking & unlocking
- SmartKey Security - providing superior security against advanced break-in techniques.
- Easy Integration
- Z-Wave Wireless Protocol
- Fits Standard Doors (1 3/8"-2") with No Screw Holes Required
- 4 AA Alkaline Batteries (no hard wiring) - batteries last for approximately 1 year



SmartCode™ 912 with Home Connect		L03	11P	15	26	26D	Case Qty.	
99120-037	912TNL ZW500 15 RCALFD			•			1	\$413.00
99120-038	912TNL ZW500 11P RCALFD		•				1	\$413.00

*Product must be ordered by item number and not description



Home Connect 620		L03	11P	15	26	26D	514	Case Qty.	
98930-001	HC620 TRL ZW700 15 SMT RCALFD RCS BP			•				1	\$297.00
98930-002	HC620 TRL ZW700 11P SMT RCALFD RCS BP		•					1	\$297.00
98930-003	HC620 TRL ZW700 L03 SMT RCALFD RCS BP	•						1	\$297.00

*Product must be ordered by item number and not description



Home Connect 620 Contemporary		L03	11P	15	26	26D	514	Case Qty.	
98930-004	HC620 CNT ZW700 15 SMT RCALFD RCS BP			•				1	\$297.00
98930-005	HC620 CNT ZW700 11P SMT RCALFD RCS BP		•					1	\$297.00
98930-006	HC620 CNT ZW700 26 SMT RCALFD RCS BP				•			1	\$297.00
98930-007	HC620 CNT ZW700 514 SMT RCALFD RCS BP						•	1	\$297.00

*Product must be ordered by item number and not description



SMARTCODE 917

RESIDENTIAL ELECTRONIC LEVER

Features

- Highest residential security rating
- 3-year battery life
- Reversible lever to fit left-hand or right-hand doors
- Lock owner can switch between three different locking modes: Auto-lock, Passage, and Disable Passage

User Codes

- Up to 30 user access codes
- Lock owner can program a one-time user code for emergencies, which deletes after first usage
- For added convenience, lock owners can program the lock from the outside with a programming code



MFG Pro#	Function	Finish								Case Qty.	Price
SmartCode™ 917		3	L03	5	11P	15	26	26D	514		
99170-001	917TNL 15 SMT CP RCALFD					•				2	\$262.00
99170-002	917TNL 11P SMT CP RCALFD				•					2	\$262.00
99170-003	917HFL 15 SMT CP RCALFD					•				2	\$262.00
99170-004	917HFL 514 SMT CP RCALFD								•	2	\$262.00
99170-005	917HFL 26 SMT CP RCALFD						•			2	\$262.00

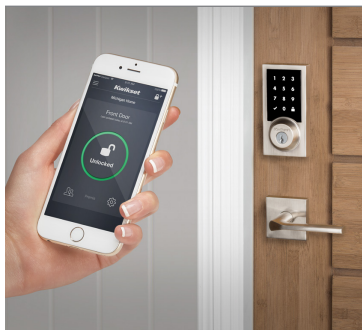

Siri® Voice Control

Lock and unlock your door using Siri voice commands

Lock Monitoring*

View lock activity, history and status notifications when lock is used.

Remote Access*

Control and monitor lock status from anywhere using the Kwikset Premis iOS or Apple Home app when connected to Apple TV (Gen 4 or higher) or HomePod with iOS 10 or higher

User Code Management

Easily send, add, and delete or disable user codes. Schedule access for certain times/days.

*Apple TV, iPad, iPhone, iPod, iPod Touch and Siri are trademarks of Apple Inc., registered in the U.S. and other countries. HomeKit is a trademark of Apple Inc. The Bluetooth® word mark and logos are registered trademarks owned by Bluetooth SIG, Inc. and any use of such marks by Kwikset is under license.

MFG Pro#	Function	Finish								Case Qty.	Price
		3	L03	5	11P	15	26	26D	514		
99190-001	919 TRL 15					•				1	\$484.00
99190-002	919 TRL 11P				•					1	\$484.00
99190-003	919CNT PREMIS 15					•				1	\$484.00
99190-004	919CNT PREMIS 514								•	1	\$484.00

HomeConnect 620

KEYPAD CONNECTED SMART LOCK

With Z-Wave® 700 Chipset



Features

- 10-Button keypad with one-touch locking
- Featuring Smartkey® Security Technology
- Sleek, all metal design
- Z-Wave® 700 for enhanced network security, network pre-enrollment, and extended wireless range and battery life
- Backward compatible with existing Z-Wave panels and hubs
- S2 Secure Network Enrollment
- SmartStart Network Pre-Enrollment

User Codes

- 250 user codes
- Control when people have access with customizable user code schedules
- MasterCode security for improved feature management

Connected Benefits

- Lock/Unlock your doors from anywhere
- View lock status and receive notifications of your lock's activity
- Connect to other devices in the home and create scenes driven by the door lock

SMARTCODE 955

COMMERCIAL GRADE LEVER



30 User Codes



Features

- Robust metallic design for enhanced durability
- BHMA Commercial grade 2 certified
- Highest residential security rating
- 3 year battery life
- Reversible lever to fit left-hand or right-hand doors

Property managers can disable the Passage Mode so that it auto-locks every time and a key or code is always required for entry. This is ideal for restrooms in restaurants and gas stations.

User Codes

- Up to 30 user access codes that can be customized for sharing with employees, maintenance personnel and service professionals
- User can program a one time user code for emergencies, which deletes after first usage
- For added convenience, property managers can program the lock from the outside with a programming code.

MFG Pro#	Function	Finish								Case Qty.	Price
		3	L03	5	11P	15	26	26D	514		
Commercial Electronic Lever											
99550-001	955PML 26D SMT CP							•		1	\$237.00
99550-002	955PML 15 SMT CP					•				1	\$237.00
99550-003	955PML 11P SMT CP				•					1	\$237.00
99550-004	955PML 514 SMT CP								•	1	\$237.00

KEY CONTROL™ DEADBOLT



Easily access the Key Control cylinder: (1) Insert the SmartKey Tool into the slot at bottom of cylinder cover (2) Rotate cover clockwise to expose the Key Control cylinder. (3) Now you have access to the Key Control cylinder. Use tool to rotate counter-clockwise back to user's keyway when appropriate.

Features

- Two Separate Cylinders, Tenant & Property Manager, Allow for More Tenant Key Cuts Than a Traditional Master Key System
- New Proprietary Keyway Adds Security
- Property Manager Cylinder is Concealed When Not in Use to Avoid Tenant Confusion
- With Smartkey®, Re-Key the Lock Without Removing From the Door

LIGHT COMMERCIAL



MFG Pro#	Function	Finish					Case Qty.	Price
Key Control Deadbolt		3	11P	15	26D	514		
98160-007	816 - Key Control Deadbolt	•					6	\$65.70
98160-009	816 - Key Control Deadbolt			•			6	\$74.30
Key Control Deadbolt CNT		3	11P	15	26D	514		
98160-012	816 SQT 15 SMT RCAL RCS RBP			•			6	\$74.30
98160-013	816 SQT 514 SMT RCAL RCS RBP					•	6	\$77.40



BUMP PROOF



PICK RESISTANT



KICK-IN RESISTANT



DRILL RESISTANT



SAW RESISTANT

HOW TO RE-KEY YOUR LOCK IN SECONDS



! Make sure you have your current key and SmartKey tool

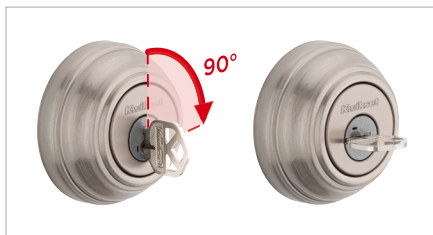

1 Insert the key that currently operates your lock, and rotate it 90° clockwise.

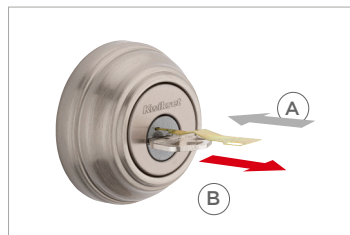

2 (A) Insert the SmartKey tool fully and firmly into the SmartKey hole.
(B) **Remove** the SmartKey tool and the current key.

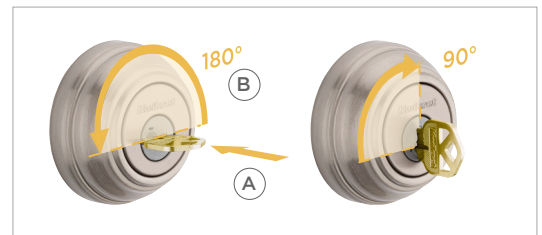

3 (A) Fully insert your new key into the lock, and rotate it 180°.
(B) Rotate the new key 90° back to the starting position, and remove it. Your lock is now re-keyed to your new key, and your old key will no longer operate the lock.



6-WAL
81825

PARTS										
MFG Pro#	Function		Finish						Case Qty.	Price
Plain Latches		NA	3	L03	5	11P	15	26/26D		
81826-001	19843 6WAL Plain Latch		•						6	\$12.90
81826-002	19843 6WAL Plain Latch				•				6	\$12.90
81826-003	19843 6WAL Plain Latch						•		6	\$12.90
Dead Latches		NA	3	L03	5	11P	15	26/26D	Case Qty.	
83014-015	Security - 5" Deadlatch, 1" Front		•						6	\$20.10
81825-001	19841 6WAL DL		•						6	\$15.00
81825-002	19841 6WAL DL				•				6	\$15.00
81825-003	19841 6WAL DL						•		6	\$15.00
Deadbolt Latches		NA	3	L03	5	11P	15	26/26D	Case Qty.	
83146-001	11776 CP, DB, ADJ 3		•						6	\$12.90
Mobile Home Conversion Kits		NA	3	L03	5	11P	15	26/26D	Case Qty.	
80340-001	12077 CP, DB, RFL, CNV Kit		•						6	\$11.20
83228-001	22827 CP, DL, 2WAL, DI 3/26 CNV Kit		•						6	\$9.80
83229-001	12003 CP, PI, 7/8RF, 3/26 CNV Kit		•						6	\$7.00
Strikes		NA	3	L03	5	11P	15	26/26D	Case Qty.	
83437-002	3437-01 CP, STRK, SQ CNR FULL LIP		•						6	\$3.90
83222-026	3222-01 3 CP STRK, DB		•						6	\$4.60

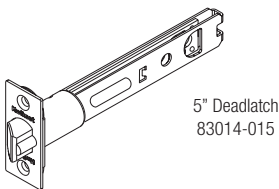

5" Deadlatch
83014-015

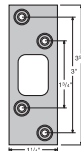

Deadbolt
Square Corner Strike
83222-026



Full Lip
Square Corner Strike
83437



REKEYING KIT

KEYING			
MFG Pro #	Description	Qty Per Pack	Price Per Pack
92720-001	272 Rekeying Kit	1	\$299.40
83108-001	#1 Master Pin .023"	100	\$20.00
83110-001	#2 Master Pin .046"	100	\$20.00
83112-001	#3 Master Pin .069"	100	\$20.00
83113-001	#4 Master Pin .092"	100	\$20.00
83114-001	#5 Master Pin .115"	100	\$20.00
83125-001	#6 Master Pin .138"	100	\$20.00
83100-001	#1 Bottom Pin .172"	100	\$20.00
83101-001	#2 Bottom Pin .195"	100	\$20.00
83103-001	#3 Bottom Pin .218"	100	\$20.00
83105-001	#4 Bottom Pin .241"	100	\$20.00
83106-001	#5 Bottom Pin .264"	100	\$20.00
83107-001	#6 Bottom Pin .287"	100	\$20.00
81858-001	Regular Top Pin .180"	100	\$20.00
83117-001	PK Top Pin .160"	100	\$20.00

KEYING			
MFG Pro #	Description	Qty Per Pack	Price Per Pack
80370-001	Regular Anti-Pick Top Pin .180"	100	\$40.00
80369-001	PK Anti-Pick Top Pin .160"	100	\$40.00
84345-001	Knob Plug Retainer	100	\$0.20
84215-001	Deadlock Plug Retainer	100	\$0.20
87619-001	Knob Control Lug (Locking Bar)	100	\$0.40
87809-001	Deadlock Control Lug (Locking Bar)	100	\$0.70
80371-001	Low Profile Deadbolt Spring Cover	100	\$1.40
85757-001	Spring Cover (5-Pin)	50	\$1.30
83561-001	Spring Cover (6-Pin)	50	\$1.30
87632-001	Spring	100	\$0.60
82208-001	PK Balls	100	\$0.20
81777-001	Tumbler Spring	100	\$0.20
81467-003	Cylinder Removal Tool	1	\$2.00
80152-001	Plug Follower	1	\$8.40
80049-001	Key Gauge	1	\$7.90

SmartKey KEYING			
MFG Pro #	Description	Case Qty.	Price
83262-001	Rekeying Kit CP SMT KW	6	\$17.30
83260-001	83260 SMT Reset Cradle	1	\$51.90



SMARTKEY SERVICE PARTS



83262-001



83260-001



335 PRIVACY



PADLOCKS

ROUND POCKET DOOR LOCK									
MFG Pro#	Function	Finish						Case Qty.	Price
Round Pocket Door Lock		3	L03	5	11P	15	26D		
93350-024	335 - Privacy					•		6	\$27.20

SMARTKEY PADLOCKS									
MFG Pro#	Function	Finish						Case Qty.	Price
SmartKey Padlocks									
90260-001	026SMT STD 1-1/8" SHKL PDL 50MM							6	\$26.80
90260-002	026SMT LNG 2" SHKL PDL 50MM							6	\$27.90



Handle Trim
Model 239

TRIMS										
Part #	Function	Finish						Dimensions	Case Qty.	Price
Trims		3	L03	5	11P	15	26D			
92930-012	293 3 CP	•						3-13/16"	4	\$18.80
92930-014	293 26D CP						•	3-13/16"	4	\$19.80