

A: GENERAL INFORMATION

Terms and Conditions	A:1
General Information	A:3
Weights and Measurements	A:12
Order Forms	A:15

B: NEW PRODUCTS

SmartCode 260 Keypad Deadbolt	B:1
SmartCode 270 Touchpad Deadbolt	B:3
San Clemente Rectangular Trim	B:5
Katella	B:9

C: KWIKSET SIGNATURE SERIES

Handlesets	C:3
Levers	C:9
Knobs	C:12
Deadbolts	C:14
Specifications	C:15

D: KWIKSET

Handlesets	D:2
Levers	D:4
Knobs	D:5
Deadbolts	D:6
Combo Packs	D:6
Specifications	D:7

E: ELECTRONIC LOCKS

Halo	E:2
Smartcode	E:4
Home Connect	E:6
Specifications	E:8

F: LIGHT COMMERCIAL

Multi-Family, Light Commercial & Key Control	F:1
Specifications	F:4

G: ACCESSORIES

Pocket Door Locks	G:1
SmartKey Padlocks	G:1
Trim	G:1
138 Installation Kit	G:1

H: SERVICE PARTS

Keys	H:1
Pin & Tumbler	H:2
SmartKey	H:6
Smartkey SC1	H:7
Key Control	H:8
Latches	H:9
Strikes	H:12
Screw Packs	H:15
Miscellaneous	H:19
Electronics	H:21

TERMS AND CONDITIONS OF SALE

Standard terms are 2% prompt payment discount for payment within 25 days from date of invoice; net 30 days from the date of invoice. Kwikset® reserves the right to charge and recover on invoices which are not paid within the above terms, a service charge of 1-1/2% a month for each month or fraction thereof during which the invoice remains unpaid, said service charge, however, not to exceed the highest applicable legal rate of interest. All orders, whether solicited or written by our sales representatives or forwarded by our customers are deemed to be mere offers to purchase in accordance with these Terms and Conditions of Sale until actually accepted by us at our home office in Lake Forest, CA. We reserve the right to refuse any order as well as the right to sell or not sell to any firm at our sole discretion. The acceptance of an order is expressly made conditional upon your assent to these Terms and Conditions of Sale. We object to the inclusion of any different or additional terms or conditions, even if the same are included in your order, a contract of sale will result upon the Terms and Conditions of Sale stated herein only. Prices reflected in this book apply to Wholesale customers only.

All sales are final.

PRICES

Pricing based on full-case quantities only; orders for less than full case will be automatically adjusted up to the next full-case quantity. All prices are subject to change without notice and are not guaranteed. All taxes, duties or other charges are the responsibility of the customer.

CLAIMS

Price claims must be submitted in writing to Kwikset, 19701 Da Vinci, Lake Forest, CA 92610 within 30 days from the date of invoice.

CHANGES OR CANCELLATIONS

Beyond 5 working days of our acknowledgement date no changes can be made. Additions to an order will be handled as a separate order and must meet applicable minimum order requirements. Order cancellation on regular stock items only, or any portion thereof is allowed only upon prior written consent from Kwikset, and the payment of cancellation charges deemed appropriate.

MINIMUM CHARGE

No order will be invoiced for less than \$100.00 net plus shipping charges except for lock accessory parts.

MINIMUM ANNUAL SALES VOLUME

The company reserves the right to discontinue direct sales to any customer who does not meet the minimum annual sales volume requirement. The current annual requirement is \$50,000.00. Your annual purchases are determined by accepted, non-cancelled, and shipped orders received during each calendar year. Kwikset reserves the right to change any or all minimum annual sales volume requirements at any time. Any customer who does not meet the annual sales volume requirements may continue to purchase Kwikset products through a Kwikset distributor.

RETURNS

Defective merchandise returned to our factories requires prior written authorization from a Kwikset Sales Rep or the Sales Office. A factory return authorization must accompany the returned shipment. The return authorization must include an itemized listing of the merchandise and an explanation stating the reason for return.

There will be a 20% product restocking fee on all returned merchandise.

FREIGHT

All goods are invoiced FOB to our factory. Upon delivery of shipments to the carrier, title to, and the risk of loss or damage in transit for such shipments, passes to our customer. Kwikset's standard policy is to pay freight charges on all orders over \$1,000.00 net invoice value to a single destination in the continental U.S., by carrier and route of our choice. Shipments less than these quantities will not be shipped on a prepaid basis. If higher freight charges are incurred from customers specifying a carrier or route of their choice the additional cost will be added to that customer's invoice.

DELIVERY CONDITIONS

Shipping schedules are our best estimates, and cannot be guaranteed. Kwikset is not responsible for any direct or consequential loss or damage resulting from an inability or delay in meeting shipping schedules.

KWIKSET LIMITED WARRANTIES

Kwikset products are backed by one of the most comprehensive warranty programs available. You can feel confident that with the purchase of Kwikset you have selected the best quality product, backed by the best customer service available.

MECHANICAL LIMITED WARRANTY

Except as otherwise provided below, Spectrum Brands, Inc., for its Kwikset® brand products ("Kwikset"), warrants to the original residential purchaser (the "Purchaser") that each Kwikset product (the "Product(s)" or "Kwikset Product(s)") will be free from mechanical defects under normal use from the date of purchase for as long as said Purchaser occupies the residential premises upon which the Product was originally installed ("Warranty Period"). This Mechanical Limited Warranty applies only to Products that were purchased from Kwikset or a Kwikset authorized seller, unless otherwise prohibited by law. Kwikset Products are legitimately sold only by authorized sellers who are required to follow Kwikset's policies, procedures, and quality control standards. Kwikset reserves the right to reject warranty claims from purchasers for Products purchased from unauthorized sellers, including unauthorized Internet sites.

FINISH LIMITED WARRANTY

The finish on Kwikset Products is protected by a durable topcoat designed to maintain the beauty and quality of the Kwikset Product. Kwikset warrants to the Purchaser that the finish of the Product shall be free of defects in material and workmanship from tarnishing, flaking, and discoloring from the date of purchase for as long as said Purchaser occupies the residential premises upon which the Product was originally installed ("Warranty Period"). This Finish Limited Warranty applies only to Products that were purchased from Kwikset or a Kwikset authorized seller, unless otherwise prohibited by law. Kwikset Products are legitimately sold only by authorized sellers who are required to follow Kwikset's policies, procedures, and quality control standards. Kwikset reserves the right to reject warranty claims from purchasers for Products purchased from unauthorized sellers, including unauthorized Internet sites.

ELECTRONIC LIMITED WARRANTY

Kwikset warrants to the Purchaser that Kwikset Products will be free from electronic defects under normal use for one (1) year from the date of purchase, as long as said Purchaser occupies the residential premises upon which the Product was originally installed ("Warranty Period"). This Electronic Limited Warranty applies only to Products that were purchased from Kwikset or a Kwikset authorized seller, unless otherwise prohibited by law. Kwikset Products are legitimately sold only by authorized sellers who are required to follow Kwikset's policies, procedures, and quality control standards. Kwikset reserves the right to reject warranty claims from purchasers for Products purchased from unauthorized sellers, including unauthorized Internet sites.

EXCLUSIONS FROM WARRANTY

1. Any Kwikset Product produced prior to January 1, 2006.¹
2. Any Kwikset Product which has been damaged as a result of installation contrary to any of Kwikset's written installation instructions is not covered by these warranties.
3. Any Kwikset Product which has been modified by any non-Kwikset component is not covered by these warranties.
4. Any Kwikset Product having a defect caused by neglect, misuse, abuse or unreasonable or extraordinary use or maintenance, including use in a commercial application, is not covered by these warranties.
5. Any Kwikset Product having a defect due to use of paints, solvents, or other chemicals is not covered by these warranties.
6. Any Kwikset Product that is used in combination with knobs, levers, or trim of other than those manufactured by Kwikset and designated for use with the applicable locks or latches is not covered by these warranties.
7. Any Kwikset Product that was purchased from an unauthorized seller is not covered by these warranties.

These warranties are not transferable. Therefore, no transferee is covered by these warranties.

¹ Kwikset Products produced prior to January 1, 2006, may be eligible for warranty in accordance with the terms and conditions of the applicable warranty program.

WARRANTY CLAIMS

If you wish to make a warranty claim based upon a Product defect, please call us at 1-800-327-LOCK (5625) or contact us at kwikset.com/support.

Please note that you will be required to provide a description of any claimed defect(s) and a dated receipt or other proof of purchase from Kwikset or the Kwikset authorized seller, to verify warranty eligibility.

Certain claimed defect(s) covered by these warranties may be resolved by Kwikset providing you with troubleshooting steps.

Other claimed defect(s) covered by these warranties may require Product replacement. Products may not be returned to Kwikset without prior authorization from Kwikset. If authorized by Kwikset, you will need to mail your Product to:

Spectrum Brands, Inc.

ATTN: Kwikset Consumer Services

19701 Da Vinci

Lake Forest, CA 92610

A prepaid shipping label will be provided to you.

REMEDIES

For certain claimed defect(s) covered by these warranties, as determined by Kwikset, Kwikset will provide you with troubleshooting steps.

For other claimed defect(s) covered by these warranties, as determined by Kwikset, Kwikset will replace the defective Product or part.

If a Kwikset Product, which is the same as the Kwikset Product or any part covered by these warranties, has been discontinued at the time of replacement or if Kwikset determines, in its sole discretion, that such replacement is inappropriate, Kwikset reserves the right to substitute an alternative product. Kwikset also reserves the right to accept or reject an alternative product proposed as a replacement, when the value is higher than that of the Product originally purchased by the Purchaser. Except as expressly provided in these warranties to the contrary, KWIKSET SHALL NOT BE OBLIGATED OR LIABLE FOR LABOR OR OTHER COSTS RELATED TO INSTALLATION, REPAIR OR REPLACEMENT OF A KWIKSET PRODUCT, OR FOR LOSS OF, OR DAMAGE TO ANY MATERIAL WHICH IS NOT SOLD BY KWIKSET.

PATENT INDEMNITY

We agree to defend any suit or proceeding brought against our customer so far as based on claim that our products, or any part thereof, made solely to our specifications and furnished to our customer constitute an infringement of any U.S. patent, if notified promptly in writing and given authority, information and assistance at our expense for the defense of same, and we shall pay all damages and costs awarded therein against our customer. In case our products, or any part thereof, is in such suit held to constitute infringement and their use is enjoined, we will, at our expense and discretion, either procure for our customer the right to continue using the products or replace same with non-infringing products, or modify them so they become non-infringing, or remove such products and refund the purchase price (less depreciation, prorated from the purchase date). The foregoing states our entire liability for patent infringement by our products or any part thereof.

INTELLECTUAL PROPERTY

No person or entity may sell, distribute, advertise, market or promote Kwikset branded products distributed by Kwikset Corporation ("Kwikset"), Spectrum Brands Hardware Home Improvement Division, without prior authorization from Kwikset. Customers of Kwikset who are authorized to sell Kwikset branded products are referred to herein as "Customers."

The Kwikset brand and all Kwikset trademarks, trade names, product depictions, colors, graphics or logos, whether or not registered or otherwise protected (the "Marks"), remain the sole and exclusive property of Kwikset and nothing arising out of the relationship between Kwikset and any Customer conveys to Customer any ownership rights in the Marks. Customer may use the Marks and then only in the sale or promotion of authentic Kwikset products in compliance with the terms of this policy. The Marks must be used exactly in the form provided and in conformity with all Kwikset trademark usage policies or guidelines, including, but not limited to, those relating to shape, color match and imprint quality. Any proposed deviation must be approved in writing by Kwikset prior to use. The Marks may not be used in or as part

of any Customer domain name on the Internet. Prior to any use of the Marks on goods or services, Customer must submit samples for Kwikset's approval.

Additionally, no Customer may use product depictions, graphics, logos or text relating to Kwikset products that have not been provided by Kwikset in connection with the advertising, promotion or sale of Kwikset products without Kwikset's prior review and written approval of each such use. The Marks may not be used in or as part of any reseller or other third party (i) domain name or VRL on the Internet, (ii) trademark or service mark, or (iii) company or trade name. Any action on the part of a Customer that violates the terms of this policy or otherwise impairs the value of or goodwill associated with the Marks or is otherwise not in conformity with Kwikset's standards may result in the suspension or termination of the Customer's authorization or any other remedy permitted by law.

Kwikset grants to each of its Customers limited, non-transferable, non-sublicenseable licenses of the patents relating to the Kwikset products that the Customer is authorized to sell and of the copyrights in any packaging or other written materials included therewith or related thereto. Said patent and copyright licenses are solely to sell such Kwikset products covered by such patents and to which such copyrights relate only to end-users and other Customers in compliance with the terms of this document. The sale of such patented Kwikset products and the sale or use of such copyrighted materials by a Customer that violate the terms of this document exceed the scope of the licenses herein granted to the Customer and may constitute patent and/or copyright infringement.

STANDARDS

Kwikset meets or exceeds the testing requirements specified for each product grade or rating.

- American National Standards Institute (ANSI)
- Builders Hardware Manufacturers Association (BHMA)
- Underwriters Laboratories, Inc. (UL)
- Americans with Disabilities Act (ADA)

MISCELLANEOUS

Substitution of non-Kwikset components/parts, and any alteration or modification of factory parts, and other lock manufacturer's parts may result in door hardware which does not function properly or will fail and will void all warranties. Orders not specified with keying requirements will be shipped Keyed Differently (KD). Orders with keying requirements of K10 or more must have a "Letter of Release" on file with Kwikset stating that Kwikset Corporation will not be held liable for cost and expense arising from any loss or damage to property utilizing Kwikset products where 10 or more locks have been keyed alike. Contact your Sales Office account representative for a copy of the release form. Kwikset reserves the right to revise or modify products, product information, or pricing without notice. Product specifications and pricing reflect available information at the time of printing. Kwikset is not responsible for typographic or printing errors.

LIMITATION OF LIABILITIES

THERE ARE NO WARRANTIES WHICH EXTEND BEYOND THOSE STATED HEREIN. ANY IMPLIED WARRANTIES THAT MAY BE APPLICABLE TO PRODUCTS, INCLUDING IMPLIED WARRANTIES OF MERCHANTABILITY OR FITNESS FOR A PARTICULAR PURPOSE, ARE LIMITED IN DURATION TO THE DURATION OF THIS WARRANTY. SOME STATES DO NOT ALLOW LIMITATIONS ON HOW LONG AN IMPLIED WARRANTY LASTS, SO THE ABOVE LIMITATION MAY NOT APPLY TO YOU. UNDER NO CIRCUMSTANCES SHALL KWIKSET BE LIABLE FOR ANY SPECIAL, INCIDENTAL, OR CONSEQUENTIAL DAMAGES BASED UPON BREACH OF THIS LIMITED WARRANTY, BREACH OF CONTRACT, OR STRICT LIABILITY. SOME STATES DO NOT ALLOW THE EXCLUSION OR LIMITATION OF INCIDENTAL OR CONSEQUENTIAL DAMAGES, SO THE ABOVE LIMITATION OR EXCLUSION MAY NOT APPLY TO YOU. THIS WARRANTY GIVES YOU SPECIFIC LEGAL RIGHTS, AND YOU MAY ALSO HAVE OTHER RIGHTS WHICH VARY FROM STATE TO STATE.

Effective Date: [July 6th 2020]

ORDER CODE BREAKOUT

Quantity	Specifies Quantity
Function & Style	Specifies Model and Function
Rose Design	Specifies Designer Rose
Handing	Handing Right or Left
Finish	Exterior/Interior
Keying	Special Keying
Code	Keying Code
Latch	Specifies Latch
Strike	Indicates Strike
Key Alike Qty	Keyed Alike

Example: "I would like to order 12 SmartKey Commonwealth levers, satin nickel finish, round corner latch & strike, 3 keyed alike" Written as:
12-740CHL 15 SMT RCAL RCS K3.

NOTE: All handlesets ordered LIP only.

UNDERWRITERS LABORATORIES LISTED LOCKSETS



To meet Underwriters Laboratories' fire rating requirements UL listed locksets, UL listed latches, and UL listed strikes must be used together.

AMERICAN WITH DISABILITIES ACT (ADA)



Products displaying this symbol comply with the Americans with Disabilities Act of 1990.

HOW TO ORDER 20MIN UL LOCKS

FD = 20 minute UL designation

Example: "I would like to order 12 passage Tustin levers with round corner latch and strike with 20 minute UL in Satin Nickel"
12-720TNL 15 RCALFD RCS.

NOTE: The latch configuration is not available with FD. There is a \$2.50 list price upcharge for 20 minute UL.

KEYING

Code	Option
KD	Keyed Differently
K2, K3	Keyed Alike (2 Locksets, 3 Locksets)
MK	Master Keyed
PK	Builder (Protecto) Keyed
GMK	Grand Master Keyed
PMK	Builder (Protecto) Master Keyed
MAIS	Maison Keying
SEQ	Sequential Construction Keying
KBOX	Keys in One Box
SMT	SmartKey Securit
SMC	SmartKey Security - SC1 Keyway

NOTE: Speciality Keying list prices can be found on page H:2

BACKSET

Backset is the distance from center edge of door to center of the 2-1/8" (54mm) diameter hole, 2-3/8" or 2-3/4" in most cases.

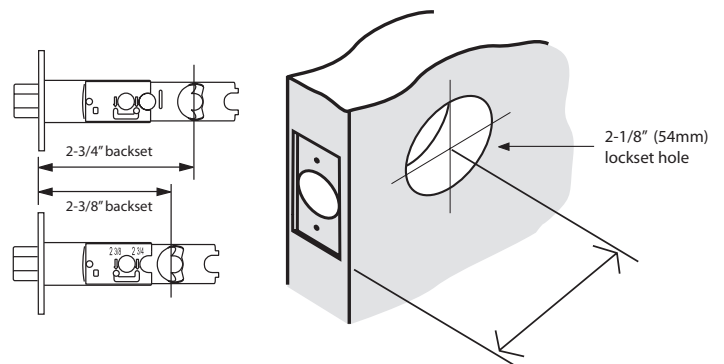

Model	Function
200/407/420/720/721/725	Passage/Hall/Closet
300/408/430/730/733/735	Privacy/Bed/Bath
334/335	Round Pocket Door Lock
400/401/438/740/756	Entry
405/406/409/413	Lever Keyed Entry
450/462/412/439/755/781	Storeroom/Vestibule
488/788	Half Dummy Trim, Surface Mounted
502/505/506/508	Interconnect
553/687/800/818	Single Cylinder Handleset
689	Double Cylinder Handleset
699/802/819	Dummy Handleset
898/814	Handle Only
899/815	Handle and Lever Only
598	Single Cylinder Gatelatch
604	Interior Pack for Kwikset Handlesets
158/258/660/780/782/980/982/816/817	Single Cylinder Deadbolts
159/665/784/785/984/985	Double Cylinder Deadbolts
905	Keyless Touchpad Deadbolt
912/916/954	Home Connect Deadbolt and Lever
260/270/907/915/917/955	Electronic Single Cylinder Deadbolt and Lever
942	Bluetooth Enabled Deadbolt
938/939	WiFi Enabled Deadbolt
953	Keyless Touchscreen Deadbolt
966/968/971/973	Interior Pack for Kwikset Signature Series Handleset
978	Interior Pack for Montara Handleset

HANDING

To determine the handing of a door face the OUTSIDE of the door. If the hinge is on the left side of the door, the door is left handed (LH). If the hinge is on the right side of the door, the door is right handed (RH).

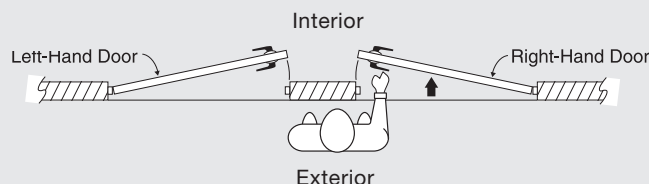

NOTE: Handing required for dummy levers and interior packs with levers when lever design is not symmetric.



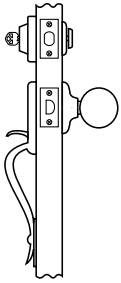
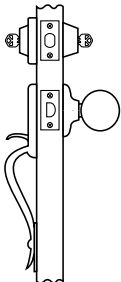
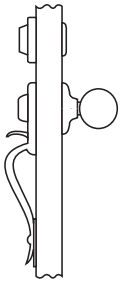
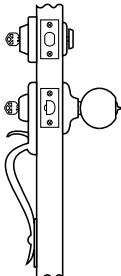

Finish	Description	ANSI/BHMA	Latch	Description
3	Polished Brass	605	WFL	Wide Face Latch 2-1/4" x 1-1/8"
L03	Lifetime Polished Brass	605E	RCAL	Round Corner Adjustable Latch
5	Antique Brass	609	6AL	6-Way Adjustable Latch. All Parts Loose
11P	Venetian Bronze	---	SCAL	Square Corner Adjustable Latch
15	Satin Nickel	619	RFAL	Round Face Adjustable Latch
15A	Antique Nickel	620	RCAL FD*	Round Corner Adjustable 20 Minute UL
26	Polished Chrome	625	SCAL FD*	Square Corner Adjustable 20 Minute UL
26D	Satin Chrome	626	RFAL FD*	Round Adjustable 20 Minute UL
514	Matte Black	---		

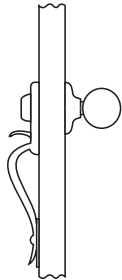
*NOTE: List charge for 20 minute UL is \$2.50

HANDLESETS	Function Name	Description	KWIKSET SIGNATURE	
			KWIKSET w/ BHMA	SERIES w/ BHMA
	Handleset with Single Cylinder Deadbolt	Latch bolt operated by thumb piece outside and grip inside. Deadbolt operated by key outside and thumb turn inside.	687	800, 818
	Handleset with Double Cylinder Deadbolt	Latch bolt operated by thumb piece outside and grip inside. Deadbolt operated by key both sides.	689	
	Dummy Handleset with Dummy Deadbolt	Handle and grip act as a pull only. For inactive leaf of double doors. No operation.	699	802, 819
	Two Point Locking Handleset with Single Cylinder Deadbolt	Latch bolt operated by thumb piece outside and grip inside, except when both are locked by key outside or turn button inside. Deadbolt operated by key outside or thumb turn inside.	N/A	553 F94

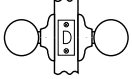
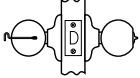
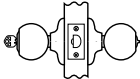
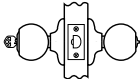
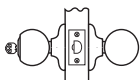
HANDLESETS	Function Name	Description	KWIKSET w/ BHMA	KWIKSET SIGNATURE SERIES w/ BHMA
	Handleset with Knob or Lever	Latch bolt operated by thumb piece outside and grip inside.	898	815
	Handleset Only	Latch bolt operated by thumb piece outside	899	814





KNOBS	Function Name	Description	KWIKSET SIGNATURE	
			KWIKSET w/ BHMA	SERIES w/ BHMA
	Passage/Hall/Closet	Both knobs always free.	200 F75	720/725UL F75
	Privacy/Bed/Bath	Both knobs locked or unlocked by turn button inside. Outside knob unlocked by emergency key.	300 F76	730/735UL F76
	Entry	Both knobs locked or unlocked by key outside or turn button inside.	400 F82	740/745UL F82
	Entry, Free Interior	Outside locked or unlocked by key outside or turn button inside. Inside always free.	401 F81	
	Storeroom/Vestibule	Outside unlocked only while key is turned. Inside always free.	450 F86	750/755UL F86
	Half Dummy Trim, Surface Mounted	For doors where only a pull is required. No operation.	488	788

NOTE: BHMA code in italics. Optional UL 1/3 hour rating for all functions.

LEVERS	Function Name	Description	KWIKSET w/ BHMA	KWIKSET SIGNATURE SERIES w/ BHMA
	Passage/Hall/Closet	Both levers always free.	200/407/420UL F75	720/725/725UL F75
	Privacy/Bed/Bath	Both levers locked or unlocked by turn button inside. Outside lever unlocked by emergency key.	300/408UL/430UL F76	730/735UL F76
	Keyed Entry Lever	Both levers locked or unlocked by key outside or turn or push button inside.	401/405/406UL F82	740/745/756UL F82
	Entry, Free Interior	Outside locked or unlocked by key outside or turn button inside. Inside always free.	401/406/413UL F81	
	Storeroom/Vestibule	Outside unlocked only while key is turned. Inside always free.	439/450/462/412UL F86	750/755UL/781 F86
	Half Dummy Trim, Surface Mounted	For doors where only a pull is required. No operation.	488	788

NOTE: BHMA code in italics. Optional UL 1/3 hour rating for all functions.

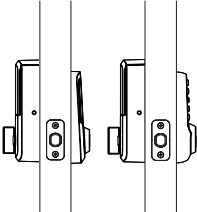
DEADBOLTS	Function Name	Description	KWIKSET w/ BHMA	KWIKSET SIGNATURE SERIES w/ BHMA
	Single Cylinder	Deadbolt operated by key outside and thumb turn inside.	660 E0153	980/982UL E0151 780/782UL 816/817UL E0152 158/258
	Double Cylinder	Deadbolt operated by key both sides.	665/E0143	985/984UL E0141 785/784UL E0142 159 E0152
	Thumb Turn Only	Deadbolt operated by thumb turn one side. No trim on exterior.	663 E0193	N/A

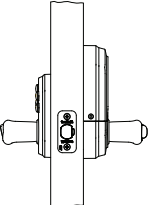
DEADBOLTS		Function Name	Description	KWIKSET w/ BHMA	KWIKSET SIGNATURE SERIES w/ BHMA
		Conversion Kit	Converts 663 to 667 when door is bored through.	664	N/A
		Thumb Turn x Plate	Deadbolt operated by thumb turn on interior. Blank plate on exterior.	667/677UL E01113	N/A
		Single Cylinder Gatelatch	Deadbolt operated by key outside and thumb turn inside.	N/A	598
ELECTRONIC DEADBOLTS		Function Name	Description	KWIKSET w/ BHMA	KWIKSET SIGNATURE SERIES w/ BHMA
		Halo™	Deadbolt operated by key outside, electronic keypad or WiFi enabled device.	N/A	938/939 E0152
		Aura™	Deadbolt operated by key outside, electronic keypad or bluetooth enabled device.	N/A	942 E0152
		SmartCode™ Deadbolt	Deadbolt operated by key outside or electronic keypad and thumb turn inside.	N/A	260/270/915
		SmartCode™ Lever	Keyed lever operated by key outside or electronic keypad and thumb turn inside.	N/A	917/955

NOTE: BHMA code in italics

ROUND POCKET

DOOR LOCK

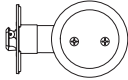
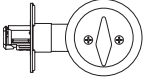
	Function Name	Description	KWIKSET w/ BHMA	KWIKSET SIGNATURE SERIES w/ BHMA
	Passage	Pocket door lock always free.	334	N/A
	Privacy	Pocket door lock operated by thumb turn.	335	N/A

LIGHT COMMERCIAL

LEVER

	Function Name	Description	LIGHT COMMERCIAL w/ BHMA
	Passage/Hall/Closet	Both levers always free.	407/720/721/725UL F75
	Privacy/Bed/Bath	Both levers locked or unlocked by ADA turn button inside. Outside lever unlocked by emergency key.	408/730/733/735UL F76
	Entry	Both levers locked or unlocked by key outside or ADA turn button inside.	409/410/438/740/745UL/756 F82
	Entry, Free Interior	Outside locked or unlocked by key outside or turn button inside. Inside always free.	401/406/413
	Storeroom/Vestibule	Outside unlocked only while key is turned. Inside always free.	412/439/750/755UL/781 F86
	Half Dummy Trim, Surface Mounted	For doors where only a pull is required. No operation.	788

NOTE: BHMA code in italics

METAL

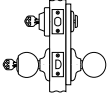
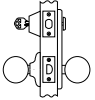
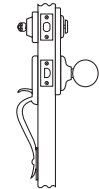
INTERCONNECT	Function Name	Description	METAL INTERCONNECT Model w/BHMA
	Deadlock Latch	Operated by grip either side except when locked by key outside and thumb turn inside. Deadbolt operated by key outside and thumb turn inside. Inside grip simultaneously retracts dead latch and deadbolt latch.	505/506UL F97
	Plain Latch	Operated by grip either side. Deadbolt operated by key outside and thumb turn inside. Inside grip simultaneously retracts plain latch and deadbolt latch.	508
	Interior Assembly Only	Grip inside simultaneously retracts plain latch and deadbolt latch when matched with handleset on outside.	502

NOTE: BHMA code in italics

BOX PACK	Unit					Master Case			
	Quantity	Length (in.)	Width (in.)	Height (in.)	Weight (lbs.)	Quantity	Length (in.)	Width (in.)	Height (in.)
Kwikset Signature Series									
Deadbolts									
780 Single Cylinder	1	4.6730	3.9230	3.0720	2.2500	12	12.8750	12.5000	5.3125
785 Double Cylinder	1	4.6730	3.9230	3.0720	2.7500	12	12.8750	12.5000	5.3125
816 Key Control	1	4.6730	3.9230	3.0720	2.2500	12	12.8750	12.5000	5.3125
816 SQT Key Control Deadbolt	1	4.92	4.13	3.15	2.02	12	12.99	13.19	5.51
980 Single Cylinder	1	4.6730	3.9230	3.0720	2.2500	12	12.8750	12.5000	5.3125
985 Double Cylinder	1	4.6730	3.9230	3.0720	2.7500	12	12.8750	12.5000	5.3125
158 Single Cylinder	1	4.6730	3.9230	3.0720	2.2500	12	12.8750	12.5000	5.3125
159 Single Cylinder	1	4.6730	3.9230	3.0720	2.7500	12	12.8750	12.5000	5.3125
258 Single Cylinder	1	4.81	4.06	3.13	1.76	12	13.37	12.9	6.21
Electronic Deadbolts/Levers									
SmartCode 260 TRL	1	4.213	5.353	9.913	3.290	2	10.557	9.180	6.213
SmartCode 260 CNT	1	4.213	5.353	9.913	3.343	2	10.557	9.180	6.213
SmartCode 270 TRL	1	4.213	5.353	9.913	3.307	2	10.557	9.180	6.213
SmartCode 270 CNT	1	4.213	5.353	9.913	3.373	2	10.557	9.180	6.213
905 Powerbolt	1	8	3.75	3.5	2	2	8.5	7.5	4.25
907 Powerbolt	1	5.51	3.54	9.29	2.93	2	5.75	7.87	10.16
912 SmartCode Lever	1	3.5	6	10	61	2	7	12.5	10.4
915/916/938/939/942 SmartCode	1	3.5	5.38	9.88	3.14	2	10.50	7.75	5.94
916 / 954	1	9.75	4.0	4.28	3.12	1	10.25	4.63	4.44
916 / 954	1	5.32	5.79	8.86	4.40	2	11.42	6.69	10.24
959 Halo Touch	1	4.19	5.40	9.83	3.76				
Handlesets									
553 Single Cylinder	1	15.9380	7.1250	4.0000	6.2500	4	16.4380	15.9380	7.8125
800 AUH Austin	1	15.9380	7.1250	4.0000	7.0000	4	16.4380	15.9380	7.8125
802 AUH Austin	1	15.9380	7.1250	4.0000	6.5000	4	16.4380	15.9380	7.8125
800ADH Ashfield, 800AVH Avalon	1	15.9380	7.1250	4.0000	7.0000	4	16.4380	15.9380	7.8125
802ADH Ashfield, 802AVH Avalon	1	15.9380	7.1250	4.0000	6.5000	4	16.4380	15.9380	7.8125
800AN Arlington	1	15.9380	7.1250	4.0000	7.0000	4	16.4380	15.9380	7.8125
802AN Arlington	1	15.9380	7.1250	4.0000	6.5000	4	16.4380	15.9380	7.8125
800CE Chelsea	1	15.9380	7.1250	4.0000	6.0000	4	16.4380	15.9380	16.6255
802CE Chelsea	1	15.9380	7.1250	4.0000	5.5000	4	16.4380	15.9380	16.6255
800HE Hawthorne	1	15.9380	7.1250	4.0000	7.0000	4	16.4380	15.9380	7.8125
802HE Hawthorne	1	15.9380	7.1250	4.0000	5.0000	4	16.4380	15.9380	7.8125
800SE Shelburne	1	15.9380	7.1250	4.0000	7.9000	4	16.4380	15.9380	7.8125
802SE Shelburne	1	15.9380	7.1250	4.0000	5.9000	4	16.4380	15.9380	7.8125
800 Tavaris	1	15.9380	7.1250	4.0000	8.0000	4	16.4380	16.6200	8.3800
802 Tavaris	1	15.9380	7.1250	4.0000	8.0000	4	16.4380	16.6200	8.3800
818 Prescott	1	16.143	7.293	3.75	4.281	4	16.339	15.945	7.677
818 Prague	1	16.142	7.283	3.937	4.079	4	16.142	16.142	7.874
966 Single Cylinder	1	2.7	3.7	4.30	2.25	12	15.20	12.5	7
968 Dummy	1	2.7	3.7	4.30	2.25	12	15.20	12.5	7
978 Single Cylinder	1	2.7	3.7	4.30	2.25	12	15.20	12.5	7

BOX PACK	Unit					Master Case			
	Quantity	Length (in.)	Width (in.)	Height (in.)	Weight (lbs.)	Quantity	Length (in.)	Width (in.)	Height (in.)
Kwikset Signature Series Continued									
Knobs									
720 Passage	1	8.1730	3.9230	2.7840	2.0000	12/30	12.3750	11.5000	8.8125
730 Privacy	1	8.1730	3.9230	2.7840	2.0000	12/30	12.3750	11.5000	8.8125
740 Entry	1	8.1730	3.9230	2.7840	2.3300	12/30	12.3750	11.5000	8.8125
788 Dummy	1	3.2360	2.7980	3.0100	0.3500	20	14.8750	12.5000	3.9375
Levers									
720 Passage	1	7.8750	6.1250	3.1875	2.4200	12/20	19.7500	12.8750	8.5625
730 Privacy	1	7.8750	6.1250	3.1875	2.4200	12/20	19.7500	12.8750	8.5625
740 Entry	1	7.8750	6.1250	3.1875	2.4200	12/20	19.7500	12.8750	8.5625
788 Dummy	1	5.8610	3.1100	2.8220	0.4500	20	15.8750	12.1250	6.6245
720 TNL	1	6.625	5.75	3.0	1.65	20	24	15.50	6.70
730 TNL	1	6.625	5.75	3.0	1.70	20	24	15.50	6.85
740 TNL	1	6.625	5.75	3.0	2.05	20	24	15.50	8.30
788 TNL	1	5.861	3.11	2.822	0.450	20	15.875	12.125	6.6245
Kwikset									
Combo Packs									
690T Tylo Knob and Single Cylinder Deadbolt	1	11.3090	3.4230	2.7840	2.8000	6	8.7500	7.3120	11.9375
Deadbolts									
598 Single Cylinder Gate Latch	1	4.6730	3.9230	3.0720	2.2500	12	12.8750	12.5000	5.3125
660 Single Cylinder	1	3.9480	3.4230	2.5720	0.5000	12	11.1250	11.0000	4.5625
665 Double Cylinder	1	3.9480	3.4230	2.5720	0.9000	12	11.1250	11.0000	4.5625
663 One-Sided	1	3.9480	3.4230	2.5720	0.5500	12	11.1250	11.0000	4.5625
667 One-Sided	1	3.9480	3.4230	2.5720	0.9000	12	11.1250	11.0000	4.5625
664 Retrofit Kit	1	3.9480	3.4230	2.5720	0.9000	12	11.1250	11.0000	4.5625
677 One-Sided	1	3.9480	3.4230	2.5720	0.2500	12	11.1250	11.0000	4.5625
Handlesets									
604 Single Cylinder	1	5.8000	3.9000	3.7000	2.25	12	15.20	12.5	7
687 LIP	1	15.9380	7.1250	4.0000	3.6000	6	15.0000	12.1250	16.6255
689 LIP	1	15.9380	7.1250	4.0000	4.0000	6	15.0000	12.1250	16.6255
699 LIP	1	15.9380	7.1250	4.0000	3.6000	6	15.0000	12.1250	16.6255
Knobs									
200 Polo	1	8.1730	3.2980	2.7840	1.3000	30	17.1250	17.0000	8.8125
300 Polo	1	8.1730	3.2980	2.7840	1.3000	30	17.1250	17.0000	8.8125
400 Polo	1	8.1730	3.2980	2.7840	1.3000	30	17.1250	17.0000	8.8125
200 Tylo/Cove	1	7.3610	3.2980	2.7840	1.1500	30	17.1250	17.0000	8.1870
300 Tylo/Cove	1	7.3610	3.2980	2.7840	1.1500	30	17.1250	17.0000	8.1870
400 Tylo/Cove	1	7.3610	3.2980	2.7840	1.1500	30	17.1250	17.0000	8.1870
488 Dummy	1	3.2360	2.7980	3.0100	0.3500	20	14.8750	12.5000	3.9375
Lever									
200 Passage	1	6.7980	5.7660	2.9720	1.3500	20	23.6250	15.3750	7.4995
300 Privacy	1	6.7980	5.7660	2.9720	1.3500	20	23.6250	15.3750	7.4995
405 Keyed Lever	1	6.7980	5.7660	2.9720	1.5800	20	23.6250	15.3750	7.4995
488 Dummy	1	5.8610	3.1100	2.8220	0.4500	20	15.8750	12.1250	6.6245
Miscellaneous									
Pocket Door Hardware									
334 Passage	1	4.3750	3.0000	2.0000	.65	12	12.5000	14.3750	2.2500
335 Privacy	1	4.3750	3.0000	2.0000	.8	12	12.5000	14.3750	2.2500

BOX PACK	Unit					Master Case			
	Quantity	Length (in.)	Width (in.)	Height (in.)	Weight (lbs.)	Quantity	Length (in.)	Width (in.)	Height (in.)
Kwikset Multi-Family / Light Commercial									
Burbank, Carson, and Palmina									
407	1	6.75	5.75	2.75	0.5	1	7.93	6.06	3.12
408	1	6.75	5.75	2.75	0.5	1	7.93	6.06	3.12
438	1	6.75	5.75	2.75	1.0	1	7.93	6.06	3.12
439	1	6.75	5.75	2.75	1.0	1	7.93	6.06	3.12
488	1	5.18	3.00	2.43	0.55	1	15.75	12.00	6.56
Kingston									
721KNL	1	6.75	5.75	2.75	1.5	1	7.93	6.06	3.12
733KNL	1	6.75	5.75	2.75	1.5	1	7.93	6.06	3.12
756KNL SMT	1	6.75	5.75	2.75	2.33	1	7.93	6.06	3.12
781KNL SMT	1	6.75	5.75	2.75	2.33	1	7.93	6.06	3.12
788 LVR	1	5.18	3.00	2.43	0.87	1	15.13	12.75	3.50
SmartKey Padlock									
50MM SmartKey Padlock Std. Shackle	6	2.56	1.46	4.65	1.10	6	5.39	4.80	5.04
50MM SmartKey Padlock Long Shackle	6	2.56	1.46	4.65	1.14	6	5.39	4.80	5.04



Customer Service Toll Free Line:

(800) 422-LOCK (800) 422-5625

FAX (866) 507-8369

email: kworders@spectrumbands.com

Monday to Friday, 6:00 a.m. to 4:00 p.m. PST

Date: _____ Delivery Address: _____ Contact: _____

PO Number: _____ Phone: _____ Company Name: _____

Job Name: _____ Fax: _____ Address: _____

Notes: _____ Store Number: _____

Line No.	Function		Style		Handing		Rose		Finish		OPTIONS					Price	Extended Price
	Exterior	Interior	Exterior	Interior	Exterior	Interior	Exterior	Interior	Exterior	Interior	Latch	Strike	Cylinder	Keying	Quantity		
1																	
2																	
3																	
4																	
5																	
6																	
7																	
8																	
9																	
10																	
11																	
12																	
13																	
14																	
15																	
16																	
17																	
18																	
19																	
20																	

1326425-01/23

To order service parts, provide service part # and quantity.
How to order questions, refer back to page A:3 for General Information.

Kwikset



SMARTCODE 260

KEYPAD ELECTRONIC LOCK

MICROBAN
ANTIMICROBIAL TECHNOLOGY

SMARTKEY
SECURITY™

The SmartCode™ 260 Keypad Electronic Deadbolt offers a sleek 10-button design, Microban® Antimicrobial Technology protection and the convenience of one-touch locking. This keyless deadbolt comes in a traditional or contemporary design, which perfectly complements the Kwikset Prescott and San Clemente handlesets.

Features

- The responsive keypad provides bright LED illumination for easy code access
- Fast motorized deadbolt with one-touch locking
- Auto-locking after 30 seconds or select custom auto-lock time delay
- Protected with Microban® Antimicrobial Technology built into the keypad and finish

User Codes

- Up to 50 user codes for family, guests and service professionals
- Programming code for improved access code management



#1 SELLING U.S. LOCK BRAND*

*Source: TraQline US quarterly brand unit share report, Q4 2006 through Q1 2021

B1

Specifications

Battery	Uses 4 x AA 6V alkaline cell batteries with approximately 1 year battery life
Function	Single cylinder deadbolt
Door Prep	1 1/2" (38mm) or 2 1/8" (54mm) diameter cross bore hole and 1" diameter edge bore hole
Backset	Adjustable 2 3/8" (60mm) or 2 3/4" (70mm)
Door Thickness	1 3/8" (35mm) to 1 3/4" (44mm) standard. Thick door service part available for 2-1/4" (57mm) thick doors
Faceplates	1" (25 mm) x 2 1/4" (57 mm) round corner faceplate with drive-in collar standard
Strikes	2 3/4" (70mm) x 1 1/8" (29mm) round corner 4 hole strike
Bolt	1" (25mm) throw, steel bolt with anti-saw security pin
Door Handing	Reversible
Cylinder	SmartKey Security™ with 2 KW1 keys
Temperature Range	Exterior: -40°F to 150°F (-40°C to 66°C) Interior: 32°F to 130°F (0°C to 54°C)
Humidity	Exterior: 100% condensing Interior: 30% to 95% non-condensing
Codes	Up to 50 user codes and 10 one-time user codes with optional programming code

Dimensions

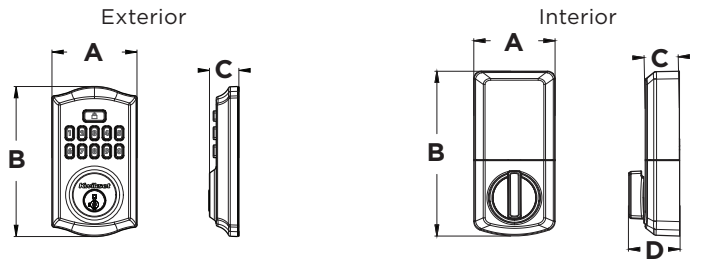

Traditional

Design	A	B	C	D
Exterior	2 13/16" (71 mm)	5" (127 mm)	1" (25 mm)	---
Interior	2 3/4" (70 mm)	5 1/2" (140 mm)	1 1/8" (29 mm)	1 11/16" (43 mm)

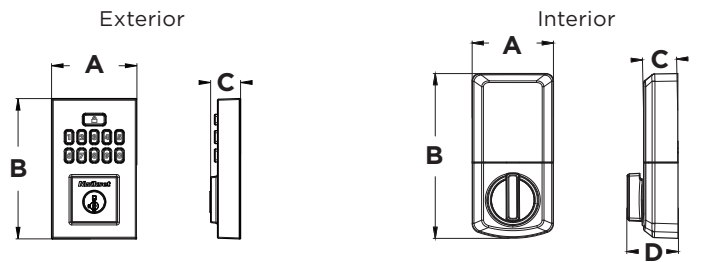

Contemporary

Design	A	B	C	D
Exterior	2 3/4" (70 mm)	4 9/16" (116 mm)	1" (25 mm)	---
Interior	2 3/4" (70 mm)	5 1/2" (140 mm)	1 1/8" (29 mm)	1 11/16" (43 mm)

Easy Installation

- Replaces existing door hardware with just a Phillips screwdriver
- No hard wiring needed and fits all standard doors
- Download the free **BILT** app featuring 3D instructions for quick and easy installation

Innovative Security

- BHMA Grade 2 certified
- 20 Minute fire rating - UL certified
- Featuring SmartKey Security™

Finishes



992600-001
Polished Brass **L03**
260 TRL L03



992600-002
Satin Nickel **15**
260 TRL 15



992600-003
Venetian Bronze **11P**
260 TRL 11P



992600-004
Satin Nickel **15**
260 CNT 15



992600-005
Polished Chrome **26**
260 CNT 26



992600-006
Matte Black **514**
260 CNT 514

FINISH AND
LIFETIME WARRANTY*
MECHANICAL

ONE YEAR
ELECTRONIC WARRANTY*

*See kwikset.com/support/warranty for the lifetime limited mechanical and finish warranties and one-year limited electronics warranty.

*Consulte kwikset.com/support/warranty para ver las garantías mecánicas y de acabado limitadas de por vida y la garantía limitada de un año de los electrónicos.

Kwikset



SMARTCODE 270™

TOUCHPAD ELECTRONIC LOCK



The SmartCode™ 270 Touchpad Electronic Deadbolt combines touchpad tactile feedback with bright LED illumination for easy code access. This keyless deadbolt comes in a traditional or contemporary design, which perfectly complements the Kwikset Prescott and San Clemente handlesets.

Features

- The responsive touchpad offers sleek style with a large and bright LED to communicate lock status
- Fast motorized deadbolt with one-touch locking
- Auto-locking after 30 seconds or select custom auto-lock time delay

User Codes

- Up to 50 user codes for family, guests and service professionals
- Programming code for improved access code management



#1 SELLING U.S. LOCK BRAND*

*Source: TraQLine US quarterly brand unit share report, Q4 2006 through Q2 2022

B3

Specifications

Battery	Uses 4 x AA 6V alkaline cell batteries with approximately 1 year battery life
Function	Single cylinder deadbolt
Door Prep	1 1/2" (38mm) or 2 1/8" (54mm) diameter cross bore hole and 1" diameter edge bore hole
Backset	Adjustable 2 3/8" (60mm) or 2 3/4" (70mm)
Door Thickness	1 3/8" (35mm) to 1 3/4" (44mm) standard. Thick door service part available for 2-1/4" (57mm) thick doors.
Faceplates	1" (25 mm) x 2 1/4" (57 mm) round corner faceplate with drive-in collar standard
Strikes	2 3/4" (70mm) x 1 1/8" (29mm) round corner 4 hole strike
Bolt	1" (25mm) throw, steel bolt with anti-saw security pin
Door Handing	Reversible
Cylinder	SmartKey Security™ with 2 KW1 keys
Temperature Range	Exterior: -40°F to 150°F (-40°C to 66°C) Interior: 32°F to 130°F (0°C to 54°C)
Humidity	Exterior: 100% condensing Interior: 30% to 95% non-condensing
Codes	Up to 50 user codes and 10 one-time user codes with optional programming code

Dimensions

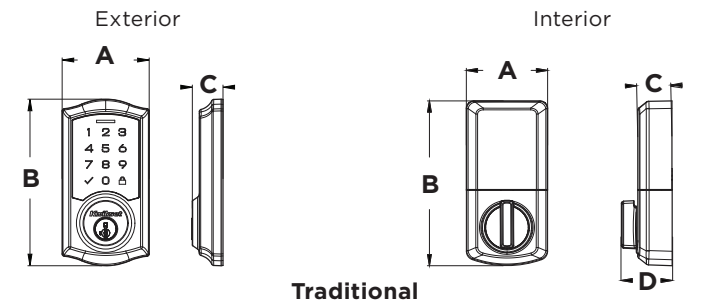

Design	A	B	C	D
Exterior	2 13/16" (71 mm)	5 3/8" (137 mm)	1" (25 mm)	---
Interior	2 3/4" (70 mm)	5 1/2" (140 mm)	1 1/8" (29 mm)	1 11/16" (43 mm)

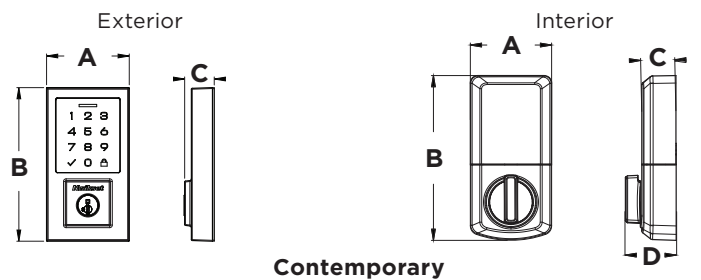

Design	A	B	C	D
Exterior	2 3/4" (70 mm)	5 3/16" (132 mm)	1" (25 mm)	---
Interior	2 3/4" (70 mm)	5 1/2" (140 mm)	1 1/8" (29 mm)	1 11/16" (43 mm)

Easy Installation

- Replace existing door hardware with just a Phillips screwdriver
- No hard wiring needed and fits all standard doors
- Download the free **BILT** app featuring 3D instructions for quick and easy installation

Innovative Security

- BHMA Grade 2 certified
- 20 Minute fire rating - UL certified
- Featuring SmartKey Security™

Finishes



992700-002
Satin Nickel 15
270 TRL 15



992700-003
Venetian Bronze 11P
270 TRL 11P



992700-004
Satin Nickel 15
270 CNT 15



992700-005
Matte Black 514
270 CNT 514

FINISH AND
LIFETIME WARRANTY*
MECHANICAL

ONE YEAR
ELECTRONIC WARRANTY*

*See kwikset.com/support/warranty for the lifetime limited mechanical and finish warranties and one-year limited electronics warranty.

*Consulte kwikset.com/support/warranty para ver las garantías mecánicas y de acabado limitadas de por vida y la garantía limitada de un año de los electrónicos.

Kwikset



SAN CLEMENTE RECTANGULAR TRIM HALIFAX™ LEVER & 258 LOW PROFILE DEADBOLT

Introducing the contemporary San Clemente Rectangular Trim - Available with the Halifax lever and the 258 Low Profile Deadbolt. These new products bring sophistication and a modern design with clean lines in a bold rectangular trim. The Halifax lever with the San Clemente rectangular trim features a new chassis with superior feel and anti-lever sag. Pair with any contemporary mechanical or electronic deadbolt. The San Clemente rectangle deadbolt features our advanced SmartKey Security™ technology and highest residential security/durability/finish. Pair our rectangular deadbolt with our Halifax rectangular lever or San Clemente handle.

#1 SELLING U.S. LOCK BRAND*

*Source: TraQline US quarterly brand unit share report, Q4 2006 through Q1 2021

Kwikset

Mix & Match

Pair any contemporary mechanical or electronic deadbolt with the San Clemente handle or Halifax™ Rectangle trim.



SAN CLEMENTE LOW PROFILE RECTANGLE DEADBOLT

Signature Series

Specifications

Function	258 RCT SMT Keyed Entry Single Cylinder
Standard Door Prep	Cross Bore 2 1/8", Edge Bore 1". Latch Face 1 1/8" x 2 3/4".
Door Thickness	1 3/8" - 1 3/4" Standard. Thick door service part available for up to 2 1/2".
Cylinder	SmartKey Security™
Faceplate	1" x 2 1/4"
Strike	1 1/8" x 2 3/4"
Bolt	1" Throw
ANSI/BHMA	Grade AAA Certified: Finish/Durability/Security
ADA	258 functions are in compliance with the American National Standards Institute (ANSI A117.1)
UL	Optional 20 Minute UL fire rating available, except inactive functions.
Warranty	Lifetime Mechanical and Lifetime Finish

Dimensions

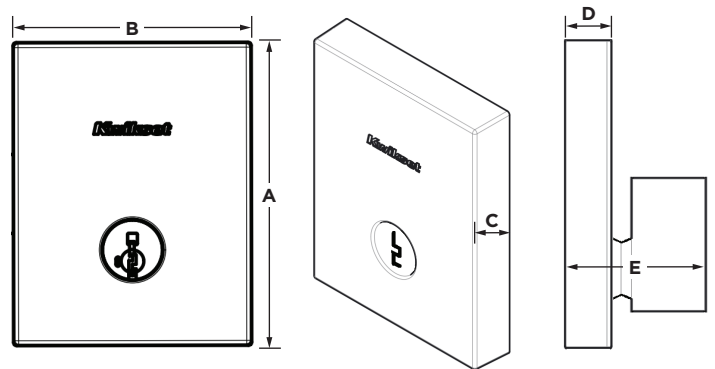

Design	A	B	C	D	E
San Clemente RCT SMT	3 9/16"	2 3/4"	9/16"	1/2"	1 15/32"

- ANSI/BHMA Grade AAA Certified
- Easy to Install
- Sleek Low Profile Deadbolt Design
- New, Bold, Rectangular Trim
- Contemporary Design with Clean Lines

Finishes



99.9% Cleaner
Than Unprotected Surface

Unprotected Surface Protected with Microban

MICROBAN
ANTIMICROBIAL TECHNOLOGY

PROTECTION THAT LIVES ON

Kwikset with Microban® inhibits growth of damaging bacteria, providing you with a cleaner home.

How to re-key in seconds

1. Insert current key and rotate it 90° clockwise.
2. Fully insert SmartKey tool. Remove tool and remove current key.
2. Fully insert new key and rotate 180°. Rotate back to starting position and remove key. **Your lock is now re-keyed!**



! You must have the working key to rekey the lock



1326425-01/23

HALIFAX™ RECTANGLE LEVER

Signature Series

Specifications

Door Prep	Cross Bore 2 1/8". Edge Bore 1". Latch Face 1" x 2 1/4".
Backset	Adjustable 2 3/8" or 2 3/4"
Door Thickness	1 3/8" - 1 3/4" Doors standard Thick door service part available for up to 2 1/8"
Cylinder	SmartKey Security™
Faceplates	1" x 2 1/4" Specify round corner, square corner or drive-in
Strikes	2 1/4" Full lip round

Bolt	1/2" Throw
ANSI/BHMA	Grade AAA Certified: Finish/Durability/Security
UL	Optional 20 Minute UL fire rating available, except inactive functions.
Door Handing	Reversible for right or left hand doors
ADA	720 & 730 functions are in compliance with the American national Standards Institute (ANSI A117.1)
Warranty	Lifetime Mechanical and Lifetime Finish

Functions

- 

Passage/Hall/Closet: Both levers always free.
- 720 HFL RCT
- 

Privacy/Bed/Bath: Both levers locked or unlocked by push-button inside. Outside lever unlocked by emergency key.
- 730 HFL RCT
- 

Keyed Entry Lever: Both sides locked or unlocked by key outside or turn-button inside.
- 740 HFL RCT
- 

Half Dummy Trim, Surface Mounted:
For doors where only a pull is required. No operation.
- 788 HFL RCT
- 

Interior Pack: Inside lever of handleset.
800 Handlesets:
- 973 HFL RCT: Dummy
818 Handlesets:
- 971 HFL RCT: Single-Cylinder

Dimensions

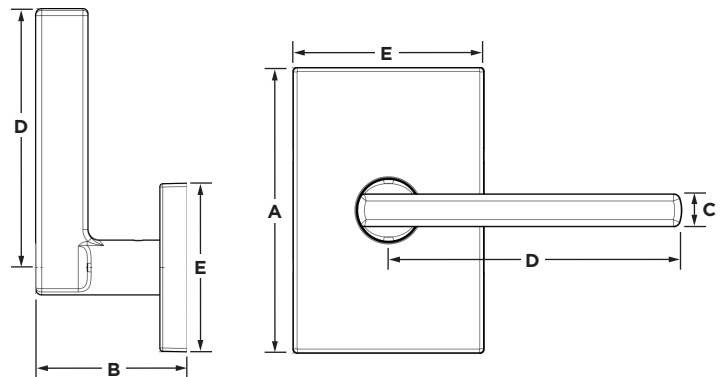

Design	A	B	B (Keyed)	C	D	E
Halifax™ RCT	4 1/8"	2 1/2"	2 9/16"	7/16"	4 1/4"	2 25/32"

- ANSI/BHMA Grade AAA Certified
- Easy to Install
- Best-in-class Lever Chassis
 - Significantly Reduced Lever Sag
 - Greater Feel
- New, Bold, Rectangular Trim



Finishes



Satin Nickel / 15

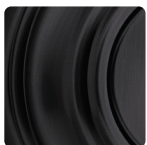

Matte Black 514



Polished Chrome 26



Halifax™ Rectangle Lever SmartKey Security™ in Polished Chrome



Halifax™ Rectangle Passage Lever in Matte Black

Kwikset



KATELLA LEVER

The Katella lever is the perfect lever for those looking to update their home hardware from a traditional home to a more transitional style. Katella provides that custom look you desire but at an affordable price. Featuring the advance SmartKey Security™ technology where if you ever need it, you can re-key your lock yourself in seconds. Katella also includes, on specific finishes, Microban® Antimicrobial product protection that inhibits the growth of surface bacteria, providing a cleaner door hardware and 99% cleaner than unprotected surfaces.

- ANSI/BHMA Grade AAA Certified
- Easy to install
- Best-in-class lever chassis
 - Significantly reduced lever sag
 - Greater feel
- Push button privacy locking



Signature Series



Katella Passage Lever with round rose in Matte Black



Katella Privacy Lever with round rose in Satin Nickel

#1 SELLING U.S. LOCK BRAND*

*Source: TraQline US quarterly brand unit share report, Q4 2006 through Q1 2021

Specifications

Door Prep	Cross Bore 2 1/8". Edge Bore 1". Latch Face 1" x 2 1/4".
Backset	Adjustable 2 3/8" or 2 3/4"
Door Thickness	1 3/8" - 1 3/4" Doors standard Thick door service part available for up to 2 1/8"
Cylinder	SmartKey Security™
Faceplates	1" x 2 1/4" Specify round, square and drive-in
Strikes	2 1/4" full lip round.

Bolt	1/2" Throw
ANSI/BHMA	Grade AAA Certified: Finish/Durability/Security
UL	N/A
Door Handing	Reversible for right or left hand doors
ADA	720 & 730 functions are in compliance with the American National Standards Institute (ANSI A117.1)
Warranty	Lifetime Mechanical and Lifetime Finish

Functions

- 

Passage/Hall/Closet: Both levers always free.
- 720KAL

- 

Privacy/Bed/Bath: Both levers locked or unlocked by push-button inside. Outside lever unlocked by emergency key.
- 730KAL

- 

Keyed Entry Lever: Both sides locked or unlocked by key outside or turn-button inside.
- 740KAL SMT

- 

Half Dummy Trim, Surface Mounted:
For doors where only a pull is required. No operation.
- 788KAL

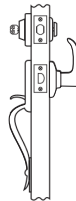
- 

Interior Pack: Inside lever of handleset.
800 Handlesets:
- 966KAL SMT: Single Cylinder
818 Handlesets:
- 971KAL SMT: Single Cylinder

Dimensions

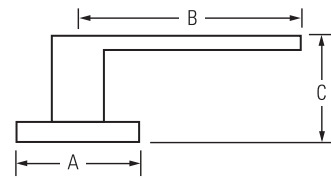

Design	A	B	C	C (Keyed)
Katella	2 21/32"	4 1/4"	2 15/32 "	2 9/16"

Finishes



Satin Nickel 15



Matte Black 514



Garantía de por vida



Katella Entry Lever SmartKey Security™ with Round Rose in Satin Nickel



Katella Entry Lever SmartKey Security™ with Round Rose in Matte Black

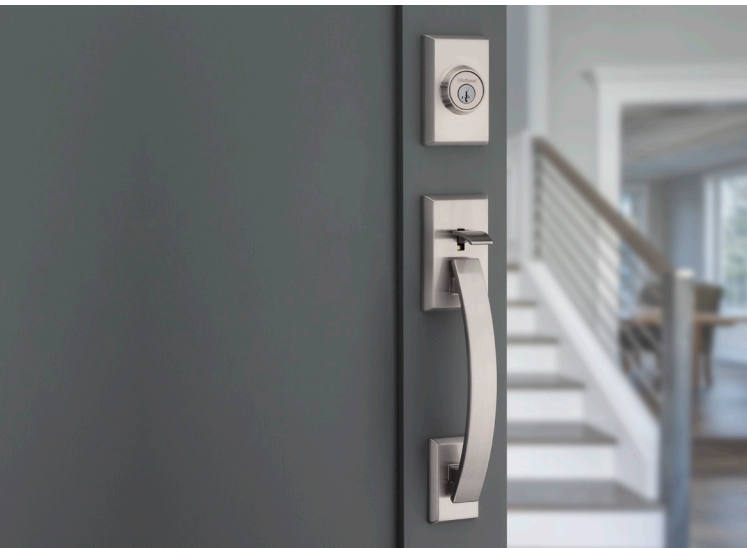

Signature Series

Superior Security Features

- ANSI/BHMA Grade 1 Certified 980/985 Deadbolt
- SmartKey Security - providing superior security against advanced break-in techniques.

Elegant Styles And Finishes

- Traditional to Contemporary Styles

Warranty

- Lifetime Mechanical
- Lifetime Finish



Arlington® Ashfield™ Austin™ Avalon™ Chelsea® Hawthorne



Uptown 258 Deadbolt Downtown 258 Deadbolt Midtown 258 Deadbolt
Halifax 158/159 Deadbolt San Clemente Rectangular Deadbolt

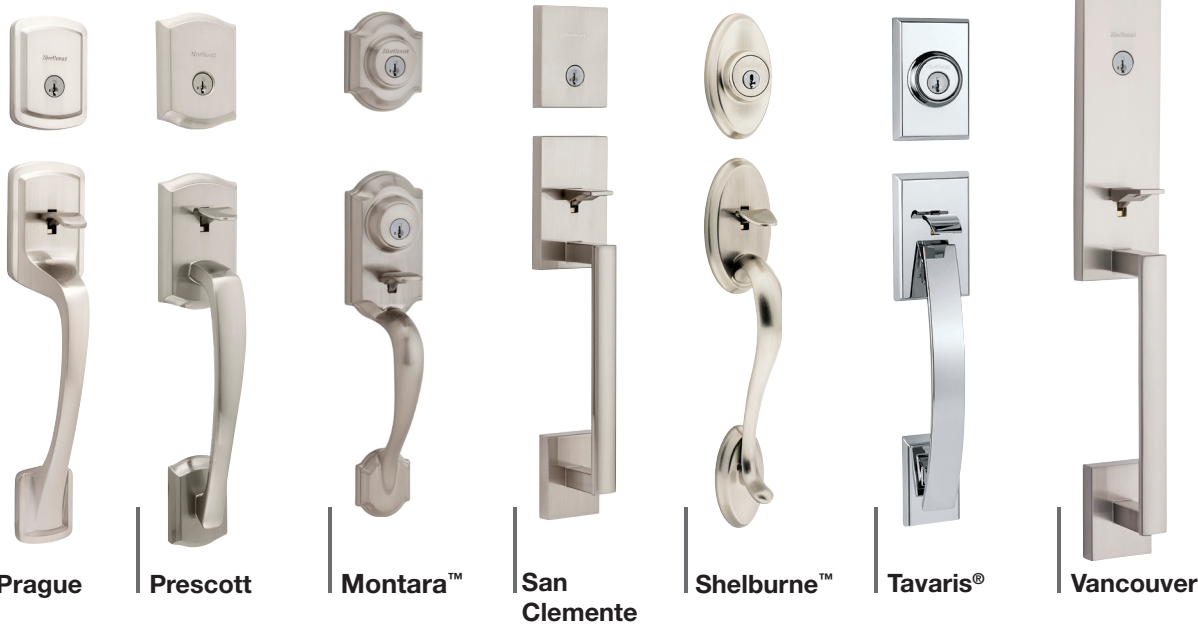

Prague Prescott Montara™ San Clemente Shelburne™ Tavaris® Vancouver



Milan 158/159 Deadbolt
780/785 Deadbolt
980/985 Deadbolt

1326425-01/23



Singapore

Signature Series



| Abbey®



| Arroyo



| Hancock®



| Laurel®



| Pismo



| Ashfield™



| Commonwealth®



| Halifax®



| Halifax®
San Clemente Trim



| Katella



| Lisbon



| Milan®



| Montreal



| Pembroke™



| Singapore



| Tripoli



| Tustin®

Vancouver



Prague



San Clemente



Ashfield™



Vancouver	Model	Function	Finish								Case	
			3	L03	5	11P	15	15A	26	26D	514	Qty
818VNH SMT	Single Cylinder					\$340.20	\$340.20		\$340.20		\$351.50	4
819VNH	Dummy				\$306.20	\$306.20		\$306.20		\$317.50	4	

* 818 VNH available only as standard configuration of 6AL RCS & 5303 (Round Corner Full Lip Strike)

Prague	Model	Function	Finish								Case	
			3	L03	5	11P	15	15A	26	26D	514	Qty
818PGH SMT	Single Cylinder					\$327.80	\$327.80		\$327.80		\$339.10	4
819PGH	Dummy				\$293.80	\$293.80		\$293.80		\$305.10	4	
814PGH	Handle Only				\$250.70	\$250.70		\$250.70		\$262.00	4	

San Clemente	Model	Function	Finish								Case	
			3	L03	5	11P	15	15A	26	26D	514	Qty
818SCE SMT	Single Cylinder					\$327.80	\$327.80		\$327.80	\$327.80	\$339.10	4
818SCE SMC	Single Cylinder						\$330.30		\$330.30		\$341.60	4
819SCE	Dummy				\$293.80	\$293.80		\$293.80	\$293.80	\$305.10	4	
814SCE	Handle Only†				\$250.70	\$250.70		\$250.70	\$250.70	\$262.00	4	
815SCE	Handle with Halifax Lever†				\$330.10	\$330.10		\$330.10	\$330.10	\$341.40	4	

Ashfield®	Model	Function	Finish								Case	
			3	L03	5	11P	15	15A	26	26D	514	Qty
800ADH	Single Cylinder					\$314.20	\$314.20				\$325.50	4
800ADH SMT	Single Cylinder				\$314.20	\$314.20				\$325.50	4	
802ADH	Dummy				\$280.20	\$280.20				\$291.50	4	

NOTE: Handlesets ordered LIP only

†Denotes handleset without deadbolt

1326425-01/23



Austin™	Model	Function	Finish								Case		
			3	L03	5	11P	15	15A	26	26D	514	Qty	
	800AUH SMT	Single Cylinder				\$314.20	\$314.20						4
	802AUH	Dummy				\$280.20	\$280.20						4
	814AUH	Handle Only†				\$237.10	\$237.10						4

Avalon™	Model	Function	Finish								Case		
			3	L03	5	11P	15	15A	26	26D	514	Qty	
	800AVH	Single Cylinder				\$314.20	\$314.20				\$325.50		4
	800AVH SMT	Single Cylinder				\$314.20	\$314.20				\$325.50		4
	802AVH	Dummy				\$280.20	\$280.20				\$291.50		4
	814AVH	Handle Only†				\$237.10	\$237.10						4

Montara™	Model	Function	Finish								Case		
			3	L03	5	11P	15	15A	26	26D	514	Qty	
	553MNH SMT	Single Cylinder	\$291.50			\$314.20	\$314.20						4

Shelburne™	Model	Function	Finish								Case		
			3	L03	5	11P	15	15A	26	26D	514	Qty	
	800SE	Single Cylinder				\$296.00	\$296.00						4
	800SE SMT	Single Cylinder				\$296.00	\$296.00						4
	802SE	Dummy				\$262.00	\$262.00						4
	814SE	Handle Only†				\$218.90	\$218.90						4

NOTE: Handlesets ordered LIP only
 †Denotes handleset without deadbolt

Hawthorne



Tavaris®



Prescott



Hawthorne	Model	Function	Finish								Case		
			3	L03	5	11P	15	15A	26	26D	514	Qty	
	800HE	Single Cylinder				\$296.00	\$296.00					\$307.30	4
	800HE SMT	Single Cylinder				\$296.00	\$296.00					\$307.30	4
	800HE SMC	Single Cylinder				\$298.50	\$298.50						4
	802HE	Dummy				\$262.00	\$262.00					\$273.30	4
	814HE	Handle Only†				\$218.90	\$218.90						4

Prescott	Model	Function	Finish								Case		
			3	L03	5	11P	15	15A	26	26D	514	Qty	
	818PTH SMT	Single Cylinder		\$296.00		\$296.00	\$296.00					\$307.30	4
	819PTH	Dummy		\$262.00		\$262.00	\$262.00					\$273.30	4
	814PTH	Handle Only		\$218.90		\$218.90	\$218.90					\$230.20	4
	815PTH	Handleset with Tustin		\$298.30		\$298.30	\$298.30						4
	815PTH	Handleset with Hancock		\$285.70		\$285.70	\$285.70						4

Tavaris®	Model	Function	Finish								Case		
			3	L03	5	11P	15	15A	26	26D	514	Qty	
	800TVH	Single Cylinder				\$296.00	\$296.00		\$296.00	\$296.00			4
	800TVH SMT	Single Cylinder				\$296.00	\$296.00		\$296.00	\$296.00	\$307.30		4
	802TVH	Dummy				\$262.00	\$262.00		\$262.00	\$262.00	\$273.30		4
	814TVH	Handle Only†				\$218.90	\$218.90		\$218.90	\$218.90	\$230.20		4

NOTE: Handlesets ordered LIP only
 †Denotes handleset without deadbolt

Arlington®



Chelsea®



Arlington®	Model	Function	Finish								Case		
			3	L03	5	11P	15	15A	26	26D	514	Qty	
	800AN	Single Cylinder		\$245.00		\$245.00	\$245.00						4
	800AN SMT	Single Cylinder		\$245.00		\$245.00	\$245.00						4
	802AN	Dummy		\$211.00		\$211.00	\$211.00						4
	814AN	Handle Only†		\$167.90		\$167.90	\$167.90						4
	815AN	Handleset with Tustin		\$247.30		\$247.30	\$247.30						6
	815AN	Handleset with Hancock		\$234.70		\$234.70	\$234.70						6

Chelsea®	Model	Function	Finish								Case		
			3	L03	5	11P	15	15A	26	26D	514	Qty	
	800CE	Single Cylinder		\$245.00		\$245.00	\$245.00		\$245.00	\$245.00			4
	800CE SMT	Single Cylinder		\$245.00		\$245.00	\$245.00		\$245.00	\$245.00			4
	800CE SMC	Single Cylinder				\$247.50	\$247.50						4
	802CE	Dummy		\$211.00		\$211.00	\$211.00		\$211.00	\$211.00			4
	814CE	Handle Only†		\$167.90		\$167.90	\$167.90		\$167.90				4
	815CE	Handleset† with Tustin		\$247.30		\$247.30	\$247.30						6
	815CE	Handleset† with Hancock		\$234.70		\$234.70	\$234.70						6

NOTE: Handlesets ordered LIP only
 †Denotes handleset without deadbolt

INTERIOR PACKS FOR TRADITIONAL 800/802 HANDLESETS

Model	Function	Series			
		Signature Lever & Laurel	Signature Knob	Kwiset Lever	Kwikset Knob
966	Single Cylinder	\$81.00	\$67.20	\$72.90	\$59.00
968	Dummy	\$67.20	\$53.40	\$61.60	\$47.70

Handleset Interior Pack Finish Options		3	L03	5	11P	15	15A	26	26D	514	Qty
Kwikset <i>Signature Series</i>	Abbey Knob	•							•		4
	Ashfield Lever				•	•				•	12
	Commonwealth Lever	•			•	•			•	•	4
	Halifax Lever				•	•		•	•	•	12
	Hancock Knob	•			•	•		•	•	•	4
	Katella Lever					○				○	4
	Laurel Knob				•	•		•		•	4
	Lisbon Lever				•	•		•	•	•	12
	Milan Lever				•	•		•	•	•	12
	Montreal Lever				•	•		•	•	•	12
	Pembroke Lever				•	•		•		•	12
	Pismo Knob				•	•		•	•	•	4
	Singapore Lever				•	•		•		•	4
	Tustin Lever	•			•	•		•	•	○	12
	Kwikset	Aliso Knob					•				
Balboa Lever		•			•	•		•	•		4
Breton Lever						•		•		•	12
Casey Lever						•		•		•	12
Cove Knob		•			•	•					4
Delta Lever		•			•	•		•	•		12
Dorian Lever		•			•	•		•	•		12
Ladera RDT Lever					•	•		•	•		12
Ladera SQT Lever						○		○	○	○	12
Polo Knob					•	•	•	•	•		4
Tylo Knob	•				•		•	•		12	

SECTIONAL INTERIOR PACKS FOR LOW PROFILE 818/819 HANDLESETS

Model	Function	Series			
		Signature Lever	Signature Knob	Kwiset Lever	Kwikset Knob
971	Single Cylinder	\$81.00	\$67.20	\$72.90	
973	Dummy	\$67.20	\$53.40	\$61.60	

Handleset Interior Pack Finish Options		3	L03	5	11P	15	15A	26	26D	514	Qty	
Kwikset <i>Signature Series</i>	Arroyo Knob					•		•		•	4	
	Halifax Lever				•	•		•	•	•	4	
	Halifax RCT Lever					•		•		•	4	
	Hancock Knob	•			•	•				•	4	
	Katella Lever					○				○	4	
	Lisbon Lever				•	•		•	•	•	4	
	Milan Lever				•	•		•	•	•	4	
	Montreal Lever				•	•		•	•	•	4	
	Pismo Knob				•	•		•		•	4	
	Singapore Lever				•	•		•	•	•	4	
	Tripoli Lever					•		•		•	4	
	Tustin Lever	•			•	•				•	4	
	Kwikset	Breton Lever					•		•		•	4
		Casey Lever					•		•		•	4

Note: Square (SQT) or Round (RDT) rose options available ○ Only available in 966 or 971 Function

FULL SQUARE INTERIOR PACKS FOR LOW PROFILE 818/819 HANDLESETS



Model	Function	Series			
		Signature Lever	Signature Knob	Kwiset Lever	Kwikset Knob
971 SQF	Single Cylinder	\$92.30			
973 SQF	Dummy	\$78.50			

Handleset Interior Pack Finish Options	3	L03	5	11P	15	15A	26	26D	514	Qty
--	---	-----	---	-----	----	-----	----	-----	-----	-----

Kwikset <i>Signature Series</i>	Halifax Lever				•	•		•		•	4
---	---------------	--	--	--	---	---	--	---	--	---	---

Note: Only square (SQF) rose option available

MONTARA INTERIOR PACKS

Model	Function	Series			
		Signature Lever	Signature Knob	Kwikset Lever	Kwikset Knob
978	Single Cylinder	\$85.60	\$70.50		\$61.30

Montara Handleset Interior Pack Finish Options	3	L03	5	11P	15	15A	26	26D	514	Qty
--	---	-----	---	-----	----	-----	----	-----	-----	-----

Kwikset <i>Signature Series</i>	Juno Knob	•			•	•				12
	Tustin Lever	•			•	•				12
Kwikset	Cove Knob				•	•				12
	Polo Knob				•	•				12
	Tylo Knob	•								12

Ashfield™

	Model	Function	Finish								Case	
			3	L03	5	11P	15	15A	26	26D	514	Qty
	720ADL	Hall/Closet				\$71.40	\$71.40				\$75.00	12
	725ADL	Hall/Closet UL				\$77.40	\$77.40				\$81.00	12
	730ADL	Bed/Bath				\$74.70	\$74.70				\$78.30	12
	735ADL	Bed/Bath UL				\$80.70	\$80.70				\$84.30	12
	740ADL SMT	Entry				\$124.30	\$124.30				\$127.90	12
	745ADL SMT	Entry UL				\$130.30	\$130.30				\$133.90	12
	788ADL	Half Dummy				\$35.70	\$35.70				\$37.50	20

Pembroke™

	Model	Function	Finish								Case	
			3	L03	5	11P	15	15A	26	26D	514	Qty
	720PML	Hall/Closet				\$71.40	\$71.40		\$71.40		\$75.00	12
	725PML	Hall/Closet UL				\$77.40	\$77.40		\$77.40		\$81.00	12
	730PML	Bed/Bath				\$74.70	\$74.70		\$74.70		\$78.30	12
	735PML	Bed/Bath UL				\$80.70	\$80.70		\$80.70		\$84.30	12
	740PML SMT	Entry				\$124.30	\$124.30		\$124.30		\$127.90	12
	745PML SMT	Entry UL				\$130.30	\$130.30		\$130.30		\$133.90	12
	788PML	Half Dummy				\$35.70	\$35.70		\$35.70		\$37.50	20

Halifax™

	Model	Function	Finish									Case	
			11P	15	26	26D	514	11Px15	11Px26	15x26	514x15	514x26	Qty
	720HFL	Hall/Closet	\$71.40	\$71.40	\$71.40	\$71.40	\$75.00	\$71.40	\$71.40	\$71.40	\$75.00	\$75.00	12
	725HFL	Hall/Closet UL	\$77.40	\$77.40	\$77.40	\$77.40	\$81.00						12
	730HFL	Bed/Bath	\$74.70	\$74.70	\$74.70	\$74.70	\$78.30	\$74.70	\$74.70	\$74.70	\$78.30	\$78.30	12
	740HFL SMT	Entry	\$124.30	\$124.30	\$124.30	\$124.30	\$127.90	\$124.30	\$124.30	\$124.30	\$127.90	\$127.90	12
	740HFL SMC*	Entry		\$126.80	\$126.80		\$130.40						12
	745HFL SMT	Entry UL	\$130.30	\$130.30	\$130.30	\$130.30	\$133.90						12
	788HFL	Half Dummy	\$35.70	\$35.70	\$35.70	\$35.70	\$37.50						20

NOTE: Can be ordered with (RDT) Round Rose or (SQT) Square Rose option. Example - 720HFL RDT 11P, *(SQT) Square Rose Only

**Halifax™
San Clemente
Trim**

	Model	Function	Function								Case		
			11P	15	26	26D	514	11Px15	11Px26	15x26	514x15	514x26	Qty
	720HFL RCT	Hall/Closet		\$80.20	\$80.20		\$83.70						12
	730HFL RCT	Bed/Bath		\$83.70	\$83.70		\$87.30						12
	740HFL RCT SMT	Entry		\$135.20	\$135.20		\$138.80						12
	788HFL RCT	Half Dummy		\$40.00	\$40.00		\$41.90						20

NOTE: RCT = Rectangular

Lisbon



Model	Function	Finish										Case Qty
		11P	15	26	26D	514	11Px15	11Px26	15x26	514x15	514x26	
720LSL	Hall/Closet	\$71.40	\$71.40	\$71.40	\$71.40	\$75.00	\$71.40	\$71.40	\$71.40	\$75.00	\$75.00	12
730LSL	Bed/Bath	\$74.70	\$74.70	\$74.70	\$74.70	\$78.30	\$74.70	\$74.70	\$74.70	\$78.30	\$78.30	12
740LSL SMT	Entry	\$124.30	\$124.30	\$124.30	\$124.30	\$127.90	\$124.30	\$124.30	\$124.30	\$127.90	\$127.90	12
788LSL	Half Dummy	\$35.70	\$35.70	\$35.70	\$35.70	\$37.50						12

NOTE: Can be ordered with (RDT) Round Rose or (SQT) Square Rose option. Example - 720LSL RDT 11P

Milan™



Model	Function	Finish										Case Qty
		11P	15	26	26D	514	11Px15	11Px26	15x26	514x15	514x26	
720MIL	Hall/Closet	\$71.40	\$71.40	\$71.40	\$71.40	\$75.00	\$71.40	\$71.40	\$71.40	\$75.00	\$75.00	12
730MIL	Bed/Bath	\$74.70	\$74.70	\$74.70	\$74.70	\$78.30	\$74.70	\$74.70	\$74.70	\$78.30	\$78.30	12
740MIL SMT	Entry	\$124.30	\$124.30	\$124.30	\$124.30	\$127.90	\$124.30	\$124.30	\$124.30	\$127.90	\$127.90	12
788MIL	Half Dummy	\$35.70	\$35.70	\$35.70	\$35.70	\$37.50						12

NOTE: Can be ordered with (RDT) Round Rose or (SQT) Square Rose option. Example - 720MIL SQT 11P

Montreal



Model	Function	Finish										Case Qty
		11P	15	26	26D	514	11Px15	11Px26	15x26	514x15	514x26	
720MRL	Hall/Closet	\$71.40	\$71.40	\$71.40	\$71.40	\$75.00	\$71.40	\$71.40	\$71.40	\$75.00	\$75.00	12
730MRL	Bed/Bath	\$74.70	\$74.70	\$74.70	\$74.70	\$78.30	\$74.70	\$74.70	\$74.70	\$78.30	\$78.30	12
740MRL SMT	Entry	\$124.30	\$124.30	\$124.30	\$124.30	\$127.90	\$124.30	\$124.30	\$124.30	\$127.90	\$127.90	12
788MRL	Half Dummy	\$35.70	\$35.70	\$35.70	\$35.70	\$37.50						12

NOTE: Can be ordered with (RDT) Round Rose or (SQT) Square Rose option. Example - 720MRL RDT 11P

Singapore



Model	Function	Finish										Case Qty
		11P	15	26	514	11Px15	11Px26	15x26	514x15	514x26		
720SAL	Hall/Closet	\$71.40	\$71.40	\$71.40	\$75.00	\$71.40	\$71.40	\$71.40	\$75.00	\$75.00	12	
730SAL	Bed/Bath	\$74.70	\$74.70	\$74.70	\$78.30	\$74.70	\$74.70	\$74.70	\$78.30	\$78.30	12	
740SAL SMT	Entry	\$124.30	\$124.30	\$124.30	\$127.90	\$124.30	\$124.30	\$124.30	\$127.90	\$127.90	12	
788SAL	Half Dummy	\$35.70	\$35.70	\$35.70	\$37.50						20	

NOTE: Square (SQT) or Round (RDT) rose options available

Tripoli





Model	Function	Finish										Case Qty
		11P	15	26	514	11Px15	11Px26	15x26	514x15	514x26		
720TPL MDT	Hall/Closet		\$71.40	\$71.40	\$75.00							12
730TPL MDT	Bed/Bath		\$74.70	\$74.70	\$78.30							12
740TPL MDT SMT	Entry		\$124.30	\$124.30	\$127.90							12
788TPL MDT	Half Dummy		\$35.70	\$35.70	\$37.50							20

NOTE: MDT=Midtown

	Model	Function	Finish								Case Qty			
			11P	15	26	26D	514	11Px15	11Px26	15x26		514x15	514x26	
	720KAL	Hall/Closet		\$71.40				\$75.00						12
	730KAL	Bed/Bath		\$74.70				\$78.30						12
	740KAL SMT	Entry		\$124.30				\$127.90						12
	788KAL	Half Dummy		\$35.70				\$37.50						20

NOTE: Made-to-Order configurations not available. Made-to-Stock only.

	Model	Function	Finish								Case Qty		
			3	L03	5	11P	15	15A	26	26D		514	
	720CHL	Hall/Closet	\$65.80	\$71.40		\$71.40	\$71.40				\$71.40	\$75.00	12
	725CHL	Hall/Closet UL	\$71.80	\$77.40		\$77.40	\$77.40				\$77.40	\$81.00	12
	730CHL	Bed/Bath	\$69.10			\$74.70	\$74.70				\$74.70	\$78.30	12
	735CHL	Bed/Bath UL	\$75.10			\$80.70	\$80.70				\$80.70	\$84.30	12
	740CHL	Entry	\$118.70	\$124.30		\$124.30	\$124.30				\$124.30	\$127.90	12
	740CHL SMT	Entry	\$118.70	\$124.30		\$124.30	\$124.30				\$124.30	\$127.90	12
	745CHL	Entry UL	\$124.70	\$130.30		\$130.30	\$130.30				\$130.30	\$133.90	12
	745CHL SMT	Entry UL	\$124.70	\$130.30		\$130.30	\$130.30				\$130.30	\$133.90	12
	788CHL	Half Dummy	\$32.90			\$35.70	\$35.70				\$35.70	\$37.50	20

	Model	Function	Finish								Case Qty		
			3	L03	5	11P	15	15A	26	26D		514	
	720TNL	Hall/Closet	\$55.00			\$60.60	\$60.60			\$60.60	\$60.60	\$64.20	12*
	725TNL	Hall/Closet UL	\$61.00			\$66.60	\$66.60			\$66.60	\$66.60	\$70.20	12*
	730TNL	Bed/Bath	\$58.30			\$63.90	\$63.90			\$63.90	\$63.90	\$67.50	12*
	735TNL	Bed/Bath UL	\$64.30			\$69.90	\$69.90			\$69.90	\$69.90		12*
	740TNL	Entry				\$89.50	\$89.50			\$89.50	\$89.50		12*
	740TNL SMT	Entry	\$83.90			\$89.50	\$89.50			\$89.50	\$89.50	\$93.10	12*
	740TNL SMC	Entry				\$92.00	\$92.00						12*
	745TNL	Entry UL	\$89.90			\$95.50	\$95.50			\$95.50	\$95.50		12*
	745TNL SMT	Entry UL	\$89.90			\$95.50	\$95.50			\$95.50	\$95.50		12*
	750TNL	Storeroom	\$88.90			\$94.50	\$94.50			\$94.50	\$94.50		12*
	750TNL SMT	Storeroom	\$88.90			\$94.50	\$94.50			\$94.50	\$94.50		12*
	755TNL	Storeroom UL	\$94.90			\$100.50	\$100.50			\$100.50	\$100.50		12*
	755TNL SMT	Storeroom UL	\$94.90			\$100.50	\$100.50			\$100.50	\$100.50		12*
	788TNL	Half Dummy	\$27.50			\$30.30	\$30.30			\$30.30	\$30.30	\$32.10	20

Laurel®

	Model	Function	Finish								Case Qty	
			3	L03	5	11P	15	15A	26	26D		514
	720L	Hall/Closet				\$58.90	\$58.90		\$58.90		\$62.40	12
	730L	Bed/Bath				\$62.50	\$62.50		\$62.50		\$66.00	12
	740L SMT	Entry				\$87.30	\$87.30		\$87.30		\$90.80	12
	788L	Half Dummy				\$29.45	\$29.45		\$29.45		\$31.20	20

Pismo

	Model	Function	Finish								Case Qty		
			11P	15	26	26D	514	11Px15	11Px26	15x26		514x15	514x26
	720PSK	Hall/Closet	\$50.20	\$50.20	\$50.20	\$50.20	\$53.70	\$50.20	\$50.20	\$50.20		\$53.70	12
	725PSK	Hall/Closet UL	\$56.20	\$56.20	\$56.20	\$56.20	\$59.70						12
	730PSK	Bed/Bath	\$53.80	\$53.80	\$53.80	\$53.80	\$57.30	\$53.80	\$53.80	\$53.80		\$57.30	12
	740PSK SMT	Entry	\$78.60	\$78.60	\$78.60	\$78.60	\$82.10	\$78.60	\$78.60	\$78.60		\$82.10	12
	740PSK SMC*	Entry		\$81.10	\$81.10		\$84.60						12
	788PSK	Half Dummy	\$25.10	\$25.10	\$25.10	\$25.10	\$26.85						20

NOTE: Can be ordered with (RDT) Round Rose or (SQT) Square Rose option. Example - 720PSK RDT 514; *(SQT) Square Rose Only

Hancock®

	Model	Function	Finish								Case Qty	
			3	L03	5	11P	15	15A	26	26D		514
	720H	Hall/Closet	\$35.80	\$41.70		\$41.70	\$41.70		\$41.70	\$41.70	\$45.20	12
	725H	Hall/Closet UL	\$41.80	\$47.70		\$47.70	\$47.70		\$47.70	\$47.70	\$51.20	12
	730H	Bed/Bath	\$39.40			\$45.30	\$45.30		\$45.30	\$45.30	\$48.80	12
	735H	Bed/Bath UL	\$45.40			\$51.30	\$51.30		\$51.30	\$51.30	\$54.80	12
	740H	Entry	\$64.20	\$70.10		\$70.10	\$70.10		\$70.10	\$70.10	\$73.60	12
	740H SMT	Entry	\$64.20	\$70.10		\$70.10	\$70.10		\$70.10	\$70.10	\$73.60	12
	740H SMC	Single Cylinder				\$72.60	\$72.60					12
	745H	Entry UL	\$70.20	\$76.10		\$76.10	\$76.10		\$76.10	\$76.10	\$79.60	12
	745H SMT	Entry UL	\$70.20	\$76.10		\$76.10	\$76.10		\$76.10	\$76.10	\$79.60	12
	750H	Storeroom	\$69.20	\$75.10		\$75.10	\$75.10		\$75.10	\$75.10	\$78.60	12
	750H SMT	Storeroom	\$69.20	\$75.10		\$75.10	\$75.10		\$75.10	\$75.10	\$78.60	12
	755H	Storeroom UL	\$75.20	\$81.10		\$81.10	\$81.10		\$81.10	\$81.10	\$84.60	12
	755H SMT	Storeroom UL	\$75.20	\$81.10		\$81.10	\$81.10		\$81.10	\$81.10	\$84.60	12
	788H	Half Dummy	\$17.90	\$20.85		\$20.85	\$20.85		\$20.85	\$20.85	\$22.60	20

Abbey®

	Model	Function	Finish								Case Qty	
			3	L03	5	11P	15	15A	26	26D		514
	720A	Hall/Closet	\$33.90								\$39.80	12
	725A	Hall/Closet UL	\$39.90								\$45.80	12
	730A	Bed/Bath	\$37.50								\$43.40	12
	735A	Bed/Bath UL	\$43.50								\$49.40	12
	740A	Entry	\$62.30								\$68.20	12
	740A SMT	Entry	\$62.30								\$68.20	12
	745A	Entry UL	\$68.30								\$74.20	12
	745A SMT	Entry UL	\$68.30								\$74.20	12
	750A	Storeroom	\$67.30								\$73.20	12
	750A SMT	Storeroom	\$67.30								\$73.20	12
	755A	Storeroom UL	\$73.30								\$79.20	12
	755A SMT	Storeroom UL	\$73.30								\$79.20	12
	788A	Half Dummy	\$16.95								\$19.90	20

Arroyo

	Model	Function	Finish								Case Qty	
			3	L03	5	11P	15	15A	26	26D		514
	720AYK MDT	Hall/Closet					\$50.20		\$50.20		\$53.70	12
	730AYK MDT	Bed/Bath					\$53.80		\$53.80		\$57.30	12
	740AYK MDT SMT	Entry					\$78.60		\$78.60		\$82.10	12
	788AYK MDT	Half Dummy					\$25.10		\$25.10		\$26.85	20

980/985



Model	Function	Finish										Case Qty
		3	L03	5	11P	15	15A	26	26D	514	514	
980	Single Cylinder				\$87.90	\$87.90					\$91.50	12
980 SMT	Single Cylinder				\$87.90	\$87.90					\$91.50	12
982	Single Cylinder UL				\$93.90	\$93.90					\$97.50	12
982 SMT	Single Cylinder UL				\$93.90	\$93.90					\$97.50	12
984	Double Cylinder UL				\$125.20	\$125.20					\$128.80	12
984 SMT	Double Cylinder UL				\$125.20	\$125.20					\$128.80	12
985	Double Cylinder				\$119.20	\$119.20					\$122.80	12
985 SMT	Double Cylinder				\$119.20	\$119.20					\$122.80	12

Uptown Deadbolt



Model	Function	Function										Case Qty
		5	11P	15	15A	26	26D	514	11Px15	11Px26	11Px26	
258 RDT SMT	Single Cylinder		\$87.90	\$87.90		\$87.90	\$87.90	\$91.50	\$87.90	\$87.90		12

Downtown Deadbolt



Model	Function	Function										Case Qty
		5	11P	15	15A	26	26D	514	11Px15	11Px26	11Px26	
258 SQT SMT	Single Cylinder		\$87.90	\$87.90		\$87.90	\$87.90	\$91.50	\$87.90	\$87.90		12
258 SQT SMC	Single Cylinder			\$90.40		\$90.40		\$94.00				12

Midtown Deadbolt



Model	Function	Function										Case Qty
		5	11P	15	15A	26	26D	514	11Px15	11Px26	11Px26	
258 MDT	Single Cylinder			\$87.90		\$87.90		\$91.50				12

San Clemente Rectangular Deadbolt



Model	Function	Function										Case Qty
		5	11P	15	15A	26	26D	514	11Px15	11Px26	11Px26	
258 RCT SMT	Single Cylinder			\$96.60		\$96.60		\$100.10				12

780/785



Model	Function	Finish									Case
		3	L03	5	11P	15	15A	26	26D	514	Qty
780	Single Cylinder	\$65.10	\$74.50		\$74.50	\$74.50		\$74.50	\$74.50	\$78.10	12
780 SMT	Single Cylinder	\$65.10	\$74.50		\$74.50	\$74.50		\$74.50	\$74.50	\$78.10	12
780 SMC	Single Cylinder				\$77.00	\$77.00			\$77.00		12
782	Single Cylinder UL	\$71.10	\$80.50		\$80.50	\$80.50		\$80.50	\$80.50		12
782 SMT	Single Cylinder UL	\$71.10	\$80.50		\$80.50	\$80.50		\$80.50	\$80.50	\$84.10	12
784	Double Cylinder UL	\$102.40	\$111.80		\$111.80	\$111.80		\$111.80	\$111.80		12
784 SMT	Double Cylinder UL	\$102.40	\$111.80		\$111.80	\$111.80		\$111.80	\$111.80		12
785	Double Cylinder	\$96.40	\$105.80		\$105.80	\$105.80		\$105.80	\$105.80		12
785 SMT	Double Cylinder	\$96.40	\$105.80		\$105.80	\$105.80		\$105.80	\$105.80		12

Halifax Deadbolt



Model	Function	Function								Case	
		11P	15	26	26D	514	11Px15	11Px26	15x26	514x26	Qty
158 SQT	Single Cylinder	\$74.50	\$74.50	\$74.50	\$74.50	\$78.10					12
158 SQT SMT	Single Cylinder	\$74.50	\$74.50	\$74.50	\$74.50	\$78.10	\$69.00	\$69.00	\$69.00	\$72.30	12
158 SQT SMC	Single Cylinder		\$77.00			\$80.60					12
982 SQT	Single Cylinder UL	\$80.50	\$80.50	\$80.50	\$80.50	\$84.10					12
982 SQT SMT	Single Cylinder UL	\$80.50	\$80.50	\$80.50	\$80.50	\$84.10					12
159 SQT	Double Cylinder	\$105.80	\$105.80	\$105.80	\$105.80	\$109.40					12
159 SQT SMT	Double Cylinder	\$105.80	\$105.80	\$105.80	\$105.80	\$109.40					12

Milan Deadbolt



Model	Function	Function								Case	
		11P	15	26	26D	514	11Px15	11Px26	15x26	514x26	Qty
158 RDT	Single Cylinder	\$74.50	\$74.50	\$74.50	\$74.50	\$78.10					12
158 RDT SMT	Single Cylinder	\$74.50	\$74.50	\$74.50	\$74.50	\$78.10	\$74.50	\$74.50	\$74.50	\$78.10	12
982 RDT	Single Cylinder UL	\$80.50	\$80.50	\$80.50	\$80.50	\$84.10					12
982 RDT SMT	Single Cylinder UL	\$80.50	\$80.50	\$80.50	\$80.50	\$84.10					12
159 RDT	Double Cylinder	\$105.80	\$105.80	\$105.80	\$105.80	\$109.40					12
159 RDT SMT	Double Cylinder	\$105.80	\$105.80	\$105.80	\$105.80	\$109.40					12

Gatelatch



Model	Function	Finish									Case
		3	L03	5	11P	15	15A	26	26D	514	Qty
598 SMT	Single Cylinder	\$92.60				\$102.00			\$102.00		12

KWIKSET SIGNATURE SERIES HANDLESETS

Door Prep	Deadbolt: Cross Bore 2-1/8" or 1-1/2". Edge Bore 1". Handle: Cross Bore 2-1/8". Edge Bore 1".
Backset	Deadbolt: Adjustable to 2-3/8" or 2-3/4". Handle: Adjustable to 2-3/8" or 2-3/4".
Door	1-3/4" doors standard. 2-1/4" doors optional.
Thickness	Not designed for use on 1-3/8" doors.
Cylinder	SmartKey Security or Pin & Tumbler
Faceplate	1" x 2-1/4". Specify round corner, square corner or drive-in.
Strikes	Deadbolt: 1-1/4" x 3-5/8". Specify round corner or square corner. Others options available. Handle: 2-1/4" full lip. Specify round corner or square corner. Other options available.
Bolt	Deadbolt: 1" throw. Handle: 1/2" throw.
Door Handing	Reversible for right or left-hand doors.
ANSI/BHMA	Deadbolt is Grade 1 Certified. Montara Deadbolt is Grade 2 Certified.
ADA	N/A
UL	Optional 1/3 hour UL* fire rating for all functions except 802, 819 and 502

KWIKSET SIGNATURE SERIES LEVERS

Door Prep	Cross Bore 2-1/8" Edge Bore 1" Latch Face 1" x 2-1/4"
Backset	Adjustable 2-3/8" or 2-3/4".
Door	1-3/8" – 1-3/4" doors standard.
Thickness	2-1/4" doors optional on 720 and 740 models. Up to 2-1/8" doors optional on HFL/MIL/LSL/MRL/SAL
Cylinder	SmartKey Security or Pin & Tumbler.
Rose	Specify round or square rose - HFL, LSL, MRL, MIL, SAL
Faceplate	1" x 2-1/4". Specify round corner, square corner or drive-in.
Strikes	2-1/4" full lip. Specify round corner or square corner. Other options available.
Bolt	1/2" throw
Door Handing	Specify handing only with inactive levers
ANSI/BHMA	Grade 2 Certified.
ADA	Families of MRL, LSL, MIL, HFL in Functions Passage, Privacy are in compliance with the American National Standards Institute (ANSI A117.1) and the Americans with Disabilities Act (ADA).
UL	Meets UL 3 hour fire rating for 725, 735, 745, 749, 755 Optional UL* 1/3 hour fire rating for all functions

KWIKSET SIGNATURE SERIES KNOBS

Door Prep	Cross Bore: 2-1/8" Edge Bore: 1" Latch Face: 1" x 2-1/4".
Backset	Adjustable to 2-3/8" or 2-3/4". UL 2-3/4" standard 2-3/8" optional.
Door	1-3/8" – 1-3/4" doors standard.
Thickness	2-1/4" doors optional on 720 and 740 models only.
Cylinder	SmartKey Security or Pin & Tumbler.
Faceplate	1" x 2-1/4". Specify round corner, square corner or drive-in.
Strikes	2-1/4" full lip. Specify round corner or square corner. Other options available.
Bolt	1/2" throw.
Door Handing	Reversible for right- or left-hand doors.
ANSI/BHMA	Grade 2 Certified
ADA	N/A
UL	Meets UL 3 hour fire rating for 725, 735, 745, 749 and 755. Optional UL* 1/3 hour fire rating for all functions

VANCOUVER HANDLESET

Door Prep (Deadbolt/Handle)	Crossbore 2-1/8". Edge Bore 1". Latch Face 1" x 2-1/4" Deadbolt & Handle bore holes must be 5-1/2" apart
Backset (Deadbolt/Handle)	Adjustable 2-3/8" or 2-3/4"
Door	1-3/4" Standard.
Thickness	Thick door service part available for up to 2-1/4"
Cylinder	SmartKey Security
Faceplate	1" x 2-1/4". Square, round, or drive in
Strikes	Deadbolt: 1-1/8" x 2-3/4" round; 2-1/4" full lip round (non-graded) Handle: 2-1/4" full lip round
Bolt	Deadbolt: 1" Throw Handle: 1/2" Throw
Door Handing	Reversible for right or left-hand doors.
ANSI/BHMA	Deadbolt – A156.39 Grade AAA Certified
ADA	N/A
UL	N/A
Warranty	Lifetime Mechanical and Lifetime Finish.

*Optional UL 1/3 hour list price charge is \$2.50.

**KWIKSET SIGNATURE SERIES
158/159 CONTEMPORARY DEADBOLTS**

Door Prep	Cross Bore 2-1/8" or 1-1/2". Edge Bore 1".
Backset	Adjustable 2-3/8" or 2-3/4".
Door Thickness	SMT 1-3/8" – 1-3/4".
Cylinder	SmartKey Security or Pin & Tumbler (158 and 159)
Rose	Specify round or square rose
Strikes	1-1/4" x 3-5/8" Square or Round Corner.
Bolt	1" Throw Steel.
ANSI/BHMA	A156.36 Grade 2
ADA	Interior turn pieces are in compliance with the American National Standards Institute (ANSI A117.1) and the Americans with Disabilities Act (ADA).
UL	Optional UL* 1/3 hour fire rating for all functions.

**KWIKSET SIGNATURE SERIES
780-785 DEADBOLTS**

Door Prep	780, 785: Crossbore 2-1/8" or 1-1/2". Edge Bore 1". 782, 784: Crossbore 2-1/8". Edge Bore 1".
Backset	Adjustable 2-3/8" or 2-3/4" standard.
Door Thickness	1-3/8" – 1-3/4" doors standard. 1-7/8" – 2-1/4" optional.
Cylinder	SmartKey Security or 6-pin removable core.
Faceplate	1" x 2-1/4". Specify round corner, square corner or drive-in.
Strikes	1-1/4" x 3-5/8". Specify round corner or square corner. Other options available.
Bolt	1" throw.
Door Handing	Reversible for right or left-hand doors.
ANSI/BHMA	Grade 2 Certified.
ADA	Interior turn pieces are in compliance with the American National Standards Institute (ANSI A117.1) and the Americans with Disabilities Act (ADA).
UL	Meets UL 3 hour fire rating for 782 & 784 Optional UL* 1/3 hour fire rating for all functions

**KWIKSET SIGNATURE SERIES
980/985 DEADBOLTS**

Door Prep	980, 985: Crossbore 2-1/8" or 1-1/2". Edge Bore 1". 982, 984: Crossbore 2-1/8". Edge Bore 1".
Backset	Adjustable 2-3/8" or 2-3/4".
Door Thickness	1-3/8" – 1-3/4" doors standard. 1-7/8" – 2-1/4" optional.
Cylinder	SmartKey Security or Pin & Tumbler.
Faceplate	1" x 2-1/4". Specify round corner, square corner or drive-in.
Strikes	Grade 2 - 3222/3223 strike (1-1/4" x 3-5/8"). Grade 1 - 20049/20050 strike (1-1/8" x 2-3/4")
Bolt	1" throw.
Door Handing	Reversible for right or left-hand doors.
ANSI/BHMA	Grade 1 Certified.
ADA	Interior turn pieces are in compliance with the American National Standards Institute (ANSI A117.1) and the Americans with Disabilities Act (ADA).
UL	Meets UL 3 hour fire rating for 982 and 984 Optional UL* 1/3 hour fire rating for all functions

*Optional UL 1/3 hour list price charge is \$2.50.

**KWIKSET SIGNATURE SERIES 258
UPTOWN & DOWNTOWN CONTEMPORARY
DEADBOLTS , AND SAN CLEMENTE**

Door Prep	Cross Bore 2-1/8". Edge Bore 1".
Backset	Adjustable 2-3/8" or 2-3/4".
Door Thickness	1-3/8" – 1-3/4" Standard. Thick door service part available for up to 2'1/4".
Cylinder	Smartkey Security
Faceplate	1" x 2-1/4" Square, round, or drive in.
Rose	Specify round (Uptown) or square (Downtown) rose.
Strikes	1" x 2-1/4" square or round corner.
Bolt	1" Throw Steel.
ANSI/BHMA	A156.36 Grade 1
ADA	Interior turn pieces are in compliance with the American National Standards Institute (ANSI A117.1) and the Americans with Disabilities Act (ADA).
UL	Optional UL* 1/3 hour fire rating for all functions (excluding 814SCE)

KWIKSET SIGNATURE SERIES HANDLESET

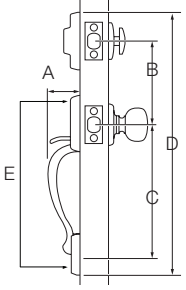

Design	A	B	C	D	E
Arlington®	2-1/2"	5-1/2"	11"	19-1/16"	15
Ashfield™	2-31/32"	5-1/2"	8-13/32"	17-3/4"	14-11/25"
Austin	3-1/8"	5-1/2"	8-13/32"	18-13/32"	13-17/20"
			9-1/8"		
			9-11/16"		
Avalon™	2-7/8"	5-1/2"	8-13/32"	18- 5/32"	12-13/20"
Chelsea®	2-3/16"	5-1/2"	9-11/16"	18 -1/2"	13
Hawthorne™	2-7/8"	5-1/2"	8-13/32"	17-7/16"	13-2/5"
Montara™	2-5/8"	5-1/2"	8-13/32"	17-5/8"	12-1/5"
			9-1/8"		
			9-11/16"		
Prague	2-25/32"	5-1/2"	8-13/32"	17-23/32"	
			9-11/16"		
Prescott	2-25/32"	5-1/2"	8-13/32"	17-23/32"	
			9-11/16"		
San Clemente	2-5/8"	5-1/2"	8-13/32"	17-15/16"	
			9-11/16"		
Shelburne™	2-7/8"	5-1/2"	8-13/32"	18-1/4"	12-3/5"
Tavaris	2-17/32"	5-1/2"	8-13/32"	18"	12-19/25"
Vancouver	2-1/32"	5-1/2"	8-13/32"	17-15/16"	
			9-11/16"		

KWIKSET SIGNATURE SERIES KNOBS

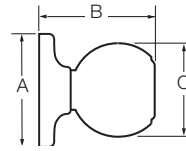

Design	A	B	C
Arroyo	2-5/8"	2-7/16"	2-3/16"
Abbey®	2-5/8"	2-7/16"	2-3/8"
Hancock®	2-5/8"	2-1/2"	2-3/8"
Laurel®	2-5/8"	2-7/16"	2-7/16"
Pismo	2-5/8"	2-13/32"	2-6/7"

KWIKSET SIGNATURE SERIES LEVERS

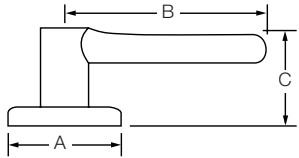

Design	A	B	C	C (Keyed)
Ashfield™	2-5/8"	4-3/16"	2-9/16"	2-9/16"
Commonwealth®	2-5/8"	4-7/32"	2-7/16"	2-7/16"
Halifax	2-5/8"	4-15/32"	2-19/32"	2-3/8"
Katella	2-21/32"	4-1/4"	2-15/32"	2-9/816"
Lisbon	2-5/8"	4-5/32"	2-9/16"	2-3/8"
Milan	2-5/8"	4-5/32"	2-9/16"	2-3/8"
Montreal	2-5/8"	4-1/4"	2-5/8"	2-11/16"
Pembroke™	2-5/8"	4-7/32"	2-23/32"	2-23/32"
Singapore Round	2-11/16"	4-7/32"	2-1/2"	2-1/4"
Singapore Square	2-11/16"	4-7/32"	2-1/2"	2-1/4"
Tustin®	2-5/8"	4-7/32"	2-3/32"	2-19/32"
Tripoli	2-11/16"	4-1/4"	2-9/16"	2-9/16"

KWIKSET SIGNATURE SERIES 158-159 DEADBOLT

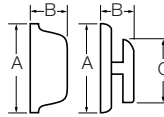

Round Design	A	B	C
158 Interior	2-17/32"	1-13/32"	1-11/16"
158 Exterior	2-17/32"	15/16"	
159 Interior	2-17/32"	1-13/32"	1-11/16"
159 Exterior	2-17/32"	15/16"	

Square Design	A	B	C
158 Interior	2-17/32"	1-13/32"	1-11/16"
158 Exterior	2-19/32"	15/16"	
159 Interior	2-17/32"	1-13/32"	1-11/16"
159 Exterior	2-19/32"	15/16"	

KWIKSET SIGNATURE SERIES 980-985 DEADBOLT

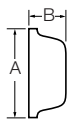

Design	A	B	C
980 Interior	2-19/32"	1-5/32"	1-13/16"
980 Exterior	2-5/8"	1-1/32"	
985 Interior	2-5/8"	1-1/32"	
985 Exterior	2-5/8"	1-1/32"	

KWIKSET SIGNATURE SERIES 780-785 DEADBOLT

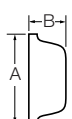

Design	A	B	C
780, 782 Interior	2-1/2"	15/16"	1-25/32"
780, 782 Exterior	2-5/8"	1-1/8"	
784, 785 Interior	2-5/8"	1-1/8"	
784, 785 Exterior	2-5/8"	1-1/8"	

KWIKSET SIGNATURE SERIES 258 UPTOWN, DOWNTOWN & MIDTOWN



Design	A	B	C
258 Round Interior	1-3/8"	1-21/32"	2-5/8"
258 Round Exterior	9/16"	2-5/8"	

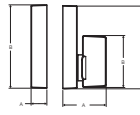

Design	A	B	C
258 Square Interior	1-7/16"	1-21/32"	2-5/8"
258 Square Exterior	1/2"	2-5/8"	

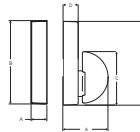

Design	A	B	C	D
258 MDT Interior	1-7/16"	2-11/16"	1-21/32"	1/2"
258 MDT Exterior	1/2"	2-11/16"		

Trusted Security



- ANSI/BHMA Grade 3
- Easy Installation
- Available with SmartKey® Security
- Most Recognized Styles

Warranty

- Lifetime Mechanical
- Lifetime Finish



Amador



Bellevue™



Dakota™



Amador	Model	Function	Finish								Case	
			3	L03	5	11P	15	15A	26	26D	514	Qty
	687AMD SMT	Single Cylinder					\$189.80		\$189.80	\$171.00	\$199.00	6
	687AMD SMC	Single Cylinder					\$192.30		\$192.30		\$201.50	6
	689AMD SMT	Double Cylinder					\$194.80		\$194.80	\$176.00		6
	699AMD	Dummy					\$178.80		\$178.80	\$160.00		6
	898AMD	Handle Only					\$156.80		\$156.80		\$166.00	6

Bellevue™	Model	Function	Finish								Case	
			3	L03	5	11P	15	15A	26	26D	514	Qty
	687BW	Single Cylinder	\$127.40		\$127.40		\$146.20			\$127.40		6
	687BW SMT	Single Cylinder	\$132.40		\$132.40		\$151.20			\$132.40	\$160.50	6
	689BW	Double Cylinder	\$132.40		\$132.40		\$151.20			\$132.40		6
	689BW SMT	Double Cylinder	\$137.40		\$137.40		\$156.20			\$137.40		6
	699BW	Dummy	\$116.40		\$116.40		\$135.20			\$116.40	\$144.50	6

Dakota™	Model	Function	Finish								Case	
			3	L03	5	11P	15	15A	26	26D	514	Qty
	687DA	Single Cylinder	\$127.40		\$127.40	\$146.20	\$146.20	\$146.20		\$127.40		6
	687DA SMT	Single Cylinder	\$132.40		\$132.40	\$151.20	\$151.20	\$151.20		\$132.40		6
	687DA SMC	Single Cylinder	\$134.90			\$153.70	\$153.70					6
	689DA	Double Cylinder	\$132.40		\$132.40	\$151.20	\$151.20	\$151.20		\$132.40		6
	689DA SMT	Double Cylinder	\$137.40		\$137.40	\$156.20	\$156.20	\$156.20		\$137.40		6
	699DA	Dummy	\$116.40		\$116.40	\$135.20	\$135.20	\$135.20		\$116.40		6
	899DA	Handleset† with Balboa				\$169.70	\$169.70					6
	898DA	Handle Only				\$113.20	\$113.20					6

†Denotes handleset without deadbolt

INTERIOR PACK FUNCTION OPTIONS

Model	Function	Series			
		Signataure Lever & Laurel	Signature Knob	Kwikset Lever	Kwikset Knob
604	Single Cylinder	\$71.50	\$58.40	\$65.60	\$53.70

NOTE:604 interior packs not impacted by SmartKey Security.

Kwikset Handleset & Interior Pack Finish Options	3	L03	5	11P	15	15A	26	26D	514	Qty
Kwikset <i>Signature Series</i>	Abbey Knob	•					•			4
	Halifax Lever				◦	◦	◦		◦	4
	Hancock Knob	•			•	•	•	•		4
	Laurel Knob				•	•	•			4
	Tustin Lever	•			•	•	•	•		4
Kwikset	Aliso Knob					•				4
	Balboa Lever	•		•	•	•	•	•	•	4
	Breton Lever					•	•		•	4
	Casey Lever					•	•		•	4
	Cove Knob				•	•			•	4
	Delta Lever	•			•	•	•	•	•	4
	Dorian Lever	•		•	•	•	•			4
	Ladera Lever					•	•	•	•	4
	Polo Knob			•	•	•	•	•	•	4
	Tylo Knob	•		•		•	•	•	•	4

◦ Item only available in 604 Function with Square Rose and Square Interior Thumbturn

Balboa™

Model	Function	Finish									Case Qty
		3	L03	5	11P	15	15A	26	26D	514	
200BL	Hall/Closet	\$44.50		\$44.50	\$48.60	\$48.60		\$48.60	\$44.50	\$51.60	12*
300BL	Bed/Bath	\$47.50		\$47.50	\$51.60	\$51.60		\$51.60	\$47.50	\$54.60	12*
405BL	Keyed Lever	\$63.00		\$63.00	\$67.10	\$67.10		\$67.10	\$63.00		12*
405BL SMT	Keyed Lever	\$68.00		\$68.00	\$72.10	\$72.10		\$72.10	\$68.00	\$75.10	12*
405BL SMC	Keyed Lever				\$74.60	\$74.60					12*
488BL	Half Dummy	\$22.30		\$22.30	\$24.30	\$24.30		\$24.30	\$22.30	\$25.80	20

Delta®

Model	Function	Finish									Case Qty
		3	L03	5	11P	15	15A	26	26D	514	
200DL	Hall/Closet	\$44.50			\$48.60	\$48.60	\$48.60	\$48.60	\$44.50		12*
300DL	Bed/Bath	\$47.50			\$51.60	\$51.60	\$51.60	\$51.60	\$47.50		12*
405DL	Keyed Lever	\$63.00			\$67.10	\$67.10	\$67.10	\$67.10	\$63.00		12*
405DL SMT	Keyed Lever	\$68.00			\$72.10	\$72.10	\$72.10	\$72.10	\$68.00		12*
405DL SMC	Keyed Lever					\$74.60			\$70.50		12*
406DL	Free Interior, Keyed Lever	\$66.00					\$70.10	\$70.10	\$66.00		12*
406DL SMT	Free Interior, Keyed Lever	\$71.00					\$75.10	\$75.10	\$71.00		12*
409DL	Keyed Lever UL	\$69.00			\$73.10	\$73.10	\$73.10	\$73.10	\$69.00		12*
409DL SMT	Keyed Lever UL	\$74.00			\$78.10	\$78.10	\$78.10	\$78.10	\$74.00		12*
412DL	Storeroom Keyed Lever UL	\$72.00					\$76.10	\$76.10	\$72.00		12*
412DL SMT	Storeroom Keyed Lever UL	\$77.00					\$81.10	\$81.10	\$77.00		12*
413DL	Free Interior, Keyed Lever UL	\$72.00					\$76.10	\$76.10	\$72.00		12*
413DL SMT	Free Interior, Keyed Lever UL	\$77.00					\$81.10	\$81.10	\$77.00		12*
420DL	Hall/Closet UL	\$53.50			\$57.60	\$57.60	\$57.60	\$57.60	\$53.50		12*
430DL	Bed/Bath UL	\$69.00					\$73.10	\$73.10	\$69.00		12*
462DL	Storeroom Keyed Lever	\$66.00					\$70.10	\$70.10	\$66.00		12*
462DL SMT	Storeroom Keyed Lever	\$71.00					\$75.10	\$75.10	\$71.00		12*
488DL	Half Dummy	\$22.30			\$24.30	\$24.30	\$24.30	\$24.30	\$22.30		20

Dorian®

Model	Function	Finish									Case Qty
		3	L03	5	11P	15	15A	26	26D	514	
200DNL	Hall/Closet	\$44.50		\$44.50	\$48.60	\$48.60	\$48.60				12*
300DNL	Bed/Bath	\$47.50		\$47.50	\$51.60	\$51.60	\$51.60				12*
405DNL	Keyed Lever	\$63.00		\$63.00	\$67.10	\$67.10	\$67.10				12*
405DNL SMT	Keyed Lever	\$68.00		\$68.00	\$72.10	\$72.10	\$72.10				12*
405DNL SMC	Keyed Lever	\$70.50			\$74.60	\$74.60					12*
406DNL	Free Interior, Keyed Lever	\$66.00		\$66.00			\$70.10				12*
406DNL SMT	Free Interior, Keyed Lever	\$71.00		\$71.00			\$75.10				12*
409DNL	Keyed Lever UL	\$69.00		\$69.00	\$73.10	\$73.10	\$73.10				12*
409DNL SMT	Keyed Lever UL	\$74.00		\$74.00	\$78.10	\$78.10	\$78.10				12*
412DNL	Storeroom Keyed Lever UL	\$72.00		\$72.00			\$76.10				12*
412DNL SMT	Storeroom Keyed Lever UL	\$77.00		\$77.00			\$81.10				12*
413DNL	Free Interior, Keyed Lever UL	\$72.00		\$72.00			\$76.10				12*
413DNL SMT	Free Interior, Keyed Lever UL	\$77.00		\$77.00			\$81.10				12*
420DNL	Hall/Closet UL	\$53.50		\$53.50	\$57.60	\$57.60	\$57.60				12*
430DNL	Bed/Bath UL	\$69.00		\$69.00			\$73.10				12*
462DNL	Storeroom Keyed Lever	\$66.00		\$66.00			\$70.10				12*
462DNL SMT	Storeroom Keyed Lever	\$71.00		\$71.00			\$75.10				12*
488DNL	Half Dummy	\$22.30		\$22.30	\$24.30	\$24.30	\$24.30				20

Ladera® RDT

Model	Function	Finish									Case Qty
		3	L03	5	11P	15	15A	26	26D	514	
200LRL RDT	Hall/Closet					\$48.60		\$48.60	\$44.50	\$51.60	12
300LRL RDT	Bed/Bath					\$51.60		\$51.60	\$47.50	\$54.60	12*
405LRL RDT	Keyed Lever					\$67.10		\$67.10	\$63.00		12*
405LRL RDT SMT	Keyed Lever					\$72.10		\$72.10	\$68.00	\$75.10	12*
488LRL RDT	Half Dummy					\$24.30		\$24.30	\$22.30	\$25.80	20

	Model	Function	Finish								Case	
			3	L03	5	11P	15	15A	26	26D	514	Qty
	200LRL SQT	Hall/Closet					\$48.60		\$48.60	\$44.50	\$51.60	12
	300LRL SQT	Bed/Bath					\$51.60		\$51.60	\$47.50	\$54.60	12
	405LRL SQT SMT	Keyed Lever					\$72.10		\$72.10	\$68.00	\$75.10	12
	405LRL SQT SMC	Keyed Lever					\$74.60		\$74.60		\$77.60	12
	488LRL SQT	Half Dummy					\$24.30		\$24.30	\$22.30	\$25.80	12

	Model	Function	Finish								Case	
			3	L03	5	11P	15	15A	26	26D	514	Qty
	200BRNL RDT	Hall/Closet					\$53.30		\$53.30		\$56.30	12*
	300BRNL RDT	Bed/Bath					\$56.30		\$56.30		\$59.30	12*
	405BRNL RDT SMT	Keyed Lever					\$76.80		\$76.80		\$79.80	12*
	488BRNL RDT	Half Dummy					\$26.70		\$26.70		\$28.20	20

	Model	Function	Finish								Case	
			3	L03	5	11P	15	15A	26	26D	514	Qty
	200BRNL SQT	Hall/Closet					\$53.30		\$53.30		\$56.30	12
	300BRNL SQT	Bed/Bath					\$56.30		\$56.30		\$59.30	12
	405BRNL SQT SMT	Keyed Lever					\$76.80		\$76.80		\$79.80	12
	488BRNL SQT	Half Dummy					\$26.70		\$26.70		\$28.20	12

	Model	Function	Finish								Case	
			3	L03	5	11P	15	15A	26	26D	514	Qty
	200CSL RDT	Hall/Closet					\$53.30		\$53.30		\$56.30	12*
	300CSL RDT	Bed/Bath					\$56.30		\$56.30		\$59.30	12*
	405CSL RDT SMT	Keyed Lever					\$76.80		\$76.80		\$79.80	12*
	488CSL RDT	Half Dummy					\$26.70		\$26.70		\$28.20	20

	Model	Function	Finish								Case	
			3	L03	5	11P	15	15A	26	26D	514	Qty
	200CSL SQT	Hall/Closet					\$53.30		\$53.30		\$56.30	12
	300CSL SQT	Bed/Bath					\$56.30		\$56.30		\$59.30	12
	405CSL SQT SMT	Keyed Lever					\$76.80		\$76.80		\$79.80	12
	488CSL SQT	Half Dummy					\$26.70		\$26.70		\$28.20	12

	Model	Function	Finish								Case	
			3	L03	5	11P	15	15A	26	26D	514	Qty
	200AO	Hall/Closet					\$33.00					30
	300AO	Bed/Bath					\$36.20					30
	400AO SMT	Entry					\$47.50					30
	488AO	Half Dummy					\$16.50					20

	Model	Function	Finish								Case	
			3	L03	5	11P	15	15A	26	26D	514	Qty
	200CV	Hall/Closet				\$33.00	\$33.00				\$36.00	30
	300CV	Bed/Bath				\$36.20	\$36.20				\$39.20	30
	400CV	Entry				\$42.50	\$42.50					30
	400CV SMT	Entry				\$47.50	\$47.50				\$50.50	30
	488CV	Half Dummy				\$16.50	\$16.50				\$18.00	20

	Model	Function	Finish								Case	
			3	L03	5	11P	15	15A	26	26D	514	Qty
	200P	Hall/Closet			\$26.50	\$29.50	\$29.50	\$29.50	\$29.50	\$26.50		30
	300P	Bed/Bath			\$29.70	\$32.70	\$32.70	\$32.70	\$32.70	\$29.70		30
	400P	Entry			\$39.20	\$42.20	\$42.20	\$42.20	\$42.20	\$39.20		30
	400P SMT	Entry			\$44.20	\$47.20	\$47.20	\$47.20	\$47.20	\$44.20		30
	400P SMC	Entry				\$49.70	\$49.70					30
	401P	Entry (Free Interior)			\$42.20	\$45.20	\$45.20			\$42.20		30
	401P SMT	Entry (Free Interior)			\$47.20	\$50.20	\$50.20			\$47.20		30
	450P	Storeroom			\$42.20					\$42.20		30
	450P SMT	Storeroom			\$47.20					\$47.20		30
	488P	Half Dummy			\$13.30	\$14.80	\$14.80	\$14.80	\$14.80	\$13.30		20

Tylo®

	Model	Function	Finish								Case Qty	
			3	L03	5	11P	15	15A	26	26D		514
	200T	Hall/Closet	\$24.10		\$24.10		\$27.10		\$27.10	\$24.10		30
	300T	Bed/Bath	\$27.30		\$27.30		\$30.30		\$30.30	\$27.30		30
	400T	Entry	\$33.60		\$33.60		\$36.60		\$36.60	\$33.60		30
	400T SMT	Entry	\$38.60		\$38.60		\$41.60		\$41.60	\$38.60		30
	401T	Entry (Free Interior)	\$36.60		\$36.60		\$39.60			\$36.60		30
	401T SMT	Entry (Free Interior)	\$41.60		\$41.60		\$44.60			\$41.60		30
	488T	Half Dummy	\$12.10		\$12.10		\$13.60		\$13.60	\$12.10		20

660/663/665

RDT

	Model	Function	Finish								Case Qty	
			3	L03	5	11P	15	15A	26	26D		514
	660 RDT	Single Cylinder SMT				\$50.30	\$50.30		\$50.30	\$47.30	\$53.30	12
	665 RDT	Double Cylinder SMT				\$59.50	\$59.50		\$59.50	\$56.50	\$62.50	12
	663 RDT	Single Sided				\$28.20	\$28.20		\$28.20	\$26.50	\$29.80	12

660/663 SQT

	Model	Function	Finish								Case Qty
			3	5	11P	15	15A	26	26D	514	
	660 SQT	Single Cylinder SMT			\$50.30	\$50.30		\$50.30	\$47.30	\$53.30	12
	660 SQT SMC	Single Cylinder				\$52.80		\$52.80		\$55.80	12
	663 SQT	Single Sided			\$28.20	\$28.20		\$28.20	\$26.50	\$29.80	12

660/665

	Model	Function	Finish								Case Qty	
			3	L03	5	11P	15	15A	26	26D		514
	660	Single Cylinder	\$34.70		\$34.70	\$37.70	\$37.70	\$37.70	\$37.70	\$34.70	\$40.70	12
	660 SMT	Single Cylinder SMT	\$39.70		\$39.70	\$42.70	\$42.70	\$42.70	\$42.70	\$39.70	\$45.70	12
	660 SMC	Single Cylinder	\$42.20			\$45.20	\$45.20			\$42.20		12
	665	Double Cylinder	\$43.90		\$43.90	\$46.90	\$46.90	\$46.90	\$46.90	\$43.90	\$49.90	12
	665 SMT	Double Cylinder SMT	\$48.90		\$48.90	\$51.90	\$51.90	\$51.90	\$51.90	\$48.90	\$54.90	12

One-Sided

	Model	Function	Finish								Case Qty	
			3	L03	5	11P	15	15A	26	26D		514
	663	Thumbturn One Side	\$19.40				\$21.10	\$21.10	\$21.10	\$19.40	\$22.80	12
	663 UL	Thumbturn One Side UL	\$25.40		\$25.40	\$27.10	\$27.10	\$27.10	\$27.10	\$25.40	\$28.80	12
	667	Thumbturn One Side with Exterior Plate	\$34.70		\$34.70	\$37.70	\$37.70	\$37.70	\$37.70			12
	664	Retrofit Kit for 663	\$13.90			\$15.10	\$15.10			\$13.90		12
	677	Thumbturn One Side with Exterior Plate UL	\$40.70		\$40.70	\$43.70	\$43.70			\$40.70		12

Deadbolt and Knob Combo Packs

	Model	Function	Finish								Case Qty	
			3	L03	5	11P	15	15A	26	26D		514
	690T	Keyed Entry Tylo Knob with Single Cylinder Deadbolt	\$61.50		\$61.50		\$66.90			\$61.50		6
	690T SMT	Keyed Entry Tylo Knob with Single Cylinder Deadbolt	\$70.50		\$70.50		\$75.90			\$70.50		6
	690P	Keyed Entry Polo Knob with Single Cylinder Deadbolt					\$71.00					6

KWIKSET HANDLESETS

Door Prep	Deadbolt: Crossbore 2-1/8" or 1-1/2". Edge Bore 1". Handle: Crossbore 2-1/8". Edge Bore 1".
Backset	Deadbolt: Adjustable to 2-3/8" or 2-3/4". Handle: Adjustable to 2-3/8" or 2-3/4".
Door Thickness	1-3/4" doors standard. 2-1/4" doors optional. Not designed for use on 1-3/8" doors.
Cylinder	SmartKey Security or traditional 5-Pin, Pin & Tumbler.
Faceplate	1" x 2-1/4". Specify round corner, square corner or drive-in.
Strikes	Deadbolt: 1" x 2-1/4". Specify round corner or square corner. Other options available. Handle: 2-1/4" full lip. Specify round corner or square corner. Other options available.
Bolt	Deadbolt: 1" throw. Handle: 1/2" throw.
Door Handing	Reversible for right or left-hand doors.
ANSI/BHMA	Deadbolt is Grade 3 Certified.
ADA	N/A
UL	Optional UL 1/3 hour fire rating for all functions except 699*

KWIKSET LEVERS

Door Prep	Cross Bore 2-1/8". Edge Bore 1".
Backset	Adjustable to 2-3/8" or 2-3/4". UL 2-3/4" standard 2-3/8" optional.
Door Thickness	1-3/8" – 1-3/4" doors standard. 2-1/4" doors optional on 200 and 400 functions only.
Cylinder	SmartKey Security or Pin & Tumbler.
Faceplate	1" x 2-1/4". Specify round corner, square corner or dr
Strikes	1" x 2-1/4" full lip. Specify round corner or square corner. Other options available.
Bolt	1/2" throw.
Door Handing	Specify handing for dummy and interior pack levers.
ANSI/BHMA	Grade 3 Certified. (all functions except 488)
ADA	Functions 200 and 420 in compliance with the American National Standards Institute (ANSI A117.1) and the Americans with Disabilities Act (ADA).
UL	Meets UL 3 hour fire rating for 409, 412, 413, 420, 430 Optional UL 1/3 hour fire rating for all functions*

KWIKSET DEADBOLTS

Door Prep	660, 665: Crossbore 2-1/8". Edge Bore 1". 663: Crossbore 1-5/8". Edge Bore 1". 667: Crossbore 2-1/8" or 1-1/2". Edge Bore 1".
Backset	660, 665, 667: Adjustable latch standard. 663: 2-3/8" standard. 2-3/4" optional.
Door Thickness	660, 663, 665, 667: 1-3/8" – 1-3/4" doors standard.
Cylinder	660, 665: SmartKey Security or Pin & Tumbler.
Faceplate	1" x 2-1/4". Specify round corner, square corner or drive-in.
Strikes	1" x 2-1/4". Specify round corner or square corner. Other options available.
Bolt	1" throw.
Door Handing	Reversible for right or left-hand doors.
ANSI/BHMA	Grade 3 Certified.
ADA	Interior turn pieces are in compliance with the American National Standards Institute (ANSI A117.1) and the Americans with Disabilities Act (ADA).
UL	Meets UL 3 hour fire rating for 677 and 663 Optional UL 1/3 hour fire rating for all functions*

KWIKSET KNOBS

Door Prep	Cross Bore 2-1/8". Edge Bore 1".
Backset	Adjustable to 2-3/8" or 2-3/4". 5" available as service part
Door Thickness	1-3/8" – 1-3/4" doors standard. 2-1/4" doors optional on 200 and 400 models only.
Cylinder	SmartKey Security or Pin & Tumbler.
Faceplate	1" x 2-1/4". Specify round corner, square corner or drive-in. Also available as drive-in latch.
Strikes	2-1/4" full lip. Specify round corner or square corner. Other options available.
Bolt	1/2" throw.
Door Handing	Reversible for right or left hand doors.
ANSI/BHMA	Grade 3 Certified. (all functions except 488)
ADA	N/A
UL	Optional UL 1/3 hour fire rating for all functions*

*Optional UL 1/3 hour list price charge is \$2.50.

KWIKSET HANDLESET

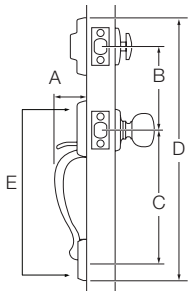

Design	A	B	C	D	E
Amador	2-5/32"	5-1/2"	9-11/16"	17-15/32"	12-14/28"
Belleview™	2-5/32"	5-1/2"	8-13/32"	18-1/16"	12-1/10"
Dakota™	2-5/32"	5-1/2"	8-13/32"	17-3/16"	12-1/10"

KWIKSET KNOB

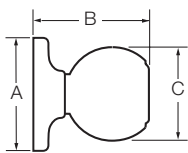

Design	A	B	C
Aliso™	2-5/8"	2-3/4"	2-2/5"
Cove™	2-5/8"	2-1/2"	2-3/16"
Polo®	2-5/8"	2-23/32"	1-7/8"
Tylo®	2-5/8"	2-1/2"	1-7/8"

KWIKSET LEVER

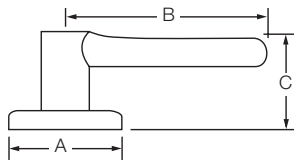

Design	A	B	C	C (Keyed)
Balboa™	2-5/8"	4-7/32"	1-15/16"	2-13/32"
Breton	2-5/8"	4"	2-7/16"	2-15/32"
Casey	2-5/8"	4-1/10"	2-3/5"	2-7/16"
Delta®	2-5/8"	3-5/8"	1-7/8"	2-15/32"
Dorian®	2-5/8"	3-3/4"	2-1/8"	2-11/16"
Ladera®	2-5/8"	4-3/16"	1-7/8"	2-7/16"

KWIKSET DEADBOLT

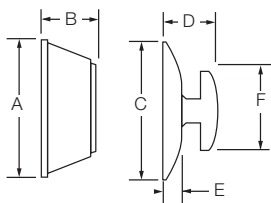

Design	A	B	C	D	E	F
660	2-7/16"	1-1/16"	2-1/2"	2-7/32"	5/16"	1-3/4"
660RDT	2-7/16"	1-1/16"	2-1/2"	3-1/32"	1-3/4"	
660SQT	2-7/16"	1-1/16"	2-1/2"	3-1/32"	1-3/4"	
663			2-1/2"	2-7/32"	5/16"	1-3/4"
663RDT			2-1/2"	3-1/32"	1-3/4"	
663SQT	2-7/16"	1-1/16"	2-1/2"	3-1/32"	1-3/4"	
665	2-7/16"	1-1/16"	2-1/2"	1-1/16"		
665RDT	2-7/16"	1-1/16"	2-7/16"	1-1/16"		
667	2-17/32"	3/8"	2-1/2"	2-7/32"	5/16"	1-3/4"
677	2-17/32"	3/8"	2-1/2"	2-7/32"	5/16"	1-3/4"

SMART LOCKS AND KEYLESS ENTRY LOCKS

Kwikset's electronic door locks offer users the convenience of keyless entry, virtually eliminating the need for keys. All of our electronic locks are easy to install and program while complementing any Kwikset knob, lever or handleset.



Features



- Smart Locks Replace any Deadbolt for Keyless Entry Convenience
- SmartCode™ Lever Ideal for - Small/Home Office, Utility/Storage Room, Interior Garage/Side Door
- Lock Your Door with the Touch of a Button
- Customizable Access Codes for Increased Security
- Back-Lit Keypad for Increased Visibility
- Customizable Automatic Door Locking After 30 Seconds for Peace Of Mind
- Installs In Minutes with Just a Screwdriver - No Hard Wiring Required
- Fits Standard Doors (1 3/8" - 2") with No Screw Holes Required

Warranty

- 1 Year Electronic Warranty
- Lifetime Finish & Mechanical Warranty

Kwikset



HALO™



TOUCH

FINGERPRINT SMART LOCK

The Halo Touch Wi-Fi enabled smart lock with fingerprint access technology allows you to simply use your unique fingerprint to lock and unlock your door.



Wi-Fi
Enabled



Works with the
Kwikset App



HALO™

WI-FI ENABLED SMART LOCKS

Halo smart locks connect directly to your existing home Wi-Fi network and smartphone to create a simple and secure smart home, without a third-party hub, panel or subscription service.

Halo Wi-Fi Enabled Smart Locks Model	Function	Finish				Case Qty
		11P	15	26	514	
939 Halo Touchscreen	WiFi Enabled Deadbolt	\$504.00	\$504.00	\$504.00	\$504.00	1
938 Halo Touchpad	WiFi Enabled Deadbolt	\$438.00	\$438.00			1
959 Halo Touch Traditional	WiFi Enabled Deadbolt	\$517.00	\$517.00			1
959 Halo Touch Contemporary	WiFi Enabled Deadbolt		\$517.00		\$517.00	1

How it Works

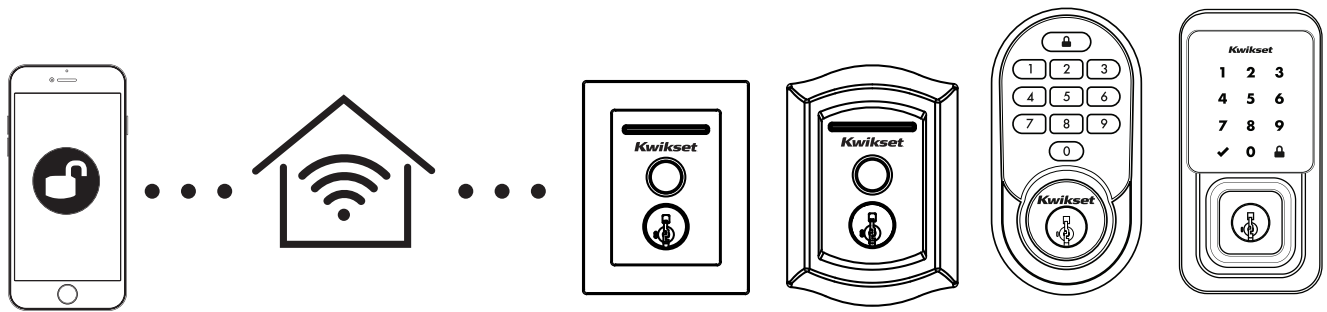

Control your lock from your smartphone

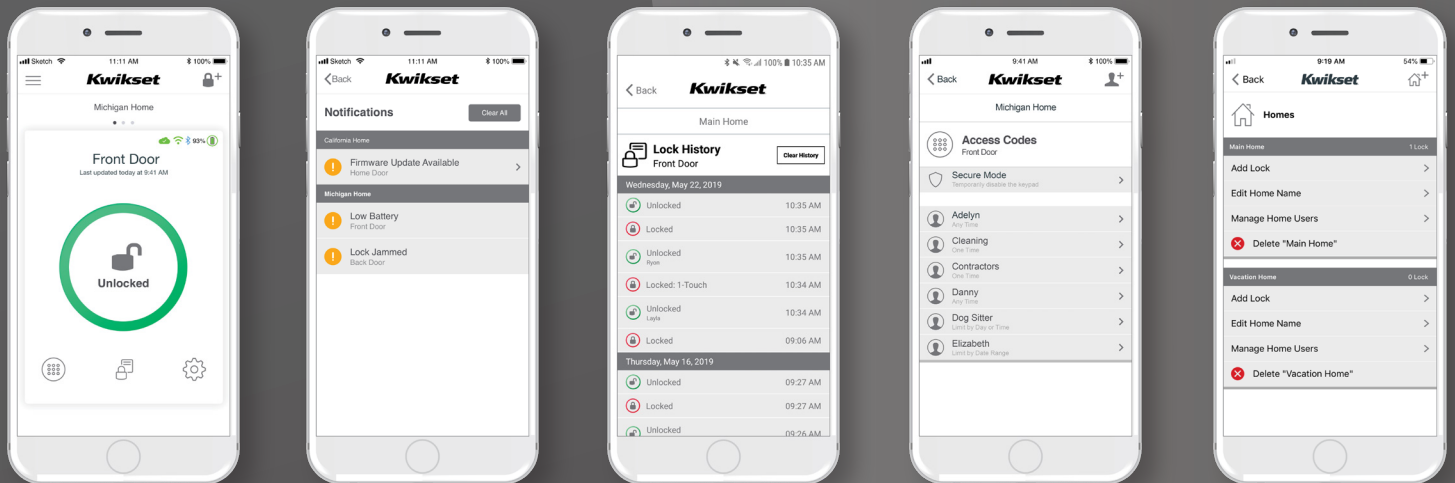

REMOTE ACCESS



PUSH NOTIFICATIONS



EVENT HISTORY



MANAGE ACCESS CODES



MANAGE MULTIPLE HOMES



Obsidian™ **SmartCode™ 260 TRL** **SmartCode™ 260 CNT** **SmartCode™ 270 TRL** **SmartCode™ 270 CNT** **SmartCode™ 915 TRL**

Obsidian™	Model	Description	Finish								Case Qty		
			3	L03	5	11P	15	15A	26	26D		514	
953 OBN	Touchscreen Electronic Deadbolt					\$407.00	\$407.00						2

SmartCode™ 260 TRL	SKU	Function	Finish								Case Qty		
			3	L03	5	11P	15	15A	26	26D		514	
992600-001	9260 TRL L03 SMT RBP RCALFD			\$231.00									2
992600-002	9260 TRL 15 SMT RBP RCALF					\$231.00							2
992600-003	9260 TRL 11P SMT RBP RCALFD				\$231.00								2

SmartCode™ 260 CNT	SKU	Function	Finish								Case Qty		
			3	L03	5	11P	15	15A	26	26D		514	
992600-004	9260 CNT 15 SMT RBP RCALFD					\$231.00							2
992600-005	9260 CNT 26 SMT RBP RCALFD							\$231.00					2
992600-006	9260 CNT 514 SMT RBP RCALFD									\$231.00			2

SmartCode™ 270 TRL	SKU	Function	Finish								Case Qty		
			3	L03	5	11P	15	15A	26	26D		514	
992700-002	9270 TRL 15 SMT RBP RCALFD					\$275.00							2
992700-003	9270 TRL 11P SMT RBP RCALFD				\$275.00								2

SmartCode™ 270 CNT	SKU	Function	Finish								Case Qty		
			3	L03	5	11P	15	15A	26	26D		514	
992700-004	9270 CNT 15 SMT RBP RCALFD					\$275.00							2
992700-005	9270 CNT 514 SMT RBP RCALFD									\$275.00			2



Aura™



SmartCode™
917 TNL



SmartCode™
917 HFL



Powerbolt 2®



Kwikset
905

**SmartCode™
915 TRL**

Model	Description	Finish										Case
		3	L03	5	11P	15	15A	26	26D	514	Qty	
915 TRL	Touchscreen Electronic Deadbolt				\$407.00	\$407.00						2

Aura™

Model	Description	Finish										Case
		3	L03	5	11P	15	15A	26	26D	514	Qty	
942 BLE	Touchscreen Electronic Deadbolt				\$328.00	\$328.00				\$328.00		1

**SmartCode™
917 TNL**

Model	Description	Finish										Case
		3	L03	5	11P	15	15A	26	26D	514	Qty	
917 TNL	Touchpad Electronic Lever Tustin				\$262.00	\$262.00						2

**SmartCode™
917 HFL**

Model	Description	Finish										Case
		3	L03	5	11P	15	15A	26	26D	514	Qty	
917 HFL	Touchpad Electronic Lever Halifax					\$262.00		\$262.00		\$262.00		2

Powerbolt 2®

Model	Description	Finish										Case
		3	L03	5	11P	15	15A	26	26D	514	Qty	
907 SMT	Touchpad Electronic Deadbolt	\$157.00			\$157.00	\$157.00						2

**905 Keyless
Entry**

Model	Description	Finish										Case
		3	L03	5	11P	15	15A	26	26D	514	Qty	
905	Touchpad Electronic Deadbolt				\$110.00	\$110.00						2



**HOME
CONNECT™**
ELECTRONIC SMART LOCKS

Control your lock from anywhere on your smart phone, tablet, or internet connected device and never worry about forgetting to lock your door again.

- Remotely lock and unlock your door from anywhere
- Receive notifications of your lock's activity
- Control when others have access to your home
- Arm or disarm your security panel
- Wirelessly communicate to other devices in your home



Features

- Full 128-Bit Encryption Security
- Motorized locking mechanism enables true remote locking & unlocking
- SmartKey Security - providing superior security against advanced break-in techniques.
- Easy Integration
- Z-Wave Wireless Protocol
- Fits Standard Doors (1 3/8"-2") with No Screw Holes Required
- 4 AA Alkaline Batteries (no hard wiring) - batteries last for approximately 1 year

Electronic Locks with Home Connect (Z-Wave)

Item Number	Function	Finish						Case Qty.	Price
		L03	11P	15	26	26D	514		
HomeConnect 620 Traditional		L03	11P	15	26	26D	514		
98930-001	HC620 TRL ZW700 15 SMT RCALFD RCS BP			•				1	\$297.00
98930-002	HC620 TRL ZW700 11P SMT RCALFD RCS BP		•					1	\$297.00
98930-003	HC620 TRL ZW700 L03 SMT RCALFD RCS BP	•						1	\$297.00

*Product must be ordered by item number and not description

HomeConnect 620 Contemporary		L03	11P	15	26	26D	514		
98930-004	HC620 CNT ZW700 15 SMT RCALFD RCS BP			•				1	\$297.00
98930-005	HC620 CNT ZW700 11P SMT RCALFD RCS BP		•					1	\$297.00
98930-006	HC620 CNT ZW700 26 SMT RCALFD RCS BP				•			1	\$297.00
98930-007	HC620 CNT ZW700 514 SMT RCALFD RCS BP						•	1	\$297.00

*Product must be ordered by item number and not description

Obsidian™ with Home Connect		L03	11P	15	26	26D	514		
99540-001	954 OBN ZW500 15 RCALFD			•				1	\$506.00
99540-002	954 OBN ZW500 11P RCALFD		•					1	\$506.00

*Product must be ordered by item number and not description

SmartCode™ 916 Contemporary with Home Connect		L03	11P	15	26	26D	514		
99160-041	916CNT 500 15 SMT CP TPR RCALFD V2			•				1	\$506.00
99160-042	916CNT 500 11P SMT CP TPR RCALFD V2		•					1	\$506.00
99160-043	916CNT 500 26 SMT CP TPR RCALFD V2				•			1	\$506.00
99160-044	916CNT 500 514 SMT CP TPR RCALFD V2						•	1	\$506.00

*Product must be ordered by item number and not description

SmartCode™ 916 with Home Connect		L03	11P	15	26	26D	514		
99160-038	916TRL 500 15 SMT CP TPR RCALFD V2			•				1	\$506.00
99160-039	916TRL 500 11P SMT CP TPR RCALFD V2		•					1	\$506.00

*Product must be ordered by item number and not description

SmartCode™ 912 with Home Connect		L03	11P	15	26	26D	514		
99120-037	912TNL ZW500 15 RCALFD			•				1	\$413.00
99120-038	912TNL ZW500 11P RCALFD		•					1	\$413.00

*Product must be ordered by item number and not description



Halo™, Halo™ Touch

Function	Single cylinder deadbolt
Door Prep	2 1/8" diameter bore hole & 1" diameter latch hole
Backset	Adjustable 2 3/8" or 2 3/4"
Door Thickness	1 3/8" - 2" automatic adjustment
Faceplates	1" x 2 1/4" round corner standard
Strikes	Round corner, 4 hole strike, 2 3/4" x 1 1/8"
Latch	Round corner adjustable 2 3/8" x 2 3/4"
Bolt	1" throw, steel deadbolt
Door Handing	Reversible
Cylinder	SmartKeySecurity™

SMARTCODE™ 916

Door Prep	2-1/8" diameter face hole & 1" diameter latch hole
Backset	Adjustable to 2-3/8" or 2-3/4"
Door Thickness	1-3/8" to 2" automatic adjustment
Cylinder	SmartKey Security
Faceplate	1" x 2-1/4". Round corner standard
Strikes	Round corner strike 1-1/8" x 2-3/4"
Bolt	1" throw, steel deadbolt
Door Handing	Reversible
Batteries	4 AA Alkaline
Wireless Communication	Z-Wave wireless technology
Operation	908.42 MHz (US)
Range	Typical 100ft line of sight

POWERBOLT 2 DEADBOLT

Function	Single cylinder deadbolt
Door Prep	2-1/8" diameter face hole & 1" diameter latch hole
Backset	Adjustable to 2-3/8" or 2-3/4"
Door Thickness	1-3/8" to 2" automatic adjustment
Cylinder	SmartKey Security
Faceplate	1" x 2-1/4" round corner standard
Strikes	Round corner strike 1-1/8" x 2-3/4"
Bolt	1" throw, steel deadbolt
Door Handing	Reversible
Batteries	4 AA Alkaline

HomeConnect™ 620

Electrical:	
Input Power	6V (4 x AA alkaline batteries)
Mechanical:	
Door Prep	1 1/2" & 2 1/8" diameter bore hole & 1" deep latch hole
Backset	Adjustable 2 3/8" or 2 3/4"
Door Thickness	1 3/8" - 2" automatic adjustment
Faceplates	1" x 2 1/4" round corner standard
Strikes	Round corner strike 1 1/8" x 2 3/4"
Latch	Round corner adjustable 2 3/8" x 2 3/4"
Bolt	1" throw, steel deadbolt
Door Handing	Reversible
Cylinder	SmartKey® Keyway
Environmental:	
Temperature Range	Exterior: -40°F to 150°F Interior: 32°F to 140°F
Humidity	Exterior: 100% condensing Interior: 30% - 95% non-condensing

OBSIDIAN 953 / 954

Function	Single cylinder deadbolt
Door Prep	1 1/2" & 2 1/8" diameter face hole & 1" diameter latch hole
Backset	Adjustable 2 3/8" or 2 3/4"
Door Thickness	1 3/8" - 2"
Faceplates	1" x 2 1/4" round corner standard
Strikes	Round corner
Latch	Round corner adjustable 2 3/8" x 2 3/4"
Bolt	1" throw, steel deadbolt
Door Handing	Reversible
Batteries	6V (4 AA alkaline batteries required)

SMARTCODE™ 912 LEVER

Door Prep	2-1/8" diameter face hole & 1" diameter latch hole
Backset	Adjustable to 2-3/8" or 2-3/4"
Door Thickness	1-3/8" to 2" automatic adjustment
Cylinder	SmartKey Security
Faceplate	1" x 2-1/4". Round corner standard
Strikes	2-1/4" full lip. Round corner
Bolt	1/2" throw
Door Handing	Reversible
Batteries	4 AA Alkaline
Wireless Communication	Z-Wave wireless technology
Operation	908.42 MHz (US)
Range	Typical 100ft line of sight

SMARTCODE™ 915 / 916 & PREMIS™

Function	Single cylinder deadbolt
Door Prep	2-1/8" diameter face hole & 1" diameter latch hole
Backset	Adjustable to 2-3/8" or 2-3/4"
Door	1-3/8" to 2-1/8" automatic adjustment
Thickness	
Cylinder	SmartKey Security
Faceplates	1" x 2-1/4" round corner standard
Strikes	Round corner, 4 hole strike, 2-3/4" x 1-1/8"
Latch	Round corner adjustable 2-3/8" or 2-3/4"
Bolt	1" throw, steel deadbolt
Door Handing	Reversible
Batteries	4 AA Required

AURA™ DEADBOLT

Door Prep	2-1/8" diameter face hole & 1" diameter latch hole
Backset	Adjustable to 2-3/8" or 2-3/4"
Door	1-3/8" to 2" automatic adjustment
Thickness	
Cylinder	SmartKey Security
Faceplate	1" x 2-1/4". Round corner standard
Strikes	2-3/4" x 1-1/8". Round corner 4 hole strike
Bolt	1" throw
Door Handing	Reversible
Batteries	4 AA Alkaline

905 TOUCHPAD DEADBOLT

Function	Single cylinder deadbolt
Door Prep	2 1/8" diameter face hole & 1" diameter latch hole
Latch Backset	Adjustable 2 3/8" or 2 3/4"
Door Thickness	Fits 1 3/8" – 1 3/4" door thickness
Latch Faceplate	1" x 2 1/4" round corner standard
Strike	Round corner strike 2 3/4" x 1 1/8"
Bolt	1" throw, steel deadbolt
Door Handing	Reversible
Batteries	Requires 4 X AA alkaline batteries

SMARTCODE™ 917

Function	Keyed entry electronic lever
Door Prep	Cross Bore 2- 1/8". Edge Bore 1".
Backset	2 3/8" or 2 3/4"
Door Thickness	1 3/8" - 1 3/4"
Faceplates	1" x 2 1/4" round corner standard, drive in available
Strikes	2 1/4" full lip round corner
Latch	Adjustable 2 3/8" x 2 3/4"
Bolt	1/2" throw, dead latch
Door Handing	Reversible for right or left-handed doors
Cylinder	SmartKey Security™
UL Rating	20 min
Temperature Range	Exterior: -40F to 150F Interior: 32F to 130F
Humidity	Exterior: - 100% condensing Interior: 30% - 95% non-condensing

SMARTCODE™ 260/270

Battery	Uses 4 x AA 6V alkaline cell batteries with approximately 1 year battery life
Function	Single cylinder deadbolt
Door Prep	1 1/2" (38mm) or 2 1/8" (54mm) diameter cross bore hole and 1" diameter edge bore hole
Backset	Adjustable 2 3/8" (60mm) or 2 3/4" (70mm)
Door Thickness	1 3/8" (35mm) to 1 3/4" (44mm) standard. Thick door service part available for 2-1/4" (57mm) thick doors
Faceplates	1" (25 mm) x 2 1/4" (57 mm) round corner faceplate with drive-in collar standard
Strikes	2 3/4" (70mm) x 1 1/8" (29mm) round corner 4 hole strike
Bolt	1" (25mm) throw, steel bolt with anti-saw security pin
Door Handing	Reversible
Cylinder	SmartKey Security™ with 2 KW1 keys
Temperature Range	Exterior: -40°F to 150°F (-40°C to 66°C) Interior: 32°F to 130°F (0°C to 54°C)
Humidity	Exterior: 100% condensing Interior: 30% to 95% non-condensing
Codes	Up to 50 user codes and 10 one-time user codes with optional programming code

OBSIDIAN™

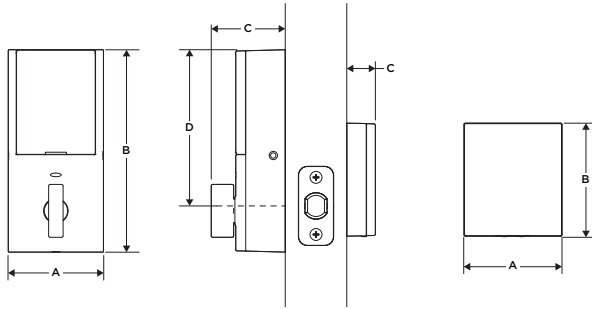

Design	A	B	C	D
Outer Trim	2 11/16"	5 3/4"	2 3/32"	4 9/16"
Inner Trim	2 25/32"	3 7/32"	13/16"	---

SMARTCODE™ 916 CNT & PREMIS CNT

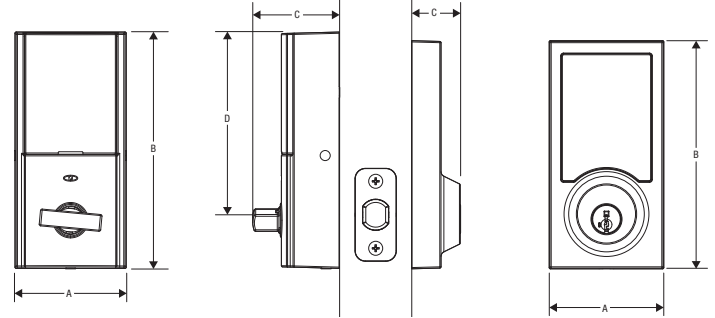

Design	A	B	C	D
Outer Trim	2 11/16"	5 3/4"	2 3/32"	4 9/16"
Inner Trim	2 25/32"	5 7/32"	1 13/16"	---

SMARTCODE™ 917 HNL

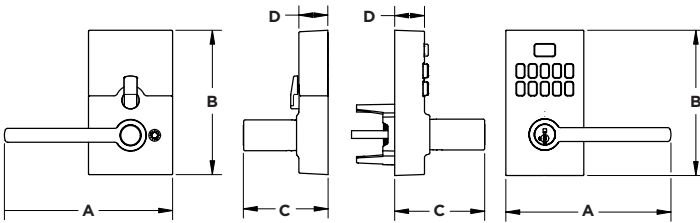

Design	A	B	C	D
Outer Trim	5 9/16"	4 29/32"	3 1/32"	1"
Inner Trim	5 1/32"	4 7/8"	2 27/32"	31/32"

SMARTCODE™ 917 TNL

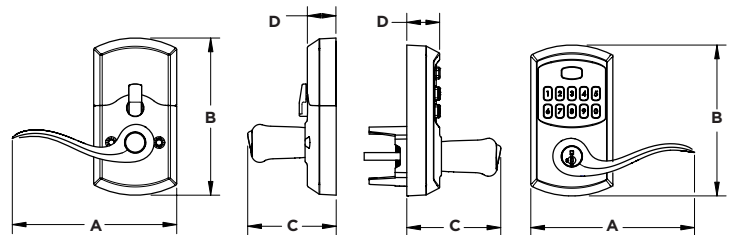

Design	A	B	C	D
Outer Trim	5 9/32"	5 5/32"	3 3/32"	1 1/8"
Inner Trim	5 5/8"	5 3/8"	2 29/32"	31/32"

KWIKSET 905

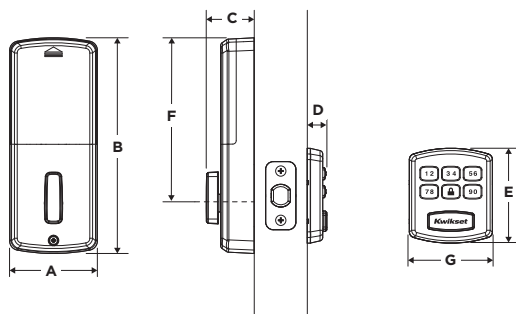

Design	A	B	C	D	E	F	G
Outer Trim	---	---	---	---	3 1/4"	---	2 27/32"
Inner Trim	3"	7 3/8"	1 21/32"	11/16"	---	5 19/32"	---

AURA

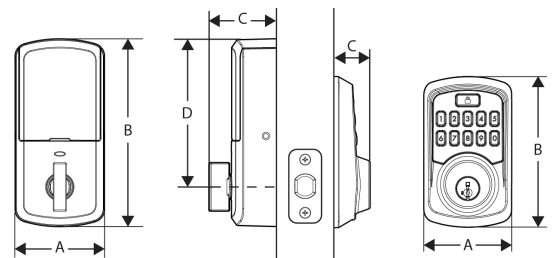

Design	A	B	C	D
Outer Trim	2 3/4"	5 13/16"	2 1/8"	4 9/16"
Inner Trim	2 23/32"	4 5/8"	1 3/16"	---

SMARTCODE™ 260 TRL

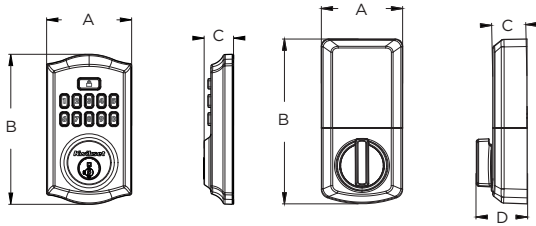

Design	A	B	C	D
Outer Trim	2 13/16"	5"	1"	
Inner Trim	2 3/4"	5 1/2"	1 1/8"	1 11/16"

SMARTCODE™ 260 CNT

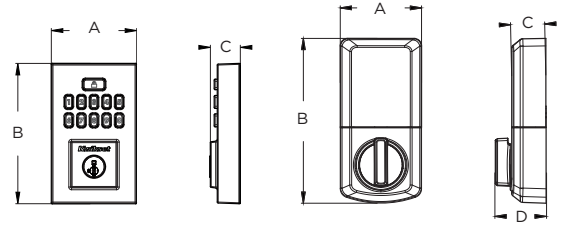

Design	A	B	C	D
Outer Trim	2 3/4"	4 9/16"	1"	
Inner Trim	2 3/4"	5 1/2"	1 1/8"	1 1/4"

SMARTCODE™ 270 TRL

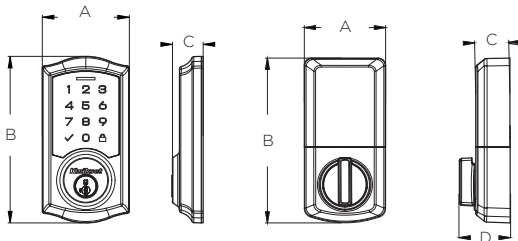

Design	A	B	C	D
Outer Trim	2 3/4"	5 3/16"	1"	
Inner Trim	2 3/4"	5 1/2"	1 1/8"	1 11/16"

SMARTCODE™ 270 CNT

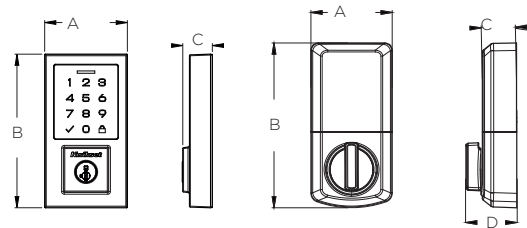

Design	A	B	C	D
Outer Trim	2 3/4"	5 3/16"	1"	
Inner Trim	2 3/4"	5 1/2"	1 1/8"	1 11/16"

SMARTCODE™ 915 / 916 & PREMIS™

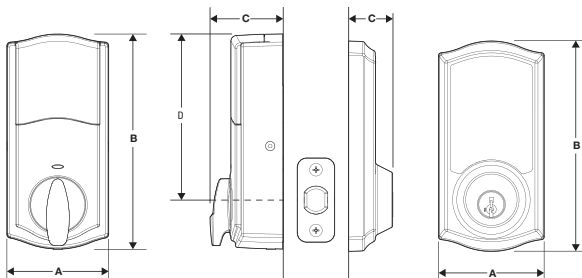

Design	A	B	C	D
Outer Trim	2-13/16"	5-3/8"	1-3/16"	
Inner Trim	2-3/4"	5-3/4"	1-15/16"	4-9/16"

SMARTCODE™ 912

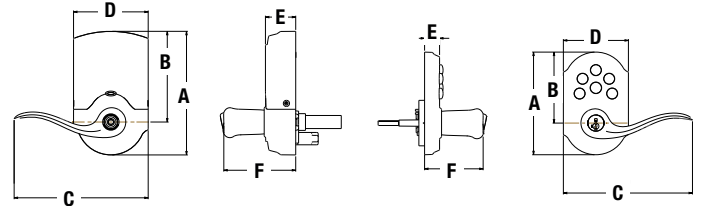

Design	A	B	C	D	E	F
Outer Trim	4 7/16"	3 1/16"	5 19/32"	2 13/16"	2 1/32"	2 17/32"
Inner Trim	5 11/32"	3 15/16"	5 19/16"	3 1/4"	1 5/16"	3 1/8"

Kwikset

KEY CONTROL™ D E A D B O L T

THE SMART ALTERNATIVE TO MASTER KEYING IN A NEW CONTEMPORARY STYLE

Re-keying & managing a traditional master key system is labor intensive, time consuming & costly. With the first & only two cylinder Key Control Deadbolt, either cylinder can be re-keyed in seconds, without removing the lock from the door.

Key Control

- Two separate cylinders, Tenant & Property Manager, allows for more tenant key cuts than a traditional master key system
- New proprietary keyway adds security - the tenant key will never fit into the Property Manager Cylinder
- The Property Manager Cylinder is concealed when not in use to avoid tenant confusion

Increased Efficiency

- Re-key the lock without removing from the door
- Save time & money by re-keying yourself
- Maintain key control throughout tenant and employee turnover



Perfect for multi-family dwellings, student housing, assisted living & rental properties.



#1 SELLING U.S. LOCK BRAND*

*Source: TraQline US quarterly brand unit share report, Q4 2006 through Q2 2020

Interconnect Knobs & Levers - 780 Deadbolt Options



Model	Function	Style	Finish							
			3	L03	5	11P	15	15A	26	26D
506	Entry	Hancock	\$269.60	\$274.60	\$269.60	\$274.60	\$274.60	\$274.60	\$274.60	\$269.60
		Commonwealth	\$269.60	\$274.60		\$274.60	\$274.60			
		Tustin	\$269.60		\$269.60	\$274.60	\$274.60	\$274.60	\$274.60	\$269.60
		Kingston	\$269.60		\$269.60					\$269.60
506 SMT	Entry	Hancock	\$269.60	\$274.60	\$269.60	\$274.60	\$274.60	\$274.60	\$274.60	\$269.60
		Commonwealth	\$269.60	\$274.60		\$274.60	\$274.60			
		Tustin	\$269.60		\$269.60	\$274.60	\$274.60	\$274.60	\$274.60	\$269.60
		Kingston	\$269.60		\$269.60					\$269.60
508	Passage	Hancock	\$252.30	\$257.30	\$252.30	\$257.30	\$257.30	\$257.30	\$257.30	\$252.30
		Commonwealth	\$252.30	\$257.30		\$257.30	\$257.30			
		Tustin	\$252.30		\$252.30	\$257.30	\$257.30	\$257.30	\$257.30	\$252.30
		Kingston	\$252.30		\$252.30	\$257.30	\$257.30			
508 SMT	Passage	Hancock	\$252.30	\$257.30	\$252.30	\$257.30	\$257.30	\$257.30	\$257.30	\$252.30
		Commonwealth	\$252.30	\$257.30		\$257.30	\$257.30			
		Tustin	\$252.30		\$252.30	\$257.30	\$257.30	\$257.30	\$257.30	\$252.30
		Kingston	\$252.30		\$252.30	\$257.30	\$257.30			\$252.30
508 SMC	Passage	Kingston				\$259.80	\$259.80		\$254.80	

- 506 & 505 interconnect functions utilize turn button locking
- Split finish options available

Interconnect Levers - 660 Deadbolt Options

Model	Function	Style	Finish							
			3	L03	5	11P	15	15A	26	26D
505	Entry	Kingston	\$250.20		\$250.20					\$250.20

Interconnect Levers - Handleset Interior Pack Options

Model	Function	Style	Finish							
			3	L03	5	11P	15	15A	26	26D
502	Interior Pack	Tustin				\$162.50	\$162.50			

Interconnect Key Control Deadbolt



Model	Function	Style	Finish							
			3	L03	5	11P	15	15A	26	26D
508 SMT KCDB	Passage	Hancock	\$259.30			\$264.30	\$264.30			
		Commonwealth				\$264.30	\$264.30			
		Tustin	\$259.30			\$264.30	\$264.30			
		Kingston	\$259.30			\$264.30	\$264.30			\$259.30

Contemporary Interconnect Levers - 780 Deadbolt Options



Model	Function	Style	Finish								
			3	5	11P	15	15A	26	26D	514	
506 SMT	Entry	Kingston CNT								\$269.60	
		Ladera CNT			\$274.60	\$274.60			\$274.60	\$269.60	
508	Passage	Kingston CNT			\$257.30	\$257.30				\$252.30	
		Ladera CNT			\$257.30	\$257.30			\$257.30	\$252.30	
508 SMT	Passage	Kingston CNT			\$257.30	\$257.30				\$252.30	\$261.30
		Ladera CNT			\$257.30	\$257.30			\$257.30	\$252.30	

Contemporary Interconnect Levers - 780 Deadbolt Options Split Style

Model	Function	Style	Finish								
			3	L03	5	11P	15	15A	26	26D	
506 SMT	Entry	Ladera LH X Kingston CNT									\$269.60
		Ladera RH X Kingston CNT									\$269.60
508	Passage	Ladera LH X Kingston CNT				\$257.30	\$257.30				\$252.30
		Ladera RH X Kingston CNT				\$257.30	\$257.30				\$252.30
508 SMT	Passage	Ladera LH X Kingston CNT				\$257.30	\$257.30				\$252.30
		Ladera RH X Kingston CNT				\$257.30	\$257.30				\$252.30

Contemporary Interconnect Levers - Interior Pack Options

Model	Function	Style	Finish								
			3	L03	5	11P	15	15A	26	26D	
502	Interior Pack	Ladera				\$162.50	\$162.50			\$162.50	\$157.50
502	Interior Pack	Kingston									\$157.50

Key Control Deadbolt



Model	Function	Finish									Case Qty	
		3	L03	5	11P	15	15A	26	26D	514		
816 SMT	Key Control Deadbolt	\$78.90		\$78.90	\$86.90	\$86.90				\$78.90		12
816 SMC	Key Control Deadbolt	\$81.40			\$89.40	\$89.40				\$81.40		12
817 SMT	Key Control Deadbolt UL				\$93.90	\$93.90				\$85.90		12
816 SQT	Single Cylinder					\$86.90		\$86.90			\$89.90	12
817 SQT UL	Single Cylinder UL					\$93.90		\$93.90			\$96.90	12

SmartCode™ 955



Model	Description	Finish									Case Qty	
		3	L03	5	11P	15	15A	26	26D	514		
955	Touchpad Electronic Lever				\$237.00	\$237.00				\$237.00	\$237.00	2

GRADE 2 LEVERS

 Kingston™	Model	Function	Finish							
			3	L03	5	11P	15	15A	26	26D
	721KNL UL	Hall/Closet	\$59.10			\$64.10	\$64.10			\$59.10
	733KNL UL	Bed/Bath	\$63.10			\$68.10	\$68.10			\$63.10
	756KNL UL	Keyed entry UL	\$88.80			\$93.80	\$93.80			\$88.80
	756KNL SMT UL	Keyed entry UL	\$88.80			\$93.80	\$93.80			\$88.80
	756KNL SMC UL	Keyed Entry UL	\$91.30			\$96.30	\$96.30			\$91.30
	781KNL UL	Storeroom UL	\$91.80			\$96.80	\$96.80			\$91.80
	781KNL SMT UL	Storeroom UL	\$91.80			\$96.80	\$96.80			\$91.80
	788KNL	Half Dummy	\$29.60			\$32.10	\$32.10			\$29.60

GRADE 3 LEVERS

 Carson™	Model	Function	Finish							
			3	L03	5	11P	15	15A	26	26D
	407CNL	Passage UL	\$42.70			\$47.70	\$47.70			\$42.70
	408CNL	Privacy UL	\$46.70			\$51.70	\$51.70			\$46.70
	438CNL UL	Entry UL	\$72.40			\$77.40	\$77.40			\$72.40
	438CNL SMT UL	Entry UL	\$72.40			\$77.40	\$77.40			\$72.40
	438CNL SMC UL	Entry UL					\$79.90			\$74.90
	439CNL UL	Storeroom UL	\$75.40			\$80.40	\$80.40			\$75.40
	439CNL SMT UL	Storeroom UL	\$75.40			\$80.40	\$80.40			\$75.40
	488CNL	Half Dummy	\$21.40			\$23.90	\$23.90			\$21.40

 Burbank™	Model	Function	Finish							
			3	L03	5	11P	15	15A	26	26D
	407BBL	Passage UL	\$42.70			\$47.70	\$47.70		\$47.70	
	408BBL	Privacy UL	\$46.70			\$51.70	\$51.70		\$51.70	
	438BBL	Entry UL	\$72.40			\$77.40	\$77.40		\$77.40	
	439BBL	Storeroom UL	\$75.40			\$80.40	\$80.40		\$80.40	
	488BBL	Half Dummy	\$21.40			\$23.90	\$23.90		\$23.90	

 Palmina	Model	Function	Finish							
			3	L03	5	11P	15	15A	26	26D
	407PLL	Passage UL				\$47.70	\$47.70		\$47.70	\$42.70
	408PLL	Bed/Bath UL				\$51.70	\$51.70		\$51.70	\$46.70
	438PLL SMT	Entry SMT UL				\$77.40	\$77.40		\$77.40	\$72.40
	488PLL	Half Dummy				\$23.90	\$23.90		\$23.90	\$21.40

*For 438PLL Function must specify RH or LH when ordering

INTERCONNECT

Door Prep	Crossbore 2-1/8" Edge Bore 1" 5-1/2 center-to-center only.
Backset	Must specify backset 2-3/8" or 2-3/4".
Door Thickness	1-3/8" - 2-1/4"
Cylinder	<ul style="list-style-type: none"> 506, 508 - utilize 6-pin or SmartKey on 780 deadbolt. 505 - utilize 5-pin on 660 deadbolt. 502 - determined by handleset ordered. SmartKey Security or Pin & Tumbler.
Faceplates	Complete locksets: No Default—must specify faceplate. 1" round corner, 1" square corner, 1-1/8 WFL square. Complete locksets: UL 3028, 3031, (WFL option 3846).
Strikes	Deadbolt Strike: UL 5278, 3223 (WFL 4632 opt.).
Door Handing	<ul style="list-style-type: none"> 506, 508, 505 - reversible. 502 - specify handing.
ANSI/BHMA	<ul style="list-style-type: none"> 506, 508, 505 - Grade 3 Certified. 502 - Determined by handleset ordered.
ADA	Lever options are in compliance with the American National Standards Institute (ANSI A117.1) and the Americans with Disabilities Act (ADA).
UL	Meets UL 3 hour fire rating for all functions except 502.
Interior Locking	<ul style="list-style-type: none"> Push button (for Kingston & Carson). Turn button (for Interconnect).

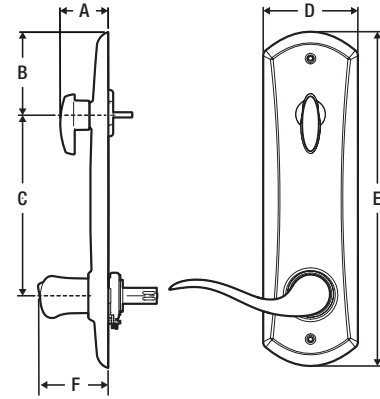

Design	A	B	C	D	E	F
Interconnect	1-7/16"	2-15/32"	5-1/2"	2-53/64"	10"	2-31/32"

CONTEMPORARY INTERCONNECT

Door Prep	2-1/8" diameter face hole & 1" diameter latch hole.
Backset	Must specify backset 2-3/8" or 2-3/4".
Door Thickness	1-3/8" - 1-3/4" automatic adjustment.
Cylinder	<ul style="list-style-type: none"> 506 and 508 utilize 6-pin or SmartKey Security on 780 deadbolt. 505 utilize 5-pin on 660 deadbolt. 502 - determined by handleset ordered.
Faceplates	1" x 2-1/4" round corner standard.
Strikes	Deadbolt Strike: UL 5278, 3223 (WFL 4632 opt.).
Door Handing	<ul style="list-style-type: none"> 506, 508, 505 - reversible. 502 - specify handing.
ANSI/BHMA	<ul style="list-style-type: none"> 506, 508, 505 - Grade 3 Certified. 502 - Determined by handleset ordered.
ADA	Lever options are in compliance with the American National Standards Institute (ANSI A117.1) and the Americans with Disabilities Act (ADA).
UL	Meets 3 hour fire rating.

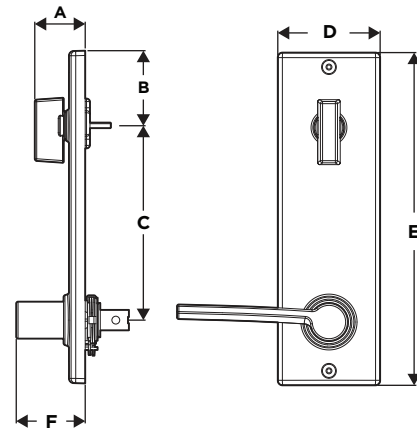

Design	A	B	C	D	E	F
Interconnect	1-13/32"	2-1/16"	5-1/2"	2-27/32"	9-3/16"	1-29/32"

KEY CONTROL

Standard Door Prep Cross Bore 2-1/8", Edge Bore 1"
Latch Face 1" x 2-1/4"

Door Thickness 1-3/4"

Cylinder 2 SmartKey Security™ cylinders: 1 standard Kwikset for users, 1 unique patented keyway for 1-Key Control

Faceplate 1" x 2-1/4"

Strike 1 1/4" x 3-5/8"

Bolt 1" throw

ANSI/BHMA A156.5 Grade 2

ADA Interior turn piece meets 4.13.9 ADA

UL Meets UL 3 hour fire rating for UL function. UL Ref# R10923

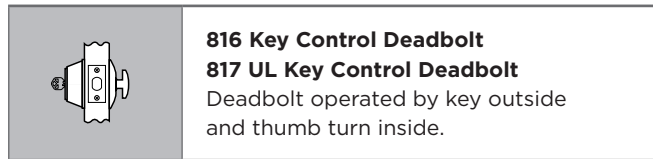

Traditional Design

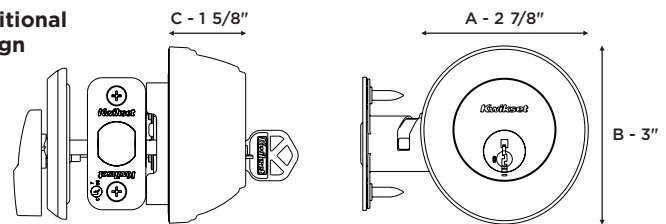

Contemporary Design

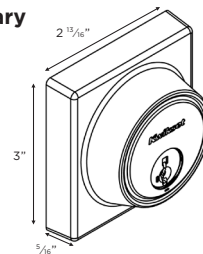

SMARTCODE 955

Function Keyed entry electronic lever

Door Prep 2 1/8" diameter face hole & 1" diameter latch hole

Backset Adjustable 2 3/8" or 2 3/4"

Door Thickness 1 3/8" - 1 3/4"

Faceplates 1" x 2 1/4" round corner standard

Strikes Round corner, 4 hole strike, 2 3/4" x 1 1/8"

Latch Round corner adjustable 2 3/8" x 2 3/4"

Bolt 1/2" throw, dead latch

Door Handing Reversible

Cylinder SmartKey Security™

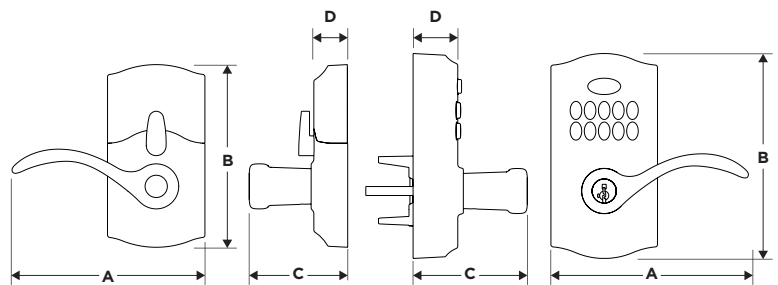

Design	A	B	C	D
Interior	5 5/8" (142.9)	5 5/16" (134.9 mm)	2 7/8" (73 mm)	3 1/32" (24.6 mm)
Exterior	5 3/4" (146 mm)	5 31/32" (151.6 mm)	3 5/16" (84.1 mm)	1 13/32" (35.7 mm)

KINGSTON LEVER

ANSI/BHMA	Grade 2 Certified
Door Prep	Crossbore 2-1/8" Edge Bore 1"
Backset	Adjustable to 2-3/8" or 2-3/4".
Door Thickness	1-3/8" – 1-3/4" doors standard
Cylinder	SmartKey Security or Pin & Tumbler.
Latch	Adjustable to 2-3/8" or 2-3/4" Specify round corner or square corner, WFL.
Strikes	2-1/4" full lip UL. Specify round corner or square corner. Other options include 2-3/4" T-Strike and 4-7/8" ASA.
Bolt	1/2" throw.
Door Handing	Reversible for right or left-hand doors.
ADA	Lever options are in compliance with the American National Standards Institute (ANSI A117.1) and the Americans with Disabilities Act (ADA).
UL	Meets UL 3 hour fire rating for all functions
Warranty	Lifetime Mechanical, 5 Year Finish
Interior Locking	Push button (for Kingston & Carson) Turn button (for Interconnect)

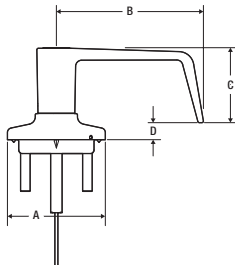

Design	A	B	C	D
Kingston	2.56"	3.84"	1.96"	.44"

CARSON LEVER

ANSI/BHMA	Grade 3 Certified
Door Prep	Crossbore 2-1/8" Edge Bore 1"
Backset	Adjustable to 2-3/8" or 2-3/4".
Door Thickness	1-3/8" – 1-3/4" doors standard
Cylinder	SmartKey Security or Pin & Tumbler.
Latch	Adjustable to 2-3/8" or 2-3/4" Specify round corner or square corner, WFL.
Strikes	2-1/4" full lip UL. Specify round corner or square corner. Other options include 2-3/4" T-Strike and 4-7/8" ASA.
Bolt	1/2" throw.
Door Handing	Reversible for right or left-hand doors.
ADA	Lever options are in compliance with the American National Standards Institute (ANSI A117.1) and the Americans with Disabilities Act (ADA).
UL	Meets UL 3 hour fire rating for all functions
Warranty	Lifetime Mechanical, 5 Year Finish
Interior Locking	Push button (for Kingston & Carson) Turn button (for Interconnect)

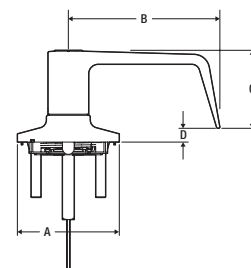

Design	A	B	C	D
Carson	2.56"	3.80"	1.96"	.35"

BURBANK LEVER

ANSI/BHMA	Grade 3 Certified
Door Prep	Crossbore 2-1/8" Edge Bore 1"
Backset	Adjustable to 2-3/8" or 2-3/4".
Door Thickness	1-3/8" – 1-3/4" doors standard
Cylinder	Pin & Tumbler.
Latch	RCAL, SCAL, WFAL, NFL
Strikes	ASA-1 t-strike, Full Lip SCS UL, Full Lip 1/4" RCS UL, T Strike
Bolt	1/2" throw.
Door Handing	Reversible for right or left-hand doors.
ADA	Lever options are in compliance with the American National Standards Institute (ANSI A117.1) and the Americans with Disabilities Act (ADA).
UL	Meets UL 3 hour fire rating for all functions
Warranty	Lifetime Mechanical, 5 Year Finish

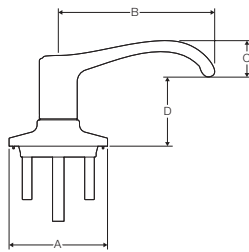

Design	A	B	C	D
Burbank	2.6"	4.07"	0.94"	1.79"

PALMINA LEVER

ANSI/BHMA	Grade 2 Certified
Door Prep	Crossbore 2-1/8" Edge Bore 1"
Backset	Adjustable to 2-3/8" or 2-3/4".
Door Thickness	1-3/8" – 1-3/4" doors standard
Cylinder	SmartKey
Latch	RCAL, SCAL, WFAL, NFL
Strikes	ASA-1 t-strike, full Lip SCS UL, Full lip 1/4" RCS UL, T Strike
Bolt	1/2" throw.
Door Handing	Reversible for right or left-hand doors.
ADA	Lever functions satisfy 4.13.9 ADA requirements
UL	Meets UL 3 hour fire rating for all functions
Warranty	Lifetime Mechanical, 5 Year Finish
Interior Locking	Push button

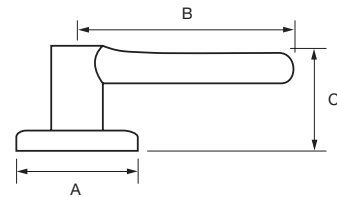

Design	A	B	C
Palmina	2.56"	3.75"	1.96"

POCKET DOOR LOCKS,
SMARTKEY SECURITY
PADLOCKS, TRIMS
& INSTALLATION KIT

Round Pocket

Door Lock	Model	Function											Case
			3	L03	5	11p	15	15A	26	26D	32	514	Qty
	334	Passage				\$42.70	\$42.70			\$42.70	\$42.70	\$42.70	12
	335	Privacy				\$46.80	\$46.80			\$46.80	\$46.80	\$46.80	12



Contemporary Pocket Door Lock

Lock	Model	Function											Case
			3	L03	5	11p	15	15A	26	26D	32	514	Qty
	334SQT	Passage				\$42.70	\$42.70			\$42.70	\$42.70	\$42.70	12
	335SQT	Privacy				\$46.80	\$46.80			\$46.80	\$46.80	\$46.80	12



SmartKey Padlocks

Part #	Model	List Price	Case	
			Qty	
	026SMT STD 1-1/8" SHKL PDL 50MM	SmartKey Security Padlock Standard Shackle	\$27.40	6
	026SMT LNG 2" SHKL PDL 50MM	SmartKey Security Padlock Long Shackle	\$28.70	6

* Keyed Alike 6

Trims

Model	Description	Finish				Pkg	Case
		3	5	15	26D		Qty
293	Round Rosette	\$19.70			\$20.80	CP	4





138 Installation Kit

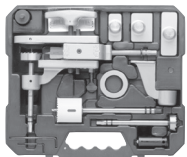

Model	Description	Qty per Pack	Master Pk Qty	List Price
91380-001	138 Installation Kit	1	1	\$691.40

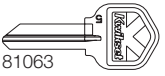
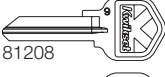

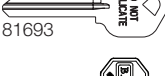
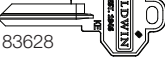
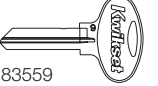
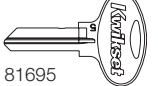
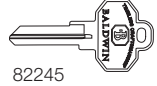
**Kwikset
Key Blanks**

	Model	Function	Qty	List Price
 81063	81063-009	K Bow, Nickel Plated, 5 Pin	50	\$1.90
 81208	81208-001	K Bow, Nickel Plated, 6 Pin (UltraMax)	50	\$1.90
 81209	81209-001	Solid Bow Builders Key, 6 Pin	50	\$1.90
 81210	81210-001	Solid Bow Masters Key	50	\$1.90
 81693	82205-002	Solid Bow Builders Key, 5 Pin	50	\$1.90
 83628	81693-001	Do Not Duplicate Key	50	\$1.90
	81693-002	Do Not Duplicate keys (Cut Keys)	50	\$2.80
	83559-008	Large Bow, Builder Key, 6 Pin	50	\$1.90
	81695-001	Large Bow, Builder Key, 5 Pin	50	\$1.90
	82245-001	Baldwin K-Key	50	\$2.60
	83628-001	Baldwin C-Key	50	\$2.80
	 83559	 81695	 82245	

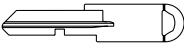
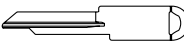
**Control Key Blanks
(Rekeying Tools)**

	Model	Function	Qty	List Price
 87615-001	87615-001	Kwikset 6-Pin Knobs and Deadbolts	50	\$1.90
 88122-001	88122-001	Kwikset 6-Pin Knobs and Deadbolts, MK	50	\$1.90
 88485-005	88485-005	Kwikset Knobs and Deadbolts, Schlage® C	12	\$1.90
	81804-001	Kwikset Key-In Lever, Standard "TC"	50	\$1.90
	89991-001	Kwikset, Schlage® C	50	\$1.90

Emergency Key

	Model	Function	Qty	List Price
 81087-001	81087-001	For All Privacy Function Locksets	100	\$0.50

***NOTE:** Use Hex Wrench for push button privacy locksets.

Depth Key

	Model	Function	Qty	List Price
	88596-001	Depth Key Ring (Order in full pack quantities only)	5	\$10.20

**Extra Cut Keys
6 Pin**

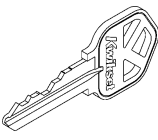
	Model		Function	List Price
	Random Cut	Specify Cut		
	81208-002	90009-074	Regular Key	\$3.70
	81210-002	90009-066	Master Key	\$4.80
	81209-002	90009-069	Builders Key	\$3.70
		90009-082	Control key	\$1.90

**Extra Cut Keys
5 Pin**

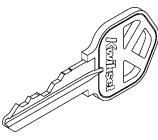
	Model		Function	List Price
	Random Cut	Specify Cut		
	81063-005		Regular Key	\$2.40
	81057-007		Set of 8 Keys/Ringed	\$22.50
	85991-001	90009-003	Master Key	\$4.10
	82205-001	90009-004	Builders Key	\$3.50

***NOTE:** Must specify desired key cut when placing order.

**Keying Charges
& Supplies**

Model	Function	Qty	List Price
8497-75	Kwikset Signature Series Knob, Schlage® keyway less cylinder cover (3, 26)	6	\$17.60
8497-76	Kwikset Signature Series Knob, Weiser keyway less cylinder cover (3, 26)	6	\$17.60
81354	Kwikset Signature Series Commonwealth Lever, Weiser cylinder (3, 26D)	6	\$25.10
81355	Kwikset Signature Series Commonwealth Lever, Schlage cylinder (3, 26D)	6	\$25.10
81236	980/985 Deadbolt double cylinder cover - interior (15, 15A, 26, 26D, 3, 5, L03,11P)	12	\$1.60
81327	780/785 Deadbolt single cylinder cover - exterior (15, 15A, 26, 26D, 3, 5, L03,11P)	12	\$1.60
81328	780/785 Deadbolt double cylinder cover - interior (3, 5, 11P)	12	\$1.60
87748-001	Knob plug - Kwikset 6 pin brass finish	20	\$2.10
87807-001	Deadbolt plug - Kwikset Signature Series 6-pin brass finish	20	\$2.10
87807-002	Deadbolt plug - Kwikset Signature Series 6-pin nickel finish	20	\$2.10
88485-005	Rekeying Tool - Schlage®	12	\$1.60

NOTES:

Order in full pack quantities only. Must specify finish in order.

Competitive keying program not compatible with SmartKey product.

Keying Kits

Model	Function	Qty	List Price
92360-001	236 Builder Pin Kit - small	1	\$177.90
92720-001	272 Pin Kit	1	\$314.40



**Specialty Keying
Charges**

Code	Description	List Price
MK	Master Keying	\$3.20
PK	Builder Keying (Protecto)	\$3.20
GMK	Grand Master Keying	\$8.90
PMK	Builder Master Keying	\$5.60
MAIS	Cross Keying / Maison Keying	\$6.60
SEQ	Sequential Construction Master Keying	\$10.80

Replacement Parts for Kwikset Pin and Tumbler Keying

Model	Pin Size	Qty	List Price
80049-001	Key Gauge	1	\$8.30
80152-001	Plug Follower	1	\$8.80
80369-001	PK Anti-Pick Top Pin .160"	100	\$40.00
80370-001	Regular Anti-Pick Top Pin .180"	100	\$40.00
80371-001	Low Profile Deadbolt Spring Cover	10	\$1.50
81467-003	Cylinder Removal Tool	1	\$2.10
81777-001	Tumbler Spring	100	\$0.20
81858-001	Regular Top Pin .180"	100	\$20.00
82208-001	PK Balls	100	\$0.20
83100-001	#1 Bottom Pin .172"	100	\$20.00
83101-001	#2 Bottom Pin .195"	100	\$20.00
83103-001	#3 Bottom Pin .218"	100	\$20.00
83105-001	#4 Bottom Pin .241"	100	\$20.00
83106-001	#5 Bottom Pin .264"	100	\$20.00
83107-001	#6 Bottom Pin .287"	100	\$20.00
83108-001	#1 Master Pin .023"	100	\$20.00
83110-001	#2 Master Pin .046"	100	\$20.00
83112-001	#3 Master Pin .069"	100	\$20.00
83113-001	#4 Master Pin .092"	100	\$20.00
83114-001	#5 Master Pin .115"	100	\$20.00
83117-001	PK Top Pin .160"	100	\$20.00
83125-001	#6 Master Pin .138"	100	\$20.00
83561-001	Spring Cover (6-Pin)	50	\$1.40
84345-001	Knob Plug Retainer	100	\$0.20
84215-001	Deadlock Plug Retainer	100	\$0.20
85757-001	Spring Cover (5-Pin)	50	\$1.40
87619-001	Knob Control Lug (Locking Bar)	100	\$0.40
87632-001	Spring	100	\$0.60
87809-001	Deadlock Control Lug (Locking Bar)	100	\$0.70

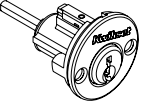
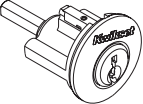
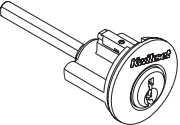
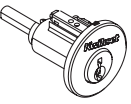
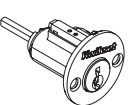
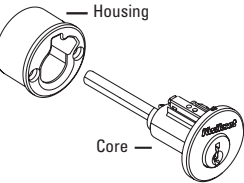
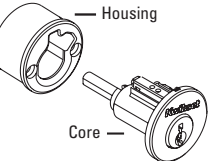
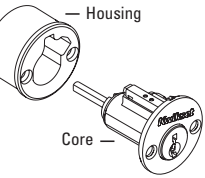
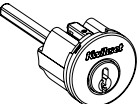
Deadbolt Cylinders

	Model	Function	List Price
	90009-016	2776 - 665 Interior (5 Pin)	\$18.30
	90009-017	2777 - 665 Exterior (5 PIN)	\$18.30
	90009-041	15843 - 660 Exterior (5 Pin)	\$18.30
	90009-045	785 Exterior without Housing (6 PIN)	\$20.70
	90009-046	785 Interior without Housing	\$20.70
 <p>— Housing</p> <p>Core —</p>	90009-010	87765 - 780 with Housing, Complete Assembly	\$26.60
	87894-001	07894-01 Housing Only, Outside	\$6.00
	90009-044	8325 - 780 Core without Housing	\$20.70
 <p>— Housing</p> <p>Core —</p>	90009-019	7766 - 785 Exterior with Housing, Complete Assembly	\$26.60
	87894-001	07894-01 Housing Only, Outside	\$6.00
 <p>— Housing</p> <p>Core —</p>	90009-020	7767 - 785 Interior with Housing, Complete Assembly	\$26.60
	90009-065	13443 980/ 993 CYL G1 (6 PIN)	\$53.90
	81227	13423 CVR CYL BDY EXT G1	\$1.60
	90009-078	13448 985 CYL Interior (6 PIN)	\$55.20
	90009-079	13450 985 CYL Exterior (6 PIN)	\$53.90

Pin & Tumbler Knob Cylinders

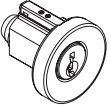
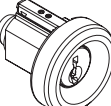
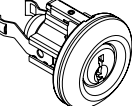
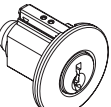
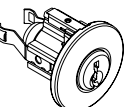
	Model	Function	List Price
	90009-011	7750A - Abbey (6 PIN)	\$16.80
	90009-012	13754 - Circa (6 PIN)	\$16.80
	90009-042	15860 - Polo (5 PIN)	\$22.50
	90009-043	13752 - Hancock (6 PIN)	\$16.80
	90009-013	1850 - All Other Kwikset and Kwikset Signatures Knobs	\$22.50

Pin & Tumbler Lever Cylinders

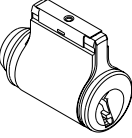
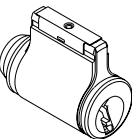
	Model	Function	List Price
	90009-077	24042 - 5-Pin P&T Cylinder	\$19.00
	90009-076	21664 Kwikset Signatures Lever Cylinder (6 PIN)	\$19.00

Pin & Tumbler Light Commercial Lever Cylinders

	Model	Function	List Price
	83525	14831 Light Commercial Grade 2 P&T Entry Cylinder	\$16.60
	83011	14845 Light Commercial Grade 3 P&T Entry Cylinder	\$16.60
	83526	19496 Light Commercial Grade 2 P&T Storeroom Cylinder	\$16.60
	83528	19497 Light Commercial Grade 3 P&T Storeroom Cylinder	\$16.60

NOTE: Must specify finish when ordering cylinders

Smartkey Security Cylinders

Model	Function	Finish										List Price
		LO3	3	5	15	15A	26	26D	690/11P	514	NA	
83279	SMT Knob/Lever Cylinder Only	Gold			Silver				Bronze	Black		\$24.60
83373	SMT Deadbolt Cylinder Plug Only (Single Cylinder)	Gold			Silver				Bronze	Black		\$24.60
83025	SMT Deadbolt Cylinder Only for 258 and 818 Model	Gold			Silver					Black		\$24.60
83280	SMT CN, C, H, T, CV Cylinder With Housing	•		•	•	•	•	•	•	•		\$24.60
83320	SMT CA, A Cylinder With Housing	•	•	•	•	•	•	•	•			\$24.60
83281	SMT 780/980 DB With Housing	•	•	•	•	•	•	•	•			\$54.70
83343	SMT 660 DB with Housing	•		•	•	•	•	•	•			\$26.30
83344	SMT 665 DB with Housing Interior & Exterior	•		•	•	•	•	•	•			\$52.50

Smartkey Security Re-Key Kits

Model	Function	Finish										List Price	
		3	LO3	5	15	15A	26	26D	690/11P	514	NA		
83262	Carded CP Rekey Kit (4 silver/2 brass)											•	\$18.20
83335	4 cut keys with a rekey tool											•	\$6.40
83336	6 cut keys with a rekey tool											•	\$7.10

Smartkey Security Conversion Kits

Model	Function	Finish										List Price	
		3	LO3	5	15	15A	26	26D	690/11P	514	NA		
83325	Abbey	•	•	•	•	•	•	•	•				\$32.00
83328	Hancock, Tylo, and Cove	•	•	•	•	•	•	•	•	•			\$32.00
83377	Polo	•		•	•	•	•	•	•				\$32.00
83326	780/980/800	•	•	•	•	•	•	•	•	•			\$57.60
83327	785	•	•	•	•	•	•	•	•	•			\$79.90
83340	985 /801	•	•	•	•	•	•	•	•	•			\$79.90

Re-Keying Tools

Model	Function	Finish										List Price	
		3	LO3	5	15	15A	26	26D	690/11P	514	NA		
83282	Steel Learn Tool											•	\$1.20
83283	Red Plastic KW Learn Tool											•	\$3.70
83576	Learn Tool, T shape											•	\$4.40
83260	Reset Cradle											•	\$54.50
83338	Large Knob/Lever C-clip											•	\$0.80
83337	Large Deadbolt C-clip											•	\$0.80
83374	SmartKey Full Round Spindle											•	\$1.30

Smartkey SC1 Security Cylinders

Model	Function	Finish										Case Qty	List Price
		3	LO3	5	15	15A	26	26D	690/11P	514			
	85170	Dbl Cyl Deadbolts Exterior (554/801/985/785/159/689/665)	Gold	Gold	Gold	Silver	Silver	Silver	Silver	Black	Black	100	\$24.60
	85171	Dbl Cyl Deadbolts Interior (967/976/979/985/785/159/689/665)	Gold	Gold	Gold	Silver	Silver	Silver	Silver	Black	Black	100	\$24.60
	85172	"Knob/Levers (Half Round Chassis) Lever Electronics (917/955)"	Gold	Gold	Gold	Silver	Silver	Silver	Silver	Black	Black	100	\$24.60
	85200	Levers (Square Drive Chassis)	Gold	Gold	Gold	Silver	Silver	Silver	Silver	Black	Black	100	\$24.60
	85173	Sgl Cyl - Low Profile Deadbolts (818/258)	Gold	Gold	Gold	Silver	Silver	Silver	Silver	Black	Black	100	\$24.60
	85174	Sgl Cyl Deadbolts (553/800/980/780/158/687/660) Electronic Deadbolts (620/888/907/909/913/915/916/919/925/938/939/942/953)	Gold	Gold	Gold	Silver	Silver	Silver	Silver	Black	Black	100	\$24.60

SmartKey SC1 Key Blanks

Model	Function	QTY	List Price
85178-001	SC1, Kwikset, 5 Pin Key	50	\$89.40
85182-001	SC1, Kwikset, Do Not Duplicate, 5 Pin Key	50	\$92.20

SmartKey SC1 Cut Keys

Model	Function	CASE	List Price
85175-001	SC1, Kwikset, Single 5 Pin Key	100	\$2.40
85176-001	SC1, Kwikset, Four 5 Pin Keys on Ring, Learn Tool, SC1 Instructions	100	\$11.70
85177-001	SC1, Kwikset, Four Sets of Two 5 Pin Keys on Ring	100	\$22.50
85183-001	SC1, Kwikset, Do Not Duplicate, Single 5 Pin Key	100	\$3.50
90009-085	SC1, Kwikset, Do Not Duplicate Key, Specific Cut	100	\$3.50

SmartKey SC1 Misc Service Parts

Model	Function	Order QTY	QTY	List Price
85179-001	"Deadbolt Large C-Clip, 50 Pack (Used with 81574)"	1	40	\$40.00
85180-001	SC1 Learn Tool & SC1 Instructions, 50 Pack	1	20	\$69.10
85181-001	SC1 Reset Tool	1	50	\$27.30

Key Control Deadbolt Parts

	Model	Function	Finish							Qty	List Price	
			3	5	11P	15	26	26D	N/A			
	83382	Key Control Deadbolt Key Blanks								•	1	\$0.40
	83383	Key Control Deadbolt Cut Keys								•	1	\$0.50
	83389	Key Control Deadbolt Cylinder Cover	•	•	•	•			•		1	\$3.00
	83390	Key Control Deadbolt Mounting Screws	Gold				Silver				1	\$7.00
	83388	Key Control Deadbolt Torque Blade								•	1	\$0.20
	83386	Key Control Deadbolt Gear Assembly								•	1	\$7.90
	83387	Key Control Deadbolt Screws for Gear Assembly								•	1	\$1.60
	83392	Key Control Deadbolt Tool								•	1	\$4.70
	83393	Key Control Deadbolt Security Mounting Screws	Gold	Gold		Silver	Silver	Silver			1	\$4.70
	83394	Key Control Deadbolt Screw Torx Wrench								•	1	\$6.30
	83397	Key Control Deadbolt Thin Door Kit	•			•			•		1	\$15.50

Deadbolt Adjustable Latches

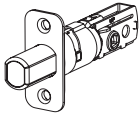
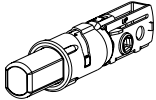
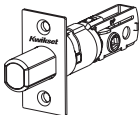
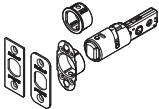
	Model	Latch	Function	Finish							List Price	
				3	5	15	15A	26/26D	690/11P	514		NA
	81305	RCAL	660 Series Deadbolt Standard	•	•	•	•	•	•			\$12.20
	81258	RCAL	780/782/816/817/980/982 Series Deadbolt Standard UL 3 hour	•		•		•	•			\$31.30
	83347	RCAL	158/780/816/980 Deadbolt Standard	•	•	•	•	•	•	•		\$18.90
	80391	RCAL	Tapered Bolt Deadbolt*	•		•			•			\$31.30
*Replacement Only												
	81306	RFAL	660 Series Deadbolt Standard								•	\$12.20
	83371	RFAL	158/780/816/980/982 Series Deadbolt Standard								•	\$18.90
	80393	RFAL	Tapered Deadbolt Latch Kit	•		•				•		\$31.30
	*Replacement Only											
	81308	SCAL	660 Series Deadbolt Standard	•	•	•	•	•	•			\$12.20
	84513	SCAL	780/782 Series Deadbolt Standard UL 3 hour	•	•	•	•	•	•			\$22.70
	81257	SCAL	816/817/980/982 Series Deadbolt Standard UL 3 hour latch	•		•		•	•			\$31.30
	83370	SCAL	158/780/816/980 Series Deadbolt Standard	•	•	•	•	•	•	•		\$18.90
*Replacement Only												
	83023	6AL	6AL 258/818 Series Deadbolt			•		•	•	•		\$26.50

Deadbolt Specialty Latches

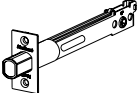
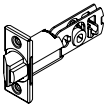
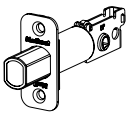
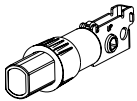
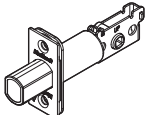
	Model	Latch	Function	Finish							List Price	
				3	5	15	15A	26/26D	690/11P	514		NA
	82730	5L	5" Kwikset (replacement part only)	•	•			•				\$18.30
	83277	Gatelatch	Gatelatch Standard	•	•			•				\$30.00
	82731	RCL	2-3/8" Backset	•	•			•	•			\$13.30
	82732	RCL	2-3/4" Backset	•	•			•	•			\$13.30
	82734	RFL	2-3/8" Backset								•	\$13.30
	82735	RFL	2-3/4" Backset								•	\$13.30
	82728	SCL	2-3/8" Backset	•	•			•	•			\$13.30
	82729	SCL	2-3/4" Backset	•	•			•	•			\$13.30

Adjustable Latches (Square Drive)

	Model	Latch	Function	Finish								List Price
				3	5	15	15A	26/26D	690/11P	514	NA	
	83480	6AL	6AL Plain Latch HFL ,MIL, LSL, MRL, SYL, SAL			•		•	•	•		\$15.90
	83000	6AL	6AL Deadlatch BBL, KNL, CNL, HFL, MIL, LSL, MRL, PLL, SYL , SAL			•		•	•	•		\$17.20
	83521	RCAL	RCAL Plain Latch UL 3 hour BBL, KNL, CNL, PLL	•		•		•	•			\$13.50
	83518	RCAL	RCAL Deadlatch UL 3 HOUR BBL, KNL, CNL, HFL, MIL, LSL, MRL, PLL, SYL, SAL	•		•		•	•			\$15.80
	83522	WFAL	WFAL SCL Plain Latch UL 3 hour BBL, KNL, CNL, PLL	•		•		•	•			\$13.50
	83010	WFAL	WFAL SCL Deadlatch UL 3 hour BBL, KNL, CNL, HFL, MIL, LSL, MRL, PLL, SYL, SAL	•		•		•	•			\$15.80
	83520	SCAL	SCAL Plain Latch UL 3 HOUR BBL, KNL, CNL, PLL	•		•		•	•			\$13.50
	83517	SCAL	SCAL Deadlatch UL 3 HOUR BBL, KNL, CNL, HFL, MIL, LSL, PLL, SAL	•		•		•	•			\$15.80

Adjustable Latches (Half-Round Drive)

	Model	Latch	Function	Finish								List Price
				3	5	15	15A	26/26D	690/11P	514	NA	
	81825	6AL	6AL Deadlatch	•	•			•				\$15.80
	81826	6AL	6AL Plain Latch	•	•			•				\$13.50
	82246	RCAL	RCAL Plain Latch	•	•	•	•	•	•	•		\$13.50
	82247	RCAL	RCAL Deadlatch	•	•	•	•	•	•	•		\$15.80
	81846	Core Latch	Adjustable Latch Core - Deadlatch								•	\$11.60
	81847	Core Latch	Adjustable Latch Core - Plain Latch								•	\$8.20



Key:

5L - 5" Latch	RFAL - Round Face Adjustable Latch
RCL - Round Corner Latch	SCAL - Square Corner Adjustable Latch
RFL - Round Face Latch (Drive-In Collar attached)	WFAL - Wide Face Adjustable Latch
SCL - Square Corner Latch	NFAL - Narrow Face Adjustable Latch
RCAL - Round Corner Adjustable Latch	FD - Latch

NOTES:

For BBL, KNL, CNL, HFL, MIL, PLL, MRL, LSL, and SYL products use square drive plain and deadlatches. All other Kwikset & Kwikset Signature knob and lever products use half-round plain and deadlatches. Plainlatches are used with passage and privacy functions. Deadlatches are used with entry functions. All fronts are 2-1/4" high. For fire rating, UL latches must be used with UL listed locksets and applicable strikes. UL Kwikset and Kwikset Signatures are rated for 3 hours, unless otherwise specified. Optional UL 1/3 hour fire rating is available for all functions (FD).

Half Round Latch Parts

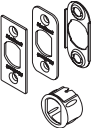
	Model	Latch	Function	Finish							List Price	
				3	5	15	15A	26/26D	690/11P	514		NA
	81827	Back Plate	6-Way Back Plate								•	\$0.20
	* For use with Kwikset Half Round Latches											
	81828	Drive In Collar	6-Way Deadlatch Collar								•	\$2.20
	81829	Drive In Collar	6-Way Plain Latch Collar								•	\$2.20
	* For use with Kwikset Half Round Latches											
	81844	Service Kit	6-Way Deadlatch Service Kit	•	•	•	•	•	•	•		\$5.70
	81845	Service Kit	6-Way Plain Latch Service Kit	•	•	•	•	•	•	•		\$4.30
	* For use with Kwikset Half Round Latches											

Specialty Deadlatches

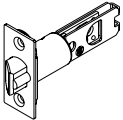
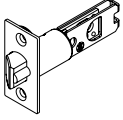
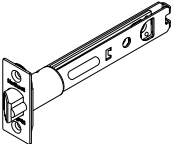
	Model	Latch	Function	Finish							List Price	
				3	5	15	15A	26/26D	690/11P	514		NA
	84292	SCDL	2-3/4" Backset - UL 3 hour	•		•		•	•			\$29.10
	84297	SCDL	2-3/8" Backset - UL 3 hour	•		•		•	•			\$29.10
	84255	WFDL	2-3/4" Backset - UL 3 hour	•		•		•	•			\$29.10
	84295	WFDL	2-3/8" Backset - UL 3 hour	•		•		•	•			\$29.10
	83014	5L SCDL	5" Latch (replacement part only)	•				•				\$21.10



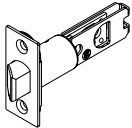
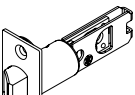

Specialty Plainlatches

	Model	Latch	Function	Finish							List Price	
				3	5	15	15A	26/26D	690/11P	514		NA
	84290	SCPL	2-3/4" Backset - UL	•		•		•	•			\$21.90
	84296	SCPL	2-3/8" Backset - UL	•		•		•	•			\$21.90
	84254	WFPL	2-3/4" Backset - UL	•		•		•	•			\$21.90
	84294	WFPL	2-3/8" Backset - UL	•		•		•	•			\$21.90

KEY:	
5L - 5" Latch	RFAL - Round Face Adjustable Latch
DL - Deadlatch	SCAL - Square Corner Adjustable Latch
RC - Round Corner	SCDL - Square Corner Deadlatch
SC - Square Corner	SCPL - Square Corner Plainlatch
RCL - Round Corner Latch	WFAL - Wide Face Adjustable Latch
RFL - Round Face Latch (Drive In Collar attached)	WFDL - Wide Face Deadlatch
SCL - Square Corner Latch	WFPL - Wide Face Plainlatch
RCAL - Round Corner Adjustable Latch	FD - Latch

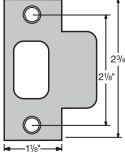
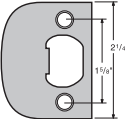
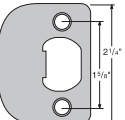
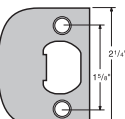
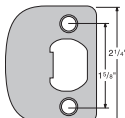
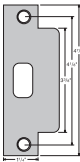
1326425-01/23

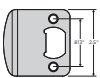
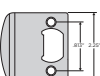

**Plainlatch and
Deadlatch**

	Model	Function	Finish							List Price
			3	5	15	15A	26/26D	690/11P	514	
	80318	Full Round, Adjustable Strike (500 Per Box)			•		•	•		\$2,907.90
	83028**	T (30 per carton) Standard on 588, 589 and UL Listed Knob and Lever sets. Add \$0.45 elsewhere.	•		•		•	•	•	\$4.10
	83030**	Full Lip Square Corner Strike, UL	•		•		•	•	•	\$5.40
	83031**	Full Lip 1/4" Round Corner Strike, UL	•		•		•	•	•	\$5.40
	83437*	Full Lip Square Corner *Standard on Non-UL Locksets	•		•		•	•	•	\$4.10
	83796*	Full Lip 1/4" Round Corner (RCS4)	•		•		•	•	•	\$4.10
	83846**	ASA-1 (30 per carton) *Add \$4.90 to Knob and Lever sets	•		•		•	•	•	\$12.80
	83929	Full Round 1- 3/4"	•	•	•	•	•	•	•	\$4.10
	83536	Round Corner Extended Lip Strike 2-1/4" Qty 10	•		•		•	•	•	\$4.10
	83537	Square Corner Extended Lip Strike 2-1/4" Qty 10	•		•		•	•	•	\$4.10
	83534	Round Corner Adjustable Strike 2-1/4"	•		•		•	•	•	\$4.10

NOTES:

*20-minute fire rating with UL locks and latchbolts.

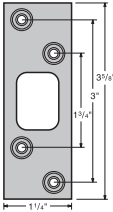
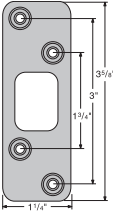
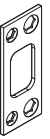
** 3-hour fire rating with UL Kwikset Signatures and 1.5 hour fire rating with UL Kwikset locks and latchbolts.

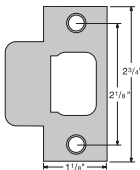
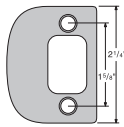
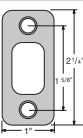
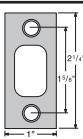
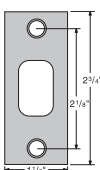
Deadbolt Strikes Model	Function	Finishes								List Price
		3	5	15	15A	26/26D	690/11P	514	NA	
	83222**	Square Corner Strike: Used on Grade 2 Deadbolts	•	•	•	•	•	•	•	\$4.80
	780, 785, 980, 985, 258, 800, 801, 553, 554, 818 Deadbolts. Add \$1.45 to 660 Series Deadbolts									
	83223**	Round Corner Strike: Used on Grade 2 Deadbolts	•	•	•	•	•	•	•	\$4.80
	780, 785, 980, 985, 258, 800, 801, 553, 554, 818 Deadbolts. Add \$1.45 to 660 Series Deadbolts									
	82004**	Square Corner Strike: Used on Grade 1 Deadbolts	•	•	•	•	•	•	•	\$4.80
	780, 785, 980, 985, 258, 800, 801, 553, 554, 818 Deadbolts. Add \$1.45 to 660 Series Deadbolts									
	82005**	Round Corner Strike: Used on Grade 1 Deadbolts	•	•	•	•	•	•	•	\$4.80
	780, 785, 980, 985, 258, 800, 801, 553, 554, 818 Deadbolts. Add \$1.45 to 660 Series Deadbolts									
	84632**	Deadbolt T-Strike (60 per carton)	•	•	•	•	•	•	•	\$4.10
	84638**	Deadbolt, Full Lip	•	•	•	•	•	•	•	\$4.10
	85063**	Deadbolt 1"x 2-1/4" Round Corner (RCS4)	•	•	•	•	•	•	•	\$4.10
	Standard on 660, 665 Deadbolts.									
	85072**	Deadbolt 1"x 2-1/4"	•	•	•	•	•	•	•	\$4.10
	Standard on 660, 665 Deadbolts.									
	85278**	Deadbolt, 1-1/8" x 2-3/4"	•	•	•	•	•	•	•	\$4.10
	Standard on 782, 784 Deadbolts.									

Deadbolt Strikes **Model** **Function** **Finishes** **List Price**

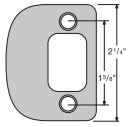

Model	Function	3	5	15	15A	26/26D	690/11P	514	NA	List Price
85303**	Deadbolt, Full lip Round Corner	•	•	•	•	•	•	•		\$4.10

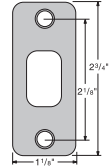

Model	Function	3	5	15	15A	26/26D	690/11P	514	NA	List Price
85279**	Deadbolt, 1-1/8" x 2-3/4" Round Corner	•	•	•	•	•	•	•		\$4.10
Standard on 782, 784 Deadbolts.										

Strike Boxes **Model** **Function** **Finishes** **List Price**

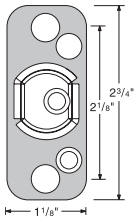

Model	Function	3	5	15	15A	26/26D	690/11P	514	NA	List Price
81225	Box for 5278/5279 Strikes								•	\$4.30

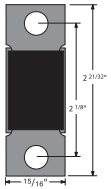

Model	Function	3	5	15	15A	26/26D	690/11P	514	NA	List Price
81231	Box for 83028 T Strike								•	\$1.30

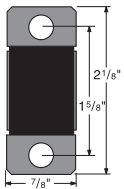

Model	Function	3	5	15	15A	26/26D	690/11P	514	NA	List Price
83288	Box for Full Lip Strikes*								•	\$1.80
*Add \$0.45 to locksets using full lip strike.										

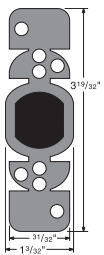

Model	Function	3	5	15	15A	26/26D	690/11P	514	NA	List Price
81640	Box for all Deadbolt Strikes								•	\$1.30
81967	Box for 83846 ASA-1 Strike								•	\$5.80

NOTES:

*20-minute fire rating with UL locks and latchbolts.

** 3-hour fire rating with UL Kwikset Signatures and 1.5 hour fire rating with UL Kwikset locks and latchbolts.

Knobs and Levers

	Model	Function	Finish						List Price	
			3	5	15/15A	26/26D	690/11P	514		NA
	81834	Signature Lever Screw Pack Styles: A, CA, H, L							•	\$1.30
	81835	Signature Lever Screw Pack Styles: ADL, AVL, BRL, CHL, KTL, LL, PML, TNL, VDL/Kwikset Screw Pack Styles: BL, DL, DNL, LRL	•		•	•	•	•		\$0.60
	83369	Signature Lever Screw Pack Styles: C, CN, PE/Kwikset Screw Pack Styles: CV, P, T	•							\$0.60
	83001	Signatures Entry Lever Screw Pack Functions: 156			•	•	•			\$5.90
	820284	Signatures Passage & Privacy Lever Screw Pack Functions: 154, 155								\$4.00
	89930	Signature Lever Screw Pack Functions: 720/730/740			•	•			•	\$1.30
	89930	Signature Lever Screw Pack Functions: 720/730/740			•	•			•	\$1.30
	89930	Signature Lever Screw Pack Functions: 720/730/740			•	•			•	\$1.30
	85201	Signature Screw Pack: KAL			•				•	\$1.30
	83523	Light Commercial Screw Pack: Kingston	•		•	•	•			\$4.30
	83524	Light Commercial Screw Pack: BBL, CNL, PLL	•		•	•	•			\$4.30
	83258	Lever Set Screw With Hex Wrench (3/32")							•	\$0.70
	83398	Lever Set Screw With Hex Wrench for MRL, SYL, HFL, LSL, MIL							•	\$0.60
	84235	LPP Interior Pack Screw Pack**			•				•	\$1.30

NOTES:

*If 15 or 15A not available, 515 (Gray Chromate) is the default finish. **Use to make 966, 968 compatible with 687 & 699

Reversible Leverset Screws

	Model	Function	Finishes						List Price	
			3	5	15/15A	26/26D	690/11P	514		NA
	83254	Passage/Provacy/Interior Entry SMT							•	\$0.20
	83255	Interior Pin & Tumbler Entry							•	\$0.20
	83256	Exterior Entry Pin & Tumbler & SMT							•	\$0.20
	83257	Exterior Entry SMT							•	\$0.20

Handlesets

	Model	Function	Finish						List Price	
			3	5	15/15A	26/26D	690/11P	514		NA
	86151	Kwikset Handleset Screw Pack Styles: A, CA, H, L, ADL, AVL, BRL, CHL, PML, CE, AVH, ADH, SE, HE	•	•	•	•	•	•		\$1.70
	82215	Signatures Handleset Decorative Interior Screw Cap Cover: ADH, AVH, AT, AUH, HE, MNH, SE, WN, PTH	•	•	•	•	•	•		\$2.60
	82213	Screw and Washer ADH, AVH, AT, HE, SE, AVH, MNH, TVH							•	\$0.80
	81696	Signature Handleset Cap for 818 and 819 CMH, SCE, TVH, VNH			•	•	•	•		\$2.60
	83004	Signature Series Handleset Screw and Washer for ADH, AVH, CMH, PTH, SCE, VNH							•	\$0.80
	84307	Screw & Washer for AUH and MNH							•	\$0.80
	88322	Sex Nut Set & Wood Screw (CE, AMD, BW, DA, AN)	•	•	•	•	•	•		\$6.70

NOTES:

*If 15 or 15A not available, 515 (Gray Chromate) is the default finish

1326425-01/23

Deadbolts	Model	Function	Finishes						List Price	
			3	5	15/15A	26/26D	690/11P	514		NA
	86171	660 Deadbolt Screw Pack	•	•	•	•	•	•		\$1.70
	86099	665 Deadbolt Screw Pack	•	•	•	•	•	•		\$2.60
	86073	One-Way Screws, 665 Deadbolt	•	•	•	•	•			\$1.60
	81247	P&T and SMT 780/782/980/982 Deadbolt Screw Pack	•	•	•	•	•	•		\$5.40
	81251	980 Series Deadbolt, Turnpiece Screw & Wrench							•	\$5.40
	83474	P&T and SMT 784, 785, 984, 985, Deadbolt Screw Pack	•	•	•	•	•	•		\$11.60
	820285	P&T and SMT 158 Deadbolt Screw Pack			•	•	•	•		\$5.40
	820286	P&T and SMT 159 Deadbolt Screw Pack			•	•	•	•		\$11.60
	83015	Standard Screw Pack for 258 Series Deadbolt	•		•	•		•		\$6.60
	83017	Thin Door Screw Pack for 258 Series Deadbolt			•	•		•		\$6.60

Dummy/In-Active	Model	Function	Finishes						List Price	
			3	5	15/15A	26/26D	690/11P	514		NA
	81708	488 & 788 Dummy Mounting Screws	•	•	•	•	•			\$1.40
	81892	488 Dummy Adapter	•	•	•	•	•			\$6.70

Latch	Model	Function	Finishes						List Price	
			3	5	15/15A	26/26D	690/11P	514		NA
	81711	Latch & Strike Screws	•	•	•	•	•			\$0.80
	82893	3846 Strike Screw Pack	•	•	•	•	•			\$3.60



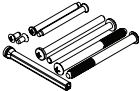



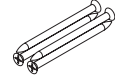
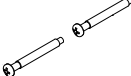

Adjustable Interconnect

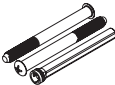
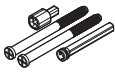
	Model	Function	Finish						List Price	
			3	5	15/15A	26/26D	690/11P	514		NA
	83270	Adjustable interconnect Screw Pack (Thick Door Pack)	•	•	•	•	•			\$3.50

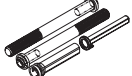
Strike Screws

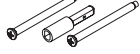
	Model	Function	Finish						List Price	
			3	5	15/15A	26/26D	690/11P	514		NA
	86356	3" Strike Screws	•	•	•	•	•			\$5.60
	88604	Full Round Strike Screws				•				\$1.70

Thick Door Conversion

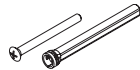
	Model	Function	Finish						List Price	
			3	5	15/15A	26/26D	690/11P	514		NA
	81691	P&T and SMT 780/782/980/982 Deadbolt and 913/914/915/916/919 Thick Door Pack	•		•	•	•	•		\$6.30
	83022	258 Series Deadbolt Thick Door Pack	•		•	•	•	•		\$6.30
	81249	P&T and SMT 784/785/985 Deadbolt Thick Door Kit with 2-11/16" Screws							•	\$6.30
	84221	P&T Deadbolt Thick Door Kit with 3.625" Screws							•	\$6.30
	86129	660 Thick Door Pack							•	\$6.30
	86130	665 Thick Door Pack	•	•	•	•				\$6.30
	81714	Thick Door Pack, Signature Series Knobs Concealed Screws Styles							•	\$6.30
	81706	Thick Door Pack, Kwikset and Signatures Knobs & Lever Styles: A, CA, CN, PE, H, AO, CV, P, T, BL, DL, DNL, LRL, ADL, AUL, AVL, CHL, L, LL, TNL, PML	•		•	•			•	\$6.30
	85202	Thick Door Signature Screw Pack: KAL			•				•	\$6.30
	89933	Signature Lever Screw Pack Functions: 720/730/740 Styles: HFL/MIL/SYL/MRL/SAL			•	•	•	•		\$6.30
	81838	Thick Door Pack, Handleset Adapter	•	•	•	•	•	•		\$3.50

Thick Door

Conversion (cont)

	Model	Function	Finish					List Price	
			3	5	15/15A	26/26D	690/11P		514
	81780	Thick Door Pack, All Active & Dummy Handsets	•	•	•	•	•	•	\$6.30
	820291	Thick Door Pack for 154 and 155 Function for the Kwikset Signature Series Lever. No Thick Door Kit is available for the 156 function.	•	•	•	•	•		\$6.30
	820289	P&T and SMT 158 Deadbolt Thick Door Pack			•	•	•	•	\$6.30
	820290	P&T and SMT 159 Deadbolt Thick Door Pack			•	•	•	•	\$6.30
	84988	1.37" Torque Blade Double Cylinder Thick Door			•	•	•		\$2.00
	84992	2.491" Torque Blade Single Cylinder Thick Door						•	\$2.00
	84994	1.40" Torque Blade Thick Door						•	\$2.00
	81861	Thick Door Screw and Washer						•	\$1.50
	81402	800 Handleset Thick Door Spindle						•	\$2.10

Model	Function	Hawthorne, Shelburne, Tavaris	Ashfield, Avalon	Austin	Arlington, Chelsea	San Clemente, Vancouver, Prescott Prague	Amador, Belleview, Dakota
	81691	980 Deadbolt Thick Door Pack (H16)	X	X	X	X	
	83022	258 Deadbolt Thick Door Pack (H16)					X
	86129	660 Deadbolt Thick Door Pack (H17)					X
	81402	Handleset Thick Door Spindle (H18)	X	X	X	X	X
	81780	Thick Door Pack for all Handlesets (H17)	X	X	X	X	X
	82213	Throughbolt Screw & Washer (H14)	O				
	81861	Thick Door Screw & Washer (H17)		X	O		X
	84307	Throughbolt Screw & Washer (H14)					
	88322	Sex Nut & Wood Screw Set (H14)				X	X

X: Needed for thick door option

O: Optional - Part comes with product on standard order

Must specify finish on order







Misc. Parts	Model	Function	Finish								List Price		
			3	5	15	15A	26	26D	690/11p	514		NA	
	82768	660/665 Cylinder Guard										•	\$4.30
	87760	780 Exterior Cylinder Guard										•	\$4.50
	82746	660/665 Cylinder Guard Cover	•	•	•	•	•	•	•	•			\$5.60
	87759	780 Cylinder Guard Cover	•	•	•	•	•	•	•	•			\$10.40
	82216	980 Cylinder Guard Cover	•	•	•	•	•	•	•	•			\$10.40
	84991	660 Torque Blade										•	\$2.20
	83273	660/663/667/677/588 Thumb Turn	•	•	•	•	•	•	•	•			\$8.90
	81692	780 Thumb Turn	•	•	•	•	•	•	•	•			\$25.50
	82217	980 Thumb Turn	•	•	•	•	•	•	•	•			\$25.50
	88381	664, 667, 677 Exterior Plate	•	•				•	•	•			\$20.70
	81295	Kwik-Install Mounting Plate										•	\$3.60
	87789	Deadbolt Reinforcing Plate										•	\$1.80
	82778	699 Function Dummy Cylinder	•	•	•	•	•	•	•	•			\$5.80
	81239	Grade 1 Body Dummy Cylinder										•	\$13.30
	85184	Dummy Deadbolt Cylinder Plug			•			•	•	•	•		\$3.90
	81857	U.L. Shield Deadbolts										•	\$6.40
	83162	U.L. Shield Entry - Halifax										•	\$6.60
	83163	U.L. Shield Passage - Halifax										•	\$6.60
	83164	U.L. Cotter Pin										•	\$0.20

Misc. Parts	Model	Function	Finish							List Price	
			3	5	15	15A	26	26D	690/11p		NA
	81226	Dummy Cylinder Cover	•	•	•	•	•	•	•		\$3.90
	84990	663/667/677/664 Tailpiece								•	\$2.20
	84568	663 Block, Bolt Mounting								•	\$1.40
	81404	Non-Handed Levers Dummy Adapter								•	\$13.10
	88841	300 Knobs Interior Round Spindle								•	\$0.70
	87628	740 SMT Interior Round Spindle (knob or lever)								•	\$1.30
	85624	3-1/2" Screw Driver Bit (10 pack)								•	\$5.80
	88448	U.L. Shield Knobs								•	\$6.60
	81822	DB 2-1/8" Adapter for 780/970/980								•	\$3.60
	84987	.835" Torque Blade								•	\$3.60
	84993	1.097" Torque Blade, Standard Door								•	\$2.10
	83621	Finish Sample Ring								•	\$18.40
	83024	258 Series Mounting Plate								•	\$4.10
	83396	Vedani Lever Support Insert								•	\$4.10
	85333	Half Round & Round Spindle Assembly								•	\$4.80
	85570	5570-07 Screw #8-32 x 1-1/2			•						\$0.10
	820314	Levers and Knobs Frost Insert								•	\$8.00
	820309-001	Handleset Mechanism								•	\$13.80
	820318-001	Deadbolt Frost Insert								•	\$12.40

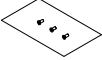
Misc. Parts

	Model	Function	Finish							List Price	
			L03	5	15	15A	26	11P/514	690		NA
	83307	909, 911 & 912 Top Battery Holder								•	\$1.90
	83581	913, 914, 915, 916, 919 and 953 Battery Pack without Pull Tab (for use with 83580)								•	\$1.90
	83502	888, 938, 939, 942, and HC620 Battery Pack with Pull Tab (For use with: 83813/83814)								•	\$1.90
	85133	938 Halo Exterior Keypad			•				•		\$57.56
	85134	939 Halo Exterior Touchscreen			•		•		•		\$113.01
	85135	942 Aura Exterior Keypad			•				•		\$49.70
	85140	942 Aura Keypad Interior Chassis								•	\$118.30
	85138	938 Halo Keypad Interior Chassis								•	\$180.57
	85139	939 Halo Touchscreen Interior Chassis								•	\$179.54
	83583	Electronics Deadbolt Adapter Ring								•	\$3.05
	83187	Tapered Deadbolt, RC, 2-Way	•		•				•	•	\$5.00
	85137	913, 914, 915, 916, 919, 938, 939, 942, 953, 954, and 959 Interior Mounting Plate								•	\$5.45
	83154	HC620 Interior Mounting Plate								•	\$5.45
	83306	909 TRL Top Cover	•		•				•		\$12.60
	85143	917 HFL Interior Battery Cover								•	\$4.50
	85145	917, 955 TNL Interior Battery Cover								•	\$4.50
	85141	938, 939, and 942 Interior Cover			•		•		•		\$32.10
	83814	Interior Cover, CNT (For use with: Battery Pack with Pull Tab 83502)			•				•		\$32.10
	83813	Interior Cover, TRL (For use with: Battery Pack with Pull Tab 83502)			•				•		\$32.10
	85196	Security Screw for black interior RF Window			•				•		\$0.50

Misc. Parts

	Model	Function	Finish							List Price	
			L03	5	15	15A	26	11P/514	690		NA
	80435	909 and 910 Interior Cover Screws			•						\$1.00
	83585	913, 914, 915, 916, 919, 938, 939, 942, 953, 954, and 959 Interior Cover Screws (For use with 85137)	•		•			•			\$1.15
	83137	HC 620 Interior Cover Screws (For use with 83154)	•		•			•			\$1.15
	83159	913, 914, 915, 916, 938, 939, 942, and HC620 Mounting Screws & Spindle for 2-1/4" Door Thickness								•	\$5.35
	85144	917 & 955 Replacement Mounting Screws with Spindle			•		•	•			\$6.00
	83651	953, 954 Mounting Screws for 1-3/8" Door Thickness								•	\$5.50
	83653	953, 954 Mounting Screws for 2" Door Thickness								•	\$5.35
	83033	2 1/4" Thick Door Kit for 953, 938, 939, 959								•	\$5.35
	83186	Electronics tapered deadbolt adjustable drive-in latch (excluding Smart Code 260 and 270)								•	\$5.05