

Kwikset

A Smarter
Kind of
Simple™

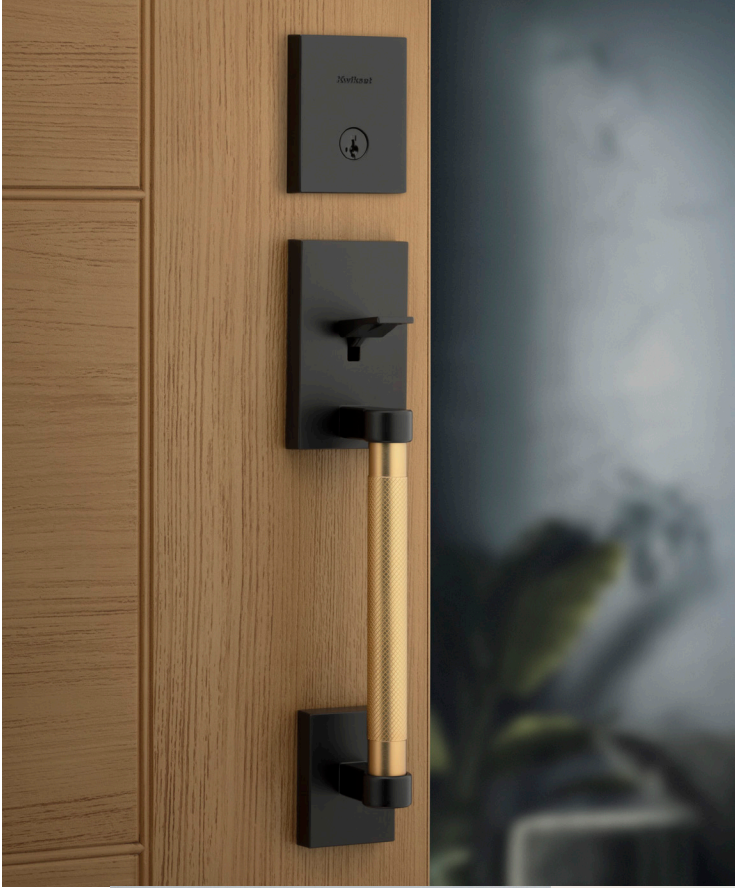

BOX PACK PRICE BOOK

April 2026

A: GENERAL INFORMATION

Terms and Conditions	3
General Information	5
Functions	7
Weights and Measurements	14
Order Forms	17

B: NEW PRODUCTS

Halo Select	18
Aura Reach	22
SmartCode 955	24
Sora Knob	26
Brentford Handleset	28
Maven Knob	30

C: KWIKSET SIGNATURE SERIES

Handlesets	34
Levers	38
Knobs	39
Deadbolts	40
Specifications	41

D: KWIKSET SECURITY SERIES

Handlesets	45
Levers	46
Knobs	47
Deadbolts	48
Combo Pack	48
Specifications	49

E: ELECTRONIC LOCKS

Halo	52
Aura Reach	52
Keyless Entry	53
Home Connect	55
UNITE	57
Specifications	58

F: LIGHT COMMERCIAL

Interconnect, Push Button Levers & Key Control	60
Specifications	68

G: ACCESSORIES

Pocket Door Locks	71
-------------------	----

TERMS AND CONDITIONS OF SALE

Standard terms are 2% prompt payment discount for payment within 25 days from date of invoice; net 30 days from the date of invoice. Kwikset® reserves the right to charge and recover on invoices which are not paid within the above terms, a service charge of 1-1/2% a month for each month or fraction thereof during which the invoice remains unpaid, said service charge, however, not to exceed the highest applicable legal rate of interest. All orders, whether solicited or written by our sales representatives or forwarded by our customers are deemed to be mere offers to purchase in accordance with these Terms and Conditions of Sale until actually accepted by us at our home office in Lake Forest, CA. We reserve the right to refuse any order as well as the right to sell or not sell to any firm at our sole discretion. The acceptance of an order is expressly made conditional upon your assent to these Terms and Conditions of Sale. We object to the inclusion of any different or additional terms or conditions, even if the same are included in your order, a contract of sale will result upon the Terms and Conditions of Sale stated herein only. Prices reflected in this book apply to Wholesale customers only.

All sales are final.

PRICES

Pricing based on full-case quantities only; orders for less than full case will be automatically adjusted up to the next full-case quantity. All prices are subject to change without notice and are not guaranteed. All taxes, duties or other charges are the responsibility of the customer.

CLAIMS

Price claims must be submitted in writing to Kwikset, 19701 Da Vinci, Lake Forest, CA 92610 within 30 days from the date of invoice.

CHANGES OR CANCELLATIONS

Beyond 5 working days of our acknowledgement date no changes can be made. Additions to an order will be handled as a separate order and must meet applicable minimum order requirements. Order cancellation on regular stock items only, or any portion thereof is allowed only upon prior written consent from Kwikset, and the payment of cancellation charges deemed appropriate.

MINIMUM CHARGE

No order will be invoiced for less than \$100.00 net plus shipping charges except for lock accessory parts.

MINIMUM ANNUAL SALES VOLUME

The company reserves the right to discontinue direct sales to any customer who does not meet the minimum annual sales volume requirement. The current annual requirement is \$50,000.00. Your annual purchases are determined by accepted, non-cancelled, and shipped orders received during each calendar year. Kwikset reserves the right to change any or all minimum annual sales volume requirements at any time. Any customer who does not meet the annual sales volume requirements may continue to purchase Kwikset products through a Kwikset distributor.

RETURNS

Defective merchandise returned to our factories requires prior written authorization from a Kwikset Sales Rep or the Sales Office. A factory return authorization must accompany the returned shipment. The return authorization must include an itemized listing of the merchandise and an explanation stating the reason for return.

There will be a 25% product restocking fee on all returned merchandise.

FREIGHT

All goods are invoiced FOB to our factory. Upon delivery of shipments to the carrier, title to, and the risk of loss or damage in transit for such shipments, passes to our customer. Kwikset's standard policy is to pay freight charges on all orders over \$1,000.00 net invoice value to a single destination in the continental U.S., by carrier and route of our choice. Shipments less than these quantities will not be shipped on a prepaid basis. If higher freight charges are incurred from customers specifying a carrier or route of their choice the additional cost will be added to that customer's invoice.

DELIVERY CONDITIONS

Shipping schedules are our best estimates, and cannot be guaranteed. Kwikset is not responsible for any direct or consequential loss or damage resulting from an inability or delay in meeting shipping schedules.

KWIKSET LIMITED WARRANTIES

Kwikset products are backed by one of the most comprehensive warranty programs available. You can feel confident that with the purchase of Kwikset you have selected the best quality product, backed by the best customer service available.

MECHANICAL LIMITED WARRANTY

Except as otherwise provided below, Spectrum Brands, Inc., for its Kwikset® brand products ("Kwikset"), warrants to the original residential purchaser (the "Purchaser") that each Kwikset product (the "Product(s)" or "Kwikset Product(s)") will be free from mechanical defects under normal use from the date of purchase for as long as said Purchaser occupies the residential premises upon which the Product was originally installed ("Warranty Period"). This Mechanical Limited Warranty applies only to Products that were purchased from Kwikset or a Kwikset authorized seller, unless otherwise prohibited by law. Kwikset Products are legitimately sold only by authorized sellers who are required to follow Kwikset's policies, procedures, and quality control standards. Kwikset reserves the right to reject warranty claims from purchasers for Products purchased from unauthorized sellers, including unauthorized Internet sites.

FINISH LIMITED WARRANTY

The finish on Kwikset Products is protected by a durable topcoat designed to maintain the beauty and quality of the Kwikset Product. Kwikset warrants to the Purchaser that the finish of the Product shall be free of defects in material and workmanship from tarnishing, flaking, and discoloring from the date of purchase for as long as said Purchaser occupies the residential premises upon which the Product was originally installed ("Warranty Period"). This Finish Limited Warranty applies only to Products that were purchased from Kwikset or a Kwikset authorized seller, unless otherwise prohibited by law. Kwikset Products are legitimately sold only by authorized sellers who are required to follow Kwikset's policies, procedures, and quality control standards. Kwikset reserves the right to reject warranty claims from purchasers for Products purchased from unauthorized sellers, including unauthorized Internet sites.

ELECTRONIC LIMITED WARRANTY

Kwikset warrants to the Purchaser that Kwikset Products will be free from electronic defects under normal use for one (1) year from the date of purchase, as long as said Purchaser occupies the residential premises upon which the Product was originally installed ("Warranty Period"). This Electronic Limited Warranty applies only to Products that were purchased from Kwikset or a Kwikset authorized seller, unless otherwise prohibited by law. Kwikset Products are legitimately sold only by authorized sellers who are required to follow Kwikset's policies, procedures, and quality control standards. Kwikset reserves the right to reject warranty claims from purchasers for Products purchased from unauthorized sellers, including unauthorized Internet sites.

EXCLUSIONS FROM WARRANTY

1. Any Kwikset Product produced prior to January 1, 2006.¹
2. Any Kwikset Product which has been damaged as a result of installation contrary to any of Kwikset's written installation instructions is not covered by these warranties.
3. Any Kwikset Product which has been modified by any non-Kwikset component is not covered by these warranties.
4. Any Kwikset Product having a defect caused by neglect, misuse, abuse or unreasonable or extraordinary use or maintenance, including use in a commercial application, is not covered by these warranties.
5. Any Kwikset Product having a defect due to use of paints, solvents, or other chemicals is not covered by these warranties.
6. Any Kwikset Product that is used in combination with knobs, levers, or trim of other than those manufactured by Kwikset and designated for use with the applicable locks or latches is not covered by these warranties.
7. Any Kwikset Product that was purchased from an unauthorized seller is not covered by these warranties.

These warranties are not transferable. Therefore, no transferee is covered by these warranties.

¹Kwikset Products produced prior to January 1, 2006, may be eligible for warranty in accordance with the terms and conditions of the applicable warranty program. 2646823-03/26

WARRANTY CLAIMS

If you wish to make a warranty claim based upon a Product defect, please call us at 1-800-327-LOCK (5625) or contact us at kwikset.com/support.

Please note that you will be required to provide a description of any claimed defect(s) and a dated receipt or other proof of purchase from Kwikset or the Kwikset authorized seller, to verify warranty eligibility.

Certain claimed defect(s) covered by these warranties may be resolved by Kwikset providing you with troubleshooting steps.

Other claimed defect(s) covered by these warranties may require Product replacement. Products may not be returned to Kwikset without prior authorization from Kwikset. If authorized by Kwikset, you will need to mail your Product to:

Spectrum Brands, Inc.

ATTN: Kwikset Consumer Services

19701 Da Vinci

Lake Forest, CA 92610

A prepaid shipping label will be provided to you.

REMEDIES

For certain claimed defect(s) covered by these warranties, as determined by Kwikset, Kwikset will provide you with troubleshooting steps.

For other claimed defect(s) covered by these warranties, as determined by Kwikset, Kwikset will replace the defective Product or part.

If a Kwikset Product, which is the same as the Kwikset Product or any part covered by these warranties, has been discontinued at the time of replacement or if Kwikset determines, in its sole discretion, that such replacement is inappropriate, Kwikset reserves the right to substitute an alternative product. Kwikset also reserves the right to accept or reject an alternative product proposed as a replacement, when the value is higher than that of the Product originally purchased by the Purchaser. Except as expressly provided in these warranties to the contrary, KWIKSET SHALL NOT BE OBLIGATED OR LIABLE FOR LABOR OR OTHER COSTS RELATED TO INSTALLATION, REPAIR OR REPLACEMENT OF A KWIKSET PRODUCT, OR FOR LOSS OF, OR DAMAGE TO ANY MATERIAL WHICH IS NOT SOLD BY KWIKSET.

PATENT INDEMNITY

We agree to defend any suit or proceeding brought against our customer so far as based on claim that our products, or any part thereof, made solely to our specifications and furnished to our customer constitute an infringement of any U.S. patent, if notified promptly in writing and given authority, information and assistance at our expense for the defense of same, and we shall pay all damages and costs awarded therein against our customer. In case our products, or any part thereof, is in such suit held to constitute infringement and their use is enjoined, we will, at our expense and discretion, either procure for our customer the right to continue using the products or replace same with non-infringing products, or modify them so they become non-infringing, or remove such products and refund the purchase price (less depreciation, prorated from the purchase date). The foregoing states our entire liability for patent infringement by our products or any part thereof.

INTELLECTUAL PROPERTY

No person or entity may sell, distribute, advertise, market or promote Kwikset branded products distributed by Kwikset Corporation ("Kwikset"), Spectrum Brands Hardware Home Improvement Division, without prior authorization from Kwikset. Customers of Kwikset who are authorized to sell Kwikset branded products are referred to herein as "Customers."

The Kwikset brand and all Kwikset trademarks, trade names, product depictions, colors, graphics or logos, whether or not registered or otherwise protected (the "Marks"), remain the sole and exclusive property of Kwikset and nothing arising out of the relationship between Kwikset and any Customer conveys to Customer any ownership rights in the Marks. Customer may use the Marks and then only in the sale or promotion of authentic Kwikset products in compliance with the terms of this policy. The Marks must be used exactly in the form provided and in conformity with all Kwikset trademark usage policies or guidelines, including, but not limited to, those relating to shape, color match and imprint quality. Any proposed deviation must be approved in writing by Kwikset prior to use. The Marks may not be used in or as part of any Customer domain name on the Internet. Prior to any use of the Marks on goods or services, Customer must submit samples for Kwikset's approval.

Additionally, no Customer may use product depictions, graphics, logos or text relating to Kwikset products that have not been provided by Kwikset in connection with the advertising, promotion or sale of Kwikset products without Kwikset's prior review and written approval of each such use. The Marks may not be used in or as part of any reseller or other third party (i) domain name or VRL on the Internet, (ii) trademark or service mark, or (iii) company or trade name. Any action on the part of a Customer that violates the terms of this policy or otherwise impairs the value of or goodwill associated with the Marks or is otherwise not in conformity with Kwikset's standards may result in the suspension or termination of the Customer's authorization or any other remedy permitted by law.

Kwikset grants to each of its Customers limited, non-transferable, non-sublicenseable licenses of the patents relating to the Kwikset products that the Customer is authorized to sell and of the copyrights in any packaging or other written materials included therewith or related thereto. Said patent and copyright licenses are solely to sell such Kwikset products covered by such patents and to which such copyrights relate only to end-users and other Customers in compliance with the terms of this document. The sale of such patented Kwikset products and the sale or use of such copyrighted materials by a Customer that violate the terms of this document exceed the scope of the licenses herein granted to the Customer and may constitute patent and/or copyright infringement.

STANDARDS

Kwikset meets or exceeds the testing requirements specified for each product grade or rating.

- American National Standards Institute (ANSI)
- Builders Hardware Manufacturers Association (BHMA)
- Underwriters Laboratories, Inc. (UL)
- Americans with Disabilities Act (ADA)

MISCELLANEOUS

Substitution of non-Kwikset components/parts, and any alteration or modification of factory parts, and other lock manufacturer's parts may result in door hardware which does not function properly or will fail and will void all warranties. Orders not specified with keying requirements will be shipped Keyed Differently (KD). Orders with keying requirements of K10 or more must have a "Letter of Release" on file with Kwikset stating that Kwikset Corporation will not be held liable for cost and expense arising from any loss or damage to property utilizing Kwikset products where 10 or more locks have been keyed alike. Contact your Sales Office account representative for a copy of the release form. Kwikset reserves the right to revise or modify products, product information, or pricing without notice. Product specifications and pricing reflect available information at the time of printing. Kwikset is not responsible for typographic or printing errors.

LIMITATION OF LIABILITIES

THERE ARE NO WARRANTIES WHICH EXTEND BEYOND THOSE STATED HEREIN. ANY IMPLIED WARRANTIES THAT MAY BE APPLICABLE TO PRODUCTS, INCLUDING IMPLIED WARRANTIES OF MERCHANTABILITY OR FITNESS FOR A PARTICULAR PURPOSE, ARE LIMITED IN DURATION TO THE DURATION OF THIS WARRANTY. SOME STATES DO NOT ALLOW LIMITATIONS ON HOW LONG AN IMPLIED WARRANTY LASTS, SO THE ABOVE LIMITATION MAY NOT APPLY TO YOU. UNDER NO CIRCUMSTANCES SHALL KWIKSET BE LIABLE FOR ANY SPECIAL, INCIDENTAL, OR CONSEQUENTIAL DAMAGES BASED UPON BREACH OF THIS LIMITED WARRANTY, BREACH OF CONTRACT, OR STRICT LIABILITY. SOME STATES DO NOT ALLOW THE EXCLUSION OR LIMITATION OF INCIDENTAL OR CONSEQUENTIAL DAMAGES, SO THE ABOVE LIMITATION OR EXCLUSION MAY NOT APPLY TO YOU. THIS WARRANTY GIVES YOU SPECIFIC LEGAL RIGHTS, AND YOU MAY ALSO HAVE OTHER RIGHTS WHICH VARY FROM STATE TO STATE.

Effective Date: [July 6th 2020]

ORDER CODE BREAKOUT

Quantity	Specifies Quantity
Function & Style	Specifies Model and Function
Rose Design	Specifies Designer Rose
Handing	Handing Right or Left
Finish	Exterior/Interior
Keying	Special Keying
Code	Keying Code
Latch	Specifies Latch
Strike	Indicates Strike
Key Alike Qty	Keyed Alike

Example: “I would like to order 12 SmartKey Halifax levers, satin nickel finish, a round rose, 6-way adjustable latch and round corner strike.

Written as: 12-740HFL RDT 15 SMT 6AL RCS.

NOTE: All handlesets ordered LIP only.

UNDERWRITERS LABORATORIES LISTED LOCKSETS



To meet Underwriters Laboratories’ fire rating requirements UL listed locksets, UL listed latches, and UL listed strikes must be used together.

AMERICAN WITH DISABILITIES ACT (ADA)



Products displaying this symbol comply with the Americans with Disabilities Act of 1990.

HOW TO ORDER 20MIN UL LOCKS

FD = 20 minute UL designation

Example: “I would like to order 12 passage Halifax levers with a round rose, 6-way adjustable latch and round corner strike with 20 minute UL in Satin Nickel”

12-720HFL RDT 15 RCALFD RCS.

KEYING

Code	Option	List Pricing Adder
KA	Keyed Alike (*SMT Only)	\$5.00
KD*	Keyed Differently	N/A
K3 or K4	Keyed Alike (2 Locksets, 3 Locksets)	N/A
MK	Master Keyed	\$15.00
PK	Builder (Protecto) Keyed	\$15.00
GMK	Grand Master Keyed	\$20.00
PMK	Builder (Protecto) Master Keyed	\$20.00
SMT	SmartKey Security	N/A

*Not every SKU is available with the KD option

BACKSET

Backset is the distance from center edge of door to center of the 2-1/8" (54mm) diameter hole, 2-3/8" or 2-3/4" in most cases.

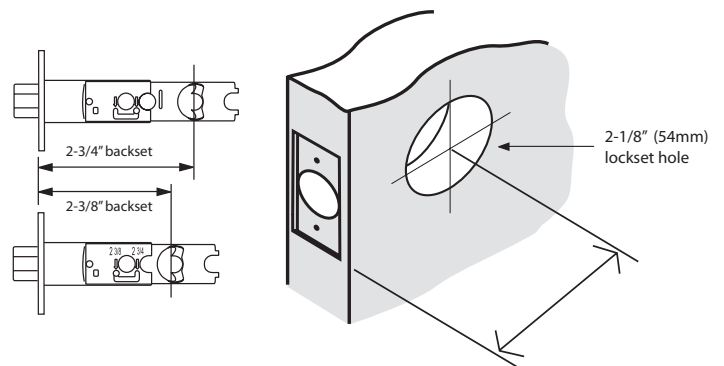

Model	Function
200/407/420/720/721/725	Passage/Hall/Closet
300/408/730/733	Privacy/Bed/Bath
334/335	Round Pocket Door Lock
400/438/740/756	Entry
405/409	Lever Keyed Entry
450/462/412/439/750/755/781	Storeroom/Vestibule
488/788	Half Dummy Trim, Surface Mounted
508	Interconnect
687/800/818	Single Cylinder Handleset
802/819	Dummy Handleset
898/814	Handle Only
899/815	Handle and Lever Only
599	Double Cylinder Gatelatch
158/258/660/780/782/980/982/817	Single Cylinder Deadbolts
159/665/785/985	Double Cylinder Deadbolts
912/918/620	Home Connect Deadbolt and Lever
240/250/260/270/917/955	Electronic Single Cylinder Deadbolt/Lever
938/939/959	WiFi Enabled Deadbolt
966/968/971/973	Interior Pack for Handlesets
9800/9801	WiFi and Matter Enabled Deadbolt
9400	Bluetooth and Matter Enabled Deadbolt

HANDING



To determine the handing of a door face the OUTSIDE of the door. If the hinge is on the left side of the door, the door is left handed (LH). If the hinge is on the right side of the door, the door is right handed (RH).

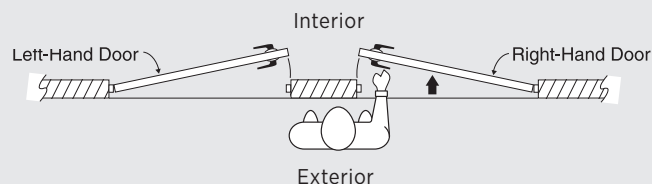

NOTE: Handing required for dummy levers and interior packs with levers when lever design is not symmetric.

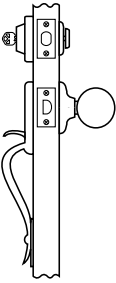
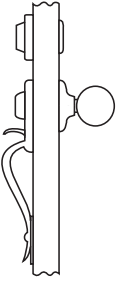

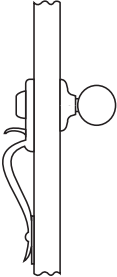
Finish	Description	ANSI/BHMA	Latch	Description
3	Polished Brass	605	RCAL	Round Corner Adjustable Latch
4	Satin Brass	---	SCAL	Square Corner Adjustable Latch
L03	Lifetime Polished Brass	605E	RFAL	Round Face Adjustable Latch
5	Antique Brass	609	RCAL FD	Round Corner Adjustable 20 Minute UL
11P	Venetian Bronze	---	6AL	6-Way Adjustable Latch. Round front staked
15	Satin Nickel	619	6AL FD	6-Way Adjustable Latch 20 Minute UL
26	Polished Chrome	625		
26D	Satin Chrome	626		
514	Matte Black	---		

HANDLESETS	Function Name	Description	KWIKSET SECURITY SERIES w/ BHMA	KWIKSET SIGNATURE SERIES w/ BHMA
	<p>Handleset with Single Cylinder Deadbolt</p>	<p>Latch bolt operated by thumb piece outside and grip inside. Deadbolt operated by key outside and thumb turn inside.</p>	<p>687</p>	<p>800, 818</p>
	<p>Dummy Handleset with Dummy Deadbolt</p>	<p>Handle and grip act as a pull only. For inactive leaf of double doors. No operation.</p>	<p>N/A</p>	<p>802, 819</p>

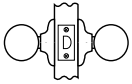
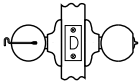
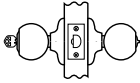
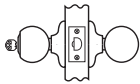
HANDLESETS	Function Name	Description	KWIKSET SECURITY SERIES w/ BHMA	KWIKSET SIGNATURE SERIES w/ BHMA
	Handleset with Knob or Lever	Latch bolt operated by thumb piece outside and grip inside.	898	815
	Handleset Only	Latch bolt operated by thumb piece outside	899	814

KNOBS	Function Name	Description	KWIKSET SECURITY SERIES w/ BHMA	KWIKSET SIGNATURE SERIES w/ BHMA
	Passage/Hall/Closet	Both knobs always free.	200 F75	720/725UL F75
	Privacy/Bed/Bath	Both knobs locked or unlocked by turn button inside. Outside knob unlocked by emergency key.	300 F76	730 F76
	Entry	Both knobs locked or unlocked by key outside or turn button inside.	400 F82	740/745UL F82
	Storeroom/Vestibule	Outside unlocked only while key is turned. Inside always free.	450 F86	750 F86
	Half Dummy Trim, Surface Mounted	For doors where only a pull is required. No operation.	488	788

NOTE: BHMA code in italics.

LEVERS	Function Name	Description	KWIKSET SECURITY SERIES w/ BHMA	KWIKSET SIGNATURE SERIES w/ BHMA
	Passage/Hall/Closet	Both levers always free.	200/407/420UL F75	720/725UL F75
	Privacy/Bed/Bath	Both levers locked or unlocked by turn button or push button inside. Outside lever unlocked by emergency key.	300/408ULL F76	730 F76
	Keyed Entry Lever	Both levers locked or unlocked by key outside or turn or push button inside.	405 F82	740/745/756UL F82
	Storeroom/Vestibule	Outside unlocked only while key is turned. Inside always free.	439/450/462/412UL F86	750/781 F86
	Half Dummy Trim, Surface Mounted	For doors where only a pull is required. No operation.	488	788

NOTE: BHMA code in italics.



DEADBOLTS	Function Name	Description	KWIKSET SECURITY SERIES w/ BHMA	KWIKSET SIGNATURE SERIES w/ BHMA
	Single Cylinder	Deadbolt operated by key outside and thumb turn inside.	660 E0153	980/982UL E0151 780/782UL 817UL E0152 158/258
	Double Cylinder	Deadbolt operated by key both sides.	665/E0143	985 E0141 785 E0142 159 E0152
	Thumb Turn Only	Deadbolt operated by thumb turn one side. No trim on exterior.	663 E0193	N/A

DEADBOLTS	Function Name	Description	KWIKSET SECURITY SERIES w/ BHMA	KWIKSET SIGNATURE SERIES w/ BHMA
	Conversion Kit	Converts 663 to 667 when door is bored through.	664	N/A
	Thumb Turn x Plate	Deadbolt operated by thumb turn on interior. Blank plate on exterior.	667 E01113	N/A
	Double Cylinder Gatelatch	Deadbolt operated by key outside and inside.	599	N/A
ELECTRONIC DEADBOLTS	Function Name	Description	KWIKSET SECURITY SERIES w/ BHMA	KWIKSET SIGNATURE SERIES w/ BHMA
	Halo™	Deadbolt operated by key outside, electronic keypad or WiFi enabled device.	N/A	938/939/959
	Aura™ Reach	Deadbolt operated by key outside, electronic keypad or bluetooth enabled device. Matter enabled.	N/A	9400
	SmartCode™ and HomeConnect™ Electronic Deadbolt	Deadbolt operated by key outside or electronic keypad and thumb turn inside.	N/A	240/250/260/270 620/912/918
	SmartCode™ Lever	Keyed lever operated by key outside or electronic keypad and thumb turn inside.	N/A	917/955
NOTE: BHMA code in italics				
	Halo Select, Halo Select CNT, Halo Select Plus	Matter and WiFi enabled device	N/A	9800/9801

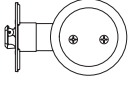
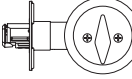
ROUND POCKET

DOOR LOCK	Function Name	Description	KWIKSET w/ BHMA	KWIKSET SIGNATURE SERIES w/ BHMA
	Passage	Pocket door lock always free.	334	N/A
	Privacy	Pocket door lock operated by thumb turn.	335	N/A

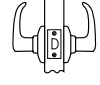
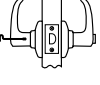
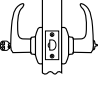
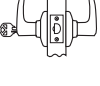
LIGHT COMMERCIAL

LEVER	Function Name	Description	LIGHT COMMERCIAL w/ BHMA
	Passage/Hall/Closet	Both levers always free.	407/721 F75
	Privacy/Bed/Bath	Both levers locked or unlocked by ADA turn button inside. Outside lever unlocked by emergency key.	408/733F76
	Entry	Both levers locked or unlocked by key outside or ADA turn button inside.	438/756 F82
	Storeroom/Vestibule	Outside unlocked only while key is turned. Inside always free.	439/781 F86
	Half Dummy Trim, Surface Mounted	For doors where only a pull is required. No operation.	788

NOTE: BHMA code in italics

METAL

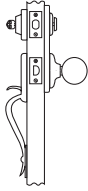
INTERCONNECT	Function Name	Description	METAL INTERCONNECT Model w/BHMA
	Plain Latch	Operated by lever either side. Deadbolt operated by key outside and thumb turn inside. Inside lever simultaneously retracts plain latch and deadbolt latch.	508

NOTE: BHMA code in italics

BOX PACK	Unit					Master Case			
	Quantity	Length (in.)	Width (in.)	Height (in.)	Weight (lbs.)	Quantity	Length (in.)	Width (in.)	Height (in.)
Kwikset Signature Series									
Deadbolts									
780 Single Cylinder	1	4.6730	3.9230	3.0720	2.2500	12	12.8750	12.5000	5.3125
785 Double Cylinder	1	4.6730	3.9230	3.0720	2.7500	12	12.8750	12.5000	5.3125
817 Key Control	1	4.6730	3.9230	3.0720	2.2500	12	12.8750	12.5000	5.3125
817 SQT Key Control Deadbolt	1	4.92	4.13	3.15	2.02	12	12.99	13.19	5.51
980 Single Cylinder	1	4.6730	3.9230	3.0720	2.2500	12	12.8750	12.5000	5.3125
985 Double Cylinder	1	4.6730	3.9230	3.0720	2.7500	12	12.8750	12.5000	5.3125
158 Single Cylinder	1	4.6730	3.9230	3.0720	2.2500	12	12.8750	12.5000	5.3125
159 Single Cylinder	1	4.6730	3.9230	3.0720	2.7500	12	12.8750	12.5000	5.3125
258 Single Cylinder	1	4.81	4.06	3.13	1.76	12	13.37	12.9	6.21
Electronic Deadbolts/Levers									
HomeConnect 620	1	9.50	4.13	4.00	3.12	1	10.23	4.33	4.53
Powerbolt 240 TRL	1	3.54	5.38	7.89	1.83	2	8.386	7.795	6.3
Powerbolt 240 CNT	1	3.54	5.38	7.89	1.83	2	8.386	7.795	6.3
Powerbolt 250 TRS	1	3.54	5.38	7.89	1.83	2	8.386	7.795	6.3
Powerbolt 250 CNT	1	3.543	5.381	7.885	2.284	2	8.386	7.795	6.3
SmartCode 260 CNT	1	4.213	5.353	9.913	3.343	2	10.557	9.180	6.213
SmartCode 260 TRL	1	4.213	5.353	9.913	3.290	2	10.557	9.180	6.213
SmartCode 270 TRL	1	4.213	5.353	9.913	3.307	2	10.557	9.180	6.213
SmartCode 270 CNT	1	4.213	5.353	9.913	3.373	2	10.557	9.180	6.213
SmartCode 955KNL	1	5.32	7.68	8.86	4.38	1	8.46	6.10	10.492
912 SmartCode Lever	1	3.5	6	10	61	2	7	12.5	10.4
Halo 938/939	1	3.5	5.38	9.88	3.14	2	10.50	7.75	5.94
HomeConnect 918	1	3.896	4.188	9.667	3.391	1	10.4	4.646	4.52
959 Halo Touch	1	4.19	5.40	9.83	3.76				
9800 Halo Select	1	4.281	5.490	9.938	3.717	1	4.635	10.344	5.823
9801 Halo Select Plus	1	4.281	5.490	9.938	3.717	1	4.635	10.344	5.823
Halo Select CNT	1	4.292	4.792	9.938	3.725	1	4.708	10.344	5.823
Handlesets									
800 AUH Austin	1	15.9380	7.1250	4.0000	7.0000	4	16.4380	15.9380	7.8125
802 AUH Austin	1	15.9380	7.1250	4.0000	6.5000	4	16.4380	15.9380	7.8125
800AVH Avalon	1	15.9380	7.1250	4.0000	7.0000	4	16.4380	15.9380	7.8125
802AVH Avalon	1	15.9380	7.1250	4.0000	6.5000	4	16.4380	15.9380	7.8125
800AN Arlington	1	15.9380	7.1250	4.0000	7.0000	4	16.4380	15.9380	7.8125
802AN Arlington	1	15.9380	7.1250	4.0000	6.5000	4	16.4380	15.9380	7.8125
800CE Chelsea	1	15.9380	7.1250	4.0000	6.0000	4	16.4380	15.9380	16.6255
802CE Chelsea	1	15.9380	7.1250	4.0000	5.5000	4	16.4380	15.9380	16.6255
800HE Hawthorne	1	15.9380	7.1250	4.0000	7.0000	4	16.4380	15.9380	7.8125
802HE Hawthorne	1	15.9380	7.1250	4.0000	5.0000	4	16.4380	15.9380	7.8125
800 Tavaris	1	15.9380	7.1250	4.0000	8.0000	4	16.4380	16.6200	8.3800
802 Tavaris	1	15.9380	7.1250	4.0000	8.0000	4	16.4380	16.6200	8.3800
818 Prescott	1	16.143	7.293	3.75	4.281	4	16.339	15.945	7.677
818 Prague	1	16.142	7.283	3.937	4.079	4	16.142	16.142	7.874
966 Single Cylinder	1	2.7	3.7	4.30	2.25	4	15.20	12.5	7
968 Dummy	1	2.7	3.7	4.30	2.25	4	15.20	12.5	7

BOX PACK	Unit					Master Case			
	Quantity	Length (in.)	Width (in.)	Height (in.)	Weight (lbs.)	Quantity	Length (in.)	Width (in.)	Height (in.)
Kwikset Signature Series Continued									
Knobs									
720 Passage	1	8.1730	3.9230	2.7840	2.0000	12	12.3750	11.5000	8.8125
730 Privacy	1	8.1730	3.9230	2.7840	2.0000	12	12.3750	11.5000	8.8125
740 Entry	1	8.1730	3.9230	2.7840	2.3300	12	12.3750	11.5000	8.8125
788 Dummy	1	3.2360	2.7980	3.0100	0.3500	20	14.8750	12.5000	3.9375
Levers									
720 Passage	1	7.8750	6.1250	3.1875	2.4200	12	19.7500	12.8750	8.5625
730 Privacy	1	7.8750	6.1250	3.1875	2.4200	12	19.7500	12.8750	8.5625
740 Entry	1	7.8750	6.1250	3.1875	2.4200	12	19.7500	12.8750	8.5625
788 Dummy	1	5.8610	3.1100	2.8220	0.4500	20	15.8750	12.1250	6.6245
720 TNL	1	6.9	6.1	3.3	1.70	20	24.9	17.2	8.1
730 TNL	1	7.0	6.0	3.2	1.719	20	24.7	17.1	8.1
740 TNL	1	7.0	6.0	3.2	1.719	20	24.7	17.1	8.1
788 TNL	1	5.861	3.11	2.822	0.450	20	15.875	12.125	6.6245
Kwikset Security Series									
Combo Packs									
690T Tylo Knob and Single Cylinder Deadbolt	1	11.3090	3.4230	2.7840	2.8000	6	8.7500	7.3120	11.9375
Deadbolts									
Double Cylinder Gate Latch	1	4.6730	3.9230	3.0720	2.2500	12	12.8750	12.5000	5.3125
660 Single Cylinder	1	3.9480	3.4230	2.5720	0.5000	12	11.1250	11.0000	4.5625
665 Double Cylinder	1	3.9480	3.4230	2.5720	0.9000	12	11.1250	11.0000	4.5625
663 One-Sided	1	3.9480	3.4230	2.5720	0.5500	12	11.1250	11.0000	4.5625
667 One-Sided	1	3.9480	3.4230	2.5720	0.9000	12	11.1250	11.0000	4.5625
664 Retrofit Kit	1	3.9480	3.4230	2.5720	0.9000	12	11.1250	11.0000	4.5625
Handlesets									
687 LIP	1	15.9380	7.1250	4.0000	3.6000	6	15.0000	12.1250	16.6255
Knobs									
200 Polo	1	8.1730	3.2980	2.7840	1.3000	30	17.1250	17.0000	8.8125
300 Polo	1	8.1730	3.2980	2.7840	1.3000	30	17.1250	17.0000	8.8125
400 Polo	1	8.1730	3.2980	2.7840	1.3000	30	17.1250	17.0000	8.8125
200 Tylo/Cove	1	7.3610	3.2980	2.7840	1.1500	30	17.1250	17.0000	8.1870
300 Tylo/Cove	1	7.3610	3.2980	2.7840	1.1500	30	17.1250	17.0000	8.1870
400 Tylo/Cove	1	7.3610	3.2980	2.7840	1.1500	30	17.1250	17.0000	8.1870
488 Dummy	1	3.2360	2.7980	3.0100	0.3500	20	14.8750	12.5000	3.9375
200 Maven	1	7.563	4.187	3.125	1.018	30	25.875	17.625	8.625
300 Maven	1	7.563	4.187	3.125	1.048	30	25.875	17.625	8.625
400 Maven	1	7.563	4.187	3.125	1.281	30	25.875	17.625	8.625
488 Maven	1	3.25	2.688	3	0.284	20	16.188	11.875	4.125
Lever									
200 Passage	1	6.7980	5.7660	2.9720	1.3500	12/20	23.6250	15.3750	7.4995
300 Privacy	1	6.7980	5.7660	2.9720	1.3500	20	23.6250	15.3750	7.4995
405 Keyed Lever	1	6.7980	5.7660	2.9720	1.5800	20	23.6250	15.3750	7.4995
488 Polo/Tylo/Cove Dummy	1	5.8610	3.1100	2.8220	0.4500	20	15.8750	12.1250	6.6245
Miscellaneous									
Pocket Door Hardware									
334 Passage	1	4.3750	3.0000	2.0000	.65	12	12.5000	14.3750	2.2500
335 Privacy	1	4.3750	3.0000	2.0000	.8	12	12.5000	14.3750	2.2500

BOX PACK	Unit					Master Case			
	Quantity	Length (in.)	Width (in.)	Height (in.)	Weight (lbs.)	Quantity	Length (in.)	Width (in.)	Height (in.)
Kwikset Multi-Family / Light Commercial									
Carson and Palmina									
407	1	6.75	5.75	2.75	0.5	1	7.93	6.06	3.12
408	1	6.75	5.75	2.75	0.5	1	7.93	6.06	3.12
438	1	6.75	5.75	2.75	1.0	1	7.93	6.06	3.12
439	1	6.75	5.75	2.75	1.0	1	7.93	6.06	3.12
488	1	5.18	3.00	2.43	0.55	1	15.75	12.00	6.56
Kingston									
721KNL	1	6.75	5.75	2.75	1.5	1	7.93	6.06	3.12
733KNL	1	6.75	5.75	2.75	1.5	1	7.93	6.06	3.12
756KNL SMT	1	6.75	5.75	2.75	2.33	1	7.93	6.06	3.12
781KNL SMT	1	6.75	5.75	2.75	2.33	1	7.93	6.06	3.12
788 KNL	1	5.18	3.00	2.43	0.87	1	15.13	12.75	3.50



Customer Service Toll Free Line:
 (800) 422-LOCK (800) 422-5625
 FAX (866) 507-8369
 email: kworders@spectrumbands.com

Date: _____ Delivery Address: _____ Contact: _____
 PO Number: _____ Phone: _____ Company Name: _____
 Job Name: _____ Fax: _____ Address: _____
 Notes: _____ Store Number: _____



April 2026

Line No.	Function		Style		Handing	Rose		Finish		OPTIONS					Quantity	Price	Extended Price
	Exterior	Interior	Exterior	Interior		Exterior	Interior	Exterior	Interior	Door Thickness	Latch	Strike	Cylinder	Keying			
1																	
2																	
3																	
4																	
5																	
6																	
7																	
8																	
9																	
10																	
11																	
12																	
13																	
14																	
15																	
16																	
17																	
18																	
19																	
20																	

To order service parts, provide service part # and quantity.
 How to order questions, refer back to page A:3 for General Information.

2646823-03/26

Kwikset

HALOSELECT™

WI-FI AND MATTER ENABLED SMART LOCK

Meet the smart lock that brings convenience, intelligence and security to your front door. Control Halo Select™ from anywhere using Wi-Fi and the full-featured Kwikset® app, or easily integrate it into your favorite smart home ecosystem with a compatible Matter hub. Enjoy the freedom and flexibility of remote access, keyless entry and customizable access codes for all your family's needs.

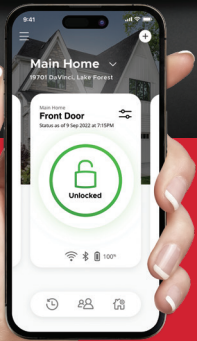

Control and Monitor from Anywhere



Smart Home Integration



Geofence Auto-Unlock



ONE TIME
ANYTIME
WEEKLY

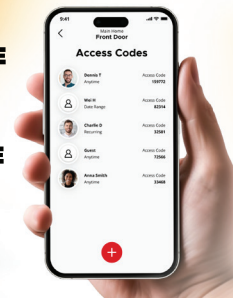

Easy Secure Guest Access

#1 SELLING U.S. LOCK BRAND*

Based on YipitData Unit Share Report, 2025

Specifications

Power	6V, 4 x AA alkaline batteries, 6-months battery life Lithium-ion battery life, 9-months battery life (Lithium-ion battery pack sold separately)
Door Prep	2 1/8" diameter cross bore hole & 1" diameter edge bore hole
Latch Backset	Adjustable 2 3/8" or 2 3/4"
Door Thickness	1 3/4" standard Service part available for 2 3/4" thick doors.
Faceplates	1" x 2 1/4" round corner faceplate standard (For Kwikset)
Strikes	1 1/8" x 2 3/4" x round corner/square corner 4-hole strike
Bolt	1" throw, steel deadbolt
Door Handing	Reversible for right or left-hand doors
Cylinder	SmartKey Security® KW1 cylinder
UL Rated	20 min UL fire rating
Security	Deadbolt: A156.40 Grade AAA Certified
Temperature Range	Exterior: -40F to 150F, Interior: 32F to 130F
Humidity	Exterior: 100% condensing, Interior: 30% to 95% non-condensing
Warranty	Lifetime Limited Mechanical and Finish Warranty. One Year Limited Electronics Warranty

Innovative Security

- 250 customizable access codes with optional schedules
- BHMA Grade AAA certified
- 20 Minute fire rating - UL certified
- Full 128-bit encryption security
- Featuring SmartKey Security® - protecting against advanced break-in techniques
- SecureScreen™ - patented security feature prevents on-screen fingerprint user code identification

Easy Installation

- No hub required by connecting directly to your home Wi-Fi network
- Operates on (4) AA batteries
- Installs in minutes using a screwdriver
- In app interactive install guide

Warranty

- Lifetime mechanical and finish warranty
- 1 year electronic warranty

Dimensions

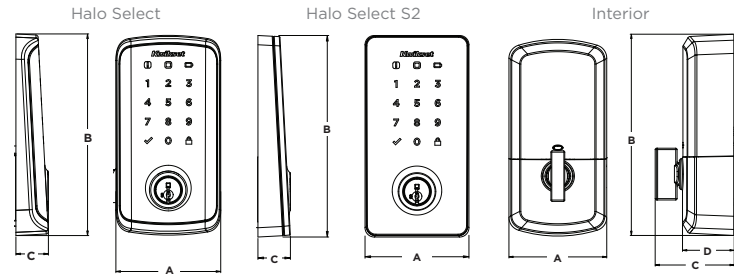

Touchscreen	A	B	C	D
Halo Select Exterior	2 27/32"	5 7/16"	7/8"	---
Halo Select S2 Exterior	2 13/16"	5 7/16"	7/8"	---
Interior	2 29/32"	5 27/32"	2 9/32"	1 1/2"



Wi-Fi and Kwikset App

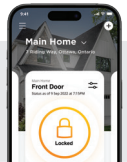

Remote Lock and Unlock



Guest Access Codes



Geofence Auto-Unlock



Door Status Sensor



Smart Home Voice Control



Intrusion Detection



Matter and Smart Home App

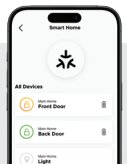

Smart Home Integration



Simple Setup



Remote Lock and Unlock



Improved Battery Life

Easy Installation

- No hub required by connecting directly to your home Wi-Fi network
- Operates on (4) AA batteries
- Installs in minutes using a screwdriver
- In app interactive install guide

Warranty

- Lifetime mechanical and finish warranty
- 1 year electronic warranty

Finishes



Halo Select Satin Nickel¹⁵
998000-001



Halo Select Matte Black⁵¹⁴
998000-002



Halo Select S2 Satin Nickel¹⁵
998000-005



Halo Select S2 Matte Black⁵¹⁴
998000-006



The BHMA certified product has been tested for a good UL center (UL security rating in each of these areas: security, quality and finish.
www.bhmacertified.com

Visit Kwikset.com/matter for the most up-to-date information

Kwikset

HALOSELECT+

WI-FI AND MATTER ENABLED SMART LOCK

Meet the smart lock that brings convenience, intelligence and security to your front door. Control Halo Select Plus™ from anywhere using Wi-Fi and the full-featured Kwikset® app, or easily integrate it into your favorite smart home ecosystem via Matter. Enjoy the freedom and flexibility of keyless entry, with Apple Home Key tap-to-unlock technology and customizable access codes for all your family's needs



Control and Monitor from Anywhere



Smart Home Integration



Geofence Auto-Unlock



ONE TIME
ANYTIME
WEEKLY

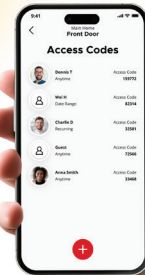

Easy Secure Guest Access

Specifications

Power	6V, 4 x AA alkaline batteries, 6-months battery life Lithium-ion battery life, 9-months battery life (Lithium-ion battery pack sold separately)
Door Prep	2 1/8" diameter cross bore hole & 1" diameter edge bore hole
Latch Backset	Adjustable 2 3/8" or 2 3/4"
Door Thickness	1 3/4" standard Service part available for 2 3/4" thick doors.
Faceplates	1" x 2 1/4" round corner faceplate standard (For Kwikset)
Strikes	1 1/8" x 2 3/4" x round corner/square corner 4-hole strike
Bolt	1" throw, steel deadbolt
Door Handing	Reversible for right or left-hand doors
Cylinder	SmartKey Security® KW1 cylinder
UL Rated	20 min UL fire rating
Security	Deadbolt: A156.40 Grade AAA Certified
Temperature Range	Exterior: -40F to 150F, Interior: 32F to 130F
Humidity	Exterior: 100% condensing, Interior: 30% to 95% non-condensing
Warranty	Lifetime Limited Mechanical and Finish Warranty. One Year Limited Electronics Warranty

Innovative Security

- 250 customizable access codes with optional schedules
- BHMA Grade AAA certified
- 20 Minute fire rating - UL certified
- Full 128-bit encryption security
- Featuring SmartKey Security® - protecting against advanced break-in techniques
- SecureScreen™ - patented security feature prevents on-screen fingerprint user code identification

Easy Installation

- No hub required by connecting directly to your home Wi-Fi network
- Operates on (4) AA batteries
- Installs in minutes using a screwdriver
- In app interactive install guide

Warranty

- Lifetime mechanical and finish warranty
- 1 year electronic warranty

Dimensions

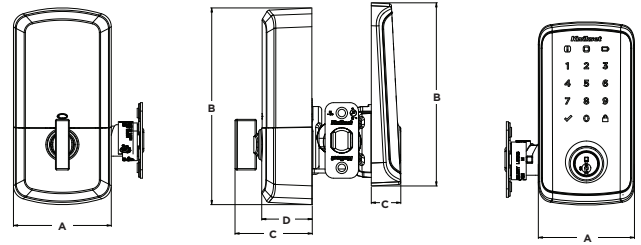

Touchscreen	A	B	C	D
Interior	2 29/32"	5 27/32"	2 9/32"	1 1/2"
Exterior	2 27/32"	5 7/16"	7/8"	---



Wi-Fi and Kwikset App

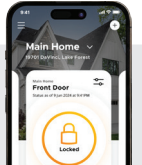

Remote Lock and Unlock



Guest Access Codes



Geofence Auto-Unlock



Door Status Sensor



Smart Home Voice Control



Intrusion Detection



Matter and Smart Home App

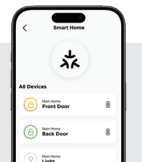

Tap to Unlock with Apple Home Key



Smart Home Integration



Simple Setup



Improved Battery Life

Finishes



Satin Nickel¹⁵
998010-001



Matte Black⁵¹⁴
998010-002



Visit Kwikset.com/matter for the most up-to-date information

2646823-03/26

Kwikset

aura[™]

R E A C H

BLUETOOTH AND MATTER ENABLED SMART LOCK

Introducing Aura Reach™, a Matter and Bluetooth-enabled smart lock designed for convenient DIY smart home security to control access from anywhere and seamlessly integrate with major smart home platforms. Use auto-unlock to unlock upon approach hands-free or a backlit touchpad screen that intelligently wakes up as you approach the keypad.

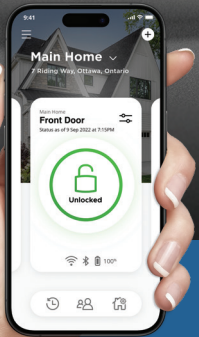

 matter  Bluetooth  Works with the Kwikset App



Control and Monitor from Anywhere

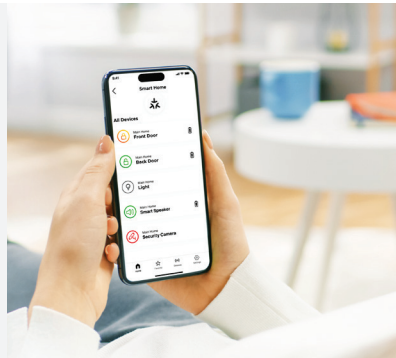

Smart Home Integration



Geofence Auto-Unlock



ONE TIME

ANYTIME



Easy Secure Guest Access

Specifications

Power	12-month battery life with 4 AA Alkaline batteries
Door Prep	2 1/8" diameter cross bore hole & 1" diameter edge bore hole
Latch Backset	Adjustable 2 3/8" or 2 3/4"
Door Thickness	1 3/4" standard Service part available for 2 1/4" thick doors.
Faceplates	1" x 2 1/4" round corner faceplate standard (For Kwikset)
Strikes	1 1/8" x 2 3/4" x round corner
Bolt	1" throw, steel deadbolt
Door Handing	Reversible for right or left-hand doors
Cylinder	SmartKey Security™ KW1 cylinder
UL Rated	20 min UL fire rating
Security	Deadbolt: A156.36 Grade 2 Certified
Temperature Range	Exterior: -40F to 185F, Interior: 32F to 130F
Humidity	Exterior: 100% condensing, Interior: 30% to 95% non-condensing
Warranty	Lifetime Limited Mechanical and Finish Warranty. One Year Limited Electronics Warranty

Innovative Security

- 250 customizable access codes with optional schedules
- BHMA Grade 2 Certified
- 20 Minute fire rating - UL certified
- Full 128-bit encryption security
- Featuring SmartKey Security™ - protecting against advanced break-in techniques

Easy Installation

- Operates on (4) AA batteries
- Installs in minutes using a screwdriver
- In app interactive install guide

Warranty

- Lifetime mechanical and finish warranty
- BHMA Grade 2 certified
- 1 year electronic warranty

Dimensions

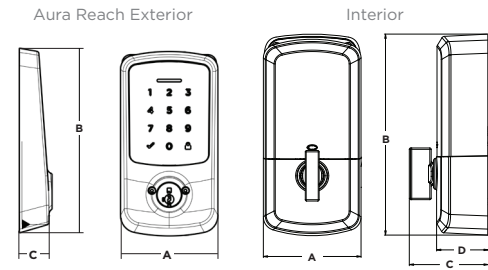

Touchscreen	A	B	C	D
Aura Reach Exterior	2 13/16"	5 11/32"	3 1/32"	---
Interior	2 23/32"	5 13/16"	1 29/32"	1 5/32"

Features

- Auto-Unlock on Approach
- Motion Activated Backlight
- Remote Lock and Unlock*
- Guest Access Codes
- Works with Existing Smart Home*
- Touchpad Screen with Tactile Feedback
- Intrusion Detection
- Simple Install & Setup
- Grade 2 BHMA Certified**
- UL Approved
- SmartKey Security™
- Lifetime Warranty***

*Requires smart home hub with Matter and Thread support.

**ANSI/BHMA Standard A156.36

***Warranty includes: lifetime finish and mechanical and one year electronics

Finishes



Satin Nickel¹⁵
994000-001

Matte Black⁵¹⁴
994000-002

FINISH AND
LIFETIME WARRANTY
MECHANICAL
ONE YEAR
ELECTRONIC WARRANTY

BHMA
CERTIFIED
Be Safe. Be Secure. Look for the Mark.
**ANSI/BHMA Standard A156.36

Kwikset
LIGHT COMMERCIAL

SMARTCODE 955

COMMERCIAL GRADE LEVER

Meet the Kwikset SmartCode™ 955 Commercial Grade Lever - featuring KW1 SmartKey® Security.

Re-key it in seconds to your KW1 key with no locksmith required. Lost keys or new tenants? No problem. Enjoy keyless entry, three lock modes, an LED keypad, and durable KW1 SmartKey® Security built for everyday use.



Satin Nickel



SMARTKEY
SECURITY™



ONE KEY
FOR ALL YOUR LOCKS™



Reasons to re-key:



Loaned or unreturned keys



Recently moved, tenant turnover



Your child has lost their key, again



You have a different key for each door

Specifications

Function	Keyed entry electronic lever
Door Prep	2 1/8" diameter cross bore hole & 1" diameter edge bore hole
Latch Backset	Adjustable 2 3/8" or 2 3/4"
Door Thickness	1 3/8" standard Service part available for 1 3/4" thick doors
Faceplates	1" x 2 1/4" round corner faceplate standard (For Kwikset)
Strikes	1 1/8" x 2 3/4" x round corner/square corner 4-hole strike
Bolt	1" throw, steel deadbolt
Door Handing	Reversible for right or left-hand doors
Cylinder	SmartKey® Security KW1 cylinder
BHMA Rated	ANSI/BHMA Grade 2 Certified
ADA	Certified
UL Rated	20 min UL fire rating
Warranty	Lifetime Limited Mechanical and Finish Warranty. One Year Limited Electronics Warranty

Dimensions

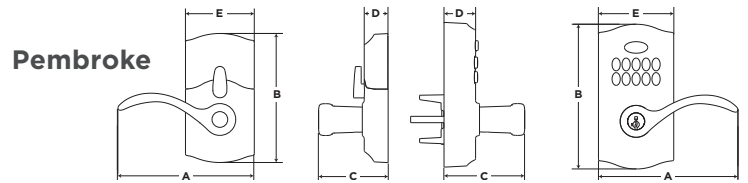

PML Design	A	B	C	D	E
Interior	5 5/8" (142.9 mm)	5 5/16" (134.9 mm)	2 7/8" (73 mm)	31/32" (24.6 mm)	2 27/32" (72.2 mm)
Exterior	5 3/4" (146 mm)	5 31/32" (151.6 mm)	3 5/16" (84.1 mm)	1 13/32" (35.7 mm)	3 3/32" (78.6 mm)

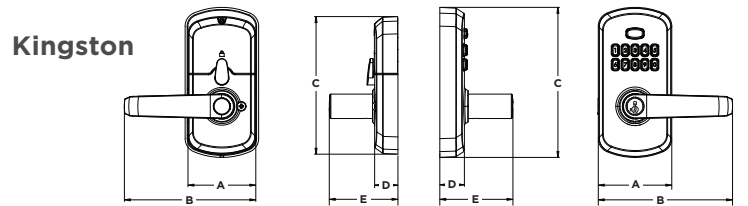

KNL Design	A	B	C	D	E
Interior	5 1/2" (139.7 mm)	5 3/4" (146 mm)	2 7/8" (73 mm)	31/32" (24.6 mm)	2 27/32" (72.2 mm)
Exterior	5 5/8" (142.9 mm)	6 9/32" (159.5 mm)	3 1/16" (77.7 mm)	1 1/32" (26.2 mm)	3 1/16" (77.7 mm)

Features

- **Convenient Keyless Entry** - Quickly lock/unlock your door without taking out your keys.
- **3-year Battery Life** - Battery lasts three years.
- **High Traffic Durability** - Lock tested to 500,000 cycles to ensure lasting, reliable performance in high-traffic entryways.
- **3 Lock Modes** - Auto-Lock, Passage and Disable Turnpiece.
- **Easy Code Management** - with 30 user codes and 1 one-time usercode.
- **Intrusion Alert** - 3 wrong codes disable keypad and sound alarm.
- **Low Light Code Entry** - Bright LED lights illuminate the keypad.
- **SmartKey® Security** - KW1 SmartKey® Security lets you re-key your lock to your KW1 key.

FINISH AND
LIFETIME*
WARRANTY
MECHANICAL

ONE YEAR
ELECTRONIC WARRANTY*

*See kwikset.com/support/warranty for the lifetime limited mechanical and finish warranties and three-year limited electronics warranty.

*Consulte kwikset.com/support/warranty para ver las garantías mecánicas y de acabado limitadas de por vida y la garantía limitada de tres años de los electrónicos.

Also available in



Finishes



Satin Nickel 15



Satin Chrome 26D



Matte Black 514



Venetian Bronze 11P



Satin Nickel 15



Satin Chrome 26D



Matte Black 514

Kwikset

19701 DaVinci, Lake Forest, CA 92610 • Kwikset.com • 1-800-327-LOCK

Copyright © 2026, ASSA ABLOY Americas Residential Inc. All rights reserved. Lake Forest, CA 92610 • 2320973-01/26-KW1

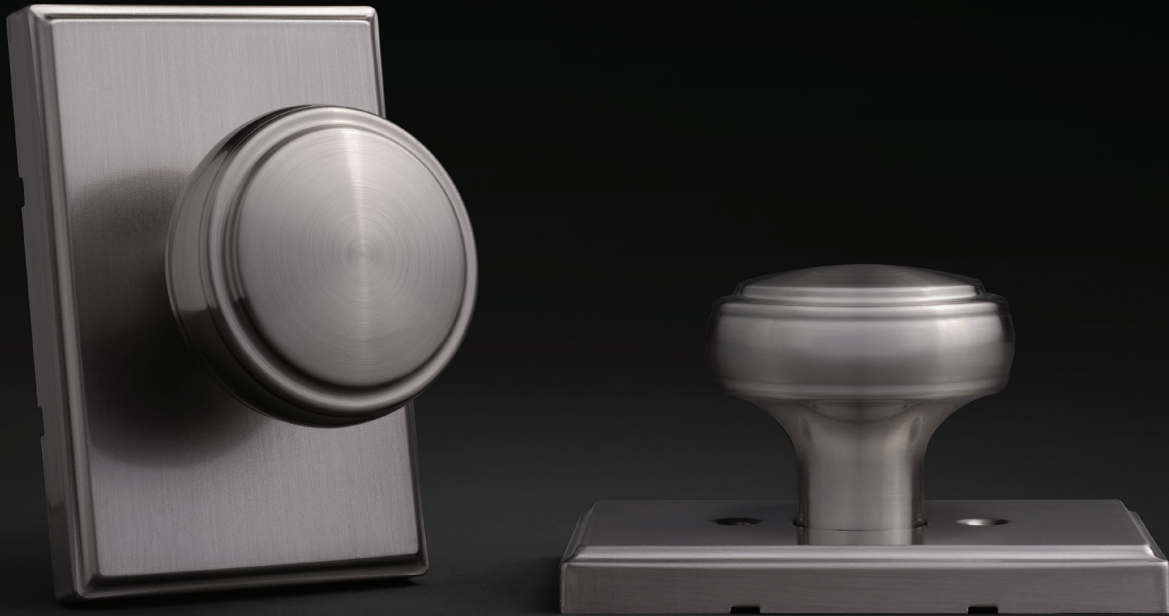

SORA™ KNOB

Sora™ offers a classic look that's always in style. Crafted with precision, the refined traditional knob features elegant detailing around the edges and premium quality you can depend on. It's a sophisticated yet comforting design that looks and feels like home.

- Featuring SmartKey Security™
- ANSI/BHMA Grade AAA - Highest Residential Security
- Premium Chassis Keeps Knobs Wobble-Free
- Convenient Push-Button Privacy Lock
- Durability and Finish
- Easy Install



Sora Knob with
round rose in Matte Black



Sora Knob with
rectangular rose in Satin Brass

Specifications

Door Prep	Cross Bore 2-1/8", Edge Bore 1"
Backset	Adjustable 2 3/8" or 2 3/4"
Door Thickness	1 3/8" - 1 3/4" Doors standard 2 3/4" Door Optional
Cylinder	SmartKey Security™
Faceplates	1" x 2 1/4" includes round corner, square corner and drive-in
Strikes	Includes 2 1/4" full lip round corner, specify round corner or square corner. Other options available.
Bolt	1/2" Throw
ANSI/BHMA	Grade AAA Certified: Finish/Durability/Security
UL	N/A
Door Handing	Reversible for right or left hand doors
ADA	N/A
Rose	Specify traditional round (TRDT) or rectangle (TRCT)
Warranty	Lifetime Mechanical and Lifetime Finish

Dimensions

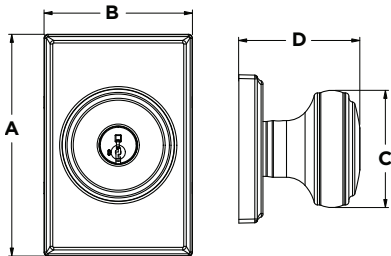

Design	A	B	C	D	D (Keyed)
Round	2 21/32"	2 21/32"	2 3/16"	2 1/4"	2 9/16"
Rectangular	4 1/8"	2 25/32"	2 3/16"	2 1/4"	2 9/16"

Finishes

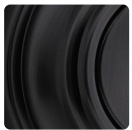

Matte
Black 514



Satin
Nickel 15



Satin
Brass 4

Functions



Passage/Hall/Closet: Both levers always free.
- 720SOK



Privacy/Bed/Bath: Both levers locked or unlocked by push-button inside. Outside lever unlocked by emergency key.
- 730SOK



Keyed Entry Lever: Both sides locked or unlocked by key outside or turn-button inside.
- 740SOK



Half Dummy Trim, Surface Mounted: For doors where only a pull is required. No operation.
- 788SOK



Interior Pack: Inside lever of handleset.
800/802 Handlesets:
- 966SOK: Single-Cylinder
- 968SOK: Dummy
818/819 Handlesets:
- 971SOK: Single-Cylinder
- 973SOK: Dummy



One Key For All Your Locks

Protects against advanced break-in techniques and allows you to re-key your lock yourself in seconds.

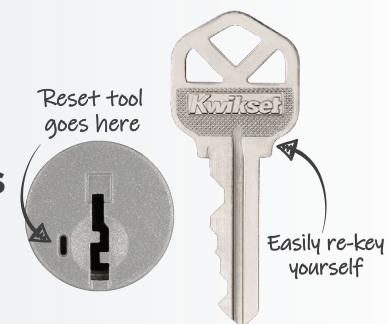

LIFETIME
WARRANTY



BRENTFORD™ HANDLESET

Brentford™ is the ideal handleset for any entryway. Its blend of soft curves and sleek lines elevates both classic and contemporary spaces. Designed with your style and safety in mind, its versatility and premium quality make it the perfect finishing touch for your home.

- Features New Advanced SmartKey Security™
- Versatile, Transitional Design
- Handleset Deadbolt is Grade AAA BHMA Certified
- Lifetime Mechanical and Finish Warranty



Specifications

Door Prep	Cross Bore 2 1/8". Edge Bore 1" Latch Face 1" x 2 1/4"
Backset	Adjustable 2 3/8" or 2 3/4"
Door Thickness	1 3/4" Standard. Thick door service part available for up to 2 1/4"
Faceplates	1" x 2 1/4" includes round corner, square corner and drive-in
Strikes	Deadbolt: 1 1/8" x 2 3/4". square, round corner & 2 1/4" full lip round corner Handle: 2 1/4" round corner full lip (Other options available)
Bolt	Deadbolt: 1" throw Handle: 1/2" throw
Cylinder	SmartKey Security™
Door Handing	Reversible for right or left-hand doors
ANSI/BHMA	Deadbolt is Grade 1 Certified
UL	N/A
ADA	N/A
Warranty	Lifetime mechanical and lifetime finish

Adjustable Throughbolt

Vertical and horizontal slide designed for a guaranteed fit

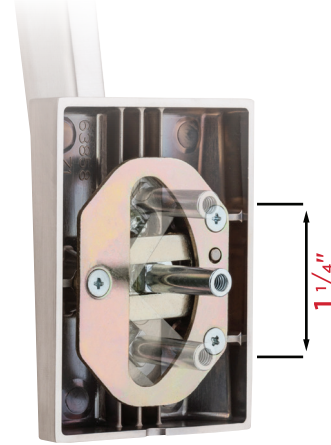

Dimensions

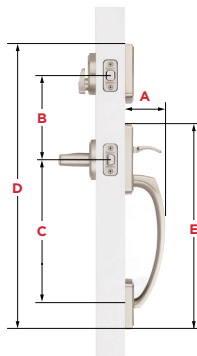

Dimensions	A	B	C	D	E
Brentford	2 11/16"	5 1/2"	9 5/16"	18 1/16"	13 1/32"

Functions



Handleset (Single-Cylinder): Exterior only, Latch bolt operated by thumb piece outside. Deadbolt operated by key outside.

- 818 BFH SMT



Handleset (Dummy): Exterior only, Handle acts as pull only. For inactive leaf or double doors. No Operation.

- 819 BFH



Handle Only: Handle only. Latch bolt operated by thumb piece outside.

- 814 BFH

LIFETIME
WARRANTY

Finishes



Matte
Black 514



Satin
Nickel 15



MAVEN KNOB

Maven™ door knobs give a unique, stylish touch to each room of your home. The modern square profile and textured perimeter create an elevated look that's still budget friendly. Choose round or square rosettes to make your space uniquely yours, and enjoy trusted Kwikset® quality with every turn.

- Featuring SmartKey Security™
- ANSI/BHMA Grade 3 Certified
- Easy to Install
- Available with Square or Round Rose



Maven Entry Knob with round rose
In Matte Black



Maven Entry Knob with square rose
In Matte Black

Specifications

Door Prep	Cross Bore 2 1/8" Edge Bore 1" Latch Face 1 x 2 1/4"
Backset	Adjustable 2 3/8" or 2 3/4"
Door Thickness	1 3/8" - 1 3/4" Doors standard.
Cylinder	SmartKey Security™
Faceplates	1" x 2 1/4" includes round corner, square corner and drive-in
Strikes	2 1/4" Full lip. Includes round corner, other options available.
Bolt	1/2" Throw
Door Handing	Reversible for right or left-hand doors
ANSI/BHMA	A156.2 Grade 3
UL	N/A
ADA	N/A
Rose	Specify round (RDT) or square (SQT)
Warranty	Lifetime Mechanical and Lifetime Finish

Dimensions

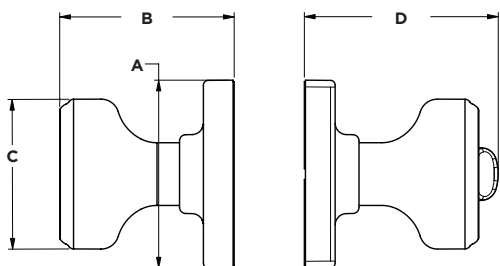

Maven	A	B	C	D (Entry)
RDT	2 5/8"	2 7/16"	2 3/32"	2 23/32"
SQT	2 5/8"	2 7/16"	2 3/32"	2 23/32"

Finishes



Matte Black 514



Satin Nickel 15



Polished Chrome 26

Functions



Passage/Hall/Closet: Both knobs always free.
- 200 MNK



Privacy/Bed/Bath: Both knobs locked or unlocked by turn-button inside. Outside knob unlocked by emergency key.
- 300 MNK



Keyed Entry: Both sides locked or unlocked by key outside or turn-button inside.
- 400 MNK



Half Dummy Trim, Surface Mounted: For doors where only a pull is required. No operation.
- 488 MNK



Interior Pack: Inside knob & thumb turn of handleset
687/800 Handlesets:
- 966 MNK: Single-Cylinder





One Key For All Your Locks

Protects against advanced break-in techniques and allows you to re-key your lock yourself in seconds.



LIFETIME WARRANTY



Superior Security Features

- ANSI/BHMA Grade 1 Certified 980/985/258 Deadbolts and 800/818 handlesets
- SmartKey Security - providing superior security against advanced break-in techniques.

Elegant Styles And Finishes

- Traditional to Contemporary Styles

Warranty

- Lifetime Mechanical
- Lifetime Finish



Arlington™ **Austin™** **Avalon™** **Brentford™** **Chelsea™** **Hawthorne**

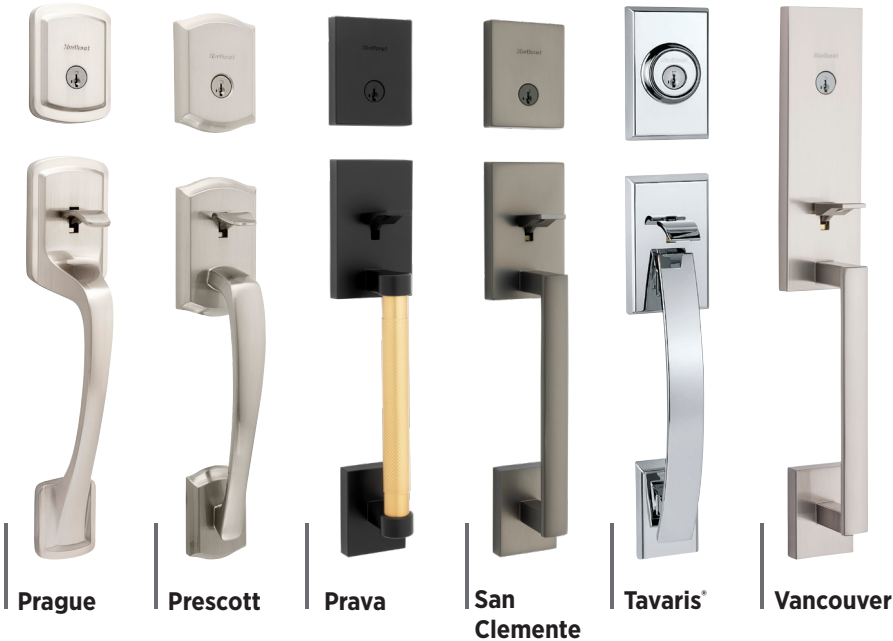

Prague **Prescott** **Prava** **San Clemente** **Tavaris™** **Vancouver**



**780/785
Deadbolt**



**980/985
Deadbolt**



**Halifax 158/159
Deadbolt**



**Milan 158/159
Deadbolt**



**Crosstown 258
Deadbolt**



**Downtown 258
Deadbolt**



**Hometown 258
Deadbolt**



**Midtown 258
Deadbolt**



**San Clemente
Rectangular
Deadbolt**



**Uptown 258
Deadbolt**



| **Abbey**



| **Arroyo**



| **Hancock**



| **Pismo**



| **Sora**



| **Sora TRCT**



| **Halifax**



| **Halifax**
San Clemente Trim



| **Katella**



| **Lisbon**



| **Milan**

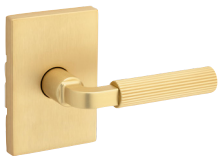

| **Mirada**



| **Mirada MDT**



| **Mirada TRDT**



| **Perth**



| **Prava**



| **Sedona**



| **Singapore**



| **Trafford**



| **Trafford TRCT**



| **Tripoli**



| **Tustin**



Arlington®



Austin™



Avalon™



Brentford



Chelsea



Hawthorne

Arlington®	Model	Function	3	L03	4	11P	15	18G	26	26D	514	Qty
	800AN SMT	Single Cylinder		\$317.20		\$326.60	\$317.20					4
	802AN	Dummy		\$260.50		\$268.20	\$260.50					4
	814AN	Handle Only*		\$207.20		\$213.50	\$207.20					4
	815AN	Handleset+ with Tustin		\$275.90		\$299.40	\$290.60					6
	815AN	Handleset+ with Hancock		\$275.90		\$284.10	\$275.90					6

*Denotes handleset without deadbolt

Austin®	Model	Function	3	L03	4	11P	15	18G	26	26D	514	Qty
	800AUH SMT	Single Cylinder				\$406.50	\$392.90					4
	802AUH	Dummy				\$365.60	\$352.10					4
	814AUH	Handle Only*				\$314.00	\$300.50					4

*Denotes handleset without deadbolt

Avalon	Model	Function	3	L03	4	11P	15	18G	26	26D	514	Qty
	800AVH SMT	Single Cylinder				\$406.50	\$392.90				\$406.50	4
	802AVH	Dummy				\$365.60	\$352.10				\$365.60	4
	814AVH	Handle Only*				\$314.00	\$300.50				\$314.00	4

*Denotes handleset without deadbolt

Brentford	Model	Function	3	L03	4	11P	15	18G	26	26D	514	Qty
	818BFH SMT	Single Cylinder					\$392.90				\$406.50	4
	819BFH	Dummy					\$352.10				\$365.60	4
	819BFH	Dummy with Sora					\$369.20				\$369.20	
	814BFH	Handle Only*					\$300.50				\$314.00	4

*Denotes handleset without deadbolt

Chelsea®	Model	Function	3	L03	4	11P	15	18G	26	26D	514	Qty
	800CE SMT	Single Cylinder		\$317.20		\$326.60	\$317.20		\$317.20			4
	802CE	Dummy		\$260.50		\$268.20	\$260.50		\$260.50			4
	814CE	Handle Only*					\$207.20					4
	815CE	Handleset+ with Hancock					\$275.90					6

*Denotes handleset without deadbolt

Hawthorne®	Model	Function	3	L03	4	11P	15	18G	26	26D	514	Qty
	800HE SMT	Single Cylinder				\$406.50	\$392.90				\$406.50	4
	802HE	Dummy				\$365.60	\$352.10				\$365.60	4
	814HE	Handle Only*				\$314.00	\$300.50				\$314.00	4

*Denotes handleset without deadbolt

NOTE: Handlesets ordered LIP only



Prague



Prava



Prescott



San Clemente



Tavaris®



Vancouver

Prague	Model	Function	3	L03	4	11P	15	18G	26	26D	514	Qty
	818PGH SMT	Single Cylinder				\$406.50	\$392.90		\$392.90		\$406.50	4
	819PGH	Dummy				\$365.60	\$352.10		\$352.10		\$365.60	4
	814PGH	Handle Only†				\$314.00	\$300.50		\$300.50		\$314.00	4

†Denotes handleset without deadbolt

Prava	Model	Function	3	4	11P	15	26	18G	26D	514	514/4	Qty
	818PVH SMT	Single Cylinder		\$430.30		\$416.80				\$430.30	\$430.30	4
	819PVH	Dummy		\$389.60		\$376.10				\$389.60	\$389.60	4
	814PVH	Handle Only†				\$324.40				\$337.90		4

†Denotes handleset without deadbolt

Prescott	Model	Function	3	L03	4	11P	15	18G	26	26D	514	Qty
	818PTH SMT	Single Cylinder		\$392.90		\$406.50	\$392.90				\$406.50	4
	819PTH	Dummy		\$352.10		\$365.60	\$352.10				\$365.60	4
	819PTH	Dummy with Sedona					\$369.20				\$369.20	4
	814PTH	Handle Only†		\$300.50		\$314.00	\$300.50				\$314.00	4
	815PTH	Handleset with Tustin†		\$376.70		\$389.50	\$376.70					4
	815PTH	Handleset with Hancock†		\$362.30		\$375.20	\$362.30					4

†Denotes handleset without deadbolt

San Clemente	Model	Function	3	L03	4	11P	15	18G	26	26D	514	Qty
	818SCE SMT	Single Cylinder			\$406.50	\$406.50	\$392.90	\$406.50	\$392.90	\$392.90	\$406.50	4
	819SCE	Dummy			\$365.60	\$365.60	\$352.10	\$365.60	\$352.10	\$352.10	\$365.60	4
	814SCE	Handle Only†				\$314.00	\$300.50		\$300.50		\$314.00	4
	815SCE	Handle with Halifax Lever†				\$389.50	\$376.70		\$376.70		\$389.50	4

†Denotes handleset without deadbolt

Tavaris®	Model	Function	3	L03	4	11P	15	18G	26	26D	514	Qty
	800TVH SMT	Single Cylinder				\$406.50	\$392.90		\$392.90	\$392.90	\$406.50	4
	802TVH	Dummy				\$365.60	\$352.10		\$352.10	\$352.10	\$365.60	4
	814TVH	Handle Only†				\$314.00	\$300.50		\$300.50		\$314.00	4

†Denotes handleset without deadbolt

Vancouver	Model	Function	3	L03	4	11P	15	18G	26	26D	514	Qty
	818VNH SMT	Single Cylinder				\$421.10	\$407.60			\$407.60	\$421.10	4
	819VNH	Dummy				\$380.50	\$366.90			\$366.90	\$380.50	4

* 818 VNH available only as standard configuration of 6AL RCS & 5303 (Round Corner Full Lip Strike)

INTERIOR PACKS FOR TRADITIONAL 687/800/802 HANDLESETS

Model	Function	Series			
		Signature Lever	Signature Knob	Security Lever	Security Knob
966	Single Cylinder	\$95.30	\$79.10	\$84.10	\$68.10
968	Dummy	\$95.30	\$79.10		

Handleset Interior Pack Finish Options		3	L03	4	5	11P	15	26	26D	514	Qty
	Halifax Lever					•	•	•	•	•	4
	Hancock Knob	•				•	•	•	•	•	4
	Katella Lever						•			•	4
	Lisbon Lever					•	•	•		•	4
	Milan Lever					•	•	•	•	•	4
	Perth Lever						•			•	4
	Pismo Knob					•	•	•	•	•	4
	Sedona Lever						•			•	4
	Singapore					•	•	•		•	4
	Sora			•			•			•	4
Trafford Lever					•	•			•	4	
	Tustin Lever	•				•	•	•	•	•	4
	Balboa Lever					○	○	○	○	○	4
	Breton Lever						○	○		○	4
	Casey Lever						○	○		○	4
	Cove Knob					○	○			○	4
	Delta Lever					○	○	○	○		4
	Dorian Lever					○	○				4
	Henley Lever						○			○	4
	Ladera Lever						○	○	○	○	4
	Maven Knob*						○	○		○	4
Polo Knob				○	○	○	○	○	○	4	
Tylo Knob	○			○		○	○	○		4	

*Available in 966 only

SECTIONAL INTERIOR PACKS FOR LOW PROFILE 818/819 HANDLESETS

Model	Function	Series			
		Signature Lever	Signature Knob	Security Lever	Security Knob
971	Single Cylinder	\$95.30	\$79.10	\$84.10	
973	Dummy	\$95.30	\$79.10		

Handleset Interior Pack Finish Options		3	L03	4	5	11P	15	18G	26	26D	514	514/4	Qty
	Arroyo Knob						•		•		•		4
	Halifax Lever			•		•	•	•	•	•	•		4
	Halifax RCT Lever						•		•		•		4
	Hancock Knob*					•	•				•		4
	Katella Lever						•				•		4
	Lisbon Lever					•	•		•		•		4
	Milan Lever					•	•		•	•	•		4
	Mirada RCT Lever			•			•				•	•	4
	Mirada TRCT Lever										•		4
	Mirada MDT										•		4
	Prava Lever*			•			•				•	•	4
	Perth Lever						•				•		4
	Pismo Knob			•		•	•	•	•	•	•		4
	Sedona Lever			•			•				•		4
	Singapore Lever			•		•	•		•		•		4
	Sora Knob			•			•				•		4
	Sora TRCT Knob			•			•				•		4
	Trafford Lever					•	•				•		4
	Tripoli Lever						•		•		•		4
	Tustin Lever	•					•	•			•		4
Breton Lever* **						•		•		•		4	
Casey Lever* **						•		•		•		4	

*Available in 971 only, **SQT only, 973H only available in 514

NOTE: Handlesets ordered LIP only

NOTE: Square (SQT) or Round (RDT) rose options available

○ Only available in Single Cyl Function Only

FULL SQUARE INTERIOR PACKS FOR LOW PROFILE 818/819 HANDLESETS

Model	Function	Series			
		Halifax Lever	Signature Knob	Security Lever	Security Knob
971 SQF	Single Cylinder	\$108.50			
973 SQF	Dummy	\$108.50			



Handleset Interior Pack Finish Options	3	L03	5	11P	15	26	26D	514	Qty
Halifax Lever				•	•	•		•	4

Note: Only square (SQF) rose option available

Halifax™	Model	Function	3	4	11P	15	18G	26	26D	514	514x26	Qty
	720HFL	Hall/Closet		\$88.10	\$88.10	\$84.00	\$88.10	\$84.00	\$84.00	\$88.10	\$88.10	12
	720HFL	Hall/Closet FD				\$86.90		\$86.90	\$86.90	\$91.20		12
	725HFL*	Hall/Closet UL				\$91.00		\$91.00	\$91.00	\$95.20		12
	730HFL	Bed/Bath		\$92.00	\$92.00	\$87.80	\$92.00	\$87.80	\$87.80	\$92.00	\$92.00	12
	740HFL SMT	Entry		\$150.30	\$150.30	\$146.20	\$150.30	\$146.20	\$146.20	\$150.30	\$150.30	12
	745HFL SMT*	Entry UL				\$153.10		\$153.10	\$153.10	\$157.40		12
	750HFL SMT	Storeroom Entry UL				\$153.00		\$153.00	\$153.00	\$157.30		12
	788HFL	Half Dummy		\$44.10	\$44.10	\$42.00	\$44.10	\$42.00	\$42.00	\$44.10		20

NOTE: Can be ordered with (RDT) Round Rose or (SQT) Square Rose option. Example - 720HFL RDT 11P, (with the exception of the 725 and 745 functions)

**Halifax™
San Clemente
Trim**



Model	Function	3	4	11P	15	18G	26	26D	514	Qty
720HFL RCT	Hall/Closet		\$98.40		\$94.30		\$94.30		\$98.40	12
730HFL RCT	Bed/Bath		\$102.60		\$98.40		\$98.40		\$102.60	12
740HFL RCT SMT	Entry		\$163.10		\$158.90		\$158.90		\$163.10	12
788HFL RCT	Half Dummy		\$49.20		\$47.10		\$47.10		\$49.20	20

**Halifax LED
Lever***



Model	Function	3	4	11P	15	18G	26	26D	514	Qty
720HFL SQT LED	Hall/Closet								\$105.80	12
730HFL SQT LED	Bed/Bath								\$109.70	12

Katella



Model	Function	3	4	11P	15	18G	26	26D	514	Qty
720KAL	Hall/Closet				\$84.00				\$88.10	12
730KAL	Bed/Bath				\$87.80				\$92.00	12
740KAL SMT	Entry				\$146.20				\$150.30	12
788KAL	Half Dummy				\$42.00				\$44.10	20

Lisbon Lever



Model	Function	3	4	11P	15	18G	26	26D	514	Qty
720LSL	Hall/Closet			\$88.10	\$84.00		\$84.00		\$88.10	12
730LSL	Bed/Bath			\$92.00	\$87.80		\$87.80		\$92.00	12
740LSL SMT	Entry			\$150.30	\$146.20		\$146.20		\$150.30	12
788LSL	Half Dummy			\$44.10	\$42.00		\$42.00		\$44.10	20

NOTE: Can be ordered with (RDT) Round Rose or (SQT) Square Rose option. Example - 720LSL RDT 11P

Milan Lever



Model	Function	3	4	11P	15	18G	26	26D	514	Qty
720MIL	Hall/Closet			\$88.10	\$84.00		\$84.00	\$84.00	\$88.10	12
720MIL FD	Hall/Closet FD				\$86.90		\$86.90	\$86.90	\$91.20	12
730MIL	Bed/Bath			\$92.00	\$87.80		\$87.80	\$87.80	\$92.00	12
740MIL SMT	Entry			\$150.30	\$146.20		\$146.20	\$146.20	\$150.30	12
750MIL SMT	Storeroom Entry UL**				\$153.00				\$157.30	12
788MIL	Half Dummy			\$44.10	\$42.00		\$42.00	\$42.00	\$44.10	20

NOTE: Can be ordered with (RDT) Round Rose or (SQT) Square Rose option. Example - 720MIL SQT 11P, (with the exception of the 750 function)

*(SQT) Square Rose Only

** (RDT) Round Rose Only

Mirada RCT Lever



Model	Function	3	4	11P	15	18G	26	26D	514	514/4	Qty
720MAL RCT	Hall/Closet		\$121.80		\$117.80				\$121.80	\$121.80	12
730MAL RCT	Bed/Bath		\$126.20		\$121.80				\$126.20	\$126.20	12
740MAL RCT SMT	Entry		\$186.60		\$182.40				\$186.60	\$186.60	12
788MAL RCT	Half Dummy		\$72.70		\$72.70				\$72.70	\$72.70	20

Mirada TRDT Lever



Model	Function	3	4	11P	15	18G	26	26D	514	514/4	Qty
720MAL	Hall/Closet								\$107.70		12
730MAL	Bed/Bath								\$111.70		12
740MAL SMT	Entry								\$170.80		12
788MAL	Half Dummy								\$64.40		20

Mirada MDT Lever



Model	Function	3	4	11P	15	18G	26	26D	514	514/4	Qty
720MAL	Hall/Closet								\$107.70		12
730MAL	Bed/Bath								\$111.70		12
740MAL SMT	Entry								\$170.80		12
788MAL	Half Dummy								\$64.40		20

Perth



Model	Function	3	4	11P	15	18G	26	26D	514	514/4	Qty
720PHL	Hall/Closet				\$84.00				\$88.10		12
730PHL	Bed/Bath				\$87.80				\$92.00		12
740PHL SMT	Entry				\$146.20				\$150.30		12
788PHL	Half Dummy				\$42.00				\$44.10		20

Prava Lever



Model	Function	3	4	11P	15	18G	26	26D	514	514/4	Qty
720PVL	Hall/Closet		\$121.80		\$117.80				\$121.80	\$121.80	12
730PVL	Bed/Bath		\$126.20		\$121.80				\$126.20	\$126.20	12
740PVL SMT	Entry		\$186.60		\$182.40				\$186.60	\$186.60	12
788PVL	Half Dummy		\$72.70		\$70.60				\$72.70	\$72.70	20

Sedona



Model	Function	3	4	11P	15	18G	26	26D	514	514/4	Qty
720SEL	Hall/Closet		\$88.10		\$84.00				\$88.10		12
730SEL	Bed/Bath		\$92.00		\$87.80				\$92.00		12
740SEL SMT	Entry		\$150.30		\$146.20				\$150.30		12
788SEL	Half Dummy		\$44.10		\$42.00				\$44.10		20

Singapore



Model	Function	3	4	11P	15	18G	26	26D	514	514/4	Qty
720SAL SQT	Hall/Closet		\$88.10	\$88.10	\$84.00		\$84.00		\$88.10		12
730SAL SQT	Bed/Bath		\$92.00	\$92.00	\$87.80		\$87.80		\$92.00		12
740SAL SMT SQT	Entry		\$150.30	\$150.30	\$146.20		\$146.20		\$150.30		12
788SAL SQT	Half Dummy		\$44.10	\$44.10	\$42.00		\$42.00		\$44.10		20

Trafford



Model	Function	3	4	11P	15	18G	26	26D	514	514/4	Qty
720TDL	Hall/Closet			\$88.10	\$84.00				\$88.10		12
730TDL	Bed/Bath			\$92.00	\$87.80				\$92.00		12
740TDL SMT	Entry			\$150.30	\$146.20				\$150.30		12
788TDL	Half Dummy			\$44.10	\$42.00				\$44.10		20

Trafford TRCT



Model	Function	3	4	11P	15	18G	26	26D	514	514/4	Qty
720TDL	Hall/Closet				\$94.30				\$98.40		12
730TDL	Bed/Bath				\$98.40				\$102.60		12
740TDL SMT	Entry				\$158.90				\$163.10		12
788TDL	Half Dummy				\$47.10				\$49.20		20

Tripoli	Model	Function	3	4	11P	15	18G	26	26D	514	Qty
	720TPL MDT	Hall/Closet				\$84.00		\$84.00		\$88.10	12
	730TPL MDT	Bed/Bath				\$87.80		\$87.80		\$92.00	12
	740TPL MDT SMT	Entry				\$146.20		\$146.20		\$150.30	12
	788TPL MDT	Half Dummy				\$42.00		\$42.00		\$44.10	20

Tustin™ Lever	Model	Function	3	4	11P	15	18G	26	26D	514	Qty
	720TNL	Hall/Closet	\$64.60		\$75.40	\$71.30		\$71.30	\$71.30	\$75.40	20
	730TNL	Bed/Bath	\$68.50		\$79.30	\$75.10		\$75.10	\$75.10	\$79.30	20
	740TNL SMT	Entry	\$98.60		\$109.50	\$105.10		\$105.10	\$105.10	\$109.50	20
	788TNL	Half Dummy	\$32.40		\$37.80	\$35.60		\$35.60	\$35.60	\$37.80	20

Abbey®	Model	Function	3	4	5	11P	15	18G	26	26D	514	Qty
	720A	Hall/Closet	\$39.90								\$46.60	12
	730A	Bed/Bath	\$44.10								\$51.10	12
	740A SMT	Entry	\$73.20								\$80.20	12
	750A SMT	Storeroom	\$79.10								\$86.00	12
	788A	Half Dummy	\$19.90								\$23.30	20

Arroyo	Model	Function	3	4	5	11P	15	18G	26	26D	514	Qty
	720AYK MDT	Hall/Closet					\$59.00		\$59.00		\$63.10	12
	730AYK MDT	Bed/Bath					\$63.20		\$63.20		\$67.40	12
	740AYK MDT SMT	Entry					\$92.30		\$92.30		\$96.60	12
	788AYK MDT	Half Dummy					\$29.50		\$29.50		\$31.60	20

Hancock™	Model	Function	3	4	11P	15	26	18G	26D	514	11Px26	Qty
	720H	Hall/Closet	\$42.10		\$53.10	\$49.00	\$49.00		\$49.00	\$53.10	\$53.10	12
	730H	Bed/Bath	\$46.20		\$57.40	\$53.20	\$53.20		\$53.20	\$57.40		12
	740H	Entry	\$69.50		\$80.60	\$76.50	\$76.50		\$76.50	\$80.60		12
	740H SMT	Entry	\$75.40		\$86.60	\$82.40	\$82.40		\$82.40	\$86.60		12
	750H	Storeroom	\$75.40			\$82.40			\$82.40			12
	750H SMT	Storeroom	\$81.30			\$88.20			\$88.20			12
	788H	Half Dummy	\$21.00		\$26.50	\$24.40	\$24.40		\$24.40	\$26.50		20

Pismo	Model	Function	3	4	11P	15	26	18G	26D	514	514x26	Qty
	720PSK	Hall/Closet		\$63.10	\$63.10	\$59.00	\$63.10	\$59.00	\$59.00	\$63.10	\$63.10	12
	730PSK	Bed/Bath		\$67.40	\$67.40	\$63.20	\$67.40	\$63.20	\$63.20	\$67.40	\$67.40	12
	740PSK SMT	Entry		\$96.60	\$96.60	\$92.30	\$96.60	\$92.30	\$92.30	\$96.60	\$96.60	12
	788PSK	Half Dummy		\$31.60	\$31.60	\$29.50	\$31.60	\$29.50	\$29.50	\$31.60		20

NOTE: Can be ordered with (RDT) Round Rose or (SQT) Square Rose option.
 Example - 720PSK RDT 514; *(SQT) Square Rose Only. Split finish available in RDT trim only.

Sora	Model	Function	3	4	5	11P	15	18G	26	26D	514	Qty
	720SOK	Hall/Closet		\$88.10			\$84.00				\$88.10	12
	730SOK	Bed/Bath		\$92.00			\$87.80				\$92.00	12
	740SOK SMT	Entry		\$150.30			\$146.20				\$150.30	12
	788SOK	Half Dummy		\$44.10			\$42.40				\$44.10	20

Sora Traditional Rectangular Rose

	Model	Function	3	4	5	11P	15	18G	26	26D	514	Qty
	720SOK TRCT	Hall/Closet		\$98.40			\$94.30				\$98.40	12
	730SOK TRCT	Bed/Bath		\$102.60			\$98.40				\$102.60	12
	740SOK TRCT SMT	Entry		\$163.10			\$158.90				\$163.10	12
	788SOK TRCT	Half Dummy		\$49.20			\$47.10				\$49.20	20

780/785



Model	Function	3	4	11P	15	18G	26	26D	514	11Px26	Qty
780	Single Cylinder	\$80.30		\$96.20	\$91.90		\$91.90	\$91.90	\$96.20		12
780 SMT	Single Cylinder	\$80.30		\$96.20	\$91.90		\$91.90	\$91.90	\$96.20	\$96.20	12
782 SMT	Single Cylinder UL				\$94.60			\$94.60	\$98.80		12
785	Double Cylinder	\$118.80		\$134.80	\$130.50		\$130.50	\$130.50	\$134.80		12
785 SMT	Double Cylinder	\$118.80		\$134.80	\$130.50		\$130.50	\$130.50	\$134.80		12

980/985



Model	Function	3	4	11P	15	18G	26	26D	514	Qty
980 SMT	Single Cylinder			\$112.80	\$108.30				\$112.80	12
982 SMT	Single Cylinder UL				\$110.40				\$114.60	12
985 SMT	Double Cylinder			\$151.30	\$146.90				\$151.30	12

Crosstown Deadbolt



Model	Function	3	4	11P	15	18G	26	26D	514	Qty
258 TRCT SMT	Single Cylinder		\$117.70		\$113.50				\$117.70	12

Downtown Deadbolt



Model	Function	3	4	11P	15	18G	26	26D	514	Qty
258 SQT SMT	Single Cylinder		\$107.60	\$107.60	\$103.30	\$107.60	\$103.30	\$103.30	\$107.60	12
258 SQT SMT	Single Cylinder FD								\$110.40	12

Halifax Deadbolt



Model	Function	3	4	11P	15	18G	26	26D	514	514x26	Qty
158 SQT SMT	Single Cylinder			\$96.20	\$91.90		\$91.90	\$91.90	\$96.20	\$96.20	12
158 SQT SMT	Single Cylinder FD				\$94.90		\$94.90	\$94.90	\$99.20		12
982 SQT SMT	Single Cylinder UL				\$94.60		\$94.60	\$94.60	\$98.80		12
159 SQT SMT	Double Cylinder			\$134.80	\$130.50		\$130.50	\$130.50	\$134.80		12

Hometown Deadbolt



Model	Function	3	4	11P	15	18G	26	26D	514	Qty
258 SMT	Single Cylinder		\$107.60	\$107.60	\$103.30				\$107.60	12

Midtown Deadbolt



Model	Function	3	4	11P	15	18G	26	26D	514	Qty
258 MDT SMT	Single Cylinder				\$103.30		\$103.30		\$107.60	12

Milan Deadbolt



Model	Function	3	4	11P	15	18G	26	26D	514	514x26	Qty
158 RDT SMT	Single Cylinder			\$96.20	\$91.90		\$91.90	\$91.90	\$96.20	\$96.20	12
158 RDT SMT	Single Cylinder FD				\$94.90		\$94.90	\$94.90	\$99.20		12
982 RDT SMT	Single Cylinder UL				\$94.60		\$94.60	\$94.60	\$98.80		12
159 RDT SMT	Double Cylinder			\$134.80	\$130.50		\$130.50	\$130.50	\$134.80		12

San Clemente Deadbolt



Model	Function	3	4	11P	15	18G	26	26D	514	Qty
258 RCT SMT	Single Cylinder		\$117.70		\$113.50		\$113.50		\$117.70	12

Uptown Deadbolt



Model	Function	3	4	11P	15	18G	26	26D	514	Qty
258 RDT SMT	Single Cylinder		\$107.60	\$107.60	\$103.30	\$107.60	\$103.30	\$103.30	\$107.60	12
258 RDT SMT	Single Cylinder FD								\$110.40	12



KWIKSET SIGNATURE SERIES HANDLESETS

Door Prep	Deadbolt: Cross Bore 2-1/8" or 1-1/2". Edge Bore 1". Handle: Cross Bore 2-1/8". Edge Bore 1".
Backset	Deadbolt: Adjustable to 2-3/8" or 2-3/4". Handle: Adjustable to 2-3/8" or 2-3/4".
Door Thickness	1-3/4" doors standard. 2-1/4" doors optional. Not designed for use on 1-3/8" doors.
Cylinder	SmartKey Security
Faceplate	1" x 2-1/4". Specify round corner, square corner or drive-in.
Strikes	Deadbolt: 2.74" x 1.115" round corner and square corner. 2.25" x 1.75" 5303 round corner full lip strike (grade 3 when used) Other strikes are available as service parts. Handle: 2-1/4" round corner and square corner full lip. Other options available as service parts.
Bolt	Deadbolt: 1" throw. Handle: 1/2" throw.
Door Handing	Reversible for right or left-hand doors.
ANSI/BHMA	Deadbolt is Grade 1 Certified.
ADA	N/A
UL	N/A

KWIKSET SIGNATURE SERIES LEVERS

Door Prep	Cross Bore 2-1/8" Edge Bore 1" Latch Face 1" x 2-1/4"
Backset	Adjustable 2-3/8" or 2-3/4".
Door Thickness	1-3/8" - 1-3/4" doors standard. 2-1/4" doors optional on 720 and 740 models. Up to 2-1/8" doors optional on HFL/MIL/LSL/MRL/SAL
Cylinder	SmartKey Security
Rose	Specify round or square rose - HFL, LSL, MIL, SAL
Faceplate	1" x 2-1/4" round corner, square corner and drive in collar. Round front comes staked.
Strikes	2-1/4" round corner full lip. Other options available as service parts.
Bolt	1/2" throw
Door Handing	Specify handing only with Tustin and Sedona inactive levers
ANSI/BHMA	Grade 2 Certified.
ADA	All families except Tustin in Functions Passage, Privacy are in compliance with the American National Standards Institute (ANSI A117.1) and the Americans with Disabilities Act (ADA).
UL	UL 3 hour fire rating and 1/3 hour fire rating available on select families.

KWIKSET SIGNATURE SERIES KNOBS

Door Prep	Cross Bore: 2-1/8" Edge Bore: 1" Latch Face: 1"x 2-1/4".
Backset	Adjustable to 2-3/8" or 2-3/4".
Door Thickness	1-3/8" - 1-3/4" doors standard.
Cylinder	SmartKey Security or Pin & Tumbler.
Faceplate	1" x 2-1/4" round corner, square corner and drive-in collar.
Strikes	2-1/4" round corner full lip. Other options available as service parts.
Bolt	1/2" throw.
Door Handing	Reversible for right- or left-hand doors.
ANSI/BHMA	Grade 2 Certified
ADA	N/A
UL	N/A

VANCOUVER HANDLESET

Door Prep (Deadbolt/Handle)	Crossbore 2-1/8". Edge Bore 1". Latch Face 1" x 2-1/4" Deadbolt & Handle bore holes must be 5-1/2" apart
Backset (Deadbolt/Handle)	Adjustable 2-3/8" or 2-3/4"
Door Thickness	1-3/4" Standard. Thick door service part available for up to 2-1/4"
Cylinder	SmartKey Security
Faceplate	1" x 2-1/4". Square, round, or drive in Deadbolt: 2.74" x 1.115" round corner and square corner 2.25" x 1.75" 5303 round corner full lip strike (grade 3 when used) Handle: 2-1/4" round corner and square corner full lip. Other options available as service parts.
Strikes	Other strikes are available as service parts.
Bolt	Deadbolt: 1" Throw Handle: 1/2" Throw
Door Handing	Reversible for right or left-hand doors.
ANSI/BHMA	Deadbolt - A156.39 Grade AAA Certified
ADA	N/A
UL	N/A

*Optional UL 1/3 hour list price charge is \$2.50.

**KWIKSET SIGNATURE SERIES
158/159 CONTEMPORARY DEADBOLTS**

Door Prep	Cross Bore 2-1/8" or 1-1/2". Edge Bore 1".
Backset	Adjustable 2-3/8" or 2-3/4".
Door Thickness	1-3/8" - 1-3/4".
Cylinder	SmartKey Security
Rose	Specify round or square rose
Strikes	2.74" x 1.115" round corner and square corner 2.25" x 1.75" 5303 round corner full lip strike (grade 3 when used) Other strikes are available as service parts.
Bolt	1" Throw Steel.
ANSI/BHMA	A156.36 Grade 2
ADA	Interior turn pieces are in compliance with the American National Standards Institute (ANSI A117.1) and the Americans with Disabilities Act (ADA).
UL	UL 3 hour and 1/3 hour fire rating available on select SKUs.

**KWIKSET SIGNATURE SERIES
780-785 DEADBOLTS**

Door Prep	780, 785: Crossbore 2-1/8" or 1-1/2". Edge Bore 1".
Backset	Adjustable 2-3/8" or 2-3/4" standard.
Door Thickness	1-3/8" - 1-3/4" doors standard. 1-7/8" - 2-1/4" optional.
Cylinder	SmartKey Security or 6-pin removable core.
Faceplate	1" x 2-1/4" round corner, square corner and drive-in collar
Strikes	2.74" x 1.115" round corner and square corner 2.25" x 1.75" 5303 round corner full lip strike (grade 3 when used) Other strikes are available as service parts.
Bolt	1" throw.
Door Handing	Reversible for right or left-hand doors.
ANSI/BHMA	Grade 2 Certified.
ADA	Interior turn pieces are in compliance with the American National Standards Institute (ANSI A117.1) and the Americans with Disabilities Act (ADA).
UL	Meets UL 3 hour fire rating for 782. UL 1/3 hour fire rating available on select SKUs.

**KWIKSET SIGNATURE SERIES
980/985 DEADBOLTS**

Door Prep	980: Crossbore 2-1/8" or 1-1/2". Edge Bore 1". 982: Crossbore 2-1/8".
Backset	Adjustable 2-3/8" or 2-3/4".
Door Thickness	1-3/8" - 1-3/4" doors standard. 1-7/8" - 2-1/4" optional.
Cylinder	SmartKey Security
Faceplate	1" x 2-1/4" round corner, square corner and drive-in collar
Strikes	2.74" x 1.115" round corner and square corner 2.25" x 1.75" 5303 round corner full lip strike (grade 3 when used) Other strikes are available as service parts.
Bolt	1" throw.
Door Handing	Reversible for right or left-hand doors.
ANSI/BHMA	Grade 1 Certified.
ADA	Interior turn pieces are in compliance with the American National Standards Institute (ANSI A117.1) and the Americans with Disabilities Act (ADA).
UL	Meets UL 3 hour fire rating for 982 UL 1/3 hour fire rating available on select SKUs.

KWIKSET SIGNATURE SERIES 258 DEADBOLTS

Door Prep	Cross Bore 2-1/8". Edge Bore 1".
Backset	Adjustable 2-3/8" or 2-3/4".
Door Thickness	1-3/8" - 1-3/4" Standard. Thick door service part available for up to 2'1/4".
Cylinder	Smartkey Security
Faceplate	1" x 2-1/4" round corner, square corner and drive-in collar
Rose	Specify round (Uptown) or square (Downtown) rose.
Strikes	2.74" x 1.115" round corner and square corner 2.25" x 1.75" 5303 round corner full lip strike (grade 3 when used) Other strikes are available as service parts.
Bolt	1" Throw Steel.
ANSI/BHMA	A156.36 Grade 1
ADA	Interior turn pieces are in compliance with the American National Standards Institute (ANSI A117.1) and the Americans with Disabilities Act (ADA).
UL	UL 1/3 hour fire rating available on select SKUs.

KWIKSET SIGNATURE SERIES HANDLESET

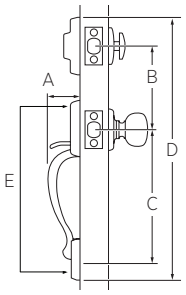

Design	A	B	C	D	E
Arlington*	2-1/2"	5-1/2"	11"	19-1/16"	15"
Austin	3-1/8"	5-1/2"	8-13/32" 9-1/8" 9-11/16"	18-13/32"	13-17/20"
Avalon™	2-7/8"	5-1/2"	8-13/32"	18- 5/32" 12-13/20"	13"
Brentford™	2-11/16"	5-1/2"	9-5/16"	18 -1/16"	13-1/32"
Chelsea*	2-3/16"	5-1/2"	9-11/16"	18 -1/2"	13"
Hawthorne™	2-7/8"	5-1/2"	8-13/32"	17-7/16"	13-2/5"
Prague	2-25/32"	5-1/2"	8-13/32"	17-23/32"	
Prava	2-21/32"	5-1/2"	8-13/32"	17-15/16"	13-7/16"
Prescott	2-25/32"	5-1/2"	8-13/32"	17-23/32"	
San Clemente	2-5/8"	5-1/2"	8-13/32"	17-15/16"	
Tavaris	2-17/32"	5-1/2"	8-13/32"	18"	12-19/25"
Vancouver	2-1/32"	5-1/2"	8-13/32" 9-11/16"	17-15/16"	

KWIKSET SIGNATURE SERIES KNOBS

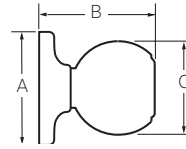

Design	A	B	C
Arroyo	2-5/8"	2-7/16"	2-3/16"
Abbey*	2-5/8"	2-7/16"	2"
Hancock*	2-5/8"	2-1/2"	2-3/8"
Pismo	2-5/8"	2-13/32"	2-6/7"
Sora Round	2-21/32"	2-21/32"	2-3/16"
Sora Rectangular	2-21/32"	2-21/32"	2-3/16"

KWIKSET SIGNATURE SERIES LEVERS

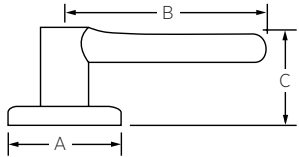

Design	A	B	C	B (Keyed)	C (Keyed)
Halifax	2-5/8"	4-15/32"	2-19/32"		2-3/8"
Katella	2-21/32"	4-1/4"	2-15/32"		2-9/16"
Lisbon	2-5/8"	4-5/32"	2-9/16"		2-3/8"
Milan	2-5/8"	4-5/32"	2-9/16"		2-3/8"
Mirada	4-1/8"	5-5/8"	2-25/32"		2-13/32"
Perth	2-21/32"	4-1/4"	2-7/16"		2-11/32"
Prava	2-25/32"	4-1/4"	2-3/8"		
Sedona	2-21/32"	4-1/4"	2-17/32"	4-9/32"	2-5/16"
Singapore Square	2-11/16"	4-7/32"	2-1/2"		2-1/4"
Trafford	2-21/32"	4-5/32"	2-19/32"		2-9/16"
Tustin*	2-5/8"	4-7/32"	2-3/32"		2-19/32"
Tripoli	2-11/16"	4-1/14"	2-9/16"		2-9/16"

KWIKSET SIGNATURE SERIES 158-159 DEADBOLT

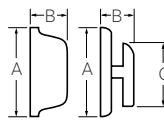

Round Design	A	B	C
158 Interior	2-17/32"	1-13/32"	1-11/16"
158 Exterior	2-17/32"	15/16"	
159 Interior	2-17/32"	1-13/32"	1-11/16"
159 Exterior	2-17/32"	15/16"	

Square Design	A	B	C
158 Interior	2-17/32"	1-13/32"	1-11/16"
158 Exterior	2-19/32"	15/16"	
159 Interior	2-17/32"	1-13/32"	1-11/16"
159 Exterior	2-19/32"	15/16"	

KWIKSET SIGNATURE SERIES 980-985 DEADBOLT

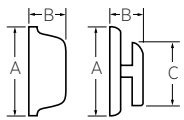

Design	A	B	C
980 Interior	2-19/32"	1-5/32"	1-13/16"
980 Exterior	2-5/8"	1-1/32"	
985 Interior	2-5/8"	1-1/32"	
985 Exterior	2-5/8"	1-1/32"	

KWIKSET SIGNATURE SERIES 780-785 DEADBOLT

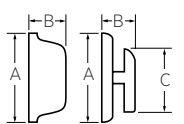

Design	A	B	C
780	2-1/2"	15/16"	1-25/32"
780	2-5/8"	1-1/8"	
785 Interior	2-5/8"	1-1/8"	
785 Exterior	2-5/8"	1-1/8"	

KWIKSET SIGNATURE SERIES 258 UPTOWN, DOWNTOWN & MIDTOWN

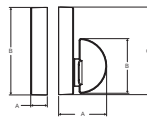

Design	A	B	C
258 Round Interior	1-3/8"	1-21/32"	2-5/8"
258 Round Exterior	9/16"	2-5/8"	

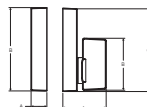

Design	A	B	C
258 Square Interior	1-7/16"	1-21/32"	2-5/8"
258 Square Exterior	1/2"	2-5/8"	

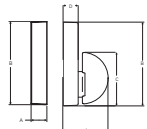

Design	A	B	C	D
258 MDT Interior	1-7/16"	2-11/16"	1-21/32"	1/2"
258 MDT Exterior	1/2"	2-11/16"		

Design	A	B	C	D
258	2-21/32"	1/2"	2-21/32"	1-1/8"
258 TRCT	3-9/16"	2-25/32"	9/16"	1-3/8"

Trusted Security



- ANSI/BHMA Grade 3
- Easy Installation
- Available with SmartKey® Security
- Most Recognized Styles

Warranty

- Lifetime Mechanical
- Lifetime Finish



Amador



Bellevue™



Dakota™



Henley



Cove™



Maven



Polo®



Tylo®



Balboa™



Breton

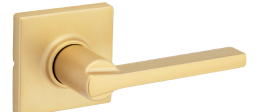

Casey



Delta®

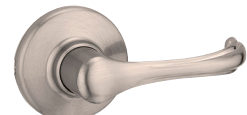

Dorian®



Henley



Ladera®



660/665
Deadbolt



660 RDT
Contemporary



660 SQT
Deadbolt

Amador

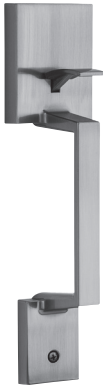

Belleview™



Dakota™



Henley



Amador	Model	Function	3	5	11P	15	26	26D	514	Qty
	687AMD SMT	Single Cylinder				\$227.30	\$227.30	\$204.80	\$238.30	6
	898AMD [†]	Handle Only				\$179.00	\$179.00		\$189.50	6

[†]Denotes handleset without deadbolt

Belleview™	Model	Function	3	5	11P	15	26	26D	514	Qty
	687BW	Single Cylinder				\$181.10				6
	687BW SMT	Single Cylinder				\$192.30		\$151.10	\$192.30	6

Dakota™	Model	Function	3	5	11P	15	26	26D	514	Qty
	687DA	Single Cylinder			\$177.00	\$175.20				6
	687DA SMT	Single Cylinder		\$158.60	\$192.30	\$181.10		\$158.60	\$192.30	6
	898DA [†]	Handle Only			\$134.40	\$129.20				6

[†]Denotes handleset without deadbolt

Henley	Model	Function	3	5	11P	15	26	26D	514	Qty
	687HYH SMT	Single Cylinder				\$227.30			\$238.30	6
	898HYH [†]	Handle Only			\$189.50	\$179.00			\$189.50	6

[†]Denotes handleset without deadbolt

NOTE: All 687 handlesets are compatible with the 966 interior packs found on page 30

Balboa	Model	Function	3	4	5	11P	15	26	26D	514	Qty
	200BL	Hall/Closet	\$51.30		\$51.30	\$59.50	\$56.00	\$56.00	\$51.30	\$59.50	20
	200BL	Hall/Closet FD					\$58.90				20
	300BL	Bed/Bath	\$54.70		\$54.70	\$63.00	\$59.50	\$59.50	\$54.70	\$63.00	20
	405BL	Keyed Lever			\$72.60	\$80.70	\$77.40		\$72.60		20
	405BL SMT	Keyed Lever	\$78.50		\$78.50	\$86.50	\$83.10	\$83.10	\$78.50	\$86.50	20
	488BL	Half Dummy	\$25.70		\$25.70	\$29.60	\$28.10	\$28.10	\$25.70	\$29.60	20

Breton RDT	Model	Function	3	4	5	11P	15	26	26D	514	Qty
	200BRNL RDT	Hall/Closet					\$61.40	\$61.40		\$64.80	12
	300BRNL RDT	Bed/Bath					\$64.80	\$64.80		\$68.30	12
	405BRNL RDT SMT	Keyed Lever					\$88.60	\$88.60		\$92.00	12
	488BRNL RDT	Half Dummy					\$30.90	\$30.90		\$32.50	20

Breton SQT	Model	Function	3	4	5	11P	15	26	26D	514	Qty
	200BRNL SQT	Hall/Closet					\$61.40	\$61.40		\$64.80	12
	300BRNL SQT	Bed/Bath					\$64.80	\$64.80		\$68.30	12
	405BRNL SQT SMT	Keyed Lever					\$88.60	\$88.60		\$92.00	12
	488BRNL SQT	Half Dummy					\$30.90	\$30.90		\$32.50	12

Casey RDT	Model	Function	3	4	5	11P	15	26	26D	514	Qty
	200CSL RDT	Hall/Closet					\$61.40	\$61.40		\$64.80	12
	200CSL RDT	Hall/Closet FD					\$64.30	\$64.30		\$67.80	12
	300CSL RDT	Bed/Bath					\$64.80	\$64.80		\$68.30	12
	405CSL RDT SMT	Keyed Lever					\$88.60	\$88.60		\$92.00	12
	488CSL RDT	Half Dummy					\$30.90	\$30.90		\$32.50	20

Casey SQT	Model	Function	3	4	5	11P	15	26	26D	514	Qty
	200CSL SQT	Hall/Closet		\$66.80			\$61.40	\$61.40		\$64.80	12
	200CSL SQT	Hall/Closet FD		\$69.80			\$64.30	\$64.30		\$67.80	12
	300CSL SQT	Bed/Bath		\$70.30			\$64.80	\$64.80		\$68.30	12
	405CSL SQT SMT	Keyed Lever		\$94.00			\$88.60	\$88.60		\$92.00	12
	488CSL SQT	Half Dummy		\$34.50			\$30.90	\$30.90		\$32.50	12

Delta	Model	Function	3	4	5	11P	15	26	26D	514	Qty
	200DL	Hall/Closet				\$59.40	\$56.00	\$56.00	\$51.30		12
	200DL	Hall/Closet FD					\$59.30		\$54.20		12
	300DL	Bed/Bath				\$63.00	\$59.50	\$59.50	\$54.70		12
	405DL	Keyed Lever				\$82.00	\$77.40		\$72.60		12
	405DL SMT	Keyed Lever	\$78.50			\$88.10	\$83.10	\$83.10	\$78.50		12
	409DL SMT	Keyed Lever UL					\$90.00		\$85.30		12
	412DL SMT	Storeroom Keyed Lever UL							\$88.80		12
	420DL	Hall/Closet UL					\$66.50		\$61.70		12
	462DL	Storeroom Keyed Lever							\$76.00		12
	462DL SMT	Storeroom Keyed Lever						\$86.50	\$81.90		12
	488DL	Half Dummy				\$29.60	\$28.10	\$28.10	\$25.70		20

Dorian	Model	Function	3	4	5	11P	15	26	26D	514	Qty
	200DNL	Hall/Closet				\$59.40	\$56.00				12
	300DNL	Bed/Bath				\$63.00	\$59.50				12
	405DNL	Keyed Lever				\$82.00	\$77.40				12
	405DNL SMT	Keyed Lever				\$88.10	\$83.10				12
	420DNL	Hall/Closet UL					\$66.50				12
	488DNL	Half Dummy				\$29.60	\$28.10				20

Henley	Model	Function	3	4	5	11P	15	26	26D	514	Qty
	200HYL	Hall/Closet					\$61.40			\$64.80	20
	300HYL	Bed/Bath					\$64.80			\$68.30	20
	405HYL SMT	Keyed Lever					\$88.60			\$92.00	20
	488HYL	Half Dummy					\$30.90			\$32.50	20

Ladera RDT	Model	Function	3	4	5	11P	15	26	26D	514	Qty
	200LRL RDT	Hall/Closet					\$56.00	\$56.00	\$51.30	\$59.50	12
	300LRL RDT	Bed/Bath					\$59.50	\$59.50	\$54.70	\$63.00	12
	405LRL RDT	Keyed Lever					\$77.40	\$83.10	\$72.60	\$86.50	12
	405LRL RDT SMT	Keyed Lever					\$83.10	\$83.10	\$78.50	\$86.50	12
	488LRL RDT	Half Dummy					\$28.10	\$28.10	\$25.70	\$29.60	20

Ladera SQT	Model	Function	3	4	5	11P	15	26	26D	514	Qty
	200LRL SQT	Hall/Closet					\$56.00	\$56.00	\$51.30	\$59.50	12
	300LRL SQT	Bed/Bath					\$59.50	\$59.50	\$54.70	\$63.00	12
	405LRL SQT SMT	Keyed Lever					\$83.10	\$83.10	\$78.50	\$86.50	12
	488LRL SQT	Half Dummy					\$28.10	\$28.10	\$25.70	\$29.60	12

Cove™	Model	Function	3	5	11P	15	26	26D	514	Qty
	200CV	Hall/Closet			\$41.50	\$38.00			\$41.50	30
	300CV	Bed/Bath			\$45.10	\$41.70			\$45.10	30
	400CV	Entry			\$52.40	\$48.90				30
	400CV SMT	Entry			\$58.20	\$54.70			\$58.20	30
	488CV	Half Dummy			\$20.70	\$19.00			\$20.70	20

Maven	Model	Function	3	5	11P	15	26	26D	514	Qty
	200MNK	Hall/Closet				\$43.80	\$43.80		\$47.30	30
	300MNK	Bed/Bath				\$47.50	\$47.50		\$50.90	30
	400MNK SMT	Entry				\$60.50	\$60.50		\$63.90	30
	488MNK	Half Dummy				\$24.80	\$24.80		\$26.50	20

NOTE: Can be ordered with (RDT) Round Rose or (SQT) Square Rose option. Example - 200MNK SQT 514

Polo®	Model	Function	3	5	11P	15	26	26D	514	Qty
	200P	Hall/Closet		\$30.50	\$37.50	\$34.00	\$34.00	\$30.50	\$37.50	30
	300P	Bed/Bath		\$34.20	\$41.20	\$37.70	\$37.70	\$34.20	\$41.20	30
	400P	Entry		\$45.10	\$52.10	\$48.60		\$45.10		30
	400P SMT	Entry		\$50.90	\$57.90	\$54.40	\$54.40	\$50.90	\$57.90	30
	450P	Storeroom						\$48.60		30
	450P SMT	Storeroom						\$54.40		30
	488P	Half Dummy		\$15.20	\$18.70	\$17.00	\$17.00	\$15.20	\$18.70	20

Tylo®	Model	Function	3	5	11P	15	26	26D	514	Qty
	200T	Hall/Closet	\$27.80	\$27.80		\$31.30	\$31.30	\$27.80		30
	300T	Bed/Bath	\$31.50	\$31.50		\$34.90	\$34.90	\$31.50		30
	400T	Entry	\$38.70	\$38.70		\$42.10	\$42.10	\$38.70		30
	400T SMT	Entry	\$44.50	\$44.50		\$48.00	\$48.00	\$44.50		30
	488T	Half Dummy	\$13.90	\$13.90		\$15.80	\$15.80	\$13.90		20

660/665	Model	Function	3	5	11P	15	26	26D	514	Qty
	660	Single Cylinder	\$40.60	\$40.60	\$47.90	\$44.20	\$44.20	\$40.60	\$47.90	12
	660 SMT	Single Cylinder SMT	\$46.50	\$46.50	\$53.70	\$50.10	\$50.10	\$46.50	\$53.70	12
	660 SMT	Single Cylinder SMT FD			\$54.90	\$53.10	\$53.10	\$49.60	\$56.50	12
	665	Double Cylinder	\$52.70	\$52.70	\$65.80	\$56.30		\$52.70	\$65.80	12
	665 SMT	Double Cylinder SMT	\$58.50	\$58.50	\$65.80	\$62.30	\$62.30	\$58.50	\$65.80	12

660 RDT	Model	Function	3	5	11P	15	26	26D	514	Qty
	660 RDT SMT	Single Cylinder SMT				\$59.10	\$59.10	\$55.50	\$62.60	12

660/663 SQT	Model	Function	3	5	11P	15	26	26D	514	Qty
	660 SQT SMT	Single Cylinder SMT				\$59.10	\$59.10	\$55.50	\$62.60	12
	660 SQT SMT	Single Cylinder SMT FD				\$62.60	\$62.60	\$59.00	\$66.00	12
	663 SQT	Single Sided				\$32.20	\$32.20	\$30.20	\$34.00	12
	663 SQT	Single Sided UL				\$39.00	\$39.00	\$37.20	\$41.00	12

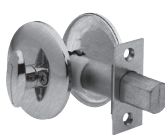
One-Sided	Model	Function	3	5	11P	15	26	26D	514	Qty
	663	Thumbturn One Side				\$24.10	\$24.10	\$22.10	\$26.00	12
	663 UL	Thumbturn One Side UL				\$31.00	\$31.00	\$29.00	\$32.80	12
	664	Retrofit Kit for 663	\$18.30		\$21.10	\$19.90		\$18.30		12
	667	Thumbturn One Side with Exterior Plate			\$53.60	\$49.50		\$49.50	\$53.60	12

Combo Pack	Model	Function	3	5	11P	15	26	26D	514	Qty
	690T	Keyed Entry Tylo Knob with Single Cylinder Deadbolt	\$72.20			\$78.50		\$72.20		6
	690T SMT	Keyed Entry Tylo Knob with Single Cylinder Deadbolt	\$82.80	\$82.80		\$89.10		\$82.80		6
	690P	Keyed Entry Polo Knob with Single Cylinder Deadbolt				\$83.30				6

Gatelatch	Model	Function	3	5	11P	15	26	26D	514	Qty
	599	Double Cylinder						\$140.80		12

KWIKSET HANDLESETS

Door Prep	Deadbolt: Crossbore 2-1/8" or 1-1/2". Edge Bore 1". Handle: Crossbore 2-1/8". Edge Bore 1".
Backset	Deadbolt: Adjustable to 2-3/8" or 2-3/4". Handle: Adjustable to 2-3/8" or 2-3/4".
Door Thickness	1-3/4" doors standard. 2-1/4" doors optional. Not designed for use on 1-3/8" doors.
Cylinder	SmartKey Security or traditional 5-Pin, Pin & Tumbler.
Faceplate	1" x 2-1/4" round corner. Other options available as service parts.
Strikes	Deadbolt: 1" x 2-1/4" round corner. Other options available as service parts Handle: 2-1/4" round corner full lip. Other options available as service parts.
Bolt	Deadbolt: 1" throw. Handle: 1/2" throw.
Door Handing	Reversible for right or left-hand doors.
ANSI/BHMA	Deadbolt is Grade 3 Certified.
ADA	N/A
UL	N/A

KWIKSET LEVERS

Door Prep	Cross Bore 2-1/8". Edge Bore 1".
Backset	Adjustable to 2-3/8" or 2-3/4". UL 2-3/4" standard 2-3/8" optional.
Door Thickness	1-3/8" – 1-3/4" doors standard. 2-1/4" doors optional on 200 and 400 functions only.
Cylinder	SmartKey Security or Pin & Tumbler.
Faceplate	1" x 2-1/4" round corner, square corner and drive-in collar.
Strikes	1" x 2-1/4" round corner. Other options available.
Bolt	1/2" throw.
Door Handing	Specify handing for dummy and interior pack levers.
ANSI/BHMA	Grade 3 Certified. (all functions except 488)
ADA	Functions 200 and 420 in compliance with the American National Standards Institute (ANSI A117.1) and the Americans with Disabilities Act (ADA).
UL	Meets UL 3 hour fire rating for 409, 412, 420 Optional UL 1/3 hour fire rating on select SKUs.

KWIKSET DEADBOLTS

Door Prep	660, 665: Crossbore 2-1/8". Edge Bore 1". 663: Crossbore 1-5/8". Edge Bore 1". 667: Crossbore 2-1/8" or 1-1/2". Edge Bore 1".
Backset	660, 665, 667: Adjustable latch standard. 663: 2-3/8" standard. 2-3/4" optional.
Door Thickness	660, 663, 665, 667: 1-3/8" – 1-3/4" doors standard.
Cylinder	660, 665: SmartKey Security or Pin & Tumbler.
Faceplate	1" x 2-1/4". Specify round corner, square corner or drive-in.
Strikes	1" x 2-1/4". Specify round corner or square corner. Other options available.
Bolt	1" throw.
Door Handing	Reversible for right or left-hand doors.
ANSI/BHMA	Grade 3 Certified.
ADA	Interior turn pieces are in compliance with the American National Standards Institute (ANSI A117.1) and the Americans with Disabilities Act (ADA).
UL	Meets UL 3 hour fire rating for 663 Optional UL 1/3 hour fire rating on select SKUs.

KWIKSET KNOBS

Door Prep	Cross Bore 2-1/8". Edge Bore 1".
Backset	Adjustable to 2-3/8" or 2-3/4". 5" available as service part
Door Thickness	1-3/8" – 1-3/4" doors standard. 2-1/4" doors optional on 200 and 400 models only.
Cylinder	SmartKey Security or Pin & Tumbler.
Faceplate	1" x 2-1/4" round corner, square corner and drive-in collar.
Strikes	1" x 2-1/4" round corner. Other options available.
Bolt	1/2" throw.
Door Handing	Reversible for right or left hand doors.
ANSI/BHMA	Grade 3 Certified. (all functions except 488)
ADA	N/A
UL	N/A

KWIKSET HANDLESET

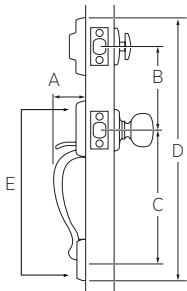

Design	A	B	C	D	E
Amador	2-5/32"	5-1/2"	9-11/16"	17-15/32"	12-14/28"
Bellevue™	2-5/32"	5-1/2"	8-13/32"	18-1/16"	12-1/10"
Dakota™	2-5/32"	5-1/2"	8-13/32"	17-3/16"	12-1/10"
Dakota™	2-5/32"	5-1/2"	8-13/32"	17-3/16"	12-1/10"
Henley	4-5/32"	5-1/2"	8-13/32"	17-5/8"	12-1/4"

KWIKSET KNOB

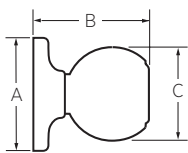

Design	A	B	C
Cove™	2-5/8"	2-1/2"	2-3/16"
Maven	2-5/8"	2-7/16"	2-3/32"
Polo®	2-5/8"	2-23/32"	1-7/8"
Tylo®	2-5/8"	2-1/2"	1-7/8"

KWIKSET LEVER

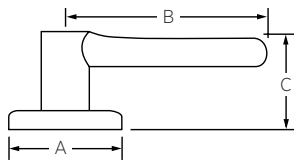

Design	A	B	C	C (Keyed)	Design	A	B	C	C (Keyed)
Balboa™	2-5/8"	4-7/32"	1-15/16"	2-13/32"	Dorian®	2-5/8"	3-3/4"	2-1/8"	2-11/16"
Breton	2-5/8"	4"	2-7/16"	2-15/32"	Henley	2-5/8"	4-3/32"	2-9/16"	2-19/32"
Casey	2-5/8"	4-1/10"	2-3/5"	2-7/16"	Ladera®	2-5/8"	4-3/16"	1-7/8"	2-7/16"
Delta®	2-5/8"	3-5/8"	1-7/8"	2-15/32"					

KWIKSET DEADBOLT

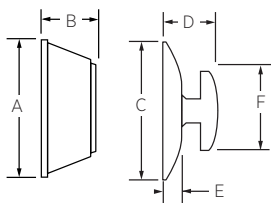

Design	A	B	C	D	E	E
660	2-7/16"	1-1/16"	2-1/2"	2-7/32"	5/16"	1-3/4"
660RDT	2-7/16"	1-1/16"	2-1/2"	3-1/32"	1-3/4"	
660SQT	2-7/16"	1-1/16"	2-1/2"	3-1/32"	1-3/4"	
663		2-1/2"	2-7/32"	5/16"	1-3/4"	
663SQT	2-7/16"	1-1/16"	2-1/2"	3-1/32"	1-3/4"	
665	2-7/16"	1-1/16"	2-1/2"	1-1/16"		
667	2-17/32"	3/8"	2-1/2"	2-7/32"	5/16"	1-3/4"

SMART LOCKS AND KEYLESS ENTRY LOCKS

Kwikset's electronic door locks offer users the convenience of keyless entry, virtually eliminating the need for keys. All of our electronic locks are easy to install and program while complementing any Kwikset knob, lever or handleset.



Features

- Smart Locks Replace any Deadbolt for Keyless Entry Convenience
- SmartCode™ Lever Ideal for - Small/Home Office, Utility/Storage Room, Interior Garage/Side Door
- Lock Your Door with the Touch of a Button
- Customizable Access Codes for Increased Security
- Back-Lit Keypad for Increased Visibility
- Customizable Automatic Door Locking After 30 Seconds for Peace Of Mind
- Installs In Minutes with Just a Screwdriver - No Hard Wiring Required
- Fits Standard Doors (1 3/8" - 2") with No Screw Holes Required

Warranty

- 1 Year Electronic Warranty
- Lifetime Finish & Mechanical Warranty



Halo Select

Model	Function	3	L03	11P	15	26	26D	514	Qty
998000-001	9800 WIFI THRD TSCR 15 SMT TPR RCALFD				\$642.30				1
998000-002	9800 WIFI THRD TSCR 514 SMT TPR RCALFD							\$642.30	1



Halo Select - Contemporary

Model	Function	3	L03	11P	15	26	26D	514	Qty
998000-005	9800 WIFI THRD TSCR 15 SMT TPR RCALFD S2				\$642.30				1
998000-006	9800 WIFI THRD TSCR 514 SMT TPR RCALFD S2							\$642.30	1



Halo Select Plus

Model	Function	3	L03	11P	15	26	26D	514	Qty
998010-001	9801 WIFI THRD TSCR 15 SMT TPR RCALFD				\$660.00				1
998010-002	9801 WIFI THRD TSCR 514 SMT TPR RCALFD							\$660.00	1



Halo Wi-Fi Enabled Smart Locks

Model	Function	3	L03	11P	15	26	26D	514	Qty
99390-001	939 WIFI TSCR 15 SMT TPR RCALFD				\$556.00				1
99390-002	939 WIFI TSCR 11P SMT TPR RCALFD			\$556.00					1
99390-003	939 WIFI TSCR 26 SMT TPR RCALFD					\$556.00			1
99390-004	939 WIFI TSCR 514 SMT TPR RCALFD							\$556.00	1
99380-001	938 WIFI KYPD 15 SMT TPR RCALFD				\$483.10				1
99380-002	938 WIFI KYPD 11P SMT TPR RCALFD			\$483.10					1
99380-003	938 WIFI KYPD 514 SMT TPR RCALFD							\$483.10	1
99590-001	959 TRL FPRT WIFI 15 RCAL RCS				\$571.00				1
99590-002	959 TRL FPRT WIFI 11P RCAL RCS			\$571.00					1
99590-003	959 CNT FPRT WIFI 15 RCAL RCS				\$571.00				1
99590-004	959 CNT FPRT WIFI 514 RCAL RCS							\$571.00	1



Aura Reach

Model	Function	3	L03	11P	15	26	26D	514	Qty
994000-001	9400 BLE THRD TPD 15 SMT TPR RCALFD				\$385.00				1
994000-002	9400 BLE THRD TPD 514 SMT TPR RCALFD							\$385.00	1



Powerbolt® 240 Electronic Deadbolt

Model	Function	3	L03	11P	15	26	26D	514	Qty
992400-001	9240 TRL L03 RBP 4AL RCS		\$110.30						2
992400-002	9240 TRL 15 RBP 4AL RCS				\$110.30				2
992400-003	9240 TRL 11P RBP 4AL RCS			\$110.30					2
992400-012	9240 TRL 514 RBP 4AL RCS							\$110.30	2
992400-004	9240 CNT 15 RBP 4AL RCS				\$110.30				2
992400-005	9240 CNT 514 RBP 4AL RCS							\$110.30	2





Powerbolt® 250 Electronic Deadbolt Transitional

Model	Function	3	L03	11P	15	26	26D	514	Qty
992500-001	9250 TRS L03 SMT RBP 4AL RCS		\$157.50						2
992500-002	9250 TRS 15 SMT RBP 4AL RCS				\$157.50				2
992500-003	9250 TRS 11P SMT RBP 4AL RCS			\$157.50					2
992500-004	9250 TRS 514 SMT RBP 4AL RCS							\$157.50	2



Powerbolt® 250 Electronic Deadbolt Contemporary

Model	Function	3	L03	11P	15	26	26D	514	Qty
992500-005	9250 CNT 15 SMT RBP 4AL RCS				\$157.50				2
992500-006	9250 CNT 514 SMT RBP 4AL RCS							\$157.50	2



SmartCode™ 260 Electronic Deadbolt

Model	Function	3	L03	11P	15	26	26D	514	Qty
992600-001	9260 TRL L03 SMT RBP RCALFD		\$254.90						2
992600-002	9260 TRL 15 SMT RBP RCALFD				\$254.90				2
992600-003	9260 TRL 11P SMT RBP RCALFD			\$254.90					2
992600-004	9260 CNT 15 SMT RBP RCALFD				\$254.90				2
992600-005	9260 CNT 26 SMT RBP RCALFD					\$254.90			2
992600-006	9260 CNT 514 SMT RBP RCALFD							\$254.90	2



SmartCode™ 270 Electronic Deadbolt

Model	Function	3	L03	11P	15	26	26D	514	Qty
992700-002	9270 TRL 15 SMT RBP RCALFD				\$303.20				2
992700-003	9270 TRL 11P SMT RBP RCALFD			\$303.20					2
992700-012	9270 TRL 514 RBP 4AL RCS							\$303.20	2
992700-004	9270 CNT 15 SMT RBP RCALFD				\$303.20				2
992700-005	9270 CNT 514 SMT RBP RCALFD							\$303.20	2



SmartCode™ 917 Electronic Deadbolt

Model	Function	3	L03	11P	15	26	26D	514	Qty
99170-001	917TNL 15 SMT CP RCALFD				\$289.20				2
99170-002	917TNL 11P SMT CP RCALFD			\$289.20					2
99170-003	917HFL 15 SMT CP RCALFD				\$289.20				2
99170-004	917HFL 514 SMT CP RCALFD							\$289.20	2
99170-005	917HFL 26 SMT CP RCALFD					\$289.20			2

 **HOME
CONNECT™**
ELECTRONIC SMART LOCKS

Control your lock from anywhere on your smart phone, tablet, or internet connected device and never worry about forgetting to lock your door again.

- Remotely lock and unlock your door from anywhere
- Receive notifications of your lock's activity
- Control when others have access to your home
- Arm or disarm your security panel
- Wirelessly communicate to other devices in your home



Features

- Full 128-Bit Encryption Security
- Motorized locking mechanism enables true remote locking & unlocking
- SmartKey Security - providing superior security against advanced break-in techniques.
- Easy Integration
- Z-Wave Wireless Protocol
- Fits Standard Doors (1 3/8"-2") with No Screw Holes Required
- 4 AA Alkaline Batteries (no hard wiring) - batteries last for approximately 1 year

Electronic Locks with Home Connect (Z-Wave) Product must be ordered by item number and not description



HomeConnect 620LR

Model	Function	3	L03	11P	15	26	26D	514	Qty
98935-001	HC620 TRL ZW700LR 15 SMT RCALFD RCS BP				\$336.60				1
98935-002	HC620 TRL ZW700LR 11P SMT RCALFD RCS BP			\$336.60					1
98935-003	HC620 TRL ZW700LR L03 SMT RCALFD RCS BP		\$336.60						1
98935-004	HC620 CNT ZW700LR 15 SMT RCALFD RCS BP				\$336.60				1
98935-005	HC620 CNT ZW700LR 11P SMT RCALFD RCS BP			\$336.60					1
98935-006	HC620 CNT ZW700LR 26 SMT RCALFD RCS BP					\$336.60			1
98935-007	HC620 CNT ZW700LR 514 SMT RCALFD RCS BP							\$336.60	1



HomeConnect 918 LR Contemporary

Model	Function	3	L03	11P	15	26	26D	514	Qty
99180-003	918 CNT ZW700 15 SMT BP RCALFD RCS				\$573.70				1
99180-004	918 CNT ZW700 11P SMT BP RCALFD RCS			\$573.70					1
99180-005	918 CNT ZW700 26 SMT BP RCALFD RCS					\$573.70			1
99180-006	918 CNT ZW700 514 SMT BP RCALFD RCS							\$573.70	1



HomeConnect 918 LR Traditional

Model	Function	3	L03	11P	15	26	26D	514	Qty
99180-001	918 TRL ZW700 15 SMT BP RCALFD RCS				\$573.70				1
99180-002	918 TRL ZW700 11P SMT BP RCALFD RCS			\$573.70					1



SmartCode™ 912 with Home Connect

Model	Function	3	L03	11P	15	26	26D	514	Qty
99120-037	912TNL ZW500 15 RCALFD				\$469.00				1
99120-038	912TNL ZW500 11P RCALFD			\$469.00					1



UNITE

Experience convenience, connectivity and seamless access control with the Kwikset UNITE™ EAC Platform. Electronic locks, cloud-based web and mobile software, smart credentials and smart reader controllers work together to deliver a simple yet comprehensive solution for managing your multifamily property.

Kwikset UNITE™ Electronic Locks

Kwikset UNITE™ electronic locks are the smart multifamily property upgrade for your mechanical locks.

Kwikset UNITE™ Electronic Locks provide multifamily property managers and tenants with a convenient, stylish and efficient way to manage resident door access. They come in a standard lock and interconnect variant and can be controlled by mobile, desktop or physical credentials (fob or card). Kwikset's trusted electronic locks and intuitive software platform offer a cohesive, simple and seamless access control experience.



3 Easy Ways to Engage

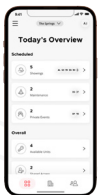

Phone App

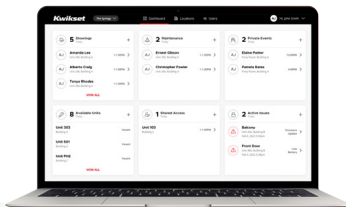

Desktop Portal



Card/FOB

Kwikset UNITE



Item Number	Family	Finish					Case Qty.
Deabolts		15	26	26D	514	Mixed	
1000 FD 4L STRKP KS	Unit Entry Deadbolt	\$580.40	\$580.40	\$580.40	\$580.40	\$580.40	2

*Product must be ordered by item number and not description

Interconnect		15	26	26D	514	Mixed	
1100BRNL FD 4L STRKP KS	Breton	\$863.70	\$863.70	\$863.70	\$863.70	\$863.70	2
1100DL FD 4L STRKP KS	Delta	\$863.70	\$863.70	\$863.70	\$863.70	\$863.70	2
1100HFL FD 4L STRKP KS	Halifax	\$863.70	\$863.70	\$863.70	\$863.70	\$863.70	2
1100HRL FD 4L STRKP KS	Hali	\$863.70	\$863.70	\$863.70	\$863.70	\$863.70	2
1100KNL FD 4L STRKP KS	Kingston	\$863.70	\$863.70	\$863.70	\$863.70	\$863.70	2

*Product must be ordered by item number and not description

Encoder Mount		15	26	26D	514	Mixed	
KS 1000 FD 4L Encoder Mount		\$709.80					1

*Product must be ordered by item number and not description

Physical Credentials	MFG#	List	Case
KS DF EV3 & Prox Access Card*	942100-001	\$12.80	25*
KS DF EV3 & Prox Fob*	941100-001	\$18.80	25*
Construction Master Card	942330-001	\$12.80	1
Construction User Card*	942420-001	\$12.80	25*

*Product must be ordered by item number and not description

Software	MFG# MFG#	List
Kwikset UNITE Software	950000-001	\$10,592.40

*Product must be ordered by item number and not description

Mobile Invitations		List
50 Invitation Bundle	951100-001	\$982.80
250 Invitation Bundle	951200-001	\$4,422.60
500 Invitation Bundle	951300-001	\$7,862.40
1000 Invitation Bundle	951400-001	\$11,793.60

*Must be ordered in multiples of 25

Halo™, Halo™ Touch

Function	Single cylinder deadbolt
Door Prep	2 1/8" diameter bore hole & 1" diameter latch hole
Backset	Adjustable 2 3/8" or 2 3/4"
Door Thickness	1 3/8" - 2" automatic adjustment
Faceplates	1" x 2 1/4" round corner standard
Strikes	Round corner, 4 hole strike, 2 3/4" x 1 1/8"
Latch	Round corner adjustable 2 3/8" x 2 3/4"
Bolt	1" throw, steel deadbolt
Door Handing	Reversible
Cylinder	SmartKey Security™

SMARTCODE™ 912 LEVER

Door Prep	2-1/8" diameter face hole & 1" diameter latch hole
Backset	Adjustable to 2-3/8" or 2-3/4"
Door Thickness	1-3/8" to 2" automatic adjustment
Cylinder	SmartKey Security
Faceplate	1" x 2-1/4". Round corner standard
Strikes	2-1/4" full lip. Round corner
Bolt	1/2" throw
Door Handing	Reversible
Batteries	4 AA Alkaline
Wireless Communication	Z-Wave wireless technology
Operation	908.42 MHz (US)
Range	Typical 100ft line of sight

HomeConnect™ 620 LR

Electrical:	
Input Power	6V (4 x AA alkaline batteries)
Mechanical:	
Door Prep	1 1/2" & 2 1/8" diameter bore hole & 1" deep latch hole
Backset	Adjustable 2 3/8" or 2 3/4"
Door Thickness	1 3/8" - 2" automatic adjustment
Faceplates	1" x 2 1/4" round corner standard
Strikes	Round corner strike 1 1/8" x 2 3/4"
Latch	Round corner adjustable 2 3/8" x 2 3/4"
Bolt	1" throw, steel deadbolt
Door Handing	Reversible
Cylinder	SmartKey® Keyway
Environmental:	
Temperature Range	Exterior: -40°F to 150°F Interior: 32°F to 140°F
Humidity	Exterior: 100% condensing Interior: 30% - 95% non-condensing

SMARTCODE™ 918

Function	Single cylinder deadbolt
Door Prep	2-1/8" or 1-1/2" diameter face hole & 1" diameter latch hole
Backset	Adjustable to 2-3/8" or 2-3/4"
Door Thickness	1-3/8" to 2-1/8" automatic adjustment
Cylinder	SmartKey Security
Faceplates	1" x 2-1/4" round corner standard
Strikes	Round corner, 4 hole strike, 2-3/4" x 1-1/8"
Latch	Round corner adjustable 2-3/8" or 2-3/4"
Bolt	1" throw, steel deadbolt
Door Handing	Reversible
Batteries	4 AA Required
Wireless Communication	Z-Wave wireless technology
Operation	908.42 MHz (US)
Range	Typical 100ft line of sight

AURA™ DEADBOLT

Door Prep	2-1/8" diameter face hole & 1" diameter latch hole
Backset	Adjustable to 2-3/8" or 2-3/4"
Door Thickness	1-3/8" to 2" automatic adjustment
Cylinder	SmartKey Security
Faceplate	1" x 2-1/4". Round corner standard
Strikes	2-3/4" x 1-1/8". Round corner 4 hole strike
Bolt	1" throw
Door Handing	Reversible
Batteries	4 AA Alkaline

POWERBOLT 240/250

Power	6V, 4 x AA alkaline batteries, 12-month battery life (batteries not included)
Door Prep	1-1/2" or 2-1/8" diameter cross bore hole and 1" diameter edge bore hole
Latch Backset	Adjustable 2-3/8" or 2-3/4"
Door Thickness	1-3/8" to 1-3/4" standard. Service part available for 2-1/4" thick doors.
Faceplates	1" x 2-1/4" round corner faceplate with drive-in collar standard
Strike	2-3/4" x 1-1/8" round corner 2-hole strike
Bolt	1" throw, steel bolt
Door Handing	Reversible for right or left-hand doors
Cylinder (240)	KW1 P&T cylinder
Cylinder (250)	SmartKey Security™ KW1 cylinder
UL Rated	N/A
Security	Deadbolt: A156.36 Grade 3 Certified
Temperature Range	Exterior: -40F to 150F, Interior: 32F to 130F
Humidity	Exterior: 100% condensing, Interior: 30% to 95% non-condensing
Warranty	Lifetime Limited Mechanical and Finish Warranty One Year Limited Electronics Warranty

SMARTCODE™ 917

Function	Keyed entry electronic lever
Door Prep	Cross Bore 2- 1/8". Edge Bore 1".
Backset	2 3/8" or 2 3/4"
Door Thickness	1 3/8" - 1 3/4"
Faceplates	1" x 2 1/4" round corner standard, drive in available
Strikes	2 1/4" full lip round corner
Latch	Adjustable 2 3/8" x 2 3/4"
Bolt	1/2" throw, dead latch
Door Handing	Reversible for right or left-handed doors
Cylinder	SmartKey Security™
UL Rating	20 min
Temperature Range	Exterior: -40F to 150F Interior: 32F to 130F
Humidity	Exterior: - 100% condensing Interior: 30% - 95% non-condensing

SMARTCODE™ 260/270

Battery	Uses 4 x AA 6V alkaline cell batteries with approximately 1 year battery life
Function	Single cylinder deadbolt
Door Prep	1 1/2" (38mm) or 2 1/8" (54mm) diameter cross bore hole and 1" diameter edge bore hole
Backset	Adjustable 2 3/8" (60mm) or 2 3/4" (70mm)
Door Thickness	1 3/8" (35mm) to 1 3/4" (44mm) standard. Thick door service part available for 2-1/4" (57mm) thick doors
Faceplates	1" (25 mm) x 2 1/4" (57 mm) round corner faceplate with drive-in collar standard
Strikes	2 3/4" (70mm) x 1 1/8" (29mm) round corner 4 hole strike
Bolt	1" (25mm) throw, steel bolt with anti-saw security pin
Door Handing	Reversible
Cylinder	SmartKey Security™ with 2 KW1 keys
Temperature Range	Exterior: -40°F to 150°F (-40°C to 66°C) Interior: 32°F to 130°F (0°C to 54°C)
Humidity	Exterior: 100% condensing Interior: 30% to 95% non-condensing
Codes	Up to 50 user codes and 10 one-time user codes with optional programming code

Kwikset UNITE™ 1000 Series Deadbolt and Kwikset UNITE™ 1100 Series Interconnect

Mechanical Specifications	
Deadbolt & Interconnect	
Materials	All-metal chassis and escutcheon
Door thickness	1 3/8" to 1 3/4" (thick kits available up to 2 1/4" for DB, up to 2" for IC)
Backsets	Deadbolts and latches (IC) adjustable to fit 2 3/8" or 2 3/4" backsets
Latch Plates	1" x 2 1/4" square & round corner (round standard, square in box)
Deadbolt	Manual Throw Deadbolt 1" (25 mm) tapered throw
Deadbolt Strike Package	Round & Square corner, 1 1/8" x 2 3/4" Round & Square corner, Full lip, 1 5/8" x 2 1/4" (lip length: 1 1/8") Additional options available.
Bore	2 1/8"
Stile Width	Minimum 4 1/2" stile for 2 3/8" backset, minimum 5" stile for 2 3/4" backset
Battery Cover	Snap-to-Secure cover. No tools required.
Thumb-turn	Spring-loaded return to vertical
Interconnect Only	
Interconnect Size	5.5" and 4.0" CTC (center to center)
Anti-microbial	Microban™ on all levers (IC). Excluding 26 & 26D
Lever Strike Package (IC Only)	Square corner, T-strike, box, 1 1/8" x 2 3/4" Full Lip Square Corner, 1 5/8" x 2 1/4" Full Lip 1/4" Round Corner, 1 5/8" x 2 1/4" Additional options available
Handing	Field reversible (1100 IC)

Electronic Specifications	
Users Capacity	Up to 500 users per lock (additional users with software)
Audits Capacity	Up to 1000 events
Visual and Audible Communications	Exterior LED (red, amber, green) and Audible indicators (field configurable)
Wake-up	Responds to host command in <5 seconds
Communication	BLE Bluetooth RFID (built-in reader)
Connectivity options	Mobile (send updates at the lock) No-Tour with enroll reader & smart credential Off-line No touring: Mobile/app shares updates w/ lock
Available status signals	Battery status
Power	4 AA Batteries Easy access 9v Back-up ports, Life Off-line: Up to 2 years, Life BLE Credential enabled: Up to 1 year
OTA Firmware Upgrades	Available
Memory	Non-volatile memory: Retains data w/battery removed
Diagnostics	Diagnostics with software
Operating humidity	0 - 100% non-condensing
Waterproof	Exterior
Operating Temperature	Exterior: -31° to 151°F (-35° to 66°C) Interior: 14° to 122°F (-10° to 50°C)

Certifications	Warranty
1000 DB: ANSI/BHMA A156.36 Grade 2.	Mechanical and Finish: Limited Lifetime
1100 IC: ANSI/BHMA A156.12 Grade 2	Electronics: 2-year limited electronics
ANSI/BHMA A156.25.	
Industry Canada RSS-247.	
ADA compliant - ANSI A117.1	
UL 90 minute, Canada UL 20-minute wood door rated	
Florida Building Code HVHZ	
FCC Certification 15C & CE: RE 2014/53/EU	
AES-256 Bit encryption	

Deadbolt Model #: 1000

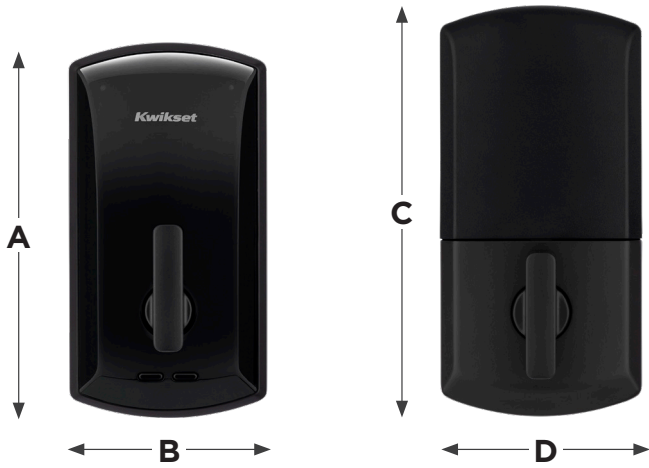

Design	A	B	C	D
Deadbolt	5.346"	2.856"	5.648"	2.849"

Interconnect Model #: 1100

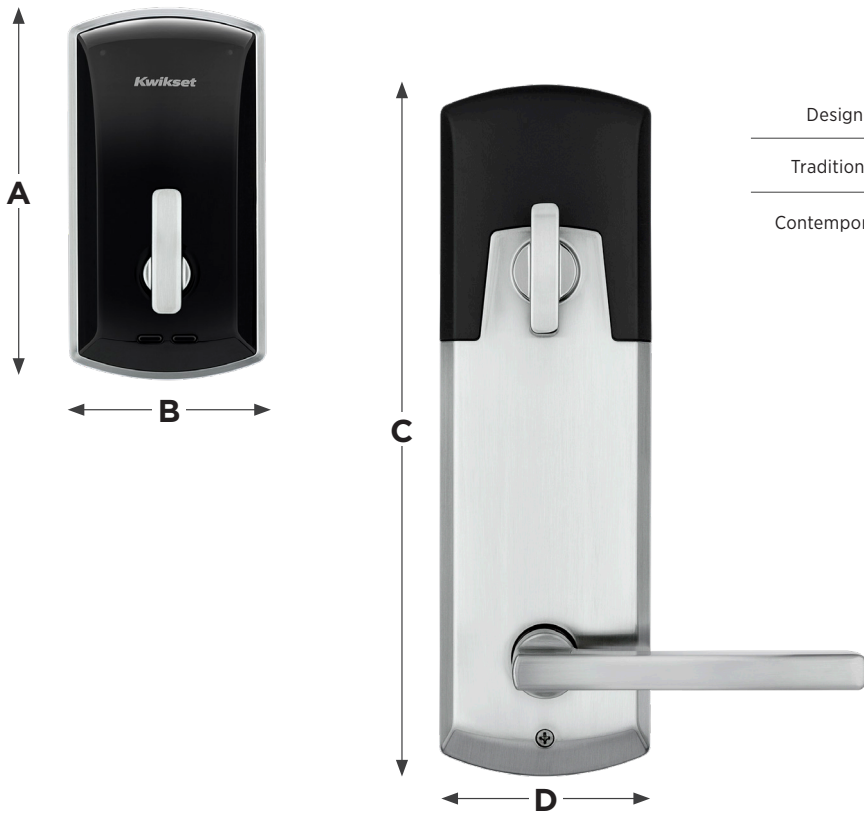

Design	A	B	C	D
Traditional	5 ⁹ / ₃₂ "	2 ¹³ / ₁₆ "	8 ¹ / ₄ "	2 ¹³ / ₁₆ "
Contemporary	5 ⁹ / ₃₂ "	2 ¹³ / ₁₆ "	9 ³ / ₄ "	2 ¹³ / ₁₆ "

AURA

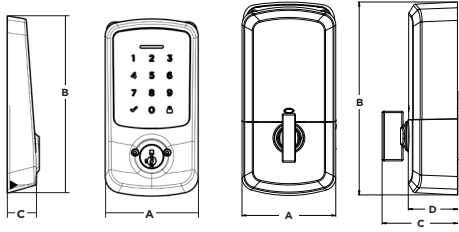

Design	A	B	C	D
Exterior	2 13/16"	5 11/16"	3 1/32"	---
Interior	2 23/32"	5 13/16"	1 29/32"	1 5/32"

HALO TOUCH

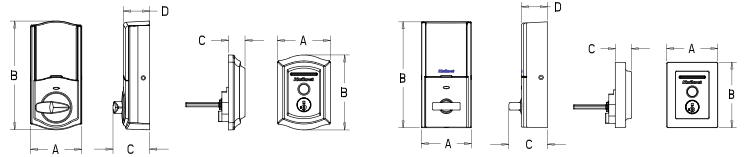

TRL	A	B	C	D	CNT	A	B	C	D
Interior	2 22/32"	5 25/32"	1 15/16"	1 7/16"	Interior	2 22/32"	5 25/32"	2 2/32"	1 13/32"
Exterior	2 13/16"	3 31/32"	7/8"	---	Exterior	2 28/32"	3 9/16"	7/8"	---

HALO TOUCHSCREEN

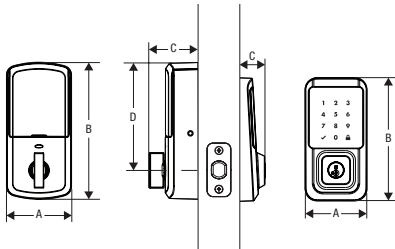

Design	A	B	C	D
Interior	2 3/4"	5 13/16"	2 1/8"	4 9/16"
Exterior	2 28/32"	5 5/8"	1 3/16"	---

HALO KEYPAD

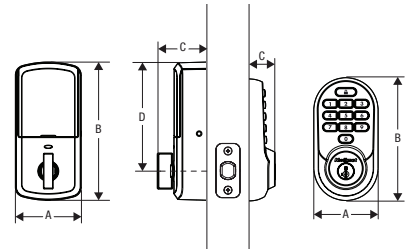

Design	A	B	C	D
Interior	2 3/4"	5 13/16"	2 1/8"	4 9/16"
Exterior	2 28/32"	5 15/32"	1 3/16"	---

HALO SELECT/ HALO SELECT PLUS/ HALO SELECT CNT

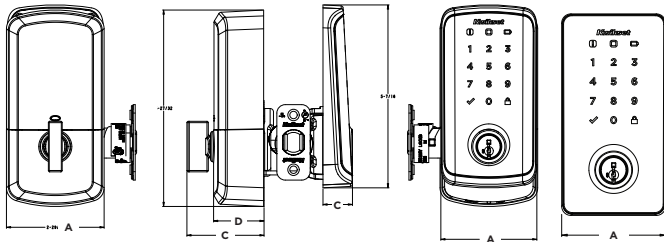

Design	A	B	C	D
Interior	2 29/32"	5 27/32"	2 9/32"	1 1/2"
Exterior TRL	2 27/32"	5 7/16"	7/8"	---
Exterior CNT	2 13/32"	5 7/16"	7/8"	---

SMARTCODE™ 917 TNL

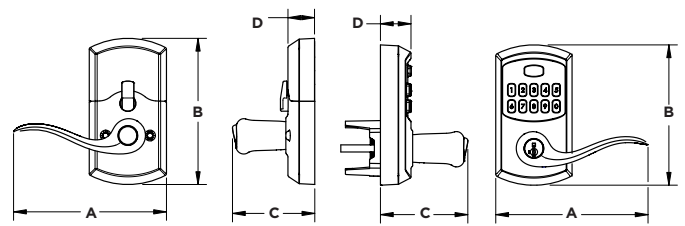

Design	A	B	C	D
Outer Trim	5 9/32"	5 5/32"	3 3/32"	1 1/8"
Inner Trim	5 5/8"	5 3/8"	2 29/32"	3 1/32"

SMARTCODE™ 917 HFL

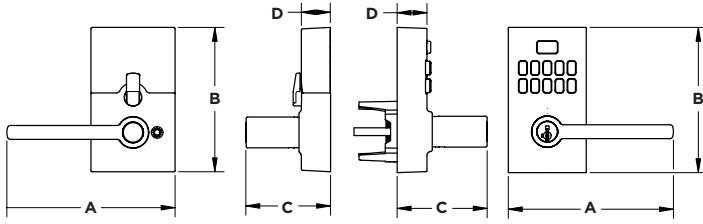

Design	A	B	C	D
Outer Trim	5 9/16"	4 29/32"	3 1/32"	1"
Inner Trim	5 1/32"	4 7/8"	2 27/32"	3/32"

SMARTCODE™ 918

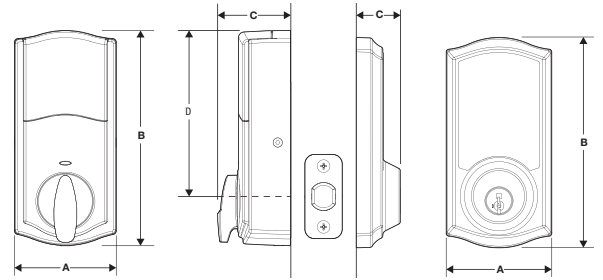

Design	A	B	C	D
Outer Trim	2-13/16"	5-3/8"	1-3/16"	
Inner Trim	2-3/4"	5-3/4"	1-15/16"	4-9/16"

SMARTCODE™ 918 CNT

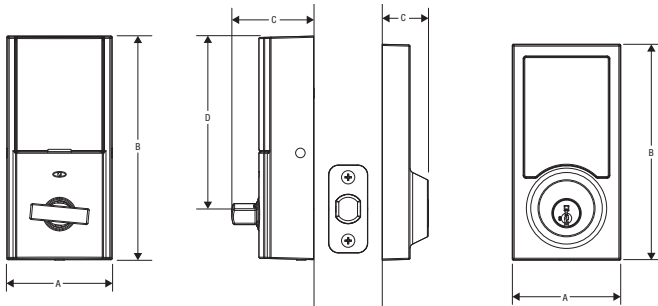

Design	A	B	C	D
Outer Trim	2 11/16"	5 3/4"	2 3/32"	4 9/16"
Inner Trim	2 25/32"	5 7/32"	1 13/16"	---

SMARTCODE™ 912

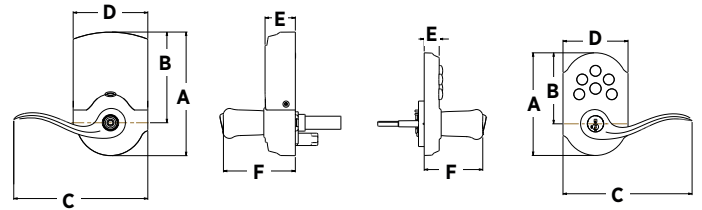

Design	A	B	C	D	E	F
Outer Trim	4 7/16"	3 1/16"	5 19/32"	2 13/16"	2 1/32"	2 17/32"
Inner Trim	5 11/32"	3 15/16"	5 13/16"	3 1/4"	1 5/16"	3 1/8"

SMARTCODE™ 260 TRL

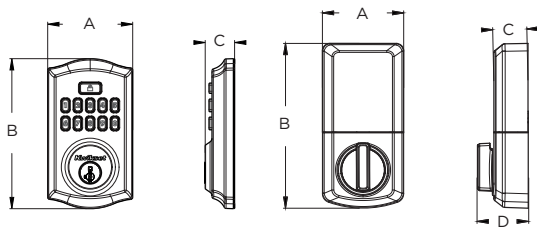

Design	A	B	C	D
Outer Trim	2 13/16"	5"	1"	
Inner Trim	2 3/4"	5 1/2"	1 1/8"	1 1/16"

SMARTCODE™ 260 CNT

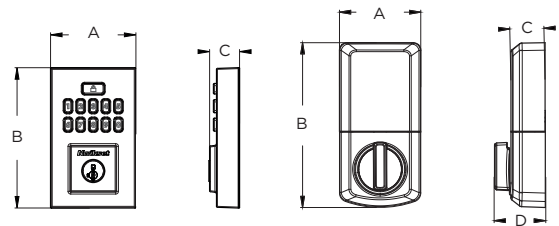

Design	A	B	C	D
Outer Trim	2 3/4"	4 9/16"	1"	
Inner Trim	2 3/4"	5 1/2"	1 1/8"	1 1/4"

SMARTCODE™ 270 TRL

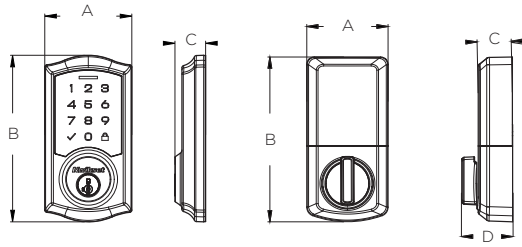

Design	A	B	C	D
Outer Trim	2 3/4"	5 3/16"	1"	
Inner Trim	2 3/4"	5 1/2"	1 1/8"	1 11/16"

SMARTCODE™ 270 CNT

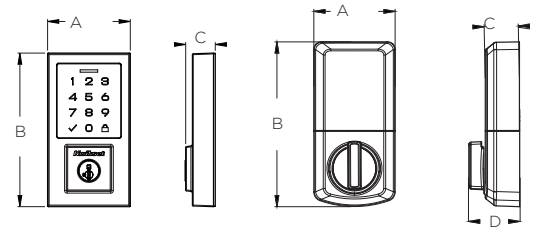

Design	A	B	C	D
Outer Trim	2 3/4"	5 3/16"	1"	
Inner Trim	2 3/4"	5 1/2"	1 1/8"	1 11/16"

POWERBOLT™ 250 TRS

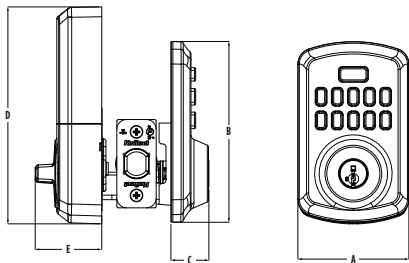

Design	A	B	C	D	E
250 TRS	2 13/16"	4 19/32"	3 1/32"	5 1/2"	1 11/16"

POWERBOLT 240 CNT

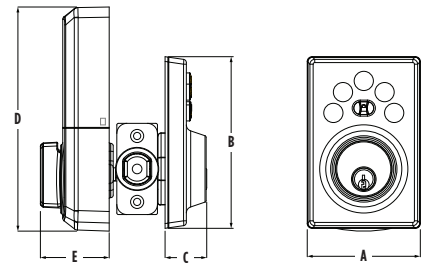

Design	A	B	C	D	E
240 TRL	2 25/32"	4 7/32"	1 1/32"	5 1/2"	1 11/16"

POWERBOLT 240 TRL

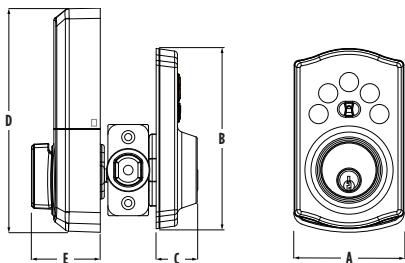

Design	A	B	C	D	E
240 TRL	2 25/32"	4 7/16"	1 1/32"	5 1/2"	1 11/16"

KEY CONTROL™ D E A D B O L T

THE SMART ALTERNATIVE TO MASTER KEYING IN A NEW CONTEMPORARY STYLE

Re-keying & managing a traditional master key system is labor intensive, time consuming & costly. With the first & only two cylinder Key Control Deadbolt, either cylinder can be re-keyed in seconds, without removing the lock from the door.

Key Control

- Two separate cylinders, Tenant & Property Manager, allows for more tenant key cuts than a traditional master key system
- New proprietary keyway adds security - the tenant key will never fit into the Property Manager Cylinder
- The Property Manager Cylinder is concealed when not in use to avoid tenant confusion

Increased Efficiency

- Re-key the lock without removing from the door
- Save time & money by re-keying yourself
- Maintain key control throughout tenant and employee turnover



Perfect for multi-family dwellings, student housing, assisted living & rental properties.





Interconnect Levers - 780 Deadbolt

Model	Function	Style	3	11P	15	26	26D	514	Qty
508 SMT	Passage	Tustin			\$347.90				6
508 SMT	Passage	Kingston			\$347.90		\$341.00	\$353.10	6
508	Passage	Kingston					\$341.00		6



Interconnect with KCDB

Model	Function	Style	3	11P	15	26	26D	514	Qty
508 SMT KCDB	Passage	Kingston			\$357.20			\$362.80	6



Contemporary Interconnect Levers - 780 Deadbolt Options

Model	Function	Style	3	11P	15	26	26D	514	Qty
508 SMT	Passage	Hali RDT CNT			\$372.10	\$372.10		\$377.90	6



Contemporary Interconnect Levers - KCDB

Model	Function	Style	3	11P	15	26	26D	514	Qty
508 SMT KCDB	Passage	Hali SQT CNT			\$381.60	\$381.60		\$386.90	6



Kingston

Model	Function	3	11P	15	26	26D	514	Qty
721KNL UL	Passage UL	\$73.00	\$82.80	\$79.20		\$73.00	\$82.80	12
733KNL UL	Privacy UL	\$77.80	\$87.80	\$84.20		\$77.80	\$87.80	12
756KNL UL	Keyed entry UL			\$115.80		\$109.70		12
756KNL SMT UL	Keyed entry UL	\$109.70	\$119.50	\$115.80		\$109.70	\$119.50	12
781KNL UL	Storeroom UL			\$120.00		\$113.80		12
781KNL SMT UL	Storeroom UL	\$113.80	\$123.70	\$120.00		\$113.80	\$123.70	12
788KNL	Half Dummy	\$36.60	\$40.40	\$39.80		\$36.60	\$40.40	20



Carson

Model	Function	3	11P	15	26	26D	514	Qty
407CNL	Passage UL		\$62.60	\$58.80		\$52.70	\$62.60	12
408CNL	Privacy UL		\$67.50	\$63.90		\$57.80	\$67.50	12
438CNL SMT UL	Entry UL		\$99.30	\$95.60		\$89.30	\$99.30	12
439CNL SMT UL	Storeroom UL		\$103.40	\$99.80		\$93.40	\$103.40	12
488CNL	Half Dummy		\$30.20	\$29.60		\$26.60	\$30.20	20



Casey

Model	Function	3	11P	15	26	26D	514	Qty
407CSL	Passage UL			\$68.80	\$68.80	\$61.90	\$72.30	12
408CSL	Privacy UL			\$72.30	\$72.30	\$65.20	\$75.90	12
438CSL SMT UL	Entry UL			\$96.60	\$96.60	\$90.70	\$100.00	12
439CSL SMT UL	Storeroom UL			\$100.70	\$100.70	\$94.90	\$104.20	12
488CSL	Half Dummy			\$30.90	\$30.90	\$28.60	\$32.50	20

NOTE: Can be ordered with (RDT) Round Rose or (SQT) Square Rose option.



Palmina

Model	Function	3	11P	15	26	26D	514	Qty
407PLL	Passage UL			\$63.40		\$58.50		12
408PLL	Privacy UL			\$66.90		\$62.00		12
438PLL SMT	Entry SMT UL			\$90.90		\$86.30		12
488PLL	Half Dummy			\$30.10		\$27.50		20



Key Control Deadbolt

Model	Function	3	11P	15	26	26D	514	Qty
817 SMT UL	Single Cylinder UL	\$109.50	\$120.20	\$120.20		\$109.50	\$124.20	12
817 SQT UL	Single Cylinder UL			\$120.20			\$124.20	12



SmartCode™ 955 Pembroke Electronic Lever

Model	Function	3	11P	15	26	26D	514	Qty
99550-001	955PML 26D SMT CP					\$308.50		1
99550-002	955PML 15 SMT CP			\$308.50				1
99550-003	955PML 11P SMT CP		\$308.50					1
99550-004	955PML 514 SMT CP						\$308.50	1



SmartCode™ 955 Kingston Electronic Lever

Model	Function	3	11P	15	26	26D	514	Qty
99550-005	955KNL 15 SMT RBP			\$308.50				1
99550-006	955KNL 26D SMT RBP					\$308.50		1
99550-007	955KNL 514 SMT RBP						\$308.50	1



Commercial Electronic Lever - Kingston SMC

Model	Function	3	11P	15	26	26D	514	Qty
99550-011	955KNL 15 SMC RBP			\$320.00				1
99550-012	955KNL 26D SMC RBP					\$320.00		1
99550-013	955KNL 514 SMC RBP						\$320.00	1

INTERCONNECT

Door Prep	Crossbore 2-1/8" Edge Bore 1" 5-1/2 center-to-center only.
Backset	Must specify backset 2-3/8" or 2-3/4".
Door Thickness	1-3/4"
Cylinder	SmartKey Security or Pin & Tumbler.
Faceplates	Available in round corner or square corner
Strikes	Depends on if a round corner or square corner latch is ordered. Round corner latch orders come with the following: 2.74" x 1.115" round corner deadbolt strike, 2.25" x 1.75" 5303 round corner full lip deadbolt strike (grade 3 when used) and 1" x 2-1/4" round corner full lip lever strike. Square corner latch orders come with the following: 2.74" x 1.115" square corner deadbolt strike, 2.25" x 1.75" 5303 square corner full lip deadbolt strike (grade 3 when used), 1" x 2-1/4" square corner full lip lever strike, and square corner T-strike.
Door Handing	508 - reversible.
ANSI/BHMA	Grade 2 Certified
ADA	Lever options are in compliance with the American National Standards Institute (ANSI A117.1) and the Americans with Disabilities Act (ADA).
UL	Meets UL 3 hour fire rating for all functions.

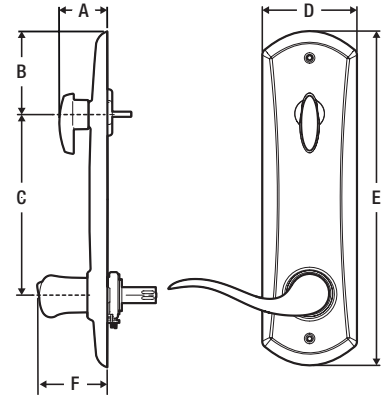

Design	A	B	C	D	E	F
Kingston and Tustin	1 7/16"	2 15/32"	5 1/2"	2 27/32"	10"	2 1/2"

CONTEMPORARY INTERCONNECT

Door Prep	Crossbore 2-1/8" Edge Bore 1"
Backset	Must specify backset 2-3/8" or 2-3/4".
Door Thickness	1-3/4"
Cylinder	SmartKey Security
Faceplates	Available in round corner or square corner
Strikes	Depends on if a round corner or square corner latch is ordered. Round corner latch orders come with the following: 2.74" x 1.115" round corner deadbolt strike, 2.25" x 1.75" 5303 round corner full lip deadbolt strike (grade 3 when used) and 1" x 2-1/4" round corner full lip lever strike. Square corner latch orders come with the following: 2.74" x 1.115" square corner deadbolt strike, 2.25" x 1.75" 5303 square corner full lip deadbolt strike (grade 3 when used), 1" x 2-1/4" square corner full lip lever strike, and square corner T-strike.
Door Handing	508 - reversible.
ANSI/BHMA	Grade 2 Certified
ADA	Lever options are in compliance with the American National Standards Institute (ANSI A117.1) and the Americans with Disabilities Act (ADA).
UL	Meets 3 hour fire rating.

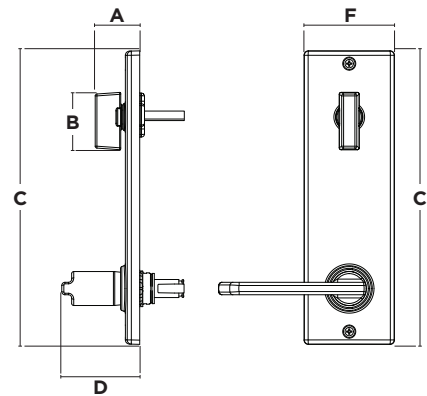

Design	A	B	C	D	F
Hali	1 13/32"	1 25/32"	9 3/16"	2 7/16"	2 27/32"

KEY CONTROL

Standard Door Prep	Cross Bore 2-1/8". Edge Bore 1" Latch Face 1" x 2-1/4"
Door Thickness	1-3/4"
Cylinder	2 SmartKey Security™ cylinders: 1 standard Kwikset for users, 1 unique patented keyway for 1-Key Control
Faceplate	1" x 2-1/4" round corner
Strike	1-1/8" x 2-3/4" round corner and 2-1/4" x 1-3/4" round corner full lip strike (grade 3 when used) Other strikes are available as service parts.
Bolt	1" throw
ANSI/BHMA	A156.5 Grade 2
ADA	Interior turn piece meets 4.13.9 ADA
UL	Meets UL 3 hour fire rating for UL function. UL Ref# R10923

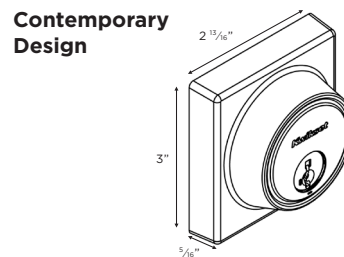
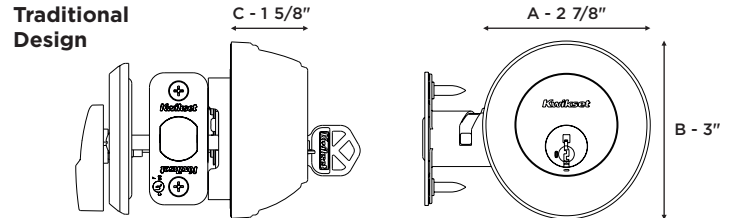
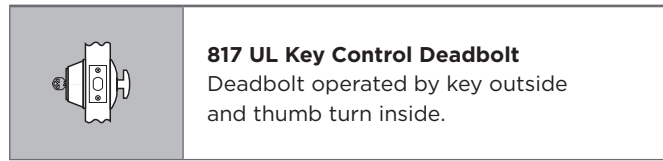

SMARTCODE 955

Function	Keyed entry electronic lever
Door Prep	2 1/8" diameter face hole & 1" diameter latch hole
Backset	Adjustable 2 3/8" or 2 3/4"
Door Thickness	1 3/8" - 1 3/4"
Faceplates	1" x 2 1/4" round corner standard
Strikes	Round corner, 4 hole strike, 2 3/4" x 1 1/8"
Latch	Round corner adjustable 2 3/8" x 2 3/4"
Bolt	1/2" throw, dead latch
Door Handing	Reversible
Cylinder	SmartKey Security™

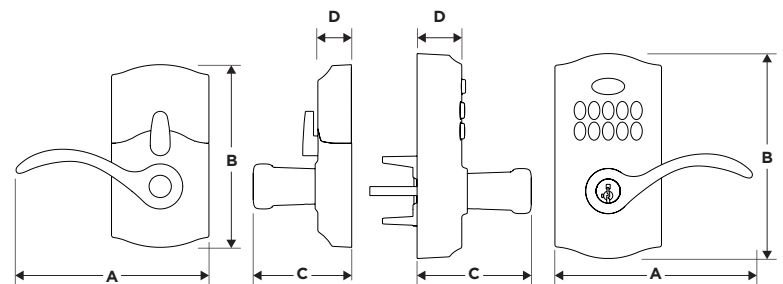

Design	A	B	C	D
Interior	5 5/8" (142.9)	5 5/16" (134.9 mm)	2 7/8" (73 mm)	31/32" (24.6 mm)
Exterior	5 3/4" (146 mm)	5 3/32" (151.6 mm)	3 5/16" (84.1 mm)	1 13/32" (35.7 mm)

KINGSTON LEVER

ANSI/BHMA	Grade 2 Certified
Door Prep	Crossbore 2-1/8" Edge Bore 1"
Backset	Adjustable to 2-3/8" or 2-3/4".
Door Thickness	1-3/8" - 1-3/4" doors standard
Cylinder	SmartKey Security or Pin & Tumbler.
Latch	Adjustable to 2-3/8" or 2-3/4" round corner.
Strikes	1" x 2-1/4" round corner
Bolt	1/2" throw.
Door Handing	Reversible for right or left-hand doors.
ADA	Lever options are in compliance with the American National Standards Institute (ANSI A117.1) and the Americans with Disabilities Act (ADA).
UL	Meets UL 3 hour fire rating for all functions
Warranty	Lifetime Mechanical, 5 Year Finish
Interior Locking	Push button

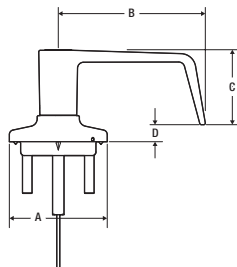

Design	A	B	C	D
Kingston	2.56"	3.84"	1.96"	.44"

CARSON LEVER

ANSI/BHMA	Grade 3 Certified
Door Prep	Crossbore 2-1/8" Edge Bore 1"
Backset	Adjustable to 2-3/8" or 2-3/4".
Door Thickness	1-3/8" - 1-3/4" doors standard
Cylinder	SmartKey Security or Pin & Tumbler.
Latch	Adjustable to 2-3/8" or 2-3/4" round corner.
Strikes	1" x 2-1/4" round corner
Bolt	1/2" throw.
Door Handing	Reversible for right or left-hand doors.
ADA	Lever options are in compliance with the American National Standards Institute (ANSI A117.1) and the Americans with Disabilities Act (ADA).
UL	Meets UL 3 hour fire rating for all functions
Warranty	Lifetime Mechanical, 5 Year Finish
Interior Locking	Push button

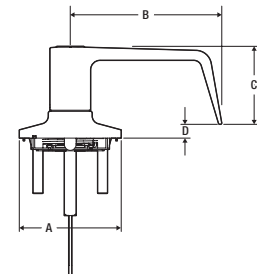

Design	A	B	C	D
Carson	2.56"	3.80"	1.96"	.35"

CASEY PUSH BUTTON LEVER

Door Prep	Cross Bore 2 1/8". Edge Bore 1" Latch Face 1 x 2 1/4"
Backset	Adjustable 2 3/8" or 2 3/4"
Door Thickness	1 3/8" - 1 3/4" Doors standard.
Cylinder	SmartKey Security™
Faceplates	1" x 2 1/4" includes round corner
Strikes	2 1/4" full lip UL. Includes round corner. Other options available.
Bolt	1/2" throw
Door Handing	Reversible for right or left-handed doors.
ANSI/BHMA	A156.2 Grade 3 (all functions except 488).
UL	3 Hr UL certification for passage, privacy, entry & storeroom functions
ADA	Lever options are in compliance with the American National Standards Institute (ANSI A117.1) and the Americans with Disabilities Act (ADA).
Warranty	Lifetime Mechanical and Lifetime Finish

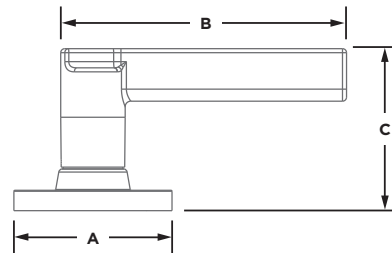

Design	A	B	C	C (Keyed)
Casey Round Rose	2 9/16"	4 3/32"	2 5/8"	2 5/16"
Casey Square Rose	2 9/16"	4 3/32"	2 5/8"	2 5/16"

Round Pocket Door Lock

	Model	Function										Case
			3	L03	5	11P	15	26	26D	32	514	Qty
	334	Passage				\$57.50	\$57.50		\$57.50		\$57.50	12
	335	Privacy				\$62.80	\$62.80		\$62.80		\$62.80	12



Contemporary Pocket Door Lock

	Model	Function										Case
			3	L03	5	11P	15	26	26D	32	514	Qty
	334SQT	Passage				\$57.50	\$57.50	\$57.50	\$57.50		\$57.50	12
	335SQT	Privacy				\$62.80	\$62.80	\$62.80	\$62.80		\$62.80	12



April 2026

Kwikset



@KwiksetLocks



@Kwikset



@Kwikset



@KwiksetCorp



@Kwikset

www.kwikset.com

19701 DaVinci • Lake Forest, CA • 92610 • 1-800-327-LOCK (5625)

Copyright © 2026 ASSA ABLOY Americas Residential Inc. • KW-2566723_02/26