

## A: GENERAL INFORMATION

Terms and Conditions	A:1
General Information	A:3
Weights and Measurements	A:12
Order Forms	A:15

## B: NEW PRODUCTS

Microban	B:1
Halo	B:2
Ladera	B:4
Aura	B:6
Vancouver	B:8
SmartCode 955 Lever	B:10
660 SQT	B:12
Pocket Door Locks	B:14
917 SmartCode	B:16

## C: KWIKSET SIGNATURE SERIES

Handlesets	C:3
Levers	C:9
Knobs	C:12
Deadbolts	C:14
Specifications	C:15

## D: KWIKSET

Handlesets	D:2
Levers	D:3
Knobs	D:5
Deadbolts	D:6
Combo Packs	D:6
Specifications	D:7

## E: ELECTRONIC LOCKS

Halo	E:1
Kevo	E:2
Smartcode	E:4
Home Connect	E:5
Specifications	E:6

## F: LIGHT COMMERCIAL

Residential/Light Commercial	F:1
Specifications	F:2
Key Control Deadbolt	F:3
Specifications	F:4

## G: ACCESSORIES

Bath Hardware	G:1
Pocket Door Locks	G:2
SmartKey Padlocks	G:2
Trim	G:2

## H: SERVICE PARTS

Keys	H:1
Pin & Tumbler	H:2
SmartKey	H:6
Key Control	H:7
Latches	H:8
Strikes	H:11
Screw Packs	H:14
Miscellaneous	H:18
Electronics	H:20

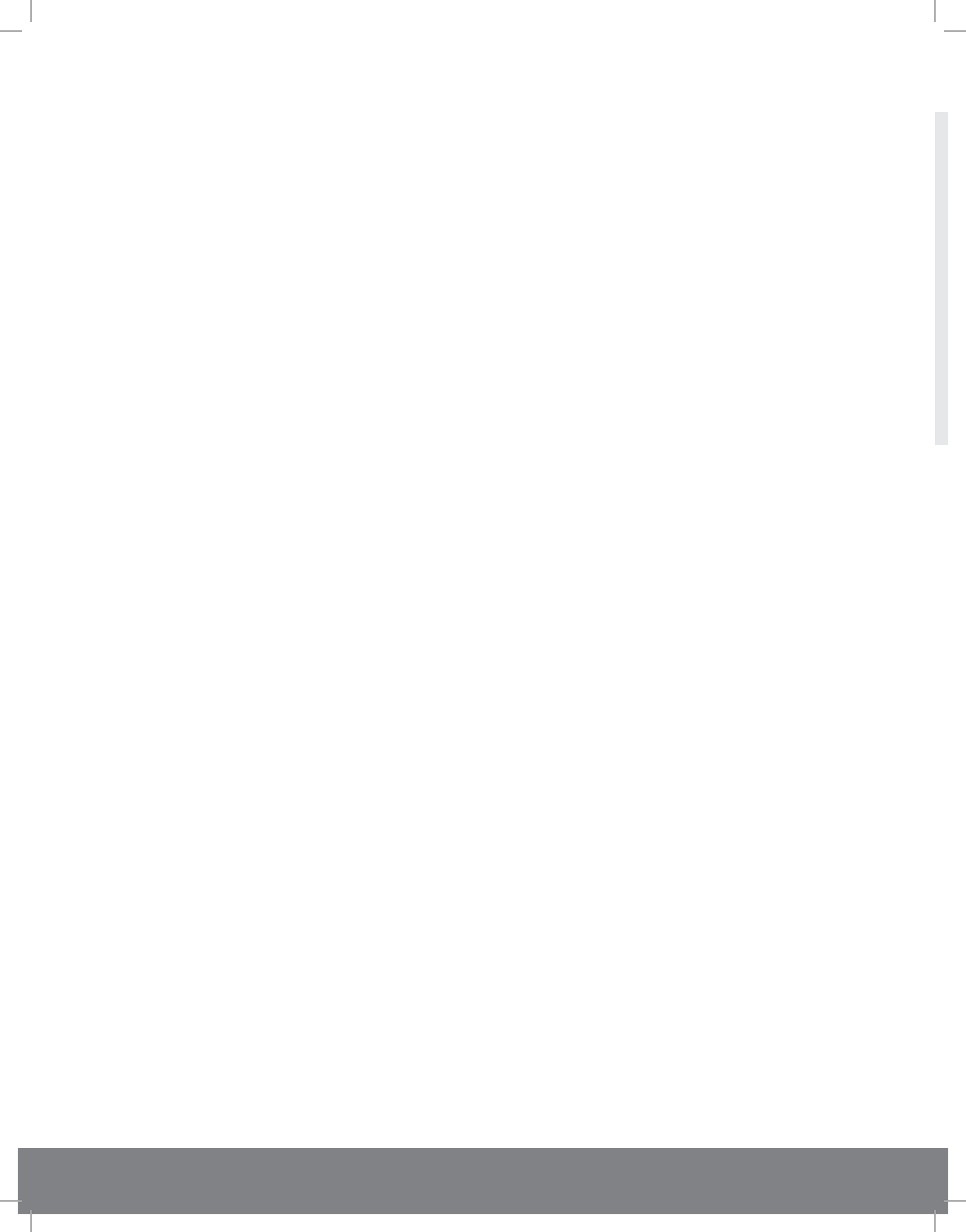

## TERMS AND CONDITIONS OF SALE

Standard terms are 2% prompt payment discount for payment within 25 days from date of invoice; net 30 days from the date of invoice. Kwikset® reserves the right to charge and recover on invoices which are not paid within the above terms, a service charge of 1-1/2% a month for each month or fraction thereof during which the invoice remains unpaid, said service charge, however, not to exceed the highest applicable legal rate of interest. All orders, whether solicited or written by our sales representatives or forwarded by our customers are deemed to be mere offers to purchase in accordance with these Terms and Conditions of Sale until actually accepted by us at our home office in Lake Forest, CA. We reserve the right to refuse any order as well as the right to sell or not sell to any firm at our sole discretion. The acceptance of an order is expressly made conditional upon your assent to these Terms and Conditions of Sale. We object to the inclusion of any different or additional terms or conditions, even if the same are included in your order, a contract of sale will result upon the Terms and Conditions of Sale stated herein only. Prices reflected in this book apply to Wholesale customers only.

All sales are final.

## PRICES

Pricing based on full-case quantities only; orders for less than full case will be automatically adjusted up to the next full-case quantity. All prices are subject to change without notice and are not guaranteed. All taxes, duties or other charges are the responsibility of the customer.

## CLAIMS

Price claims must be submitted in writing to Kwikset, 19701 Da Vinci, Lake Forest, CA 92610 within 30 days from the date of invoice.

## CHANGES OR CANCELLATIONS

Beyond 5 working days of our acknowledgement date no changes can be made. Additions to an order will be handled as a separate order and must meet applicable minimum order requirements. Order cancellation on regular stock items only, or any portion thereof is allowed only upon prior written consent from Kwikset, and the payment of cancellation charges deemed appropriate.

## MINIMUM CHARGE

No order will be invoiced for less than \$100.00 net plus shipping charges except for lock accessory parts.

## MINIMUM ANNUAL SALES VOLUME

The company reserves the right to discontinue direct sales to any customer who does not meet the minimum annual sales volume requirement. The current annual requirement is \$50,000.00. Your annual purchases are determined by accepted, non-cancelled, and shipped orders received during each calendar year. Kwikset reserves the right to change any or all minimum annual sales volume requirements at any time. Any customer who does not meet the annual sales volume requirements may continue to purchase Kwikset products through a Kwikset distributor.

## RETURNS

Defective merchandise returned to our factories requires prior written authorization from a Kwikset Sales Rep or the Sales Office. A factory return authorization must accompany the returned shipment. The return authorization must include an itemized listing of the merchandise and an explanation stating the reason for return.

There will be a 20% product restocking fee on all returned merchandise.

## FREIGHT

All goods are invoiced FOB to our factory. Upon delivery of shipments to the carrier, title to, and the risk of loss or damage in transit for such shipments, passes to our customer. Kwikset's standard policy is to pay freight charges on all orders over \$1,000.00 net invoice value to a single destination in the continental U.S., by carrier and route of our choice. Shipments less than these quantities will not be shipped on a prepaid basis. If higher freight charges are incurred from customers specifying a carrier or route of their choice the additional cost will be added to that customer's invoice.

## DELIVERY CONDITIONS

Shipping schedules are our best estimates, and cannot be guaranteed. Kwikset is not responsible for any direct or consequential loss or damage resulting from an inability or delay in meeting shipping schedules.

## KWIKSET LIMITED WARRANTIES

Kwikset products are backed by one of the most comprehensive warranty programs available. You can feel confident that with the purchase of Kwikset you have selected the best quality product, backed by the best customer service available.

## MECHANICAL LIMITED WARRANTY

Except as otherwise provided below, Spectrum Brands, Inc., for its Kwikset® brand products ("Kwikset"), warrants to the original residential purchaser (the "Purchaser") that each Kwikset product (the "Product(s)" or "Kwikset Product(s)") will be free from mechanical defects under normal use from the date of purchase for as long as said Purchaser occupies the residential premises upon which the Product was originally installed ("Warranty Period"). This Mechanical Limited Warranty applies only to Products that were purchased from Kwikset or a Kwikset authorized seller, unless otherwise prohibited by law. Kwikset Products are legitimately sold only by authorized sellers who are required to follow Kwikset's policies, procedures, and quality control standards. Kwikset reserves the right to reject warranty claims from purchasers for Products purchased from unauthorized sellers, including unauthorized Internet sites.

## FINISH LIMITED WARRANTY

The finish on Kwikset Products is protected by a durable topcoat designed to maintain the beauty and quality of the Kwikset Product. Kwikset warrants to the Purchaser that the finish of the Product shall be free of defects in material and workmanship from tarnishing, flaking, and discoloring from the date of purchase for as long as said Purchaser occupies the residential premises upon which the Product was originally installed ("Warranty Period"). This Finish Limited Warranty applies only to Products that were purchased from Kwikset or a Kwikset authorized seller, unless otherwise prohibited by law. Kwikset Products are legitimately sold only by authorized sellers who are required to follow Kwikset's policies, procedures, and quality control standards. Kwikset reserves the right to reject warranty claims from purchasers for Products purchased from unauthorized sellers, including unauthorized Internet sites.

## ELECTRONIC LIMITED WARRANTY

Kwikset warrants to the Purchaser that Kwikset Products will be free from electronic defects under normal use for one (1) year from the date of purchase, as long as said Purchaser occupies the residential premises upon which the Product was originally installed ("Warranty Period"). This Electronic Limited Warranty applies only to Products that were purchased from Kwikset or a Kwikset authorized seller, unless otherwise prohibited by law. Kwikset Products are legitimately sold only by authorized sellers who are required to follow Kwikset's policies, procedures, and quality control standards. Kwikset reserves the right to reject warranty claims from purchasers for Products purchased from unauthorized sellers, including unauthorized Internet sites.

## EXCLUSIONS FROM WARRANTY

1. Any Kwikset Product produced prior to January 1, 2006.<sup>1</sup>
2. Any Kwikset Product which has been damaged as a result of installation contrary to any of Kwikset's written installation instructions is not covered by these warranties.
3. Any Kwikset Product which has been modified by any non-Kwikset component is not covered by these warranties.
4. Any Kwikset Product having a defect caused by neglect, misuse, abuse or unreasonable or extraordinary use or maintenance, including use in a commercial application, is not covered by these warranties.
5. Any Kwikset Product having a defect due to use of paints, solvents, or other chemicals is not covered by these warranties.
6. Any Kwikset Product that is used in combination with knobs, levers, or trim of other than those manufactured by Kwikset and designated for use with the applicable locks or latches is not covered by these warranties.
7. Any Kwikset Product that was purchased from an unauthorized seller is not covered by these warranties.

These warranties are not transferable. Therefore, no transferee is covered by these warranties.

<sup>1</sup> Kwikset Products produced prior to January 1, 2006, may be eligible for warranty in accordance with the terms and conditions of the applicable warranty program.

## WARRANTY CLAIMS

If you wish to make a warranty claim based upon a Product defect, please call us at 1-800-327-LOCK (5625) or contact us at [kwikset.com/support](http://kwikset.com/support).

Please note that you will be required to provide a description of any claimed defect(s) and a dated receipt or other proof of purchase from Kwikset or the Kwikset authorized seller, to verify warranty eligibility.

Certain claimed defect(s) covered by these warranties may be resolved by Kwikset providing you with troubleshooting steps.

Other claimed defect(s) covered by these warranties may require Product replacement. Products may not be returned to Kwikset without prior authorization from Kwikset. If authorized by Kwikset, you will need to mail your Product to:

Spectrum Brands, Inc.  
ATTN: Kwikset Consumer Services  
19701 Da Vinci

Lake Forest, CA 92610

A prepaid shipping label will be provided to you.

## REMEDIES

For certain claimed defect(s) covered by these warranties, as determined by Kwikset, Kwikset will provide you with troubleshooting steps.

For other claimed defect(s) covered by these warranties, as determined by Kwikset, Kwikset will replace the defective Product or part.

If a Kwikset Product, which is the same as the Kwikset Product or any part covered by these warranties, has been discontinued at the time of replacement or if Kwikset determines, in its sole discretion, that such replacement is inappropriate, Kwikset reserves the right to substitute an alternative product. Kwikset also reserves the right to accept or reject an alternative product proposed as a replacement, when the value is higher than that of the Product originally purchased by the Purchaser. Except as expressly provided in these warranties to the contrary, KWIKSET SHALL NOT BE OBLIGATED OR LIABLE FOR LABOR OR OTHER COSTS RELATED TO INSTALLATION, REPAIR OR REPLACEMENT OF A KWIKSET PRODUCT, OR FOR LOSS OF, OR DAMAGE TO ANY MATERIAL WHICH IS NOT SOLD BY KWIKSET.

## PATENT INDEMNITY

We agree to defend any suit or proceeding brought against our customer so far as based on claim that our products, or any part thereof, made solely to our specifications and furnished to our customer constitute an infringement of any U.S. patent, if notified promptly in writing and given authority, information and assistance at our expense for the defense of same, and we shall pay all damages and costs awarded therein against our customer. In case our products, or any part thereof, is in such suit held to constitute infringement and their use is enjoined, we will, at our expense and discretion, either procure for our customer the right to continue using the products or replace same with non-infringing products, or modify them so they become non-infringing, or remove such products and refund the purchase price (less depreciation, prorated from the purchase date). The foregoing states our entire liability for patent infringement by our products or any part thereof.

## INTELLECTUAL PROPERTY

No person or entity may sell, distribute, advertise, market or promote Kwikset branded products distributed by Kwikset Corporation ("Kwikset"), Spectrum Brands Hardware Home Improvement Division, without prior authorization from Kwikset. Customers of Kwikset who are authorized to sell Kwikset branded products are referred to herein as "Customers."

The Kwikset brand and all Kwikset trademarks, trade names, product depictions, colors, graphics or logos, whether or not registered or otherwise protected (the "Marks"), remain the sole and exclusive property of Kwikset and nothing arising out of the relationship between Kwikset and any Customer conveys to Customer any ownership rights in the Marks. Customer may use the Marks and then only in the sale or promotion of authentic Kwikset products in compliance with the terms of this policy. The Marks must be used exactly in the form provided and in conformity with all Kwikset trademark usage policies or guidelines, including, but not limited to, those relating to shape, color match and imprint quality. Any proposed deviation must be approved in writing by Kwikset prior to use. The Marks may not be used in or as part

of any Customer domain name on the Internet. Prior to any use of the Marks on goods or services, Customer must submit samples for Kwikset's approval.

Additionally, no Customer may use product depictions, graphics, logos or text relating to Kwikset products that have not been provided by Kwikset in connection with the advertising, promotion or sale of Kwikset products without Kwikset's prior review and written approval of each such use. The Marks may not be used in or as part of any reseller or other third party (i) domain name or VRL on the Internet, (ii) trademark or service mark, or (iii) company or trade name. Any action on the part of a Customer that violates the terms of this policy or otherwise impairs the value of or goodwill associated with the Marks or is otherwise not in conformity with Kwikset's standards may result in the suspension or termination of the Customer's authorization or any other remedy permitted by law.

Kwikset grants to each of its Customers limited, non-transferable, non-sublicenseable licenses of the patents relating to the Kwikset products that the Customer is authorized to sell and of the copyrights in any packaging or other written materials included therewith or related thereto. Said patent and copyright licenses are solely to sell such Kwikset products covered by such patents and to which such copyrights relate only to end-users and other Customers in compliance with the terms of this document. The sale of such patented Kwikset products and the sale or use of such copyrighted materials by a Customer that violate the terms of this document exceed the scope of the licenses herein granted to the Customer and may constitute patent and/or copyright infringement.

## STANDARDS

Kwikset meets or exceeds the testing requirements specified for each product grade or rating.

- American National Standards Institute (ANSI)
- Builders Hardware Manufacturers Association (BHMA)
- Underwriters Laboratories, Inc. (UL)
- Americans with Disabilities Act (ADA)

## MISCELLANEOUS

Substitution of non-Kwikset components/parts, and any alteration or modification of factory parts, and other lock manufacturer's parts may result in door hardware which does not function properly or will fail and will void all warranties. Orders not specified with keying requirements will be shipped Keyed Differently (KD). Orders with keying requirements of K10 or more must have a "Letter of Release" on file with Kwikset stating that Kwikset Corporation will not be held liable for cost and expense arising from any loss or damage to property utilizing Kwikset products where 10 or more locks have been keyed alike. Contact your Sales Office account representative for a copy of the release form. Kwikset reserves the right to revise or modify products, product information, or pricing without notice. Product specifications and pricing reflect available information at the time of printing. Kwikset is not responsible for typographic or printing errors.

## LIMITATION OF LIABILITIES

**THERE ARE NO WARRANTIES WHICH EXTEND BEYOND THOSE STATED HEREIN. ANY IMPLIED WARRANTIES THAT MAY BE APPLICABLE TO PRODUCTS, INCLUDING IMPLIED WARRANTIES OF MERCHANTABILITY OR FITNESS FOR A PARTICULAR PURPOSE, ARE LIMITED IN DURATION TO THE DURATION OF THIS WARRANTY. SOME STATES DO NOT ALLOW LIMITATIONS ON HOW LONG AN IMPLIED WARRANTY LASTS, SO THE ABOVE LIMITATION MAY NOT APPLY TO YOU. UNDER NO CIRCUMSTANCES SHALL KWIKSET BE LIABLE FOR ANY SPECIAL, INCIDENTAL, OR CONSEQUENTIAL DAMAGES BASED UPON BREACH OF THIS LIMITED WARRANTY, BREACH OF CONTRACT, OR STRICT LIABILITY. SOME STATES DO NOT ALLOW THE EXCLUSION OR LIMITATION OF INCIDENTAL OR CONSEQUENTIAL DAMAGES, SO THE ABOVE LIMITATION OR EXCLUSION MAY NOT APPLY TO YOU. THIS WARRANTY GIVES YOU SPECIFIC LEGAL RIGHTS, AND YOU MAY ALSO HAVE OTHER RIGHTS WHICH VARY FROM STATE TO STATE.**

Effective Date: [July 6th 2020]



**ORDER CODE BREAKOUT**

Quantity	Specifies Quantity
Function & Style	Specifies Model and Function
Rose Design	Specifies Designer Rose
Handing	Handing Right or Left
Finish	Exterior/Interior
Keying	Special Keying
Code	Keying Code
Latch	Specifies Latch
Strike	Indicates Strike
Key Alike Qty	Keyed Alike

**Example:** "I would like to order 12 SmartKey Commonwealth levers, satin nickel finish, round corner latch & strike, 3 keyed alike" Written as:  
12-740CHL 15 SMT RCAL RCS K3.

NOTE: All handlesets ordered LIP only.

**UNDERWRITERS LABORATORIES LISTED LOCKSETS**

 To meet Underwriters Laboratories' fire rating requirements UL listed locksets, UL listed latches, and UL listed strikes must be used together.

**AMERICAN WITH DISABILITIES ACT (ADA)**

 Products displaying this symbol comply with the Americans with Disabilities Act of 1990.

**HOW TO ORDER 20MIN UL LOCKS**

FD = 20 minute UL designation

**Example:** "I would like to order 12 passage Tustin levers with round corner latch and strike with 20 minute UL in Satin Nickel"  
12-720TNL 15 RCALFD RCS.

NOTE: The latch configuration is not available with FD. There is a \$2.50 list price upcharge for 20 minute UL.

**KEYING**

Code	Option
KD	Keyed Differently
K2, K3	Keyed Alike (2 Locksets, 3 Locksets)
MK	Master Keyed
PK	Builder (Protecto) Keyed
GMK	Grand Master Keyed
PMK	Builder (Protecto) Master Keyed
MAIS	Maison Keying
SEQ	Sequential Construction Keying
KBOX	Keys in One Box
SMT	SmartKey Security

NOTE: Speciality Keying list prices can be found on page H:2

**BACKSET**

Backset is the distance from center edge of door to center of the 2-1/8" (54mm) diameter hole, 2-3/8" or 2-3/4" in most cases.

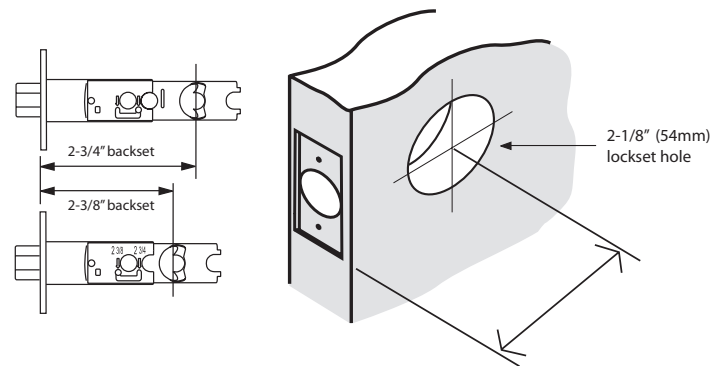



Model	Function
154/200/407/420/720/721/725	Passage/Hall/Closet
155/300/408/430/730/733/735	Privacy/Bed/Bath
334/335	Round Pocket Door Lock
400/401/438/740/741/756	Entry
156/405/406/409/413	Lever Keyed Entry
450/462/412/439/755/781	Storeroom/Vestibule
157/488/788	Half Dummy Trim, Surface Mounted
502/505/506/507/508	Interconnect
553/687/800/818	Single Cylinder Handleset
689/801	Double Cylinder Handleset
699/802/819	Dummy Handleset
898/814	Handle Only
899/815	Handle and Lever Only
598	Single Cylinder Gatelatch
599	Double Cylinder Gatelatch
604/605/606	Interior Pack for Kwikset Handlesets
158/258/660/780/782/980/982/816/817	Single Cylinder Deadbolts
159/665/784/785/984/985	Double Cylinder Deadbolts
905	Keyless Touchpad Deadbolt
910/912/914/916/954/888	Home Connect Deadbolt and Lever
907/909/911/913/915/919/917/955	Electronic Single Cylinder Deadbolt and Lever
925/942	Bluetooth Enabled Deadbolt
938/939	WiFi Enabled Deadbolt
953	Keyless Touchscreen Deadbolt
966/967/968/971/973/974/976/977	Interior Pack for Kwikset Signature Series Handleset
978/979	Interior Pack for Montara Handleset

**HANDING**

To determine the handing of a door face the OUTSIDE of the door. If the hinge is on the left side of the door, the door is left handed (LH). If the hinge is on the right side of the door, the door is right handed (RH).

**NOTE:** Handing required for dummy levers and interior packs with levers when lever design is not symmetric.

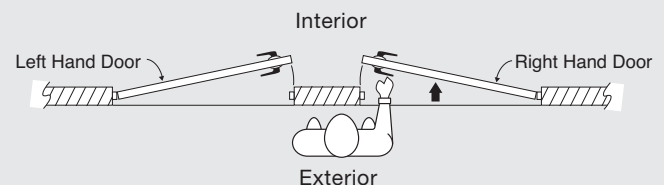

Finish	Description	ANSI/BHMA	Latch	Description
3	Polished Brass	605	WFL	Wide Face Latch 2-1/4" x 1-1/8"
L03	Lifetime Polished Brass	605E	RCAL	Round Corner Adjustable Latch
5	Antique Brass	609	6AL	6-Way Adjustable Latch. All Parts Loose
11P	Venetian Bronze	---	SCAL	Square Corner Adjustable Latch
15	Satin Nickel	619	RFAL	Round Face Adjustable Latch
15A	Antique Nickel	620	RCAL FD*	Round Corner Adjustable 20 Minute UL
26	Polished Chrome	625	SCAL FD*	Square Corner Adjustable 20 Minute UL
26D	Satin Chrome	626	RFAL FD*	Round Adjustable 20 Minute UL
514	Iron Black	---		



\*NOTE: List charge for 20 minute UL is \$2.50



HANDLESETS	Function Name	Description	KWIKSET w/ BHMA	KWIKSET SIGNATURE SERIES w/ BHMA
	<p>Handleset with Single Cylinder Deadbolt</p>	<p>Latch bolt operated by thumb piece outside and grip inside. Deadbolt operated by key outside and thumb turn inside.</p>	<p>687</p>	<p>800, 818</p>
	<p>Handleset with Double Cylinder Deadbolt</p>	<p>Latch bolt operated by thumb piece outside and grip inside. Deadbolt operated by key both sides.</p>	<p>689</p>	<p>801</p>
	<p>Dummy Handleset with Dummy Deadbolt</p>	<p>Handle and grip act as a pull only. For inactive leaf of double doors. No operation.</p>	<p>699</p>	<p>802, 819</p>
	<p>Two Point Locking Handleset with Single Cylinder Deadbolt</p>	<p>Latch bolt operated by thumb piece outside and grip inside, except when both are locked by key outside or turn button inside. Deadbolt operated by key outside or thumb turn inside.</p>	<p>N/A</p>	<p>553 F94</p>

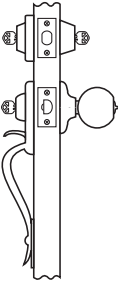
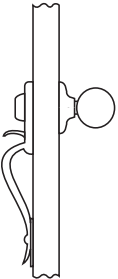

or



HANDLESETS	Function Name	Description	KWIKSET w/ BHMA	KWIKSET SIGNATURE SERIES w/ BHMA
	Two Point Locking Handleset with Double Cylinder Deadbolt	Latch bolt operated by thumb piece outside and grip inside, except when both are locked by key outside or turn button inside. Deadbolt operated by key both sides.	N/A	554
	Handleset with Knob or Lever	Latch bolt operated by thumb piece outside and grip inside.	898	815
	Handleset Only	Latch bolt operated by thumb piece outside	899	814



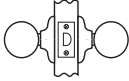
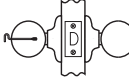
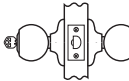
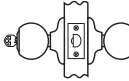
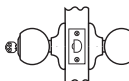



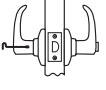
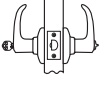
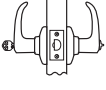
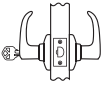

KNOBS	Function Name	Description	KWIKSET SIGNATURE	
			KWIKSET w/ BHMA	SERIES w/ BHMA
	Passage/Hall/Closet	Both knobs always free.	200 F75	720/725UL F75
	Privacy/Bed/Bath	Both knobs locked or unlocked by turn button inside. Outside knob unlocked by emergency key.	300 F76	730/735UL F76
	Entry	Both knobs locked or unlocked by key outside or turn button inside.	400 F82	740/745UL F82
	Entry, Free Interior	Outside locked or unlocked by key outside or turn button inside. Inside always free.	401 F81	741/746UL F81
	Storeroom/Vestibule	Outside unlocked only while key is turned. Inside always free.	450 F86	750/755UL F86
	Half Dummy Trim, Surface Mounted	For doors where only a pull is required. No operation.	488	788

NOTE: BHMA code in italics. Optional UL 1/3 hour rating for all functions.







LEVERS	Function Name	Description	KWIKSET w/ BHMA	KWIKSET SIGNATURE
				SERIES w/ BHMA
	Passage/Hall/Closet	Both levers always free.	200/407/420UL F75	154/720/725/725UL F75
	Privacy/Bed/Bath	Both levers locked or unlocked by turn button inside. Outside lever unlocked by emergency key.	300/408UL/430UL F76	155/730/735UL F76
	Keyed Entry Lever	Both levers locked or unlocked by key outside or turn or push button inside.	401/405/406UL F82	156/740/745/756UL F82
	Entry, Free Interior	Outside locked or unlocked by key outside or turn button inside. Inside always free.	401/406/413UL F81	741/746UL/911 F81
	Storeroom/Vestibule	Outside unlocked only while key is turned. Inside always free.	439/450/462/412UL F86	750/755UL/781 F86
	Half Dummy Trim, Surface Mounted	For doors where only a pull is required. No operation.	488	788/157

NOTE: BHMA code in italics. Optional UL 1/3 hour rating for all functions.

DEADBOLTS	Function Name	Description	KWIKSET w/ BHMA	KWIKSET SIGNATURE
				SERIES w/ BHMA
	Single Cylinder	Deadbolt operated by key outside and thumb turn inside.	660 E0153	980/982UL E0151 780/782UL/909 E0152 816/817UL E0152 158/258/913/925/997 E0142
	Double Cylinder	Deadbolt operated by key both sides.	665/E0143	985/984UL E0141 785/784UL E0142 996 159 E0152
	Thumb Turn Only	Deadbolt operated by thumb turn one side. No trim on exterior.	663 E0193	N/A

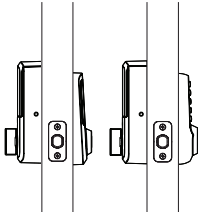
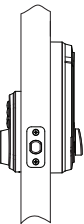
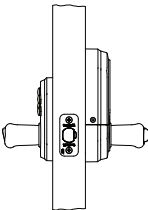

DEADBOLTS	Function Name	Description	KWIKSET w/ BHMA	KWIKSET SIGNATURE SERIES w/ BHMA
	Conversion Kit	Converts 663 to 667 when door is bored through.	664	N/A
	Thumb Turn x Plate	Deadbolt operated by thumb turn on interior. Blank plate on exterior.	667/677UL E01113	N/A
	Single Cylinder Gatelatch	Deadbolt operated by key outside and thumb turn inside.	N/A	598
	Double Cylinder Gatelatch	Deadbolt operated by key both sides.	N/A	599

ELECTRONIC DEADBOLTS	Function Name	Description	KWIKSET w/ BHMA	KWIKSET SIGNATURE SERIES w/ BHMA
	Kevo®	Deadbolt operated by key outside or bluetooth enabled device	N/A	925 E0152
	Halo™	Deadbolt operated by key outside, electronic keypad or WiFi enabled device.	N/A	938/939 E0152
	Aura™	Deadbolt operated by key outside, electronic keypad or bluetooth enabled device.	N/A	942 E0152
	SmartCode™ Deadbolt	Deadbolt operated by key outside or electronic keypad and thumb turn inside.	N/A	909/913/915/919 E0152
	SmartCode™ Lever	Keyed lever operated by key outside or electronic keypad and thumb turn inside.	N/A	911 F81/917 955

**NOTE:** BHMA code in italics



**ROUND POCKET**

**DOOR LOCK**

**KWIKSET SIGNATURE**

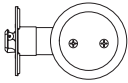
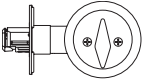
	Function Name	Description	KWIKSET w/ BHMA	SERIES w/ BHMA
	Passage	Pocket door lock always free.	334	N/A
	Privacy	Pocket door lock operated by thumb turn.	335	N/A

**LIGHT COMMERCIAL**

**LEVER**

**LIGHT COMMERCIAL**

**w/ BHMA**

	Function Name	Description	
	Passage/Hall/Closet	Both levers always free.	407/720/721/725UL F75
	Privacy/Bed/Bath	Both levers locked or unlocked by ADA turn button inside. Outside lever unlocked by emergency key.	408/730/733/735UL F76
	Entry	Both levers locked or unlocked by key outside or ADA turn button inside.	409/410/438/740/745UL/756 F82
	Entry, Free Interior	Outside locked or unlocked by key outside or turn button inside. Inside always free.	401/406/413/741/746UL F81
	Storeroom/Vestibule	Outside unlocked only while key is turned. Inside always free.	412/439/750/755UL/781 F86
	Half Dummy Trim, Surface Mounted	For doors where only a pull is required. No operation.	788

NOTE: BHMA code in italics

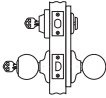
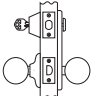
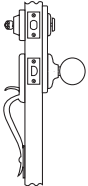

**METAL**

<b>INTERCONNECT</b>	<b>Function Name</b>	<b>Description</b>	<b>METAL INTERCONNECT Model w/BHMA</b>
	Deadlock Latch	Operated by grip either side except when locked by key outside and thumb turn inside. Deadbolt operated by key outside and thumb turn inside. Inside grip simultaneously retracts dead latch and deadbolt latch.	505/506UL F97
	Plain Latch	Operated by grip either side. Deadbolt operated by key outside and thumb turn inside. Inside grip simultaneously retracts plain latch and deadbolt latch.	508/507UL F96
	Interior Assembly Only	Grip inside simultaneously retracts plain latch and deadbolt latch when matched with handleset on outside.	502

NOTE: BHMA code in italics



BOX PACK	Unit					Master Case			
	Quantity	Length (in.)	Width (in.)	Height (in.)	Weight (lbs.)	Quantity	Length (in.)	Width (in.)	Height (in.)
<b>Kwikset Signature Series</b>									
<b>Deadbolts</b>									
780 Single Cylinder	1	4.6730	3.9230	3.0720	2.2500	12	12.8750	12.5000	5.3125
785 Double Cylinder	1	4.6730	3.9230	3.0720	2.7500	12	12.8750	12.5000	5.3125
816 Key Control	1	4.6730	3.9230	3.0720	2.2500	12	12.8750	12.5000	5.3125
980 Single Cylinder	1	4.6730	3.9230	3.0720	2.2500	12	12.8750	12.5000	5.3125
985 Double Cylinder	1	4.6730	3.9230	3.0720	2.7500	12	12.8750	12.5000	5.3125
158 Single Cylinder	1	4.6730	3.9230	3.0720	2.2500	12	12.8750	12.5000	5.3125
159 Single Cylinder	1	4.6730	3.9230	3.0720	2.7500	12	12.8750	12.5000	5.3125
258 Single Cylinder	1	4.81	4.06	3.13	1.76	12	13.37	12.9	6.21
Electronic Deadbolts/Levers									
905 Powerbolt	1	8	3.75	3.5	2	2	8.5	7.5	4.25
907 Powerbolt	1	5.51	3.54	9.29	2.93	2	5.75	7.87	10.16
909 / 910 SmartCode	1	5.5	3.5	10	2.88	2	7.6	6	10.5
912 SmartCode Lever	1	3.5	6	10	61	2	7	12.5	10.4
913 / 914 SmartCode	1	5.5	3.5	10	2.88	2	7.6	6	10.5
915/916/919/938/939/942 SmartCode	1	3.5	5.38	9.88	3.14	2	10.50	7.75	5.94
914 / 916 / 954	1	9.75	4.0	4.28	3.12	1	10.25	4.63	4.44
914 / 916 / 954	1	5.32	5.79	8.86	4.40	2	11.42	6.69	10.24
925 Kevo	1	3.63	5.75	10.38	3.5	1	11.63	4	6.25
926 Kevo Fob	4	6	1	3	0.5	4	6	1	3
<b>Handlesets</b>									
553 Single Cylinder	1	15.9380	7.1250	4.0000	6.2500	4	16.4380	15.9380	7.8125
554 Double Cylinder	1	15.9380	7.1250	4.0000	6.7500	4	16.4380	15.9380	7.8125
800 AUH Austin	1	15.9380	7.1250	4.0000	7.0000	4	16.4380	15.9380	7.8125
801 AUH Austin	1	15.9380	7.1250	4.0000	7.5000	4	16.4380	15.9380	7.8125
802 AUH Austin	1	15.9380	7.1250	4.0000	6.5000	4	16.4380	15.9380	7.8125
800ADH Ashfield, 800AVH Avalon	1	15.9380	7.1250	4.0000	7.0000	4	16.4380	15.9380	7.8125
801ADH Ashfield, 801AVH Avalon	1	15.9380	7.1250	4.0000	7.5000	4	16.4380	15.9380	7.8125
802ADH Ashfield, 802AVH Avalon	1	15.9380	7.1250	4.0000	6.5000	4	16.4380	15.9380	7.8125
800AN Arlington	1	15.9380	7.1250	4.0000	7.0000	4	16.4380	15.9380	7.8125
801AN Arlington	1	15.9380	7.1250	4.0000	7.5000	4	16.4380	15.9380	7.8125
802AN Arlington	1	15.9380	7.1250	4.0000	6.5000	4	16.4380	15.9380	7.8125
800AT Amherst	1	19.9380	7.6250	4.0000	8.9000	4	20.5000	16.0000	8.3875
801AT Amherst	1	19.9380	7.6250	4.0000	9.9000	4	20.5000	16.0000	8.3875
802AT Amherst	1	19.9380	7.6250	4.0000	6.9000	4	20.5000	16.0000	8.3875
800CE Chelsea	1	15.9380	7.1250	4.0000	6.0000	4	16.4380	15.9380	16.6255
801CE Chelsea	1	15.9380	7.1250	4.0000	6.5000	4	16.4380	15.9380	16.6255
802CE Chelsea	1	15.9380	7.1250	4.0000	5.5000	4	16.4380	15.9380	16.6255
800HE Hawthorne	1	15.9380	7.1250	4.0000	7.0000	4	16.4380	15.9380	7.8125
801HE Hawthorne	1	15.9380	7.1250	4.0000	8.0000	4	16.4380	15.9380	7.8125
802HE Hawthorne	1	15.9380	7.1250	4.0000	5.0000	4	16.4380	15.9380	7.8125
800SE Shelburne	1	15.9380	7.1250	4.0000	7.9000	4	16.4380	15.9380	7.8125
801SE Shelburne	1	15.9380	7.1250	4.0000	8.9000	4	16.4380	15.9380	7.8125
802SE Shelburne	1	15.9380	7.1250	4.0000	5.9000	4	16.4380	15.9380	7.8125
800 Tavaris	1	15.9380	7.1250	4.0000	8.0000	4	16.4380	16.6200	8.3800
801 Tavaris	1	15.9380	7.1250	4.0000	8.2500	4	16.4380	16.6200	8.3800
802 Tavaris	1	15.9380	7.1250	4.0000	8.0000	4	16.4380	16.6200	8.3800
966 Single Cylinder	1	2.7	3.7	4.30	2.25	12	15.20	12.5	7
967 Double Cylinder	1	2.7	3.7	4.30	2.25	12	15.20	12.5	7
968 Dummy	1	2.7	3.7	4.30	2.25	12	15.20	12.5	7
978 Single Cylinder	1	2.7	3.7	4.30	2.25	12	15.20	12.5	7
979 Double Cylinder	1	2.7	3.7	4.30	2.25	12	15.20	12.5	7

BOX PACK	Unit					Master Case			
	Quantity	Length (in.)	Width (in.)	Height (in.)	Weight (lbs.)	Quantity	Length (in.)	Width (in.)	Height (in.)
<b>Kwikset Signature Series Continued</b>									
<b>Knobs</b>									
720 Passage	1	8.1730	3.9230	2.7840	2.0000	12/30	12.3750	11.5000	8.8125
730 Privacy	1	8.1730	3.9230	2.7840	2.0000	12/30	12.3750	11.5000	8.8125
740 Entry	1	8.1730	3.9230	2.7840	2.3300	12/30	12.3750	11.5000	8.8125
788 Dummy	1	3.2360	2.7980	3.0100	0.3500	20	14.8750	12.5000	3.9375
<b>Levers</b>									
154/720 Passage	1	7.8750	6.1250	3.1875	2.4200	12/20	19.7500	12.8750	8.5625
155/730 Privacy	1	7.8750	6.1250	3.1875	2.4200	12/20	19.7500	12.8750	8.5625
156/740 Entry	1	7.8750	6.1250	3.1875	2.4200	12/20	19.7500	12.8750	8.5625
157/788 Dummy	1	5.8610	3.1100	2.8220	0.4500	20	15.8750	12.1250	6.6245
720 LL, TNL	1	6.625	5.75	3.0	1.65	20	24	15.50	6.70
730 LL, TNL	1	6.625	5.75	3.0	1.70	20	24	15.50	6.85
740 LL, TNL	1	6.625	5.75	3.0	2.05	20	24	15.50	8.30
788 LL, TNL	1	5.861	3.11	2.822	0.450	20	15.875	12.125	6.6245

<b>Kwikset</b>									
<b>Combo Packs</b>									
690T Tylo Knob and Single Cylinder Deadbolt	1	11.3090	3.4230	2.7840	2.8000	6	8.7500	7.3120	11.9375
<b>Deadbolts</b>									
598 Single Cylinder Gate Latch	1	4.6730	3.9230	3.0720	2.2500	12	12.8750	12.5000	5.3125
599 Double Cylinder Gate Latch	1	4.6730	3.9230	3.0720	2.2500	12	12.8750	12.5000	5.3125
660 Single Cylinder	1	3.9480	3.4230	2.5720	0.5000	12	11.1250	11.0000	4.5625
665 Double Cylinder	1	3.9480	3.4230	2.5720	0.9000	12	11.1250	11.0000	4.5625
663 One-Sided	1	3.9480	3.4230	2.5720	0.5500	12	11.1250	11.0000	4.5625
667 One-Sided	1	3.9480	3.4230	2.5720	0.9000	12	11.1250	11.0000	4.5625
664 Retrofit Kit	1	3.9480	3.4230	2.5720	0.9000	12	11.1250	11.0000	4.5625
677 One-Sided	1	3.9480	3.4230	2.5720	0.2500	12	11.1250	11.0000	4.5625
<b>Handlesets</b>									
604 Single Cylinder	1	5.8000	3.9000	3.7000	2.25	12	15.20	12.5	7
605 Double Cylinder	1	5.8000	3.9000	3.7000	2.25	12	15.20	12.5	7
606 Dummy	1	5.8000	3.9000	3.7000	2.25	12	15.20	12.5	7
687 LIP	1	15.9380	7.1250	4.0000	3.6000	6	15.0000	12.1250	16.6255
689 LIP	1	15.9380	7.1250	4.0000	4.0000	6	15.0000	12.1250	16.6255
699 LIP	1	15.9380	7.1250	4.0000	3.6000	6	15.0000	12.1250	16.6255
<b>Knobs</b>									
200 Polo	1	8.1730	3.2980	2.7840	1.3000	30	17.1250	17.0000	8.8125
300 Polo	1	8.1730	3.2980	2.7840	1.3000	30	17.1250	17.0000	8.8125
400 Polo	1	8.1730	3.2980	2.7840	1.3000	30	17.1250	17.0000	8.8125
200 Tylo/Cove	1	7.3610	3.2980	2.7840	1.1500	30	17.1250	17.0000	8.1870
300 Tylo/Cove	1	7.3610	3.2980	2.7840	1.1500	30	17.1250	17.0000	8.1870
400 Tylo/Cove	1	7.3610	3.2980	2.7840	1.1500	30	17.1250	17.0000	8.1870
488 Dummy	1	3.2360	2.7980	3.0100	0.3500	20	14.8750	12.5000	3.9375
<b>Lever</b>									
200 Passage	1	6.7980	5.7660	2.9720	1.3500	20	23.6250	15.3750	7.4995
300 Privacy	1	6.7980	5.7660	2.9720	1.3500	20	23.6250	15.3750	7.4995
405 Keyed Lever	1	6.7980	5.7660	2.9720	1.5800	20	23.6250	15.3750	7.4995
488 Dummy	1	5.8610	3.1100	2.8220	0.4500	20	15.8750	12.1250	6.6245

<b>Miscellaneous</b>									
<b>Pocket Door Hardware</b>									
334 Passage	1	4.3750	3.0000	2.0000	.65	12	12.5000	14.3750	2.2500
335 Privacy	1	4.3750	3.0000	2.0000	.8	12	12.5000	14.3750	2.2500

BOX PACK	Unit					Master Case			
	Quantity	Length (in.)	Width (in.)	Height (in.)	Weight (lbs.)	Quantity	Length (in.)	Width (in.)	Height (in.)
<b>Kwikset Multi-Family / Light Commercial</b>									
<b>Burbank, Carson, and Palmina</b>									
407	1	6.75	5.75	2.75	0.5	1	7.93	6.06	3.12
408	1	6.75	5.75	2.75	0.5	1	7.93	6.06	3.12
438	1	6.75	5.75	2.75	1.0	1	7.93	6.06	3.12
439	1	6.75	5.75	2.75	1.0	1	7.93	6.06	3.12
488	1	5.18	3.00	2.43	0.55	1	15.75	12.00	6.56
<b>Kingston</b>									
721KNL	1	6.75	5.75	2.75	1.5	1	7.93	6.06	3.12
733KNL	1	6.75	5.75	2.75	1.5	1	7.93	6.06	3.12
756KNL SMT	1	6.75	5.75	2.75	2.33	1	7.93	6.06	3.12
781KNL SMT	1	6.75	5.75	2.75	2.33	1	7.93	6.06	3.12
788 LVR	1	5.18	3.00	2.43	0.87	1	15.13	12.75	3.50
<b>SmartKey Padlock</b>									
50MM SmartKey Padlock Std. Shackle	6	2.56	1.46	4.65	1.10	6	5.39	4.80	5.04
50MM SmartKey Padlock Long Shackle	6	2.56	1.46	4.65	1.14	6	5.39	4.80	5.04





Customer Service Toll Free Line:

(800) 422-LOCK (800) 422-5625

FAX (866) 507-8369

email: [kworders@spectrumbands.com](mailto:kworders@spectrumbands.com)

Monday to Friday, 6:00 a.m. to 4:00 p.m. PST

Date:

\_\_\_\_\_

Delivery Address:

\_\_\_\_\_

Contact:

\_\_\_\_\_

PO Number:

\_\_\_\_\_

Phone:

\_\_\_\_\_

Company Name:

\_\_\_\_\_

Job Name:

\_\_\_\_\_

Fax:

\_\_\_\_\_

Address:

\_\_\_\_\_

Notes:

Store Number:

\_\_\_\_\_

Line No.	Function		Style		Handing	Rose		Finish		OPTIONS					Quantity	Price	Extended Price
	Exterior	Interior	Exterior	Interior		Exterior	Interior	Exterior	Interior	Door Thickness	Latch	Strike	Cylinder	Keying			
1																	
2																	
3																	
4																	
5																	
6																	
7																	
8																	
9																	
10																	
11																	
12																	
13																	
14																	
15																	
16																	
17																	
18																	
19																	
20																	

To order service parts, provide service part # and quantity.  
How to order questions, refer back to page A:3 for General Information.





## Benefits of Kwikset® Door Hardware with Microban® Technology

Bacteria can double every 20 minutes on unprotected surfaces, but Kwikset Door Hardware with Microban protection works to continuously fight off microbes.

- Door hardware is 99.9% cleaner than knobs without Microban
- The antimicrobial coating last for the lifetime of the hardware finish, so you can worry less and feel more secure in your home.
- No need to clean door hardware - 24/7 Antimicrobial protection
- Kwikset with Microban protection is effective against a broad spectrum of bacteria

**99.9% cleaner than unprotected surface**

Protected with Microban

Unprotected Surface

## Microban finish is available on select Kwikset® products.



Available Finishes

	Satin Nickel 15		Polished Brass 3
	Antique Nickel 15A		Antique Brass 5

Look for the Microban sticker:



Additional Styles Coming Soon

**#1 SELLING U.S. LOCK BRAND\***

\*Source: TraQline US quarterly brand unit share report, Q4 2006 through Q2 2018

# Kwikset



# HALO



## TOUCH

### FINGERPRINT SMART LOCK

The Halo Touch Wi-Fi enabled smart lock with fingerprint access technology allows you to simply use your unique fingerprint to lock and unlock your door.



Kwikset

Works with the  
Kwikset App



## Control your lock from your smartphone

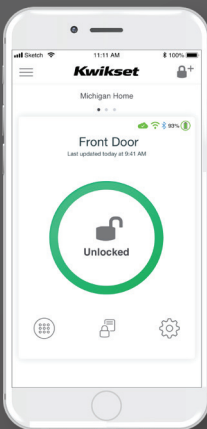

REMOTE  
ACCESS

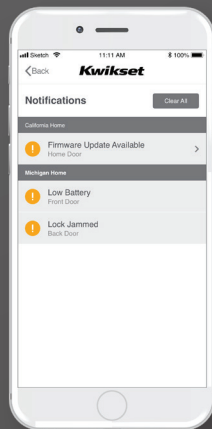

PUSH  
NOTIFICATIONS

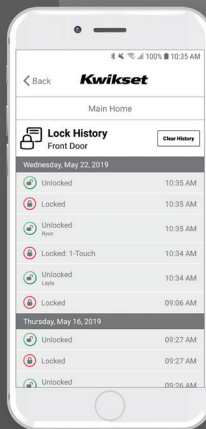

EVENT  
HISTORY

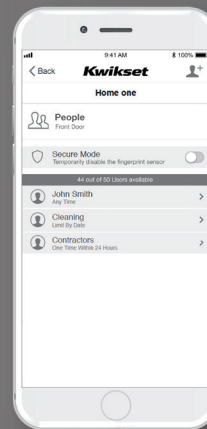

MANAGE  
USERS

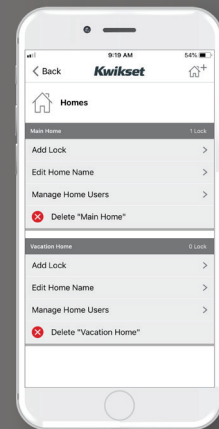

MANAGE MULTIPLE  
HOMES

## #1 SELLING U.S. LOCK BRAND\*

\*Source: TraQline US quarterly brand unit share report, Q4 2006 through Q4 2019.

## Specifications

<b>Function</b>	Single cylinder deadbolt
<b>Door Prep</b>	2 1/8" diameter bore hole & 1" diameter latch hole
<b>Backset</b>	Adjustable 2 3/8" or 2 3/4"
<b>Door Thickness</b>	1 3/4" - 2" automatic adjustment
<b>Faceplates</b>	1" x 2 1/4" round corner standard
<b>Strikes</b>	Round corner, 4 hole strike, 2 3/4" x 1 1/8"
<b>Latch</b>	Round corner adjustable 2 3/8" x 2 3/4"
<b>Bolt</b>	1" throw, steel deadbolt
<b>Door Handing</b>	Reversible
<b>Cylinder</b>	SmartKey Security™
<b>Temp Range &amp; Humidity</b>	Temperature Range: Exterior: -40F to 150F Interior: 32F to 130F Humidity: Exterior: 100% condensing Interior: 30% - 95% non-condensing

## Innovative Security

- Up to 100 fingerprints/50 users
- BHMA Grade AAA certified
- 256-bit AES encryption security
- Featuring SmartKey Security™ - protecting against advanced break-in techniques

## Easy Installation

- No hub required by connecting directly to your home Wi-Fi network
- Operates on (4) AA batteries
- Installs in minutes using a screwdriver

## Warranty

- Lifetime mechanical and finish warranty
- 1 year electronic warranty

## How it Works

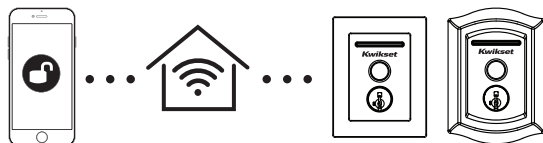

## Dimensions

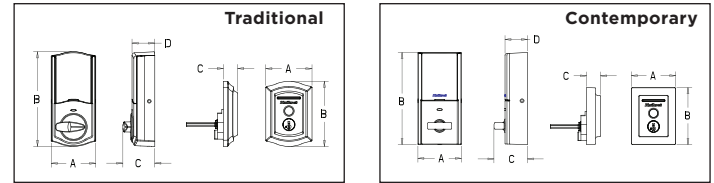

Traditional	A	B	C	D
Interior	2 23/32" (69 mm)	5 25/32" (147 mm)	1 15/16" (49 mm)	1 7/16" (35 mm)
Exterior	2 13/16" (72 mm)	3 31/32" (101 mm)	7/8" (22 mm)	---

Contemporary	A	B	C	D
Interior	2 23/32" (69 mm)	5 25/32" (147 mm)	2 2/32" (53 mm)	1 13/32" (36 mm)
Exterior	2 25/32" (71 mm)	3 9/16" (91 mm)	7/8" (22 mm)	---

## Finishes



Satin Nickel<sup>15</sup>  
99590-001



Venetian Bronze<sup>17P</sup>  
99590-002



Satin Nickel<sup>15</sup>  
99590-003



Matte Black<sup>514</sup>  
99590-004

FINISH AND  
LIFETIME  
WARRANTY  
MECHANICAL

ONE YEAR  
ELECTRONIC WARRANTY



This BHMA certified product has been tested to a good (C), better (B), best (A) rating in each of these areas: security, durability and finish.  
[www.securehome.org](http://www.securehome.org)

# Kwikset



# HALO™

WI-FI ENABLED SMART LOCKS

Halo smart locks connect directly to your existing home Wi-Fi network and smartphone to create a simple and secure smart home, without a third-party hub, panel or subscription service.



## Control your lock from your smartphone

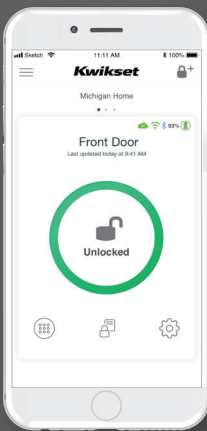

REMOTE ACCESS

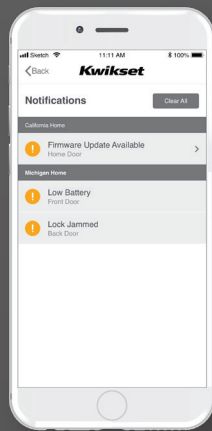

PUSH NOTIFICATIONS

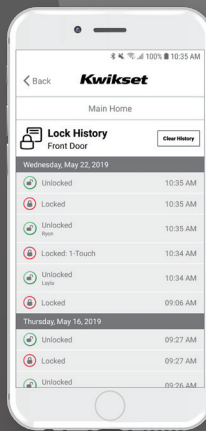

EVENT HISTORY

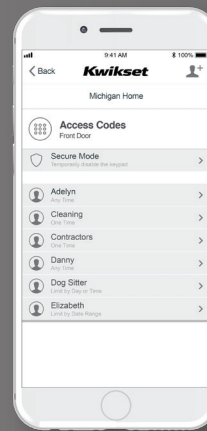

MANAGE ACCESS CODES

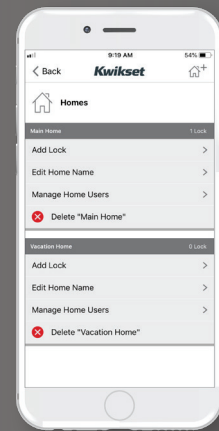

MANAGE MULTIPLE HOMES

## #1 SELLING U.S. LOCK BRAND\*

\*Source: TraQline US quarterly brand unit share report, Q4 2006 through Q2 2019.

## Specifications

<b>Function</b>	Single cylinder deadbolt
<b>Door Prep</b>	2 1/8" diameter bore hole & 1" diameter latch hole
<b>Backset</b>	Adjustable 2 3/8" or 2 3/4"
<b>Door Thickness</b>	1 3/8" - 2" automatic adjustment
<b>Faceplates</b>	1" x 2 1/4" round corner standard
<b>Strikes</b>	Round corner, 4 hole strike, 2 3/4" x 1 1/8"
<b>Latch</b>	Round corner adjustable 2 3/8" x 2 3/4"
<b>Bolt</b>	1" throw, steel deadbolt
<b>Door Handing</b>	Reversible
<b>Cylinder</b>	SmartKey Security™

## Dimensions

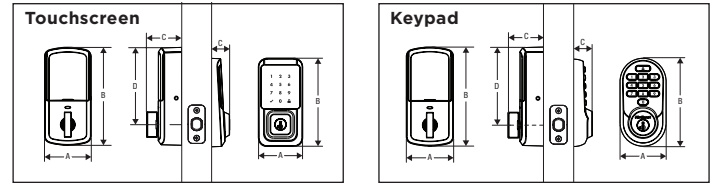

Touchscreen	A	B	C	D
Interior	2 3/4" (70 mm)	5 13/16" (147 mm)	2 1/8" (53 mm)	4 9/16" (116 mm)
Exterior	2 28/32" (73 mm)	5 5/8" (143 mm)	1 3/16" (30 mm)	---

Keypad	A	B	C	D
Interior	2 3/4" (70 mm)	5 13/16" (147 mm)	2 1/8" (53 mm)	4 9/16" (116 mm)
Exterior	2 28/32" (73 mm)	5 13/32" (137 mm)	1 3/16" (30 mm)	---

## Innovative Security

- 250 customizable access codes with optional schedules
- BHMA Grade AAA certified
- 20 Minute fire rating - UL certified
- Full 128-bit encryption security
- Featuring SmartKey Security™ - protecting against advanced break-in techniques
- SecureScreen™ - patented security feature prevents on-screen fingerprint user code identification (Touchscreen only)

## Easy Installation

- Installs in minutes with just a screwdriver
- No hard wiring needed
- Operates on 4 AA batteries

## Warranty

- Lifetime mechanical and finish warranty
- 1 year electronic warranty

## Finishes



Satin Nickel<sup>15</sup>  
99390-001

Venetian Bronze<sup>11P</sup>  
99390-002

Polished Chrome<sup>26</sup>  
99390-003

Iron Black<sup>514</sup>  
99390-004



Satin Nickel<sup>15</sup>  
99380-001



Venetian Bronze<sup>11P</sup>  
99380-002

## How it Works



FINISH AND  
**LIFETIME  
WARRANTY**  
MECHANICAL  
  
ONE YEAR  
ELECTRONIC WARRANTY



# Kwikset

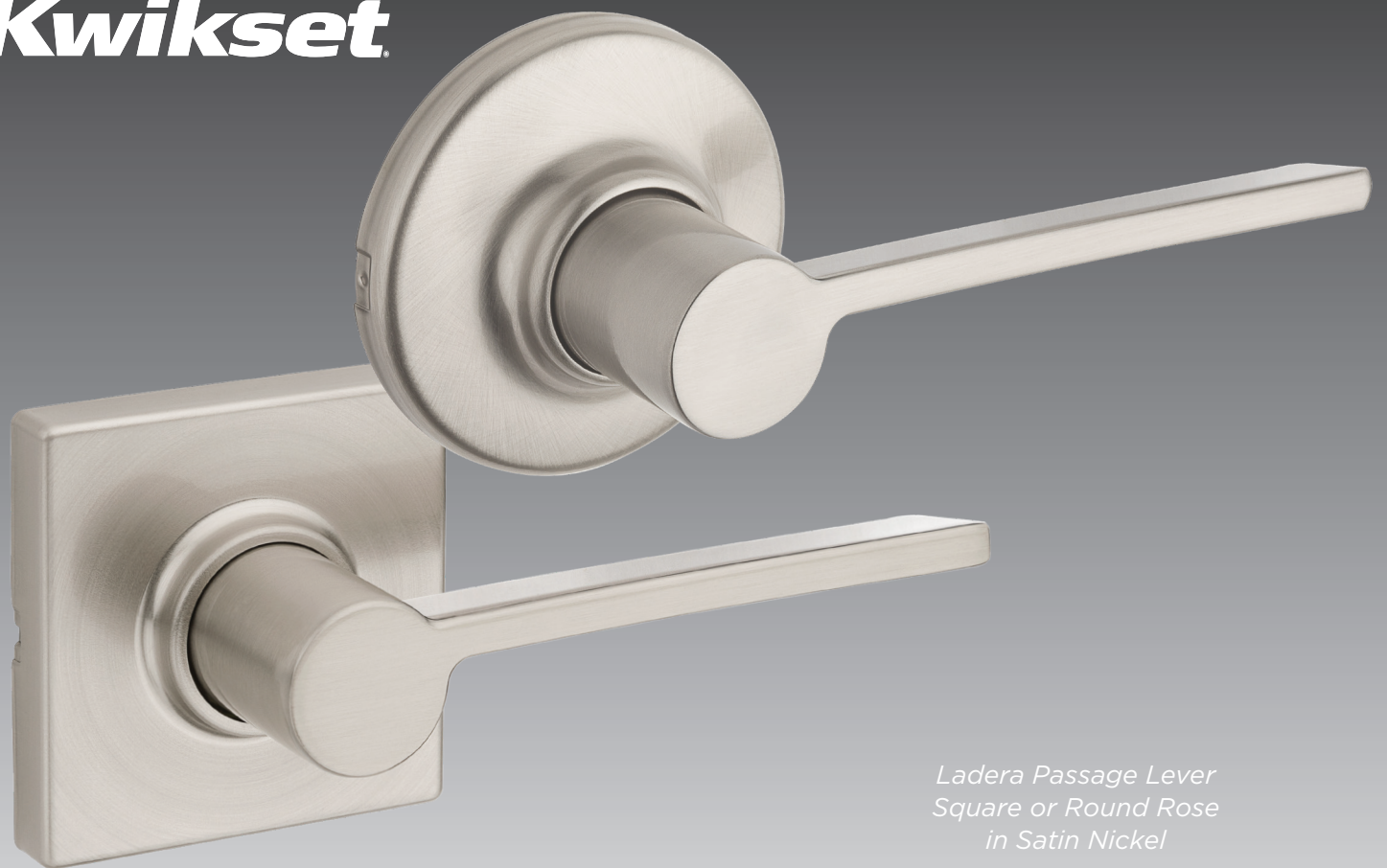

*Ladera Passage Lever  
Square or Round Rose  
in Satin Nickel*

## LADERA LEVER

Simple and understated, the Ladera lever will surely delight. The linear and unadorned look of the Ladera lever makes it an excellent choice for a transitional or contemporary themed décor.

- Reversible lever fits both left and right-hand doors
- Available with square or round rose
- ANSI/BHMA Grade 3 Certified



*Ladera Entry Lever  
with SmartKey Security™  
Round Rose in  
Polished Chrome*

*Ladera Entry Lever  
with SmartKey Security™  
Square Rose in Iron Black*



#1 SELLING U.S. LOCK BRAND\*

\*Source: TraQline US quarterly brand unit share report, Q4 2006 through Q2 2019



## Specifications

<b>Door Prep</b>	2-1/8" diameter face hole & 1" diameter latch hole
<b>Backset</b>	Adjustable 2-3/8" or 2-3/4".
<b>Door Thickness</b>	1-3/8" - 1-3/4" Doors standard. 2 1/4" doors optional on 200 and 405 functions only
<b>Cylinder</b>	SmartKey Security™ or traditional 5-Pin pin & tumbler
<b>Faceplates</b>	1" x 2-1/4" Specify round corner, square corner or drive-in
<b>Strikes</b>	2-1/4" Full lip round corner strike. Other options available
<b>Bolt</b>	1/2" Throw
<b>Door Handing</b>	Reversible for passage, privacy or entry. Specify handing only with inactive levers
<b>ANSI/BHMA</b>	Grade 3 (all functions except 488)
<b>ADA</b>	Functions 200 and 420 are in compliance with the American National Standards Institute (ANSI A117.1) and the Americans with Disabilities Act (ADA)

## Dimensions

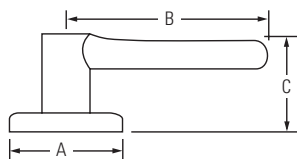

Design	A	B	C	C (Keyed)
Ladera™ Round Rose	2 5/8"	4 3/16"	1 7/8"	2 7/16"
Ladera™ Square Rose	2 5/8"	4 3/16"	1 7/8"	2 7/16"

## Finishes

MICROBAN

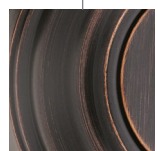

Venetian Bronze 11P



Satin Nickel 15



Iron Black\* 514



Polished Chrome 26

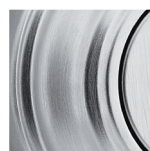

Satin Chrome 26D

LIFETIME WARRANTY

\*Iron Black finish available in square rose only

## Functions



**Passage/Hall/Closet:** Both levers always free  
- 200 LRL



**Privacy/Bed/Bath:** Both levers locked or unlocked by turnbutton inside. Outside lever unlocked by emergency key  
- 300 LRL



**Keyed Entry Lever:** Both sides locked or unlocked by key outside or turnbutton inside  
- 405 LRL SMT



**Half Dummy Trim, Surface Mounted:** For doors where only a pull is required. No operation  
- 488 LRL



**SMARTKEY  
SECURITY™**

Kwikset's SmartKey Security™ provides homeowners with the superior security that is resistant to a variety of common break-in methods.

This technology also allows homeowners to re-key their locks themselves in seconds, rendering lost or un-returned keys useless.

**Kwikset**

19701 DaVinci, Lake Forest, CA 92610 • Kwikset.com • 1-800-327-5625

© 2019 Spectrum Brands, Inc. Kwikset is a trademark of Spectrum Brands, Inc. Lake Forest, CA 92610 • 437926

# Kwikset



# aura™

BLUETOOTH KEYPAD SMART LOCK

Smarter Living  
Aura™ Bluetooth™ smart lock gives you control of your door with your smartphone — it's as simple as that.



Bluetooth Enabled



Works with the Kwikset App

## Control your lock from your phone

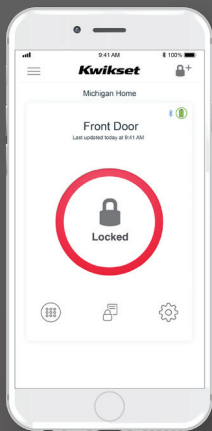

LOCKED

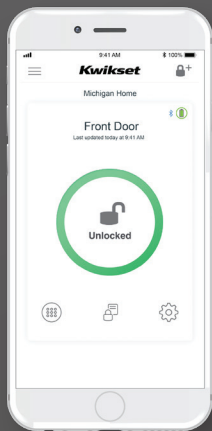

UNLOCKED

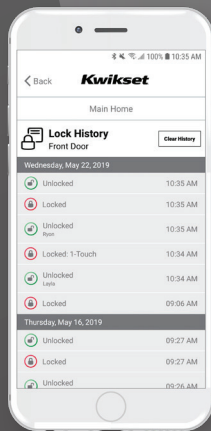

EVENT HISTORY

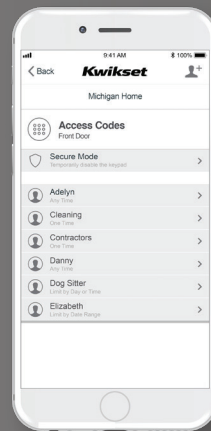

MANAGE ACCESS CODES

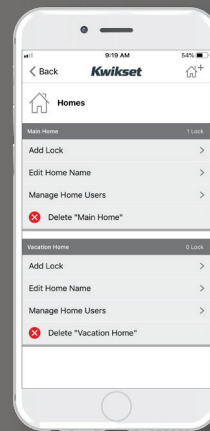

MANAGE MULTIPLE HOMES

## #1 SELLING U.S. LOCK BRAND\*

\*Source: TraQline US quarterly brand unit share report, Q4 2006 through Q1 2019.

## Specifications

<b>Function</b>	Single cylinder deadbolt
<b>Door Prep</b>	2 1/8" diameter bore hole & 1" diameter latch hole
<b>Backset</b>	Adjustable 2 3/8" or 2 3/4"
<b>Door Thickness</b>	1 3/8" - 2" automatic adjustment
<b>Faceplates</b>	1" x 2 1/4" round corner standard
<b>Strikes</b>	Round corner, 4 hole strike, 2 3/4" x 1 1/8"
<b>Latch</b>	Round corner adjustable 2 3/8" x 2 3/4"
<b>Bolt</b>	1" throw, steel deadbolt
<b>Door Handing</b>	Reversible
<b>Cylinder</b>	SmartKey Security™

## Dimensions

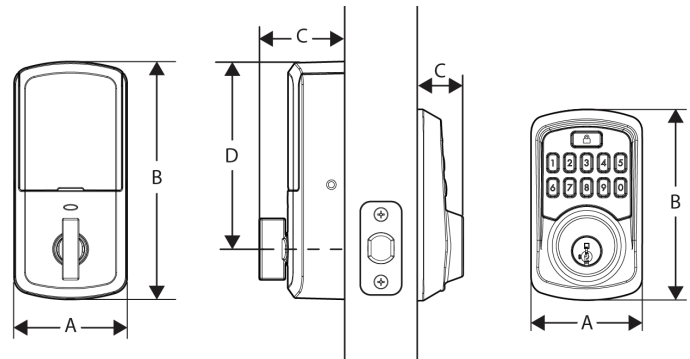

Design	A	B	C	D
Interior	2 3/4" (70 mm)	5 13/16" (147 mm)	2 1/8" (53 mm)	4 9/16" (116 mm)
Exterior	2 23/32" (69 mm)	4 5/8" (117 mm)	1 3/16" (30 mm)	---

## Innovative Security

- 250 customizable access codes with optional schedules
- BHMA Grade AAA certified
- 20 Minute fire rating - UL certified
- Full 128-bit encryption security
- Featuring SmartKey Security™ - protecting against advanced break-in techniques

## Easy Installation

- Installs in minutes with just a screwdriver
- No hard wiring needed
- Operates on 4 AA batteries

## Warranty

- Lifetime mechanical and finish warranty
- 1 year electronic warranty



## Finishes



*Satin Nickel*<sup>15</sup>  
99420-001

*Venetian Bronze*<sup>11P</sup>  
99420-002

*Iron Black*<sup>514</sup>  
99420-003

## How it Works

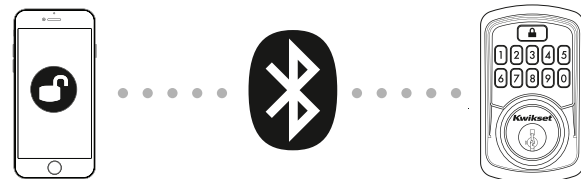

# Kwikset

Introducing

# VANCOUVER

Featuring



**SMARTKEY**  
**SECURITY™**



**The Vancouver handleset has a clean, low profile design.**

With this sleek contemporary style, you make a bold statement right at the front door.

- Features New Advance SmartKey Security™
- Features Microban® antimicrobial finish protection\*
- Certified Highest Security Deadbolt
- Lifetime Mechanical and Finish Warranty
- Adjustable Throughbolt for Guaranteed Fit

\* Microban® available in the following finishes:  
Satin Nickel (15), Venetian Bronze (11p), and Iron Black (514)

## #1 SELLING U.S. LOCK BRAND\*

\*Source: TraQline US quarterly brand unit share report, Q4 2006 through Q1 2019

386177-04/19

## Specifications

<b>Door Prep</b>	Cross Bore 2 1/8" Edge Bore 1" Latch Face 1" x 2 1/4" Deadbolt & Handle bore holes must be 5 1/2" apart
<b>Backset</b>	Adjustable 2 3/8" or 2 3/4"
<b>Door Thickness</b>	1 3/4" Standard. Thick door service part available for up to 2 1/4"
<b>Faceplates</b>	1" x 2 1/4". Square, round and drive-in included
<b>Strikes</b>	<ul style="list-style-type: none"> <li>▪ <b>Deadbolt:</b> 1 1/8" x 2 3/4" &amp; 2 1/4" full lip (non-graded)</li> <li>▪ <b>Handle:</b> 2 1/4" full lip round</li> </ul>
<b>Bolt</b>	<ul style="list-style-type: none"> <li>▪ <b>Deadbolt:</b> 1" throw</li> <li>▪ <b>Handle:</b> 1/2" throw</li> </ul>
<b>Cylinder</b>	SmartKey Security™
<b>Door Handing</b>	Reversible for right or left-hand doors
<b>ANSI/BHMA</b>	Deadbolt - A156.39 Grade AAA Certified
<b>UL</b>	N/A
<b>ADA</b>	N/A
<b>Warranty</b>	Lifetime mechanical and lifetime finish

## Dimensions

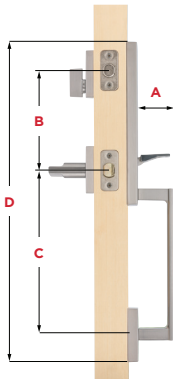

Dimensions	A	B	C	D
Vancouver	2 21/32"	5 1/2"	8 13/32" through 9 11/16"	17 15/16"

## Finishes

MICROBAN®

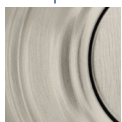

15  
Satin  
Nickel



11P  
Venetian  
Bronze



514  
Iron  
Black



26  
Polished  
Chrome

## Interior Options



Halifax Square Full Interior  
(HFL SQF)



Sectional Interiors  
(Other options available)

## Functions



**Handleset (Single-Cylinder):** Latch bolt operated by thumb piece outside and lever inside. Deadbolt operated by key outside and thumb turn inside.  
- 818 VNH SMT



**Handleset (Dummy):** Handle and lever act as a pull only. For inactive leaf or double doors. No operation.  
- 819 VNH



**Interior Pack (Single-Cylinder):** Latch bolt operated by thumb piece outside and lever inside. Deadbolt operated by key outside and thumb turn inside.  
- 971HFL SQF  
(Halifax Only)



**Interior Pack (Dummy):** Lever acts as a pull only. For inactive leaf or double doors. No operation.  
- 973HFL SQFz  
(Halifax Only)



# SMARTCODE 955

COMMERCIAL GRADE LEVER



**30** User Codes



## Features

- Robust metallic design for enhanced durability
- BHMA Commercial grade 2 certified
- Highest residential security rating
- 3 year battery life
- Reversible lever to fit left-hand or right-hand doors
- Property managers can disable the Passage Mode so that it auto-locks every time and a key or code is always required for entry. This is ideal for restrooms in restaurants and gas stations.

## User Codes

- Up to 30 user access codes that can be customized for sharing with employees, maintenance personnel and service professionals
- User can program a one time user code for emergencies, which deletes after first usage
- For added convenience, property managers can program the lock from the outside with a programming code.

**#1 SELLING U.S. LOCK BRAND\***

\*Source: TraQline US quarterly brand unit share report, Q4 2006 through Q4 2018

# Kwikset

## SMARTCODE 955

COMMERCIAL GRADE LEVER

### Specifications

<b>Function</b>	Keyed entry electronic lever
<b>Door Prep</b>	2 1/8" diameter face hole & 1" diameter latch hole
<b>Backset</b>	Adjustable 2 3/8" or 2 3/4"
<b>Door Thickness</b>	1 3/8" - 1 3/4"
<b>Faceplates</b>	1" x 2 1/4" round corner standard
<b>Strikes</b>	Round corner, 4 hole strike, 2 3/4" x 1 1/8"
<b>Latch</b>	Round corner adjustable 2 3/8" x 2 3/4"
<b>Bolt</b>	1/2" throw, dead latch
<b>Door Handing</b>	Reversible
<b>Cylinder</b>	SmartKey Security™

### Dimensions

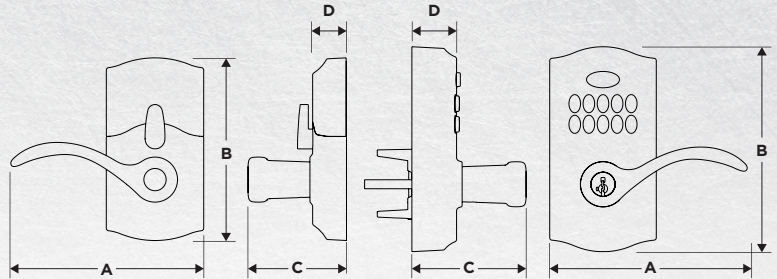

Design	A	B	C	D
Interior	5 5/8" (142.9)	5 5/16" (134.9 mm)	2 7/8" (73 mm)	31/32" (24.6 mm)
Exterior	5 3/4" (146 mm)	5 31/32" (151.6 mm)	3 5/16" (84.1 mm)	1 13/32" (35.7 mm)

### Easy Installation

- Replaces existing door hardware with just a screwdriver
- No hard wiring needed
- Operates on a single 9V battery

### Innovative Security

- BHMA Commercial Grade 2 certified
- BHMA certified AAA. Highest residential security, durability and finish ratings
- ADA Compliant
- Featuring SmartKey Security™
- Tested to 500,000 cycles

### Finishes



**99550-002**  
Satin Nickel 15



**99550-003**  
Venetian Bronze 11P



**99550-001**  
Satin Chrome 26D



**99550-004**  
Iron Black 514

FINISH AND  
**LIFETIME WARRANTY**  
MECHANICAL  
THREE YEAR  
ELECTRONIC WARRANTY

# Kwikset

19701 DaVinci, Lake Forest, CA 92610 • Kwikset.com • 1-800-327-LOCK

©2019 Spectrum Brands, Inc. Kwikset is a trademark of Spectrum Brands, Inc. Lake Forest, CA 92610 • 341544-2/19

# Kwikset

## Introducing CONTEMPORARY DEADBOLT



**Kwikset's Contemporary Deadbolt has a sleek and simple design.**

Priced affordably, this deadbolt offers achievable style while maintaining superior security.

- Featuring SmartKey Security™ - protecting against advanced break-in techniques
- Features Microban® antimicrobial finish protection\*
- ANSI/BHMA Grade 3 Certified Security & Quality
- Lifetime Mechanical Warranty

**#1 SELLING U.S. LOCK BRAND\***

\*Source: TraQline US quarterly brand unit share report, Q4 2006 through Q2 2018



## Specifications

<b>Door Prep</b>	<ul style="list-style-type: none"> <li>▪ <b>660:</b> Cross Bore 2 1/8". Edge Bore 1". Latch face 1" x 2 1/4".</li> <li>▪ <b>663:</b> Crossbore 1-5/8". Edge Bore 1". Latch Face 1" x 2-1/4".</li> </ul>
<b>Backset</b>	<ul style="list-style-type: none"> <li>▪ <b>660:</b> Adjustable latch standard.</li> <li>▪ <b>663:</b> Adjustable to 2 3/8" standard x 2 3/4" optional.</li> </ul>
<b>Door Thickness</b>	<b>660, 66:</b> 1 3/8" - 1 3/4" doors standard.
<b>Cylinder</b>	<b>660:</b> SmartKey Security™
<b>Faceplates</b>	1" x 2-1/4". Specify round corner, square corner or drive-in.
<b>Strikes</b>	1" x 2-1/4". Specify round corner or square corner. Other options available.

<b>Bolt</b>	1" throw.
<b>Door Handing</b>	Reversible for right or left-hand doors.
<b>ANSI/BHMA</b>	Grade 3 Certified
<b>ADA</b>	Interior turn piece is in compliance with the American National Standards Institute (ANSI A117.1) and the Americans with Disabilities Act (ADA).
<b>UL</b>	N/A

## Dimensions

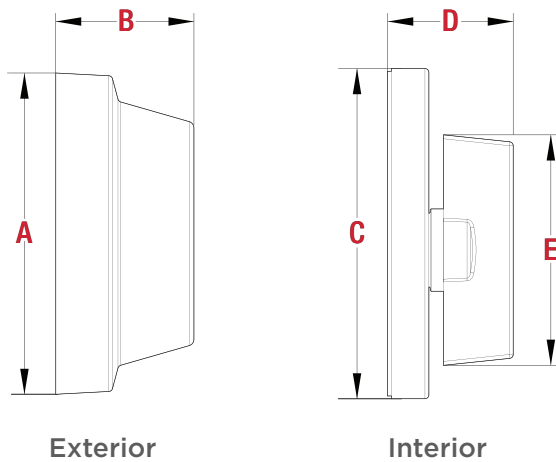

Dimensions	A	B	C	D	E
Exterior	2 7/16"	1 1/16"			
Interior			2 1/2"	3 1/32"	1 3/4"



Kwikset's SmartKey™ Security™ provides homeowners with the superior security that is resistant to a variety of advanced break-in methods.

This technology also allows homeowners to re-key their locks themselves in seconds, rendering lost or un-returned keys useless.

## Finishes



**11P**  
Venetian  
Bronze

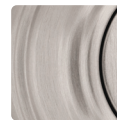

**15**  
Satin  
Nickel



**514**  
Iron  
Black



**26**  
Polished  
Chrome



**26D**  
Satin  
Chrome

# Kwikset

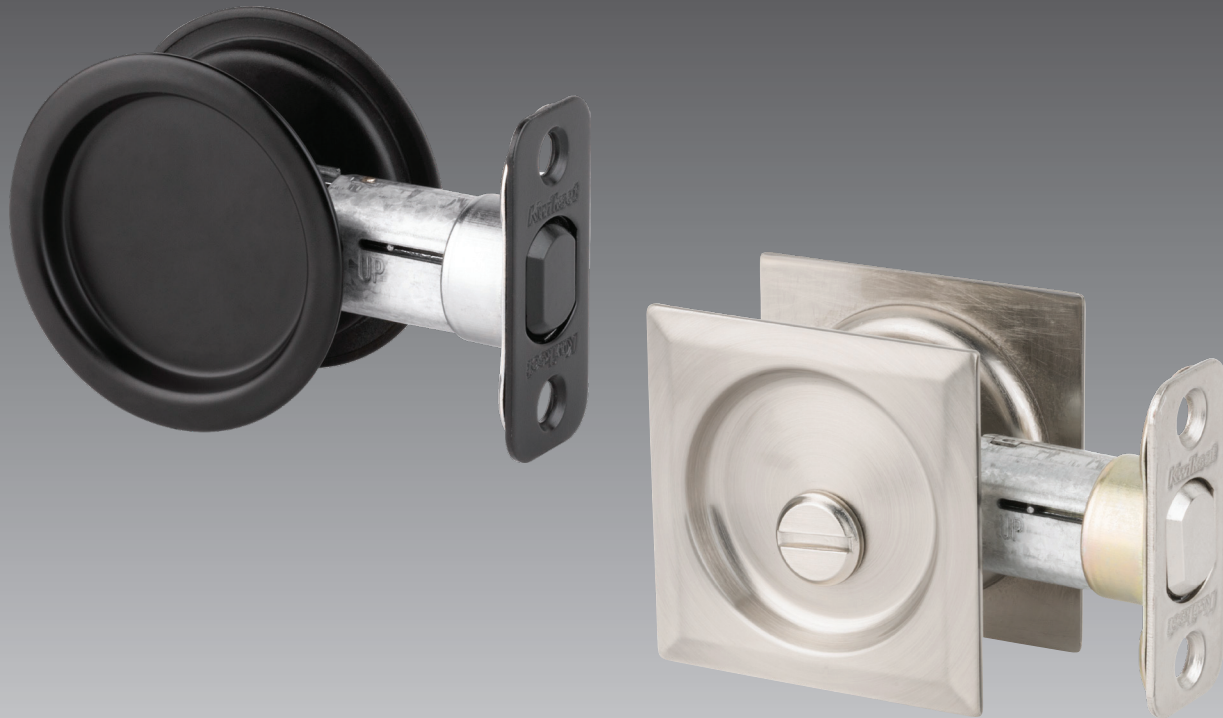

## POCKET DOOR LOCK

Kwikset's innovative pocket door locks offer traditional and contemporary styles for any sliding door.

- New contemporary square trim
- Fits standard door prep
- Push-to-pull latch for easy access
- Ideal for spaces with a concealed door like an office, bathroom, laundry room or closet door



Pocket Door Lock  
in Stainless Steel

#1 SELLING U.S. LOCK BRAND\*

\*Source: TraQline US quarterly brand unit share report, Q4 2006 through Q1 2019

372541-5/19

## Specifications

**Door Prep** Cross Bore 2-1/8". Edge Bore 1".

**Backset** 2-3/8"

**Faceplates** 1" x 2-1/4". Square or round corner.

**Strikes** 1" x 2-1/4". Square or round corner.

**Bolt** 1" throw.

**Door Handing** Reversible for right or left-handed doors.

**ANSI/BHMA** N/A

## Dimensions

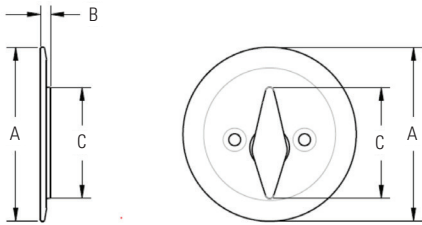

Design	A	B	C
Round	2 15/32"	1 5/32"	1 19/32"

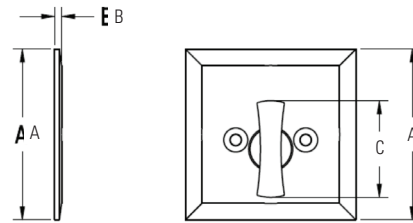

Design	A	B	C
Square	2 7/16"	1 5/32"	1 3/8"

## Finishes

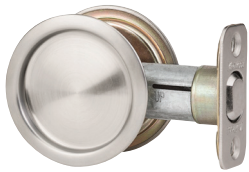

*Satin Nickel 15*

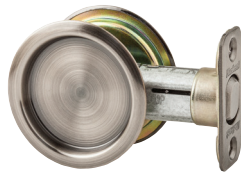

*Antique Nickel 15A*

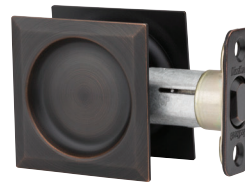

*Venetian Bronze 11P*



*Satin Nickel 15*



*Stainless Steel 32*

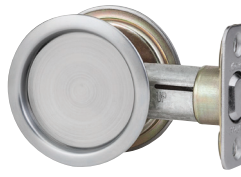

*Satin Chrome 26D*



*Polished Chrome 26*



*Satin Chrome 26D*



*Iron Black 514*

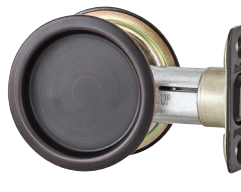

*Venetian Bronze 11P*

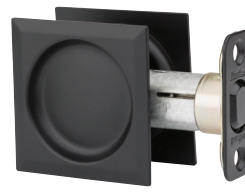

*Iron Black 514*

LIFETIME WARRANTY

**Kwikset**

19701 DaVinci, Lake Forest, CA 92610 • Kwikset.com • 1-800-327-5625

© 2019 Spectrum Brands, Inc. Kwikset is a trademark of Spectrum Brands, Inc. Lake Forest, CA 92610 • 372541-5/19

# Kwikset



## SMARTCODE 917

RESIDENTIAL ELECTRONIC LEVER

### Features

- Highest residential security rating
- 3-year battery life
- Reversible lever to fit left-hand or right-hand doors
- Lock owner can switch between three different locking modes: Auto-lock, Passage, and Disable Passage

### User Codes

- Up to 30 user access codes
- Lock owner can program a one-time user code for emergencies, which deletes after first usage
- For added convenience, lock owners can program the lock from the outside with a programming code



**#1 SELLING U.S. LOCK BRAND\***

\*Source: TraQline US quarterly brand unit share report, Q4 2006 through Q1 2019

## Specifications

<b>Function</b>	Keyed entry electronic lever
<b>Door Prep</b>	Cross Bore 2- 1/8". Edge Bore 1".
<b>Backset</b>	2 3/8" or 2 3/4"
<b>Door Thickness</b>	1 3/8" - 1 3/4"
<b>Faceplates</b>	1" x 2 1/4" round corner standard, drive in available
<b>Strikes</b>	2 1/4" full lip round corner
<b>Latch</b>	Adjustable 2 3/8" x 2 3/4"
<b>Bolt</b>	1/2" throw, dead latch
<b>Door Handing</b>	Reversible for right or left-handed doors
<b>Cylinder</b>	SmartKey Security™
<b>UL Rating</b>	20 min
<b>Temperature Range</b>	Exterior: -40F to 150F Interior: 32F to 130F
<b>Humidity</b>	Exterior: - 100% condensing Interior: 30% - 95% non-condensing

## Dimensions

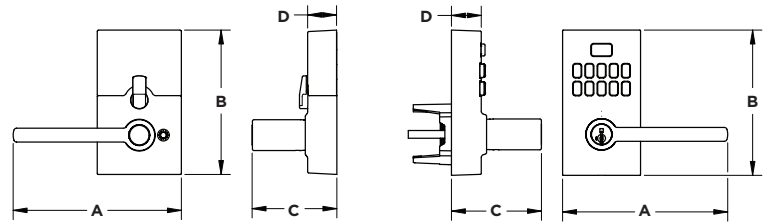

Design	A	B	C	D
Interior	5 21/32" (143.9 mm)	4 7/8" (123.5 mm)	2 27/32" (72.1 mm)	3 1/32" (24.7 mm)
Exterior	5 9/16" (141.7 mm)	4 29/32" (124.3 mm)	3 1/32" (76.7 mm)	1" (25.4 mm)

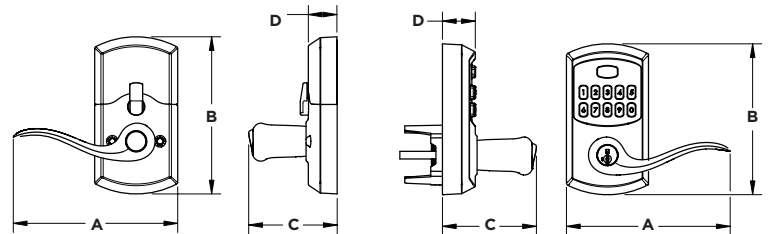

Design	A	B	C	D
Interior	5 5/8" (142.5 mm)	5 3/8" (136.2 mm)	2 29/32" (73.8 mm)	3 1/32" (24.7 mm)
Exterior	5 19/32" (142 mm)	5 5/32" (130.7 mm)	3 3/32" (78.6 mm)	1 1/8" (28.6 mm)

## Finishes



**99170-001**  
Satin Nickel 15



**99170-002**  
Venetian Bronze 11P



**99170-003**  
Satin Nickel 15



**99170-004**  
Iron Black 514



**99170-005**  
Polished Chrome 26

## Easy Installation

- Replaces existing door hardware with just a screwdriver
- No hard wiring needed
- Operates on a single 9V battery

## Innovative Security

- BHMA certified AAA. Highest residential security, durability and finish ratings
- Featuring SmartKey Security™

FINISH AND  
**LIFETIME WARRANTY**  
MECHANICAL  
ONE YEAR  
ELECTRONIC WARRANTY

# Kwikset

19701 DaVinci, Lake Forest, CA 92610 • Kwikset.com • 1-800-327-LOCK

© 2019 Spectrum Brands, Inc. Kwikset is a trademark of Spectrum Brands, Inc. Lake Forest, CA 92610 • 412640-07/19

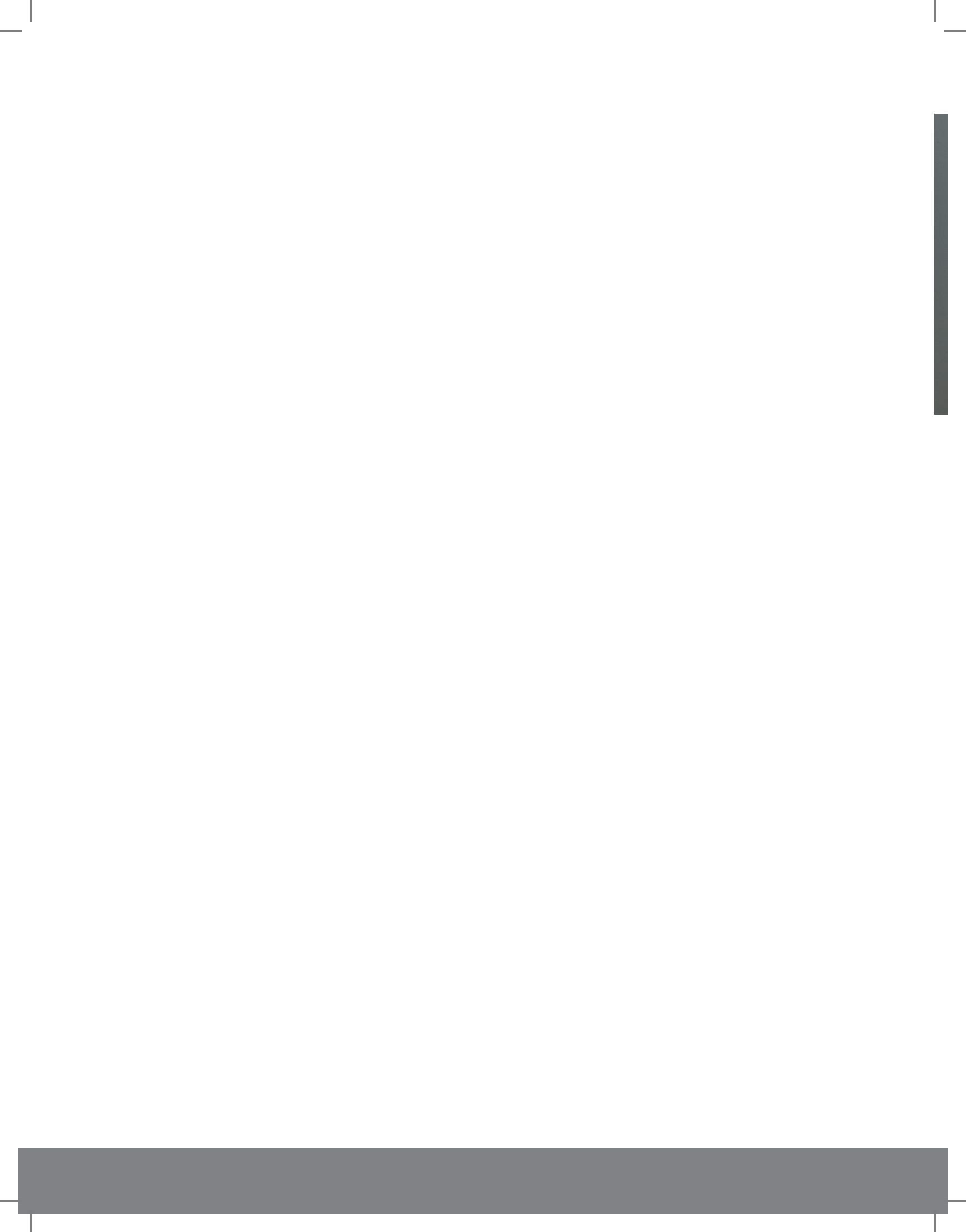



## Superior Security Features

- ANSI/BHMA Grade 1 Certified 980/985 Deadbolt
- SmartKey Security - providing superior security against advanced break-in techniques.

## Elegant Styles And Finishes

- Traditional to Contemporary Styles

## Warranty

- Lifetime Mechanical
- Lifetime Finish



Amherst®



Arlington®



Ashfield™



Austin™



Avalon™



Camino



Uptown 258  
Deadbolt



Downtown 258  
Deadbolt



Austin  
Deadbolt



Halifax  
158/159  
Deadbolt



Chelsea®



Hawthorne



Montara™



San  
Clemente



Shelburne™



Tavaris®



Vancouver



Milan  
158/159  
Deadbolt



780/ 785  
Deadbolt



980/ 985  
Deadbolt



| **Abbey®**



| **Cameron®**



| **Circa®**



| **Hancock®**



| **Pismo**



| **Laurel®**



| **Phoenix®**



| **Ashfield™**



| **Austin**



| **Avalon™**



| **Brooklane®**



| **Commonwealth®**



| **Halifax®**



| **Katara®**



| **Lido®**



| **Lisbon**



| **Milan®**

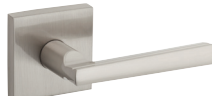

| **Montreal**



| **Pembroke™**



| **Sydney®**



| **Tustin®**



| **Vedani®**





**Amherst®**



**Vancouver\***



**Camino**



**San Clemente**



**Ashfield™**



Amherst®	Model	Function	Finish								Case		
			3	L03	5	11P	15	15A	26	26D	514	Qty	
800AT	Single Cylinder					\$310.10	\$310.10						4
800AT SMT	Single Cylinder					\$310.10	\$310.10						4
801AT	Double Cylinder					\$315.20	\$315.20						4
801AT SMT	Double Cylinder					\$315.20	\$315.20						4
802AT	Dummy					\$281.50	\$281.50						4

Vancouver	Model	Function	Finish								Case		
			3	L03	5	11P	15	15A	26	26D	514	Qty	
818VNH SMT	Single Cylinder					\$299.90	\$299.90		\$299.90		\$310.10		4
819VNH	Dummy					\$271.30	\$271.30		\$271.30		\$281.50		4

Camino	Model	Function	Finish								Case		
			3	L03	5	11P	15	15A	26	26D	514	Qty	
818CMH SMT	Single Cylinder					\$288.70	\$288.70		\$288.70	\$288.70	\$298.90		4
819CMH	Dummy					\$260.10	\$260.10		\$260.10	\$260.10	\$270.30		4
814CMH	Handle Only†					\$219.30	\$219.30		\$219.30	\$219.30	\$230.50		4

San Clemente	Model	Function	Finish								Case		
			3	L03	5	11P	15	15A	26	26D	514	Qty	
818SCE SMT	Single Cylinder					\$288.70	\$288.70		\$288.70	\$288.70	\$298.90		4
819SCE	Dummy					\$260.10	\$260.10		\$260.10	\$260.10	\$270.30		4
814SCE	Handle Only†					\$219.30	\$219.30		\$219.30	\$219.30	\$230.50		4
815SCE	Handle with Halifax Lever†					\$290.70	\$290.70		\$290.70	\$290.70	\$300.90		4

Ashfield®	Model	Function	Finish								Case		
			3	L03	5	11P	15	15A	26	26D	514	Qty	
800ADH	Single Cylinder			\$277.40		\$277.40	\$277.40				\$288.70		4
800ADH SMT	Single Cylinder			\$277.40		\$277.40	\$277.40				\$288.70		4
801ADH	Double Cylinder			\$283.60		\$283.60	\$283.60				\$293.80		4
801ADH SMT	Double Cylinder			\$283.60		\$283.60	\$283.60				\$293.80		4
802ADH	Dummy			\$248.90		\$248.90	\$248.90				\$260.10		4

**NOTE:** Handlesets ordered LIP only  
 †Denotes handleset without deadbolt



**Austin™**



**Avalon™**



**Montara™**



**Shelburne™**



Austin™	Model	Function	Finish								Case		
			3	L03	5	11P	15	15A	26	26D	514	Qty	
	800AUH SMT	Single Cylinder				\$277.40	\$277.40						4
	801AUH SMT	Double Cylinder				\$283.60	\$283.60						4
	802AUH	Dummy				\$248.90	\$248.90						4
	814AUH	Handle Only†				\$209.10	\$209.10						4

Avalon™	Model	Function	Finish								Case		
			3	L03	5	11P	15	15A	26	26D	514	Qty	
	800AVH	Single Cylinder		\$277.40	\$277.40	\$277.40	\$277.40				\$288.70		4
	800AVH SMT	Single Cylinder		\$277.40	\$277.40	\$277.40	\$277.40				\$288.70		4
	801AVH	Double Cylinder		\$283.60	\$283.60	\$283.60	\$283.60				\$293.80		4
	801AVH SMT	Double Cylinder		\$283.60	\$283.60	\$283.60	\$283.60				\$293.80		4
	802AVH	Dummy		\$248.90	\$248.90	\$248.90	\$248.90				\$260.10		4
	814AVH	Handle Only†		\$209.10		\$209.10	\$209.10						4

Montara™	Model	Function	Finish								Case		
			3	L03	5	11P	15	15A	26	26D	514	Qty	
	553MNH SMT	Single Cylinder	\$257.00			\$277.40	\$277.40						4
	554MNH SMT	Double Cylinder	\$262.10			\$283.60	\$283.60						4

Shelburne™	Model	Function	Finish								Case		
			3	L03	5	11P	15	15A	26	26D	514	Qty	
	800SE	Single Cylinder				\$261.10	\$261.10						4
	800SE SMT	Single Cylinder				\$261.10	\$261.10						4
	801SE	Double Cylinder				\$266.20	\$266.20						4
	801SE SMT	Double Cylinder				\$266.20	\$266.20						4
	802SE	Dummy				\$232.60	\$232.60						4
	814SE	Handle Only†				\$191.80	\$191.80						4

NOTE: Handlesets ordered LIP only  
 †Denotes handleset without deadbolt



**Hawthorne**



**Tavaris®**



**Prescott**



Hawthorne	Model	Function	Finish								Case		
			3	L03	5	11P	15	15A	26	26D	514	Qty	
	800HE	Single Cylinder				\$261.10	\$261.10	\$261.10				\$271.30	4
	800HE SMT	Single Cylinder				\$261.10	\$261.10	\$261.10				\$271.30	4
	801HE	Double Cylinder				\$266.20	\$266.20	\$266.20				\$276.40	4
	801HE SMT	Double Cylinder				\$266.20	\$266.20	\$266.20				\$276.40	4
	802HE	Dummy				\$232.60	\$232.60	\$232.60				\$242.80	4
	814HE	Handle Only†				\$191.80	\$191.80						4

Prescott	Model	Function	Finish								Case		
			3	L03	5	11P	15	15A	26	26D	514	Qty	
	818PTH SMT	Single Cylinder		\$261.10		\$261.10	\$261.10					\$271.30	4
	819PTH	Dummy		\$261.10		\$261.10	\$261.10					\$271.30	4
	814PTH	Handle Only		\$191.80		\$191.80	\$191.80					\$202.00	4
	815PTH	Handleset with Tustin		\$263.20		\$263.20	\$263.20						4
	815PTH	Handleset with Hancock		\$252.00		\$252.00	\$252.00						4

Tavaris®	Model	Function	Finish								Case		
			3	L03	5	11P	15	15A	26	26D	514	Qty	
	800TVH	Single Cylinder				\$261.10	\$261.10		\$261.10	\$261.10			4
	800TVH SMT	Single Cylinder				\$261.10	\$261.10		\$261.10	\$261.10			4
	801TVH	Double Cylinder				\$266.20	\$266.20		\$266.20	\$266.20			4
	801TVH SMT	Double Cylinder				\$266.20	\$266.20		\$266.20	\$266.20			4
	802TVH	Dummy				\$232.60	\$232.60		\$232.60	\$232.60			4
	814TVH	Handle Only†				\$191.80	\$191.80		\$191.80	\$191.80			4
	815TVH	Handleset† with Vedani				\$263.20	\$263.20		\$263.20	\$263.20			6
	815TVH	Handleset† with Katara				\$263.20	\$263.20		\$263.20	\$263.20			6

**NOTE:** Handlesets ordered LIP only  
 †Denotes handleset without deadbolt



**Arlington®**



**Chelsea®**



Arlington®	Model	Function	Finish								Case Qty		
			3	L03	5	11P	15	15A	26	26D		514	
	800AN	Single Cylinder		\$216.20	\$216.20	\$216.20	\$216.20	\$216.20					4
	800AN SMT	Single Cylinder		\$216.20	\$216.20	\$216.20	\$216.20	\$216.20					4
	801AN	Double Cylinder		\$221.30	\$221.30	\$221.30	\$221.30	\$221.30					4
	801AN SMT	Double Cylinder		\$221.30	\$221.30	\$221.30	\$221.30	\$221.30					4
	802AN	Dummy		\$187.70	\$187.70	\$187.70	\$187.70	\$187.70					4
	814AN	Handle Only†		\$147.90		\$147.90	\$147.90						4
	815AN	Handleset with Tustin		\$218.30		\$218.30	\$218.30						6
	815AN	Handleset with Hancock		\$207.10		\$207.10	\$207.10						6

Chelsea®	Model	Function	Finish								Case Qty		
			3	L03	5	11P	15	15A	26	26D		514	
	800CE	Single Cylinder		\$216.20	\$216.20	\$216.20	\$216.20	\$216.20	\$216.20	\$216.20			4
	800CE SMT	Single Cylinder		\$216.20	\$216.20	\$216.20	\$216.20	\$216.20	\$216.20	\$216.20			4
	801CE	Double Cylinder		\$221.30	\$221.30	\$221.30	\$221.30	\$221.30	\$221.30	\$221.30			4
	801CE SMT	Double Cylinder		\$221.30	\$221.30	\$221.30	\$221.30	\$221.30	\$221.30	\$221.30			4
	802CE	Dummy		\$187.70	\$187.70	\$187.70	\$187.70	\$187.70	\$187.70	\$187.70			4
	814CE	Handle Only†		\$147.90		\$147.90	\$147.90		\$149.90				4
	815CE	Handleset† with Tustin		\$218.30		\$218.30	\$218.30						6
	815CE	Handleset† with Hancock		\$207.10		\$207.10	\$207.10						6

**NOTE:** Handlesets ordered LIP only  
 †Denotes handleset without deadbolt



**INTERIOR PACKS FOR TRADITIONAL 800/801/802 HANDLESETS**

Model	Function	Series			
		Signature Lever & Laurel	Signature Knob	Kwikset Lever	Kwikset Knob
966	Single Cylinder	\$71.40	\$59.20	\$64.30	\$52.00
967	Double Cylinder	\$94.90	\$82.60	\$82.60	\$70.40
967 SMT	Double Cylinder	\$94.90	\$82.60	\$82.60	\$70.40
968	Dummy	\$59.20	\$47.90	\$54.10	\$41.80

Handleset Interior Pack Finish Options		3	L03	5	11P	15	15A	26	26D	514	Qty
<b>Kwikset</b> <i>Signature Series</i>	Abbey Knob	•							•		4
	Ashfield Lever				•	•		•		•	12
	Avalon Lever				•	•					12
	Brooklane Lever				•	•	•				4
	Cameron Knob	•			•	•					4
	Circa Knob				•	•			•		4
	Commonwealth Lever	•		•	•	•	•		•	•	4
	Halifax Lever				•	•		•	•	•	12
	Hancock Knob	•		•	•	•	•	•	•	•	4
	Laurel Knob				•	•		•		•	4
	Lido Lever	•		•	•	•	•		•		4
	Lisbon Lever				•	•		•	•	•	12
	Milan Lever				•	•		•	•	•	12
	Montreal Lever				•	•		•	•	•	12
	Pembroke Lever				•	•	•	•		•	12
	Phoenix Knob			•	•	•					4
	Pismo Knob				•	•		•	•	•	4
	Sydney Lever				•	•		•	•	•	12
<b>Kwikset</b>	Tustin Lever	•		•	•	•	•	•	•	○	12
	Aliso Knob	•			•	•		•			12
	Balboa Lever	•		•	•	•		•	•		4
	Cove Knob	•		•	•	•		•	•		4
	Delta Lever	•		•	•	•	•	•	•		12
	Dorian Lever	•		•	•	•	•	•	•		12
	Ladera Lever				•	•		•	•		12
	Polo Knob	•		•	•	•	•	•	•		4
	Tylo Knob	•		•		•		•	•		12

**AUSTIN INTERIOR PACKS**

Model	Function	Series			
		Signature Lever	Signature Knob	Kwikset Lever	Kwikset Knob
966 AUL	Single Cylinder	\$71.40			
967 AUL SMT	Double Cylinder	\$94.90			
968 AUL	Dummy	\$59.20			

**CAMINO, SAN CLEMENTE, PRESCOTT AND VANCOUVER INTERIOR PACKS**

Model	Function	Series			
		Signature Lever	Signature Knob	Kwikset Lever	Kwikset Knob
971	Single Cylinder	\$71.40	\$59.20		
973	Dummy	\$59.20	\$47.90		

Handleset Interior Pack Finish Options		3	L03	5	11P	15	15A	26	26D	514	Qty
<b>Kwikset</b> <i>Signature Series</i>	Halifax Lever				•	•		•	•	•	4
	Katara Lever					•		•			4
	Lisbon Lever				•	•		•	•	•	4
	Milan Lever				•	•		•	•	•	4
	Montreal Lever				•	•		•	•	•	4
	Pismo Knob				•	•		•	•	•	4
	Sydney Lever				•	•		•	•	•	4
	Vedani Lever				•	•		•	•		4

Note: Square (SQT) or Round (RDT) rose options available

○ Only available in 966 Function



**Low Profile Interior Packs**

Model	Function	Series			
		Signature Lever	Signature Knob	Kwikset Lever	Kwikset Knob
971	Single Cylinder	\$71.4	\$59.20		
973	Dummy	\$59.20	\$47.90		

Handleset Interior Pack Finish Options	3	L03	5	11P	15	15A	26	26D	514	Qty
<b>Kwikset</b> Tustin Lever	•			•	•				•	4
<i>Signature Series</i> Hancock Knob	•			•	•				•	4

Note: Only square (SQF) rose option available

**CAMINO, SAN CLEMENTE, AND VANCOUVER FULL SQUARE INTERIOR PACKS**

Model	Function	Series			
		Signature Lever	Signature Knob	Kwikset Lever	Kwikset Knob
971 SQF	Single Cylinder	\$81.60			
973 SQF	Dummy	\$69.40			

Handleset Interior Pack Finish Options	3	L03	5	11P	15	15A	26	26D	514	Qty
<b>Kwikset</b> Halifax Lever				•	•		•		•	4
<i>Signature Series</i>										

Note: Only square (SQF) rose option available

**CONTEMPORARY INTERIOR PACKS**

Model	Function	Series			
		Signature Lever	Signature Knob	Kwikset Lever	Kwikset Knob
974	Single Cylinder	\$71.40			
976 SMT	Double Cylinder	\$94.90			
977	Dummy	\$59.20			

Handleset Interior Pack Finish Options	3	L03	5	11P	15	15A	26	26D	514	Qty
<b>Kwikset</b> Katara Lever					•		•			12
<i>Signature Series</i> Vedani Lever				•	•	Signature Knob	•	Kwikset Lever		12

NOTE: 966, 968, 974 and 977 are not impacted by SmartKey Security cylinder.

**MONTARA INTERIOR PACKS**

Model	Function	Series			
		Signature Lever	Signature Knob	Kwikset Lever	Kwikset Knob
978	Single Cylinder	\$75.50	\$62.20		\$54.10
979	Double Cylinder	\$98.90	\$85.70		\$72.40

Montara Handleset Interior Pack Finish Options	3	L03	5	11P	15	15A	26	26D	514	Qty
<b>Kwikset</b> Cameron Knob	•			•	•					12
<i>Signature Series</i> Circa Knob				•	•					12
Juno Knob	•			•	•					12
Lido Lever	•			•	•					12
Tustin Lever	•			•	•					12
<b>Kwikset</b> Cove Knob	•			•	•					12
Polo Knob	•			•	•					12
Tylo Knob	•									12

<b>Ashfield™</b>	<b>Model</b>	<b>Function</b>	<b>Finish</b>								<b>Case</b>	
			<b>3</b>	<b>L03</b>	<b>5</b>	<b>11P</b>	<b>15</b>	<b>15A</b>	<b>26</b>	<b>26D</b>	<b>514</b>	<b>Qty</b>
	720ADL	Hall/Closet				\$68.30	\$68.30		\$68.30		\$71.40	12
	725ADL	Hall/Closet UL				\$74.30	\$74.30		\$74.30		\$77.40	12
	730ADL	Bed/Bath				\$71.40	\$71.40		\$71.40		\$74.50	12
	735ADL	Bed/Bath UL				\$77.40	\$77.40		\$77.40		\$80.50	12
	740ADL SMT	Entry				\$114.20	\$114.20		\$114.20		\$117.30	12
	745ADL SMT	Entry UL				\$120.20	\$120.20		\$120.20		\$123.30	12
	788ADL	Half Dummy				\$33.70	\$33.70		\$33.70		\$35.70	20

<b>Austin</b>	<b>Model</b>	<b>Function</b>	<b>Finish</b>								<b>Case</b>	
			<b>3</b>	<b>L03</b>	<b>5</b>	<b>11P</b>	<b>15</b>	<b>15A</b>	<b>26</b>	<b>26D</b>	<b>514</b>	<b>Qty</b>
	720AUL	Hall/Closet				\$68.30	\$68.30					12
	730AUL	Bed/Bath				\$71.40	\$71.40					12
	740AUL SMT	Entry				\$114.20	\$114.20					12
	788AUL	Half Dummy				\$33.70	\$33.70					20

<b>Avalon™</b>	<b>Model</b>	<b>Function</b>	<b>Finish</b>								<b>Case</b>	
			<b>3</b>	<b>L03</b>	<b>5</b>	<b>11P</b>	<b>15</b>	<b>15A</b>	<b>26</b>	<b>26D</b>	<b>514</b>	<b>Qty</b>
	720AVL	Hall/Closet				\$68.30	\$68.30					12
	725AVL	Hall/Closet UL				\$74.30	\$74.30					12
	730AVL	Bed/Bath				\$71.40	\$71.40					12
	735AVL	Bed/Bath UL				\$77.40	\$77.40					12
	740AVL SMT	Entry				\$114.20	\$114.20					12
	745AVL SMT	Entry UL				\$120.20	\$120.20					12
	788AVL	Half Dummy				\$33.70	\$33.70					20

<b>Pembroke™</b>	<b>Model</b>	<b>Function</b>	<b>Finish</b>								<b>Case</b>	
			<b>3</b>	<b>L03</b>	<b>5</b>	<b>11P</b>	<b>15</b>	<b>15A</b>	<b>26</b>	<b>26D</b>	<b>514</b>	<b>Qty</b>
	720PML	Hall/Closet				\$68.30	\$68.30	\$68.30	\$68.30		\$71.40	12
	725PML	Hall/Closet UL				\$74.30	\$74.30	\$74.30	\$74.30		\$77.40	12
	730PML	Bed/Bath				\$71.40	\$71.40	\$71.40	\$71.40		\$74.50	12
	735PML	Bed/Bath UL				\$77.40	\$77.40	\$77.40	\$77.40		\$80.50	12
	740PML SMT	Entry				\$114.20	\$114.20	\$114.20	\$114.20		\$117.30	12
	745PML SMT	Entry UL				\$120.20	\$120.20	\$120.20	\$120.20		\$123.30	12
	788PML	Half Dummy				\$33.70	\$33.70	\$33.70	\$33.70		\$35.70	20



**Halifax™**

Model	Function	Finish										Case Qty
		3	L03	5	11P	15	15A	26	26D	514		
 154HFL	Hall/Closet				\$60.20	\$60.20		\$60.20	\$60.20	\$63.20	12	
725HFL	Hall/Closet UL				\$66.20	\$66.20		\$66.20	\$66.20	\$69.20	12	
155HFL	Bed/Bath				\$63.20	\$63.20		\$63.20	\$63.20	\$67.30	12	
156HFL SMT	Entry				\$107.10	\$107.10		\$107.10	\$107.10	\$110.20	12	
745HFL SMT	Entry UL				\$113.10	\$113.10		\$113.10	\$113.10	\$116.20	12	
157HFL	Half Dummy				\$30.60	\$30.60		\$30.60	\$30.60	\$31.60	20	

**NOTE:** Can be ordered with (RDT) Round Rose or (SQT) Square Rose option. Example - 154HFL RDT 11P

**Katara®**

Model	Function	Finish										Case Qty
		3	L03	5	11P	15	15A	26	26D	514		
 720KTL	Hall/Closet					\$60.20		\$60.20			12	
725KTL	Hall/Closet UL					\$66.20		\$66.20			12	
730KTL	Bed/Bath					\$63.20		\$63.20			12	
735KTL	Bed/Bath UL					\$69.20		\$69.20			12	
740KTL SMT	Entry					\$107.10		\$107.10			12	
745KTL SMT	Entry UL					\$113.10		\$113.10			12	
788KTL	Half Dummy					\$30.60		\$30.60			20	

**Lisbon**

Model	Function	Finish										Case Qty
		3	L03	5	11P	15	15A	26	26D	514		
 154LSL	Hall/Closet				\$60.20	\$60.20		\$60.20	\$60.20	\$63.20	12	
155LSL	Bed/Bath				\$63.20	\$63.20		\$63.20	\$63.20	\$67.30	12	
156LSL SMT	Entry				\$107.10	\$107.10		\$107.10	\$107.10	\$110.20	12	
157LSL	Half Dummy				\$30.60	\$30.60		\$30.60	\$30.60	\$31.60	20	

**NOTE:** Can be ordered with (RDT) Round Rose or (SQT) Square Rose option. Example - 154LSL RDT 11P

**Milan™**

Model	Function	Finish										Case Qty
		3	L03	5	11P	15	15A	26	26D	514		
 154MIL	Hall/Closet				\$60.20	\$60.20		\$60.20	\$60.20	\$63.20	12	
155MIL	Bed/Bath				\$63.20	\$63.20		\$63.20	\$63.20	\$67.30	12	
156MIL SMT	Entry				\$107.10	\$107.10		\$107.10	\$107.10	\$110.20	12	
157MIL	Half Dummy				\$30.60	\$30.60		\$30.60	\$30.60	\$31.60	20	

**NOTE:** Can be ordered with (RDT) Round Rose or (SQT) Square Rose option. Example - 154MIL SQT 11P

**Montreal**

Model	Function	Finish										Case Qty
		3	L03	5	11P	15	15A	26	26D	514		
 154MRL	Hall/Closet				\$60.20	\$60.20		\$60.20	\$60.20	\$63.20	12	
155MRL	Bed/Bath				\$63.20	\$63.20		\$63.20	\$63.20	\$67.30	12	
156MRL SMT	Entry				\$107.10	\$107.10		\$107.10	\$107.10	\$110.20	12	
157MRL	Half Dummy				\$30.60	\$30.60		\$30.60	\$30.60	\$31.60	20	

**NOTE:** Can be ordered with (RDT) Round Rose or (SQT) Square Rose option. Example - 154MRL RDT 11P

**Sydney®**

Model	Function	Finish										Case Qty
		3	L03	5	11P	15	15A	26	26D	514		
 154SYL	Hall/Closet				\$60.20	\$60.20		\$60.20	\$60.20	\$63.20	12	
155SYL	Bed/Bath				\$63.20	\$63.20		\$63.20	\$63.20	\$67.30	12	
156SYL SMT	Entry				\$107.10	\$107.10		\$107.10	\$107.10	\$110.20	12	
157SYL	Half Dummy				\$30.60	\$30.60		\$30.60	\$30.60	\$31.60	20	

**NOTE:** Can be ordered with (RDT) Round Rose or (SQT) Square Rose option. Example - 154SYL RDT 11P

**Vedani®**

Model	Function	Finish										Case Qty
		3	L03	5	11P	15	15A	26	26D	514		
 720VDL	Hall/Closet				\$60.20	\$60.20		\$60.20	\$60.20		12	
725VDL UL	Hall/Closet UL				\$66.20	\$66.20		\$66.20	\$66.20		12	
730VDL	Bed/Bath				\$63.20	\$63.20		\$63.20	\$63.20		12	
735VDL UL	Bed/Bath UL				\$69.20	\$69.20		\$69.20	\$69.20		12	
740VDL SMT	Entry				\$107.10	\$107.10		\$107.10	\$107.10		12	
745VDL SMT	Entry UL				\$113.10	\$113.10		\$113.10	\$113.10		12	
788VDL	Half Dummy				\$30.60	\$30.60		\$30.60	\$30.60		20	

**NOTE:** Can be ordered with (RDT) Round Rose or (SQT) Square Rose option. Example - 720VDL RDT 11P





**Brooklane®**

Model	Function	Finish									Case Qty
		3	L03	5	11P	15	15A	26	26D	514	
720BRL	Hall/Closet				\$60.20	\$60.20	\$60.20				12
725BRL	Hall/Closet UL				\$66.20	\$66.20	\$66.20				12
730BRL	Bed/Bath				\$63.20	\$63.20	\$63.20				12
735BRL	Bed/Bath UL				\$69.20	\$69.20	\$69.20				12
740BRL SMT	Entry				\$107.10	\$107.10	\$107.10				12
745BRL SMT	Entry UL				\$113.10	\$113.10	\$113.10				12
788BRL	Half Dummy				\$30.60	\$30.60	\$30.60				20

**Commonwealth®**

Model	Function	Finish									Case Qty
		3	L03	5	11P	15	15A	26	26D	514	
720CHL	Hall/Closet	\$55.10	\$60.20	\$60.20	\$60.20	\$60.20	\$60.20		\$60.20	\$63.20	12
725CHL	Hall/Closet UL	\$61.10	\$66.20	\$66.20	\$66.20	\$66.20	\$66.20		\$66.20	\$69.20	12
730CHL	Bed/Bath	\$58.10		\$63.20	\$63.20	\$63.20	\$63.20		\$63.20	\$67.30	12
735CHL	Bed/Bath UL	\$64.10		\$69.20	\$69.20	\$69.20	\$69.20		\$69.20	\$73.30	12
740CHL	Entry	\$102.00	\$107.10	\$107.10	\$107.10	\$107.10	\$107.10		\$107.10	\$110.20	12
740CHL SMT	Entry	\$102.00	\$107.10	\$107.10	\$107.10	\$107.10	\$107.10		\$107.10	\$110.20	12
745CHL	Entry UL	\$108.00	\$113.10	\$113.10	\$113.10	\$113.10	\$113.10		\$113.10	\$116.20	12
745CHL SMT	Entry UL	\$108.00	\$113.10	\$113.10	\$113.10	\$113.10	\$113.10		\$113.10	\$116.20	12
788CHL	Half Dummy	\$27.50		\$30.60	\$30.60	\$30.60	\$30.60		\$30.60	\$31.60	20

**Lido®**

Model	Function	Finish									Case Qty
		3	L03	5	11P	15	15A	26	26D	514	
720LL	Hall/Closet	\$45.90		\$51.00	\$51.00	\$51.00	\$51.00		\$51.00		20
725LL	Hall/Closet UL	\$51.90		\$57.00	\$57.00	\$57.00	\$57.00		\$57.00		20
730LL	Bed/Bath	\$49.00		\$54.10	\$54.10	\$54.10	\$54.10		\$54.10		20
735LL	Bed/Bath UL	\$55.00		\$60.10	\$60.10	\$60.10	\$60.10		\$60.10		20
740LL SMT	Entry	\$71.40		\$76.50	\$76.50	\$76.50	\$76.50		\$76.50		20
741LL SMT	Entry, Free Interior	\$76.50		\$81.60	\$81.60	\$81.60	\$81.60		\$81.60		20
745LL SMT	Entry UL	\$77.40		\$82.50	\$82.50	\$82.50	\$82.50		\$82.50		20
746LL SMT	Entry, Free Interior UL	\$82.50		\$87.60	\$87.60	\$87.60	\$87.60		\$87.60		20
750LL SMT	Vestibule	\$76.50		\$81.60	\$81.60	\$81.60	\$81.60		\$81.60		20
755LL SMT	Vestibule UL	\$82.50		\$87.60	\$87.60	\$87.60	\$87.60		\$87.60		20
788LL	Half Dummy	\$22.40		\$25.50	\$25.50	\$25.50	\$25.50		\$25.50		20

**Tustin™**

Model	Function	Finish									Case Qty
		3	L03	5	11P	15	15A	26	26D	514	
720TNL	Hall/Closet	\$45.90		\$51.00	\$51.00	\$51.00	\$51.00	\$51.00	\$51.00	\$54.10	20
725TNL	Hall/Closet UL	\$51.90		\$57.00	\$57.00	\$57.00	\$57.00	\$57.00	\$57.00	\$60.20	20
730TNL	Bed/Bath	\$49.00		\$54.10	\$54.10	\$54.10	\$54.10	\$54.10	\$54.10	\$57.10	20
735TNL	Bed/Bath UL	\$55.00		\$60.10	\$60.10	\$60.10	\$60.10	\$60.10	\$60.10		20
740TNL	Entry			\$76.50	\$76.50	\$76.50	\$76.50	\$76.50	\$76.50		20
740TNL SMT	Entry	\$71.40		\$76.50	\$76.50	\$76.50	\$76.50	\$76.50	\$76.50	\$79.60	20
741TNL	Entry, Free Interior	\$76.50		\$81.60	\$81.60	\$81.60	\$81.60	\$81.60	\$81.60		20
741TNL SMT	Entry, Free Interior	\$76.50		\$81.60	\$81.60	\$81.60	\$81.60	\$81.60	\$81.60		20
745TNL	Entry UL	\$77.40		\$82.50	\$82.50	\$82.50	\$82.50	\$82.50	\$82.50		20
745TNL SMT	Entry UL	\$77.40		\$82.50	\$82.50	\$82.50	\$82.50	\$82.50	\$82.50		20
746TNL	Entry, Free Interior UL	\$82.50		\$87.60	\$87.60	\$87.60	\$87.60	\$87.60	\$87.60		20
746TNL SMT	Entry, Free Interior UL	\$82.50		\$87.60	\$87.60	\$87.60	\$87.60	\$87.60	\$87.60		20
750TNL	Vestibule	\$76.50		\$81.60	\$81.60	\$81.60	\$81.60	\$81.60	\$81.60		20
750TNL SMT	Vestibule	\$76.50		\$81.60	\$81.60	\$81.60	\$81.60	\$81.60	\$81.60		20
755TNL	Vestibule UL	\$82.50		\$87.60	\$87.60	\$87.60	\$87.60	\$87.60	\$87.60		20
755TNL SMT	Vestibule UL	\$82.50		\$87.60	\$87.60	\$87.60	\$87.60	\$87.60	\$87.60		20
788TNL	Half Dummy	\$22.40		\$25.50	\$25.50	\$25.50	\$25.50	\$25.50	\$25.50	\$27.50	20



**Laurel®**

Model	Function	Finish										Case Qty
		3	L03	5	11P	15	15A	26	26D	514		
720L	Hall/Closet				\$54.10	\$54.10		\$54.10		\$57.10		12
730L	Bed/Bath				\$57.10	\$57.10		\$57.10		\$60.20		12
740L SMT	Entry				\$80.60	\$80.60		\$80.60		\$83.60		12
788L	Half Dummy				\$27.50	\$27.50		\$27.50		\$28.60		20

**Pismo**

Model	Function	Finish										Case Qty
		11P	15	26	26D	514	11Px15	11Px26	15x26	514x26		
720PSK	Hall/Closet	\$40.80	\$40.80	\$40.80	\$40.80	\$43.90	\$40.80	\$40.80	\$40.80	\$40.80	\$43.90	12
725PSK	Hall/Closet UL	\$46.80	\$46.80	\$46.80	\$46.80	\$49.90	\$46.80	\$46.80	\$46.80	\$46.80	\$49.90	12
730PSK	Bed/Bath	\$43.90	\$43.90	\$43.90	\$43.90	\$46.90	\$43.90	\$43.90	\$43.90	\$43.90	\$46.90	12
740PSK SMT	Entry	\$67.30	\$67.30	\$67.30	\$67.30	\$70.40	\$67.30	\$67.30	\$67.30	\$67.30	\$70.40	12
788PSK	Half Dummy	\$20.40	\$20.40	\$20.40	\$20.40	\$21.40						20

**NOTE:** Can be ordered with (RDT) Round Rose or (SQT) Square Rose option. Example - 720PSK RDT 514

**Circa®**

Model	Function	Finish										Case Qty
		3	L03	5	11P	15	15A	26	26D	514		
720CA	Hall/Closet				\$35.70	\$35.70			\$35.70		12	
725CA	Hall/Closet UL				\$41.70	\$41.70			\$41.70		12	
730CA	Bed/Bath				\$38.80	\$38.80			\$38.80		12	
735CA	Bed/Bath UL				\$44.80	\$44.80			\$44.80		12	
740CA SMT	Entry				\$62.20	\$62.20			\$62.20		12	
741CA SMT	Entry, Free Interior				\$68.30				\$68.30		12	
745CA SMT	Entry UL				\$68.20	\$68.20			\$68.20		12	
746CA SMT	Entry, Free Interior UL				\$74.30				\$74.30		12	
750CA SMT	Vestibule				\$68.30				\$68.30		12	
755CA	Vestibule UL				\$74.30				\$74.30		12	
788CA	Half Dummy				\$18.40	\$18.40			\$18.40		20	

**Hancock®**

Model	Function	Finish										Case Qty
		3	L03	5	11P	15	15A	26	26D	514		
720H	Hall/Closet	\$30.60	\$35.70	\$35.70	\$35.70	\$35.70	\$35.70	\$35.70	\$35.70	\$38.80		12
725H	Hall/Closet UL	\$36.60	\$41.70	\$41.70	\$41.70	\$41.70	\$41.70	\$41.70	\$41.70	\$44.80		12
730H	Bed/Bath	\$33.70		\$38.80	\$38.80	\$38.80	\$38.80	\$38.80	\$38.80	\$42.80		12
735H	Bed/Bath UL	\$39.70		\$44.80	\$44.80	\$44.80	\$44.80	\$44.80	\$44.80	\$48.80		12
740H	Entry	\$57.10	\$62.20	\$62.20	\$62.20	\$62.20	\$62.20	\$62.20	\$62.20	\$65.30		12
740H SMT	Entry	\$57.10	\$62.20	\$62.20	\$62.20	\$62.20	\$62.20	\$62.20	\$62.20	\$65.30		12
741H	Entry, Free Interior	\$62.20	\$68.30	\$68.30	\$68.30	\$68.30	\$68.30	\$68.30	\$68.30	\$71.40		12
741H SMT	Entry, Free Interior	\$62.20	\$68.30	\$68.30	\$68.30	\$68.30	\$68.30	\$68.30	\$68.30	\$71.40		12
745H	Entry UL	\$63.10	\$68.20	\$68.20	\$68.20	\$68.20	\$68.20	\$68.20	\$68.20	\$71.30		12
745H SMT	Entry UL	\$63.10	\$68.20	\$68.20	\$68.20	\$68.20	\$68.20	\$68.20	\$68.20	\$71.30		12
746H	Entry, Free Interior UL	\$68.20	\$74.30	\$74.30	\$74.30	\$74.30	\$74.30	\$74.30	\$74.30			12
746H SMT	Entry, Free Interior UL	\$68.20	\$74.30	\$74.30	\$74.30	\$74.30	\$74.30	\$74.30	\$74.30			12
750H	Vestibule	\$62.20	\$68.30	\$68.30	\$68.30	\$68.30	\$68.30	\$68.30	\$68.30	\$71.40		12
750H SMT	Vestibule	\$62.20	\$68.30	\$68.30	\$68.30	\$68.30	\$68.30	\$68.30	\$68.30	\$71.40		12
755H	Vestibule UL	\$68.20	\$74.30	\$74.30	\$74.30	\$74.30	\$74.30	\$74.30	\$74.30	\$77.40		12
755H SMT	Vestibule UL	\$74.20	\$80.30	\$80.30	\$80.30	\$80.30	\$80.30	\$80.30	\$80.30	\$83.40		12
788H	Half Dummy	\$15.30	\$18.40	\$18.40	\$18.40	\$18.40	\$18.40	\$18.40	\$18.40	\$19.40		20

**Phoenix®**

Model	Function	Finish										Case Qty
		3	L03	5	11P	15	15A	26	26D	514		
720PE	Hall/Closet			\$35.70	\$35.70	\$35.70						12
730PE	Bed/Bath			\$38.80	\$38.80	\$38.80						12
740PE SMT	Entry			\$62.20	\$62.20	\$62.20						12
788PE	Half Dummy			\$18.40	\$18.40	\$18.40						20



**Abbey®**



Model	Function	Finish										Case Qty
		3	L03	5	11P	15	15A	26	26D	514		
720A	Hall/Closet	\$28.60									\$33.70	12
725A	Hall/Closet UL	\$34.60									\$39.70	12
730A	Bed/Bath	\$31.60									\$36.70	12
735A	Bed/Bath UL	\$37.60									\$43.70	12
740A	Entry	\$55.10									\$60.20	12
740A SMT	Entry	\$55.10									\$60.20	12
741A	Entry, Free Interior	\$60.20									\$65.30	12
741A SMT	Entry, Free Interior	\$60.20									\$65.30	12
745A	Entry UL	\$61.10									\$66.20	12
745A SMT	Entry UL	\$61.10									\$66.20	12
746A	Entry, Free Interior UL	\$66.20									\$71.30	12
746A SMT	Entry, Free Interior UL	\$66.20									\$71.30	12
750A	Vestibule	\$60.20									\$65.30	12
750A SMT	Vestibule	\$60.20									\$65.30	12
755A	Vestibule UL	\$66.20									\$71.30	12
755A SMT	Vestibule UL	\$66.20									\$71.30	12
788A	Half Dummy	\$14.30									\$17.30	20

**Cameron®**



Model	Function	Finish										Case Qty
		3	L03	5	11P	15	15A	26	26D	514		
720CN	Hall/Closet	\$28.60			\$33.70	\$33.70						30
730CN	Bed/Bath	\$31.60			\$36.70	\$36.70						30
740CN	Entry	\$55.10			\$60.20	\$60.20						30
740CN SMT	Entry	\$55.10			\$60.20	\$60.20						30
741CN	Entry, Free Interior	\$60.20			\$65.30	\$65.30						30
741CN SMT	Entry, Free Interior	\$60.20			\$65.30	\$65.30						30
750CN	Vestibule	\$60.20			\$65.30	\$65.30						30
750CN SMT	Vestibule	\$60.20			\$65.30	\$65.30						30
788CN	Half Dummy	\$14.30			\$17.30	\$17.30						20



**980/985**



Model	Function	Finish										Case Qty
		3	L03	5	11P	15	15A	26	26D	514		
980	Single Cylinder		\$74.50	\$74.50	\$74.50	\$74.50					\$77.50	12
980 SMT	Single Cylinder		\$74.50	\$74.50	\$74.50	\$74.50					\$77.50	12
982	Single Cylinder UL		\$80.50	\$80.50	\$80.50	\$80.50					\$83.50	12
982 SMT	Single Cylinder UL		\$80.50	\$80.50	\$80.50	\$80.50					\$83.50	12
984	Double Cylinder UL		\$107.00	\$107.00	\$107.00	\$107.00					\$110.00	12
984 SMT	Double Cylinder UL		\$107.00	\$107.00	\$107.00	\$107.00					\$110.00	12
985	Double Cylinder		\$101.00	\$101.00	\$101.00	\$101.00					\$104.00	12
985 SMT	Double Cylinder		\$101.00	\$101.00	\$101.00	\$101.00					\$104.00	12

**Uptown Deadbolt**



Model	Function	Function										Case Qty
		3	L03	5	11P	15	15A	26	26D	514		
258 RDT SMT	Single Cylinder				\$74.50	\$74.50		\$74.50	\$74.50	\$77.50		12

**Downtown Deadbolt**



Model	Function	Function										Case Qty
		3	L03	5	11P	15	15A	26	26D	514		
258 SQT SMT	Single Cylinder				\$74.50	\$74.50		\$74.50	\$74.50	\$77.50		12

**Austin Deadbolt**



Model	Function	Function										Case Qty
		3	L03	5	11P	15	15A	26	26D	514		
980AUD SMT	Single Cylinder				\$74.50	\$74.50						12
985AUD SMT	Double Cylinder				\$101.00	\$101.00						12

**780/785**



Model	Function	Finish										Case Qty
		3	L03	5	11P	15	15A	26	26D	514		
780	Single Cylinder	\$55.10	\$63.20	\$63.20	\$63.20	\$63.20	\$63.20	\$63.20	\$63.20	\$63.20		12
780 SMT	Single Cylinder	\$55.10	\$63.20	\$63.20	\$63.20	\$63.20	\$63.20	\$63.20	\$63.20	\$63.20		12
782	Single Cylinder UL	\$61.10	\$69.20	\$69.20	\$69.20	\$69.20	\$69.20	\$69.20	\$69.20	\$69.20		12
782 SMT	Single Cylinder UL	\$61.10	\$69.20	\$69.20	\$69.20	\$69.20	\$69.20	\$69.20	\$69.20	\$69.20		12
784	Double Cylinder UL	\$87.60	\$95.80	\$95.80	\$95.80	\$95.80	\$95.80	\$95.80	\$95.80	\$95.80		12
784 SMT	Double Cylinder UL	\$87.60	\$95.80	\$95.80	\$95.80	\$95.80	\$95.80	\$95.80	\$95.80	\$95.80		12
785	Double Cylinder	\$81.60	\$89.80	\$89.80	\$89.80	\$89.80	\$89.80	\$89.80	\$89.80	\$89.80		12
785 SMT	Double Cylinder	\$81.60	\$89.80	\$89.80	\$89.80	\$89.80	\$89.80	\$89.80	\$89.80	\$89.80		12

**Halifax Deadbolt**



Model	Function	Function										Case Qty
		3	L03	5	11P	15	15A	26	26D	514		
158 SQT	Single Cylinder				\$63.20	\$63.20		\$63.20	\$63.20	\$67.30		12
158 SQT SMT	Single Cylinder				\$63.20	\$63.20		\$63.20	\$63.20	\$67.30		12
982 SQT	Single Cylinder UL				\$69.20	\$69.20		\$69.20	\$69.20	\$73.30		12
982 SQT SMT	Single Cylinder UL				\$69.20	\$69.20		\$69.20	\$69.20	\$73.30		12
159 SQT	Double Cylinder				\$89.80	\$89.80		\$89.80	\$89.80	\$93.80		12
159 SQT SMT	Double Cylinder				\$89.80	\$89.80		\$89.80	\$89.80	\$93.80		12

**Milan Deadbolt**



Model	Function	Function										Case Qty
		3	L03	5	11P	15	15A	26	26D	514		
158 RDT	Single Cylinder				\$63.20	\$63.20		\$63.20	\$63.20	\$67.30		12
158 RDT SMT	Single Cylinder				\$63.20	\$63.20		\$63.20	\$63.20	\$67.30		12
982 RDT	Single Cylinder UL				\$69.20	\$69.20		\$69.20	\$69.20	\$73.30		12
982 RDT SMT	Single Cylinder UL				\$69.20	\$69.20		\$69.20	\$69.20	\$73.30		12
159 RDT	Double Cylinder				\$89.80	\$89.80		\$89.80	\$89.80	\$93.80		12
159 RDT SMT	Double Cylinder				\$89.80	\$89.80		\$89.80	\$89.80	\$93.80		12

**Gatelatch**



Model	Function	Finish										Case Qty
		3	L03	5	11P	15	15A	26	26D	514		
598 SMT	Single Cylinder	\$78.50		\$86.70		\$86.70				\$86.70		12
599	Double Cylinder	\$105.10		\$113.20		\$113.20				\$113.20		12
599 SMT	Double Cylinder	\$105.10		\$113.20		\$113.20				\$113.20		12

**KWIKSET SIGNATURE SERIES HANDLESETS**

Door Prep	Deadbolt: Cross Bore 2-1/8" or 1-1/2". Edge Bore 1". Handle: Cross Bore 2-1/8". Edge Bore 1".
Backset	Deadbolt: Adjustable to 2-3/8" or 2-3/4". Handle: Adjustable to 2-3/8" or 2-3/4".
Door	1-3/4" doors standard. 2-1/4" doors optional.
Thickness	Not designed for use on 1-3/8" doors.
Cylinder	SmartKey Security or Pin & Tumbler
Faceplate	1" x 2-1/4". Specify round corner, square corner or drive-in.
Strikes	Deadbolt: 1-1/4" x 3-5/8". Specify round corner or square corner. Others options available. Handle: 2-1/4" full lip. Specify round corner or square corner. Other options available.
Bolt	Deadbolt: 1" throw. Handle: 1/2" throw.
Door Handing	Reversible for right or left-hand doors.
ANSI/BHMA	Deadbolt is Grade 1 Certified. Montara Deadbolt is Grade 2 Certified.
ADA	N/A
UL	Optional 1/3 hour UL* fire rating for all functions except 802, 819 and 502

**KWIKSET SIGNATURE SERIES LEVERS**

Door Prep	Cross Bore 2-1/8" Edge Bore 1" Latch Face 1" x 2-1/4"
Backset	Adjustable 2-3/8" or 2-3/4".
Door	1-3/8" – 1-3/4" doors standard.
Thickness	2-1/4" doors optional on 720 and 740 models.
Cylinder	SmartKey Security or Pin & Tumbler.
Rose	Specify round or square rose - HFL, LSL, MRL, SYL, MIL, VDL
Faceplate	1" x 2-1/4". Specify round corner, square corner or drive-in.
Strikes	2-1/4" full lip. Specificity round corner or square corner. Other options available.
Bolt	1/2" throw
Door Handing	Specify handing only with inactive levers
ANSI/BHMA	Grade 2 Certified.
ADA	Families of MRL, SYL, LSL, MIL, HFL in Functions Passage, Privacy and Entry are in compliance with the American National Standards Institute (ANSI A117.1) and the Americans with Disabilities Act (ADA).
UL	Meets UL 3 hour fire rating for 725, 735, 745, 746, 749, 755 Optional UL* 1/3 hour fire rating for all functions

**KWIKSET SIGNATURE SERIES KNOBS**

Door Prep	Cross Bore: 2-1/8" Edge Bore: 1" Latch Face: 1"x 2-1/4".
Backset	Adjustable to 2-3/8" or 2-3/4". UL 2-3/4" standard 2-3/8" optional.
Door	1-3/8" – 1-3/4" doors standard.
Thickness	2-1/4" doors optional on 720 and 740 models only.
Cylinder	SmartKey Security or Pin & Tumbler.
Faceplate	1" x 2-1/4". Specify round corner, square corner or drive-in.
Strikes	2-1/4" full lip. Specify round corner or square corner. Other options available.
Bolt	1/2" throw.
Door Handing	Reversible for right- or left-hand doors.
ANSI/BHMA	Grade 2 Certified
ADA	N/A
UL	Meets UL 3 hour fire rating for 725, 735, 745, 746, 749 and 755. Optional UL* 1/3 hour fire rating for all functions

**VANCOUVER HANDLESET**

Door Prep (Deadbolt/ Handle)	Crossbore 2-1/8". Edge Bore 1". Latch Face 1" x 2-1/4" Deadbolt & Handle bore holes must be 5-1/2" apart
Backset (Deadbolt/ Handle)	Adjustable 2-3/8" or 2-3/4"
Door	1-3/4" Standard.
Thickness	Thick door service part available for up to 2-1/4"
Cylinder	SmartKey Security
Faceplate	1" x 2-1/4". Square, round, or drive in
Strikes	Deadbolt: 1-1/8" x 2-3/4" round; 2-1/4" full lip round (non-graded) Handle: 2-1/4" full lip round
Bolt	Deadbolt: 1" Throw Handle: 1/2" Throw
Door Handing	Reversible for right or left-hand doors.
ANSI/BHMA	Deadbolt – A156.39 Grade AAA Certified
ADA	N/A
UL	N/A
Warranty	Lifetime Mechanical and Lifetime Finish.

\*Optional UL 1/3 hour list price charge is \$2.50.



**KWIKSET SIGNATURE SERIES  
158/159 CONTEMPORARY DEADBOLTS**

Door Prep	Cross Bore 2-1/8" or 1-1/2". Edge Bore 1".
Backset	Adjustable 2-3/8" or 2-3/4".
Door Thickness	SMT 1-3/8" – 1-3/4".
Cylinder	SmartKey Security or Pin & Tumbler (158 and 159)
Rose	Specify round or square rose
Strikes	1-1/4" x 3-5/8" Square or Round Corner.
Bolt	1" Throw Steel.
ANSI/BHMA	A156.36 Grade 2
ADA	Interior turn pieces are in compliance with the American National Standards Institute (ANSI A117.1) and the Americans with Disabilities Act (ADA).
UL	Optional UL* 1/3 hour fire rating for all functions.

**KWIKSET SIGNATURE SERIES  
780-785 DEADBOLTS**

Door Prep	780, 785: Crossbore 2-1/8" or 1-1/2". Edge Bore 1". 782, 784: Crossbore 2-1/8". Edge Bore 1".
Backset	Adjustable 2-3/8" or 2-3/4" standard.
Door Thickness	1-3/8" – 1-3/4" doors standard. 1-7/8" – 2-1/4" optional.
Cylinder	SmartKey Security or 6-pin removable core.
Faceplate	1" x 2-1/4". Specify round corner, square corner or drive-in.
Strikes	1-1/4" x 3-5/8". Specify round corner or square corner. Other options available.
Bolt	1" throw.
Door Handing	Reversible for right or left-hand doors.
ANSI/BHMA	Grade 2 Certified.
ADA	Interior turn pieces are in compliance with the American National Standards Institute (ANSI A117.1) and the Americans with Disabilities Act (ADA).
UL	Meets UL 3 hour fire rating for 782 & 784 Optional UL* 1/3 hour fire rating for all functions

**KWIKSET SIGNATURE SERIES  
980/985 DEADBOLTS**

Door Prep	980, 985: Crossbore 2-1/8" or 1-1/2". Edge Bore 1". 982, 984: Crossbore 2-1/8". Edge Bore 1".
Backset	Adjustable 2-3/8" or 2-3/4".
Door Thickness	1-3/8" – 1-3/4" doors standard. 1-7/8" – 2-1/4" optional.
Cylinder	SmartKey Security or Pin & Tumbler.
Faceplate	1" x 2-1/4". Specify round corner, square corner or drive-in.
Strikes	Grade 2 - 3222/3223 strike (1-1/4" x 3-5/8"). Grade 1 - 20049/20050 strike (1-1/8" x 2-3/4")
Bolt	1" throw.
Door Handing	Reversible for right or left-hand doors.
ANSI/BHMA	Grade 1 Certified.
ADA	Interior turn pieces are in compliance with the American National Standards Institute (ANSI A117.1) and the Americans with Disabilities Act (ADA).
UL	Meets UL 3 hour fire rating for 982 and 984 Optional UL* 1/3 hour fire rating for all functions

\*Optional UL 1/3 hour list price charge is \$2.50.

**KWIKSET SIGNATURE SERIES  
258 UPTOWN & DOWNTOWN  
CONTEMPORARY DEADBOLTS**

Door Prep	Cross Bore 2-1/8". Edge Bore 1".
Backset	Adjustable 2-3/8" or 2-3/4".
Door Thickness	1-3/8" – 1-3/4" Standard. Thick door service part available for up to 2-1/4".
Cylinder	Smartkey Security
Faceplate	1" x 2-1/4" Square, round, or drive in.
Rose	Specify round (Uptown) or square (Downtown) rose.
Strikes	1" x 2-1/4" square or round corner.
Bolt	1" Throw Steel.
ANSI/BHMA	A156.36 Grade 1
ADA	Interior turn pieces are in compliance with the American National Standards Institute (ANSI A117.1) and the Americans with Disabilities Act (ADA).
UL	Optional UL* 1/3 hour fire rating for all functions.



**KWIKSET SIGNATURE SERIES HANDLESET**

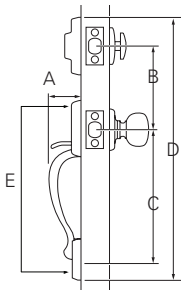

Design	A	B	C	D	E
Amherst®	3"	5-1/2"	8-13/32"	18-23/32"	18-18/25"
Arlington®	2-1/2"	5-1/2"	11"	19-1/16"	15"
Camino	2-15/16"	5-1/2"	8-13/32"	17-5/8"	13"
			9-11/16"		
Ashfield™	2-31/32"	5-1/2"	8-13/32"	17-3/4"	14-11/25"
Austin	3-1/8"	5-1/2"	8-13/32"	18-13/32"	13-17/20"
			9-1/8"		
			9-11/16"		
Avalon™	2-7/8"	5-1/2"	8-13/32"	18- 5/32"	12-13/20"
Chelsea®	2-3/16"	5-1/2"	9-11/16"	18-1/2"	13"
Hawthorne™	2-7/8"	5-1/2"	8-13/32"	17-7/16"	13-2/5"
Montara™	2-5/8"	5-1/2"	8-13/32"	17-5/8"	12-1/5"
			9-1/8"		
			9-11/16"		
San Clemente	2-5/8"	5-1/2"	8-13/32"	17-29/32"	13-7/16"
			9-11/16"		
Shelburne™	2-7/8"	5-1/2"	8-13/32"	18-1/4"	12-3/5"
Tavaris	2-17/32"	5-1/2"	8-13/32"	18"	12-19/25"
Vancouver	2-1/32"	5-1/2"	8-13/32"	17-15/16"	
			9-11/16"		

**KWIKSET SIGNATURE SERIES KNOBS**

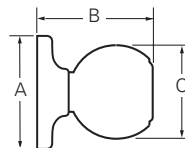

Design	A	B	C
Abbey®	2-5/8"	2-17/16"	2"
Cameron®	2-5/8"	2-13/32"	2-1/8"
Circa®	2-5/8"	2-31/32"	2-1/8"
Hancock®	2-5/8"	2-1/2"	2-3/8"
Laurel®	2-5/8"	2-7/16"	2-7/16"
Phoenix®	2-5/8"	2-1/2"	2-3/16"
Pismo	2-5/8"	2-13/32"	2-6/7"

**KWIKSET SIGNATURE SERIES LEVERS**

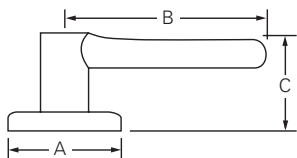

Design	A	B	C	C (Keyed)
Ashfield™	2-5/8"	4-3/16"	2-9/16"	2-9/16"
Austin	2-13/16"	4-1/8"	2-2/3"	2-3/4"
Avalon™	2-5/8"	4-1/4"	2-17/32"	2-7/16"
Brooklane®	2-5/8"	4-3/16"	2-11/16"	2-11/16"
Commonwealth®	2-5/8"	4-7/32"	2-7/16"	2-7/16"
Halifax	2-5/8"	4-15/32"	2-19/32"	2-3/8"
Katara	2-4/9"	4-4/9"	2-2/3"	2-3/4"
Lido®	2-5/8"	3-3/4"	1-29/32"	2-15/32"
Lisbon	2-5/8"	4-5/32"	2-9/16"	2-3/8"
Milan	2-5/8"	4-5/32"	2-9/16"	2-3/8"
Montreal	2-5/8"	4-1/4"	2-5/8"	2-11/16"
Pembroke™	2-5/8"	4-7/32"	2-23/32"	2-23/32"
Sydney®	2 5/8"	4 1/4"	2 3/4"	2 3/8"
Tustin®	2-5/8"	4-7/32"	2-3/32"	2-19/32"
Vedani	2-2/3"	4-5/8"	2-1/2"	2-3/4"

**KWIKSET SIGNATURE SERIES 158-159 DEADBOLT**

Round Design	A	B	C
158 Interior	2-17/32"	1-13/32"	1-11/16"
158 Exterior	2-17/32"	15/16"	
159 Interior	2-17/32"	1-13/32"	1-11/16"
159 Exterior	2-17/32"	15/16"	

  

Square Design	A	B	C
158 Interior	2-17/32"	1-13/32"	1-11/16"
158 Exterior	2-19/32"	15/16"	
159 Interior	2-17/32"	1-13/32"	1-11/16"
159 Exterior	2-19/32"	15/16"	

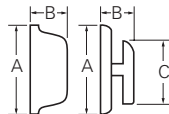

**KWIKSET SIGNATURE SERIES 980-985 DEADBOLT**

Design	A	B	C
980 Interior	2-19/32"	1-5/32"	1-13/16"
980 Exterior	2-5/8"	1-1/32"	
985 Interior	2-5/8"	1-1/32"	
985 Exterior	2-5/8"	1-1/32"	

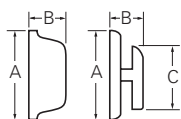

**KWIKSET SIGNATURE SERIES 780-785 DEADBOLT**

Design	A	B	C
780, 782 Interior	2-1/2"	15/16"	1-25/32"
780, 782 Exterior	2-5/8"	1-1/8"	
784, 785 Interior	2-5/8"	1-1/8"	
784, 785 Exterior	2-5/8"	1-1/8"	

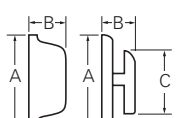

**KWIKSET SIGNATURE SERIES AUSTIN 980-985 DEADBOLT**

Design	A	B	C
980 Interior	3-13/32"	1-1/2"	1-7/16"
980 Exterior	3-17/32"	1-1/16"	
985 Interior	3-17/32"	1-1/16"	
985 Exterior	3-17/32"	1-1/16"	

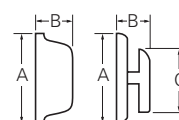

**KWIKSET SIGNATURE SERIES 258 UPTOWN & DOWNTOWN DEADBOLT**

Design	A	B	C
258 Round Interior	1-3/8"	1-21/32"	2-5/8"
258 Round Exterior	9/16"	2-5/8"	

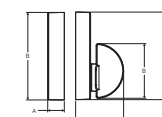

Design	A	B	C
258 Square Interior	1-7/16"	1-21/32"	2-5/8"
258 Square Exterior	1/2"	2-5/8"	

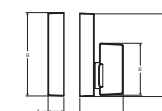

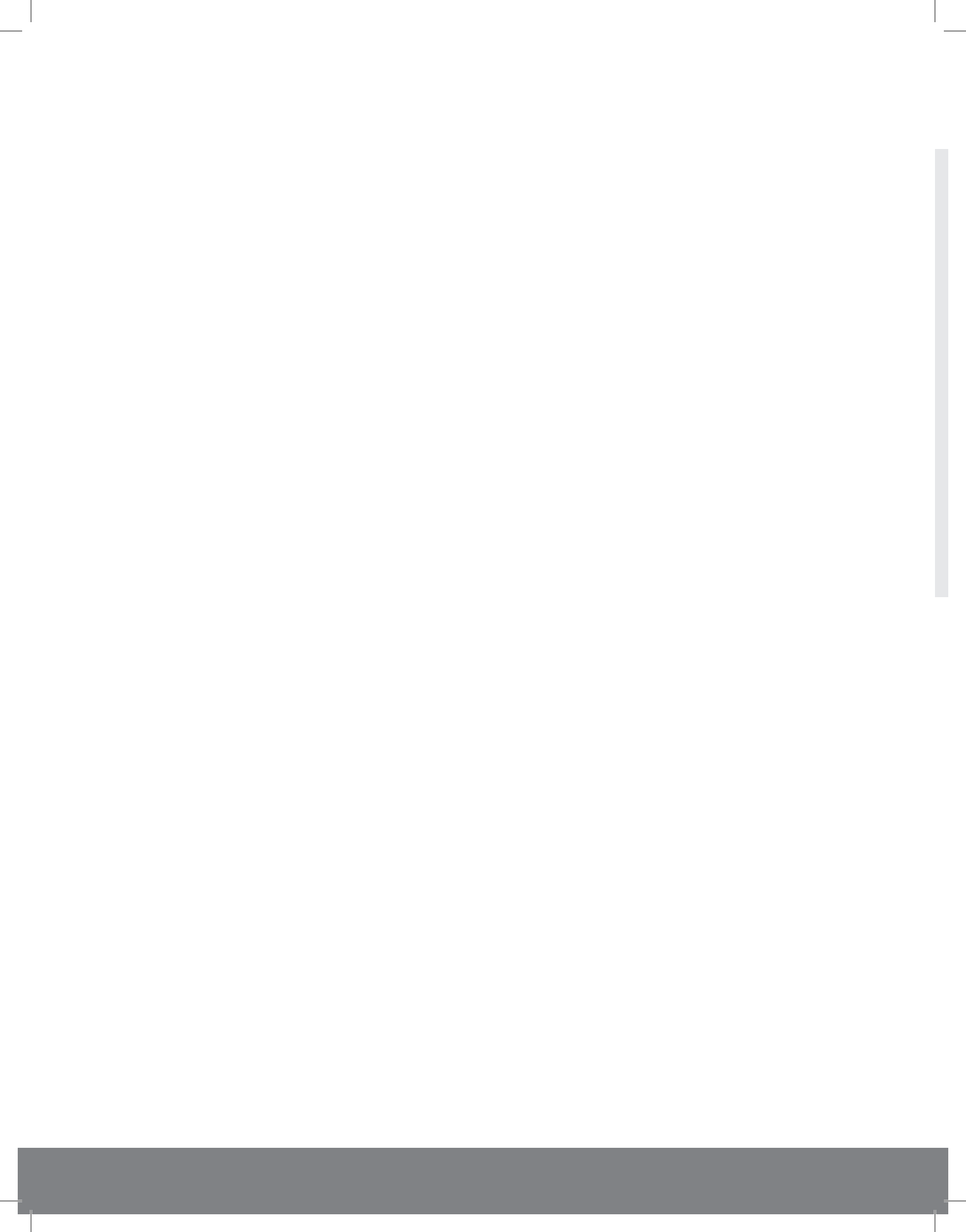



**Trusted Security**

- ANSI/BHMA Grade 3
- Easy Installation
- Available with SmartKey® Security
- Most Recognized Styles

**Warranty**

- Lifetime Mechanical
- Lifetime Finish



**Amador**



**Belleview™**



**Dakota™**



**Aliso™**



**Cove™**



**Polo®**



**Tylo®**



**Balboa™**



**Delta®**



**Dorian®**



**Ladera®**



**660 RDT  
Contemporary**



**660 SQT  
Deadbolt**



**660/665  
Deadbolt**



**Amador**



**Belleview™**



**Dakota™**



<b>Amador</b>		<b>Model</b>	<b>Function</b>	<b>Finish</b>							<b>Case</b>		
				<b>3</b>	<b>L03</b>	<b>5</b>	<b>11P</b>	<b>15</b>	<b>15A</b>	<b>26</b>	<b>26D</b>	<b>514</b>	<b>Qty</b>
		687AMD SMT	Single Cylinder				\$164.20	\$164.20		\$164.20	\$147.90	\$174.20	6
		689AMD SMT	Double Cylinder				\$169.30	\$169.30		\$169.30	\$153.00		6
		699AMD	Dummy				\$148.90	\$148.90		\$148.90	\$131.60		6
		898AMD	Handle Only				\$125.50	\$125.50		\$125.50		\$135.50	6

<b>Belleview™</b>		<b>Model</b>	<b>Function</b>	<b>Finish</b>							<b>Case</b>		
				<b>3</b>	<b>L03</b>	<b>5</b>	<b>11P</b>	<b>15</b>	<b>15A</b>	<b>26</b>	<b>26D</b>	<b>514</b>	<b>Qty</b>
		687BW	Single Cylinder	\$109.10		\$109.10	\$126.50	\$126.50			\$109.10		6
		687BW SMT	Single Cylinder	\$114.10		\$114.10	\$131.50	\$131.50			\$114.10		6
		689BW	Double Cylinder	\$114.10		\$114.10	\$131.50	\$131.50			\$114.10		6
		689BW SMT	Double Cylinder	\$119.10		\$119.10	\$136.50	\$136.60			\$119.10		6
		699BW	Dummy	\$98.90		\$98.90	\$115.30	\$115.30			\$98.90		6
		898BW	Handle Only				\$93.80	\$93.80					6

<b>Dakota™</b>		<b>Model</b>	<b>Function</b>	<b>Finish</b>							<b>Case</b>		
				<b>3</b>	<b>L03</b>	<b>5</b>	<b>11P</b>	<b>15</b>	<b>15A</b>	<b>26</b>	<b>26D</b>	<b>514</b>	<b>Qty</b>
		687DA	Single Cylinder	\$109.10		\$109.10	\$126.50	\$126.50	\$126.50		\$109.10		6
		687DA SMT	Single Cylinder	\$114.10		\$114.10	\$131.50	\$131.50	\$131.50		\$114.10		6
		689DA	Double Cylinder	\$114.10		\$114.10	\$131.50	\$131.50	\$131.50		\$114.10		6
		689DA SMT	Double Cylinder	\$119.10		\$119.10	\$136.50	\$136.50	\$136.50		\$119.10		6
		699DA	Dummy	\$98.90		\$98.90	\$115.30	\$115.30	\$115.30		\$98.90		6
		899DA	Handleset† with Balboa				\$153.00	\$153.00					6
		898DA	Handle Only				\$93.80	\$93.80					6

†Denotes handleset without deadbolt



**INTERIOR PACK FUNCTION OPTIONS**

Model	Function	Series			
		Signataure Lever & Laurel	Signature Knob	Kwikset Lever	Kwikset Knob
604	Single Cylinder	\$61.20	\$50.00	\$56.10	\$45.90
605	Double Cylinder	\$81.60	\$70.40	\$69.40	\$58.10
605 SMT	Double Cylinder	\$87.60	\$75.40	\$74.40	\$63.10
606	Dummy	\$52.00	\$40.80	\$45.90	\$34.70

NOTE:604 and 606 interior packs not impacted by SmartKey Security.

Kwikset Handleset & Interior Pack Finish Options	3	L03	5	11P	15	15A	26	26D	514	Qty	
<b>Kwikset</b> <i>Signature Series</i>	Abbey Knob	•					•			4	
	Circa Knob	•			•	•		•		4	
	Halifax Lever				°	°	°			4	
	Hancock Knob	•		•	•	•	•	•	•	4	
	Laurel Knob				•	•	•	•		4	
	Lido Lever	•		•		•	•		•	4	
	Tustin Lever	•		•	•	•	•	•	•	4	
<b>Kwikset</b>	Cove Knob				•	•	•	•		4	
	Delta Lever	•		•	•	•	•	•		4	
	Dorian Lever	•		•	•	•	•	•		4	
	Polo Knob	•		•	•	•	•	•		4	
	Tylo Knob	•		•		•		•	•	4	
	Aliso Knob	•			•	•		•		4	
	Balboa Lever	•		•	•	•		•	•	4	
	Ladera Lever RDT				•	•		•	•	4	
	Ladera Lever SQT				•	•		•	•	•	4

° Item only available in 604 Function with Square Rose and Square Interior Thumbturn



**Balboa™**

	Model	Function	Finish							Case	
			3	L03	5	11P	15	15A	26	26D	Qty
	200BL	Hall/Closet	\$37.70		\$37.70	\$41.80	\$41.80		\$41.80	\$37.70	20
	300BL	Bed/Bath	\$41.80		\$41.80	\$44.90	\$44.90		\$44.90	\$41.80	20
	405BL	Keyed Lever	\$57.10		\$57.10	\$60.20	\$60.20		\$60.20	\$57.10	20
	405BL SMT	Keyed Lever	\$62.10		\$62.10	\$65.20	\$65.20		\$65.20	\$62.10	20
	488BL	Half Dummy	\$19.40		\$19.40	\$22.40	\$22.40		\$22.40	\$19.40	20

**Delta®**

	Model	Function	Finish							Case	
			3	L03	5	11P	15	15A	26	26D	Qty
	200DL	Hall/Closet	\$37.70		\$37.70	\$41.80	\$41.80	\$41.80	\$41.80	\$37.70	20
	300DL	Bed/Bath	\$41.80		\$41.80	\$44.90	\$44.90	\$44.90	\$44.90	\$41.80	20
	405DL	Keyed Lever	\$57.10		\$57.10	\$60.20	\$60.20	\$60.20	\$60.20	\$57.10	20
	405DL SMT	Keyed Lever	\$62.10		\$62.10	\$65.20	\$65.20	\$65.20	\$65.20	\$62.10	20
	406DL	Free Interior, Keyed Lever	\$60.10		\$60.10			\$63.20	\$63.20	\$60.10	20
	406DL SMT	Free Interior, Keyed Lever	\$65.10		\$65.10			\$68.20	\$68.20	\$65.10	20
	409DL	Keyed Lever UL	\$63.10		\$63.10	\$66.20	\$66.20	\$66.20	\$66.20	\$63.10	20
	409DL SMT	Keyed Lever UL	\$68.10		\$68.10	\$71.20	\$71.20	\$71.20	\$71.20	\$68.10	20
	412DL	Vestibule Keyed Lever UL	\$66.20		\$66.20			\$69.20	\$69.20	\$66.20	20
	412DL SMT	Vestibule Keyed Lever UL	\$71.20		\$71.20			\$74.20	\$74.20	\$71.20	20
	413DL	Free Interior, Keyed Lever UL	\$66.10		\$66.10			\$69.20	\$69.20	\$66.10	20
	413DL SMT	Free Interior, Keyed Lever UL	\$71.10		\$71.10			\$74.20	\$74.20	\$71.10	20
	420DL	Hall/Closet UL	\$43.70		\$43.70	\$47.80	\$47.80	\$47.80	\$47.80	\$43.70	20
	430DL	Bed/Bath UL	\$47.80		\$47.80			\$50.90	\$50.90	\$47.80	20
	462DL	Vestibule Keyed Lever	\$60.20		\$60.20			\$63.20	\$63.20	\$60.20	20
	462DL SMT	Vestibule Keyed Lever	\$65.20		\$65.20			\$68.20	\$68.20	\$65.20	20
	488DL	Half Dummy	\$19.40		\$19.40	\$22.40	\$22.40	\$22.40	\$22.40	\$19.40	20

**Dorian®**

	Model	Function	Finish							Case	
			3	L03	5	11P	15	15A	26	26D	Qty
	200DNL	Hall/Closet	\$37.70		\$37.70	\$41.80	\$41.80	\$41.80	\$41.80	\$37.70	20
	300DNL	Bed/Bath	\$41.80		\$41.80	\$44.90	\$44.90	\$44.90	\$44.90	\$41.80	20
	405DNL	Keyed Lever	\$57.10		\$57.10	\$60.20	\$60.20	\$60.20	\$60.20	\$57.10	20
	405DNL SMT	Keyed Lever	\$62.10		\$62.10	\$65.20	\$65.20	\$65.20	\$65.20	\$62.10	20
	406DNL	Free Interior, Keyed Lever	\$60.10		\$60.10			\$63.20	\$63.20	\$60.10	20
	406DNL SMT	Free Interior, Keyed Lever	\$65.10		\$65.10			\$68.20	\$68.20	\$65.10	20
	409DNL	Keyed Lever UL	\$63.10		\$63.10	\$66.20	\$66.20	\$66.20	\$66.20	\$63.10	20
	409DNL SMT	Keyed Lever UL	\$68.10		\$68.10	\$71.20	\$71.20	\$71.20	\$71.20	\$68.10	20
	412DNL	Vestibule Keyed Lever UL	\$66.20		\$66.20			\$69.20	\$69.20	\$66.20	20
	412DNL SMT	Vestibule Keyed Lever UL	\$71.20		\$71.20			\$74.20	\$74.20	\$71.20	20
	413DNL	Free Interior, Keyed Lever UL	\$66.10		\$66.10			\$69.20	\$69.20	\$66.10	20
	413DNL SMT	Free Interior, Keyed Lever UL	\$71.10		\$71.10			\$74.20	\$74.20	\$71.10	20
	420DNL	Hall/Closet UL	\$43.70		\$43.70	\$47.80	\$47.80	\$47.80	\$47.80	\$43.70	20
	430DNL	Bed/Bath UL	\$47.80		\$47.80			\$50.90	\$50.90	\$47.80	20
	462DNL	Vestibule Keyed Lever	\$60.20		\$60.20			\$63.20	\$63.20	\$60.20	20
	462DNL SMT	Vestibule Keyed Lever	\$65.20		\$65.20			\$68.20	\$68.20	\$65.20	20
	488DNL	Half Dummy	\$19.40		\$19.40	\$22.40	\$22.40	\$22.40	\$22.40	\$19.40	20

**Ladera®**

	Model	Function	Finish							Case		
			3	L03	5	11P	15	15A	26	26D	514	Qty
	200LRL SQT	Hall/Closet				\$41.80	\$41.80		\$41.80	\$37.70	\$44.80	12
	300LRL SQT	Bed/Bath				\$44.90	\$44.90		\$44.90	\$41.80	\$47.90	12
	405LRL SQT SMT	Keyed Lever				\$65.20	\$65.20		\$65.20	\$62.20	\$68.20	12
	488LRL SQT	Half Dummy				\$22.40	\$22.40		\$22.40	\$19.40	\$25.40	12



**Ladera®**

Model	Function	Finish						Case Qty			
		3	L03	5	11P	15	15A		26	26D	514
200LRL RDT	Hall/Closet				\$41.80	\$41.80		\$41.80	\$37.70		20
300LRL RDT	Bed/Bath				\$44.90	\$44.90		\$44.90	\$41.80		20
405LRL RDT	Keyed Lever				\$60.20	\$60.20		\$60.20	\$57.10		20
405LRL SMT RDT	Keyed Lever				\$65.20	\$65.20		\$65.20	\$62.20		20
488LRL RDT	Half Dummy				\$22.40	\$22.40		\$22.40	\$19.40		20

**Aliso™**

Model	Function	Finish						Case Qty		
		3	L03	5	11P	15	15A		26	26D
200AO	Hall/Closet	\$25.50			\$28.60	\$28.60		\$28.60		30
300AO	Bed/Bath	\$28.60			\$31.60	\$31.60		\$31.60		30
400AO SMT	Entry	\$40.80			\$43.90	\$43.90		\$43.90		30
488AO	Half Dummy	\$12.20			\$16.30	\$16.30		\$16.30		20

**Cove™**

Model	Function	Finish						Case Qty		
		3	L03	5	11P	15	15A		26	26D
200CV	Hall/Closet				\$28.60	\$28.60		\$28.60	\$25.50	30
300CV	Bed/Bath				\$31.60	\$31.60		\$31.60	\$28.60	30
400CV	Entry				\$37.70	\$37.70		\$37.70	\$34.70	30
400CV SMT	Entry				\$42.70	\$42.70		\$42.70	\$39.70	30
488CV	Half Dummy				\$16.30	\$16.30		\$16.30	\$12.20	20

**Polo®**

Model	Function	Finish						Case Qty		
		3	L03	5	11P	15	15A		26	26D
200P	Hall/Closet	\$22.40		\$22.40	\$25.50	\$25.50	\$25.50	\$25.50	\$22.40	30
300P	Bed/Bath	\$25.50		\$25.50	\$28.60	\$28.60	\$28.60	\$28.60	\$25.50	30
400P	Entry	\$31.60		\$31.60	\$34.70	\$34.70	\$34.70	\$34.70	\$31.60	30
400P SMT	Entry	\$36.60		\$36.60	\$39.70	\$39.70	\$39.70	\$39.70	\$36.60	30
401P	Entry (Free Interior)	\$34.70		\$34.70	\$37.70	\$37.70			\$34.70	30
401P SMT	Entry (Free Interior)	\$39.70		\$39.70	\$42.70	\$42.70			\$39.70	30
450P	Vestible	\$34.70		\$34.70					\$34.70	30
450P SMT	Vestible	\$39.70		\$39.70					\$39.70	30
488P	Half Dummy	\$11.20		\$11.20	\$14.30	\$14.30	\$14.30	\$14.30	\$11.20	20

**Tylo®**

Model	Function	Finish						Case Qty		
		3	L03	5	11P	15	15A		26	26D
200T	Hall/Closet	\$20.40		\$20.40		\$23.50		\$23.50	\$20.40	30
300T	Bed/Bath	\$23.50		\$23.50		\$26.50		\$26.50	\$23.50	30
400T	Entry	\$29.60		\$29.60		\$32.60		\$32.60	\$29.60	30
400T SMT	Entry	\$34.60		\$34.60		\$37.60		\$37.60	\$34.60	30
401T	Entry (Free Interior)	\$32.60		\$32.60		\$35.70			\$32.60	30
401T SMT	Entry (Free Interior)	\$37.60		\$37.60		\$40.70			\$37.60	30
488T	Half Dummy	\$10.20		\$10.20		\$13.30		\$13.30	\$10.20	20



**660/663/665**

**RDT**



Model	Function	Finish								Case
		3	L03	5	11P	15	15A	26	26D	Qty
660 RDT	Single Cylinder SMT				\$44.00	\$44.00		\$44.00	\$44.00	12
665 RDT	Double Cylinder SMT				\$54.20	\$54.20		\$54.20	\$54.20	12
663 RDT	Single Sided				\$25.50	\$25.50		\$25.50	\$25.50	12

**660/663 SQT**



Model	Function	Finish								Case
		3	5	11P	15	15A	26	26D	514	Qty
660 SQT	Single Cylinder SMT			\$44.00	\$44.00		\$44.00	\$44.00	\$47.00	12
663 SQT	Single Sided			\$25.50	\$25.50		\$25.50	\$25.50	\$28.50	12

**660/665**



Model	Function	Finish								Case
		3	L03	5	11P	15	15A	26	26D	Qty
660	Single Cylinder	\$30.60		\$30.60	\$33.70	\$33.70	\$33.70	\$33.70	\$30.60	12
660 SMT	Single Cylinder SMT	\$35.60		\$35.60	\$38.70	\$38.70	\$38.70	\$38.70	\$35.60	12
665	Double Cylinder	\$38.80		\$38.80	\$42.80	\$42.80	\$42.80	\$42.80	\$38.80	12
665 SMT	Double Cylinder SMT	\$43.80		\$43.80	\$47.80	\$47.80	\$47.80	\$47.80	\$43.80	12

**One-Sided**



Model	Function	Finish								Case
		3	L03	5	11P	15	15A	26	26D	Qty
663	Thumbturn One Side	\$15.30		\$15.30	\$18.40	\$18.40	\$18.40	\$18.40	\$15.30	12
667	Thumbturn One Side with Exterior Plate	\$30.60		\$30.60	\$33.70	\$33.70	\$33.70	\$33.70	\$30.60	12
664	Retrofit Kit for 663	\$10.20		\$10.20	\$14.30	\$14.30			\$10.20	12
677	Thumbturn One Side with Exterior Plate UL	\$36.70		\$36.70	\$40.80	\$40.80			\$36.70	12

**Deadbolt and Knob Combo Packs**



Model	Function	Finish								Case
		3	L03	5	11P	15	15A	26	26D	Qty
690T	Keyed Entry Tylo Knob with Single Cylinder Deadbolt	\$55.10		\$55.10		\$55.10			\$55.10	6
690T SMT	Keyed Entry Tylo Knob with Single Cylinder Deadbolt	\$64.30		\$64.30		\$64.30			\$64.30	6
690P	Keyed Entry Polo Knob with Single Cylinder Deadbolt	\$56.10				\$56.10				6

## KWIKSET HANDLESETS

Door Prep	Deadbolt: Crossbore 2-1/8" or 1-1/2". Edge Bore 1". Handle: Crossbore 2-1/8". Edge Bore 1".
Backset	Deadbolt: Adjustable to 2-3/8" or 2-3/4". Handle: Adjustable to 2-3/8" or 2-3/4".
Door Thickness	1-3/4" doors standard. 2-1/4" doors optional. Not designed for use on 1-3/8" doors.
Cylinder	SmartKey Security or traditional 5-Pin, Pin & Tumbler.
Faceplate	1" x 2-1/4". Specify round corner, square corner or drive-in.
Strikes	Deadbolt: 1" x 2-1/4". Specify round corner or square corner. Other options available. Handle: 2-1/4" full lip. Specify round corner or square corner. Other options available.
Bolt	Deadbolt: 1" throw. Handle: 1/2" throw.
Door Handing	Reversible for right or left-hand doors.
ANSI/BHMA	Deadbolt is Grade 3 Certified.
ADA	N/A
UL	Optional UL 1/3 hour fire rating for all functions except 699*

## KWIKSET LEVERS

Door Prep	Cross Bore 2-1/8". Edge Bore 1".
Backset	Adjustable to 2-3/8" or 2-3/4". UL 2-3/4" standard 2-3/8" optional.
Door Thickness	1-3/8" – 1-3/4" doors standard. 2-1/4" doors optional on 200 and 400 functions only.
Cylinder	SmartKey Security or Pin & Tumbler.
Faceplate	1" x 2-1/4". Specify round corner, square corner or dr
Strikes	1" x 2-1/4" full lip. Specify round corner or square corner. Other options available.
Bolt	1/2" throw.
Door Handing	Delta and Dorian are non-handed. Balboa and Ladera are reversible for all functions except 488.
ANSI/BHMA	Grade 3 Certified. (all functions except 488)
ADA	Functions 200 and 420 in compliance with the American National Standards Institute (ANSI A117.1) and the Americans with Disabilities Act (ADA).
UL	Meets UL 3 hour fire rating for 409, 412, 413, 420, 430 Optional UL 1/3 hour fire rating for all functions*

## KWIKSET DEADBOLTS

Door Prep	660, 665: Crossbore 2-1/8". Edge Bore 1". 663: Crossbore 1-5/8". Edge Bore 1". 667: Crossbore 2-1/8" or 1-1/2". Edge Bore 1".
Backset	660, 665, 667: Adjustable latch standard. 663: 2-3/8" standard. 2-3/4" optional.
Door Thickness	660, 663, 665, 667: 1-3/8" – 1-3/4" doors standard.
Cylinder	660, 665: SmartKey Security or Pin & Tumbler.
Faceplate	1" x 2-1/4". Specify round corner, square corner or drive-in.
Strikes	1" x 2-1/4". Specify round corner or square corner. Other options available.
Bolt	1" throw.
Door Handing	Reversible for right or left-hand doors.
ANSI/BHMA	Grade 3 Certified.
ADA	Interior turn pieces are in compliance with the American National Standards Institute (ANSI A117.1) and the Americans with Disabilities Act (ADA).
UL	Meets UL 3 hour fire rating for 677 Optional UL 1/3 hour fire rating for all functions*

## KWIKSET KNOBS

Door Prep	Cross Bore 2-1/8". Edge Bore 1".
Backset	Adjustable to 2-3/8" or 2-3/4". 5" available as service part
Door Thickness	1-3/8" – 1-3/4" doors standard. 2-1/4" doors optional on 200 and 400 models only.
Cylinder	SmartKey Security or Pin & Tumbler.
Faceplate	1" x 2-1/4". Specify round corner, square corner or drive-in. Also available as drive-in latch.
Strikes	2-1/4" full lip. Specify round corner or square corner. Other options available.
Bolt	1/2" throw.
Door Handing	Reversible for right or left hand doors.
ANSI/BHMA	Grade 3 Certified. (all functions except 488)
ADA	N/A
UL	Optional UL 1/3 hour fire rating for all functions*

\*Optional UL 1/3 hour list price charge is \$2.50.



**KWIKSET HANDLESET**

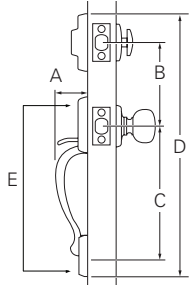

Design	A	B	C	D	E
Amador™	2-5/32"	5-1/2"	9-11/16"	17-15/32"	12-14/28"
Bellevue™	2-5/32"	5-1/2"	8-13/32"	18-1/16"	12-1/10"
Dakota™	2-5/32"	5-1/2"	8-13/32"	17-3/16"	12-1/10"

**KWIKSET KNOB**

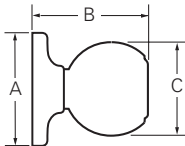

Design	A	B	C
Aliso™	2-5/8"	2-3/4"	2-2/5"
Cove™	2-5/8"	2-1/2"	2-3/16"
Polo®	2-5/8"	2-23/32"	1-7/8"
Tylo®	2-5/8"	2-1/2"	1-7/8"

**KWIKSET LEVER**

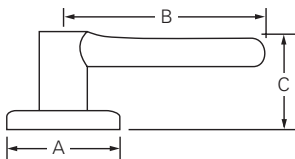

Design	A	B	C	C (Keyed)
Balboa™	2-5/8"	4-7/32"	1-15/16"	2-13/32"
Delta®	2-5/8"	3-5/8"	1-7/8"	2-15/32"
Dorian®	2-5/8"	3-3/4"	2-1/8"	2-11/16"
Ladera®	2-5/8"	4-3/16"	1-7/8"	2-7/16"

**KWIKSET DEADBOLT**

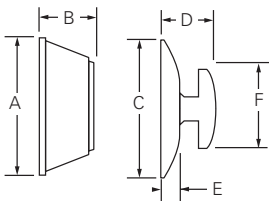

Design	A	B	C	D	E	F
660	2-7/16"	1-1/16"	2-1/2"	27/32"	5/16"	1-3/4"
660RDT	2-7/16"	1-1/16"	2-1/2"	31/32"	1-3/4"	
663			2-1/2"	27/32"	5/16"	1-3/4"
663RDT			2-1/2"	31/32"	1-3/4"	
665	2-7/16"	1-1/16"	2-1/2"	1-1/16"		
665RDT	2-7/16"	1-1/16"	2-7/16"	1-1/16"		
667	2-17/32"	3/8"	2-1/2"	27/32"	5/16"	1-3/4"
677	2-17/32"	3/8"	2-1/2"	27/32"	5/16"	1-3/4"



# SMART LOCKS AND KEYLESS ENTRY LOCKS

Kwikset's electronic door locks offer users the convenience of keyless entry, virtually eliminating the need for keys. All of our electronic locks are easy to install and program while complementing any Kwikset knob, lever or handleset.



## Features

- Smart Locks Replace any Deadbolt for Keyless Entry Convenience
- SmartCode™ Lever Ideal for - Small/Home Office, Utility/Storage Room, Interior Garage/Side Door
- Lock Your Door with the Touch of a Button
- Customizable Access Codes for Increased Security
- Back-Lit Keypad for Increased Visibility
- Customizable Automatic Door Locking After 30 Seconds for Peace Of Mind
- Installs In Minutes with Just a Screwdriver - No Hard Wiring Required
- Fits Standard Doors ( 1 3/8" - 2" ) with No Screw Holes Required

## Warranty

- 1 Year Electronic Warranty
- Lifetime Finish & Mechanical Warranty

# Kwikset



# HALO™



## FINGERPRINT SMART LOCK

The Halo Touch Wi-Fi enabled smart lock with fingerprint access technology allows you to simply use your unique fingerprint to lock and unlock your door.



Wi-Fi Enabled



Works with the Kwikset App



# HALO™

## WI-FI ENABLED SMART LOCKS

Halo smart locks connect directly to your existing home Wi-Fi network and smartphone to create a simple and secure smart home, without a third-party hub, panel or subscription service.



Wi-Fi Enabled



Works with the Kwikset App



Halo Wi-Fi Enabled Smart Locks Model	Function	Finish				Case Qty
		11P	15	26	514	
939 Halo Touchscreen	WiFi Enabled Deadbolt	\$458.00	\$458.00	\$458.00	\$458.00	1
938 Halo Touchpad	WiFi Enabled Deadbolt	\$398.00	\$398.00			1
959 Halo Touch Traditional	WiFi Enabled Deadbolt	\$470.00	\$470.00			1
959 Halo Touch Contemporary	WiFi Enabled Deadbolt		\$470.00		\$470.00	1

How it Works

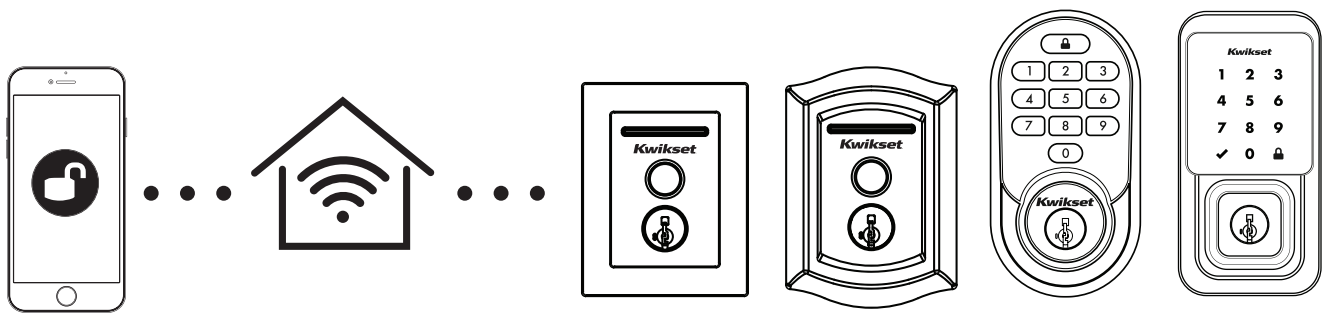

Control your lock from your smartphone

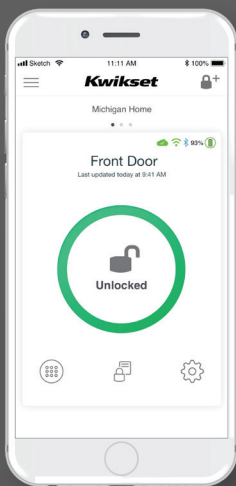

REMOTE ACCESS

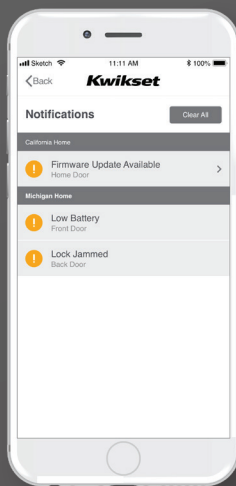

PUSH NOTIFICATIONS

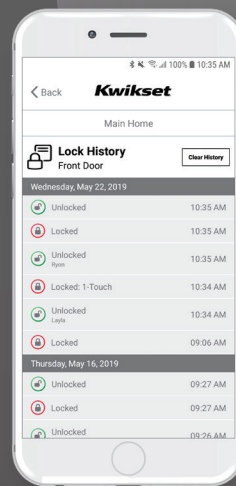

EVENT HISTORY

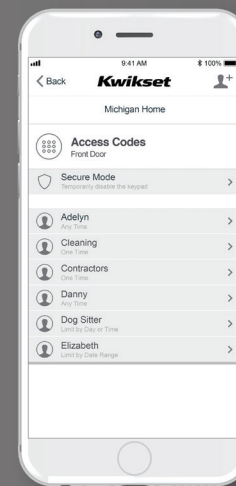

MANAGE ACCESS CODES

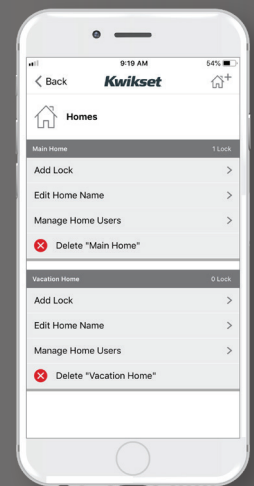

MANAGE MULTIPLE HOMES



**Kevo Contemporary**



**Kevo 2nd Gen**



**Kevo Convert**

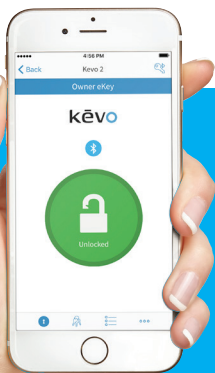

Kevo is compatible with:



Amazon Alexa



Nest® Learning Thermostat



Apple® Watch Notifications



Honeywell® Thermostats™ (select models)



Ring™ Video Doorbell



Skybell® WiFi Doorbell



Android Wear



For a complete compatibility list: [www.kwikset.com/kevo/compatibility](http://www.kwikset.com/kevo/compatibility)

**Kevo**

Kevo Contemporary Model	Function	Finish								Case Qty
		3	L03	5	11P	15	15A	26	514	
925 KEVO2 CNT DB	Bluetooth Enabled Deadbolt				\$472.00	\$472.00		\$472.00	\$472.00	1

Kevo 2nd Gen Model	Function	Finish								Case Qty
		3	L03	5	11P	15	15A	26	514	
925 KEVO 2 DB	Bluetooth Enabled Deadbolt		\$458.00		\$458.00	\$458.00				1

Kevo Convert Model	Function	Finish								Case Qty
		3	L03	5	11P	15	15A	26	26D	
925 KEVO CONVERT	Smart Lock Conversion Kit				\$298.00	\$298.00				1

Kevo Fob	Model	Function	Finish								Case Qty
			3	L03	5	11P	15	15A	26	N/A	
	926	Kevo Key Fob								\$54.00	1

# kēvo™

Touch-to-Open® Smart Lock

## Dimensions

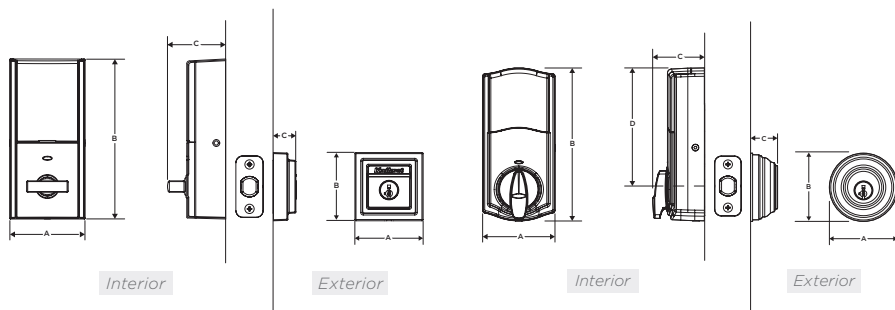

Design	A	B
Kevo™ CNT Interior	2.72" (69.09 mm)	5.77" (146.56 mm)
	C	D
	1.40" (35.66 mm)	---
Kevo™ CNT Exterior	A	B
	2.66" (67.61 mm)	2.66" (67.61 mm)
	C	D
	0.89" (22.73 mm)	---

Design	A	B
Kevo™ Interior	2 3/4" (69.85 mm)	5 3/4" (146.05 mm)
	C	D
	2" (50.8 mm)	4 9/16" (115.88 mm)
Kevo™ Exterior	A	B
	2" (50.8 mm)	4 9/16" (115.88 mm)
	C	D
	2" (50.8 mm)	---

## System Requirements

- Bluetooth Smart ready with a Bluetooth 4.0 enabled device
- Data connection required to download Kevo mobile app
- Smartphone compatibility: Apple iPhone 4S or higher and select Android 5.0 or higher. Check here for an updated compatibility list:

[www.kwikset.com/Kevo](http://www.kwikset.com/Kevo)

## Specifications

Function	Single Cylinder Deadbolt
<b>Door Prep</b>	2 1/8" diameter face hole & 1" diameter latch hole
<b>Backset</b>	Adjustable 2 3/8" or 2 3/4"
<b>Door Thickness</b>	1 3/4" standard doors
<b>Cylinder</b>	SmartKey® Re-key Technology
<b>Faceplates</b>	1" x 2 1/4" round corner standard
<b>Strikes</b>	Round corner strike 2 3/4" x 1 1/8"
<b>Latch</b>	Round corner adjustable 2 3/8" x 2 3/4"
<b>Bolt</b>	1" throw, steel deadbolt
<b>Door Handing</b>	Reversible
<b>Batteries</b>	4AA Required

## What's In The Box

- Kevo dedbolt
- 4 AA Batteries
- 2 eKeys
- 2 standard keys

# kēvo™

## CONVERT

Smart Lock Conversion Kit

## Dimensions

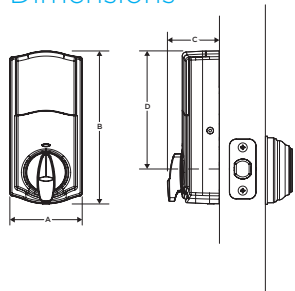

Design	A	B
Kevo™ Convert	2 3/4" (69.85 mm)	5 3/4" (146.05 mm)
	C	D
	2" (50.8 mm)	4 9/16" (115.88 mm)

## What's In The Box

- Kevo Convert Unit
- Mounting Hardware
- Lock Adapters
- 4 AA Batteries

## System Requirements

- Smartphone compatibility: Apple iPhone 4S or higher and select Android 5.0 or higher. Requires iOS 8 or higher and Android 5.0 or higher.
- Data connection required to download Kevo mobile app
- Visit [kevosmart.com](http://kevosmart.com) for details
- Download App from



## Specifications

Function	Smart Lock Conversion kit
<b>Backset</b>	Adjustable 2 3/8" or 2 3/4"
<b>Door Thickness</b>	1 3/8"-1 3/4" automatic adjustment
<b>Door Handing</b>	Reversible
<b>Batteries</b>	4AA Required



Premis™	Model	Description	Finish								Case Qty		
			3	L03	5	11P	15	15A	26	26D		514	
	919 TRL PREMIS	Touchscreen Electronic Deadbolt with Apple HomeKit™				\$440.00	\$440.00						2
	919 CNT PREMIS	Touchscreen Electronic Deadbolt with Home Kit					\$440.00				\$440.00		2

Obsidian™	Model	Description	Finish								Case Qty		
			3	L03	5	11P	15	15A	26	26D		514	
	953 OBN	Touchscreen Electronic Deadbolt				\$370.00	\$370.00						2

SmartCode™ 915 CNT	Model	Description	Finish								Case Qty		
			3	L03	5	11P	15	15A	26	26D		514	
	915 CNT	Touchscreen Electronic Deadbolt				\$370.00	\$370.00		\$370.00		\$370.00		2

SmartCode™ 915 TRL	Model	Description	Finish								Case Qty		
			3	L03	5	11P	15	15A	26	26D		514	
	915 TRL	Touchscreen Electronic Deadbolt				\$370.00	\$370.00						2

Aura™	Model	Description	Finish								Case Qty		
			3	L03	5	11P	15	15A	26	26D		514	
	942 BLE	Touchscreen Electronic Deadbolt				\$298.00	\$298.00				\$298.00		1

SmartCode™ 913 CNT	Model	Description	Finish								Case Qty		
			3	L03	5	11P	15	15A	26	26D		514	
	913 CNT	Touchpad Electronic Deadbolt				\$250.00	\$250.00		\$250.00		\$250.00		2



**SmartCode™  
913 TRL**



**SmartCode™  
909 TRL**



**SmartCode™  
917 TNL**



**SmartCode™  
917 HFL**



**Powerbolt 2®**



**Kwikset  
905**

**SmartCode™  
913 TRL**

Model	Description	Finish									Case
		3	L03	5	11P	15	15A	26	26D	514	Qty
913 TRL SMT	Touchpad Electronic Deadbolt		\$250.00		\$250.00	\$250.00					2

**SmartCode™  
909 TRL**

Model	Description	Finish									Case
		3	L03	5	11P	15	15A	26	26D	514	Qty
909 SMT	Touchpad Electronic Deadbolt		\$210.00		\$210.00	\$210.00					2

**SmartCode™  
917 TNL**

Model	Description	Finish									Case
		3	L03	5	11P	15	15A	26	26D	514	Qty
917 TNL	Touchpad Electronic Lever Tustin				\$238.00	\$238.00					2

**SmartCode™  
917 HFL**

Model	Description	Finish									Case
		3	L03	5	11P	15	15A	26	26D	514	Qty
917 HFL	Touchpad Electronic Lever Halifax					\$238.00		\$238.00		\$238.00	2

**Powerbolt 2®**

Model	Description	Finish									Case
		3	L03	5	11P	15	15A	26	26D	514	Qty
907 SMT	Touchpad Electronic Deadbolt		\$143.00		\$143.00	\$143.00					2

**905 Keyless Entry**

Model	Description	Finish									Case
		3	L03	5	11P	15	15A	26	26D	514	Qty
905	Touchpad Electronic Deadbolt	\$100.00			\$100.00	\$100.00					2



Control your lock from anywhere on your smart phone, tablet, or internet connected device and never worry about forgetting to lock your door again.

- Remotely lock and unlock your door from anywhere
- Receive notifications of your lock's activity
- Control when others have access to your home
- Arm or disarm your security panel
- Wirelessly communicate to other devices in your home



**Electronic Locks with Home Connect (Z-Wave)**

Item Number	Function	Finish						Case Qty.	Price
		L03	11P	15	26	26D	514		
<b>Obsidian™ with Home Connect</b>		L03	11P	15	26	26D	514		
99540-001	954 OBN ZW500 15 RCALFD			•				1	\$460.00
99540-002	954 OBN ZW500 11P RCALFD		•					1	\$460.00

\*Product must be ordered by item number and not description

<b>SmartCode™ 916 Contemporary with Home Connect</b>		L03	11P	15	26	26D	514		
99160-016	916CNT TSCR ZW500 15 SMTCD			•				1	\$460.00
99160-017	916CNT TSCR 11P ZW500 SMTCD		•					1	\$460.00
99160-018	916CNT TSCR 26 ZW500 SMTCD				•			1	\$460.00
99160-028	916CNT ZW500 514 SMT CP TPR RCALFD						•	1	\$460.00

\*Product must be ordered by item number and not description

<b>SmartCode™ 916 with Home Connect</b>		L03	11P	15	26	26D	514		
99160-019	916TRL ZW500 L03 RCALFD	•						1	\$460.00
99160-020	916TRL ZW500 15 RCALFD			•				1	\$460.00
99160-021	916TRL ZW500 11P RCALFD		•					1	\$460.00

\*Product must be ordered by item number and not description

<b>SmartCode™ 914 Contemporary with Home Connect</b>		L03	11P	15	26	26D	514		
99140-019	914CNT ZW500 15 SMTCD			•				1	\$395.00
99140-020	914CNT ZW500 11P SMTCD		•					1	\$395.00
99140-021	914CNT ZW500 26 SMTCD				•			1	\$395.00
99140-028	914CNT ZW500 514 SMT CP TPR RCALFD						•	1	\$395.00

\*Product must be ordered by item number and not description

<b>SmartCode™ 914 with Home Connect</b>		L03	11P	15	26	26D	514		
99140-022	914TRL ZW500 L03 RCALFD	•						1	\$395.00
99140-023	914TRL ZW500 15 RCALFD			•				1	\$395.00
99140-024	914TRL ZW500 11P RCALFD		•					1	\$395.00

\*Product must be ordered by item number and not description





## Features

- Full 128-Bit Encryption Security
- Motorized locking mechanism enables true remote locking & unlocking
- SmartKey Security - providing superior security against advanced break-in techniques.
- Easy Integration
- Z-Wave Wireless Protocol
- Fits Standard Doors (1 3/8"-2") with No Screw Holes Required
- 4 AA Alkaline Batteries (no hard wiring) - batteries last for approximately 1 year

Electronic Locks with Home Connect (Z-Wave)								
SmartCode™ 912 with Home Connect		L03	11P	15	26	26D		
99120-037	912TNL ZW500 15 RCALFD	•					1	\$375.00
99120-038	912TNL ZW500 11P RCALFD			•			1	\$375.00
99120-039	912TNL ZW500 L03 RCALFD		•				1	\$375.00
*Product must be ordered by item number and not description								
SmartCode™ 910 with Home Connect		L03	11P	15	26	26D		
99100-077	910TRL ZW500 L03 RCALFD	•					1	\$375.00
99100-078	910TRL ZW500 15 RCALFD			•			1	\$375.00
99100-079	910TRL ZW500 11P RCALFD		•				1	\$375.00
*Product must be ordered by item number and not description								
SmartCode™ 910 Contemporary with Home Connect		L03	11P	15	26	26D		
99100-080	910CNT ZW500 15 RCALFD			•			1	\$375.00
99100-081	910CNT ZW500 26D RCALFD				•		1	\$375.00
99100-082	910CNT ZW500 26 RCALFD					•	1	\$375.00
99100-083	910CNT ZW500 11P RCALFD		•				1	\$375.00
*Product must be ordered by item number and not description								
Signature Series Deadbolt with Home Connect		L03	11P	15	26	26D		
99140-130	914 S 2 TRL ZW500 15 SMT BP TPR RCALFD			•			1	\$258.00
99140-131	914 S 2 TRL ZW500 11P SMT BP TPR RCALFD		•				1	\$258.00
*Product must be ordered by item number and not description								
99140-132	914 S 2 CNT ZW500 15 SMT BP TPR RCALFD			•			1	\$258.00
99140-133	914 S 2 CNT ZW500 11P SMT BP TPR RCALFD		•				1	\$258.00
*Product must be ordered by item number and not description								
Kwikset Convert with Home Connect		L03	11P	15	26	26D		
99140-101	914 ZW500 CONVERT L03	•					1	\$258.00
99140-102	914 ZW500 CONVERT 15			•			1	\$258.00
99140-103	914 ZW500 CONVERT 11P		•				1	\$258.00
*Product must be ordered by item number and not description								
SmartCode™ 888 with Home Connect		L03	11P	15	26	26D		
98880-004	888 ZW500 15 SMT RCALFD			•			1	\$258.00
98880-005	888 ZW500 11P SMT RCALFD		•				1	\$258.00
98880-006	888 ZW500 L03 SMT RCALFD	•					1	\$258.00
*Product must be ordered by item number and not description								



**SMARTCODE™ 910, 914, 916**

Door Prep	2-1/8" diameter face hole & 1" diameter latch hole
Backset	Adjustable to 2-3/8" or 2-3/4"
Door	1-3/8" to 2" automatic adjustment
Thickness	
Cylinder	SmartKey Security
Faceplate	1" x 2-1/4". Round corner standard
Strikes	Round corner strike 1-1/8" x 2-3/4"
Bolt	1" throw, steel deadbolt
Door Handing	Reversible
Batteries	4 AA Alkaline
Wireless Communication	Z-Wave wireless technology
Operation	908.42 MHz (US)
Range	Typical 100ft line of sight

**SMARTCODE™ 909, 913,  
POWERBOLT 2 DEADBOLT**

Function	Single cylinder deadbolt
Door Prep	2-1/8" diameter face hole & 1" diameter latch hole
Backset	Adjustable to 2-3/8" or 2-3/4"
Door	1-3/8" to 2" automatic adjustment
Thickness	
Cylinder	SmartKey Security
Faceplate	1" x 2-1/4" round corner standard
Strikes	Round corner strike 1-1/8" x 2-3/4"
Bolt	1" throw, steel deadbolt
Door Handing	Reversible
Batteries	4 AA Alkaline

**SMARTCODE™ 912 LEVER**

Door Prep	2-1/8" diameter face hole & 1" diameter latch hole
Backset	Adjustable to 2-3/8" or 2-3/4"
Door	1-3/8" to 2" automatic adjustment
Thickness	
Cylinder	SmartKey Security
Faceplate	1" x 2-1/4". Round corner standard
Strikes	2-1/4" full lip. Round corner
Bolt	1/2" throw
Door Handing	Reversible
Batteries	4 AA Alkaline
Wireless Communication	Z-Wave wireless technology
Operation	908.42 MHz (US)
Range	Typical 100ft line of sight

**SIGNATURE SERIES DEADBOLT W/ HOME CONNECT**

Function	Single cylinder deadbolt
Door Prep	2-1/8" diameter face hole & 1" diameter latch hole
Backset	Adjustable 2-3/8" or 2-3/4"
Door Thickness	1-3/8" - 2" automatic adjustment
Faceplates	1" x 2-1/4" round corner standard
Strikes	Round corner strike 2-3/4" x 2-1/8"
Latch	Round corner adjustable 2-3/8" x 2-3/4"
Bolt	1" throw, steel deadbolt
Door Handing	Reversible
Cylinder	SmartKey®
Wireless Protocol	Z-Wave 500; lock complies with Z-Wave standard of open air, line of sight transmission of 160 feet or more. Compliant with FCC Part 15. Industry Canada.

*\*Range may vary depending on radio frequency environment. Work with your home control platform to optimize range.*

**OBSIDIAN 953 / 954**

Function	Single cylinder deadbolt
Door Prep	1-1/2 & 2-1/8" diameter face hole & 1" diameter latch hole
Backset	Adjustable to 2-3/8" or 2-3/4"
Door	1-3/8" to 2"
Thickness	
Faceplates	1" x 2-1/4" round corner standard
Strikes	Round corner
Latch	Round corner adjustable 2-3/8" or 2-3/4"
Bolt	1" throw, steel deadbolt
Door Handing	Reversible
Batteries	6V (4 AA alkaline batteries required)

**SMARTCODE™ 915 / 916 & PREMIS™**

Function	Single cylinder deadbolt
Door Prep	2-1/8" diameter face hole & 1" diameter latch hole
Backset	Adjustable to 2-3/8" or 2-3/4"
Door	1-3/8" to 2-1/8" automatic adjustment
Thickness	
Cylinder	SmartKey Security
Faceplates	1" x 2-1/4" round corner standard
Strikes	Round corner, 4 hole strike, 2-3/4" x 1-1/8"
Latch	Round corner adjustable 2-3/8" or 2-3/4"
Bolt	1" throw, steel deadbolt
Door Handing	Reversible
Batteries	4 AA Required

### SMARTCODE™ 917

Function	Keyed entry electronic lever
Door Prep	Cross Bore 2- 1/8". Edge Bore 1".
Backset	2 3/8" or 2 3/4"
Door Thickness	1 3/8" - 1 3/4"
Faceplates	1" x 2 1/4" round corner standard, drive in available
Strikes	2 1/4" full lip round corner
Latch	Adjustable 2 3/8" x 2 3/4"
Bolt	1/2" throw, dead latch
Door Handing	Reversible for right or left-handed doors
Cylinder	SmartKey Security™
UL Rating	20 min
Temperature Range	Exterior: -40F to 150F Interior: 32F to 130F
Humidity	Exterior: - 100% condensing Interior: 30% - 95% non-condensing

### SMARTCODE™ 888

Function	Single cylinder deadbolt
Door Prep	2 1/8" diameter face hole & 1" diameter latch hole
Backset	Adjustable 2 3/8" or 2 3/4"
Door Thickness	1 3/8" - 1 3/4" automatic adjustment
Faceplates	1" x 2 1/4" round corner standard
Strikes	Round corner strike 2 3/4" x 1 1/8"
Latch	Round corner adjustable 2 3/8" x 2 3/4"
Bolt	1" throw, steel deadbolt
Door Handing	Reversible
Cylinder	SmartKey®
Wireless Protocol	Z-Wave 500; lock complies with Z-Wave standard of open air, line of sight transmission of 160 feet or more. Compliant with FCC Part 15. Industry Canada. <small>*Range may vary depending on radio frequency environment. Work with your home control platform to optimize range.</small>

### AURA™ DEADBOLT

Door Prep	2-1/8" diameter face hole & 1" diameter latch hole
Backset	Adjustable to 2-3/8" or 2-3/4"
Door	1-3/8" to 2" automatic adjustment
Thickness	
Cylinder	SmartKey Security
Faceplate	1" x 2-1/4". Round corner standard
Strikes	2-3/4" x 1-1/8". Round corner 4 hole strike
Bolt	1" throw
Door Handing	Reversible
Batteries	4 AA Alkaline

### 905 TOUCHPAD DEADBOLT

Function	Single cylinder deadbolt
Door Prep	2 1/8" diameter face hole & 1" diameter latch hole
Latch Backset	Adjustable 2 3/8" or 2 3/4"
Door Thickness	Fits 1 3/8" - 1 3/4" door thickness
Latch Faceplate	1" x 2 1/4" round corner standard
Strike	Round corner strike 2 3/4" x 1 1/8"
Bolt	1" throw, steel deadbolt
Door Handing	Reversible
Batteries	Requires 4 X AA alkaline batteries

### Kwikset Convert

Function	Smart Lock Conversion Kit
Backset	Adjustable 2 3/8" or 2 3/4"
Door Thickness	1 3/8" - 1 3/4" automatic adjustment
Door Handing	Reversible
Batteries	4AA required



**OBSIDIAN™**

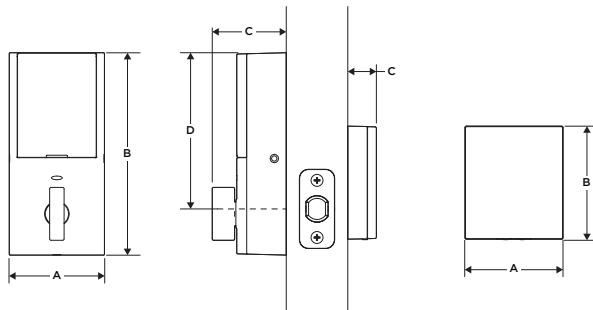

Design	A	B	C	D
Outer Trim	2 11/16"	5 3/4"	2 3/32"	4 9/16"
Inner Trim	2 25/32"	3 7/32"	1 3/16"	---

**SMARTCODE™ 915/916 CNT & PREMIS CNT**

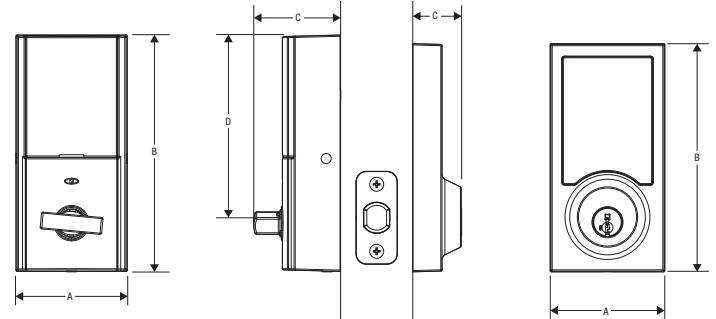

Design	A	B	C	D
Outer Trim	2 11/16"	5 3/4"	2 3/32"	4 9/16"
Inner Trim	2 25/32"	5 1/32"	1 13/16"	---

**SMARTCODE™ 917 HNL**

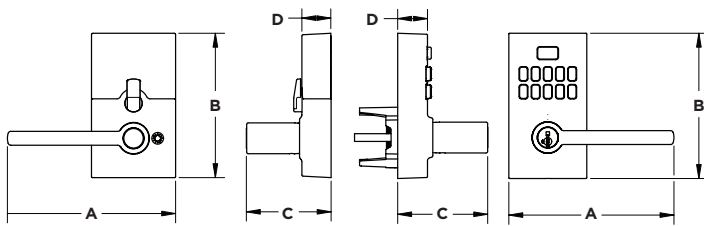

Design	A	B	C	D
Outer Trim	5 9/16"	4 29/32"	3 1/32"	1"
Inner Trim	5 1/32"	4 7/8"	2 27/32"	3 1/32"

**KWISKET™ CONVERT**

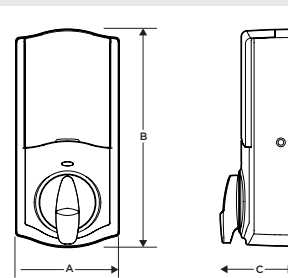

Design	A	B	C
Inner Trim	2 25/32"	5 3/4"	1 15/16"

**SMARTCODE™ 917 TNL**

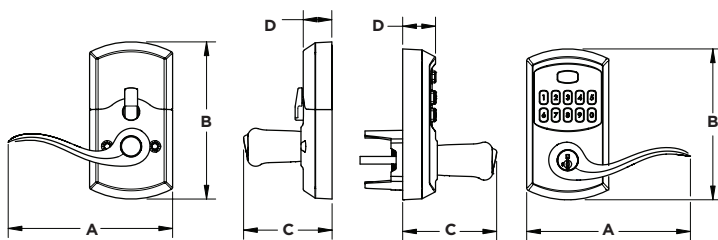

Design	A	B	C	D
Outer Trim	5 9/32"	5 5/32"	3 3/32"	1 1/8"
Inner Trim	5 5/8"	5 3/8"	2 29/32"	3 1/32"

**SMARTCODE™ 888**

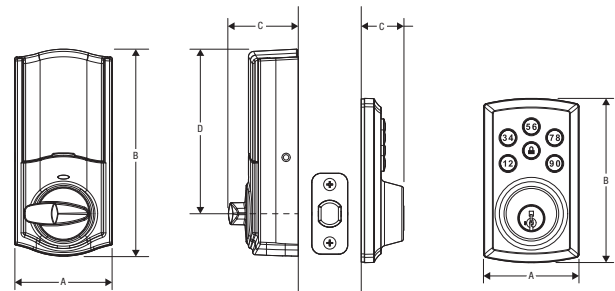

Design	A	B	C	D
Outer Trim	2 23/32"	5 25/32"	1 15/16"	4 9/16"
Inner Trim	2 21/32"	4 19/32"	1 3/16"	---

**KWIKSET 905**

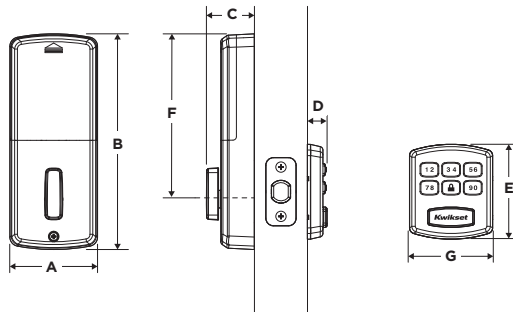

Design	A	B	C	D	E	F	G
Outer Trim	-	-	-	-	3 1/4"	5 19/32"	2 27/32"
Inner Trim	3"	7 3/8"	1 21/32"	1 1/36"	-	-	-

**SMARTCODE™ 914**

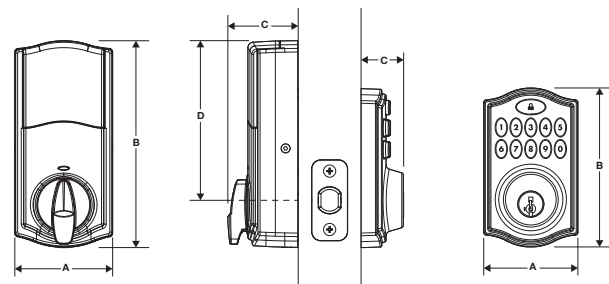

Design	A	B	C	D
Outer Trim	2-5/8"	4-7/16"	1-3/16"	-
Inner Trim	2-3/4"	5-3/4"	2"	4-7/16"

**NOTE:** Lifetime Finish and Mechanical Warranty. One Year Electronic Warranty.

**AURA**

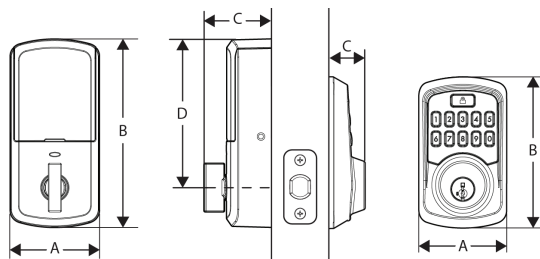

Design	A	B	C	D
Outer Trim	2 3/4"	5 13/16"	2 1/8"	4 9/16"
Inner Trim	2 23/32"	4 5/8"	1 3/16"	---

**SMARTCODE™ 913 / 914 CONTEMPORARY**

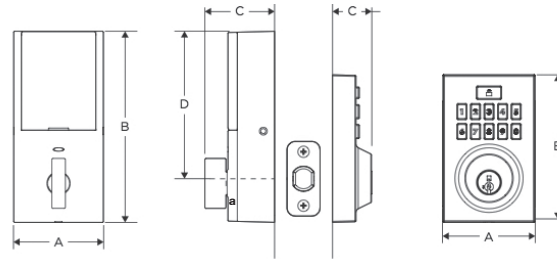

Design	A	B	C	D
Outer Trim	2-25/32"	4-7/16"	1-3/16"	-
Inner Trim	2-11/16"	5-3/4"	2-3/32"	4-9/16"

**SMARTCODE™ 915 / 916 & PREMIS™**

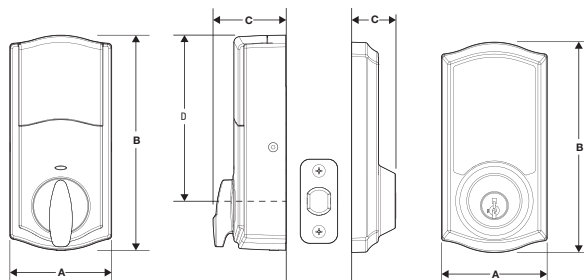

Design	A	B	C	D
Outer Trim	2-13/16"	5-3/8"	1-3/16"	-
Inner Trim	2-3/4"	5-3/4"	1-15/16"	4-9/16"

**SMARTCODE™ 913**

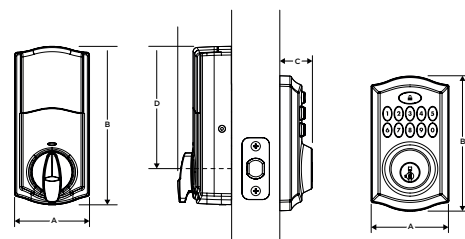

Design	A	B	C	D
Outer Trim	2-7/8"	5"	1-3/16"	-
Inner Trim	2-3/4"	5-3/4"	2	4-7/16"



**SMARTCODE™ 912**

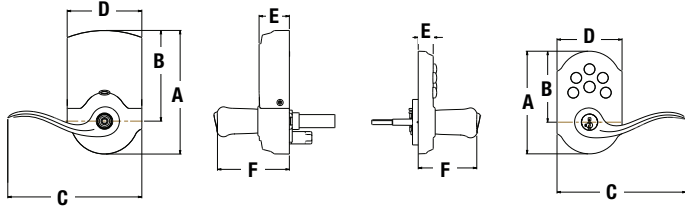

Design	A	B	C	D	E	F
Outer Trim	4 7/16"	3 1/16"	5 19/32"	2 19/16"	2 1/32"	2 17/32"
Inner Trim	5 11/32"	3 15/16"	5 13/16"	3 1/4"	1 5/16"	3 1/8"

**SMARTCODE™ 910 CONTEMPORARY**

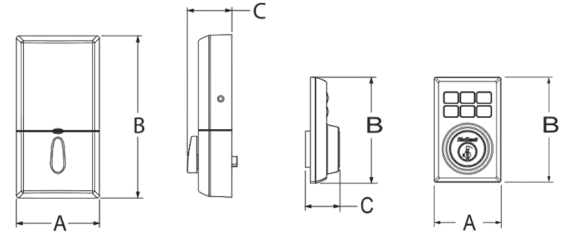

Design	A	B	C
Outer Trim	2-23/32"	4-1/4"	1-3/16"
Inner Trim	3-9/32"	6-13/32"	1-3/4"

**SMARTCODE™ 909/910**

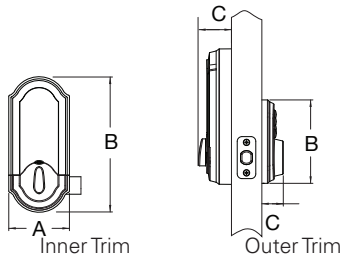

Design	A	B	C
Outer Trim	2-13/16"	4-7/16"	1-3/16"
Inner Trim	3-1/4"	7-1/4"	1-3/4"

**SMARTCODE™ 910 ROUND**

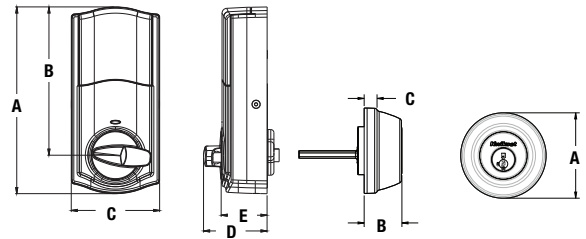

Design	A	B	C	D	E
Outer Trim	2-5/8"	1-5/32"	19/32"	-	-
Inner Trim	5-3/4"	4-9/16"	2-23/16"	1-31/32"	1-13/32"

**SMARTCODE™ 910 SQUARE**

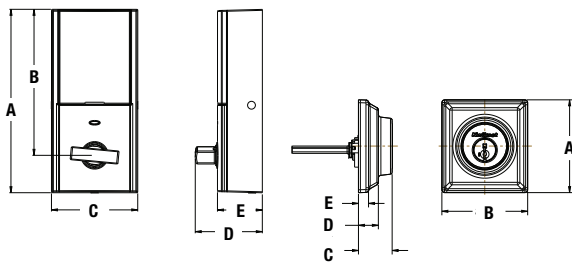

Design	A	B	C	D	E
Outer Trim	2-29/32"	2-1/16"	1-1/16"	5/8"	5/16"
Inner Trim	5-3/4"	4-9/16"	2-11/16"	2-3/32"	1-13/32"



**Interconnect Knobs & Levers - 780 Deadbolt Options**

Model	Function	Style	Finish							
			3	L03	5	11P	15	15A	26	26D
506	Entry	Hancock	\$241.70	\$246.80	\$241.70	\$246.80	\$246.80	\$246.80	\$246.80	\$241.70
		Commonwealth	\$241.70	\$246.80		\$246.80	\$246.80			
		Tustin	\$241.70		\$241.70	\$246.80	\$246.80	\$246.80	\$246.80	\$241.70
		Kingston	\$241.70		\$241.70					\$241.70
506 SMT	Entry	Hancock	\$241.70	\$246.80	\$241.70	\$246.80	\$246.80	\$246.80	\$246.80	\$241.70
		Commonwealth	\$241.70	\$246.80		\$246.80	\$246.80			
		Tustin	\$241.70		\$241.70	\$246.80	\$246.80	\$246.80	\$246.80	\$241.70
		Kingston	\$241.70		\$241.70					\$241.70
508	Passage	Hancock	\$224.40	\$230.50	\$224.40	\$230.50	\$230.50	\$230.50	\$230.50	\$224.40
		Commonwealth	\$224.40	\$230.50		\$230.50	\$230.50			
		Tustin	\$224.40		\$224.40	\$230.50	\$230.50	\$230.50	\$230.50	\$224.40
		Kingston	\$224.40		\$224.40	\$230.50	\$230.50			\$224.40
508 SMT	Passage	Hancock	\$224.40	\$230.50	\$224.40	\$230.50	\$230.50	\$230.50	\$230.50	\$224.40
		Commonwealth	\$224.40	\$230.50		\$230.50	\$230.50			
		Tustin	\$224.40		\$224.40	\$230.50	\$230.50	\$230.50	\$230.50	\$224.40
		Kingston	\$224.40		\$224.40	\$230.50	\$230.50			\$224.40



- 506 & 505 interconnect functions utilize turn button locking
- Split finish options available

**Interconnect Levers - 660 Deadbolt Options**

Model	Function	Style	Finish							
			3	L03	5	11P	15	15A	26	26D
505	Entry	Kingston	\$224.40		\$224.40					\$224.40

**Interconnect Levers - Handleset Interior Pack Options**

Model	Function	Style	Finish							
			3	L03	5	11P	15	15A	26	26D
502	Passage	Tustin				\$147.90	\$147.90			

**Interconnect Key Control Deadbolt**

Model	Function	Style	Finish							
			3	L03	5	11P	15	15A	26	26D
508 SMT KCDB	Passage	Hancock	\$231.50			\$236.60	\$236.60			
		Commonwealth				\$236.60	\$236.60			
		Tustin	\$231.50			\$236.60	\$236.60			
		Kingston	\$231.50			\$236.60	\$236.60			\$232.00





**Contemporary Interconnect Levers - 780 Deadbolt Options**



Model	Function	Style	Finish								
			3	L03	5	11P	15	15A	26	26D	
506 SMT	Entry	Kingston CNT									\$241.70
		Ladera CNT				\$246.80	\$246.80		\$246.80		\$241.70
508	Passage	Kingston CNT				\$230.50	\$230.50				\$224.40
		Ladera CNT				\$230.50	\$230.50		\$230.50		\$224.40
508 SMT	Passage	Kingston CNT				\$230.50	\$230.50				\$224.40
		Ladera CNT				\$230.50	\$230.50		\$230.50		\$224.40

**Contemporary Interconnect Levers - 780 Deadbolt Options Split Style**

Model	Function	Style	Finish								
			3	L03	5	11P	15	15A	26	26D	
506 SMT	Entry	Ladera LH X Kingston CNT									\$241.70
		Ladera RH X Kingston CNT									\$241.70
508	Passage	Ladera LH X Kingston CNT				\$230.50	\$230.50				\$224.40
		Ladera RH X Kingston CNT				\$230.50	\$230.50				\$224.40
508 SMT	Passage	Ladera LH X Kingston CNT				\$230.50	\$230.50				\$224.40
		Ladera RH X Kingston CNT				\$230.50	\$230.50				\$224.40

**Contemporary Interconnect Levers - Interior Pack Options**

Model	Function	Style	Finish							
			3	L03	5	11P	15	15A	26	26D
502	Interior Pack	Ladera				\$147.90	\$147.90		\$147.90	\$141.80
502	Interior Pack	Kingston								\$141.80

**Key Control Deadbolt**



Model	Function	Finish							Case		
		3	L03	5	11P	15	15A	26	26D	514	Qty
816 SMT	Key Control Deadbolt	\$69.40		\$77.50	\$77.50	\$77.50			\$77.50		12
817 SMT	Key Control Deadbolt UL				\$83.60	\$83.60			\$83.60		12

**SmartCode™  
955**



Model	Description	Finish							Case		
		3	L03	5	11P	15	15A	26	26D	514	Qty
955	Touchpad Electronic Lever				\$215.00	\$215.00			\$215.00	\$215.00	2





## GRADE 2 LEVERS

	Kingston™	Model	Function	Finish							
				3	L03	5	11P	15	15A	26	26D
		721KNL UL	Hall/Closet	\$52.00			\$57.10	\$57.10			\$52.00
		733KNL UL	Bed/Bath	\$55.10			\$60.20	\$60.20			\$55.10
		756KNL UL	Keyed entry UL	\$80.60			\$85.70	\$85.70			\$80.60
		756KNL SMT UL	Keyed entry UL	\$80.60			\$85.70	\$85.70			\$80.60
		781KNL UL	Storeroom UL	\$84.70			\$89.80	\$89.80			\$84.70
		781KNL SMT UL	Storeroom UL	\$84.70			\$89.80	\$89.80			\$84.70
		788KNL	Half Dummy	\$25.50			\$28.60	\$28.60			\$25.50

## GRADE 3 LEVERS

	Carson™	Model	Function	Finish							
				3	L03	5	11P	15	15A	26	26D
		407CNL	Passage UL	\$37.70			\$43.90	\$43.90			\$37.70
		408CNL	Privacy UL	\$41.80			\$46.90	\$46.90			\$41.80
		438CNL UL	Entry UL	\$67.30			\$72.40	\$72.40			\$67.30
		438CNL SMT UL	Entry UL	\$67.30			\$72.40	\$72.40			\$67.30
		439CNL UL	Storeroom UL	\$70.40			\$75.50	\$75.50			\$70.40
		439CNL SMT UL	Storeroom UL	\$70.40			\$75.50	\$75.50			\$70.40
		488CNL	Half Dummy	\$19.40			\$21.40	\$21.40			\$19.40

	Burbank™	Model	Function	Finish							
				3	L03	5	11P	15	15A	26	26D
		407BBL	Passage UL	\$37.70			\$43.90	\$43.90		\$43.90	
		408BBL	Privacy UL	\$41.80			\$46.90	\$46.90		\$46.90	
		438BBL	Entry UL	\$67.30			\$72.40	\$72.40		\$72.40	
		439BBL	Storeroom UL	\$70.40			\$75.50	\$75.50		\$75.50	
		488BBL	Half Dummy	\$19.40			\$21.40	\$21.40		\$21.40	

	Palmina	Model	Function	Finish							
				3	L03	5	11P	15	15A	26	26D
		407PLL	Passage UL				\$43.90	\$43.90		\$43.90	\$37.70
		408PLL	Bed/Bath UL				\$46.90	\$46.90		\$46.90	\$41.80
		438PLL SMT	Entry SMT UL				\$72.40	\$72.40		\$72.40	\$67.30
		488PLL	Half Dummy				\$21.40	\$21.40		\$21.40	\$19.40

\*For 438PLL Function must specify RH or LH when ordering



<b>Door Prep</b>	Crossbore 2-1/8" Edge Bore 1" 5-1/2 center-to-center only.
<b>Backset</b>	Complete locksets: 2-3/4 UL or 2-3/8 UL
<b>Door Thickness</b>	1-3/8" - 2-1/4"
<b>Cylinder</b>	<ul style="list-style-type: none"> <li>506, 508 - utilize 6-pin or SmartKey on 780 deadbolt.</li> <li>505, 507 - utilize 5-pin on 660 deadbolt.</li> <li>502 - determined by handleset ordered.</li> <li>SmartKey Security or Pin &amp; Tumbler.</li> </ul>
<b>Faceplates</b>	Complete locksets: No Default—must specify faceplate. 1" round corner, 1" square corner, 1-1/8 WFL square. Complete locksets: UL 3028, 3031, (WFL option 3846).
<b>Strikes</b>	Deadbolt Strike: UL 5278, 3223 (WFL 4632 opt.).
<b>Door Handing</b>	<ul style="list-style-type: none"> <li>506, 508, 505, 507 - reversible.</li> <li>502 - specify handing.</li> </ul>
<b>ANSI/BHMA</b>	<ul style="list-style-type: none"> <li>506, 508, 505, 507 - Grade 3 Certified.</li> <li>502 - Determined by handleset ordered.</li> </ul>
<b>ADA</b>	Lever options are in compliance with the American National Standards Institute (ANSI A117.1) and the Americans with Disabilities Act (ADA).
<b>UL</b>	Meets UL 3 hour fire rating for all functions except 502.
<b>Interior Locking</b>	<ul style="list-style-type: none"> <li>Push button (for Kingston &amp; Carson).</li> <li>Turn button (for Interconnect).</li> </ul>

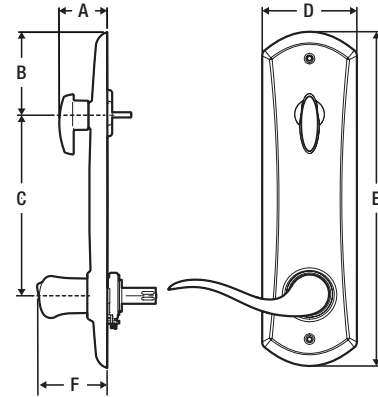

Design	A	B	C	D	E	F
Interconnect	1-7/16"	2-15/32"	5-1/2"	2-53/64"	10"	2-31/32"

### CONTEMPORARY INTERCONNECT

<b>Door Prep</b>	2-1/8" diameter face hole & 1" diameter latch hole.
<b>Backset</b>	Adjustable 2-3/8" or 2-3/4".
<b>Door Thickness</b>	1-3/8" - 1-3/4" automatic adjustment.
<b>Cylinder</b>	<ul style="list-style-type: none"> <li>506 and 508 utilize 6-pin or SmartKey Security on 780 deadbolt.</li> <li>505 utilize 5-pin on 660 deadbolt.</li> <li>502 - determined by handleset ordered.</li> </ul>
<b>Faceplates</b>	1" x 2-1/4" round corner standard.
<b>Strikes</b>	Deadbolt Strike: UL 5278, 3223 (WFL 4632 opt.).
<b>Door Handing</b>	<ul style="list-style-type: none"> <li>506, 508, 505, 507 - reversible.</li> <li>502 - specify handing.</li> </ul>
<b>ANSI/BHMA</b>	<ul style="list-style-type: none"> <li>506, 508, 505 - Grade 3 Certified.</li> <li>502 - Determined by handleset ordered.</li> </ul>
<b>ADA</b>	Lever options are in compliance with the American National Standards Institute (ANSI A117.1) and the Americans with Disabilities Act (ADA).
<b>UL</b>	Meets 3 hour fire rating.

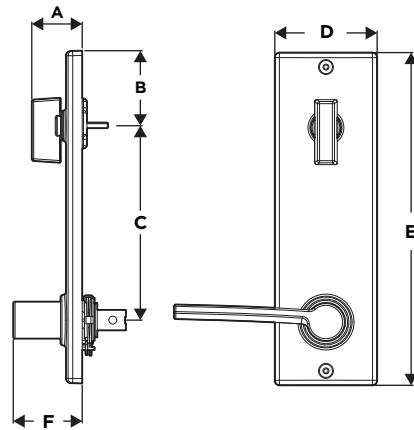

Design	A	B	C	D	E	F
Interconnect	1-13/32"	2-1/16"	5-1/2"	2-27/32"	9-3/16"	1-29/32"



**KEY CONTROL**

SPECIFICATIONS:

<b>Standard Door Prep</b>	Cross Bore 2-1/8". Edge Bore 1" Latch Face 1" x 2-1/4"
<b>Door Thickness</b>	1-3/4"
<b>Cylinder</b>	2 SmartKey Security™ cylinders: 1 standard Kwikset for users, 1 unique patented keyway for 1-Key Control
<b>Faceplate</b>	1" x 2-1/4"
<b>Strike</b>	1 1/4" x 3-5/8"
<b>Bolt</b>	1" throw
<b>ANSI/BHMA</b>	A156.5 Grade 2
<b>ADA</b>	Interior turn piece meets 4.13.9 ADA
<b>UL</b>	Meets UL 3 hour fire rating for UL function. UL Ref# R10923

FUNCTIONS:



**816 Key Control Deadbolt**  
**817 UL Key Control Deadbolt**  
 Deadbolt operated by key outside and thumb turn inside.

DIMENSIONS:

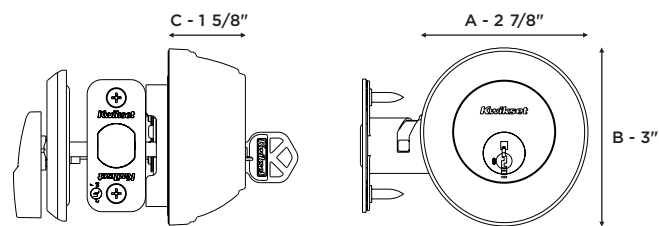

FINISHES:

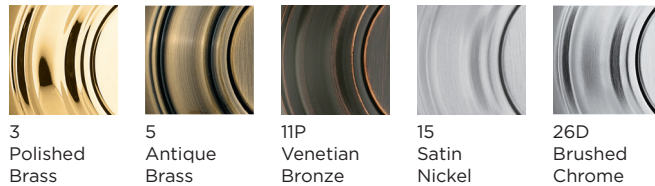

**SMARTCODE 955**

<b>Function</b>	Keyed entry electronic lever
<b>Door Prep</b>	2 1/8" diameter face hole & 1" diameter latch hole
<b>Backset</b>	Adjustable 2 3/8" or 2 3/4"
<b>Door Thickness</b>	1 3/8" - 1 3/4"
<b>Faceplates</b>	1" x 2 1/4" round corner standard
<b>Strikes</b>	Round corner, 4 hole strike, 2 3/4" x 1 1/8"
<b>Latch</b>	Round corner adjustable 2 3/8" x 2 3/4"
<b>Bolt</b>	1/2" throw, dead latch
<b>Door Handing</b>	Reversible
<b>Cylinder</b>	SmartKey Security™

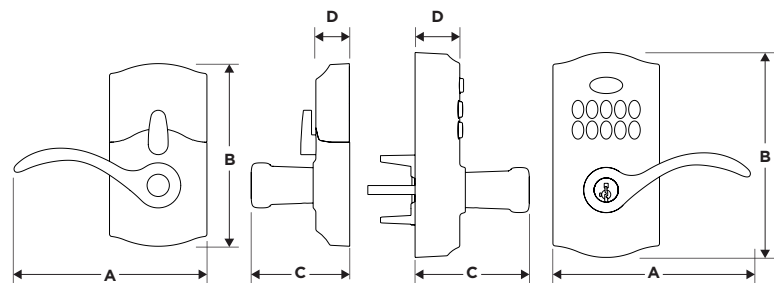

Design	A	B	C	D
Interior	5 5/8" (142.9)	5 5/16" (134.9 mm)	2 7/8" (73 mm)	3 1/32" (24.6 mm)
Exterior	5 3/4" (146 mm)	5 31/32" (151.6 mm)	3 5/16" (84.1 mm)	1 13/32" (35.7 mm)



**KINGSTON LEVER**

ANSI/BHMA	Grade 2 Certified
Door Prep	Crossbore 2-1/8" Edge Bore 1"
Backset	Adjustable to 2-3/8" or 2-3/4".
Door Thickness	1-3/8" – 1-3/4" doors standard
Cylinder	SmartKey Security or Pin & Tumbler.
Latch	Adjustable to 2-3/8" or 2-3/4" Specify round corner or square corner, WFL.
Strikes	2-1/4" full lip UL. Specify round corner or square corner. Other options include 2-3/4" T-Strike and 4-7/8" ASA.
Bolt	1/2" throw.
Door Handing	Reversible for right or left-hand doors.
ADA	Lever options are in compliance with the American National Standards Institute (ANSI A117.1) and the Americans with Disabilities Act (ADA).
UL	Meets UL 3 hour fire rating for all functions
Warranty	Lifetime Mechanical, 5 Year Finish
Interior Locking	Push button (for Kingston & Carson) Turn button (for Interconnect)

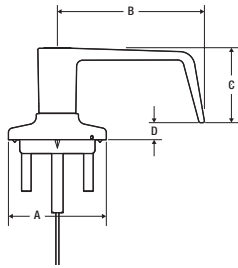

Design	A	B	C	D
Kingston	2.56"	3.84"	1.96"	.44"

**CARSON LEVER**

ANSI/BHMA	Grade 3 Certified
Door Prep	Crossbore 2-1/8" Edge Bore 1"
Backset	Adjustable to 2-3/8" or 2-3/4".
Door Thickness	1-3/8" – 1-3/4" doors standard
Cylinder	SmartKey Security or Pin & Tumbler.
Latch	Adjustable to 2-3/8" or 2-3/4" Specify round corner or square corner, WFL.
Strikes	2-1/4" full lip UL. Specify round corner or square corner. Other options include 2-3/4" T-Strike and 4-7/8" ASA.
Bolt	1/2" throw.
Door Handing	Reversible for right or left-hand doors.
ADA	Lever options are in compliance with the American National Standards Institute (ANSI A117.1) and the Americans with Disabilities Act (ADA).
UL	Meets UL 3 hour fire rating for all functions
Warranty	Lifetime Mechanical, 5 Year Finish
Interior Locking	Push button (for Kingston & Carson) Turn button (for Interconnect)

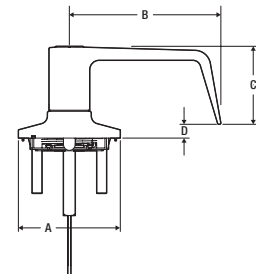

Design	A	B	C	D
Carson	2.56"	3.80"	1.96"	.35"

**BURBANK LEVER**

ANSI/BHMA	Grade 3 Certified
Door Prep	Crossbore 2-1/8" Edge Bore 1"
Backset	Adjustable to 2-3/8" or 2-3/4".
Door Thickness	1-3/8" – 1-3/4" doors standard
Cylinder	Pin & Tumbler.
Latch	RCAL, SCAL, WFAL, NFL
Strikes	ASA-1 t-strike, Full Lip SCS UL, Full Lip 1/4" RCS UL, T Strike
Bolt	1/2" throw.
Door Handing	Reversible for right or left-hand doors.
ADA	Lever options are in compliance with the American National Standards Institute (ANSI A117.1) and the Americans with Disabilities Act (ADA).
UL	Meets UL 3 hour fire rating for all functions
Warranty	Lifetime Mechanical, 5 Year Finish

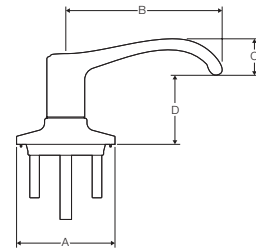

Design	A	B	C	D
Burbank	2.6"	4.07"	0.94"	1.79"

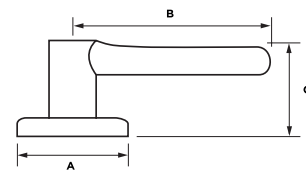

Design	A	B	C	D
Palmina	2.56"	3.75"	1.96"	



**Redmond™**



Model	Function	Finishes			Case	
		11P	15	26	Pkg	Qty
079RDB	24" Towel Bar	\$55.10	\$42.80	\$30.60	BP	6
080RDB	Towel Ring	\$36.70	\$26.50	\$18.40	BP	6
081RDB	Tissue Holder	\$37.70	\$30.60	\$24.50	BP	6
082RDB	Robe Hook	\$13.30	\$13.30	\$10.20	BP	6

**Ashfield™**



Model	Function	Finishes			Case	
		11P	15	Pkg	Qty	
0795ADB	24" Double Towel Bar	\$185.60	\$185.60	CP	4	
079ADB	24" Towel Bar	\$100.00	\$100.00	CP	4	
080ADB	Towel Ring	\$73.40	\$68.30	CP	4	
081ADB	Tissue Holder	\$77.50	\$77.50	CP	4	
082ADB	Robe Hook	\$42.80	\$42.80	CP	4	

**Avalon™**



Model	Function	Finishes			Case	
		11P	15	26	Pkg	Qty
079AVB	24" Towel Bar	\$81.60	\$81.60	\$55.10	CP	4
080AVB	Towel Ring	\$58.10	\$58.10	\$38.80	CP	4
081AVB	Tissue Holder	\$63.20	\$63.20	\$41.80	CP	4
082AVB	Robe Hook	\$34.70	\$34.70	\$25.50	CP	4



**Round Pocket Door Lock**

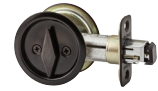

Model	Function	Finish						Case
		11P	15	15A	26D	32	514	Qty
334	Passage	\$37.70	\$37.70	\$37.70	\$37.70	\$37.70	\$37.70	12
335	Privacy	\$41.80	\$41.80	\$41.80	\$41.80	\$41.80	\$41.80	12

**Contemporary Pocket Door Lock**



Model	Function	Finish					Case
		11p	15	26	26D	514	Qty
334	Passage	\$37.70	\$37.70	\$37.70	\$37.70	\$37.70	12
335	Privacy	\$41.80	\$41.80	\$41.80	\$41.80	\$41.80	12

**SmartKey Padlocks**



Part #	Model	List Price	Case
026SMT STD 1-1/8" SHKL PDL 50MM	SmartKey Security Padlock Standard Shackle	\$24.90	6
026SMT LNG 2" SHKL PDL 50MM	SmartKey Security Padlock Long Shackle	\$26.00	6





**Trims**



Model	Description	Finish					Case
		3	5	15	26D	Pkg	Qty
293	Round Rossette	\$17.50			\$18.50	CP	4

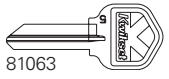
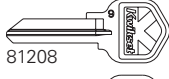
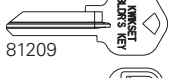

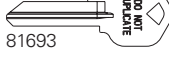
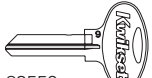
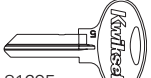
**Kwikset Key Blanks**

	Model	Function	Qty	List Price
	81063-009	K Bow, Nickel Plated, 5 Pin	50	\$1.60/E
	81208-001	K Bow, Nickel Plated, 6 Pin (UltraMax)	50	\$1.60/E
	81209-001	Solid Bow Builders Key, 6 Pin	50	\$1.60/E
	81210-001	Solid Bow Masters Key	50	\$1.60/E
	82205-002	Solid Bow Builders Key, 5 Pin	50	\$1.60/E
	81693-001	Do Not Duplicate Key	50	\$1.60/E
	83559-008	Large Bow, Builder Key, 6 Pin	50	\$1.65/E
	81695-001	Large Bow, Builder Key, 5 Pin	50	\$1.65/E
	82245-001	Baldwin K-Key	50	\$2.30/E
	 83559	 81695	 82245	

**Control Key Blanks (Rekeying Tools)**

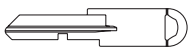
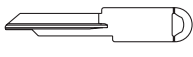
	Model	Function	Qty	List Price
	87615-001	Kwikset 6-Pin Knobs and Deadbolts	50	\$1.65/E
	88122-001	Kwikset 6-Pin Knobs and Deadbolts, MK	50	\$1.65/E
	88485-005	Kwikset Knobs and Deadbolts, Schlage® C	12	\$1.65/E
	81804-001	Kwikset Key-In Lever, Standard "TC"	50	\$1.65/E
	89991-001	Kwikset, Schlage® C	50	\$1.65/E

**Emergency Key**

	Model	Function	Qty	List Price
	81087-001	For All (Turn Button) Privacy Function Locksets	100	\$0.45/E

**\*NOTE:** Use Hex Wrench for push button privacy locksets.

**Depth Key**

	Model	Function	Qty	List Price
	88596-001	Depth Key Ring (Order in full pack quantities only)	5	\$8.85 /E

**Extra Cut Keys 6 Pin**

	Model	Function	List Price
	Random Cut	Specify Cut	
	81208-002	90009-074 Regular Key	\$3.20
	81389-001	Set of 2 Keys / Ringed	\$5.05
	81211-001	Set of 2 Keys w/ Control Key	\$5.05
	81210-002	90009-066 Master Key	\$4.20
	81209-002	90009-069 Builders Key	\$3.20
		90009-082 Control key	\$1.65

**Extra Cut Keys 5 Pin**

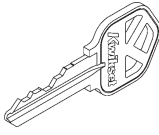
	Model	Function	List Price
	Random Cut	Specify Cut	
	81063-005	Regular Key	\$2.10
	81057-007	Set of 8 Keys / Ringed	\$19.55
	81057-002	Set of 2 Keys / Ringed"	\$5.05
	85991-001	90009-003 Master Key	\$3.50
	82205-001	90009-004 Builders Key	\$2.95

**\*NOTE:** Must specify desired key cut when placing order.



**Keying Charges  
& Supplies**

Model	Function	Qty	List Price
8497-75	Kwikset Signature Series Knob, Schlage® keyway less cylinder cover (3, 26)	6	\$15.35/E
8497-76	Kwikset Signature Series Knob, Weiser keyway less cylinder cover (3, 26)	6	\$15.35/E
81354	Kwikset Signature Series Commonwealth Lever, Weiser cylinder (3, 26D)	6	\$21.85/E
81355	Kwikset Signature Series Commonwealth Lever, Schlage cylinder (3, 26D)	6	\$21.85/E
81326	980/985 Deadbolt double cylinder cover - interior (15, 15A, 26, 26D, 3, 5, L03,11P)	12	\$1.30/E
81327	780/785 Deadbolt single cylinder cover - exterior (15, 15A, 26, 26D, 3, 5, L03,11P)	12	\$1.30/E
81328	780/785 Deadbolt double cylinder cover - interior (3, 5, 11P)	12	\$1.30/E
87748-001	Knob plug - Kwikset 6 pin brass finish	20	\$1.85/E
87807-001	Deadbolt plug - Kwikset Signature Series 6-pin brass finish	20	\$1.85/E
87807-002	Deadbolt plug - Kwikset Signature Series 6-pin nickel finish	20	\$1.85/E
88485-005	Rekeying Tool - Schlage®	12	\$1.30/E

NOTES:  
Order in full pack quantities only. Must specify finish in order.  
Competitive keying program not compatible with SmartKey product.

**Keying Kits**

Model	Function	Qty	List Price
92360-001	236 Builder Pin Kit - small	1	\$154.40
92720-001	272 Pin Kit	1	\$272.80

**Specialty Keying  
Charges**

Code	Description	List Price
MK	Master Keying	\$2.75
PK	Builder Keying (Protecto)	\$2.75
GMK	Grand Master Keying	\$7.75
PMK	Builder Master Keying	\$4.75
MAIS	Cross Keying / Maison Keying	\$5.75
SEQ	Sequential Construction Master Keying	\$9.40





**Replacement Parts for Kwikset Pin and Tumbler Keying**

Model	Pin Size	Qty	List Price
80049-001	Key Gauge	1	\$7.55/E
80152-001	Plug Follower	1	\$8.05/E
80369-001	PK Anti-Pick Top Pin .160"	100	\$0.35/E
80370-001	Regular Anti-Pick Top Pin .180"	100	\$0.35/E
80371-001	Low Profile Deadbolt Spring Cover	10	\$1.30/E
81467-003	Cylinder Removal Tool	1	\$1.95/E
81777-001	Tumbler Spring	100	\$0.15/E
81858-001	Regular Top Pin .180"	100	\$0.15/E
82208-001	PK Balls	100	\$0.15/E
83100-001	#1 Bottom Pin .172"	100	\$0.15/E
83101-001	#2 Bottom Pin .195"	100	\$0.15/E
83103-001	#3 Bottom Pin .218"	100	\$0.15/E
83105-001	#4 Bottom Pin .241"	100	\$0.15/E
83106-001	#5 Bottom Pin .264"	100	\$0.15/E
83107-001	#6 Bottom Pin .287"	100	\$0.15/E
83108-001	#1 Master Pin .023"	100	\$0.15/E
83110-001	#2 Master Pin .046"	100	\$0.15/E
83112-001	#3 Master Pin .069"	100	\$0.15/E
83113-001	#4 Master Pin .092"	100	\$0.15/E
83114-001	#5 Master Pin .115"	100	\$0.15/E
83117-001	PK Top Pin .160"	100	\$0.15/E
83125-001	#6 Master Pin .138"	100	\$0.15/E
83561-001	Spring Cover (6-Pin)	50	\$1.20/E
84345-001	Knob Plug Retainer	100	\$0.15/E
84215-001	Deadlock Plug Retainer	100	\$0.15/E
85757-001	Spring Cover (5-Pin)	50	\$1.20/E
87619-001	Knob Control Lug (Locking Bar)	100	\$0.35/E
87632-001	Spring	100	\$0.55/E
87809-001	Deadlock Control Lug (Locking Bar)	100	\$0.70/E

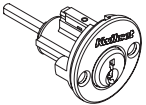
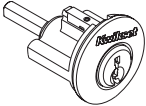
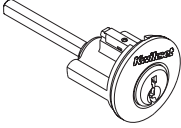
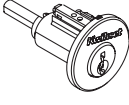
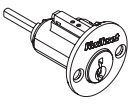
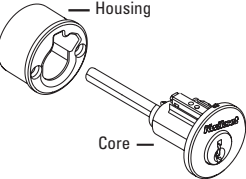
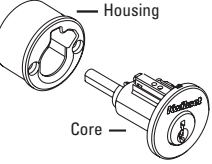
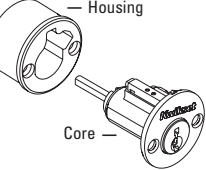
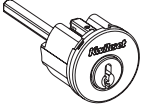

**Deadbolt Cylinders**

	Model	Function	List Price
	90009-016	2776 - 665 Interior (5 Pin)	\$15.85
	90009-017	2777 - 665 Exterior (5 PIN)	\$15.85
	90009-041	15843 - 660 Exterior (5 Pin)	\$15.85
	90009-045	785 Exterior without Housing (6 PIN)	\$17.95
	90009-046	785 Interior without Housing	\$17.95
	90009-010	87765 - 780 with Housing, Complete Assembly	\$23.05
	87894-001	07894-01 Housing Only, Outside	\$5.20
	90009-044	8325 - 780 Core without Housing	\$17.95
	90009-019	7766 - 785 Exterior with Housing, Complete Assembly	\$23.05
	87894-001	07894-01 Housing Only, Outside	\$5.20
	90009-020	7767 - 785 Interior with Housing, Complete Assembly	\$23.05
	90009-065	13443 980/ 993 CYL G1 (6 PIN)	\$46.80
	81227	13423 CVR CYL BDY EXT G1	\$1.30
	90009-078	13448 985/994 CYL Interior (6 PIN)	\$47.90
	90009-079	13450 985/ 994 CYL Exterior (6 PIN)	\$46.80

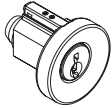
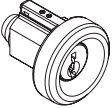
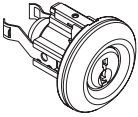
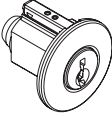
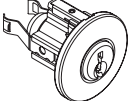

**Pin & Tumbler Knob Cylinders**

	Model	Function	List Price
	90009-011	7750A - Abbey (6 PIN)	\$14.50
	90009-012	13754 - Circa (6 Pin)	\$14.50
	90009-042	15860 - Polo (5 PIN)	\$19.50
	90009-043	13752 - Hancock (6 PIN)	\$14.50
	90009-013	1850 - All Other Kwikset and Kwikset Signatures Knobs	\$19.50

**Pin & Tumbler Lever Cylinders**

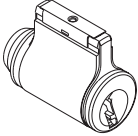
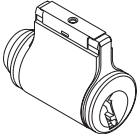
	Model	Function	List Price
	90009-077	24042 - 5-Pin P&T Cylinder	\$16.45
	90009-076	21664 Kwikset Signatures Lever Cylinder (6 PIN)	\$16.45

**Pin & Tumbler Light Commercial Lever Cylinders**

	Model	Function	List Price
	83525	14831 Light Commercial Grade 2 P&T Entry Cylinder	\$14.35
	83011	14845 Light Commercial Grade 3 P&T Entry Cylinder	\$14.35
	83526	19496 Light Commercial Grade 2 P&T Storeroom Cylinder	\$14.35
	83528	19497 Light Commercial Grade 3 P&T Storeroom Cylinder	\$14.35

NOTE: Must specify finish when ordering cylinders



**Smartkey Security Cylinders**

Model	Function	Finish										List Price
		3	LO3	5	15	15A	26	26D	690/11P	514	NA	
83279	SMT Knob/Lever Cylinder Only	Gold			Silver				Bronze	Black		\$21.30
83373	SMT Deadbolt Cylinder Plug Only (Single Cylinder)	Gold			Silver				Bronze	Black		\$21.30
83025	SMT Deadbolt Cylinder Only for 258/818 Models	Gold			Silver					Black		\$21.30
83280	SMT CN, C, H, T, CV Cylinder With Housing	•		•	•	•	•	•	•	•		\$21.30
83320	SMT CA, A Cylinder With Housing	•	•	•	•	•	•	•	•			\$21.30
83281	SMT 780/980 DB With Housing	•	•	•	•	•	•	•	•			\$47.45
83343	SMT 660 DB with Housing	•		•	•	•	•	•	•			\$22.80
83344	SMT 665 DB with Housing Interior & Exterior	•		•	•	•	•	•	•			\$45.55

**Smartkey Security Re-Key Kits**

Model	Function	Finish										List Price
		3	LO3	5	15	15A	26	26D	690/11P	514	NA	
83262	Carded CP Rekey Kit (4 silver/2 brass)										•	\$15.75
83335	4 cut keys with a rekey tool										•	\$5.55
83336	6 cut keys with a rekey tool										•	\$6.20

**Smartkey Security Conversion Kits**



Model	Function	Finish										List Price
		3	LO3	5	15	15A	26	26D	690/11P	514	NA	
83325	Abbey & circa	•	•	•	•	•	•	•	•			\$27.20
83328	Cameron, Hancock, Tylo, and Cove	•	•	•	•	•	•	•	•	•		\$27.75
83377	Polo	•		•	•	•	•	•	•			\$27.75
83326	780/980/800	•	•	•	•	•	•	•	•	•		\$50.00
83327	785	•	•	•	•	•	•	•	•	•		\$69.40
83340	985 /801		•	•	•	•	•	•	•	•		\$69.40

**Re-Keying Tools**

Model	Function	Finish										List Price
		3	LO3	5	15	15A	26	26D	690/11P	514	NA	
83282	Steel Learn Tool										•	\$1.00
83283	Red Plastic KW Learn Tool										•	\$3.15
83576	Learn Tool, T shape										•	\$3.85
83260	Reset Cradle										•	\$47.25
83374	SmartKey Full Round Spindle										•	\$1.05



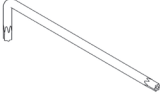

**Key Control Deadbolt Parts**

	Model	Function	Finish						Qty	List Price
			3	5	11P	15	26D	N/A		
	83382	Key Control Deadbolt Key Blanks						•	10	\$3.50
	83383	Key Control Deadbolt Cut Keys						•	10	\$4.20
	83389	Key Control Deadbolt Cylinder Cover	•	•	•	•	•		1	\$2.75
	83390	Key Control Deadbolt Mounting Screws	Gold			Silver			1	\$6.20
	83388	Key Control Deadbolt Torque Blade						•	10	\$1.85
	83386	Key Control Deadbolt Gear Assembly						•	1	\$6.95
	83387	Key Control Deadbolt Screws for Gear Assembly						•	1	\$1.40
	83395	Key Control Deadbolt Tool						•	1	\$4.20
	83393	Key Control Deadbolt Security Mounting Screws	Gold	Gold		Silver	Silver		1	\$4.20
	83394	Torx Wrench						•	1	\$5.55
	83397	Key Control Deadbolt Thin Door Kit	•			•	•		1	\$13.75

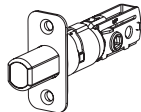
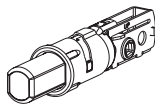

**Deadbolt Adjustable Latches**

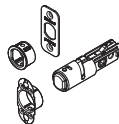
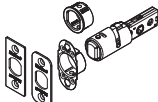
	Model	Latch	Function	Finish							List Price	
				3	5	15	15A	26/26D	690/11P	514		NA
	81305	RCAL	660 Series Deadbolt Standard	•	•	•	•	•	•		\$10.50	
	81258	RCAL	780/782/816/817/980/982 Series Deadbolt Standard UL 3 hour	•		•		•	•		\$27.15	
	83347	RCAL	158/780/816/980 Deadbolt Standard	•	•	•	•	•	•	•	\$16.35	
	80391	RCAL	Tapered Deadbolt Latch Kit*	•		•			•		\$27.15	
*Replacement Only												
	81306	RFAL	660 Series Deadbolt Standard								•	\$10.50
	83371	RFAL	158/780/816/980/982 Series Deadbolt Standard								•	\$16.35
	80393	RFAL	Tapered Deadbolt Latch Kit*	•		•			•			\$27.15
*Replacement Only												
	81308	SCAL	660 Series Deadbolt Standard	•	•	•	•	•	•			\$10.50
	84513	SCAL	780/782 Series Deadbolt Standard UL 3 hour	•	•	•	•	•	•			\$19.70
	81257	SCAL	816/817/980/982 Series Deadbolt Standard UL 3 hour latch	•		•		•	•			\$27.15
	83370	SCAL	158/780/816/980 Series Deadbolt Standard	•	•	•	•	•	•	•		\$16.35
*Replacement Only												
	83002	4AL	4AL 158/780/816/980 Series Deadbolt				•		•	•		\$22.95
	83023	6AL	6AL 258/818 Series Deadbolt			•		•	•	•		\$22.10

**Deadbolt Specialty Latches**

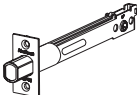
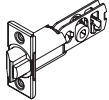
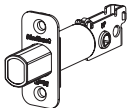
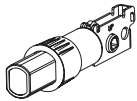
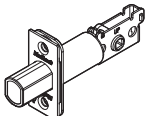
	Model	Latch	Function	Finish							List Price	
				3	5	15	15A	26/26D	690/11P	514		NA
	82730	5L	5" Kwikset (replacement part only)	•	•			•				\$15.85
	83277	Gatelatch	Gatelatch Standard	•	•			•				\$26.00
	82731	RCL	2-3/8" Backset	•	•			•	•			\$11.55
	82732	RCL	2-3/4" Backset	•	•			•	•			\$11.55
	82734	RFL	2-3/8" Backset								•	\$11.55
	82735	RFL	2-3/4" Backset								•	\$11.55
	82728	SCL	2-3/8" Backset	•	•			•	•			\$11.55
	82729	SCL	2-3/4" Backset	•	•			•	•			\$11.55

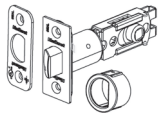
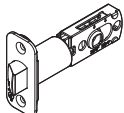
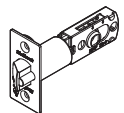
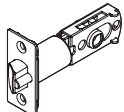

**Adjustable Latches (Square Drive)**

	Model	Latch	Function	Finish							List Price	
				3	5	15	15A	26/26D	690/11P	514		NA
	83480	6AL	6AL Plain Latch HFL, MIL, LSL, MRL, SYL			•		•	•	•		\$13.75
	83000	6AL	6AL Deadlatch BBL, KNL, CNL, HFL, MIL, LSL, MRL, PLL, SYL			•		•	•	•		\$14.90
	83521	RCAL	RCAL Plain Latch UL 3 hour BBL, KNL, CNL, PLL	•		•		•	•			\$11.80
	83518	RCAL	RCAL Deadlatch UL 3 HOUR BBL, KNL, CNL, HFL, MIL, LSL, MRL, PLL, SYL	•		•		•	•			\$13.65
	83522	WFAL	WFAL SCL Plain Latch UL 3 hour BBL, KNL, CNL, PLL	•		•		•	•			\$11.80
	83010	WFAL	WFAL SCL Deadlatch UL 3 hour BBL, KNL, CNL, HFL, MIL, LSL, MRL, PLL, SYL	•		•		•	•			\$13.65
	83520	SCAL	SCAL Plain Latch UL 3 HOUR BBL, KNL, CNL, PLL	•		•		•	•			\$11.80
	83517	SCAL	SCAL Deadlatch UL 3 HOUR BBL, KNL, CNL, HFL, MIL, LSL, PLL	•		•		•	•			\$13.65

**Adjustable Latches (Half-Round Drive)**

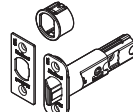
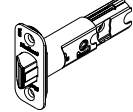
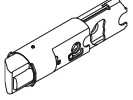

	Model	Latch	Function	Finish							List Price	
				3	5	15	15A	26/26D	690/11P	514		NA
	81825	6AL	6AL Deadlatch	•	•			•				\$13.65
	81826	6AL	6AL Plain Latch	•	•			•				\$11.80
	82246	RCAL	RCAL Plain Latch	•	•	•	•	•	•	•		\$11.80
	82247	RCAL	RCAL Deadlatch	•	•	•	•	•	•	•		\$13.65
	81846	Core Latch	Adjustable Latch Core - Deadlatch								•	\$10.00
	81847	Core Latch	Adjustable Latch Core - Plain Latch								•	\$7.05

<b>Key:</b>	
5L - 5" Latch	RFAL - Round Face Adjustable Latch
RCL - Round Corner Latch	SCAL - Square Corner Adjustable Latch
RFL - Round Face Latch (Drive-In Collar attached)	WFAL - Wide Face Adjustable Latch
SCL - Square Corner Latch	NFAL - Narrow Face Adjustable Latch
RCAL - Round Corner Adjustable Latch	FD - Latch

**NOTES:**  
 For BBL, KNL, CNL, HFL, MIL, PLL, MRL, LSL, and SYL products use square drive plain and deadlatches. All other Kwikset & Kwikset Signature knob and lever products use half-round plain and deadlatches. Plainlatches are used with passage and privacy functions. Deadlatches are used with entry functions. All fronts are 2-1/4" high.  
 For fire rating, UL latches must be used with UL listed locksets and applicable strikes. UL Kwikset and Kwikset Signatures are rated for 3 hours, unless otherwise specified.  
 Optional UL 1/3 hour fire rating is available for all functions (FD).

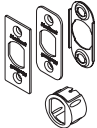

**Half Round Latch Parts**

	Model	Latch	Function	Finish							List Price	
				3	5	15	15A	26/26D	690/11P	514		NA
	81827	Back Plate	6-Way Back Plate								•	\$0.20
	* For use with Kwikset Half Round Latches											
	81828	Drive In Collar	6-Way Deadlatch Collar								•	\$1.90
	81829	Drive In Collar	6-Way Plain Latch Collar								•	\$1.90
	* For use with Kwikset Half Round Latches											
	81844	Service Kit	6-Way Deadlatch Service Kit	•	•	•	•	•	•	•		\$4.85
	81845	Service Kit	6-Way Plain Latch Service Kit	•	•	•	•	•	•	•		\$3.75
	* For use with Kwikset Half Round Latches											

**Specialty Deadlatches**

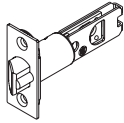
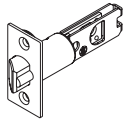
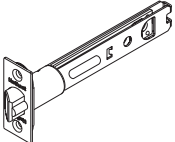
	Model	Latch	Function	Finish							List Price	
				3	5	15	15A	26/26D	690/11P	514		NA
	84292	SCDL	2-3/4" Backset - UL 3 hour	•	•	•	•	•	•			\$25.25
	84297	SCDL	2-3/8" Backset - UL 3 hour	•	•	•	•	•	•			\$25.25
	84255	WFDL	2-3/4" Backset - UL 3 hour	•	•	•	•	•	•			\$25.25
	84295	WFDL	2-3/8" Backset - UL 3 hour	•	•	•	•	•	•			\$25.25
	83014	5L SCDL	5" Latch (replacement part only)	•	•			•				\$18.30

**Specialty Plainlatches**

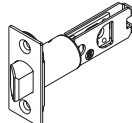
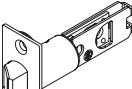



	Model	Latch	Function	Finish							List Price	
				3	5	15	15A	26/26D	690/11P	514		NA
	84290	SCPL	2-3/4" Backset - UL	•	•	•	•	•	•			\$19.05
	84296	SCPL	2-3/8" Backset - UL	•	•	•	•	•	•			\$19.05
	84254	WFPL	2-3/4" Backset - UL	•	•	•	•	•	•			\$19.05
	84294	WFPL	2-3/8" Backset - UL	•	•	•	•	•	•			\$19.05

<b>KEY:</b>	
5L - 5" Latch	RFAL - Round Face Adjustable Latch
DL - Deadlatch	SCAL - Square Corner Adjustable Latch
RC - Round Corner	SCDL - Square Corner Deadlatch
SC - Square Corner	SCPL - Square Corner Plainlatch
RCL - Round Corner Latch	WFAL - Wide Face Adjustable Latch
RFL - Round Face Latch (Drive In Collar attached)	WFDL - Wide Face Deadlatch
SCL - Square Corner Latch	WFPL - Wide Face Plainlatch
RCAL - Round Corner Adjustable Latch	FD - Latch



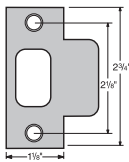
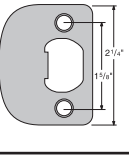
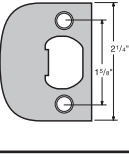
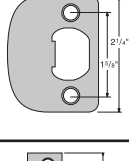
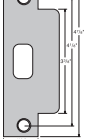

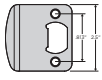
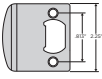
**Plainlatch and Deadlatch**

	Model	Function	Finish							List Price																					
			3	5	15	15A	26/26D	690/11P	514		NA																				
	80318	Full Round, Adjustable Strike (500 Per Box)	•	•		•				\$1,835.60																					
	80318	Full Round, Adjustable Strike (500 Per Box)			•		•	•		\$2,523.95																					
	<table border="1"> <thead> <tr> <th></th> <th>3</th> <th>5</th> <th>15</th> <th>15A</th> <th>26/26D</th> <th>690/11P</th> <th>514</th> <th>NA</th> <th></th> </tr> </thead> <tbody> <tr> <td>83028**</td> <td>T (30 per carton)</td> <td>•</td> <td>•</td> <td>•</td> <td>•</td> <td>•</td> <td>•</td> <td>•</td> <td></td> <td>\$3.50</td> </tr> </tbody> </table> <p>Standard on 588, 589 and UL Listed Knob and Lever sets. Add \$0.45 elsewhere.</p>											3	5	15	15A	26/26D	690/11P	514	NA		83028**	T (30 per carton)	•	•	•	•	•	•	•		\$3.50
	3	5	15	15A	26/26D	690/11P	514	NA																							
83028**	T (30 per carton)	•	•	•	•	•	•	•		\$3.50																					
	<table border="1"> <thead> <tr> <th></th> <th>3</th> <th>5</th> <th>15</th> <th>15A</th> <th>26/26D</th> <th>690/11P</th> <th>514</th> <th>NA</th> <th></th> </tr> </thead> <tbody> <tr> <td>83030**</td> <td>Full Lip Square Corner Strike, UL</td> <td>•</td> <td>•</td> <td>•</td> <td>•</td> <td>•</td> <td>•</td> <td>•</td> <td></td> <td>\$4.70</td> </tr> </tbody> </table>											3	5	15	15A	26/26D	690/11P	514	NA		83030**	Full Lip Square Corner Strike, UL	•	•	•	•	•	•	•		\$4.70
		3	5	15	15A	26/26D	690/11P	514	NA																						
83030**	Full Lip Square Corner Strike, UL	•	•	•	•	•	•	•		\$4.70																					
	<table border="1"> <thead> <tr> <th></th> <th>3</th> <th>5</th> <th>15</th> <th>15A</th> <th>26/26D</th> <th>690/11P</th> <th>514</th> <th>NA</th> <th></th> </tr> </thead> <tbody> <tr> <td>83031**</td> <td>Full Lip 1/4" Square Corner Strike, UL</td> <td>•</td> <td>•</td> <td>•</td> <td>•</td> <td>•</td> <td>•</td> <td>•</td> <td></td> <td>\$4.70</td> </tr> </tbody> </table>											3	5	15	15A	26/26D	690/11P	514	NA		83031**	Full Lip 1/4" Square Corner Strike, UL	•	•	•	•	•	•	•		\$4.70
		3	5	15	15A	26/26D	690/11P	514	NA																						
83031**	Full Lip 1/4" Square Corner Strike, UL	•	•	•	•	•	•	•		\$4.70																					
	<table border="1"> <thead> <tr> <th></th> <th>3</th> <th>5</th> <th>15</th> <th>15A</th> <th>26/26D</th> <th>690/11P</th> <th>514</th> <th>NA</th> <th></th> </tr> </thead> <tbody> <tr> <td>83437*</td> <td>Full Lip Square Corner</td> <td>•</td> <td>•</td> <td>•</td> <td>•</td> <td>•</td> <td>•</td> <td>•</td> <td></td> <td>\$3.50</td> </tr> </tbody> </table> <p>*Standard on Non-UL Locksets</p>											3	5	15	15A	26/26D	690/11P	514	NA		83437*	Full Lip Square Corner	•	•	•	•	•	•	•		\$3.50
		3	5	15	15A	26/26D	690/11P	514	NA																						
83437*	Full Lip Square Corner	•	•	•	•	•	•	•		\$3.50																					
	<table border="1"> <thead> <tr> <th></th> <th>3</th> <th>5</th> <th>15</th> <th>15A</th> <th>26/26D</th> <th>690/11P</th> <th>514</th> <th>NA</th> <th></th> </tr> </thead> <tbody> <tr> <td>83796*</td> <td>Full Lip 1/4" Round Corner (RCS4)</td> <td>•</td> <td>•</td> <td>•</td> <td>•</td> <td>•</td> <td>•</td> <td>•</td> <td></td> <td>\$3.50</td> </tr> </tbody> </table>											3	5	15	15A	26/26D	690/11P	514	NA		83796*	Full Lip 1/4" Round Corner (RCS4)	•	•	•	•	•	•	•		\$3.50
		3	5	15	15A	26/26D	690/11P	514	NA																						
83796*	Full Lip 1/4" Round Corner (RCS4)	•	•	•	•	•	•	•		\$3.50																					
	<table border="1"> <thead> <tr> <th></th> <th>3</th> <th>5</th> <th>15</th> <th>15A</th> <th>26/26D</th> <th>690/11P</th> <th>514</th> <th>NA</th> <th></th> </tr> </thead> <tbody> <tr> <td>83846**</td> <td>ASA-1 (30 per carton)</td> <td>•</td> <td>•</td> <td>•</td> <td>•</td> <td>•</td> <td>•</td> <td>•</td> <td></td> <td>\$11.10</td> </tr> </tbody> </table> <p>*Add \$4.90 to Knob and Lever sets and specify 81967 strike box.</p>											3	5	15	15A	26/26D	690/11P	514	NA		83846**	ASA-1 (30 per carton)	•	•	•	•	•	•	•		\$11.10
		3	5	15	15A	26/26D	690/11P	514	NA																						
83846**	ASA-1 (30 per carton)	•	•	•	•	•	•	•		\$11.10																					
	<table border="1"> <thead> <tr> <th></th> <th>3</th> <th>5</th> <th>15</th> <th>15A</th> <th>26/26D</th> <th>690/11P</th> <th>514</th> <th>NA</th> <th></th> </tr> </thead> <tbody> <tr> <td>83929</td> <td>Full Round 1- 3/4"</td> <td>•</td> <td>•</td> <td>•</td> <td>•</td> <td>•</td> <td>•</td> <td>•</td> <td></td> <td>\$3.50</td> </tr> </tbody> </table>											3	5	15	15A	26/26D	690/11P	514	NA		83929	Full Round 1- 3/4"	•	•	•	•	•	•	•		\$3.50
		3	5	15	15A	26/26D	690/11P	514	NA																						
83929	Full Round 1- 3/4"	•	•	•	•	•	•	•		\$3.50																					
	<table border="1"> <thead> <tr> <th></th> <th>3</th> <th>5</th> <th>15</th> <th>15A</th> <th>26/26D</th> <th>690/11P</th> <th>514</th> <th>NA</th> <th></th> </tr> </thead> <tbody> <tr> <td>83536</td> <td>Round Corner Extended Lip Strike 2-1/4" Qty 10</td> <td>•</td> <td></td> <td>•</td> <td></td> <td>•</td> <td>•</td> <td></td> <td></td> <td>\$3.50</td> </tr> </tbody> </table>											3	5	15	15A	26/26D	690/11P	514	NA		83536	Round Corner Extended Lip Strike 2-1/4" Qty 10	•		•		•	•			\$3.50
		3	5	15	15A	26/26D	690/11P	514	NA																						
83536	Round Corner Extended Lip Strike 2-1/4" Qty 10	•		•		•	•			\$3.50																					
	<table border="1"> <thead> <tr> <th></th> <th>3</th> <th>5</th> <th>15</th> <th>15A</th> <th>26/26D</th> <th>690/11P</th> <th>514</th> <th>NA</th> <th></th> </tr> </thead> <tbody> <tr> <td>83537</td> <td>Square Corner Extended Lip Strike 2-1/4" Qty 10</td> <td>•</td> <td></td> <td>•</td> <td></td> <td>•</td> <td>•</td> <td></td> <td></td> <td>\$3.50</td> </tr> </tbody> </table>											3	5	15	15A	26/26D	690/11P	514	NA		83537	Square Corner Extended Lip Strike 2-1/4" Qty 10	•		•		•	•			\$3.50
		3	5	15	15A	26/26D	690/11P	514	NA																						
83537	Square Corner Extended Lip Strike 2-1/4" Qty 10	•		•		•	•			\$3.50																					
	<table border="1"> <thead> <tr> <th></th> <th>3</th> <th>5</th> <th>15</th> <th>15A</th> <th>26/26D</th> <th>690/11P</th> <th>514</th> <th>NA</th> <th></th> </tr> </thead> <tbody> <tr> <td>83534</td> <td>Round Corner Adjustable Strike 2-1/4"</td> <td>•</td> <td></td> <td>•</td> <td></td> <td>•</td> <td>•</td> <td></td> <td></td> <td>\$3.50</td> </tr> </tbody> </table>											3	5	15	15A	26/26D	690/11P	514	NA		83534	Round Corner Adjustable Strike 2-1/4"	•		•		•	•			\$3.50
		3	5	15	15A	26/26D	690/11P	514	NA																						
83534	Round Corner Adjustable Strike 2-1/4"	•		•		•	•			\$3.50																					

NOTES:  
 \*20-minute fire rating with UL locks and latchbolts.  
 \*\* 3-hour fire rating with UL Kwikset Signatures and 1.5 hour fire rating with UL Kwikset locks and latchbolts.



**Deadbolt Strikes**    **Model**    **Function**    **Finishes**    **List Price**

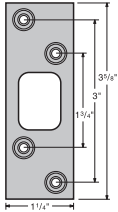

		3	5	15	15A	26/26D	690/11P	514	NA	
83222**	Square Corner Strike: Used on Grade 2 Deadbolts	•	•	•	•	•	•	•		\$4.20

780, 785, 980, 985, 258, 800, 801, 553, 554, 818 Deadbolts. Add \$1.45 to 660 Series Deadbolts

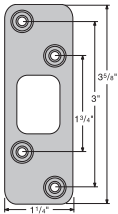

		3	5	15	15A	26/26D	690/11P	514	NA	
83223**	Round Corner Strike: Used on Grade 2 Deadbolts	•	•	•	•	•	•	•		\$4.20

780, 785, 980, 985, 258, 800, 801, 553, 554, 818 Deadbolts. Add \$1.45 to 660 Series Deadbolts

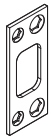

		3	5	15	15A	26/26D	690/11P	514	NA	
820049**	Square Corner Strike: Used on Grade 1 Deadbolts	•	•	•	•	•	•	•		\$4.20

780, 785, 980, 985, 258, 800, 801, 553, 554, 818 Deadbolts. Add \$1.45 to 660 Series Deadbolts



		3	5	15	15A	26/26D	690/11P	514	NA	
820050**	Round Corner Strike: Used on Grade 1 Deadbolts	•	•	•	•	•	•	•		\$4.20

780, 785, 980, 985, 258, 800, 801, 553, 554, 818 Deadbolts. Add \$1.45 to 660 Series Deadbolts

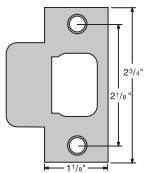

		3	5	15	15A	26/26D	690/11P	514	NA	
84632**	Deadbolt T-Strike (60 per carton)	•	•	•	•	•	•	•		\$3.50

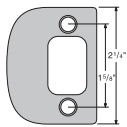

		3	5	15	15A	26/26D	690/11P	514	NA	
84638**	Deadbolt, Full Lip	•	•	•	•	•	•	•		\$3.50

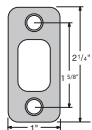

		3	5	15	15A	26/26D	690/11P	514	NA	
85063**	Deadbolt 1"x 2-1/4" Round Corner (RCS4)	•	•	•	•	•	•	•		\$3.50

Standard on 660, 665 Deadbolts.

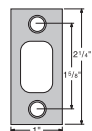

		3	5	15	15A	26/26D	690/11P	514	NA	
85072**	Deadbolt 1"x 2-1/4"	•	•	•	•	•	•	•		\$3.50

Standard on 660, 665 Deadbolts.

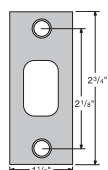

		3	5	15	15A	26/26D	690/11P	514	NA	
85278**	Deadbolt, 1-1/8" x 2- 3/4"	•	•	•	•	•	•	•		\$3.50

Standard on 782, 784 Deadbolts.

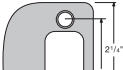

Deadbolt Strikes	Model	Function	Finishes							List Price	
			3	5	15	15A	26/26D	690/11P	514		NA
	85303**	Deadbolt, Full lip Round Corner	•	•	•	•	•	•	•	•	\$3.50

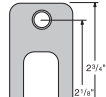
	85279**	Deadbolt, 1-1/8" x 2- 3/4" Round Corner	•	•	•	•	•	•	•	•	\$3.50
Standard on 782, 784 Deadbolts.											

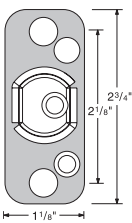
Strike Boxes	Model	Function	Finishes							List Price	
			3	5	15	15A	26/26D	690/11P	514		NA
	81225	Box for 5278/5279 Strikes								•	\$3.75

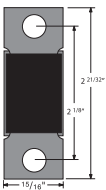
	81231	Box for 83028 T Strike								•	\$1.05
--	-------	------------------------	--	--	--	--	--	--	--	---	--------

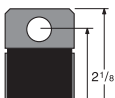
	83288	Box for Full Lip Strikes*								•	\$1.50
*Add \$0.45 to locksets using full lip strike.											

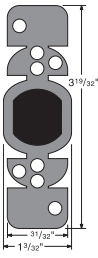
	81640	Box for all Deadbolt Strikes								•	\$1.05
---	-------	------------------------------	--	--	--	--	--	--	--	---	--------

	81967	Box for 83846 ASA-1 Strike								•	\$5.00
---	-------	----------------------------	--	--	--	--	--	--	--	---	--------

**NOTES:**

\*20-minute fire rating with UL locks and latchbolts.

\*\* 3-hour fire rating with UL Kwikset Signatures and 1.5 hour fire rating with UL Kwikset locks and latchbolts.



**Knobs and Levers**

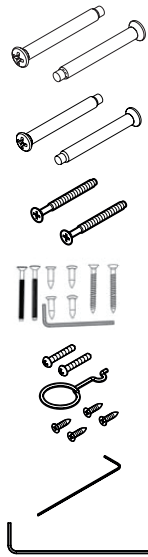

Model	Function	Finish							List Price
		3	5	15/15A	26/26D	690/11P	514	NA	
81834	Machine Screws used on the following: A, CA, H, L							•	\$1.05
81835	Machine Screws used on the following: ADL, AVL, BRL, CHL, LL, PML, PSK, TNL, DL, DNL, BL, KTL, VDL, LRL	•		•	•	•	•		\$0.55
83369	Signature Knob Screw Pack Styles: C, CN, PE/Kwikset Screw Pack Styles: CV, P, T	•							\$0.55
83001	Signatures Entry Lever Screw Pack: HFL, MIL, LSL, MRL, SYL			•	•	•			\$5.05
820284	Signatures Passage & Privacy: HFL, MIL, LSL, MRL, SYL								\$3.45
83523	Light Commercial Screw Pack: Kingston	•		•	•	•			\$3.75
83524	Light Commercial Screw Pack: Carson, BBL, CNL, PPL	•		•	•	•			\$3.75
83258	Lever Set Screw With Hex Wrench (3/32")							•	\$0.70
83398	Lever Set Screw With Hex Wrench for MRL, SYL, HFL, MIL, LSL							•	\$5.70

**NOTES:**  
\*If 15 or 15A not available, 515 (Gray Chromate) is the default finish

**Reversible Leverset Screws**



Model	Function	Finishes							List Price
		3	5	15/15A	26/26D	690/11P	514	NA	
83254	Passage/Privacy/Interior Entry SMT							•	\$0.20
83255	Interior Pin & Tumbler Entry							•	\$0.20
83256	Exterior Entry Pin & Tumbler & SMT							•	\$0.20
83257	Exterior Entry SMT							•	\$0.20









**Handlesets**

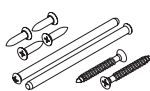

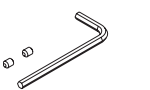
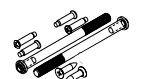

Model	Function	Finish							List Price
		3	5	15/15A	26/26D	690/11P	514	NA	
86151	Kwikset Handleset Screw Pack Styles: A, CA, H, L, ADL, AVL, BRL, CHL, PML, CE, AVH, ADH, SE, HE	•	•	•	•	•			\$1.40
82215	Signatures Handleset Decorative Interior Screw Cap Cover: ADH, AVH, AT, AUH, HE, MNH, SE, WN, PTH	•	•	•	•	•	•		\$2.25
82213	Screw & Washer for ADH, AVH, AT, HE, SE, AVH, TVH							•	\$0.80
81696	Signature Handleset Cap for 818 and 819 CMH, SCE, TVH, VNH			•	•	•	•		\$2.25
83004	Screw and Washer for ADH, AVH, CMH, PTH, SCE, VNH							•	\$0.80
84307	Screw & Washer for AUH and MNH							•	\$0.75
88322	Sex Nut Set & Wood Screw: , CE, AMD, BW, DA	•	•	•	•	•			\$5.80

**NOTES:**  
\*If 15 or 15A not available, 515 (Gray Chromate) is the default finish

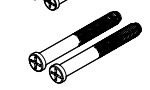

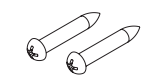
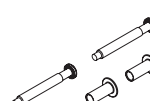
Deadbolts	Model	Function	Finishes						List Price	
			3	5	15/15A	26/26D	690/11P	514		NA
	86171	660 Deadbolt Screw Pack	•	•	•		•			\$1.40
	86099	665 Deadbolt Screw Pack	•	•	•	•	•			\$2.25
	86073	One-Way Screws, 665 Deadbolt	•	•	•	•	•			\$1.30
	81247	P&T and SMT 780/782/980/982 Deadbolt Screw Pack	•	•	•	•	•			\$4.70
	81251	980 Series Deadbolt, Turnpiece Screw & Wrench							•	\$4.70
	83474	P&T and SMT 784, 785, 984, 985, Deadbolt Screw Pack	•	•	•	•	•			\$10.00
	820285	P&T and SMT 158 Deadbolt Screw Pack			•	•	•			\$4.70
	820286	P&T and SMT 159 Deadbolt Screw Pack			•	•	•			\$10.00
	83015	Standard Screw Pack for 258 Series Deadbolt	•		•	•		•		\$5.70
	83017	Thin Door Screw Pack for 258 Series Deadbolt			•	•		•		\$5.70

Dummy/In-Active	Model	Function	Finishes						List Price	
			3	5	15/15A	26/26D	690/11P	514		NA
	81708	488 & 788 Dummy Mounting Screws	•	•	•	•	•			\$1.15
	81892	488 Dummy Adapter	•	•	•	•	•			\$5.85

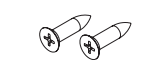
Latch	Model	Function	Finishes						List Price	
			3	5	15/15A	26/26D	690/11P	514		NA
	81711	Latch & Strike Screws	•	•	•	•	•			\$0.75
	82893	3846 Strike Screw Pack	•	•	•	•	•			\$3.05



**Adjustable Interconnect**

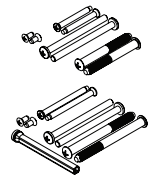

Model	Function	Finish							List Price
		3	5	15/15A	26/26D	690/11P	514	NA	
83269	Adjustable Interconnect Screw Pack	•	•	•	•	•			\$2.95
83270	Adjustable interconnect Screw Pack (Thick Door Pack)	•	•	•	•	•			\$2.95

**Strike Screws**

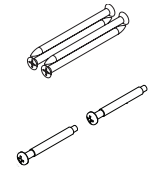

Model	Function	Finish							List Price
		3	5	15/15A	26/26D	690/11P	514	NA	
86356	3" Strike Screws	•	•	•	•	•			\$4.80
88604	Full Round Strike Screws				•				\$1.40

**Thick Door Conversion**

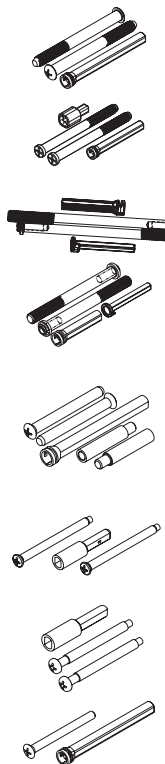











Model	Function	Finish							List Price
		3	5	15/15A	26/26D	690/11P	514	NA	
81691	P&T and SMT 780/782/980/982 Deadbolt and 913/914/915/916/919 Thick Door Pack	•	•	•	•			•	\$5.45
83022	258 Series Deadbolt Thick Door Pack	•		•	•		•		\$5.45
81249	P&T and SMT 784/785 /985 Deadbolt Thick Door Kit with 2-11/16" Screws					•			\$5.45
84221	P&T Deadbolt Thick Door Kit with 3.625" Screws					•		•	\$5.45
86129	660 Thick Door Pack	•	•	•	•			•	\$5.45
86130	665 Thick Door Pack	•	•	•	•				\$5.45
81714	Thick Door Pack, Signature Series Knobs Concealed Screws Styles					•			\$5.45
81706	Thick Door Pack, Kwikset and Signatures Knobs & Lever Styles: A, CA, CN, PE, H, AO, CV, P, T, BL, DL, DNL, LRL, ADL, AUL, AVL, BRL, CHL, L, LL, TNL, PML, PSK, KTL, VDL	•	•	•	•			•	\$5.45
81838	Thick Door Pack, Handleset Adapter	•	•	•	•				\$2.95

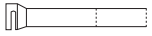
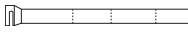
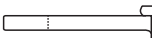

**Thick Door**

**Conversion** *(cont)*

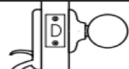
	Model	Function	Finish						List Price
			3	5	15/15A	26/26D	690/11P	514	
	81780	Thick Door Pack, All Active & Dummy Handsets	•	•	•	•	•		\$5.45
	820291	Thick Door Pack for 154 and 155 Function for the Kwikset Signature Series Lever Styles HFL, MIL, LSL, MRL, and SYL. No Thick Door Kit is available for the 156 function.	•	•	•	•	•		\$5.45
	820289	P&T and SMT 158 Deadbolt Thick Door Pack			•	•	•		\$5.45
	820290	P&T and SMT 159 Deadbolt Thick Door Pack			•	•	•		\$5.45
	84988	1.37" Torque Blade Double Cylinder Thick Door			•	•	•		\$5.45
	84992	2.491" Torque Blade Single Cylinder Thick Door						•	\$1.75
	84994	1.40" Torque Blade Thick Door						•	\$1.75
	81861	Thick Door Screw and Washer						•	\$1.25
	81402	800 Handleset Thick Door Spindle							\$1.85

Model	Function	Amherst, Hawthorne, Shelburne, Tavaris	Ashfield, Avalon	Austin	Arlington, Chelsea	San Clemente, Camino, Vancouver, Prescott	Amador, Belleview, Dakota
	81691	980 Deadbolt Thick Door Pack (H16)	X	X	X	X	
	83022	258 Deadbolt Thick Door Pack (H16)				X	
	86129	660 Deadbolt Thick Door Pack (H17)					X
	81402	Handleset Thick Door Spindle (H18)	X	X	X	X	X
	81780	Thick Door Pack for all Handlesets (H17)	X	X	X	X	X
	82213	Throughbolt Screw & Washer (H14)	O				
	81861	Thick Door Screw & Washer (H17)		X	O	X	
	84307	Throughbolt Screw & Washer (H14)					
	88322	Sex Nut & Wood Screw Set (H14)				X	X

**X:** Needed for thick door option

**O:** Optional - Part comes with product on standard order







Must specify finish on order



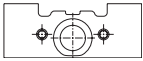

















Misc. Parts	Model	Function	Finish								List Price		
			3	5	15	15A	26	26D	690/11p	514		NA	
	82768	660/665 Cylinder Guard										•	\$3.75
	87760	780 Exterior Cylinder Guard										•	\$3.90
	82746	660/665 Cylinder Guard Cover	•	•	•	•	•	•	•	•			\$4.80
	87759	780 Cylinder Guard Cover	•	•	•	•	•	•	•	•			\$8.95
	82216	980 Cylinder Guard Cover	•	•	•	•	•	•	•	•			\$8.95
	84991	660 Torque Blade										•	\$1.95
	83273	660/663/667/677/588 Thumb Turn	•	•	•	•	•	•	•	•			\$7.75
	81692	780 Thumb Turn	•	•	•	•	•	•	•	•			\$22.10
	82217	980 Thumb Turn	•	•	•	•	•	•	•	•			\$22.10
	88381	664, 667, 677 Exterior Plate	•	•				•	•	•			\$17.95
	81295	Kwik-Install Mounting Plate										•	\$3.05
	87789	Deadbolt Reinforcing Plate										•	\$1.50
	82778	699 Function Dummy Cylinder	•	•	•	•	•	•	•	•			\$5.00
	81239	Grade 1 Body Dummy Cylinder										•	\$11.55
	85184	Dummy Deadbolt Cylinder Plug			•			•	•	•	•		\$3.35
	81857	U.L. Shield Deadbolts										•	\$5.45
	83162	U.L. Shield Entry - Halifax										•	\$5.70
	83163	U.L. Shield Passage - Halifax										•	\$5.70
	83164	U.L. Cotter Pin										•	\$0.20



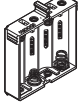

Misc. Parts	Model	Function	Finish							List Price	
			3	5	15	15A	26	26D	690/11p		NA
	81226	Dummy Cylinder Cover	•	•	•	•	•	•	•	\$3.35	
	84990	663/667/677/664 Tailpiece								•	\$1.95
	84568	663 Block, Bolt Mounting								•	\$1.15
	81404	Non-Handed Levers Dummy Adapter								•	\$11.35
	88841	300 Knobs Interior Round Spindle								•	\$0.70
	87628	740 Interior Round Spindle								•	\$1.05
	85624	3-1/2" Screw Driver Bit (10 Pack)								•	\$50.00
	88448	U.L. Shield Knobs								•	\$5.70
	81857	U.L. Shield Deadbolts								•	\$5.55
	81822	DB 2-1/8" Adapter for 780/970/980								•	\$3.05
	84987	.835" Torque Blade								•	\$1.80
	84993	1.097" Torque Blade, Standard Door								•	\$1.85
	83621	Finish Sample Ring								•	\$15.95
	83024	258 Series Mounting Plate								•	\$3.50
	83396	Vedani Lever Support Insert								•	\$3.55
	85333	Half Round & Round Spindle Assembly								•	\$4.20
	85570	5570-07 Screw #8-32 x 1-1/2			•						\$0.10
	820314	Levers and Knobs Frost Insert								•	\$6.90
	820309	Handleset Mechanism								•	\$11.95
	820318-001	Deadbolt Frost Insert								•	\$10.70

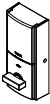

Misc. Parts	Model	Function	Finish							List Price
			L03	5	15	15A	26	11P/514	NA	
	83306	909 and 910 TRL Top Cover	•		•				•	\$12.60
	80435	909 and 910 Interior Cover Screws	•		•				•	\$1.00
	83307	909 & 911 Top Battery Holder							•	\$1.90
	83500	925 Kevo CNT Slide Cover							•	\$4.25
	83501	925 Kevo CNT Interior Cover			•		•	•	•	\$32.10
	83532	Kevo 2 Parts for Thin Door Installation								\$5.45
	83577	925 2nd Gen Exterior	•		•				•	\$142.00
	83578	925 2nd Gen Interior Chassis							•	\$98.30
	83580	913TRL, 914TRL, 915TRL, 916TRL, 919, and 925 Interior Cover	•		•				•	\$32.10
	83581	913, 914, 915, 916, 919, 925 and 953 Top Battery Holder							•	\$1.90
	85137	913, 914, 915, 916, 919, 925, 953 and 959 Interior Mounting Plate							•	\$5.45
	83583	Electronics Deadbolt Adapter Ring							•	\$3.05
	83585	Exterior Screws for the Interior Cover of the 913, 914, 915, 916, 919, 925 2nd Gen, 953 and 954	•		•				•	\$1.15
	83651	953 Mounting Screws for 1-3/8" Door Thickness							•	\$5.50
	83502	925 Kevo CNT and 888 Top Battery Holder							•	\$1.90
	85143	917 HFL Interior Battery Cover							•	\$4.50
	85144	917 Mounting Screws with Spindle			•		•	•		\$6.00
	85145	917 TNL Interior Battery Cover							•	\$4.50
	83813	interior cover, TRD, KS								\$32.10
	83814	interior cover, CNT, KS								\$32.10
	85196	lpp, screw pan head, 4-20x1/4								\$0.50