

General Information.....	3
Ordering Information .....	5
Functions & Measurements.....	6
<b>Kwikset Signature Series</b>	
Handlesets .....	16-17
Levers.....	18-19
Knobs.....	20-21
Combo Packs.....	22
Deadbolts.....	23
<b>Kwikset</b>	
Handlesets .....	26
Levers .....	27
Knobs.....	28-29
Deadbolts.....	30
Combo Pack.....	31
Project Packs .....	32
<b>Electronic Locks</b>	
Halo .....	33
Halo Touch .....	35
Aura.....	37
SmartCode 240 .....	39
SmartCode 250 .....	41
SmartCode 260.....	43
SmartCode 270.....	45
HomeConnect 620 .....	47
Electronics.....	50
<b>Light Commercial</b>	
Key Control Deadbolt .....	54
<b>Parts &amp; Accessories</b>	
Levers, Knobs & Deadbolts.....	55
Handlesets & Re-Keying Kit .....	56
Service Parts Keys, Rekeying Kits & Misc. ....	57
Round Pocket Door Lock.....	59



## TERMS AND CONDITIONS OF SALE

Standard terms are 2% prompt payment discount for payment within 25 days from date of invoice; net 30 days from the date of invoice. Kwikset® reserves the right to charge and recover on invoices which are not paid within the above terms, a service charge of 1-1/2% a month for each month or fraction thereof during which the invoice remains unpaid, said service charge, however, not to exceed the highest applicable legal rate of interest. All orders, whether solicited or written by our sales representatives or forwarded by our customers are deemed to be mere offers to purchase in accordance with these Terms and Conditions of Sale until actually accepted by us at our home office in Lake Forest, CA. We reserve the right to refuse any order as well as the right to sell or not sell to any firm at our sole discretion. The acceptance of an order is expressly made conditional upon your assent to these Terms and Conditions of Sale. We object to the inclusion of any different or additional terms or conditions, even if the same are included in your order, a contract of sale will result upon the Terms and Conditions of Sale stated herein only. Prices reflected in this book apply to Wholesale customers only.

All sales are final.

## PRICES

Pricing based on full-case quantities only; orders for less than full case will be automatically adjusted up to the next full-case quantity. All prices are subject to change without notice and are not guaranteed. All taxes, duties or other charges are the responsibility of the customer.

## CLAIMS

Price claims must be submitted in writing to Kwikset, 19701 Da Vinci, Lake Forest, CA 92610 within 30 days from the date of invoice.

## CHANGES OR CANCELLATIONS

Beyond 5 working days of our acknowledgement date no changes can be made. Additions to an order will be handled as a separate order and must meet applicable minimum order requirements. Order cancellation on regular stock items only, or any portion thereof is allowed only upon prior written consent from Kwikset, and the payment of cancellation charges deemed appropriate.

## MINIMUM CHARGE

No order will be invoiced for less than \$100.00 net plus shipping charges except for lock accessory parts.

## MINIMUM ANNUAL SALES VOLUME

The company reserves the right to discontinue direct sales to any customer who does not meet the minimum annual sales volume requirement. The current annual requirement is \$50,000.00. Your annual purchases are determined by accepted, non-cancelled, and shipped orders received during each calendar year. Kwikset reserves the right to change any or all minimum annual sales volume requirements at any time. Any customer who does not meet the annual sales volume requirements may continue to purchase Kwikset products through a Kwikset distributor.

## RETURNS

Defective merchandise returned to our factories requires prior written authorization from a Kwikset Sales Rep or the Sales Office. A factory return authorization must accompany the returned shipment. The return authorization must include an itemized listing of the merchandise and an explanation stating the reason for return.

There will be a 20% product restocking fee on all returned merchandise.

## FREIGHT

All goods are invoiced FOB to our factory. Upon delivery of shipments to the carrier, title to, and the risk of loss or damage in transit for such shipments, passes to our customer. Kwikset's standard policy is to pay freight charges on all orders over \$1,000.00 net invoice value to a single destination in the continental U.S., by carrier and route of our choice. Shipments less than these quantities will not be shipped on a prepaid basis. If higher freight charges are incurred from customers specifying a carrier or route of their choice the additional cost will be added to that customer's invoice.

## DELIVERY CONDITIONS

Shipping schedules are our best estimates, and cannot be guaranteed. Kwikset is not responsible for any direct or consequential loss or damage resulting from an inability or delay in meeting shipping schedules.

## KWIKSET LIMITED WARRANTIES

Kwikset products are backed by one of the most comprehensive warranty programs available. You can feel confident that with the purchase of Kwikset you have selected the best quality product, backed by the best customer service available.

## MECHANICAL LIMITED WARRANTY

Except as otherwise provided below, Spectrum Brands, Inc., for its Kwikset® brand products ("Kwikset"), warrants to the original residential purchaser (the "Purchaser") that each Kwikset product (the "Product(s)" or "Kwikset Product(s)") will be free from mechanical defects under normal use from the date of purchase for as long as said Purchaser occupies the residential premises upon which the Product was originally installed ("Warranty Period"). This Mechanical Limited Warranty applies only to Products that were purchased from Kwikset or a Kwikset authorized seller, unless otherwise prohibited by law. Kwikset Products are legitimately sold only by authorized sellers who are required to follow Kwikset's policies, procedures, and quality control standards. Kwikset reserves the right to reject warranty claims from purchasers for Products purchased from unauthorized sellers, including unauthorized Internet sites.

## FINISH LIMITED WARRANTY

The finish on Kwikset Products is protected by a durable topcoat designed to maintain the beauty and quality of the Kwikset Product. Kwikset warrants to the Purchaser that the finish of the Product shall be free of defects in material and workmanship from tarnishing, flaking, and discoloring from the date of purchase for as long as said Purchaser occupies the residential premises upon which the Product was originally installed ("Warranty Period"). This Finish Limited Warranty applies only to Products that were purchased from Kwikset or a Kwikset authorized seller, unless otherwise prohibited by law. Kwikset Products are legitimately sold only by authorized sellers who are required to follow Kwikset's policies, procedures, and quality control standards. Kwikset reserves the right to reject warranty claims from purchasers for Products purchased from unauthorized sellers, including unauthorized Internet sites.

## ELECTRONIC LIMITED WARRANTY

Kwikset warrants to the Purchaser that Kwikset Products will be free from electronic defects under normal use for one (1) year from the date of purchase, as long as said Purchaser occupies the residential premises upon which the Product was originally installed ("Warranty Period"). This Electronic Limited Warranty applies only to Products that were purchased from Kwikset or a Kwikset authorized seller, unless otherwise prohibited by law. Kwikset Products are legitimately sold only by authorized sellers who are required to follow Kwikset's policies, procedures, and quality control standards. Kwikset reserves the right to reject warranty claims from purchasers for Products purchased from unauthorized sellers, including unauthorized Internet sites.

## EXCLUSIONS FROM WARRANTY

1. Any Kwikset Product produced prior to January 1, 2006.<sup>1</sup>
2. Any Kwikset Product which has been damaged as a result of installation contrary to any of Kwikset's written installation instructions is not covered by these warranties.
3. Any Kwikset Product which has been modified by any non-Kwikset component is not covered by these warranties.
4. Any Kwikset Product having a defect caused by neglect, misuse, abuse or unreasonable or extraordinary use or maintenance, including use in a commercial application, is not covered by these warranties.
5. Any Kwikset Product having a defect due to use of paints, solvents, or other chemicals is not covered by these warranties.
6. Any Kwikset Product that is used in combination with knobs, levers, or trim of other than those manufactured by Kwikset and designated for use with the applicable locks or latches is not covered by these warranties.
7. Any Kwikset Product that was purchased from an unauthorized seller is not covered by these warranties.

These warranties are not transferable. Therefore, no transferee is covered by these warranties.

<sup>1</sup> Kwikset Products produced prior to January 1, 2006, may be eligible for warranty in accordance with the terms and conditions of the applicable warranty program.

## WARRANTY CLAIMS

If you wish to make a warranty claim based upon a Product defect, please call us at 1-800-327-LOCK (5625) or contact us at [kwikset.com/support](http://kwikset.com/support).

Please note that you will be required to provide a description of any claimed defect(s) and a dated receipt or other proof of purchase from Kwikset or the Kwikset authorized seller, to verify warranty eligibility.

Certain claimed defect(s) covered by these warranties may be resolved by Kwikset providing you with troubleshooting steps.

Other claimed defect(s) covered by these warranties may require Product replacement. Products may not be returned to Kwikset without prior authorization from Kwikset. If authorized by Kwikset, you will need to mail your Product to:

Spectrum Brands, Inc.

ATTN: Kwikset Consumer Services

19701 Da Vinci

Lake Forest, CA 92610

A prepaid shipping label will be provided to you.

## REMEDIES

For certain claimed defect(s) covered by these warranties, as determined by Kwikset, Kwikset will provide you with troubleshooting steps.

For other claimed defect(s) covered by these warranties, as determined by Kwikset, Kwikset will replace the defective Product or part.

If a Kwikset Product, which is the same as the Kwikset Product or any part covered by these warranties, has been discontinued at the time of replacement or if Kwikset determines, in its sole discretion, that such replacement is inappropriate, Kwikset reserves the right to substitute an alternative product. Kwikset also reserves the right to accept or reject an alternative product proposed as a replacement, when the value is higher than that of the Product originally purchased by the Purchaser. Except as expressly provided in these warranties to the contrary, KWIKSET SHALL NOT BE OBLIGATED OR LIABLE FOR LABOR OR OTHER COSTS RELATED TO INSTALLATION, REPAIR OR REPLACEMENT OF A KWIKSET PRODUCT, OR FOR LOSS OF, OR DAMAGE TO ANY MATERIAL WHICH IS NOT SOLD BY KWIKSET.

## PATENT INDEMNITY

We agree to defend any suit or proceeding brought against our customer so far as based on claim that our products, or any part thereof, made solely to our specifications and furnished to our customer constitute an infringement of any U.S. patent, if notified promptly in writing and given authority, information and assistance at our expense for the defense of same, and we shall pay all damages and costs awarded therein against our customer. In case our products, or any part thereof, is in such suit held to constitute infringement and their use is enjoined, we will, at our expense and discretion, either procure for our customer the right to continue using the products or replace same with non-infringing products, or modify them so they become non-infringing, or remove such products and refund the purchase price (less depreciation, prorated from the purchase date). The foregoing states our entire liability for patent infringement by our products or any part thereof.

## INTELLECTUAL PROPERTY

No person or entity may sell, distribute, advertise, market or promote Kwikset branded products distributed by Kwikset Corporation ("Kwikset"), Spectrum Brands Hardware Home Improvement Division, without prior authorization from Kwikset. Customers of Kwikset who are authorized to sell Kwikset branded products are referred to herein as "Customers."

The Kwikset brand and all Kwikset trademarks, trade names, product depictions, colors, graphics or logos, whether or not registered or otherwise protected (the "Marks"), remain the sole and exclusive property of Kwikset and nothing arising out of the relationship between Kwikset and any Customer conveys to Customer any ownership rights in the Marks. Customer may use the Marks and then only in the sale or promotion of authentic Kwikset products in compliance with the terms of this policy. The Marks must be used exactly in the form provided and in conformity with all Kwikset trademark usage policies or guidelines, including, but not limited to, those relating to shape, color match and imprint quality. Any proposed deviation must be approved in writing by Kwikset prior to use. The Marks may not be used in or as part

of any Customer domain name on the Internet. Prior to any use of the Marks on goods or services, Customer must submit samples for Kwikset's approval.

Additionally, no Customer may use product depictions, graphics, logos or text relating to Kwikset products that have not been provided by Kwikset in connection with the advertising, promotion or sale of Kwikset products without Kwikset's prior review and written approval of each such use. The Marks may not be used in or as part of any reseller or other third party (i) domain name or VRL on the Internet, (ii) trademark or service mark, or (iii) company or trade name. Any action on the part of a Customer that violates the terms of this policy or otherwise impairs the value of or goodwill associated with the Marks or is otherwise not in conformity with Kwikset's standards may result in the suspension or termination of the Customer's authorization or any other remedy permitted by law.

Kwikset grants to each of its Customers limited, non-transferable, non-sublicenseable licenses of the patents relating to the Kwikset products that the Customer is authorized to sell and of the copyrights in any packaging or other written materials included therewith or related thereto. Said patent and copyright licenses are solely to sell such Kwikset products covered by such patents and to which such copyrights relate only to end-users and other Customers in compliance with the terms of this document. The sale of such patented Kwikset products and the sale or use of such copyrighted materials by a Customer that violate the terms of this document exceed the scope of the licenses herein granted to the Customer and may constitute patent and/or copyright infringement.

## STANDARDS

Kwikset meets or exceeds the testing requirements specified for each product grade or rating.

- American National Standards Institute (ANSI)
- Builders Hardware Manufacturers Association (BHMA)
- Underwriters Laboratories, Inc. (UL)
- Americans with Disabilities Act (ADA)

## MISCELLANEOUS

Substitution of non-Kwikset components/parts, and any alteration or modification of factory parts, and other lock manufacturer's parts may result in door hardware which does not function properly or will fail and will void all warranties. Orders not specified with keying requirements will be shipped Keyed Differently (KD). Orders with keying requirements of K10 or more must have a "Letter of Release" on file with Kwikset stating that Kwikset Corporation will not be held liable for cost and expense arising from any loss or damage to property utilizing Kwikset products where 10 or more locks have been keyed alike. Contact your Sales Office account representative for a copy of the release form. Kwikset reserves the right to revise or modify products, product information, or pricing without notice. Product specifications and pricing reflect available information at the time of printing. Kwikset is not responsible for typographic or printing errors.

## LIMITATION OF LIABILITIES

**THERE ARE NO WARRANTIES WHICH EXTEND BEYOND THOSE STATED HEREIN. ANY IMPLIED WARRANTIES THAT MAY BE APPLICABLE TO PRODUCTS, INCLUDING IMPLIED WARRANTIES OF MERCHANTABILITY OR FITNESS FOR A PARTICULAR PURPOSE, ARE LIMITED IN DURATION TO THE DURATION OF THIS WARRANTY. SOME STATES DO NOT ALLOW LIMITATIONS ON HOW LONG AN IMPLIED WARRANTY LASTS, SO THE ABOVE LIMITATION MAY NOT APPLY TO YOU. UNDER NO CIRCUMSTANCES SHALL KWIKSET BE LIABLE FOR ANY SPECIAL, INCIDENTAL, OR CONSEQUENTIAL DAMAGES BASED UPON BREACH OF THIS LIMITED WARRANTY, BREACH OF CONTRACT, OR STRICT LIABILITY. SOME STATES DO NOT ALLOW THE EXCLUSION OR LIMITATION OF INCIDENTAL OR CONSEQUENTIAL DAMAGES, SO THE ABOVE LIMITATION OR EXCLUSION MAY NOT APPLY TO YOU. THIS WARRANTY GIVES YOU SPECIFIC LEGAL RIGHTS, AND YOU MAY ALSO HAVE OTHER RIGHTS WHICH VARY FROM STATE TO STATE.**

Effective Date: [July 6th 2020]



**HANDING**

To determine the handing of a door, face the **OUTSIDE** of a door. If the hinge is on the left side of the door, the door is left-handed (LH). If the hinge is on the right side of the door, the door is right-handed (RH).

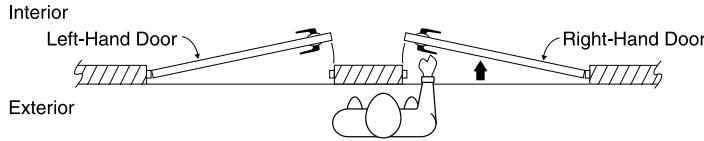

*Note: Handing only required for Dummy Kwikset Signature Series levers.*

**FINISHES**

US	Description	BHMA	US	Description	BHMA
L03	Lifetime Polished Brass	605E	26D	Satin Chrome	626
3	Polished Brass	605	514	Matte Black	
5	Antique Brass	609	26	Polished Chrome US	
15	Satin Nickel	619	4	Satin Brass	

**KEYING**

Code	Option
K4, K6	Keyed Alike (4 Locksets, 6 Locksets)

**BACKSET**

Backset is the length from center edge of door to center of the 2 1/8" (54mm) diameter hole. 2 3/8" or 2 3/4" in most cases.

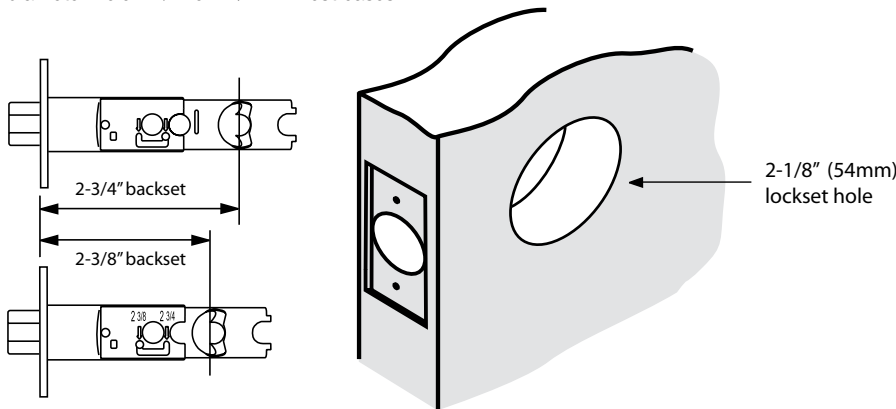

**FUNCTIONS**

Model	Description	Model	Description
200/720	Passage/Hall & Closet	488/788	Half Dummy Trim, Surface Mounted
300/730	Privacy/Bed & Bath	553/687/800/818	Single Cylinder Handlesets
400/740	Keyed Entry Knob	815	Handle Grip Only
405/740	Keyed Entry Lever	660/816/980/258	Single Cylinder Deadbolts
		665/985	Double Cylinder Deadbolts
		240, 250, 260, 270, 938, 939, 959	Electronic Deadbolts

**KWIKSET SIGNATURE SERIES HANDLESET FUNCTIONS**

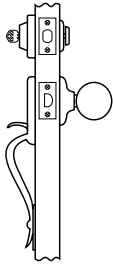

**Model**  
800 / 818

**Function**  
Handleset with Single Cylinder Deadbolt

**Description**  
Latchbolt operated by thumbpiece outside and grip inside. Deadbolt operated by key outside and thumbturn inside.

**KWIKSET SIGNATURE SERIES KNOB & LEVER FUNCTIONS**

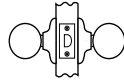

**Passage/Hall/Closet:** Both knobs always free.  
**720 F75**

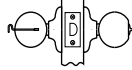

**Privacy/Bed/Bath:** Both knobs locked or unlocked by turnbutton inside. Outside knob unlocked by emergency key.  
**730 F76**

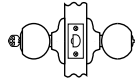

**Entry:** Both knobs locked or unlocked by key outside or turnbutton inside.  
**740 F82**



**Half Dummy Trim, Surface Mounted:** For doors where only a pull is required. No operation.  
**788**

**KWIKSET SIGNATURE SERIES DEADBOLT FUNCTIONS**



**Single Cylinder:** Deadbolt operated by key outside and thumbturn inside.  
**980 E0151 / 258**

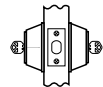

**Double Cylinder:** Deadbolt operated by key both sides.  
**985 E0141**

*Note: ANSI/BHMA functions are listed in italics.*

**KWIKSET SIGNATURE SERIES HANDLESET FUNCTIONS**

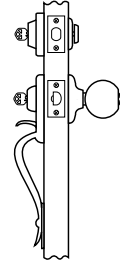

**Model**  
553

**Function**  
Handleset with Single Cylinder Deadbolt

**Description**  
Latch bolt operated by thumb piece outside and grip inside, except when both are locked by key outside or turn button inside. Deadbolt operated by key outside or thumb turn inside.

Kwikset Signature Series Packaging Dimensions									
	Unit Height	Unit Width	Unit Length	Unit Weight	Master Height	Master Width	Master Length	Master Weight	Case Qty
Knobs	9.1	4.6	3.1	1.5	8.4	5.5	13.6	6.5	4
Levers	9.3	6.2	3.2	2.0	9.8	7.1	13.7	8.65	4
Contemporary Levers	9.4	6.4	3.1	3.0	9.9	7.2	13.9	12.85	4
Deadbolts	7.8	4.7	4.2	2.5	8.3	5.5	18.2	8.9	4
Knob Combo	9.1	7.9	3.0	3.0	9.6	8.7	13.3	12.8	4
Lever Combo	9.4	9.0	3.0	3.5	9.4	9.0	3.0	14.8	4
Halifax Combo	9.8	3.4	7.7	5.1	10.4	8.5	15.4	20.5	4
992 Combo	8.9	9.0	3.0	3.3	9.2	9.7	13.5	14.0	4
Inactive Knobs	8.7	3.5	3.3	0.3	9.3	4.4	13.3	1.55	4
Inactive Levers	8.7	3.5	3.3	1.0	9.3	4.4	13.3	2.75	4
Handlesets	21.6	8.0	5.5	7.0	11.9	8.6	22.2	15.0	2
Handle Only	16.3	7.3	4.1	4.9	7.9	8.6	16.8	10.4	2

Note: All dimensions in inches. All weights in pounds and based on maximum weights of each function.

**KWIKSET HANDLESET FUNCTIONS**

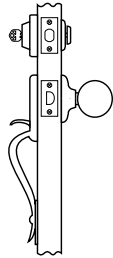

**Model**  
687

**Function**  
Sectional Handleset with Single Cylinder Deadbolt

**Description**  
Latchbolt operated by thumbpiece outside and grip inside.  
Deadbolt operated by key outside and thumbturn inside.

**KWIKSET KNOB & LEVER FUNCTIONS**

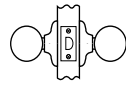

**Passage/Hall/Closet:** Both knobs always free.  
**200 F75**

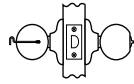

**Privacy/Bed/Bath:** Both knobs or levers locked or unlocked by turnbutton inside. Outside knob unlocked by emergency key. **300 F76**

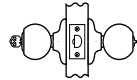

**Entry:** Both knobs or levers locked or unlocked by key outside or turnbutton inside.  
**400 F82 - 2 knobs**  
**405 F82 - 2 levers**



**Half Dummy Trim, Surface Mounted:** For doors where only a pull is required. No operation.  
**488**

**KWIKSET DEADBOLT FUNCTIONS**



**Single Cylinder:** Deadbolt operated by key outside and thumbturn inside.  
**660/660M E0153**

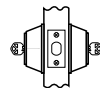

**Double Cylinder:** Deadbolt operated by key both sides.  
**665 E0143**



**Thumbturn Only:** Deadbolt operated by thumbturn one side. No trim on other side.  
**663 E0193**

*Note: ANSI/BHMA functions are listed in italics.*

Kwikset Packaging Dimensions										
	Unit Carton Height	Unit Carton Width	Unit Carton Depth	Unit Carton Weight	Master Carton Height	Master Carton Width	Master Carton Depth	Cubic Ft.	Master Carton Weight	Case Count
Knobs	6.5	8	3	1.4	6.875	3.625	8.5	0.581	8.4	6
Levers	6.5	8	3	2.13	6.875	3.625	19.875	1.09	14	6
Deadbolts	6.5	2.906	5.375	1.235	6.688	17.438	6.25	0.422	7.41	6
Combo Packs	10.5	7.875	3.25	2.5	11.4	8.875	18.125	1.061	15	6
Bellevue	21.8	8	5.5	4.5	12.5	9	21.625	1.408	9	2
Dakota	21.8	8	5.5	6	12.5	9	21.625	1.408	12	2
Inactive Knobs	8.75	3.5	3.125	0.93	9.313	13.313	4.375	0.314	3.72	4
Inactive Levers	8.75	3	3.5	0.93	9.313	13.313	4.375	0.314	3.72	4

Note: All dimensions in inches. All weights in pounds and based on maximum weights of each function.

**ELECTRONIC DEADBOLTS FUNCTIONS**

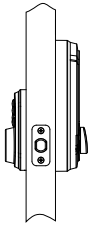

**Function**

SmartCode™ Deadbolt

**Description**

Deadbolt operated by key outside or electronic keypad and thumb turn inside.

**Kwikset w/ BHMA**

N/A

**Kwikset Signature Series w/ BHMA**

915 E0152

Electronic Deadbolts/Levers Packaging Dimensions									
	Quantity	Unit Carton Height	Unit Carton Width	Unit Carton Depth	Unit Carton Weight	Quantity	Master Carton Height	Master Carton Width	Master Carton Depth
260 SmartCode	1	9.913	5.353	4.213	3.343	2	10.557	9.180	6.213
912 SmartCode Lever	1	10	6	3.5	61	2	10.4	12.5	7
270 SmartCode	1	9.913	5.353	4.213	3.307	2	10.557	9.180	6.213
916 SmartCode	1	9.88	5.38	3.5	3.14	2	5.94	7.75	10.50
Powerbolt 240	1	9.88	5.32	4.13	3.31	2	6.30	7.80	8.39
Powerbolt 250	1	9.88	5.32	4.13	3.31	2	6.30	7.80	8.39
916	1	9.75	4.0	4.28	3.12	1	4.44	4.63	10.25
Halo Touch	1	9.83	5.4	4.19	3.76	1	10.31	5.63	4.56
Halo Touchscreen	1	9.771	5.313	3.521	3.561	1	3.917	5.688	5.688
Halo Keypad	1	9.834	5.313	3.542	2.413	1	3.917	5.688	10.334

Note: All dimensions in inches. All weights in pounds and based on maximum weights of each function.

**Kwikset**



**99.9% Cleaner  
Than Unprotected Surface**

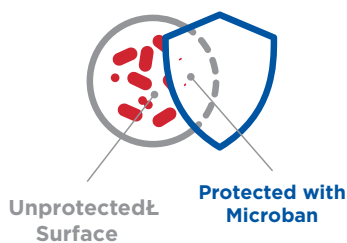

Kwikset® and Microban®, the global leader in built-in antimicrobial protection, have teamed up to improve the standard for door hardware. Kwikset® will now offer antimicrobial protection on select products, inhibiting the growth of bacteria on frequently touched door hardware in your home.

### **Benefits of Kwikset® Door Hardware with Microban® Technology**

Bacteria can double every 20 minutes on unprotected surfaces, but Kwikset Door Hardware with Microban protection works to continuously fight off microbes.

- Door hardware is 99.9% cleaner than knobs without Microban.
- The antimicrobial coating lasts for the lifetime of the hardware finish, so you can worry less and feel more secure in your home.
- 24/7 Antimicrobial product protection.
- Kwikset with Microban protection resists the growth of a broad spectrum of bacteria.

**#1 SELLING U.S. LOCK BRAND**

\*Source: TraQline US Door and Lock Hardware Report Q4 2020 through Q4 2022

Look for the Microban logo:



Microban is available on select Kwikset® products.



Finish availability will vary per product



Polished Brass 3



Antique Brass 5



Venetian Bronze 11P



Satin Nickel 15



Matte Black 514

**Kwikset**  
— Security Series



## HENLEY LEVER

Henley levers combine subtle details with ergonomic curves, creating a versatile design that complements any home aesthetic. The unique designer rosette will add style and dimension to your doors, and our full suite of products can outfit the interior and exteriors of your home. SmartKey Security™ allows you to re-key your exterior door lock yourself in seconds, and powerful Microban® technology guards against bacteria growth. Enjoy trusted security, peace of mind and an easy install from the number-one-selling U.S. lock brand.



Henley Lever with SmartKey Security  
in Matte Black



Henley Lever with SmartKey Security  
in Satin Nickel

**#1 SELLING U.S. LOCK BRAND\***

Numerator TruView, Unit Share Report, 2023



## Specifications

<b>Door Prep</b>	Cross Bore 2-1/8" or 1 1/2". Edge Bore 1"
<b>Backset</b>	Adjustable 2 3/8" or 2 3/4"
<b>Door Thickness</b>	1 3/8" - 1 3/4" Doors standard
<b>Cylinder</b>	SmartKey Security™
<b>Faceplates</b>	1" x 2 1/4" Specify round corner, square corner or drive-in
<b>Strikes</b>	1 1/8" - 2 3/4" round corner

<b>ANSI/BHMA</b>	A156.2 Grade 3
<b>Door Handing</b>	Reversible for right or left hand doors
<b>ADA</b>	Satisfy section 4.13.9 ADA requirement
<b>Warranty</b>	Lifetime Mechanical and Lifetime Finish

## Functions



**Passage/Hall/Closet:** Both levers always free.



**Privacy/Bed/Bath:** Both levers locked or unlocked by push-button inside. Outside lever unlocked by emergency key.



**Keyed Entry Lever:** Both sides locked or unlocked by key outside or push-button inside.



**Half Dummy Trim, Surface Mounted:**  
For doors whereonly a pull is required.  
No operation.

## Dimensions

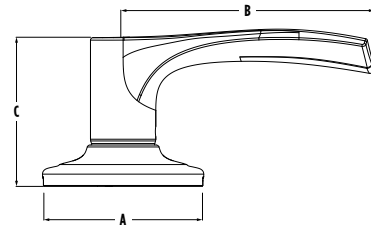

Design	A	B	C	C (Keyed)
Henley	2 5/8"	4 3/32"	2 9/16"	2 19/32"



**Kwikset's SmartKey Security™** provides homeowners with the superior security that is resistant to a variety of advanced break-in methods.

This technology also allows homeowners to re-key their locks themselves in seconds, rendering lost or un-returned keys useless.

## Finishes



Matte  
Black 514



Satin  
Nickel 15

**LIFETIME**  
WARRANTY



## NEW MIDTOWN COLLECTION

### Tripoli Lever & Midtown deadbolt

Introducing the soft modern design of the Midtown Collection - Available with the Tripoli Lever and Midtown Deadbolt. These new products bring comfort and practicality to modern design. This collection addresses the demand for a softer modern design with clean lines and subtle curves.

**FEATURES:**

- New Advanced SmartKey Technology
- Solid Metal Design
- Best-in Class Lever Chassis
- Sleek Low Profile Deadbolt Design
- ANSI/BHMA Grade AAA
- Highest Residential Security/Durability/Finish

*Signature Series*

**#1 SELLING U.S. LOCK BRAND**

\*Source: TraQline US quarterly brand unit share report, Q4 2006 through Q4 2022

386117-04/2019

# MIDTOWN LOW PROFILE RECTANGLE DEADBOLT

## Specifications

<b>Function</b>	258 MDT SMT Keyed Entry Single Cylinder
<b>Standard Door Prep</b>	Cross Bore 2 1/8". Edge Bore 1". Latch Face 1 1/8" x 2 3/4".
<b>Backset</b>	Adjustable to 2 3/8" or 2 3/4"
<b>Door Thickness</b>	1 3/8" - 1 3/4" Standard. Thick door service part available for up to 2 1/2".
<b>Cylinder</b>	SmartKey Security™
<b>Faceplate</b>	1" x 2 1/4"
<b>Strike</b>	1 1/8" x 2 3/4" Specify square or round
<b>Bolt</b>	1" Throw
<b>ANSI/BHMA</b>	Grade AAA Certified: Finish/Durability/Security
<b>ADA</b>	258 functions are in compliance with the American National Standards Institute (ANSI A117.1)
<b>UL</b>	Optional 20 Minute UL fire rating available, except inactive functions.
<b>Warranty</b>	Lifetime Mechanical and Lifetime Finish
<b>Rose</b>	Specify round, square, rectangle or Midtown

## Dimensions

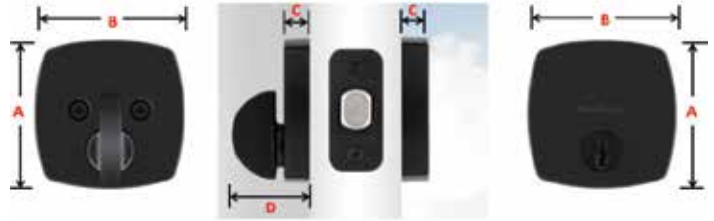

Design	A	B	C	D
Midtown MDT SMT	2 11/16"	2 11/16"	1/2"	1 7/16"

- Highest Residential Security/Durability/Finish
- Easy to Install
- Sleek Low Profile Deadbolt Design
- New Modern Design with Soft Subtle Lines

## Finishes



Satin Nickel 15

Matte Black 514

Polished Chrome 26

**99.9% Cleaner**  
Than Unprotected Surface

Unprotected Surface      Protected with Microban

**MICROBAN**  
ANTIMICROBIAL TECHNOLOGY

PROTECTION THAT LIVES ON

Kwikset with Microban® inhibits growth of damaging bacteria, providing you with a cleaner home.

## How to re-key in seconds

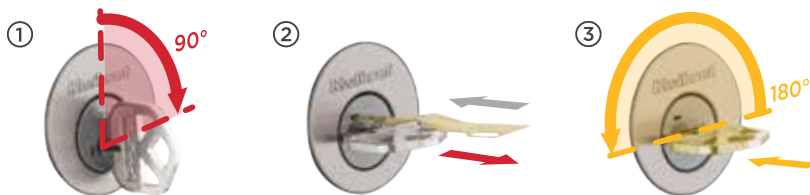

1. Insert current key and rotate it 90° clockwise.

2. Fully insert SmartKey tool. Remove tool and remove current key.

2. Fully insert new key and rotate 180°. Rotate back to starting position and remove key. **Your lock is now re-keyed!**



**!** You must have the working key to rekey the lock



Current Key

SmartKey Tool

New Key



**Superior Security Features**

- ANSI/BHMA Grade 1 Certified 258/980/985 Deadbolt
- SmartKey Security™ to Protect Against Lock Bumping

**Elegant Styles And Finishes**

- Broad Array of Finishes
- Traditional to Contemporary Styles

**Warranty**

- Limited Mechanical
- Limited Finish

\*Lock Bumping - an attack technique using specially cut keys that can defeat conventional pin & tumbler locks.



Arlington™



Ashfield™



Avalon™



Chelsea™



Hawthorne™



Montara™



Prague



Prague



Prescott



Prescott



San Clemente™



San Clemente™



Shelburne™



Vancouver

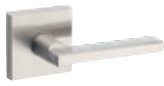

Halifax™



Singapore



Tustin™



Tripoli™



Juno™



Pismo™



Uptown



Downtown



980/985 Deadbolt



Midtown



MFG Pro#	Function	Finish									Case Qty.	Price
<b>San Clemente™ Handleset</b>		3	L03	4	5	11P	15	26	26D	514		
98180-001	818SCEXHFL SQT San Clemente x Halifax SQT					•					2	\$328.30
98180-002	818SCEXHFL SQT San Clemente x Halifax SQT						•				2	\$328.30
98180-020	818SCEXHFL SQT - San Clemente X Halifax SQT									•	2	\$328.30
98180-031	818SCEXHFL SQT San Clemente x Halifax SQT			•							2	\$328.30
98150-011	815SCEXHFL SQT San Clemente Handle Only x Halifax SQT*									•	2	\$231.00
98150-012	815SCEXHFL SQT San Clemente Handle Only x Halifax SQT*						•				2	\$220.70
<b>Montara™ Handleset</b>		3	L03		5	11P	15	26	26D	514		
95530-017	553MNXJ Montara x Juno		•								2	\$293.90
95530-018	553MNXJ Montara x Juno						•				2	\$304.60
95530-019	553MNXJ Montara x Juno					•					2	\$304.60
<b>Ashfield™ Handleset</b>		3	L03		5	11P	15	26	26D	514		
98001-098	800ADHXADL Ashfield x Ashfield					•					2	\$313.30
<b>Avalon™ Handleset</b>		3	L03		5	11P	15	26	26D	514		
98150-001	815AVHxTNL Avalon Handle Only x Tustin*					•					2	\$220.70
98150-002	815AVHxTNL Avalon Handle Only x Tustin*						•				2	\$220.70
<b>Vancouver Handleset</b>		3	L03		5	11P	15	26	26D	514		
98180-014	818VNHXHFL SQT 15 SMT CP						•				2	\$339.10
98180-015	818VNHXHFL SQT 514 SMT CP									•	2	\$339.10
<b>Prescott Handleset</b>		3	L03		5	11P	15	26	26D	514		
98150-013	815PTHXTNL 15 RBP Handle Only*						•				2	\$220.70
98150-014	815PTHXTNL 11P RBP Handle Only*					•					2	\$220.70
98180-021	818PTHXTNL 15 SMT CP						•				2	\$293.90
98180-022	818PTHXTNL 11P SMT CP						•				2	\$293.90
<b>Prague Handleset</b>		3	L03		5	11P	15	26	26D	514		
98180-025	818PGHXPSK RDT Prague x Pismo RDT 15						•				2	\$304.60
98180-026	818PGHXPSK RDT Prague x Pismo RDT 514									•	2	\$304.60
98150-024	815PGHXPSK - Pague Handle Only X Pismo RDT 514*									•	2	\$231.00
98150-023	815PGHXPSK - Pague Handle Only X Pismo RDT 15*						•				2	\$220.70

\*Denotes handset without deadbolt



<b>HANDLESETS - all keyed handlesets below have SmartKey only</b>								
<i>MFG Pro#</i>	<i>Function</i>	<i>Finish</i>					<i>Case Qty.</i>	<i>Price</i>
<b>Hawthorne™ Handleset</b>		<b>3</b>	<b>L03</b>	<b>5</b>	<b>11P</b>	<b>15</b>		
98001-104	800HEXJ - Hawthorne x Juno				•		2	\$286.90
<b>Shelburne™ Handleset</b>		<b>3</b>	<b>L03</b>	<b>5</b>	<b>11P</b>	<b>15</b>		
98001-107	800SEXTNL - Shelburne x Tustin					•	2	\$293.90
<b>Arlington® Handleset</b>		<b>3</b>	<b>L03</b>	<b>5</b>	<b>11P</b>	<b>15</b>		
98001-097	800ANXTNL - Arlington X Tustin				•		2	\$260.00
<b>Chelsea® Handleset</b>		<b>3</b>	<b>L03</b>	<b>5</b>	<b>11P</b>	<b>15</b>		
98001-196	800CEXJ - Chelsea x Juno		•				2	\$181.40
98001-369	800CEXJ - Chelsea x Juno					•	2	\$218.60



HALIFAX®



TRIPOLI®

<b>LEVERS - all keyed levers below have SmartKey only</b>													
MFG Pro#	Function	Finish									Case Qty.	Keying	Price
<b>Halifax® Reversible Lever</b>		3	L03	4	5	11P	15	26	26D	514			
97200-854	720HFL SQT - Hall/Closet						•				4		\$51.70
97300-896	730HFL SQT - Bed/Bath						•				4		\$60.30
97402-812	740HFL SQT - Keyed Entry						•				4	K4	\$101.20
97880-902	788HFL SQT - Inactive						•				4		\$26.40
97880-949	788HFL SQT - Inactive									•	4		\$26.40
97402-920	740HFL SQT - Keyed Entry									•	4	K4	\$101.20
97300-949	730HFL SQT - Bed/Bath									•	4		\$60.30
97200-906	720HFL SQT - Hall/Closet									•	4		\$51.70
97200-923	720HFL SQT - Hall/Closet			•									\$51.70
97300-967	730HFL SQT - Bed/Bath			•									\$60.30
97402-933	740HFL SQT - Keyed Entry			•									\$101.20
97880-962	788HFL SQT - Inactive			•									\$26.40
<b>Tripoli Lever</b>		3	L03		5	11P	15	26	26D	514			
97200-915	720TPL MDT - Hall/Closet						•				4		\$51.70
97300-954	730TPL MDT - Bed/Bath						•				4		\$60.30
97402-925	740TPL MDT - Keyed Entry						•				4	K4	\$101.20
97200-916	720TPL MDT - Hall/Closet									•	4		\$51.70
97300-955	730TPL MDT - Bed/Bath									•	4		\$60.30
97402-926	740TPL MDT - Keyed Entry									•	4	K4	\$101.20





TUSTIN®



SINGAPORE

<b>LEVERS - all keyed levers below have SmartKey only</b>												
MFG Pro#	Function	Finish								Case Qty.	Keying	Price
<b>Tustin® Reversible Lever</b>		3	L03	5	11P	15	26	26D	514			
97200-778	720TNL - Hall/Closet				•					4		\$54.40
97300-818	730TNL - Bed/Bath				•					4		\$58.70
97402-733	740TNL - Keyed Entry				•					4	K4	\$91.50
97880-678	788TNL LH - Inactive				•					4		\$23.20
97880-679	788TNL RH - Inactive				•					4		\$23.20
97200-777	720TNL - Hall/Closet					•				4		\$45.70
97300-817	730TNL - Bed/Bath					•				4		\$48.50
97402-732	740TNL - Keyed Entry					•				4	K4	\$85.00
97880-673	788TNL LH - Inactive					•				4		\$20.40
97880-676	788TNL RH - Inactive					•				4		\$20.40
<b>Singapore Lever</b>		3	L03	5	11P	15	26	26D	514			
97200-898	720SAL 15 SQT CP					•				4		\$51.70
97300-941	730SAL 15 SQT CP					•				4		\$60.30
97402-911	740SAL 15 SQT SMT CP K4					•				4	K4	\$101.20
97200-899	720SAL 514 SQT CP								•	4		\$51.70
97300-942	730SAL 514 SQT CP								•	4		\$60.30
97402-912	740SAL 514 SQT SMT CP K4								•	4	K4	\$101.20



PISMO®

<b>KNOBS - all keyed levers below have SmartKey only</b>											
<i>MFG Pro#</i>	<i>Function</i>	<i>Finish</i>							<i>Case Qty.</i>	<i>Keying</i>	<i>Price</i>
<b>Pismo® Knob</b>		<b>3</b>	<b>L03</b>	<b>5</b>	<b>11P</b>	<b>15</b>	<b>26</b>	<b>514</b>			
97200-888	720PSK - Hall/Closet					•			4		\$46.30
97300-931	730PSK - Bed/Bath					•			4		\$47.40
97402-850	740PSK - Entry					•			4	K4	\$68.90
97880-934	788PSK - Inactive					•			4		\$23.70
97200-887	720PSK - Hall/Closet							•	4		\$46.30
97300-930	730PSK - Bed/Bath							•	4		\$47.40
97402-849	740PSK - Entry							•	4	K4	\$68.90
97880-933	788PSK - Inactive							•	4		\$23.70



JUNO®

<b>KNOBS - all keyed levers below have SmartKey only</b>											
<i>MFG Pro#</i>	<i>Function</i>	<i>Finish</i>							<i>Case Qty.</i>	<i>Keying</i>	<i>Price</i>
<b>Juno® Knob</b>		<b>3</b>	<b>L03</b>	<b>5</b>	<b>11P</b>	<b>15</b>	<b>26</b>	<b>26D</b>			
97200-787	720J - Hall/Closet	•							4		\$25.80
97300-827	730J - Bed/Bath	•							4		\$28.50
97402-734	740J - Entry	•							4	K4	\$46.80
97880-666	788J - Inactive	•							4		\$13.40
97200-788	720J - Hall/Closet			•					4		\$27.40
97300-828	730J - Bed/Bath			•					4		\$31.20
97402-735	740J - Entry			•					4	K4	\$49.50
97200-790	720J - Hall/Closet				•				4		\$38.70
97300-830	730J - Bed/Bath				•				4		\$39.80
97402-737	740J - Entry				•				4	K4	\$54.40
97880-669	788J - Inactive				•				4		\$16.70
97200-789	720J - Hall/Closet					•			4		\$29.60
97300-829	730J - Bed/Bath					•			4		\$32.80
97402-736	740J - Entry					•			4	K4	\$52.70
97880-668	788J - Inactive					•			4		\$15.00



TUSTIN®  
COMBO PACK



JUNO®  
COMBO PACK



HALIFAX®  
COMBO PACK



PISMO  
COMBO PACK

<b>COMBO PACKS - all keyed levers below have SmartKey only</b>										
MFG Pro#	Function	Finish						Case Qty.	Keying	Price
<b>991 Combo Pack - Tustin® Lever with Single Cylinder Deadbolt</b>		3	L03	5	11P	15	514			
99910-040	991TNL - Single Cylinder					•		4	K4	\$134.00
99910-041	991TNL - Single Cylinder				•			4	K4	\$141.60
<b>991 Combo Pack - Juno® Knob with Single Cylinder Deadbolt</b>		3	L03	5	11P	15	514			
99910-032	991J - Single Cylinder	•						4	K4	\$96.40
99910-033	991J - Single Cylinder			•				4	K4	\$77.50
99910-035	991J - Single Cylinder				•			4	K4	\$121.60
99910-034	991J - Single Cylinder					•		4	K4	\$116.80
<b>992 Combo Pack - Juno® Knob with Double Cylinder Deadbolt</b>		3	L03	5	11P	15	514			
99920-006	992J - Double Cylinder					•		4	K4	\$127.60
99920-007	992J - Double Cylinder				•			4	K4	\$129.20
<b>991 Combo Pack Halifax Lever with Halifax Single Cylinder Deadbolt</b>		3	L03	5	11P	15	514			
99910-068	991HFL SQT - Single Cylinder					•			K4	\$143.70
99910-067	991HFL SQT - Single Cylinder					•			K4	\$143.70
<b>991 Combo Pack - Pismo Knob with Single Cylinder Deadbolt</b>		3	L03	5	11P	15	514			
99910-069	991PSK RDT - Single Cylinder					•		4	K4	\$125.40
99910-070	991PSK RDT - Single Cylinder					•		4	K4	\$125.40



980  
DEADBOLT



985  
DEADBOLT



UPTOWN



DOWNTOWN



MIDTOWN

<b>DEADBOLTS - all keyed levers below have SmartKey only</b>									
MFG Pro#	Function	Finish					Case Qty.	Keying	Price
<b>Single Cylinder Deadbolt</b>		3	L03	5	11P	15			
99800-120	980 - Single Cylinder	•					4	K4	\$58.10
99800-121	980 - Single Cylinder			•			4	K4	\$63.50
99800-122	980 - Single Cylinder				•		4	K4	\$67.30
99800-123	980 - Single Cylinder					•	4	K4	\$64.00
<b>Double Cylinder Deadbolt</b>		3	L03	5	11P	15			
99850-071	985 - Double Cylinder	•					4	K4	\$78.00
99850-073	985 - Double Cylinder				•		4	K4	\$93.70
99850-074	985 - Double Cylinder					•	4	K4	\$89.40

<b>DEADBOLTS - all keyed levers below have SmartKey only</b>												
MFG Pro#	Function	Finish								Case Qty.	Keying	Price
<b>Uptown Deadbolt</b>		3	L03	4	5	11P	15	26	514			
92580-016	258 RDT - Single Cylinder						•			4	K4	\$70.60
92580-020	258 RDT - Single Cylinder								•	4	K4	\$70.60
<b>Downtown Deadbolt</b>		3	L03	4	5	11P	15	26	514			
92580-018	258 SQT - Single Cylinder						•			4	K4	\$71.60
92580-022	258 SQT - Single Cylinder								•	4	K4	\$71.60
92580-033	258 SQT - Single Cylinder			•						4	K4	\$70.60
<b>Midtown Deadbolt</b>		3	L03	4	5	11P	15	26	514			
92580-034	258 MDT - Single Cylinder						•			4	K4	\$71.60
92580-035	258 MDT - Single Cylinder								•	4	K4	\$71.60





Henley

Trusted Security



- ANSI/BHMA Grade 3
- Easy Installation
- Handlesets Now Feature SmartKey Security™ to Protect Against Lock Bumping
- Most Recognized Style

Warranty

- Limited Mechanical
- Limited Finish

\*Lock Bumping - an attack technique using specially cut keys that can defeat conventional pin & tumbler locks.



660 RDT Contemporary



660/665 Deadbolt



Ladera



Delta\*



Amador



Belleview™



Dakota™



Henley



Balboa\*



Henly



Cove™



Polo\*



Tylo\*





<b>HANDLESETS - all keyed levers below have SmartKey only</b>											
<i>MFG Pro#</i>	<i>Function</i>	<i>Finish</i>								<i>Case Qty.</i>	<i>Price</i>
<b>Amador Handleset</b>		<b>3</b>	<b>L03</b>	<b>5</b>	<b>11P</b>	<b>15</b>	<b>26D</b>	<b>26</b>	<b>514</b>		
96870-151	687AMDXLRL RDT - Amador x Ladera RDT SMT					•				2	\$165.50
<b>Belleview™ Handleset</b>		<b>3</b>	<b>L03</b>	<b>5</b>	<b>11P</b>	<b>15</b>	<b>26D</b>	<b>26</b>	<b>514</b>		
96870-098	687BWXT - Belleview x Tylo x SMT			•						2	\$139.90
96870-100	687BWXC - Belleview x Cove SMT				•					2	\$145.30
96870-099	687BWXP - Belleview x Polo SMT					•				2	\$145.30
<b>Dakota™ Handleset</b>		<b>3</b>	<b>L03</b>	<b>5</b>	<b>11P</b>	<b>15</b>	<b>26D</b>	<b>26</b>	<b>514</b>		
96870-091	687DAXT - Dakota x Tylo SMT	•								2	\$134.60
96870-087	687DAXT - Dakota x Tylo SMT			•						2	\$139.90
96870-090	687DAXP - Dakota x Polo SMT					•				2	\$145.30
<b>Henley Handleset</b>		<b>3</b>	<b>L03</b>	<b>5</b>	<b>11P</b>	<b>15</b>	<b>26D</b>	<b>26</b>	<b>514</b>		
96870-172	687HYHXHYL Henley x Henley SMT 514								•	2	\$167.50



BALBOA



DELTA®



LADERA®



HENLEY

<b>LEVERS</b>												
<i>MFG Pro#</i>	<i>Function</i>	<i>Finish</i>								<i>Case Qty.</i>	<i>Keying</i>	<i>Price</i>
<b>Balboa Lever</b>		<b>3</b>	<b>L03</b>	<b>5</b>	<b>11P</b>	<b>15</b>	<b>26</b>	<b>26D</b>	<b>514</b>			
92001-526	200BL - Hall/Closet				•					6		\$38.70
93001-883	300BL - Bed/Bath				•					6		\$40.90
94050-674	405BL - SMT Keyed Entry				•					6	K6	\$67.10
94880-518	488BL LH - Inactive				•					4		\$17.30
94880-519	488BL RH - Inactive				•					4		\$17.30
92001-525	200BL - Hall/Closet					•				6		\$36.60
93001-882	300BL - Bed/Bath					•				6		\$38.70
94050-673	405BL - SMT Keyed Entry					•				6	K6	\$64.90
94880-495	488BL LH - Inactive					•				4		\$16.20
94880-496	488BL RH - Inactive					•				4		\$16.20
<b>Delta® Lever</b>		<b>3</b>	<b>L03</b>	<b>5</b>	<b>11P</b>	<b>15</b>	<b>26</b>	<b>26D</b>	<b>514</b>			
92001-522	200DL - Hall/Closet							•		6		\$35.50
93001-879	300DL - Bed/Bath							•		6		\$37.70
94050-675	405DL - SMT Keyed Entry							•		6	K6	\$60.20
94880-435	488DL - Inactive							•		4		\$15.50
<b>Ladera® Lever</b>		<b>3</b>	<b>L03</b>	<b>5</b>	<b>11P</b>	<b>15</b>	<b>26</b>	<b>26D</b>	<b>514</b>			
92001-578	200LRL RDT - Hall/Closet					•				6		\$38.70
93001-973	300LRL RDT - Bed/Bath					•				6		\$40.90
94880-580	488LRL RDT LH - Inactive					•				4		\$17.30
94880-581	488LRL RDT RH - Inactive					•				4		\$17.30
94050-615	405LRL RDT - SMT Keyed Entry					•				4	K6	\$64.60
92001-587	200LRL RDT - Hall/Closet							•		6		\$41.80
93002-015	300LRL RDT - Bed/Bath							•		6		\$44.00
94050-616	405LRL RDT - RDT SMT Keyed Entry							•		6	K6	\$67.70
94880-597	488LRL RDT - Inactive LH							•		4		\$19.30
94880-598	488LRL RDT - Inactive RH							•		4		\$19.30
<b>Henley Lever</b>		<b>3</b>	<b>L03</b>	<b>5</b>	<b>11P</b>	<b>15</b>	<b>26</b>	<b>26D</b>	<b>514</b>			
92001-627	200HYL - Hall/Closet							•		6		\$41.80
93002-941	300HYL - Bed/Bath							•		6		\$44.00
94050-705	405HYL - SMT Keyed Entry							•		6	K6	\$67.70
94880-637	488HYL - Inactive							•		4		\$19.30



COVE™



POLO®

KNOBS												
MFG Pro#	Function	Finish								Case Qty.	Keying	Price
Cove™ Knob		3	L03	5	11P	15	26	26D	514			
92001-511	200CV - Hall/Closet				•					6		\$24.40
93001-868	300CV - Bed/Bath				•					6		\$25.90
94002-956	400CV - SMT Keyed Entry				*					6	K6	\$34.60
94880-488	488CV - Inactive				•					4		\$11.40
92001-509	200CV - Hall/Closet					•				6		\$22.20
93001-866	300CV - Bed/Bath					•				6		\$23.80
94002-954	400CV - SMT Keyed Entry					•				6	K6	\$32.50
94880-490	488CV - Inactive					•				4		\$10.40
Polo® Knob		3	L03	5	11P	15	26	26D	514			
92001-516	200P - Hall/Closet	•								6		\$18.40
93001-873	300P - Bed/Bath	•								6		\$20.20
94002-831	400P - Entry	•								6	K6	\$27.00
94880-367	488P - Inactive	•								4		\$8.30
92001-510	200P - Hall/Closet				•					6		\$21.70
93001-867	300P - Bed/Bath				•					6		\$23.70
94002-822	400P - Entry				•					6	K6	\$30.10
94880-489	488P - Inactive				•					4		\$10.80
92001-518	200P - Hall/Closet					•				6		\$20.70
93001-875	300P - Bed/Bath					•				6		\$22.50
94002-826	400P - Entry					•				6	K6	\$28.80
94880-399	488P - Inactive					•				4		\$10.20
92001-516	200P - Hall/Closet								•	6		\$21.70
93001-873	300P - Bed/Bath								•	6		\$23.70
94002-831	400P - Keyed Entry SMT								•	6	K6	\$32.60



TYLO®



MOBILE HOME LOCKS

<b>KNOBS</b>												
<i>MFG Pro#</i>	<i>Function</i>	<i>Finish</i>								<i>Case Qty.</i>	<i>Keying</i>	<i>Price</i>
<b>Tylo® Knobs</b>		<b>3</b>	<b>L03</b>	<b>5</b>	<b>11P</b>	<b>15</b>	<b>26</b>	<b>26D</b>	<b>514</b>			
92001-513	200T - Hall/Closet	•								6		\$16.20
93001-870	300T - Bed/Bath	•								6		\$18.00
94002-828	400T - Keyed Entry	•								6	K6	\$23.50
94880-363	488T - Inactive	•								4		\$7.40
92001-512	200T - Hall/Closet			•						6		\$18.10
93001-869	300T - Bed/Bath			•						6		\$19.60
94002-827	400T - Keyed Entry			•						6	K6	\$26.30
94880-364	488T - Inactive			•						4		\$8.50
92001-508	200T - Hall/Closet					•				6		\$18.30
93001-865	300T - Bed/Bath					•				6		\$20.40
94002-820	400T - Keyed Entry					•				6	K6	\$26.90
94880-520	488T - Inactive					•				4		\$9.20
92001-514	200T - Hall/Closet							•		6		\$16.50
93001-871	300T - Bed/Bath							•		6		\$18.20
94002-829	400T - Keyed Entry							•		6	K6	\$25.20
94880-365	488T - Inactive							•		4		\$7.50
<i>MFG Pro#</i>	<i>Function</i>	<i>Finish</i>								<i>Case Qty.</i>	<i>Keying</i>	<i>Price</i>
<b>Mobile Home Locks</b>		<b>3</b>	<b>L03</b>	<b>5</b>	<b>11P</b>	<b>15</b>	<b>26</b>	<b>26D</b>	<b>514</b>	<b>Case Qty.</b>	<b>Keying</b>	<b>Price</b>
92001-519	200M - Hall/Closet	•								6		\$15.10
93001-876	300M - Bed/Bath	•								6		\$16.70
94002-825	400M - Entry	•								6	K6	\$22.80
92001-520	200M - Hall/Closet							•		6		\$15.30
93001-877	300M - Bed/Bath							•		6		\$17.00
94002-824	400M - Entry							•		6	K6	\$23.20



660 SINGLE CYLINDER



663 ONE SIDED DEADBOLT



665 DOUBLE CYLINDER



660 RDT CONTEMPORARY

<b>DEADBOLTS</b>										
<i>MFG Pro#</i>	<i>Function</i>	<i>Finish</i>						<i>Case Qty.</i>	<i>Keying</i>	<i>Price</i>
<b>Single Cylinder Deadbolt with SmartKey</b>		<b>3</b>	<b>5</b>	<b>11P</b>	<b>15</b>	<b>26D</b>	<b>514</b>			
96600-747	660 - SMT Single Cylinder	•						6	K6	\$29.10
96600-749	660 - SMT Single Cylinder		•					6	K6	\$31.30
96600-751	660 - SMT Single Cylinder			•				6	K6	\$32.60
96600-750	660 - SMT Single Cylinder				•			6	K6	\$31.30
96600-748	660 - SMT Single Cylinder					•		6	K6	\$29.60
96600-710	660 - SMT Single Cylinder						•	6	K6	\$31.90
<b>One-Sided Deadbolt</b>		<b>3</b>	<b>5</b>	<b>11P</b>	<b>15</b>	<b>26D</b>	<b>514</b>	<b>Case Qty.</b>	<b>Keying</b>	
96630-059	663 - One Sided Deadbolt - RCL RCS	•						4		\$12.70
96630-061	663 - One Sided Deadbolt - RCL RCS		•					4		\$13.50
96630-065	663 - One Sided Deadbolt RCL RCS				•			4		\$12.50
<b>Double Cylinder Deadbolt with SmartKey</b>		<b>3</b>	<b>5</b>	<b>11P</b>	<b>15</b>	<b>26D</b>	<b>514</b>	<b>Case Qty.</b>	<b>Keying</b>	
96650-509	665 SMT - Double Cylinder	•						6	K6	\$36.60
96650-510	665 SMT - Double Cylinder		•					6	K6	\$38.90
96650-516	665 SMT - Double Cylinder				•			6	K6	\$38.90
96650-511	665 SMT - Double Cylinder					•		6	K6	\$37.40
<b>Mobile Home Locks with SmartKey Cylinder</b>		<b>3</b>	<b>5</b>	<b>11P</b>	<b>15</b>	<b>26D</b>	<b>514</b>	<b>Case Qty.</b>	<b>Keying</b>	
96600-768	660M SMT - Mobile Home	•						6	K6	\$27.60
96600-767	660M SMT - Mobile Home					•		6	K6	\$28.00
<b>RDT Contemporary Single Cylinder Deadbolt</b>		<b>3</b>	<b>5</b>	<b>11P</b>	<b>15</b>	<b>26D</b>	<b>514</b>	<b>Case Qty.</b>	<b>Keying</b>	
96600-761	660 RDT - Single Cylinder						•	6	K6	\$35.09
96600-766	660 RDT - Single Cylinder				•			6	K6	\$33.09



COMBO PACK ENTRY KNOB/LEVER WITH DEADBOLT

<b>COMBO PACKS - all combo packs include 660 or 665 deadbolt &amp; keyed entry</b>										
MFG Pro#	Function	Finish						Case Qty.	Keying	Price
<b>690 Combo Pack - Cove™ Knob with Smartkey Single Cylinder Deadbolt</b>		<b>3</b>	<b>5</b>	<b>11P</b>	<b>15</b>	<b>26D</b>	<b>514</b>			
96900-421	690CV - SMT Single Cylinder			•				6	K6	\$65.30
96900-424	690CV - SMT Single Cylinder				•			6	K6	\$65.30
<b>690 Combo Pack - Balboa™ Lever with Smartkey Single Cylinder Deadbolt</b>		<b>3</b>	<b>5</b>	<b>11P</b>	<b>15</b>	<b>26D</b>	<b>514</b>			
96900-425	690BL - SMT Single Cylinder			•				6	K6	\$94.40
96900-420	690BL - SMT Single Cylinder				•			6	K6	\$94.40
<b>690 Combo Pack - Polo® Knob with Single Cylinder Deadbolt</b>		<b>3</b>	<b>5</b>	<b>11P</b>	<b>15</b>	<b>26D</b>	<b>514</b>			
96900-250	690P - Single Cylinder	•						6	K6	\$55.60
96900-251	690P - Single Cylinder		•					6	K6	\$59.90
96900-333	690P - Single Cylinder			•				6	K6	\$57.80
96900-320	690P - Single Cylinder				•			6	K6	\$57.80
96900-449	690P - Single Cylinder SMT						•	6	K6	\$62.80
<b>690 Combo Pack - Tylor® Knob with Single Cylinder Deadbolt</b>		<b>3</b>	<b>5</b>	<b>11P</b>	<b>15</b>	<b>26D</b>	<b>514</b>			
96900-252	690T - Single Cylinder					•		6	K6	\$54.40
96900-253	690T - Single Cylinder	•						6	K6	\$51.00
96900-254	690T - Single Cylinder		•					6	K6	\$57.40
96900-376	690T - Single Cylinder				•			6	K6	\$56.00
<b>690 Combo Pack - Delta® Lever with Smartkey Single Cylinder Deadbolt</b>		<b>3</b>	<b>5</b>	<b>11P</b>	<b>15</b>	<b>26D</b>	<b>514</b>			
96900-427	690DL - SMT Single Cylinder					•		6	K6	\$88.50
<b>695 Combo Pack - Tylor® Knob with Double Cylinder Deadbolt</b>		<b>3</b>	<b>5</b>	<b>11P</b>	<b>15</b>	<b>26D</b>	<b>514</b>			
96950-163	695T - Double Cylinder	•						6	K6	\$60.90
96950-164	695T - Double Cylinder		•					6	K6	\$65.30
96950-162	695T - Double Cylinder					•		6	K6	\$61.90



242 PROJECT PACK



243 PROJECT PACK

<b>PROJECT PACKS - all 242 project packs include 660 deadbolt &amp; keyed entry</b>									
<i>MFG Pro#</i>	<i>Function</i>	<i>Finish</i>					<i>Case Qty.</i>	<i>Keying</i>	<i>Price</i>
<b>Project Pack - 2 Keyed Tylo® Knobs with 2 Single Cylinder Deadbolts</b>		<b>3</b>	<b>5</b>	<b>11P</b>	<b>15</b>	<b>26D</b>			
92420-031	242T - 2 Keyed Knobs with 2 Single Cylinder Deadbolts	•					6	K2	\$106.00
92420-032	242T - 2 Keyed Knobs with 2 Single Cylinder Deadbolts		•				6	K2	\$114.60
92420-036	242T - 2 Keyed Knobs with 2 Single Cylinder Deadbolts					•	6	K2	\$108.70
92420-051	242T - 2 Keyed Knobs with 2 Single Cylinder Deadbolts				•		6	K2	\$112.00
<b>Project Pack - 2 Keyed Tylo® Knobs</b>		<b>3</b>	<b>5</b>	<b>11P</b>	<b>15</b>	<b>26D</b>			
92430-022	243T - 2 Keyed Knobs	•					6	K2	\$49.00
92430-035	243T - 2 Keyed Knobs					•	6	K2	\$49.70
<b>Project Pack - 2 Keyed Cove Knobs with 2 Smartkey Single Cylinder Deadbolts</b>		<b>3</b>	<b>5</b>	<b>11P</b>	<b>15</b>	<b>26D</b>			
92420-063	242CV SMT - 2 Keyed Knobs with 2 Single Cylinder Deadbolts			•			6	K2	\$119.60
92420-059	242CV SMT - 2 Keyed Knobs with 2 Single Cylinder Deadbolts				•		6	K2	\$117.90



# Kwikset



# HALO™

WI-FI ENABLED SMART LOCKS

Halo smart locks connect directly to your existing Wi-Fi router and smartphone to create a simple and secure smart home, without a third-party hub, panel or subscription service.



Works with the Kwikset App



## Control your lock from your smartphone



REMOTE ACCESS



EVENT HISTORY

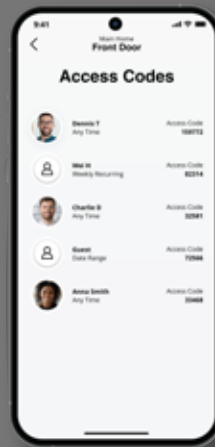

MANAGE ACCESS CODES



MANAGE MULTIPLE HOMES

## #1 SELLING U.S. LOCK BRAND\*

Numerator TruView, Unit Share Report, 2023

## Specifications

<b>Function</b>	Single cylinder deadbolt
<b>Door Prep</b>	2 1/8" diameter bore hole & 1" diameter latch hole
<b>Backset</b>	Adjustable 2 3/8" or 2 3/4"
<b>Door Thickness</b>	1 3/8" - 2" automatic adjustment
<b>Faceplates</b>	1" x 2 1/4" round corner standard
<b>Strikes</b>	Round corner, 4 hole strike, 2 3/4" x 1 1/8"
<b>Latch</b>	Round corner adjustable 2 3/8" x 2 3/4"
<b>Bolt</b>	1" throw, steel deadbolt
<b>Door Handing</b>	Reversible
<b>Cylinder</b>	SmartKey Security™

## Dimensions

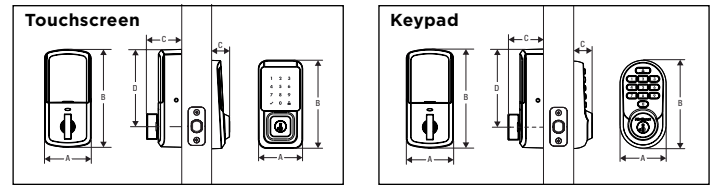

Touchscreen	A	B	C	D
Interior	2 3/4" (70 mm)	5 13/16" (147 mm)	2 1/8" (53 mm)	4 9/16" (116 mm)
Exterior	2 28/32" (73 mm)	5 5/8" (143 mm)	1 3/16" (30 mm)	---

Keypad	A	B	C	D
Interior	2 3/4" (70 mm)	5 13/16" (147 mm)	2 1/8" (53 mm)	4 9/16" (116 mm)
Exterior	2 28/32" (73 mm)	5 13/32" (137 mm)	1 3/16" (30 mm)	---

## Innovative Security

- 250 customizable access codes with optional schedules
- BHMA Grade AAA certified
- 20 Minute fire rating - UL certified
- Full 128-bit encryption security
- Featuring SmartKey Security™ - protecting against advanced break-in techniques
- SecureScreen™ - patented security feature prevents on-screen fingerprint user code identification (Touchscreen only)

## Easy Installation

- No hub required by connecting directly to your home Wi-Fi network
- Operates on (4) AA batteries
- Installs in minutes using a screwdriver

## Warranty

- Lifetime mechanical and finish warranty
- 1 year electronic warranty



## Finishes



## How it Works



# Kwikset



# HALO™

## TOUCH

FINGERPRINT SMART LOCK

The Halo Touch Wi-Fi enabled smart lock with fingerprint access technology allows you to simply use your unique fingerprint to lock and unlock your door.



## Control your lock from your smartphone



  
REMOTE  
ACCESS

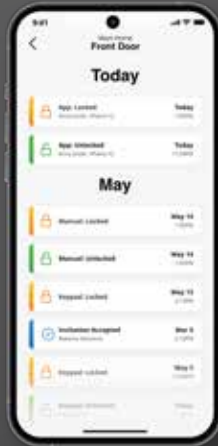

  
EVENT  
HISTORY

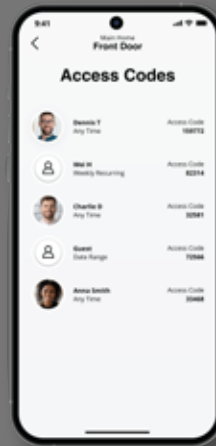

  
MANAGE  
ACCESS CODES

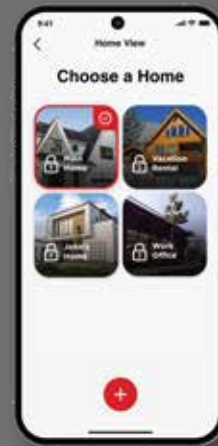

  
MANAGE MULTIPLE  
HOMES

## #1 SELLING U.S. LOCK BRAND\*

Numerator TruView, Unit Share Report, 2023

## Specifications

<b>Function</b>	Single cylinder deadbolt
<b>Door Prep</b>	2 1/8" diameter bore hole & 1" diameter latch hole
<b>Backset</b>	Adjustable 2 3/8" or 2 3/4"
<b>Door Thickness</b>	1 3/4" - 2" automatic adjustment
<b>Faceplates</b>	1" x 2 1/4" round corner standard
<b>Strikes</b>	Round corner, 4 hole strike, 2 3/4" x 1 1/8"
<b>Latch</b>	Round corner adjustable 2 3/8" x 2 3/4"
<b>Bolt</b>	1" throw, steel deadbolt
<b>Door Handing</b>	Reversible
<b>Cylinder</b>	SmartKey Security™
<b>Temp Range &amp; Humidity</b>	Temperature Range: Exterior: -40F to 150F Interior: 32F to 130F Humidity: Exterior: 100% condensing Interior: 30% - 95% non-condensing

## Innovative Security

- Up to 100 fingerprints/50 users
- BHMA Grade AAA certified
- 256-bit AES encryption security
- Featuring SmartKey Security™ - protecting against advanced break-in techniques

## Easy Installation

- No hub required by connecting directly to your home Wi-Fi network
- Operates on (4) AA batteries
- Installs in minutes using a screwdriver

## Warranty

- Lifetime mechanical and finish warranty
- 1 year electronic warranty

## How it Works

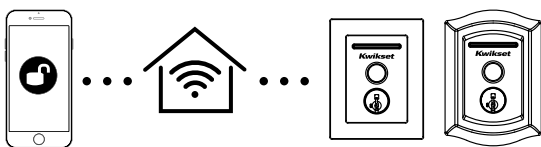

## Dimensions

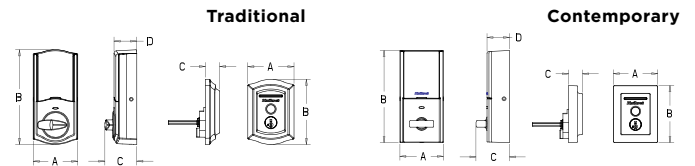

Traditional	A	B	C	D
Interior	2 23/32" (69 mm)	5 25/32" (147 mm)	1 15/16" (49 mm)	1 7/16" (35 mm)
Exterior	2 15/16" (72 mm)	3 31/32" (101 mm)	7/8" (22 mm)	---
Contemporary	A	B	C	D
Interior	2 23/32" (69 mm)	5 25/32" (147 mm)	2 2/32" (53 mm)	1 13/32" (36 mm)
Exterior	2 25/32" (71 mm)	3 9/16" (91 mm)	7/8" (22 mm)	---

## Finishes



Satin Nickel<sup>15</sup>  
99590-001



Venetian Bronze<sup>11P</sup>  
99590-002



Satin Nickel<sup>15</sup>  
99590-003



Matte Black<sup>514</sup>  
99590-004

FINISH AND  
**LIFETIME WARRANTY**  
MECHANICAL  
ONE YEAR  
ELECTRONIC WARRANTY



**Kwikset**



**aura**<sup>TM</sup>

BLUETOOTH KEYPAD SMART LOCK

Smarter Living

Aura<sup>TM</sup> Bluetooth<sup>TM</sup> smart lock gives you control of your door with your smartphone — it's as simple as that.



Bluetooth Enabled



Works with the Kwikset App

Control your lock from your phone



LOCAL ACCESS

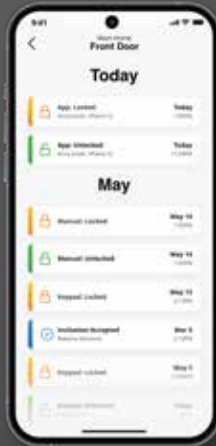

EVENT HISTORY

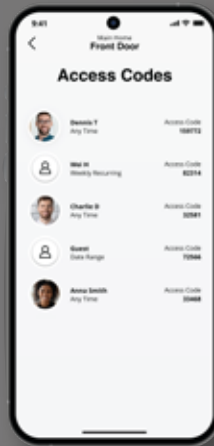

MANAGE ACCESS CODES



MANAGE MULTIPLE HOMES

**#1 SELLING U.S. LOCK BRAND\***

Numerator TruView, Unit Share Report, 2023

## Specifications

<b>Function</b>	Single cylinder deadbolt
<b>Door Prep</b>	2 1/8" diameter bore hole & 1" diameter latch hole
<b>Backset</b>	Adjustable 2 3/8" or 2 3/4"
<b>Door Thickness</b>	1 3/8" - 2" automatic adjustment
<b>Faceplates</b>	1" x 2 1/4" round corner standard
<b>Strikes</b>	Round corner, 4 hole strike, 2 3/4" x 1 1/8"
<b>Latch</b>	Round corner adjustable 2 3/8" x 2 3/4"
<b>Bolt</b>	1" throw, steel deadbolt
<b>Door Handing</b>	Reversible
<b>Cylinder</b>	SmartKey Security™

## Dimensions

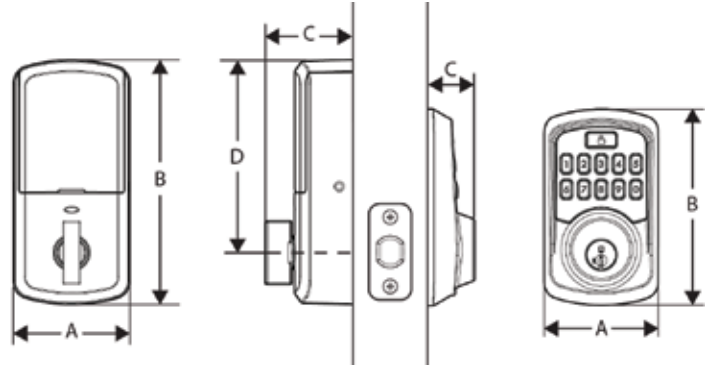

Design	A	B	C	D
Interior	2 3/4" (70 mm)	5 13/16" (147 mm)	2 1/8" (53 mm)	4 9/16" (116 mm)
Exterior	2 23/32" (69 mm)	4 5/8" (117 mm)	1 3/16" (30 mm)	---

## Innovative Security

- 250 customizable access codes with optional schedules
- BHMA Grade AAA certified
- 20 Minute fire rating - UL certified
- Full 128-bit encryption security
- Featuring SmartKey Security™ - protecting against advanced break-in techniques

## Easy Installation

- Installs in minutes with just a screwdriver
- No hard wiring needed
- Operates on 4 AA batteries

## Warranty

- Lifetime mechanical and finish warranty
- 1 year electronic warranty



## Finishes



Satin Nickel<sup>15</sup>  
99420-001

Venetian Bronze<sup>11P</sup>  
99420-002

Matte Black<sup>514</sup>  
99420-003

## How it Works

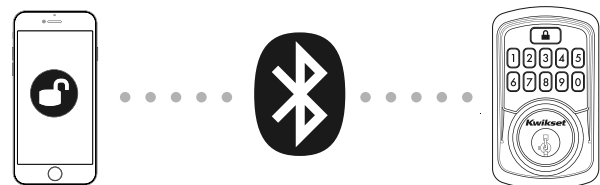





# Powerbolt<sup>®</sup> 240

KEYPAD ELECTRONIC LOCK



**Simple and easy access control that you can depend on.**

- **KEYLESS ENTRY:** Makes coming and going secure and convenient.
- **EASY CODE MANAGEMENT:** 12 user codes and 2 one-time user codes.
- **AUTO LOCK:** Peace of mind with customizable, automatic locking.
- **INTRUSION ALERT:** 3 wrong codes disable keypad and sound alarm.
- **EASY LOW LIGHT CODE ENTRY:** Bright LED light up keypad.

## Specifications

<b>Battery</b>	6V, 4 x AA alkaline batteries, 12-month battery life (batteries not included)
<b>Door Prep</b>	1 1/2" (38mm) or 2 1/8" (54mm) diameter cross bore hole and 1" diameter edge bore hole
<b>Backset</b>	Adjustable 2 3/8" (60mm) or 2 3/4" (70mm)
<b>Door Thickness</b>	1 3/8" (35mm) to 1 3/4" (44mm) standard. Thick door service part available for 2-1/4" (57mm) thick doors.
<b>Faceplates</b>	1" (25 mm) x 2 1/4" (57 mm) round corner faceplate with drive-in collar standard
<b>Strikes</b>	2 3/4" (70mm) x 1 1/8" (29mm) round corner 2-hole strike
<b>Bolt</b>	1" (25mm) throw, steel bolt
<b>Door Handing</b>	Reversible for right or left-hand doors
<b>Cylinder</b>	KW1 P&T cylinder
<b>Security</b>	Deadbolt: A156.36 Grade 3 Certified
<b>Temperature Range</b>	Exterior: -40F to 150F, Interior: 32F to 130F
<b>Humidity</b>	Exterior: 100% condensing, Interior: 30% to 95% non-condensing
<b>Warranty</b>	Lifetime Limited Mechanical and Finish Warranty; One Year Limited Electronics Warranty
<b>Codes</b>	Up to 12 user codes and 2 one-time user codes with optional programming code

## Dimensions

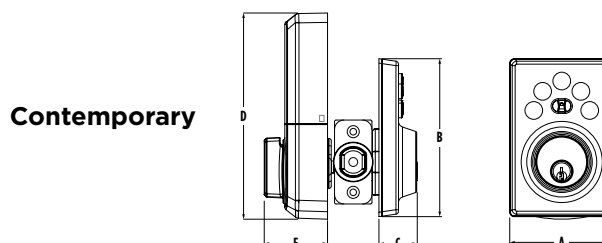
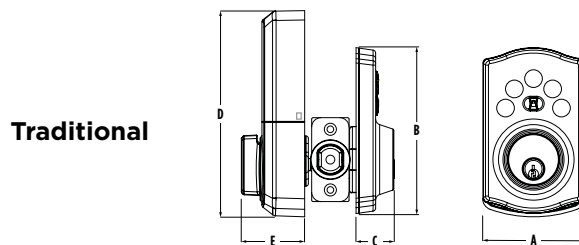

Design	A	B	C	D	E
CNT	2 25/32" (71 mm)	4 7/32" (107 mm)	1 1/32" (26 mm)	5 1/2" (140 mm)	1 11/16" (43 mm)
TRL	2 11/16" (71 mm)	4 7/16" (107 mm)	1 1/32" (26 mm)	5 1/2" (140 mm)	1 11/16" (43 mm)

## Features

- **VACATION MODE:** Disable the keypad when you're out of town.
- **ONE-TOUCH LOCKING:** Lock the door with the touch of a button.
- **12-MONTH BATTERY LIFE:** 4x AA alkaline batteries (not included).
- **EASY INSTALL and BILT App:** Installs with just a screwdriver. BILT 3D interactive instructions provide voice, text and animation guidance for an easy installation.
- **CERTIFIED SECURITY:** BHMA Grade 3. Security, Durability and Finish.

FINISH AND  
**LIFETIME WARRANTY\***  
MECHANICAL  
ONE YEAR  
ELECTRONIC WARRANTY\*

\*See [kwikset.com/support/warranty](http://kwikset.com/support/warranty) for the lifetime limited mechanical and finish warranties and one-year limited electronics warranty.

\*Consulte [kwikset.com/support/warranty](http://kwikset.com/support/warranty) para ver las garantías mecánicas y de acabado limitadas de por vida y la garantía limitada de un año de los electrónicos.

## Finishes



Polished Brass **LOS**



Satin Nickel **15**



Venetian Bronze **11P**



Satin Nickel **15**



Matte Black **514**





# Powerbolt<sup>®</sup> 250

KEYPAD ELECTRONIC LOCK



## Keyless entry solution providing more freedom and more value

- **KEYLESS ENTRY:** Makes coming and going secure and convenient.
- **EASY CODE MANAGEMENT:** 25 user codes and 5 one-time user codes.
- **AUTO LOCK:** Peace of mind with customizable, automatic locking.
- **INTRUSION ALERT:** 3 wrong codes disable keypad and sound alarm.
- **EASY LOW LIGHT CODE ENTRY:** Bright LED light up keypad.

## Specifications

<b>Battery</b>	6V, 4 x AA alkaline batteries, 12-month battery life (batteries not included)
<b>Door Prep</b>	1 1/2" (38mm) or 2 1/8" (54mm) diameter cross bore hole and 1" diameter edge bore hole
<b>Backset</b>	Adjustable 2 3/8" (60mm) or 2 3/4" (70mm)
<b>Door Thickness</b>	1 3/8" (35mm) to 1 3/4" (44mm) standard. Thick door service part available for 2-1/4" (57mm) thick doors.
<b>Faceplates</b>	1" (25 mm) x 2 1/4" (57 mm) round corner faceplate with drive-in collar standard
<b>Strikes</b>	2 3/4" (70mm) x 1 1/8" (29mm) round corner 2-hole strike
<b>Bolt</b>	1" (25mm) throw, steel bolt
<b>Door Handing</b>	Reversible for right or left-hand doors
<b>Cylinder</b>	SmartKey Security™ KW1 cylinder
<b>Security</b>	Deadbolt: A156.36 Grade 3 Certified
<b>Temperature Range</b>	Exterior: -40F to 150F, Interior: 32F to 130F
<b>Humidity</b>	Exterior: 100% condensing, Interior: 30% to 95% non-condensing
<b>Warranty</b>	Lifetime Limited Mechanical and Finish Warranty; One Year Limited Electronics Warranty
<b>Codes</b>	Up to 25 user codes and 5 one-time user codes with optional programming code

## Dimensions

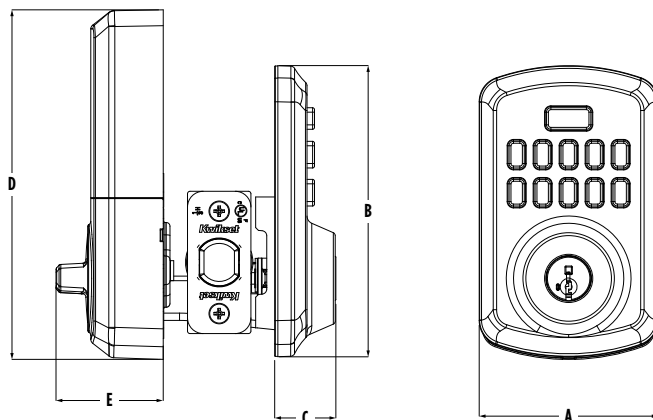

Design	A	B	C	D	E
250 TRS	2 13/16" (71 mm)	4 19/32" (117 mm)	31/32" (24 mm)	5 1/2" (140 mm)	1 11/16" (43 mm)

## Features

- **VACATION MODE:** Disable the keypad when you're out of town.
- **FEATURING SMARTKEY SECURITY:** Re-key the lock yourself in seconds.
- **12-MONTH BATTERY LIFE:** 4x AA alkaline batteries (not included).
- **EASY INSTALL and BILT App:** Installs with just a screwdriver. BILT 3D interactive instructions provide voice, text and animation guidance for an easy installation.
- **CERTIFIED SECURITY:** BHMA Grade 3. Security, Durability and Finish.

## Finishes



Satin Nickel 15



Venetian Bronze 11P



Matte Black 514



Lifetime Polished Brass L03

FINISH AND  
**LIFETIME\***  
WARRANTY  
MECHANICAL  
ONE YEAR  
ELECTRONIC WARRANTY\*

\*See [kwikset.com/support/warranty](http://kwikset.com/support/warranty) for the lifetime limited mechanical and finish warranties and one-year limited electronics warranty.

\*Consulte [kwikset.com/support/warranty](http://kwikset.com/support/warranty) para ver las garantías mecánicas y de acabado limitadas de por vida y la garantía limitada de un año de los electrónicos.





## SMARTCODE 260™

KEYPAD ELECTRONIC LOCK



The SmartCode™ 260 Keypad Electronic Deadbolt offers a sleek 10-button design, Microban® Antimicrobial Technology protection and the convenience of one-touch locking. This keyless deadbolt comes in a traditional or contemporary design, which perfectly complements the Kwikset Prescott and San Clemente handlesets.

### Features

- The responsive keypad provides bright LED illumination for easy code access
- Fast motorized deadbolt with one-touch locking
- Auto-locking after 30 seconds or select custom auto-lock time delay
- Protected with Microban® Antimicrobial Technology built into the keypad and finish

### User Codes

- Up to 50 user codes for family, guests and service professionals
- Programming code for improved access code management



## Specifications

<b>Battery</b>	Uses 4 x AA 6V alkaline cell batteries with approximately 1 year battery life
<b>Function</b>	Single cylinder deadbolt
<b>Door Prep</b>	1 1/2" (38mm) or 2 1/8" (54mm) diameter cross bore hole and 1" diameter edge bore hole
<b>Backset</b>	Adjustable 2 3/8" (60mm) or 2 3/4" (70mm)
<b>Door Thickness</b>	1 3/8" (35mm) to 1 3/4" (44mm) standard. Thick door service part available for 2-1/4" (57mm) thick doors
<b>Faceplates</b>	1" (25 mm) x 2 1/4" (57 mm) round corner faceplate with drive-in collar standard
<b>Strikes</b>	2 3/4" (70mm) x 1 1/8" (29mm) round corner 4 hole strike
<b>Bolt</b>	1" (25mm) throw, steel bolt with anti-saw security pin
<b>Door Handing</b>	Reversible
<b>Cylinder</b>	SmartKey Security™ with 2 KW1 keys
<b>Temperature Range</b>	Exterior: -40°F to 150°F (-40°C to 66°C) Interior: 32°F to 130°F (0°C to 54°C)
<b>Humidity</b>	Exterior: 100% condensing Interior: 30% to 95% non-condensing
<b>Codes</b>	Up to 50 user codes and 10 one-time user codes with optional programming code

## Dimensions

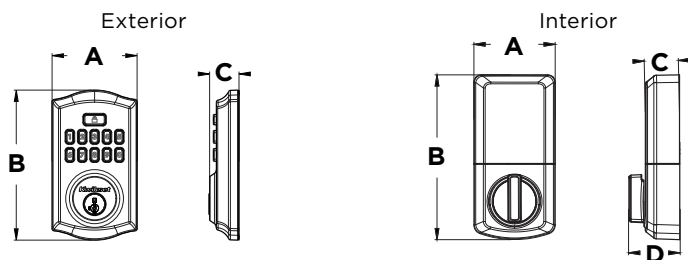

**Traditional**

Design	A	B	C	D
Exterior	2 13/16" (71 mm)	5" (127 mm)	1" (25 mm)	---
Interior	2 3/4" (70 mm)	5 1/2" (140 mm)	1 1/8" (29 mm)	1 11/16" (43 mm)

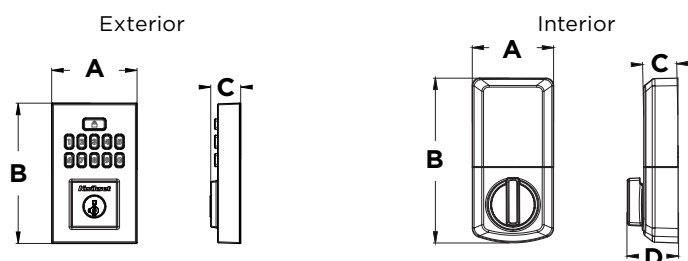

**Contemporary**

Design	A	B	C	D
Exterior	2 3/4" (70 mm)	4 9/16" (116 mm)	1" (25 mm)	---
Interior	2 3/4" (70 mm)	5 1/2" (140 mm)	1 1/8" (29 mm)	1 11/16" (43 mm)

## Easy Installation

- Replaces existing door hardware with just a Phillips screwdriver
- No hard wiring needed and fits all standard doors
- Download the free **BILT** app featuring 3D instructions for quick and easy installation

## Innovative Security

- BHMA Grade 2 certified
- 20 Minute fire rating - UL certified
- Featuring SmartKey Security™

## Finishes



**992600-001**  
Polished Brass **LO3**  
260 TRL LO3



**992600-002**  
Satin Nickel **15**  
260 TRL 15



**992600-003**  
Venetian Bronze **11P**  
260 TRL 11P



**992600-004**  
Satin Nickel **15**  
260 CNT 15



**992600-005**  
Polished Chrome **26**  
260 CNT 26



**992600-006**  
Matte Black **514**  
260 CNT 514

FINISH AND  
**LIFETIME WARRANTY\***  
MECHANICAL

ONE YEAR  
ELECTRONIC WARRANTY\*

\*See [kwikset.com/support/warranty](http://kwikset.com/support/warranty) for the lifetime limited mechanical and finish warranties and one-year limited electronics warranty.

\*Consulte [kwikset.com/support/warranty](http://kwikset.com/support/warranty) para ver las garantías mecánicas y de acabado limitadas de por vida y la garantía limitada de un año de los electrónicos.



## SMARTCODE 270

TOUCHPAD ELECTRONIC LOCK



The SmartCode™ 270 Touchpad Electronic Deadbolt combines touchpad tactile feedback with bright LED illumination for easy code access. This keyless deadbolt comes in a traditional or contemporary design, which perfectly complements the Kwikset Prescott and San Clemente handlesets.

### Features

- The responsive touchpad offers sleek style with a large and bright LED to communicate lock status
- Fast motorized deadbolt with one-touch locking
- Auto-locking after 30 seconds or select custom auto-lock time delay

### User Codes

- Up to 50 user codes for family, guests and service professionals
- Programming code for improved access code management



## Specifications

<b>Battery</b>	Uses 4 x AA 6V alkaline cell batteries with approximately 1 year battery life
<b>Function</b>	Single cylinder deadbolt
<b>Door Prep</b>	1 1/2" (38mm) or 2 1/8" (54mm) diameter cross bore hole and 1" diameter edge bore hole
<b>Backset</b>	Adjustable 2 3/8" (60mm) or 2 3/4" (70mm)
<b>Door Thickness</b>	1 3/8" (35mm) to 1 3/4" (44mm) standard. Thick door service part available for 2-1/4" (57mm) thick doors.
<b>Faceplates</b>	1" (25 mm) x 2 1/4" (57 mm) round corner faceplate with drive-in collar standard
<b>Strikes</b>	2 3/4" (70mm) x 1 1/8" (29mm) round corner 4 hole strike
<b>Bolt</b>	1" (25mm) throw, steel bolt with anti-saw security pin
<b>Door Handing</b>	Reversible
<b>Cylinder</b>	SmartKey Security™ with 2 KW1 keys
<b>Temperature Range</b>	Exterior: -40°F to 150°F (-40°C to 66°C) Interior: 32°F to 130°F (0°C to 54°C)
<b>Humidity</b>	Exterior: 100% condensing Interior: 30% to 95% non-condensing
<b>Codes</b>	Up to 50 user codes and 10 one-time user codes with optional programming code

## Dimensions

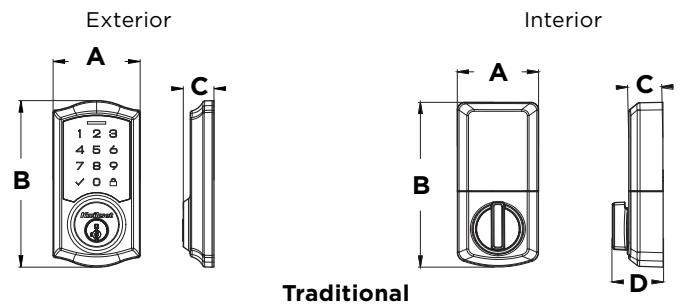

**Traditional**

Design	A	B	C	D
Exterior	2 13/16" (71 mm)	5 3/8" (137 mm)	1" (25 mm)	---
Interior	2 3/4" (70 mm)	5 1/2" (140 mm)	1 1/8" (29 mm)	1 1/16" (43 mm)

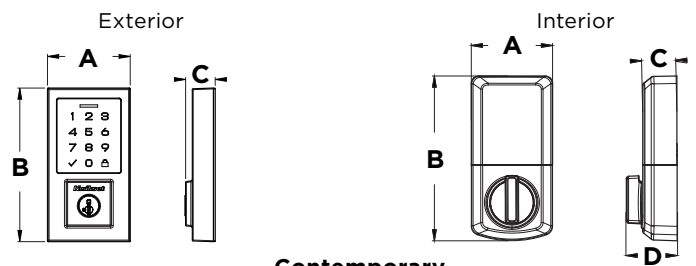

**Contemporary**

Design	A	B	C	D
Exterior	2 3/4" (70 mm)	5 3/16" (132 mm)	1" (25 mm)	---
Interior	2 3/4" (70 mm)	5 1/2" (140 mm)	1 1/8" (29 mm)	1 1/16" (43 mm)

## Easy Installation

- Replace existing door hardware with just a Phillips screwdriver
- No hard wiring needed and fits all standard doors
- Download the free **BILT** app featuring 3D instructions for quick and easy installation

## Innovative Security

- BHMA Grade 2 certified
- 20 Minute fire rating – UL certified
- Featuring SmartKey Security™

## Finishes



**992700-002**  
Satin Nickel 15  
270 TRL 15



**992700-003**  
Venetian Bronze 11P  
270 TRL 11P



**992700-004**  
Satin Nickel 15  
270 CNT 15



**992700-005**  
Matte Black 514  
270 CNT 514

FINISH AND  
**LIFETIME**  
WARRANTY  
MECHANICAL

ONE YEAR  
ELECTRONIC WARRANTY\*

\*See [kwikset.com/support/warranty](http://kwikset.com/support/warranty) for the lifetime limited mechanical and finish warranties and one-year limited electronics warranty.

\*Consulte [kwikset.com/support/warranty](http://kwikset.com/support/warranty) para ver las garantías mecánicas y de acabado limitadas de por vida y la garantía limitada de un año de los electrónicos.

# HomeConnect 620

KEYPAD CONNECTED SMART LOCK

With Z-Wave® 700 Chipset



## Features

- 10-Button keypad with one-touch locking
- Featuring Smartkey® Security Technology
- Sleek, all metal design
- Z-Wave® 700 for enhanced network security, network pre-enrollment, and extended wireless range and battery life
- Backward compatible with existing Z-Wave panels and hubs
- S2 Secure Network Enrollment
- SmartStart Network Pre-Enrollment

## User Codes

- 250 user codes
- Control when people have access with customizable user code schedules
- MasterCode security for improved feature management

## Connected Benefits

- Lock/Unlock your doors from anywhere
- View lock status and receive notifications of your lock's activity
- Connect to other devices in the home and create scenes driven by the door lock



## Specifications

### Electrical:

<b>Input Power</b>	6V (4 x AA alkaline batteries)
--------------------	--------------------------------

### Mechanical:

<b>Door Prep</b>	1 1/2" & 2 1/8" diameter bore hole & 1" deep latch hole
<b>Backset</b>	Adjustable 2 3/8" or 2 3/4"
<b>Door Thickness</b>	1 3/8" - 2" automatic adjustment
<b>Faceplates</b>	1" x 2 1/4" round corner standard
<b>Strikes</b>	Round corner strike 1 1/8" x 2 3/4"
<b>Latch</b>	Round corner adjustable 2 3/8" x 2 3/4"
<b>Bolt</b>	1" throw, steel deadbolt
<b>Door Handing</b>	Reversible
<b>Cylinder</b>	SmartKey® Keyway

### Environmental:

<b>Temperature Range</b>	Exterior: -40°F to 150°F Interior: 32°F to 140°F
<b>Humidity</b>	Exterior: 100% condensing Interior: 30% - 95% non-condensing

## Finishes



Satin Nickel 15



Venetian Bronze 11P



Polished Brass 3



Satin Nickel 15



Venetian Bronze 11P



Polished Chrome 26



Matte Black 514

## Dimensions

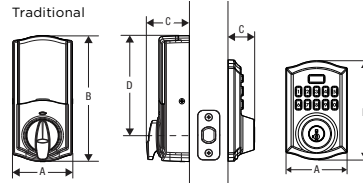

	Interior	Exterior
<b>A</b>	2 23/32" (69.1 mm)	2 13/16" (71.43 mm)
<b>B</b>	5 25/32" (146.6 mm)	4 9/16" (115.887 mm)
<b>C</b>	1 15/16" (49.5 mm)	1 1/4" (31.75 mm)
<b>D</b>	4 19/32" (116.5 mm)	---

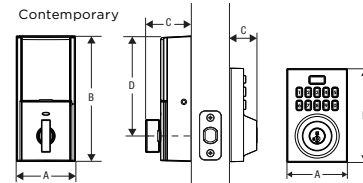

	Interior	Exterior
<b>A</b>	2 23/32" (69.1 mm)	2 25/32" (70.64 mm)
<b>B</b>	5 25/32" (146.6 mm)	4 5/16" (109.53 mm)
<b>C</b>	2 1/8" (53.97 mm)	1 1/4" (31.75 mm)
<b>D</b>	4 1/2" (114.3 mm)	---

## Easy Installation

- Replaces existing door hardware with just a screwdriver
- No hard wiring needed
- Operates on 4 x AA alkaline batteries

## Innovative Security

- BHMA Grade 2 certified
- Full 128-bit encryption security
- Features SmartKey® Security Re-Key Technology with BumpGuard™ Protection
- Revolutionary tapered deadbolt design—enables misaligned doors to lock without pulling and pushing your door shut
- Supports S2 Secure Network Enrollment

FINISH AND  
LIFETIME  
WARRANTY  
MECHANICAL  
ONE YEAR  
ELECTRONIC WARRANTY



# Electronic Locks

Kwikset's electronic door locks offer users the convenience of keyless entry, virtually eliminating the need for keys. All of our electronic locks are easy to install and program while complementing any Kwikset knob, lever or handleset.



## Features



- Smart Locks Replace any Deadbolt for Keyless Entry Convenience
- SmartCode™ Lever Ideal for - Small/Home Office, Utility/Storage Room, Interior Garage/Side Door
- Lock Your Door with the Touch of a Button
- Customizable Access Codes for Increased Security
- Back-Lit Keypad for Increased Visibility
- Customizable Automatic Door Locking After 30 Seconds for Peace Of Mind
- Installs In Minutes with Just a Screwdriver - No Hard Wiring Required
- Fits Standard Doors ( 1 3/8" - 2" ) with No Screw Holes Required

## Warranty

- 1 Year Electronic Warranty
- Limited Finish & Mechanical Warranty



<b>ELECTRONIC LOCKS</b>											
<b>SmartCode™ 917</b>		<b>3</b>	<b>L03</b>	<b>5</b>	<b>11P</b>	<b>15</b>	<b>26</b>	<b>26D</b>	<b>514</b>		
99170-001	917TNL 15 SMT CP RCALFD					•				2	\$262.00
99170-002	917TNL 11P SMT CP RCALFD				•					2	\$262.00
99170-003	917HFL 15 SMT CP RCALFD					•				2	\$262.00
99170-004	917HFL 514 SMT CP RCALFD								•	2	\$262.00
99170-005	917HFL 26 SMT CP RCALFD						•			2	\$262.00



<b>Halo Wi-Fi Touchscreen</b>											
<b>3</b>	<b>L03</b>	<b>5</b>	<b>11P</b>	<b>15</b>	<b>26</b>	<b>26D</b>	<b>514</b>				
99390-001	939 WIFI TSCR 15 SMT TPR RCALFD					•				1	\$504.00
99390-002	939 WIFI TSCR 11P SMT TPR RCALFD				•					1	\$504.00
99390-003	939 WIFI TSCR 26 SMT TPR RCALFD						•			1	\$504.00
99390-004	939 WIFI TSCR 514 SMT TPR RCALFD							•		1	\$504.00



<b>Halo Wi-Fi Keypad</b>											
<b>3</b>	<b>L03</b>	<b>5</b>	<b>11P</b>	<b>15</b>	<b>26</b>	<b>26D</b>	<b>514</b>				
99380-001	938 WIFI KYPD 15 SMT TPR RCALFD					•				1	\$438.00
99380-002	938 WIFI KYPD 11P SMT TPR RCALFD				•					1	\$438.00



<b>Halo Touch Wi-Fi</b>											
<b>3</b>	<b>L03</b>	<b>5</b>	<b>11P</b>	<b>15</b>	<b>26</b>	<b>26D</b>	<b>514</b>				
99590-001	959 TRL FPRT WIFI 15 RCAL RCS					•				1	\$517.00
99590-002	959 TRL FPRT WIFI 11P RCAL RCS				•					1	\$517.00
99590-003	959 CNT FPRT WIFI 15 RCAL RCS					•				1	\$517.00
99590-004	959 CNT FPRT WIFI 514 RCAL RCS							•		1	\$517.00



<b>SmartCode™ 9260 Traditional</b>											
<b>3</b>	<b>L03</b>	<b>5</b>	<b>11P</b>	<b>15</b>	<b>26</b>	<b>26D</b>	<b>514</b>				
992600-001	SmartCode 9260 Keypad Deadbolt		•							2	\$231.00
992600-002	SmartCode 9260 Keypad Deadbolt					•				2	\$231.00
992600-003	SmartCode 9260 Keypad Deadbolt				•					2	\$231.00



<b>SmartCode™ 9260 Contemporary</b>											
<b>3</b>	<b>L03</b>	<b>5</b>	<b>11P</b>	<b>15</b>	<b>26</b>	<b>26D</b>	<b>514</b>				
992600-004	SmartCode 9260 Keypad Deadbolt				•					2	\$231.00
992600-005	SmartCode 9260 Keypad Deadbolt					•				2	\$231.00
992600-006	SmartCode 9260 Keypad Deadbolt						•			2	\$231.00



<b>SmartCode™ 9270 Traditional</b>											
<b>3</b>	<b>L03</b>	<b>5</b>	<b>11P</b>	<b>15</b>	<b>26</b>	<b>26D</b>	<b>514</b>				
992700-002	SmartCode 9270 Touchpad Deadbolt				•					2	\$275.00
992700-003	SmartCode 9270 Touchpad Deadbolt			•						2	\$275.00



<b>SmartCode™ 9270 Contemporary</b>											
<b>3</b>	<b>L03</b>	<b>5</b>	<b>11P</b>	<b>15</b>	<b>26</b>	<b>26D</b>	<b>514</b>				
992700-004	SmartCode 9270 Touchpad Deadbolt				•					2	\$275.00
992700-005	SmartCode 9270 Touchpad Deadbolt						•			2	\$275.00



<b>ELECTRONIC LOCKS</b>											
<b>Aura™ Bluetooth</b>		3	L03	5	11P	15	26	26D	514		
99420-001	942 BLE DB 15 SMT TPR RCALFD					•				1	\$328.00
99420-002	942 BLE DB 11P SMT TPR RCALFD				•					1	\$328.00
99420-003	942 BLE DB 514 SMT TPR RCALFD								•	1	\$328.00



<b>Powerbolt 240 Traditional</b>		3	L03	5	11P	15	26	26D	514		
992400-001	9240 TRL L03 RBP 4AL RCS		•								\$100.00
992400-002	9240 TRL 15 RBP 4AL RCS					•					\$100.00
992400-003	9240 TRL 11P RBP 4AL RCS				•						\$100.00



<b>Powerbolt 240 Contemporary</b>		3	L03	5	11P	15	26	26D	514		
992400-004	9240 CNT 15 RBP 4AL RCS					•					\$100.00
992400-005	9240 CNT 514 RBP 4AL RCS								•		\$100.00



<b>Powerbolt 250 Transitional</b>		3	L03	5	11P	15	26	26D	514		
992500-001	9250 TRS L03 SMT RBP 4AL RCS		•								\$143.00
992500-002	9250 TRS 15 SMT RBP 4AL RCS					•					\$143.00
992500-003	9250 TRS 11P SMT RBP 4AL RCS				•						\$143.00
992500-004	9250 TRS 514 SMT RBP 4AL RCS								•		\$143.00



<b>Commercial Electronic Lever</b>		3	L03	5	11P	15	26	26D	514		
99550-001	955PML 26D SMT CP							•		1	\$237.00
99550-002	955PML 15 SMT CP					•				1	\$237.00
99550-003	955PML 11P SMT CP				•					1	\$237.00
99550-004	955PML 514 SMT CP								•	1	\$237.00



Control your lock from anywhere on your smart phone, tablet, or internet connected device and never worry about forgetting to lock your door again.

- Remotely lock and unlock your door from anywhere
- Receive notifications of your lock's activity
- Control when others have access to your home
- Arm or disarm your security panel
- Wirelessly communicate to other devices in your home

Electronic Locks with Home Connect (Z-Wave)									
Item Number	Function	Finish						Case Qty.	Price
<b>SmartCode™ 916 Contemporary with Home Connect</b>		L03	11P	15	26	26D	514		
99160-041	916CNT 500 15 SMT CP TPR RCALFD V2			•				1	\$506.00
99160-043	916CNT 500 26 SMT CP TPR RCALFD V2				•			1	\$506.00
99160-044	916CNT 500 514 SMT CP TPR RCALFD V2						•	1	\$506.00
99160-042	916CNT 500 11P SMT CP TPR RCALFD V2		•					1	\$506.00



\*Product must be ordered by item number and not description

<b>SmartCode™ 916 Traditional with Home Connect</b>									
Item Number	Function	L03	11P	15	26	26D	514	Case Qty.	Price
99160-039	916TRL 500 11P SMT CP TPR RCALFD V2		•					1	\$506.00
99160-038	916TRL 500 15 SMT CP TPR RCALFD V2			•				1	\$506.00



\*Product must be ordered by item number and not description

## Features

- Full 128-Bit Encryption Security
- Motorized locking mechanism enables true remote locking & unlocking
- SmartKey Security - providing superior security against advanced break-in techniques.
- Easy Integration
- Z-Wave Wireless Protocol
- Fits Standard Doors (1 3/8"-2") with No Screw Holes Required
- 4 AA Alkaline Batteries (no hard wiring) - batteries last for approximately 1 year



SmartCode™ 912 with Home Connect		L03	11P	15	26	26D	Case Qty.	
99120-037	912TNL ZW500 15 RCALFD			•			1	\$413.00
99120-038	912TNL ZW500 11P RCALFD		•				1	\$413.00

\*Product must be ordered by item number and not description



Home Connect Traditional 620		L03	11P	15	26	26D	514	Case Qty.	
98930-001	HC620 TRL ZW700 15 SMT RCALFD RCS BP			•				1	\$297.00
98930-002	HC620 TRL ZW700 11P SMT RCALFD RCS BP		•					1	\$297.00
98930-003	HC620 TRL ZW700 L03 SMT RCALFD RCS BP	•						1	\$297.00

\*Product must be ordered by item number and not description



Home Connect 620 Contemporary		L03	11P	15	26	26D	514	Case Qty.	
98930-004	HC620 CNT ZW700 15 SMT RCALFD RCS BP			•				1	\$297.00
98930-005	HC620 CNT ZW700 11P SMT RCALFD RCS BP		•					1	\$297.00
98930-006	HC620 CNT ZW700 26 SMT RCALFD RCS BP				•			1	\$297.00
98930-007	HC620 CNT ZW700 514 SMT RCALFD RCS BP						•	1	\$297.00

\*Product must be ordered by item number and not description

# KEY CONTROL™ DEADBOLT



Easily access the Key Control cylinder: (1) Insert the SmartKey Tool into the slot at bottom of cylinder cover (2) Rotate cover clockwise to expose the Key Control cylinder. (3) Now you have access to the Key Control cylinder. Use tool to rotate counter-clockwise back to user's keyway when appropriate.

## Features

- Two Separate Cylinders, Tenant & Property Manager, Allow for More Tenant Key Cuts Than a Traditional Master Key System
- New Proprietary Keyway Adds Security
- Property Manager Cylinder is Concealed When Not in Use to Avoid Tenant Confusion
- With Smartkey®, Re-Key the Lock Without Removing From the Door



LIGHT COMMERCIAL							Case Qty.	Price
MFG Pro#	Function	Finish						
<b>Key Control Deadbolt</b>		3	11P	15	26D	514		
98160-007	816 - Key Control Deadbolt	•					6	\$65.70
98160-009	816 - Key Control Deadbolt			•			6	\$74.30
<b>Key Control Deadbolt CNT</b>		3	11P	15	26D	514		
98160-012	816 SQT 15 SMT RCAL RCS RBP			•			6	\$74.30
98160-013	816 SQT 514 SMT RCAL RCS RBP					•	6	\$77.40



BUMP PROOF



PICK RESISTANT



KICK-IN RESISTANT



DRILL RESISTANT



SAW RESISTANT

### HOW TO RE-KEY YOUR LOCK IN SECONDS

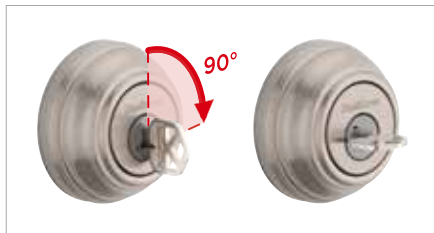

**1** Insert the key that currently operates your lock, and rotate it 90° clockwise.

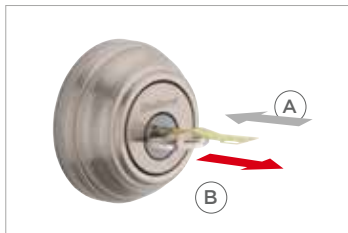

**2** (A) Insert the SmartKey tool fully and firmly into the SmartKey hole.  
(B) **Remove** the SmartKey tool and the current key.

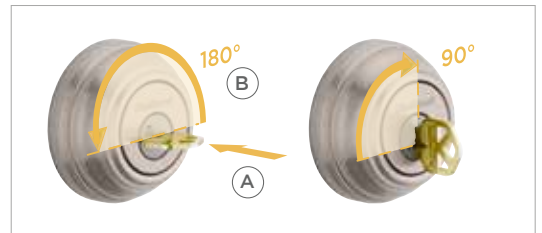



**3** (A) Fully insert your new key into the lock, and rotate it 180°.  
(B) Rotate the new key 90° back to the starting position, and remove it. Your lock is now re-keyed to your new key, and your old key will no longer operate the lock.

LEVER	EA. QTY	SKU No.	STYLE COMPATIBILITY													LIST PRICE						
			3	4	5	15	26	26D	11P	514	NO FINISH	BL	DL	DNL	HFL		LL	LRL	MIL	SAL	TNL	TPL
<b>LATCHES: 6WAY PLAIN &amp; DEADLATCH</b>																						
	1	81826	-001		-002	-004	-003															\$21.80
	1	81825	-001		-002	-004	-003															\$21.80
<b>LATCHES: 5"backset</b>																						
	1	83014	-015																			\$21.80
	5	84285									-001											\$16.80



KNOB	EA. QTY	SKU No.	STYLE COMPATIBILITY													LIST PRICE						
			3	4	5	15	26	26D	11P	514	NO FINISH	CV	J	T	P		PSK					
<b>LATCHES: 6WAY PLAIN &amp; DEAD LATCH</b>																						
	1	81826	-001		-002	-004	-003															\$21.80
	1	81825	-001		-002	-004	-003															\$21.80
<b>LATCHES: 5"backset</b>																						
	1	83014	-015																			\$21.80
	5	84285										-001										\$16.80

DEADBOLTS	EA. QTY	SKU No.	STYLE COMPATIBILITY													LIST PRICE						
			3	4	5	15	26	26D	11P	514	NO FINISH	660	665	663								
<b>LATCHES</b>																						
	1	83146	-001																			\$21.80
	1	80340										-001										\$21.80

687

KWIKSET MECHANICAL HANDLESETS Security Series		EA. QTY	SKU No.	3	4	5	15	26	26D	11P	514	NO FINISH	AMD,DA, BW, HYH	LIST PRICE
<b>Strike</b>														
	Deadbolt Square Corner Strike, 4-Hole Offset, 1-1/4" x 3-5/8"	1	83222	-026									•	\$10.80
<b>Latches</b>														
	Plain Latch 6AL	1	81826	-001		-002	-004	-003	-003				•	\$21.80















800 818





KWIKSET MECHANICAL HANDLESETS Signature Series		EA. QTY	SKU No.	3	4	5	15	26	26D	11P	514	NO FINISH	CE, AN, AT, HE, SE, AVH, ADH, SO, TVH, AUH	CMH, SCE, VNH, PTH, PGH	LIST PRICE
<b>Strike</b>															
	Deadbolt Square Corner Strike, 4-Hole Offset, 1-1/4" x 3-5/8"	1	83222	-026									•	•	\$10.80
<b>Latches</b>															
	Plain Latch 6AL	1	81826	-001		-002	-004	-003	-003				•	•	\$21.80

KWIKSET MECHANICAL KEYS		PART #	EA. QTY	SKU No.	NO FINISH	LIST PRICE
<b>Strike</b>						
	SMT Rekey Kit: 4 Silver & 2 Brass Keys, Red Plastic Learn Tool w/Instructions	5083262	1	83262	-001	\$32.80

Style Abbreviations available on page 60



KEYS, RE-KEYING KITS & MISC.		EA. QTY	SKU No.	List Price
<b>MISCELLANEOUS PARTS</b>				
	272 P&T Keying Kit	1	92720-001	\$420.80
	Knob Plug Retainer Clip	1	84345-001	\$4.80
	Spring for Control Lug Locking Bar, 100CT	1	87632-001	\$20.80
	Deadbolt Control Lug Locking Bar	1	87809-001	\$6.80
	Deadbolt Plug Retainer Clip	1	84215-001	\$4.80
	PK/Construction Balls, 100CT	1	82208-001	\$20.80
	5 Pin Spring Cover, 50CT	1	85757-001	\$40.00
	Tumbler Spring, 100CT	1	81777-001	\$20.80
	6 Pin Spring Cover	1	83561-001	\$4.80
	Cylinder Removal Tool	1	81467-003	\$8.80
	Key Gauge	1	80049-001	\$16.80
<b>P&amp;T KEYING KIT 236</b>				
	#3 Bottom Pin Silver .218", 100CT	1	83103-001	\$20.80
	#2 Bottom Pin Purple .195", 100CT	1	83101-001	\$20.80
	#1 Bottom Pin Gold .172", 100CT	1	83100-001	\$20.80
	#6 Bottom Pin Gold .287", 100CT	1	83107-001	\$20.80
	#5 Bottom Pin Red .264", 100CT	1	83106-001	\$20.80
	#4 Bottom Pin Green .241", 100CT	1	83105-001	\$20.80

KEYS, RE-KEYING KITS & MISC.		EA. QTY	SKU No.	List Price
	#6 Master Pin Gold .138", 100CT	1	83125-001	\$20.80
	#5 Master Pin Red .115", 100CT	1	83114-001	\$20.80
	#4 Master Pin Green .092", 100CT	1	83113-001	\$20.80
	#3 Master Pin Silver .069", 100CT	1	83112-001	\$20.80
	#2 Master Pin Purple .046", 100CT	1	83110-001	\$20.80
	#1 Master Pin Gold .023", 100CT	1	83108-001	\$20.80
	Regular Top Pin Gold .180", 100CT	1	81858-001	\$20.80
	PK Top Pin Red .160", 100CT	1	83117-001	\$20.80
	Plug Follower	1	80152-001	\$16.80
SMARTKEY KEYING				
	Reset Cradle SMT	1	83260-001	\$64.20

ROUND POCKET DOOR LOCK		SKU No.	3	4	5	15	26	26D	11P	514	NO FINISH	LIST PRICE
<b>Round Pocket Door Lock</b>												
	335 - Privacy	93350-024				•						\$27.20

KNOBS	
AYK	Arroyo
CV	Cove
P	Polo
PSK	Pismo
T	Tylo

KNOBS	
BL	Balboa
CSL	Casey
DL	Delta
HFL	Halifax
HYL	Henley
KAL	Katella
LRL	Ladera
MIL	Milan
PTH	Perth
SEL	Sedona
SAL	Singapore
TDL	Trafford
TPL	Tripoli
TNL	Tustin

HANDLESET	
AMD	Amador
ADH	Ashfield
AUH	Austin HS
AVH	Avalon
BW	Belleview
CE	Chelsea
DA	Dakota
HE	Hawthorne
MNH	Montara
PGH	Prague
PTH	Prescott
SCE	San Clemente
SE	Shelburne
TVH	Tavaris
VNH	Vancouver

DEADBOLT	
KCDB	Key Control