

Kwikset

A Smarter
Kind of
Simple™



BOX PACK PRICE BOOK NOVEMBER 2024



A: GENERAL INFORMATION

Terms and Conditions	1
General Information	3
Functions	5
Weights and Measurements	12
Order Forms	15

B: NEW PRODUCTS

Halo Select	16
Prava Handleset	18
Prava Lever	20
Maven Knob	22

C: KWIKSET SIGNATURE SERIES

Handlesets	27
Handleset Interior Packs	31
Sectional Interior Pack	38
Full Square Interior Packs	43
Levers	44
Knobs	52
Deadbolts	56
Specifications	61

D: KWIKSET SECURITY SERIES

Handlesets	65
Levers	66
Knobs	71
Deadbolts	74
Specifications	79

E: ELECTRONIC LOCKS

Halo	82
Aura & Smartcode	84
Home Connect	86
UNITE	88
Specifications	90

F: LIGHT COMMERCIAL

Interconnect, Push Button Levers & Key Control	96
Specifications	101

G: ACCESSORIES

Pocket Door Locks	104
-------------------	-----

H: SERVICE PARTS

Levers	108
Knobs	111
Deadbolts – Security Series	113
Deadbolts – Signature Series	117
Handlesets	120
Interconnect	124
Push Button Lever	126
Keys, Re-Keying Kits & Misc.	129
Electronic Service Parts	136
Style Abbreviations	139

TERMS AND CONDITIONS OF SALE

Standard terms are 2% prompt payment discount for payment within 25 days from date of invoice; net 30 days from the date of invoice. Kwikset® reserves the right to charge and recover on invoices which are not paid within the above terms, a service charge of 1-1/2% a month for each month or fraction thereof during which the invoice remains unpaid, said service charge, however, not to exceed the highest applicable legal rate of interest. All orders, whether solicited or written by our sales representatives or forwarded by our customers are deemed to be mere offers to purchase in accordance with these Terms and Conditions of Sale until actually accepted by us at our home office in Lake Forest, CA. We reserve the right to refuse any order as well as the right to sell or not sell to any firm at our sole discretion. The acceptance of an order is expressly made conditional upon your assent to these Terms and Conditions of Sale. We object to the inclusion of any different or additional terms or conditions, even if the same are included in your order, a contract of sale will result upon the Terms and Conditions of Sale stated herein only. Prices reflected in this book apply to Wholesale customers only.

All sales are final.

PRICES

Pricing based on full-case quantities only; orders for less than full case will be automatically adjusted up to the next full-case quantity. All prices are subject to change without notice and are not guaranteed. All taxes, duties or other charges are the responsibility of the customer.

CLAIMS

Price claims must be submitted in writing to Kwikset, 19701 Da Vinci, Lake Forest, CA 92610 within 30 days from the date of invoice.

CHANGES OR CANCELLATIONS

Beyond 5 working days of our acknowledgement date no changes can be made. Additions to an order will be handled as a separate order and must meet applicable minimum order requirements. Order cancellation on regular stock items only, or any portion thereof is allowed only upon prior written consent from Kwikset, and the payment of cancellation charges deemed appropriate.

MINIMUM CHARGE

No order will be invoiced for less than \$100.00 net plus shipping charges except for lock accessory parts.

MINIMUM ANNUAL SALES VOLUME

The company reserves the right to discontinue direct sales to any customer who does not meet the minimum annual sales volume requirement. The current annual requirement is \$50,000.00. Your annual purchases are determined by accepted, non-cancelled, and shipped orders received during each calendar year. Kwikset reserves the right to change any or all minimum annual sales volume requirements at any time. Any customer who does not meet the annual sales volume requirements may continue to purchase Kwikset products through a Kwikset distributor.

RETURNS

Defective merchandise returned to our factories requires prior written authorization from a Kwikset Sales Rep or the Sales Office. A factory return authorization must accompany the returned shipment. The return authorization must include an itemized listing of the merchandise and an explanation stating the reason for return.

There will be a 20% product restocking fee on all returned merchandise.

FREIGHT

All goods are invoiced FOB to our factory. Upon delivery of shipments to the carrier, title to, and the risk of loss or damage in transit for such shipments, passes to our customer. Kwikset's standard policy is to pay freight charges on all orders over \$1,000.00 net invoice value to a single destination in the continental U.S., by carrier and route of our choice. Shipments less than these quantities will not be shipped on a prepaid basis. If higher freight charges are incurred from customers specifying a carrier or route of their choice the additional cost will be added to that customer's invoice.

DELIVERY CONDITIONS

Shipping schedules are our best estimates, and cannot be guaranteed. Kwikset is not responsible for any direct or consequential loss or damage resulting from an inability or delay in meeting shipping schedules.

KWIKSET LIMITED WARRANTIES

Kwikset products are backed by one of the most comprehensive warranty programs available. You can feel confident that with the purchase of Kwikset you have selected the best quality product, backed by the best customer service available.

MECHANICAL LIMITED WARRANTY

Except as otherwise provided below, Spectrum Brands, Inc., for its Kwikset® brand products ("Kwikset"), warrants to the original residential purchaser (the "Purchaser") that each Kwikset product (the "Product(s)" or "Kwikset Product(s)") will be free from mechanical defects under normal use from the date of purchase for as long as said Purchaser occupies the residential premises upon which the Product was originally installed ("Warranty Period"). This Mechanical Limited Warranty applies only to Products that were purchased from Kwikset or a Kwikset authorized seller, unless otherwise prohibited by law. Kwikset Products are legitimately sold only by authorized sellers who are required to follow Kwikset's policies, procedures, and quality control standards. Kwikset reserves the right to reject warranty claims from purchasers for Products purchased from unauthorized sellers, including unauthorized Internet sites.

FINISH LIMITED WARRANTY

The finish on Kwikset Products is protected by a durable topcoat designed to maintain the beauty and quality of the Kwikset Product. Kwikset warrants to the Purchaser that the finish of the Product shall be free of defects in material and workmanship from tarnishing, flaking, and discoloring from the date of purchase for as long as said Purchaser occupies the residential premises upon which the Product was originally installed ("Warranty Period"). This Finish Limited Warranty applies only to Products that were purchased from Kwikset or a Kwikset authorized seller, unless otherwise prohibited by law. Kwikset Products are legitimately sold only by authorized sellers who are required to follow Kwikset's policies, procedures, and quality control standards. Kwikset reserves the right to reject warranty claims from purchasers for Products purchased from unauthorized sellers, including unauthorized Internet sites.

ELECTRONIC LIMITED WARRANTY

Kwikset warrants to the Purchaser that Kwikset Products will be free from electronic defects under normal use for one (1) year from the date of purchase, as long as said Purchaser occupies the residential premises upon which the Product was originally installed ("Warranty Period"). This Electronic Limited Warranty applies only to Products that were purchased from Kwikset or a Kwikset authorized seller, unless otherwise prohibited by law. Kwikset Products are legitimately sold only by authorized sellers who are required to follow Kwikset's policies, procedures, and quality control standards. Kwikset reserves the right to reject warranty claims from purchasers for Products purchased from unauthorized sellers, including unauthorized Internet sites.

EXCLUSIONS FROM WARRANTY

1. Any Kwikset Product produced prior to January 1, 2006.¹
2. Any Kwikset Product which has been damaged as a result of installation contrary to any of Kwikset's written installation instructions is not covered by these warranties.
3. Any Kwikset Product which has been modified by any non-Kwikset component is not covered by these warranties.
4. Any Kwikset Product having a defect caused by neglect, misuse, abuse or unreasonable or extraordinary use or maintenance, including use in a commercial application, is not covered by these warranties.
5. Any Kwikset Product having a defect due to use of paints, solvents, or other chemicals is not covered by these warranties.
6. Any Kwikset Product that is used in combination with knobs, levers, or trim of other than those manufactured by Kwikset and designated for use with the applicable locks or latches is not covered by these warranties.
7. Any Kwikset Product that was purchased from an unauthorized seller is not covered by these warranties.

These warranties are not transferable. Therefore, no transferee is covered by these warranties.

¹Kwikset Products produced prior to January 1, 2006, may be eligible for warranty in accordance with the terms and conditions of the applicable warranty program.

WARRANTY CLAIMS

If you wish to make a warranty claim based upon a Product defect, please call us at 1-800-327-LOCK (5625) or contact us at kwikset.com/support.

Please note that you will be required to provide a description of any claimed defect(s) and a dated receipt or other proof of purchase from Kwikset or the Kwikset authorized seller, to verify warranty eligibility.

Certain claimed defect(s) covered by these warranties may be resolved by Kwikset providing you with troubleshooting steps.

Other claimed defect(s) covered by these warranties may require Product replacement. Products may not be returned to Kwikset without prior authorization from Kwikset. If authorized by Kwikset, you will need to mail your Product to:

Spectrum Brands, Inc.

ATTN: Kwikset Consumer Services

19701 Da Vinci

Lake Forest, CA 92610

A prepaid shipping label will be provided to you.

REMEDIES

For certain claimed defect(s) covered by these warranties, as determined by Kwikset, Kwikset will provide you with troubleshooting steps.

For other claimed defect(s) covered by these warranties, as determined by Kwikset, Kwikset will replace the defective Product or part.

If a Kwikset Product, which is the same as the Kwikset Product or any part covered by these warranties, has been discontinued at the time of replacement or if Kwikset determines, in its sole discretion, that such replacement is inappropriate, Kwikset reserves the right to substitute an alternative product. Kwikset also reserves the right to accept or reject an alternative product proposed as a replacement, when the value is higher than that of the Product originally purchased by the Purchaser. Except as expressly provided in these warranties to the contrary, KWIKSET SHALL NOT BE OBLIGATED OR LIABLE FOR LABOR OR OTHER COSTS RELATED TO INSTALLATION, REPAIR OR REPLACEMENT OF A KWIKSET PRODUCT, OR FOR LOSS OF, OR DAMAGE TO ANY MATERIAL WHICH IS NOT SOLD BY KWIKSET.

PATENT INDEMNITY

We agree to defend any suit or proceeding brought against our customer so far as based on claim that our products, or any part thereof, made solely to our specifications and furnished to our customer constitute an infringement of any U.S. patent, if notified promptly in writing and given authority, information and assistance at our expense for the defense of same, and we shall pay all damages and costs awarded therein against our customer. In case our products, or any part thereof, is in such suit held to constitute infringement and their use is enjoined, we will, at our expense and discretion, either procure for our customer the right to continue using the products or replace same with non-infringing products, or modify them so they become non-infringing, or remove such products and refund the purchase price (less depreciation, prorated from the purchase date). The foregoing states our entire liability for patent infringement by our products or any part thereof.

INTELLECTUAL PROPERTY

No person or entity may sell, distribute, advertise, market or promote Kwikset branded products distributed by Kwikset Corporation ("Kwikset"), Spectrum Brands Hardware Home Improvement Division, without prior authorization from Kwikset. Customers of Kwikset who are authorized to sell Kwikset branded products are referred to herein as "Customers."

The Kwikset brand and all Kwikset trademarks, trade names, product depictions, colors, graphics or logos, whether or not registered or otherwise protected (the "Marks"), remain the sole and exclusive property of Kwikset and nothing arising out of the relationship between Kwikset and any Customer conveys to Customer any ownership rights in the Marks. Customer may use the Marks and then only in the sale or promotion of authentic Kwikset products in compliance with the terms of this policy. The Marks must be used exactly in the form provided and in conformity with all Kwikset trademark usage policies or guidelines, including, but not limited to, those relating to shape, color match and imprint quality. Any proposed deviation must be approved in writing by Kwikset prior to use. The Marks may not be used in or as part of any Customer domain name on the Internet. Prior to any use of the Marks on goods or services, Customer must submit samples for Kwikset's approval.

Additionally, no Customer may use product depictions, graphics, logos or text relating to Kwikset products that have not been provided by Kwikset in connection with the advertising, promotion or sale of Kwikset products without Kwikset's prior review and written approval of each such use. The Marks may not be used in or as part of any reseller or other third party (i) domain name or VRL on the Internet, (ii) trademark or service mark, or (iii) company or trade name. Any action on the part of a Customer that violates the terms of this policy or otherwise impairs the value of or goodwill associated with the Marks or is otherwise not in conformity with Kwikset's standards may result in the suspension or termination of the Customer's authorization or any other remedy permitted by law.

Kwikset grants to each of its Customers limited, non-transferable, non-sublicenseable licenses of the patents relating to the Kwikset products that the Customer is authorized to sell and of the copyrights in any packaging or other written materials included therewith or related thereto. Said patent and copyright licenses are solely to sell such Kwikset products covered by such patents and to which such copyrights relate only to end-users and other Customers in compliance with the terms of this document. The sale of such patented Kwikset products and the sale or use of such copyrighted materials by a Customer that violate the terms of this document exceed the scope of the licenses herein granted to the Customer and may constitute patent and/or copyright infringement.

STANDARDS

Kwikset meets or exceeds the testing requirements specified for each product grade or rating.

- American National Standards Institute (ANSI)
- Builders Hardware Manufacturers Association (BHMA)
- Underwriters Laboratories, Inc. (UL)
- Americans with Disabilities Act (ADA)

MISCELLANEOUS

Substitution of non-Kwikset components/parts, and any alteration or modification of factory parts, and other lock manufacturer's parts may result in door hardware which does not function properly or will fail and will void all warranties. Orders not specified with keying requirements will be shipped Keyed Differently (KD). Orders with keying requirements of K10 or more must have a "Letter of Release" on file with Kwikset stating that Kwikset Corporation will not be held liable for cost and expense arising from any loss or damage to property utilizing Kwikset products where 10 or more locks have been keyed alike. Contact your Sales Office account representative for a copy of the release form. Kwikset reserves the right to revise or modify products, product information, or pricing without notice. Product specifications and pricing reflect available information at the time of printing. Kwikset is not responsible for typographic or printing errors.

LIMITATION OF LIABILITIES

THERE ARE NO WARRANTIES WHICH EXTEND BEYOND THOSE STATED HEREIN. ANY IMPLIED WARRANTIES THAT MAY BE APPLICABLE TO PRODUCTS, INCLUDING IMPLIED WARRANTIES OF MERCHANTABILITY OR FITNESS FOR A PARTICULAR PURPOSE, ARE LIMITED IN DURATION TO THE DURATION OF THIS WARRANTY. SOME STATES DO NOT ALLOW LIMITATIONS ON HOW LONG AN IMPLIED WARRANTY LASTS, SO THE ABOVE LIMITATION MAY NOT APPLY TO YOU. UNDER NO CIRCUMSTANCES SHALL KWIKSET BE LIABLE FOR ANY SPECIAL, INCIDENTAL, OR CONSEQUENTIAL DAMAGES BASED UPON BREACH OF THIS LIMITED WARRANTY, BREACH OF CONTRACT, OR STRICT LIABILITY. SOME STATES DO NOT ALLOW THE EXCLUSION OR LIMITATION OF INCIDENTAL OR CONSEQUENTIAL DAMAGES, SO THE ABOVE LIMITATION OR EXCLUSION MAY NOT APPLY TO YOU. THIS WARRANTY GIVES YOU SPECIFIC LEGAL RIGHTS, AND YOU MAY ALSO HAVE OTHER RIGHTS WHICH VARY FROM STATE TO STATE.

Effective Date: [July 6th 2020]

ORDER CODE BREAKOUT

Quantity	Specifies Quantity
Function & Style	Specifies Model and Function
Rose Design	Specifies Designer Rose
Handing	Handing Right or Left
Finish	Exterior/Interior
Keying	Special Keying
Code	Keying Code
Latch	Specifies Latch
Strike	Indicates Strike
Key Alike Qty	Keyed Alike

Example: “I would like to order 12 SmartKey Halifax levers, satin nickel finish, a round rose, 6-way adjustable latch and round corner strike.

Written as: 12-740HFL RDT 15 SMT 6AL RCS.

NOTE: All handlesets ordered LIP only.

UNDERWRITERS LABORATORIES LISTED LOCKSETS



To meet Underwriters Laboratories’ fire rating requirements UL listed locksets, UL listed latches, and UL listed strikes must be used together.

AMERICAN WITH DISABILITIES ACT (ADA)



Products displaying this symbol comply with the Americans with Disabilities Act of 1990.

HOW TO ORDER 20MIN UL LOCKS

FD = 20 minute UL designation

Example: “I would like to order 12 passage Halifax levers with a round rose, 6-way adjustable latch and round corner strike with 20 minute UL in Satin Nickel”

12-720HFL RDT 15 RCALFD RCS.

KEYING

Code	Option	List Pricing Adder
KA	Keyed Alike (*SMT Only)	\$5.00
KD*	Keyed Differently	N/A
K3 or K4	Keyed Alike (2 Locksets, 3 Locksets)	N/A
MK	Master Keyed	\$15.00
PK	Builder (Protecto) Keyed	\$15.00
GMK	Grand Master Keyed	\$20.00
PMK	Builder (Protecto) Master Keyed	\$20.00
SMT	SmartKey Security	N/A

*Not every SKU is available with the KD option

BACKSET

Backset is the distance from center edge of door to center of the 2-1/8" (54mm) diameter hole, 2-3/8" or 2-3/4" in most cases.

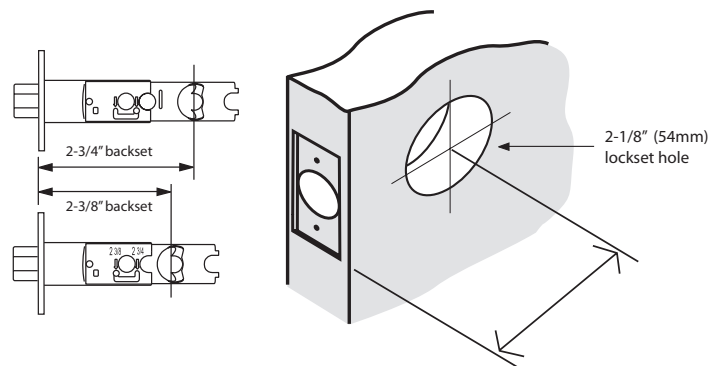

Model	Function
200/407/420/720/721/725	Passage/Hall/Closet
300/408/730/733	Privacy/Bed/Bath
334/335	Round Pocket Door Lock
400/438/740/756	Entry
405/409	Lever Keyed Entry
450/462/412/439/755/781	Storeroom/Vestibule
488/788	Half Dummy Trim, Surface Mounted
508	Interconnect
687/800/818	Single Cylinder Handleset
802/819	Dummy Handleset
898/814	Handle Only
899/815	Handle and Lever Only
599	Double Cylinder Gatelatch
158/258/660/780/782/980/982/817	Single Cylinder Deadbolts
159/665/785/985	Double Cylinder Deadbolts
912/916/620	Home Connect Deadbolt and Lever
240/250/260/270/917/955	Electronic Single Cylinder Deadbolt/Lever
942	Bluetooth Enabled Deadbolt
938/939/959	WiFi Enabled Deadbolt
966/968/971/973	Interior Pack for Handlesets

HANDING



To determine the handing of a door face the OUTSIDE of the door. If the hinge is on the left side of the door, the door is left handed (LH). If the hinge is on the right side of the door, the door is right handed (RH).

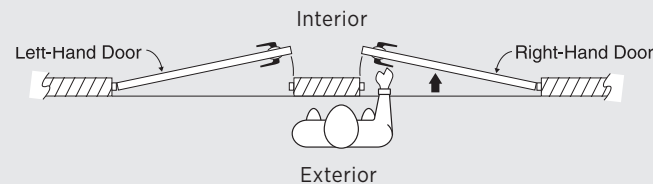

NOTE: Handing required for dummy levers and interior packs with levers when lever design is not symmetric.

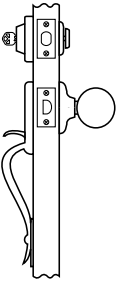
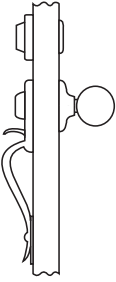

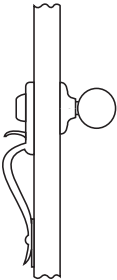

Finish	Description	ANSI/BHMA	Latch	Description
3	Polished Brass	605	RCAL	Round Corner Adjustable Latch
4	Satin Brass	---	SCAL	Square Corner Adjustable Latch
L03	Lifetime Polished Brass	605E	RFAL	Round Face Adjustable Latch
5	Antique Brass	609	RCAL FD	Round Corner Adjustable 20 Minute UL
11P	Venetian Bronze	---	6AL	6-Way Adjustable Latch. Round front staked
15	Satin Nickel	619	6AL FD	6-Way Adjustable Latch 20 Minute UL
26	Polished Chrome	625		
26D	Satin Chrome	626		
514	Matte Black	---		

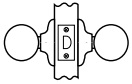
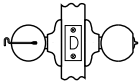
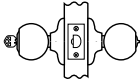
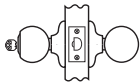
HANDLESETS	Function Name	Description	KWIKSET SECURITY SERIES w/ BHMA	KWIKSET SIGNATURE SERIES w/ BHMA
	<p>Handleset with Single Cylinder Deadbolt</p>	<p>Latch bolt operated by thumb piece outside and grip inside. Deadbolt operated by key outside and thumb turn inside.</p>	<p>687</p>	<p>800, 818</p>
	<p>Dummy Handleset with Dummy Deadbolt</p>	<p>Handle and grip act as a pull only. For inactive leaf of double doors. No operation.</p>	<p>N/A</p>	<p>802, 819</p>



HANDLESETS	Function Name	Description	KWIKSET SECURITY SERIES w/ BHMA	KWIKSET SIGNATURE SERIES w/ BHMA
	Handleset with Knob or Lever	Latch bolt operated by thumb piece outside and grip inside.	898	815
	Handleset Only	Latch bolt operated by thumb piece outside	899	814

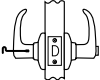
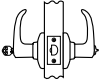
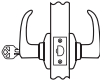

KNOBS	Function Name	Description	KWIKSET SECURITY SERIES w/ BHMA	KWIKSET SIGNATURE SERIES w/ BHMA
	Passage/Hall/Closet	Both knobs always free.	200 F75	720/725UL F75
	Privacy/Bed/Bath	Both knobs locked or unlocked by turn button inside. Outside knob unlocked by emergency key.	300 F76	730 F76
	Entry	Both knobs locked or unlocked by key outside or turn button inside.	400 F82	740/745UL F82
	Storeroom/Vestibule	Outside unlocked only while key is turned. Inside always free.	450 F86	750 F86
	Half Dummy Trim, Surface Mounted	For doors where only a pull is required. No operation.	488	788

NOTE: BHMA code in italics.

LEVERS	Function Name	Description	KWIKSET SECURITY SERIES w/ BHMA	KWIKSET SIGNATURE SERIES w/ BHMA
	Passage/Hall/Closet	Both levers always free.	200/407/420UL F75	720/725UL F75
	Privacy/Bed/Bath	Both levers locked or unlocked by turn button or push button inside. Outside lever unlocked by emergency key.	300/408ULL F76	730 F76
	Keyed Entry Lever	Both levers locked or unlocked by key outside or turn or push button inside.	405 F82	740/745/756UL F82
	Storeroom/Vestibule	Outside unlocked only while key is turned. Inside always free.	439/450/462/412UL F86	750/781 F86
	Half Dummy Trim, Surface Mounted	For doors where only a pull is required. No operation.	488	788

NOTE: BHMA code in italics.

DEADBOLTS	Function Name	Description	KWIKSET SECURITY SERIES w/ BHMA	KWIKSET SIGNATURE SERIES w/ BHMA
	Single Cylinder	Deadbolt operated by key outside and thumb turn inside.	660 E0153	980/982UL E0151 780/782UL 817UL E0152 158/258
	Double Cylinder	Deadbolt operated by key both sides.	665/E0143	985 E0141 785 E0142 159 E0152
	Thumb Turn Only	Deadbolt operated by thumb turn one side. No trim on exterior.	663 E0193	N/A

DEADBOLTS	Function Name	Description	KWIKSET SECURITY SERIES w/ BHMA	KWIKSET SIGNATURE SERIES w/ BHMA
	Conversion Kit	Converts 663 to 667 when door is bored through.	664	N/A
	Thumb Turn x Plate	Deadbolt operated by thumb turn on interior. Blank plate on exterior.	667 E01113	N/A
	Double Cylinder Gatelatch	Deadbolt operated by key outside and inside.	599	N/A

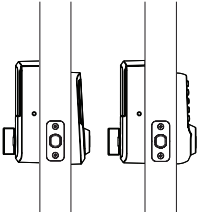
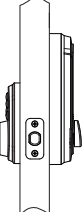
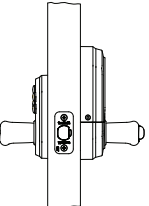

ELECTRONIC DEADBOLTS	Function Name	Description	KWIKSET SECURITY SERIES w/ BHMA	KWIKSET SIGNATURE SERIES w/ BHMA
	Halo™	Deadbolt operated by key outside, electronic keypad or WiFi enabled device.	N/A	938/939/959 E0152
	Aura™	Deadbolt operated by key outside, electronic keypad or bluetooth enabled device.	N/A	942 E0152
	SmartCode™ and HomeConnect™ Electronic Deadbolt	Deadbolt operated by key outside or electronic keypad and thumb turn inside.	N/A	240/250/260/270 620/912/916
	SmartCode™ Lever	Keyed lever operated by key outside or electronic keypad and thumb turn inside.	N/A	917/955

NOTE: BHMA code in italics

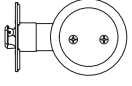
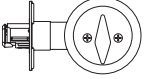
ROUND POCKET

DOOR LOCK	Function Name	Description	KWIKSET w/ BHMA	KWIKSET SIGNATURE SERIES w/ BHMA
	Passage	Pocket door lock always free.	334	N/A
	Privacy	Pocket door lock operated by thumb turn.	335	N/A

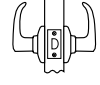
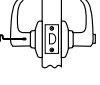
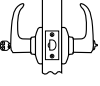
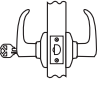
LIGHT COMMERCIAL

LEVER	Function Name	Description	LIGHT COMMERCIAL w/ BHMA
	Passage/Hall/Closet	Both levers always free.	407/721 F75
	Privacy/Bed/Bath	Both levers locked or unlocked by ADA turn button inside. Outside lever unlocked by emergency key.	408/733F76
	Entry	Both levers locked or unlocked by key outside or ADA turn button inside.	438/756 F82
	Storeroom/Vestibule	Outside unlocked only while key is turned. Inside always free.	439/781 F86
	Half Dummy Trim, Surface Mounted	For doors where only a pull is required. No operation.	788

NOTE: BHMA code in italics

METAL

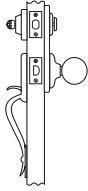
INTERCONNECT	Function Name	Description	METAL INTERCONNECT Model w/BHMA
	Plain Latch	Operated by lever either side. Deadbolt operated by key outside and thumb turn inside. Inside lever simultaneously retracts plain latch and deadbolt latch.	508

NOTE: BHMA code in italics

BOX PACK	Unit					Master Case			
	Quantity	Length (in.)	Width (in.)	Height (in.)	Weight (lbs.)	Quantity	Length (in.)	Width (in.)	Height (in.)
Kwikset Signature Series									
Deadbolts									
780 Single Cylinder	1	4.6730	3.9230	3.0720	2.2500	12	12.8750	12.5000	5.3125
785 Double Cylinder	1	4.6730	3.9230	3.0720	2.7500	12	12.8750	12.5000	5.3125
817 Key Control	1	4.6730	3.9230	3.0720	2.2500	12	12.8750	12.5000	5.3125
817 SQT Key Control Deadbolt	1	4.92	4.13	3.15	2.02	12	12.99	13.19	5.51
980 Single Cylinder	1	4.6730	3.9230	3.0720	2.2500	12	12.8750	12.5000	5.3125
985 Double Cylinder	1	4.6730	3.9230	3.0720	2.7500	12	12.8750	12.5000	5.3125
158 Single Cylinder	1	4.6730	3.9230	3.0720	2.2500	12	12.8750	12.5000	5.3125
159 Single Cylinder	1	4.6730	3.9230	3.0720	2.7500	12	12.8750	12.5000	5.3125
258 Single Cylinder	1	4.81	4.06	3.13	1.76	12	13.37	12.9	6.21
Electronic Deadbolts/Levers									
HomeConnect 620	1	9.50	4.13	4.00	3.12	1	10.23	4.33	4.53
Powerbolt 240 TRL	1	3.54	5.38	7.89	1.83	2	8.386	7.795	6.3
Powerbolt 240 CNT	1	3.54	5.38	7.89	1.83	2	8.386	7.795	6.3
Powerbolt 250 TRS	1	3.54	5.38	7.89	1.83	2	8.386	7.795	6.3
SmartCode 260 CNT	1	4.213	5.353	9.913	3.343	2	10.557	9.180	6.213
SmartCode 260 TRL	1	4.213	5.353	9.913	3.290	2	10.557	9.180	6.213
SmartCode 270 TRL	1	4.213	5.353	9.913	3.307	2	10.557	9.180	6.213
SmartCode 270 CNT	1	4.213	5.353	9.913	3.373	2	10.557	9.180	6.213
912 SmartCode Lever	1	3.5	6	10	61	2	7	12.5	10.4
SmartCode 938/939/942	1	3.5	5.38	9.88	3.14	2	10.50	7.75	5.94
SmartCode 916	1	3.896	4.188	9.667	3.391	1	10.4	4.646	4.52
959 Halo Touch	1	4.19	5.40	9.83	3.76				
Handlesets									
800 AUH Austin	1	15.9380	7.1250	4.0000	7.0000	4	16.4380	15.9380	7.8125
802 AUH Austin	1	15.9380	7.1250	4.0000	6.5000	4	16.4380	15.9380	7.8125
800AVH Avalon	1	15.9380	7.1250	4.0000	7.0000	4	16.4380	15.9380	7.8125
802AVH Avalon	1	15.9380	7.1250	4.0000	6.5000	4	16.4380	15.9380	7.8125
800AN Arlington	1	15.9380	7.1250	4.0000	7.0000	4	16.4380	15.9380	7.8125
802AN Arlington	1	15.9380	7.1250	4.0000	6.5000	4	16.4380	15.9380	7.8125
800CE Chelsea	1	15.9380	7.1250	4.0000	6.0000	4	16.4380	15.9380	16.6255
802CE Chelsea	1	15.9380	7.1250	4.0000	5.5000	4	16.4380	15.9380	16.6255
800HE Hawthorne	1	15.9380	7.1250	4.0000	7.0000	4	16.4380	15.9380	7.8125
802HE Hawthorne	1	15.9380	7.1250	4.0000	5.0000	4	16.4380	15.9380	7.8125
800 Tavaris	1	15.9380	7.1250	4.0000	8.0000	4	16.4380	16.6200	8.3800
802 Tavaris	1	15.9380	7.1250	4.0000	8.0000	4	16.4380	16.6200	8.3800
818 Prescott	1	16.143	7.293	3.75	4.281	4	16.339	15.945	7.677
818 Prague	1	16.142	7.283	3.937	4.079	4	16.142	16.142	7.874
966 Single Cylinder	1	2.7	3.7	4.30	2.25	4	15.20	12.5	7
968 Dummy	1	2.7	3.7	4.30	2.25	4	15.20	12.5	7

BOX PACK	Unit					Master Case			
	Quantity	Length (in.)	Width (in.)	Height (in.)	Weight (lbs.)	Quantity	Length (in.)	Width (in.)	Height (in.)
Kwikset Signature Series Continued									
Knobs									
720 Passage	1	8.1730	3.9230	2.7840	2.0000	12	12.3750	11.5000	8.8125
730 Privacy	1	8.1730	3.9230	2.7840	2.0000	12	12.3750	11.5000	8.8125
740 Entry	1	8.1730	3.9230	2.7840	2.3300	12	12.3750	11.5000	8.8125
788 Dummy	1	3.2360	2.7980	3.0100	0.3500	20	14.8750	12.5000	3.9375
Levers									
720 Passage	1	7.8750	6.1250	3.1875	2.4200	12	19.7500	12.8750	8.5625
730 Privacy	1	7.8750	6.1250	3.1875	2.4200	12	19.7500	12.8750	8.5625
740 Entry	1	7.8750	6.1250	3.1875	2.4200	12	19.7500	12.8750	8.5625
788 Dummy	1	5.8610	3.1100	2.8220	0.4500	20	15.8750	12.1250	6.6245
720 TNL	1	6.9	6.1	3.3	1.70	20	24.9	17.2	8.1
730 TNL	1	7.0	6.0	3.2	1.719	20	24.7	17.1	8.1
740 TNL	1	7.0	6.0	3.2	1.719	20	24.7	17.1	8.1
788 TNL	1	5.861	3.11	2.822	0.450	20	15.875	12.125	6.6245
Kwikset Security Series									
Combo Packs									
690T Tylo Knob and Single Cylinder Deadbolt	1	11.3090	3.4230	2.7840	2.8000	6	8.7500	7.3120	11.9375
Deadbolts									
Double Cylinder Gate Latch	1	4.6730	3.9230	3.0720	2.2500	12	12.8750	12.5000	5.3125
660 Single Cylinder	1	3.9480	3.4230	2.5720	0.5000	12	11.1250	11.0000	4.5625
665 Double Cylinder	1	3.9480	3.4230	2.5720	0.9000	12	11.1250	11.0000	4.5625
663 One-Sided	1	3.9480	3.4230	2.5720	0.5500	12	11.1250	11.0000	4.5625
667 One-Sided	1	3.9480	3.4230	2.5720	0.9000	12	11.1250	11.0000	4.5625
664 Retrofit Kit	1	3.9480	3.4230	2.5720	0.9000	12	11.1250	11.0000	4.5625
Handlesets									
687 LIP	1	15.9380	7.1250	4.0000	3.6000	6	15.0000	12.1250	16.6255
Knobs									
200 Polo	1	8.1730	3.2980	2.7840	1.3000	30	17.1250	17.0000	8.8125
300 Polo	1	8.1730	3.2980	2.7840	1.3000	30	17.1250	17.0000	8.8125
400 Polo	1	8.1730	3.2980	2.7840	1.3000	30	17.1250	17.0000	8.8125
200 Tylo/Cove	1	7.3610	3.2980	2.7840	1.1500	30	17.1250	17.0000	8.1870
300 Tylo/Cove	1	7.3610	3.2980	2.7840	1.1500	30	17.1250	17.0000	8.1870
400 Tylo/Cove	1	7.3610	3.2980	2.7840	1.1500	30	17.1250	17.0000	8.1870
488 Dummy	1	3.2360	2.7980	3.0100	0.3500	20	14.8750	12.5000	3.9375
Lever									
200 Passage	1	6.7980	5.7660	2.9720	1.3500	20	23.6250	15.3750	7.4995
300 Privacy	1	6.7980	5.7660	2.9720	1.3500	20	23.6250	15.3750	7.4995
405 Keyed Lever	1	6.7980	5.7660	2.9720	1.5800	20	23.6250	15.3750	7.4995
488 Dummy	1	5.8610	3.1100	2.8220	0.4500	20	15.8750	12.1250	6.6245
Miscellaneous									
Pocket Door Hardware									
334 Passage	1	4.3750	3.0000	2.0000	.65	12	12.5000	14.3750	2.2500
335 Privacy	1	4.3750	3.0000	2.0000	.8	12	12.5000	14.3750	2.2500

BOX PACK	Unit					Master Case			
	Quantity	Length (in.)	Width (in.)	Height (in.)	Weight (lbs.)	Quantity	Length (in.)	Width (in.)	Height (in.)
Kwikset Multi-Family / Light Commercial									
Carson and Palmina									
407	1	6.75	5.75	2.75	0.5	1	7.93	6.06	3.12
408	1	6.75	5.75	2.75	0.5	1	7.93	6.06	3.12
438	1	6.75	5.75	2.75	1.0	1	7.93	6.06	3.12
439	1	6.75	5.75	2.75	1.0	1	7.93	6.06	3.12
488	1	5.18	3.00	2.43	0.55	1	15.75	12.00	6.56
Kingston									
721KNL	1	6.75	5.75	2.75	1.5	1	7.93	6.06	3.12
733KNL	1	6.75	5.75	2.75	1.5	1	7.93	6.06	3.12
756KNL SMT	1	6.75	5.75	2.75	2.33	1	7.93	6.06	3.12
781KNL SMT	1	6.75	5.75	2.75	2.33	1	7.93	6.06	3.12
788 KNL	1	5.18	3.00	2.43	0.87	1	15.13	12.75	3.50



Customer Service Toll Free Line:
 (800) 422-LOCK (800) 422-5625
 FAX (866) 507-8369
 email: kworders@spectrumbands.com

Monday to Friday, 6:00 a.m. to 4:00 p.m. PST

Date: _____ Delivery Address: _____ Contact: _____
 PO Number: _____ Phone: _____ Company Name: _____
 Job Name: _____ Fax: _____ Address: _____
 Notes: _____ Store Number: _____



November 2024

Line No.	Function		Style		Handing	Rose		Finish		OPTIONS					Quantity	Price	Extended Price
	Exterior	Interior	Exterior	Interior		Exterior	Interior	Exterior	Interior	Door Thickness	Latch	Strike	Cylinder	Keying			
1																	
2																	
3																	
4																	
5																	
6																	
7																	
8																	
9																	
10																	
11																	
12																	
13																	
14																	
15																	
16																	
17																	
18																	
19																	
20																	

To order service parts, provide service part # and quantity.
 How to order questions, refer back to page A:3 for General Information.

1921423-11/24

Kwikset



HALOSELECT™

WI-FI AND MATTER ENABLED SMART LOCK

Meet the smart lock that brings convenience, intelligence and security to your front door. Control Halo Select™ from anywhere using Wi-Fi and the full-featured Kwikset® app, or easily integrate it into your favorite smart home ecosystem with a compatible Matter hub. Enjoy the freedom and flexibility of remote access, keyless entry and customizable access codes for all your family's needs.



Control and Monitor from Anywhere



Smart Home Integration



Geofence Auto-Unlock



ONE TIME
ANYTIME
WEEKLY

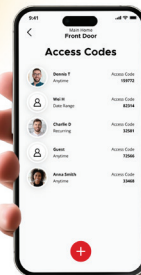

Easy Secure Guest Access

#1 SELLING U.S. LOCK BRAND*

Based on YipitData Unit Share Report, 2024

Specifications

Power	6V, 4 x AA alkaline batteries, 6-months battery life Lithium-ion battery life, 9-months battery life (Lithium-ion battery pack sold separately)
Door Prep	2 1/8" diameter cross bore hole & 1" diameter edge bore hole
Latch Backset	Adjustable 2 3/8" or 2 3/4"
Door Thickness	1 3/4" standard Service part available for 2 3/4" thick doors.
Faceplates	1" x 2 1/4" round corner faceplate standard (For Kwikset)
Strikes	1 1/8" x 2 3/4" x round corner/square corner 4-hole strike
Bolt	1" throw, steel deadbolt
Door Handing	Reversible for right or left-hand doors
Cylinder	SmartKey Security™ KW1 cylinder
UL Rated	20 min UL fire rating
Security	Deadbolt: A156.40 Grade AAA Certified
Temperature Range	Exterior: -40F to 150F, Interior: 32F to 130F
Humidity	Exterior: 100% condensing, Interior: 30% to 95% non-condensing
Warranty	Lifetime Limited Mechanical and Finish Warranty. One Year Limited Electronics Warranty

Innovative Security

- 250 customizable access codes with optional schedules
- BHMA Grade AAA certified
- 20 Minute fire rating - UL certified
- Full 128-bit encryption security
- Featuring SmartKey Security™ - protecting against advanced break-in techniques
- SecureScreen™ - patented security feature prevents on-screen fingerprint user code identification

Easy Installation

- No hub required by connecting directly to your home Wi-Fi network
- Operates on (4) AA batteries
- Installs in minutes using a screwdriver
- In app interactive install guide

Warranty

- Lifetime mechanical and finish warranty
- 1 year electronic warranty

Dimensions

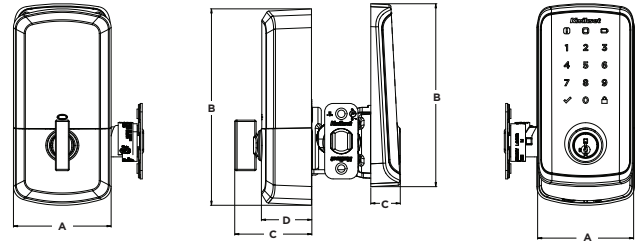

Touchscreen	A	B	C	D
Interior	2 29/32"	5 27/32"	2 9/32"	1 1/2"
Exterior	2 27/32"	5 7/16"	7/8"	---



Wi-Fi and Kwikset App

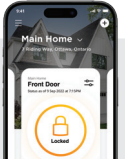

Remote Lock and Unlock



Guest Access Codes



Geofence Auto-Unlock



Door Status Sensor



Smart Home Voice Control



Intrusion Detection



Matter and Smart Home App

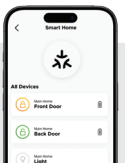

Smart Home Integration



Simple Setup



Remote Lock and Unlock



Improved Battery Life

Finishes



Satin Nickel¹⁵
998000-001

Matte Black⁵¹⁴
998000-002



Visit Kwikset.com/matter for the most up-to-date information

The logo features the brand name 'Kwikset' in a bold, white, sans-serif font, set against a red rectangular background. Below the name, the words 'SIGNATURE SERIES' are written in a smaller, white, sans-serif font on a black horizontal bar.

SIGNATURE SERIES



PRAVA HANDLESET

Prava™ handleset merges alluring aesthetics and trusted functionality. With intricate, decorative knurling, you can feel the Kwikset® difference on each statement piece. Experience tactile luxury, contemporary style and elevated craftsmanship on every door.

- Handle features diamond knurling
- Features New Advanced SmartKey Security™
- Low Profile Contemporary Design
- Handleset Deadbolt has ANSI/BHMA Grade AAA Certified Security
- Lifetime Mechanical and Finish Warranty
- Compatible with 971 interior packs for 818 & 814 series handlesets and 973 dummy interior packs for 819 series handlesets



#1 SELLING U.S. LOCK BRAND*

Numerator TruView, Unit Share Report, 2024

Specifications

Door Prep	Cross Bore 2 1/8". Edge Bore 1" Latch Face 1" x 2 1/4"
Backset	Adjustable 2 3/8" or 2 3/4"
Door Thickness	1 3/4" Standard. Thick door service part available for up to 2 1/4"
Faceplates	1" x 2 1/4" includes round corner, square corner and drive-in
Strikes	Deadbolt: 1 1/8" x 2 3/4". square, round corner & 2 1/4" full lip round corner Handle: 2 1/4" round corner full lip (Other options available)
Bolt	Deadbolt: 1" throw Handle: 1/2" throw
Cylinder	SmartKey Security™
Door Handing	Reversible for right or left-hand doors
ANSI/BHMA	Deadbolt is A156.39 Grade AAA Certified
UL	N/A
ADA	N/A
Warranty	Lifetime mechanical and lifetime finish

Dimensions

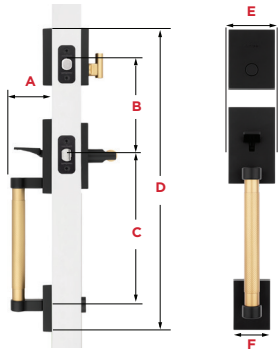

Dimensions	A	B	C	D	E	F
Prava	2 21/32"	5 1/2"	8 13/32" through 9 11/16"	17 15/16"	2 25/32"	2 3/16"

Finishes



Satin Brass 4



Satin Nickel 15



Matte Black 514



Matte Black with Satin Brass 514/4

Adjustable Throughbolt

Vertical and horizontal slide designed for a guaranteed fit

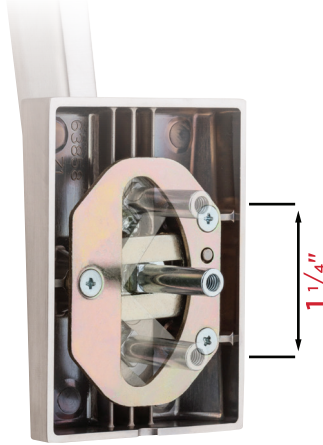

Functions



Handleset (Single-Cylinder): Exterior only, Latch bolt operated by thumb piece outside. Deadbolt operated by key outside.
- 818 PVH SMT



Handleset (Dummy): Exterior only, Handle acts as pull only. For inactive leaf or double doors. No Operation.
- 819 PVH



Handle Only: Handle only. Latch bolt operated by thumb piece outside.
- 814 PVH

Interior Pack (Single-Cylinder): Interior only, Latch bolt operated by lever inside. Deadbolt operated by thumb turn inside.
- 971____
(Indicate interior lever style)

Interior Pack (Dummy): Interior only, Lever acts as a pull only. For inactive leaf or double doors. No operation.
- 973____
(Indicate interior lever style)

No Double-Cylinder Function Available

Kwikset
SIGNATURE SERIES



PRAVA LEVER

Prava™ lever merges alluring aesthetics and trusted functionality. With intricate, decorative knurling, you can feel the Kwikset® difference on each statement piece. Experience tactile luxury, contemporary style and elevated craftsmanship on every door.

- Features New Advanced SmartKey Security* Technology
- ANSI/BHMA Grade AAA Highest Residential Security/Durability/Finish
- Handle Features Diamond Knurling

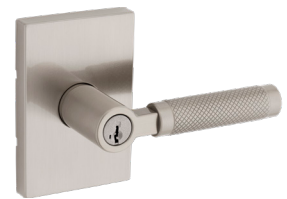

Prava Lever with SmartKey Security
in Satin Nickel

#1 SELLING U.S. LOCK BRAND*

Numerator TruView, Unit Share Report, 2024

Specifications

Door Prep	Cross Bore 2-1/8". Edge Bore 1"
Backset	Adjustable 2 3/8" or 2 3/4"
Door Thickness	1 3/8" - 1 3/4" Doors standard Thick Door Kit Available for 720 & 740 functions
Cylinder	SmartKey Security™
Faceplates	1" x 2 1/4" includes round corner, square corner and drive-in
Strikes	Includes 2 1/4" full lip round corner, other options available
Bolt	1/2" Throw
Door Handing	Reversible for right- or left-hand doors.
ANSI/BHMA	A156.30 Grade AAA certified
ADA	720 & 730 functions are in compliance with the American National Standards Institute (ANSI A117.1)
UL	N/A
Warranty	Lifetime Mechanical and Lifetime Finish

Dimensions

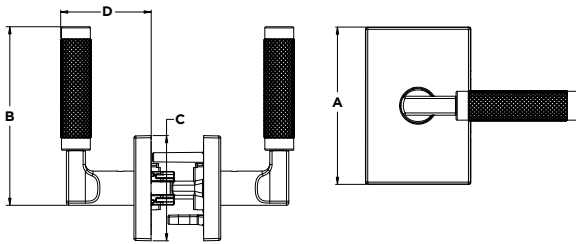

Design	A	B	B (Keyed)
Prava	4 1/8"	4 11/16"	4 25/32 "
	C	D	D (Keyed)
	2 25/32 "	2 3/8"	2 13/32 "

Finishes



Satin
Brass 4



Satin
Nickel 15



Matte
Black 514



Matte Black with
Satin Brass 514/4

LIFETIME
WARRANTY

Functions



Passage/Hall/Closet: Both levers
always free. - 720PVL



Privacy/Bed/Bath: Both levers locked
or unlocked by push-button inside.
Outside lever unlocked by emergency
key. - 730PVL



Keyed Entry Lever: Both sides locked
or unlocked by key outside or turn-
button inside. - 740PVL



Half Dummy Trim, Surface Mounted:
For doors where only a pull is required.
No operation. - 788PVL



Interior Pack: Inside lever of handleset.
818/819 : Handlesets
- 971PVL : Single-Cylinder
- 973PVL : Dummy



One Key For All Your Locks

Protects against
advanced break-in
techniques and allows
you to re-key your lock
yourPVLf in seconds.

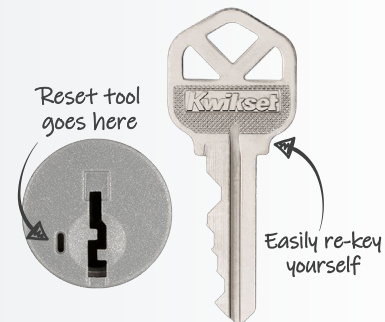

Kwikset
— Security Series



MAVEN KNOB

Maven™ door knobs give a unique, stylish touch to each room of your home. The modern square profile and textured perimeter create an elevated look that's still budget friendly. Choose round or square rosettes to make your space uniquely yours, and enjoy trusted Kwikset® quality with every turn.

- Featuring SmartKey Security™
- ANSI/BHMA Grade 3 Certified
- Easy to Install
- Available with Square or Round Rose



Maven Entry Knob with round rose
In Matte Black



Maven Entry Knob with square rose
In Matte Black

#1 SELLING U.S. LOCK BRAND*

*Source: TraQline US quarterly brand unit share report, Q4 2006 through Q1 2021

Specifications

Functions

Door Prep	Cross Bore 2 1/8" Edge Bore 1" Latch Face 1 x 2 1/4"
Backset	Adjustable 2 3/8" or 2 3/4"
Door Thickness	1 3/8" - 1 3/4" Doors standard.
Cylinder	SmartKey Security™
Faceplates	1" x 2 1/4" includes round corner, square corner and drive-in
Strikes	2 1/4" Full lip. Includes round corner, other options available.
Bolt	1/2" Throw
Door Handing	Reversible for right or left-hand doors
ANSI/BHMA	A156.2 Grade 3
UL	N/A
ADA	N/A
Rose	Specify round (RDT) or square (SQT)
Warranty	Lifetime Mechanical and Lifetime Finish



Passage/Hall/Closet: Both knobs always free.
- 200 MNK



Privacy/Bed/Bath: Both knobs locked or unlocked by turn-button inside. Outside knob unlocked by emergency key.
- 300 MNK



Keyed Entry: Both sides locked or unlocked by key outside or turn-button inside.
- 400 MNK



Half Dummy Trim, Surface Mounted: For doors where only a pull is required. No operation.
- 488 MNK



Interior Pack: Inside knob & thumb turn of handleset
687/800 Handlesets:
-966 MNK: Single-Cylinder



Dimensions

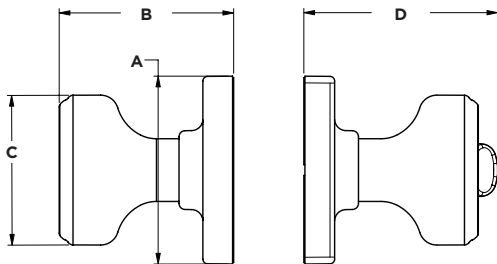

Maven	A	B	C	D (Entry)
RDT	2 5/8"	2 7/16"	2 3/32"	2 23/32"
SQT	2 5/8"	2 7/16"	2 3/32"	2 23/32"

Finishes



Matte Black 514



Satin Nickel 15



Polished Chrome 26



One Key For All Your Locks

Protects against advanced break-in techniques and allows you to re-key your lock yourself in seconds.

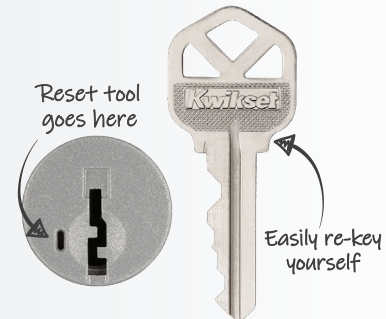

LIFETIME WARRANTY



Superior Security Features

- ANSI/BHMA Grade 1 Certified 980/985/258 Deadbolts and 800/818 handlesets
- SmartKey Security - providing superior security against advanced break-in techniques.

Elegant Styles And Finishes

- Traditional to Contemporary Styles

Warranty

- Lifetime Mechanical
- Lifetime Finish



Arlington®



Austin™



Avalon™



Chelsea®



Hawthorne



Uptown 258
Deadbolt



Downtown 258
Deadbolt



Midtown 258
Deadbolt



Halifax
158/159
Deadbolt



San Clemente
Rectangular
Deadbolt



780/785
Deadbolt



Milan
158/159
Deadbolt



980/985
Deadbolt



Prague



Prescott



Prava



San
Clemente



Tavaris®



Vancouver

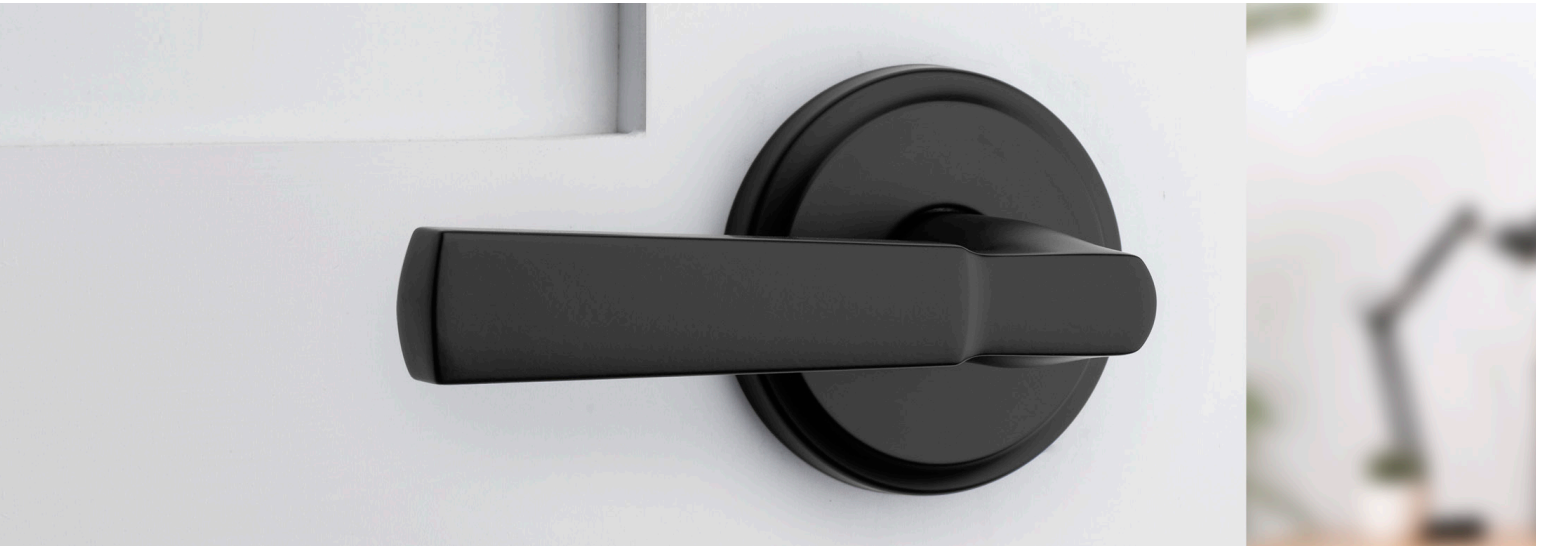

| **Abbey***



| **Arroyo**



| **Hancock***



| **Laurel***



| **Pismo**



| **Halifax***



| **Halifax***
San Clemente Trim



| **Katella**



| **Lisbon**



| **Milan***



| **Perth**



| **Prava**



| **Sedona**



| **Singapore**



| **Trafford**



| **Tripoli**



| **Tustin***



Arlington

MFG Pro #	Item Description	Function	3	L03	5	11P	15	26	26D	514	List Price	QTY
98001-404	800AN LIP 11P SMT 6AL STRKP	Single Cyl				•					\$257.00	4
98001-405	800AN LIP 15 SMT 6AL STRKP	Single Cyl					•				\$257.00	4
98001-408	800AN LIP L03 SMT 6AL STRKP	Single Cyl		•							\$257.00	4
98020-203	802AN LIP 11P	Dummy				•					\$211.00	4
98020-204	802AN LIP 15	Dummy					•				\$211.00	4
98020-205	802AN LIP L03	Dummy		•							\$211.00	4
98140-011	814AN 11P 6AL RCS	Grip Only†				•					\$167.90	4
98140-012	814AN 15 6AL RCS	Grip Only†					•				\$167.90	4
98140-013	814AN L03 6AL RCS	Grip Only†		•							\$167.90	4
98150-025	815ANXH 11P 6AL RCS	Grip Only†				•					\$234.70	6
98150-026	815ANXH 15 6AL RCS	Grip Only†					•				\$234.70	6
98150-027	815ANXH L03 6AL RCS	Grip Only†		•							\$234.70	6
98150-028	815ANXTNL LH 11P 6AL RCS	Grip Only†				•					\$247.30	6
98150-029	815ANXTNL LH 15 6AL RCS	Grip Only†					•				\$247.30	6
98150-030	815ANXTNL RH 11P 6AL RCS	Grip Only†				•					\$247.30	6
98150-031	815ANXTNL RH 15 6AL RCS	Grip Only†					•				\$247.30	6



Avalon

MFG Pro #	Item Description	Function	3	L03	5	11P	15	26	26D	514	List Price	QTY
98001-402	800AUH LIP 11P SMT 6AL STRKP	Single Cyl				•					\$330.00	4
98001-409	800AUH LIP 15 SMT 6AL STRKP	Single Cyl					•				\$330.00	4
98020-206	802AUH LIP 11P	Dummy				•					\$280.20	4
98020-207	802AUH LIP 15	Dummy					•				\$280.20	4
98140-014	814AUH 11P 6AL RCS	Grip Only†				•					\$237.10	4
98140-015	814AUH 15 6AL RCS	Grip Only†					•				\$237.10	4



Avalon

MFG Pro #	Item Description	Function	3	L03	5	11P	15	26	26D	514	List Price	QTY
98001-411	800AVH LIP 11P SMT 6AL STRKP	Single Cyl				•					\$330.00	4
98001-403	800AVH LIP 15 SMT 6AL STRKP	Single Cyl					•				\$330.00	4
98001-410	800AVH LIP 514 SMT 6AL STRKP	Single Cyl								•	\$341.00	4
98020-208	802AVH LIP 11P	Dummy				•					\$280.20	4
98020-209	802AVH LIP 15	Dummy					•				\$280.20	4
98020-210	802AVH LIP 514	Dummy								•	\$291.50	4
98140-016	814AVH 11P 6AL RCS	Grip Only†				•					\$237.10	4
98140-017	814AVH 15 6AL RCS	Grip Only†					•				\$237.10	4
98140-018	814AVH 514 6AL RCS	Grip Only†								•	\$248.10	4

NOTE: Handlesets ordered LIP only
 †Denotes handleset without deadbolt



Chelsea

MFG Pro #	Item Description	Function	3	L03	5	11P	15	26	26D	514	List Price	QTY
98001-406	800CE LIP 11P SMT 6AL STRKP	Single Cyl				•					\$257.00	4
98001-407	800CE LIP 15 SMT 6AL STRKP	Single Cyl					•				\$257.00	4
98001-412	800CE LIP 26 SMT 6AL STRKP	Single Cyl						•			\$257.00	4
98001-413	800CE LIP L03 SMT 6AL STRKP	Single Cyl		•							\$257.00	4
98020-211	802CE LIP 11P	Dummy				•					\$211.00	4
98020-212	802CE LIP 15	Dummy					•				\$211.00	4
98020-213	802CE LIP 26	Dummy						•			\$211.00	4
98020-214	802CE LIP L03	Dummy		•							\$211.00	4
98140-019	814CE 15 6AL RCS	Grip Only†					•				\$167.90	4
98150-032	815CEXH 15 6AL RCS	Grip Only†					•				\$234.70	6



Hawthorne

MFG Pro #	Item Description	Function	3	L03	5	11P	15	26	26D	514	List Price	QTY
98001-398	800HE LIP 11P SMT 6AL STRKP	Single Cyl				•					\$311.00	4
98001-397	800HE LIP 15 SMT 6AL STRKP	Single Cyl					•				\$311.00	4
98001-399	800HE LIP 514 SMT 6AL STRKP	Single Cyl								•	\$322.00	4
98020-215	802HE LIP 11P	Dummy				•					\$262.00	4
98020-216	802HE LIP 15	Dummy					•				\$262.00	4
98020-217	802HE LIP 514	Dummy								•	\$273.30	4
98140-020	814HE 11P 6AL RCS	Grip Only†				•					\$218.90	4
98140-010	814HE 15 6AL RCS	Grip Only†					•				\$218.90	4
98140-021	814HE 514 6AL RCS	Grip Only†								•	\$229.90	4



Prague

MFG Pro #	Item Description	Function	3	L03	5	11P	15	26	26D	514	List Price	QTY
98140-022	814PGH 11P 6AL RCS	Grip Only†				•					\$250.70	4
98140-023	814PGH 15 6AL RCS	Grip Only†					•				\$250.70	4
98140-024	814PGH 26 6AL RCS	Grip Only†						•			\$250.70	4
98140-025	814PGH 514 6AL RCS	Grip Only†								•	\$262.00	4
98180-032	818PGH LIP 11P SMT 6AL STRKP	Single Cyl				•					\$327.80	4
98180-027	818PGH LIP 15 SMT 6AL STRKP	Single Cyl					•				\$327.80	4
98180-028	818PGH LIP 26 SMT 6AL STRKP	Single Cyl						•			\$327.80	4
98180-029	818PGH LIP 514 SMT 6AL STRKP	Single Cyl								•	\$339.10	4
98190-009	819PGH LIP 11P	Dummy				•					\$293.80	4
98190-010	819PGH LIP 15	Dummy					•				\$293.80	4
98190-011	819PGH LIP 26	Dummy						•			\$293.80	4
98190-012	819PGH LIP 514	Dummy								•	\$305.10	4

NOTE: Handlesets ordered LIP only
 †Denotes handleset without deadbolt



Prava

MFG Pro #	Item Description	Function	3	L03	5	11P	15	26	26D	514	List Price	QTY
98140-039	814PVH LIP 15 6AL RCS	Grip Only					•				\$270.70	4
98140-038	814PVH LIP 514 6AL RCS	Grip Only								•	\$282.00	4
98180-044	818PVH LIP 15 SMT 6AL STRKP	Handleset					•				\$347.80	4
98180-045	818PVH LIP 4 SMT 6AL STRKP	Handleset		•							\$359.10	4
98180-043	818PVH LIP 514 SMT 6AL STRKP	Handleset								•	\$359.10	4
98180-046	818PVH LIP 514/4 SMT 6AL STRKP	Handleset		•						•	\$359.10	4
98190-025	819PVH LIP 15	Dummy Handleset					•				\$313.80	4
98190-026	819PVH LIP 4	Dummy Handleset		•							\$325.10	4
98190-024	819PVH LIP 514	Dummy Handleset								•	\$325.10	4
98190-027	819PVH LIP 514/4	Dummy Handleset		•						•	\$325.10	4



Prescott

MFG Pro #	Item Description	Function	3	L03	5	11P	15	26	26D	514	List Price	QTY
98140-026	814PTH 11P 6AL RCS	Grip Only				•					\$218.90	4
98140-027	814PTH 15 6AL RCS	Grip Only					•				\$218.90	4
98140-028	814PTH 514 6AL RCS	Grip Only								•	\$230.20	4
98140-029	814PTH L03 6AL RCS	Grip Only		•							\$218.90	4
98150-033	815PTHXH 11P 6AL RCS	Grip Only				•					\$285.70	4
98150-034	815PTHXH 15 6AL RCS	Grip Only					•				\$285.70	4
98150-035	815PTHXH L03 6AL RCS	Grip Only		•							\$285.70	4
98150-036	815PTHXTNL LH 11P 6AL RCS	Grip Only				•					\$298.30	4
98150-037	815PTHXTNL LH 15 6AL RCS	Grip Only					•				\$298.30	4
98150-038	815PTHXTNL LH L03 6AL RCS	Grip Only		•							\$298.30	4
98150-039	815PTHXTNL RH 11P 6AL RCS	Grip Only				•					\$298.30	4
98150-040	815PTHXTNL RH 15 6AL RCS	Grip Only					•				\$298.30	4
98150-041	815PTHXTNL RH L03 6AL RCS	Grip Only		•							\$298.30	4
98180-024	818PTH LIP 11P SMT 6AL STRKP	Single Cyl				•					\$296.00	4
98180-023	818PTH LIP 15 SMT 6AL STRKP	Single Cyl					•				\$296.00	4
98180-033	818PTH LIP 514 SMT 6AL STRKP	Single Cyl								•	\$307.30	4
98180-034	818PTH LIP L03 SMT 6AL STRKP	Single Cyl		•							\$296.00	4
98190-013	819PTH LIP 11P	Dummy				•					\$262.00	4
98190-014	819PTH LIP 15	Dummy					•				\$262.00	4
98190-015	819PTH LIP 514	Dummy								•	\$273.30	4
98190-016	819PTH LIP L03	Dummy		•							\$262.00	4



San Clemente

MFG Pro #	Item Description	Function	3	L03	5	11P	15	26	26D	514	List Price	QTY
98140-030	814SCE 11P 6AL RCS	Grip Only				•					\$250.70	4
98140-031	814SCE 15 6AL RCS	Grip Only					•				\$250.70	4
98140-032	814SCE 26 6AL RCS	Grip Only						•			\$250.70	4
98140-033	814SCE 514 6AL RCS	Grip Only								•	\$262.00	4
98150-042	815SCEXHFL SQT 11P 6AL RCS	Grip Only				•					\$330.10	4
98150-043	815SCEXHFL SQT 15 6AL RCS	Grip Only					•				\$330.10	4
98150-044	815SCEXHFL SQT 26 6AL RCS	Grip Only						•			\$330.10	4
98150-045	815SCEXHFL SQT 514 6AL RCS	Grip Only								•	\$341.40	4

NOTE: Handlesets ordered LIP only
 †Denotes handleset without deadbolt

98180-004	818SCE LIP 11P SMT 6AL STRKP	Single Cyl					•						\$327.80	4
98180-005	818SCE LIP 15 SMT 6AL STRKP	Single Cyl						•					\$327.80	4
98180-006	818SCE LIP 26 SMT 6AL STRKP	Single Cyl							•				\$327.80	4
98180-035	818SCE LIP 26D SMT 6AL STRKP	Single Cyl								•			\$327.80	4
98180-036	818SCE LIP 4 SMT 6AL STRKP	Single Cyl											\$339.10	4
98180-007	818SCE LIP 514 SMT 6AL STRKP	Single Cyl									•		\$339.10	4
98190-017	819SCE LIP 11P	Dummy					•						\$293.80	4
98190-018	819SCE LIP 15	Dummy						•					\$293.80	4
98190-019	819SCE LIP 26	Dummy							•				\$293.80	4
98190-020	819SCE LIP 26D	Dummy								•			\$293.80	4
98190-022	819SCE LIP 4	Dummy											\$305.10	4
98190-021	819SCE LIP 514	Dummy									•		\$305.10	4

Tavaris



MFG Pro #	Item Description	Function	3	L03	5	11P	15	26	26D	514	List Price	QTY
98001-418	800TVH LIP 11P SMT 6AL STRKP	Single Cyl				•					\$311.00	4
98001-396	800TVH LIP 15 SMT 6AL STRKP	Single Cyl					•				\$311.00	4
98001-416	800TVH LIP 26 SMT 6AL STRKP	Single Cyl						•			\$311.00	4
98001-419	800TVH LIP 26D SMT 6AL STRKP	Single Cyl							•		\$311.00	4
98001-417	800TVH LIP 514 SMT 6AL STRKP	Single Cyl								•	\$322.00	4
98001-428	800TVH LIP 15 6AL STRKP	Single Cyl					•				\$311.00	4
98001-429	800TVH LIP 514 6AL STRKP	Single Cyl								•	\$322.00	4
98020-218	802TVH LIP 11P	Dummy				•					\$262.00	4
98020-219	802TVH LIP 15	Dummy					•				\$262.00	4
98020-220	802TVH LIP 26	Dummy						•			\$262.00	4
98020-221	802TVH LIP 26D	Dummy							•		\$262.00	4
98020-222	802TVH LIP 514	Dummy								•	\$273.30	4
98140-034	814TVH 11P 6AL RCS	Grip Only				•					\$218.90	4
98140-035	814TVH 15 6AL RCS	Grip Only					•				\$218.90	4
98140-036	814TVH 26 6AL RCS	Grip Only						•			\$218.90	4
98140-037	814TVH 514 6AL RCS	Grip Only								•	\$230.20	4

Vancouver



MFG Pro #	Item Description	Function	3	L03	5	11P	15	26	26D	514	List Price	QTY
98180-017	818VNH LIP 11P SMT 6AL STRKP	Single Cyl				•					\$340.20	4
98180-016	818VNH LIP 15 SMT 6AL STRKP	Single Cyl					•				\$340.20	4
98180-018	818VNH LIP 26 SMT 6AL STRKP	Single Cyl						•			\$340.20	4
98180-019	818VNH LIP 514 SMT 6AL STRKP	Single Cyl								•	\$351.50	4
98190-006	819VNH LIP 11P	Dummy				•					\$306.20	4
98190-005	819VNH LIP 15	Dummy					•				\$306.20	4
98190-007	819VNH LIP 26	Dummy						•			\$306.20	4
98190-008	819VNH LIP 514	Dummy								•	\$317.50	4

NOTE: Handlesets ordered LIP only
 †Denotes handleset without deadbolt

Aliso



MFG Pro #	Item Description	Function	3	L03	5	11P	15	26	26D	514	List Price	QTY
99660-209	966AO 15 UNIV	Single Cyl Interior Pack					•				\$59.00	4

Balboa



MFG Pro #	Item Description	Function	3	L03	5	11P	15	26	26D	514	List Price	QTY
99660-223	966BL LH 11P UNIV	Single Cyl Interior Pack				•					\$72.90	4
99660-224	966BL LH 15 UNIV	Single Cyl Interior Pack					•				\$72.90	4
99660-225	966BL LH 26 UNIV	Single Cyl Interior Pack						•			\$72.90	4
99660-226	966BL LH 26D UNIV	Single Cyl Interior Pack							•		\$72.90	4
99660-227	966BL LH 514 UNIV	Single Cyl Interior Pack								•	\$72.90	4
99660-228	966BL RH 11P UNIV	Single Cyl Interior Pack				•					\$72.90	4
99660-229	966BL RH 15 UNIV	Single Cyl Interior Pack					•				\$72.90	4
99660-230	966BL RH 26 UNIV	Single Cyl Interior Pack						•			\$72.90	4
99660-231	966BL RH 26D UNIV	Single Cyl Interior Pack							•		\$72.90	4
99660-232	966BL RH 514 UNIV	Single Cyl Interior Pack								•	\$72.90	4

Breton RDT



MFG Pro #	Item Description	Function	3	L03	5	11P	15	26	26D	514	List Price	QTY
99660-236	966BRNL RDT 15 UNIV	Single Cyl Interior Pack					•				\$72.90	4
99660-237	966BRNL RDT 26 UNIV	Single Cyl Interior Pack						•			\$72.90	4
99660-238	966BRNL RDT 514 UNIV	Single Cyl Interior Pack								•	\$72.90	12

Breton SQT



MFG Pro #	Item Description	Function	3	L03	5	11P	15	26	26D	514	List Price	QTY
99660-233	966BRNL SQT 15 UNIV	Single Cyl Interior Pack					•				\$72.90	4
99660-234	966BRNL SQT 26 UNIV	Single Cyl Interior Pack						•			\$72.90	4
99660-235	966BRNL SQT 514 UNIV	Single Cyl Interior Pack								•	\$72.90	4

Casey RDT



MFG Pro #	Item Description	Function	3	L03	5	11P	15	26	26D	514	List Price	QTY
99660-242	966CSL RDT 15 UNIV	Single Cyl Interior Pack					•				\$72.90	4
99660-243	966CSL RDT 26 UNIV	Single Cyl Interior Pack						•			\$72.90	4
99660-244	966CSL RDT 514 UNIV	Single Cyl Interior Pack								•	\$72.90	4

Casey SQT



MFG Pro #	Item Description	Function	3	L03	5	11P	15	26	26D	514	List Price	QTY
99660-239	966CSL SQT 15 UNIV	Single Cyl Interior Pack					•				\$72.90	4
99660-240	966CSL SQT 26 UNIV	Single Cyl Interior Pack						•			\$72.90	4
99660-241	966CSL SQT 514 UNIV	Single Cyl Interior Pack								•	\$72.90	4



Cove

MFG Pro #	Item Description	Function	3	L03	5	11P	15	26	26D	514	List Price	QTY
99660-210	966CV 11P UNIV	Single Cyl Interior Pack				•					\$59.00	4
99660-211	966CV 15 UNIV	Single Cyl Interior Pack					•				\$59.00	4
99660-212	966CV 514 UNIV	Single Cyl Interior Pack								•	\$59.00	4



Delta

MFG Pro #	Item Description	Function	3	L03	5	11P	15	26	26D	514	List Price	QTY
99660-246	966DL 11P UNIV	Single Cyl Interior Pack				•					\$72.90	4
99660-247	966DL 15 UNIV	Single Cyl Interior Pack					•				\$72.90	4
99660-248	966DL 26 UNIV	Single Cyl Interior Pack						•			\$72.90	4
99660-249	966DL 26D UNIV	Single Cyl Interior Pack							•		\$72.90	4



Dorian

MFG Pro #	Item Description	Function	3	L03	5	11P	15	26	26D	514	List Price	QTY
99660-251	966DNL 11P UNIV	Single Cyl Interior Pack				•					\$72.90	4
99660-252	966DNL 15 UNIV	Single Cyl Interior Pack					•				\$72.90	4



Halifax RDT

MFG Pro #	Item Description	Function	3	L03	5	11P	15	26	26D	514	List Price	QTY
99660-323	966HFL RDT 11P V1 UNIV	Single Cyl Interior Pack				•					\$81.00	4
99660-319	966HFL RDT 15 V1 UNIV	Single Cyl Interior Pack					•				\$81.00	4
99660-320	966HFL RDT 26 V1 UNIV	Single Cyl Interior Pack						•			\$81.00	4
99660-322	966HFL RDT 26D V1 UNIV	Single Cyl Interior Pack							•		\$81.00	4
99660-321	966HFL RDT 514 V1 UNIV	Single Cyl Interior Pack								•	\$81.00	4
99680-065	968HFL RDT 11P	Dummy Interior Pack				•					\$67.20	4
99680-066	968HFL RDT 15	Dummy Interior Pack					•				\$67.20	4
99680-067	968HFL RDT 26	Dummy Interior Pack						•			\$67.20	4
99680-068	968HFL RDT 26D	Dummy Interior Pack							•		\$67.20	4
99680-069	968HFL RDT 514	Dummy Interior Pack								•	\$67.20	4



Halifax SQT

MFG Pro #	Item Description	Function	3	L03	5	11P	15	26	26D	514	List Price	QTY
99660-343	966HFL SQT 11P V2 UNIV	Single Cyl Interior Pack				•					\$81.00	4
99660-182	966HFL SQT 15 V1 UNIV	Single Cyl Interior Pack					•				\$81.00	4
99660-342	966HFL SQT 26 V2 UNIV	Single Cyl Interior Pack						•			\$81.00	4
99660-324	966HFL SQT 26D V1 UNIV	Single Cyl Interior Pack							•		\$81.00	4
99660-192	966HFL SQT 514 V1 UNIV	Single Cyl Interior Pack								•	\$81.00	4
99680-070	968HFL SQT 11P	Dummy Interior Pack				•					\$67.20	4
99680-071	968HFL SQT 15	Dummy Interior Pack					•				\$67.20	4
99680-072	968HFL SQT 26	Dummy Interior Pack						•			\$67.20	4
99680-073	968HFL SQT 26D	Dummy Interior Pack							•		\$67.20	4
99680-074	968HFL SQT 514	Dummy Interior Pack								•	\$67.20	4



Hancock

MFG Pro #	Item Description	Function	3	L03	5	11P	15	26	26D	514	List Price	QTY
99660-301	966H 11P V1 UNIV	Single Cyl Interior Pack				•					\$67.20	4
99660-299	966H 15 V1 UNIV	Single Cyl Interior Pack					•				\$67.20	4
99660-300	966H 26 V1 UNIV	Single Cyl Interior Pack						•			\$67.20	4
99660-302	966H 26D V1 UNIV	Single Cyl Interior Pack							•		\$67.20	4
99660-298	966H 3 V1 UNIV	Single Cyl Interior Pack	•								\$67.20	4
99660-271	966H 514 UNIV	Single Cyl Interior Pack								•	\$67.20	4
99680-027	968H 11P	Dummy Interior Pack				•					\$53.40	4
99680-028	968H 15	Dummy Interior Pack					•				\$53.40	4
99680-029	968H 26	Dummy Interior Pack						•			\$53.40	4
99680-030	968H 26D	Dummy Interior Pack							•		\$53.40	4
99680-031	968H 3	Dummy Interior Pack	•								\$53.40	4
99680-032	968H 514	Dummy Interior Pack								•	\$53.40	4



Henley* Lever

MFG Pro #	Item Description	Function	3	L03	5	11P	15	26	26D	514	List Price	QTY
99660-207	966HYL 15 UNIV	Single Cyl Interior Pack					•				\$72.90	4
99660-208	966HYL 514 UNIV	Single Cyl Interior Pack								•	\$72.90	4



Katella

MFG Pro #	Item Description	Function	3	L03	5	11P	15	26	26D	514	List Price	QTY
99660-303	966KAL 15 V1 UNIV	Single Cyl Interior Pack					•				\$81.00	4
99660-304	966KAL 514 V1 UNIV	Single Cyl Interior Pack								•	\$81.00	4
99680-037	968KAL 15	Dummy Interior Pack					•				\$67.20	4



Ladera RDT

MFG Pro #	Item Description	Function	3	L03	5	11P	15	26	26D	514	List Price	QTY
99660-261	966LRL RDT LH 15 UNIV	Single Cyl Interior Pack					•				\$72.90	4
99660-262	966LRL RDT LH 26 UNIV	Single Cyl Interior Pack						•			\$72.90	4
99660-263	966LRL RDT LH 26D UNIV	Single Cyl Interior Pack							•		\$72.90	4
99660-264	966LRL RDT LH 514 UNIV	Single Cyl Interior Pack								•	\$72.90	4
99660-265	966LRL RDT RH 15 UNIV	Single Cyl Interior Pack					•				\$72.90	4
99660-266	966LRL RDT RH 26 UNIV	Single Cyl Interior Pack						•			\$72.90	4
99660-267	966LRL RDT RH 26D UNIV	Single Cyl Interior Pack							•		\$72.90	4
99660-268	966LRL RDT RH 514 UNIV	Single Cyl Interior Pack								•	\$72.90	4



Ladera SQT*

MFG Pro #	Item Description	Function	3	L03	5	11P	15	26	26D	514	List Price	QTY
99660-253	966LRL SQT LH 15 UNIV	Single Cyl Interior Pack					•				\$72.90	4
99660-254	966LRL SQT LH 26 UNIV	Single Cyl Interior Pack						•			\$72.90	4
99660-255	966LRL SQT LH 26D UNIV	Single Cyl Interior Pack							•		\$72.90	4
99660-256	966LRL SQT LH 514 UNIV	Single Cyl Interior Pack								•	\$72.90	4
99660-257	966LRL SQT RH 15 UNIV	Single Cyl Interior Pack					•				\$72.90	4

99680-040	968PSK RDT 15	Dummy Interior Pack																		\$53.40	4
99680-041	968PSK RDT 26	Dummy Interior Pack																		\$53.40	4
99680-042	968PSK RDT 26D	Dummy Interior Pack																		\$53.40	4
99680-043	968PSK RDT 514	Dummy Interior Pack																		\$53.40	4

Pismo SQT



MFG Pro #	Item Description	Function	3	L03	5	11P	15	26	26D	514	List Price	QTY
99660-283	966PSK SQT 11P UNIV	Single Cyl Interior Pack				•					\$67.20	4
99660-279	966PSK SQT 15 UNIV	Single Cyl Interior Pack					•				\$67.20	4
99660-280	966PSK SQT 26 UNIV	Single Cyl Interior Pack						•			\$67.20	4
99660-282	966PSK SQT 26D UNIV	Single Cyl Interior Pack							•		\$67.20	4
99660-281	966PSK SQT 514 UNIV	Single Cyl Interior Pack								•	\$67.20	4
99680-044	968PSK SQT 11P	Dummy Interior Pack				•					\$53.40	4
99680-045	968PSK SQT 15	Dummy Interior Pack					•				\$53.40	4
99680-046	968PSK SQT 26	Dummy Interior Pack						•			\$53.40	4
99680-047	968PSK SQT 26D	Dummy Interior Pack							•		\$53.40	4
99680-048	968PSK SQT 514	Dummy Interior Pack								•	\$53.40	4

Polo



MFG Pro #	Item Description	Function	3	L03	5	11P	15	26	26D	514	List Price	QTY
99660-214	966P 11P UNIV	Single Cyl Interior Pack				•					\$59.00	4
99660-215	966P 15 UNIV	Single Cyl Interior Pack					•				\$59.00	4
99660-216	966P 26 UNIV	Single Cyl Interior Pack						•			\$59.00	4
99660-217	966P 26D UNIV	Single Cyl Interior Pack							•		\$59.00	4
99660-213	966P 5 UNIV	Single Cyl Interior Pack			•						\$59.00	4
99660-373	966P 514 UNIV	Single Cyl Interior Pack								•	\$59.00	4

Sedona



MFG Pro #	Item Description	Function	3	L03	5	11P	15	26	26D	514	List Price	QTY
99660-350	966SEL LH 15 UNIV	Single Cyl Interior Pack					•				\$81.00	4
99660-364	966SEL LH 4 UNIV	Single Cyl Interior Pack									\$81.00	4
99660-351	966SEL LH 514 UNIV	Single Cyl Interior Pack								•	\$81.00	4
99660-353	966SEL RH 15 UNIV	Single Cyl Interior Pack					•				\$81.00	4
99660-365	966SEL RH 4 UNIV	Single Cyl Interior Pack									\$81.00	4
99660-354	966SEL RH 514 UNIV	Single Cyl Interior Pack								•	\$81.00	4
99680-017	968SEL LH 15	Dummy Interior Pack					•				\$67.20	4
99680-092	968SEL LH 4	Dummy Interior Pack									\$67.20	4
99680-018	968SEL LH 514	Dummy Interior Pack								•	\$67.20	4
99680-020	968SEL RH 15	Dummy Interior Pack					•				\$67.20	4
99680-093	968SEL RH 4	Dummy Interior Pack									\$67.20	4
99680-021	968SEL RH 514	Dummy Interior Pack								•	\$67.20	4

Singapore SQT



MFG Pro #	Item Description	Function	3	L03	5	11P	15	26	26D	514	List Price	QTY
99660-291	966SAL SQT 11P UNIV	Single Cyl Interior Pack				•					\$81.00	4
99660-288	966SAL SQT 15 UNIV	Single Cyl Interior Pack					•				\$81.00	4
99660-289	966SAL SQT 26 UNIV	Single Cyl Interior Pack						•			\$81.00	4
99660-290	966SAL SQT 514 UNIV	Single Cyl Interior Pack								•	\$81.00	4

99680-049	968SAL SQT 11P	Dummy Interior Pack					•						\$67.20	4
99680-050	968SAL SQT 15	Dummy Interior Pack						•					\$67.20	4
99680-051	968SAL SQT 26	Dummy Interior Pack							•				\$67.20	4
99680-052	968SAL SQT 514	Dummy Interior Pack									•		\$67.20	4

Trafford



MFG Pro #	Item Description	Function	3	L03	5	11P	15	26	26D	514	List Price	QTY
99660-355	966TDL 11P UNIV	Single Cyl Interior Pack				•					\$81.00	4
99660-356	966TDL 15 UNIV	Single Cyl Interior Pack					•				\$81.00	4
99660-366	966TDL 514 UNIV	Single Cyl Interior Pack								•	\$81.00	4
99680-022	968TDL 11P	Dummy Interior Pack				•					\$67.20	4
99680-023	968TDL 15	Dummy Interior Pack					•				\$67.20	4
99680-094	968TDL 514	Dummy Interior Pack								•	\$67.20	4

Tustin



MFG Pro #	Item Description	Function	3	L03	5	11P	15	26	26D	514	List Price	QTY
99660-311	966TNL LH 11P V1 UNIV	Single Cyl Interior Pack				•					\$81.00	4
99660-307	966TNL LH 15 V1 UNIV	Single Cyl Interior Pack					•				\$81.00	4
99660-294	966TNL LH 26 UNIV	Single Cyl Interior Pack						•			\$81.00	4
99660-296	966TNL LH 26D UNIV	Single Cyl Interior Pack							•		\$81.00	4
99660-292	966TNL LH 3 UNIV	Single Cyl Interior Pack	•								\$81.00	4
99660-309	966TNL LH 514 V2 UNIV	Single Cyl Interior Pack								•	\$81.00	4
99660-312	966TNL RH 11P V1 UNIV	Single Cyl Interior Pack				•					\$81.00	4
99660-308	966TNL RH 15 V1 UNIV	Single Cyl Interior Pack					•				\$81.00	4
99660-295	966TNL RH 26 UNIV	Single Cyl Interior Pack						•			\$81.00	4
99660-297	966TNL RH 26D UNIV	Single Cyl Interior Pack							•		\$81.00	4
99660-293	966TNL RH 3 UNIV	Single Cyl Interior Pack	•								\$81.00	4
99660-310	966TNL RH 514 V2 UNIV	Single Cyl Interior Pack								•	\$81.00	4
99680-053	968TNL LH 11P	Dummy Interior Pack				•					\$67.20	4
99680-054	968TNL LH 15	Dummy Interior Pack					•				\$67.20	4
99680-055	968TNL LH 26	Dummy Interior Pack						•			\$67.20	4
99680-056	968TNL LH 26D	Dummy Interior Pack							•		\$67.20	4
99680-057	968TNL LH 3	Dummy Interior Pack	•								\$67.20	4
99680-058	968TNL LH 514	Dummy Interior Pack								•	\$67.20	4
99680-059	968TNL RH 11P	Dummy Interior Pack				•					\$67.20	4
99680-060	968TNL RH 15	Dummy Interior Pack					•				\$67.20	4
99680-061	968TNL RH 26	Dummy Interior Pack						•			\$67.20	4
99680-062	968TNL RH 26D	Dummy Interior Pack							•		\$67.20	4
99680-063	968TNL RH 3	Dummy Interior Pack	•								\$67.20	4
99680-064	968TNL RH 514	Dummy Interior Pack								•	\$67.20	4

Tylo



MFG Pro #	Item Description	Function	3	L03	5	11P	15	26	26D	514	List Price	QTY
99660-220	966T 15 UNIV	Single Cyl Interior Pack					•				\$59.00	4
99660-221	966T 26 UNIV	Single Cyl Interior Pack						•			\$59.00	4
99660-222	966T 26D UNIV	Single Cyl Interior Pack							•		\$59.00	4
99660-218	966T 3 UNIV	Single Cyl Interior Pack	•								\$59.00	4
99660-219	966T 5 UNIV	Single Cyl Interior Pack			•						\$59.00	4

1921423-11/24



Arroyo MDT

MFG Pro #	Item Description	Function	3	L03	4	5	11P	15	26	26D	514	List Price	QTY
99710-069	971AYK MDT 15	Single Cyl Interior Pack						•				\$67.20	4
99710-070	971AYK MDT 26	Single Cyl Interior Pack							•			\$67.20	4
99710-071	971AYK MDT 514	Single Cyl Interior Pack									•	\$67.20	4
99730-018	973AYK MDT 15	Dummy Interior Pack						•				\$53.40	4
99730-019	973AYK MDT 26	Dummy Interior Pack							•			\$53.40	4
99730-020	973AYK MDT 514	Dummy Interior Pack									•	\$53.40	4



Breton SQT

MFG Pro #	Item Description	Function	3	L03	4	5	11P	15	26	26D	514	List Price	QTY
99710-050	971BRNL SQT 15	Single Cyl Interior Pack						•				\$72.90	4
99710-051	971BRNL SQT 26	Single Cyl Interior Pack							•			\$72.90	4
99710-052	971BRNL SQT 514	Single Cyl Interior Pack									•	\$72.90	4



Casey SQT

MFG Pro #	Item Description	Function	3	L03	4	5	11P	15	26	26D	514	List Price	QTY
99710-054	971CSL SQT 15	Single Cyl Interior Pack						•				\$72.90	4
99710-057	971CSL SQT 26	Single Cyl Interior Pack							•			\$72.90	4
99710-056	971CSL SQT 514	Single Cyl Interior Pack									•	\$72.90	4



Halifax RDT

MFG Pro #	Item Description	Function	3	L03	4	5	11P	15	26	26D	514	List Price	QTY
99710-132	971HFL RCT 4	Single-Cyl Interior Pack			•							\$81.00	4
99710-090	971HFL RDT 11P	Single Cyl Interior Pack					•					\$81.00	4
99710-091	971HFL RDT 15	Single Cyl Interior Pack						•				\$81.00	4
99710-092	971HFL RDT 26	Single Cyl Interior Pack							•			\$81.00	4
99710-093	971HFL RDT 26D	Single Cyl Interior Pack								•		\$81.00	4
99710-116	971HFL RDT 4	Single Cyl Interior Pack			•							\$81.00	4
99710-094	971HFL RDT 514	Single Cyl Interior Pack									•	\$81.00	4
99730-098	973HFL RCT 4	Dummy Interior Pack			•							\$67.20	4
99730-024	973HFL RDT 11P	Dummy Interior Pack					•					\$67.20	4
99730-025	973HFL RDT 15	Dummy Interior Pack						•				\$67.20	4
99730-026	973HFL RDT 26	Dummy Interior Pack							•			\$67.20	4
99730-027	973HFL RDT 26D	Dummy Interior Pack								•		\$67.20	4
99730-078	973HFL RDT 4	Dummy Interior Pack			•							\$67.20	4
99730-028	973HFL RDT 514	Dummy Interior Pack									•	\$67.20	4



Halifax RCT

MFG Pro #	Item Description	Function	3	L03	4	5	11P	15	26	26D	514	List Price	QTY
99710-132	971HFL RCT 4	Single Cyl Interior Pack			•							\$81.00	4
99710-064	971HFL RCT 15	Single Cyl Interior Pack						•				\$81.00	4
99710-089	971HFL RCT 26	Single Cyl Interior Pack							•			\$81.00	4
99710-065	971HFL RCT 514	Single Cyl Interior Pack									•	\$81.00	4
99730-098	973HFL RCT 4	Single Cyl Interior Pack			•							\$67.20	4
99710-132	971HFL RCT 4	Single-Cyl Interior Pack			•							\$81.00	4

99730-021	973HFL RCT 15	Dummy Interior Pack								•										\$67.20	4	
99730-022	973HFL RCT 26	Dummy Interior Pack																		•	\$67.20	4
99730-023	973HFL RCT 514	Dummy Interior Pack																		•	\$67.20	4
99730-098	973HFL RCT 4	Dummy Interior Pack																	•	\$67.20	4	

Halifax SQT



MFG Pro #	Item Description	Function	3	L03	4	5	11P	15	26	26D	514	List Price	QTY	
99710-015	971HFL SQT 11P V1	Single Cyl Interior Pack						•				\$81.00	4	
99710-014	971HFL SQT 15 V1	Single Cyl Interior Pack							•			\$81.00	4	
99710-016	971HFL SQT 26 V1	Single Cyl Interior Pack								•		\$81.00	4	
99710-095	971HFL SQT 26D	Single Cyl Interior Pack									•	\$81.00	4	
99710-076	971HFL SQT 4	Single Cyl Interior Pack										\$81.00	4	
99710-022	971HFL SQT 514 V1	Single Cyl Interior Pack										•	\$81.00	4
99730-029	973HFL SQT 11P	Dummy Interior Pack						•				\$67.20	4	
99730-030	973HFL SQT 15	Dummy Interior Pack							•			\$67.20	4	
99730-031	973HFL SQT 26	Dummy Interior Pack								•		\$67.20	4	
99730-032	973HFL SQT 26D	Dummy Interior Pack									•	\$67.20	4	
99730-079	973HFL SQT 4	Dummy Interior Pack										\$67.20	4	
99730-033	973HFL SQT 514	Dummy Interior Pack										•	\$67.20	4

Hancock



MFG Pro #	Item Description	Function	3	L03	4	5	11P	15	26	26D	514	List Price	QTY	
99710-046	971H 11P	Single Cyl Interior Pack						•				\$67.20	4	
99710-045	971H 15	Single Cyl Interior Pack							•			\$67.20	4	
99710-088	971H 514	Single Cyl Interior Pack										•	\$67.20	4
99730-017	973H 514	Dummy Interior Pack										•	\$53.40	4

Katella



MFG Pro #	Item Description	Function	3	L03	4	5	11P	15	26	26D	514	List Price	QTY	
99710-062	971KAL 15	Single Cyl Interior Pack						•				\$81.00	4	
99710-063	971KAL 514	Single Cyl Interior Pack										•	\$81.00	4
99730-034	973KAL 15	Dummy Interior Pack							•			\$67.20	4	
99730-035	973KAL 514	Dummy Interior Pack										•	\$67.20	4

Lisbon RDT



MFG Pro #	Item Description	Function	3	L03	4	5	11P	15	26	26D	514	List Price	QTY	
99710-096	971LSL RDT 11P	Single Cyl Interior Pack						•				\$81.00	4	
99710-097	971LSL RDT 15	Single Cyl Interior Pack							•			\$81.00	4	
99710-098	971LSL RDT 26	Single Cyl Interior Pack								•		\$81.00	4	
99710-099	971LSL RDT 514	Single Cyl Interior Pack										•	\$81.00	4
99730-036	973LSL RDT 11P	Dummy Interior Pack						•				\$67.20	4	
99730-037	973LSL RDT 15	Dummy Interior Pack							•			\$67.20	4	
99730-038	973LSL RDT 26	Dummy Interior Pack								•		\$67.20	4	
99730-039	973LSL RDT 514	Dummy Interior Pack										•	\$67.20	4

Lisbon SQT



MFG Pro #	Item Description	Function	3	L03	4	5	11P	15	26	26D	514	List Price	QTY
99710-023	971LSL SQT 11P V1	Single Cyl Interior Pack					•					\$81.00	4
99710-024	971LSL SQT 15 V1	Single Cyl Interior Pack						•				\$81.00	4
99710-025	971LSL SQT 26 V1	Single Cyl Interior Pack							•			\$81.00	4
99710-061	971LSL SQT 514 V1	Single Cyl Interior Pack									•	\$81.00	4
99730-075	973LSL SQT 11P	Dummy Interior Pack					•					\$67.20	4
99730-076	973LSL SQT 15	Dummy Interior Pack						•				\$67.20	4
99730-077	973LSL SQT 26	Dummy Interior Pack							•			\$67.20	4
99730-001	973LSL SQT 514	Dummy Interior Pack									•	\$67.20	4

Milan RDT



MFG Pro #	Item Description	Function	3	L03	4	5	11P	15	26	26D	514	List Price	QTY
99710-017	971MIL RDT 11P V1	Single Cyl Interior Pack					•					\$81.00	4
99710-018	971MIL RDT 15 V1	Single Cyl Interior Pack						•				\$81.00	4
99710-019	971MIL RDT 26 V1	Single Cyl Interior Pack							•			\$81.00	4
99710-100	971MIL RDT 26D	Single Cyl Interior Pack								•		\$81.00	4
99710-101	971MIL RDT 514	Single Cyl Interior Pack									•	\$81.00	4
99730-040	973MIL RDT 11P	Dummy Interior Pack					•					\$67.20	4
99730-041	973MIL RDT 15	Dummy Interior Pack						•				\$67.20	4
99730-042	973MIL RDT 26	Dummy Interior Pack							•			\$67.20	4
99730-043	973MIL RDT 26D	Dummy Interior Pack								•		\$67.20	4
99730-044	973MIL RDT 514	Dummy Interior Pack									•	\$67.20	4

Milan SQT



MFG Pro #	Item Description	Function	3	L03	4	5	11P	15	26	26D	514	List Price	QTY
99710-102	971MIL SQT 11P V1	Single Cyl Interior Pack					•					\$81.00	4
99710-103	971MIL SQT 15 V1	Single Cyl Interior Pack						•				\$81.00	4
99710-104	971MIL SQT 26 V1	Single Cyl Interior Pack							•			\$81.00	4
99710-105	971MIL SQT 26D	Single Cyl Interior Pack								•		\$81.00	4
99710-106	971MIL SQT 514	Single Cyl Interior Pack									•	\$81.00	4
99730-045	973MIL SQT 11P	Dummy Interior Pack					•					\$67.20	4
99730-046	973MIL SQT 15	Dummy Interior Pack						•				\$67.20	4
99730-047	973MIL SQT 26	Dummy Interior Pack							•			\$67.20	4
99730-048	973MIL SQT 26D	Dummy Interior Pack								•		\$67.20	4
99730-049	973MIL SQT 514	Dummy Interior Pack									•	\$67.20	4

Perth



MFG Pro #	Item Description	Function	3	L03	4	5	11P	15	26	26D	514	List Price	QTY
99710-086	971PHL 15	Single Cyl Interior Pack						•				\$81.00	4
99710-087	971PHL 514	Single Cyl Interior Pack									•	\$81.00	4
99730-015	973PHL 15	Dummy Interior Pack						•				\$67.20	4
99730-016	973PHL 514	Dummy Interior Pack									•	\$67.20	4



Pismo RDT

MFG Pro #	Item Description	Function	3	L03	4	5	11P	15	26	26D	514	List Price	QTY
99710-030	971PSK RDT 11P	Single Cyl Interior Pack					•					\$67.20	4
99710-031	971PSK RDT 15	Single Cyl Interior Pack						•				\$67.20	4
99710-032	971PSK RDT 26	Single Cyl Interior Pack							•			\$67.20	4
99710-107	971PSK RDT 26D	Single Cyl Interior Pack								•		\$67.20	4
99710-073	971PSK RDT 4	Single Cyl Interior Pack										\$67.20	4
99710-033	971PSK RDT 514	Single Cyl Interior Pack									•	\$67.20	4
99730-050	973PSK RDT 11P	Dummy Interior Pack					•					\$53.40	4
99730-051	973PSK RDT 15	Dummy Interior Pack						•				\$53.40	4
99730-052	973PSK RDT 26	Dummy Interior Pack							•			\$53.40	4
99730-053	973PSK RDT 26D	Dummy Interior Pack								•		\$53.40	4
99730-080	973PSK RDT 4	Dummy Interior Pack										\$53.40	4
99730-054	973PSK RDT 514	Dummy Interior Pack									•	\$53.40	4



Pismo SQT

MFG Pro #	Item Description	Function	3	L03	4	5	11P	15	26	26D	514	List Price	QTY
99710-108	971PSK SQT 11P	Single Cyl Interior Pack					•					\$67.20	4
99710-039	971PSK SQT 15	Single Cyl Interior Pack						•				\$67.20	4
99710-109	971PSK SQT 26	Single Cyl Interior Pack							•			\$67.20	4
99710-110	971PSK SQT 26D	Single Cyl Interior Pack								•		\$67.20	4
99710-074	971PSK SQT 4	Single Cyl Interior Pack										\$67.20	4
99710-040	971PSK SQT 514	Single Cyl Interior Pack									•	\$67.20	4
99730-055	973PSK SQT 11P	Dummy Interior Pack					•					\$53.40	4
99730-056	973PSK SQT 15	Dummy Interior Pack						•				\$53.40	4
99730-057	973PSK SQT 26	Dummy Interior Pack							•			\$53.40	4
99730-058	973PSK SQT 26D	Dummy Interior Pack								•		\$53.40	4
99730-081	973PSK SQT 4	Dummy Interior Pack										\$53.40	4
99730-059	973PSK SQT 514	Dummy Interior Pack									•	\$53.40	4



Pismo SQT

MFG Pro #	Item Description	Function	3	L03	4	5	11P	15	26	26D	514	List Price	QTY
99710-121	971PVL RCT 15	Single Cyl Interior Pack						•				\$81.00	4
99710-122	971PVL RCT 4	Single Cyl Interior Pack			•							\$81.00	4
99710-120	971PVL RCT 514	Single Cyl Interior Pack									•	\$81.00	4
99710-123	971PVL RCT 514/4	Single Cyl Interior Pack			•						•	\$81.00	4
99730-087	973PVL RCT 15	Dummy Interior Pack						•				\$67.20	4
99730-088	973PVL RCT 4	Dummy Interior Pack			•							\$67.20	4
99730-086	973PVL RCT 514	Dummy Interior Pack									•	\$67.20	4
99730-089	973PVL RCT 514/4	Dummy Interior Pack			•						•	\$67.20	4



Sedona

MFG Pro #	Item Description	Function	3	L03	4	5	11P	15	26	26D	514	List Price	QTY
99710-078	971SEL LH 15	Single Cyl Interior Pack						•				\$81.00	4
99710-117	971SEL LH 4	Single Cyl Interior Pack										\$81.00	4
99710-079	971SEL LH 514	Single Cyl Interior Pack									•	\$81.00	4
99710-081	971SEL RH 15	Single Cyl Interior Pack						•				\$81.00	4
99710-118	971SEL RH 4	Single Cyl Interior Pack										\$81.00	4

1921423-11/24

FULL SQUARE INTERIOR
PACKS FOR LOW PROFILE
818/819 HANDLESETS



November 2024

99730-064	973TPL MDT 15	Dummy Interior Pack							•					\$67.20	4
99730-065	973TPL MDT 26	Dummy Interior Pack								•				\$67.20	4
99730-066	973TPL MDT 514	Dummy Interior Pack										•		\$67.20	4
99710-072	971TPL MDT 15	Single Cyl Interior Pack							•					\$81.00	4
99710-067	971TPL MDT 26	Single Cyl Interior Pack								•				\$81.00	4
99710-068	971TPL MDT 514	Single Cyl Interior Pack										•		\$81.00	4
99730-064	973TPL MDT 15	Dummy Interior Pack							•					\$67.20	4
99730-065	973TPL MDT 26	Dummy Interior Pack								•				\$67.20	4
99730-066	973TPL MDT 514	Dummy Interior Pack										•		\$67.20	4

Tustin



MFG Pro #	Item Description	Function	3	L03	4	5	11P	15	26	26D	514	List Price	QTY
99710-044	971TNL LH 11P	Single Cyl Interior Pack					•					\$81.00	4
99710-042	971TNL LH 15	Single Cyl Interior Pack						•				\$81.00	4
99710-112	971TNL LH 3	Single Cyl Interior Pack	•									\$81.00	4
99710-113	971TNL LH 514	Single Cyl Interior Pack									•	\$81.00	4
99710-043	971TNL RH 11P	Single Cyl Interior Pack					•					\$81.00	4
99710-041	971TNL RH 15	Single Cyl Interior Pack						•				\$81.00	4
99710-114	971TNL RH 3	Single Cyl Interior Pack	•									\$81.00	4
99710-115	971TNL RH 514	Single Cyl Interior Pack									•	\$81.00	4
99730-067	973TNL LH 11P	Dummy Interior Pack					•					\$67.20	4
99730-068	973TNL LH 15	Dummy Interior Pack						•				\$67.20	4
99730-069	973TNL LH 3	Dummy Interior Pack	•									\$67.20	4
99730-070	973TNL LH 514	Dummy Interior Pack									•	\$67.20	4
99730-071	973TNL RH 11P	Dummy Interior Pack					•					\$67.20	4
99730-072	973TNL RH 15	Dummy Interior Pack						•				\$67.20	4
99730-073	973TNL RH 3	Dummy Interior Pack	•									\$67.20	4
99730-074	973TNL RH 514	Dummy Interior Pack									•	\$67.20	4

Halifax SQF



MFG Pro #	Item Description	Function	3	L03	5	11P	15	26	26D	514	List Price	QTY
99710-036	971HFL SQF 11P	Single Cyl Interior Pack				•					\$92.30	4
99710-035	971HFL SQF 15	Single Cyl Interior Pack					•				\$92.30	4
99710-037	971HFL SQF 26	Single Cyl Interior Pack						•			\$92.30	4
99710-038	971HFL SQF 514	Single Cyl Interior Pack								•	\$92.30	4
99730-003	973HFL SQF 11P	Dummy Interior Pack				•					\$78.50	4
99730-002	973HFL SQF 15	Dummy Interior Pack					•				\$78.50	4
99730-004	973HFL SQF 26	Dummy Interior Pack						•			\$78.50	4
99730-005	973HFL SQF 514	Dummy Interior Pack								•	\$78.50	4

1921423-11/24



Halifax LED

MFG Pro #	Item Description	Function	3	L03	4	5	11P	15	26	26D	514	List Price	QTY
97201-124	720HFL SQT LED 514 6AL RCS	Passage									•	\$90.00	12
97301-047	730HFL SQT LED 514 6AL RCS	Privacy									•	\$92.50	12
83840-001	54196 HFL LED LVR & CARTRIDGE KS 514	N/A									•	\$37.80	12



Halifax RCT - San Clemente Trim Lever

MFG Pro #	Item Description	Function	3	L03	4	5	11P	15	26	26D	514	List Price	QTY
97201-135	720HFL RCT 4 6AL RCS	Passage			•							\$83.70	12
97200-909	720HFL RCT 15 6AL RCS	Passage					•					\$80.20	12
97200-962	720HFL RCT 26 6AL RCS	Passage							•			\$80.20	12
97200-910	720HFL RCT 514 6AL RCS	Passage									•	\$83.70	12
97201-135	720HFL RCT 4 6AL RCS	Passage			•							\$83.70	4
97301-058	730HFL RCT 4 6AL RCS	Privacy			•							\$87.30	12
97300-952	730HFL RCT 15 6AL RCS	Privacy					•					\$83.70	12
97300-993	730HFL RCT 26 6AL RCS	Privacy							•			\$83.70	12
97300-953	730HFL RCT 514 6AL RCS	Privacy									•	\$87.30	12
97301-058	730HFL RCT 4 6AL RCS	Privacy			•							\$87.30	4
97403-112	740HFL RCT 4 SMT 6AL RCS	Entry			•							\$138.80	12
97403-113	740HFL RCT 4 SMT 6AL RCS K3	Entry			•							\$138.80	12
97402-985	740HFL RCT 15 SMT 6AL RCS	Entry					•					\$135.20	12
97402-986	740HFL RCT 26 SMT 6AL RCS	Entry							•			\$135.20	12
97402-987	740HFL RCT 26 SMT 6AL RCS K3	Entry							•			\$135.20	12
97402-988	740HFL RCT 514 SMT 6AL RCS	Entry									•	\$138.80	12
97402-923	740HFL RCT SMT 15 6AL RCS K3	Entry					•					\$135.20	12
97402-924	740HFL RCT SMT 514 6AL RCS K3	Entry									•	\$138.80	12
97403-112	740HFL RCT 4 SMT 6AL RCS	Entry			•							\$138.80	4
97403-113	740HFL RCT 4 SMT 6AL RCS K3	Entry			•							\$138.80	4
97881-070	788HFL RCT 4	Dummy			•							\$41.90	20
97880-952	788HFL RCT 15	Dummy					•					\$40.00	20
97880-989	788HFL RCT 26	Dummy							•			\$40.00	20
97880-953	788HFL RCT 514	Dummy									•	\$41.90	20
97881-070	788HFL RCT 4	Inactive			•							\$41.90	4



Halifax SQT

MFG Pro #	Item Description	Function	3	L03	4	5	11P	15	26	26D	514	List Price	QTY
97200-911	720HFL SQT 15 RCALFD RCS	Passage						•				\$73.90	12
97200-864	720HFL SQT 11P 6AL RCS	Passage					•					\$71.40	12
97200-852	720HFL SQT 15 6AL RCS V1	Passage						•				\$71.40	12
97200-950	720HFL SQT 26 6AL FD RCS	Passage							•			\$73.90	12
97200-861	720HFL SQT 26 6AL RCS	Passage							•			\$71.40	12
97200-949	720HFL SQT 26D 6AL FD RCS	Passage								•		\$73.90	12
97200-977	720HFL SQT 26D 6AL RCS	Passage								•		\$71.40	12
97200-935	720HFL SQT 4 6AL RCS	Passage										\$75.00	12
97200-912	720HFL SQT 514 6AL FD RCS	Passage									•	\$77.50	12
97200-871	720HFL SQT 514 6AL RCS	Passage									•	\$75.00	12
97200-979	720HFL SQT 514x26 6AL RCS	Passage									•	\$75.00	12



Halifax RDT - San Clemente Trim Lever

MFG Pro #	Item Description	Function	3	L03	4	5	11P	15	26	26D	514	List Price	QTY
97200-973	720HFL RDT 11P 6AL RCS	Passage					•					\$71.40	12
97200-946	720HFL RDT 15 6AL FD RCS	Passage						•				\$73.90	12
97200-928	720HFL RDT 15 6AL RCS	Passage						•				\$71.40	12
97200-947	720HFL RDT 26 6AL FD RCS	Passage							•			\$73.90	12
97200-974	720HFL RDT 26 6AL RCS	Passage							•			\$71.40	12
97200-945	720HFL RDT 26D 6AL FD RCS	Passage								•		\$73.90	12
97200-975	720HFL RDT 26D 6AL RCS	Passage								•		\$71.40	12
97200-996	720HFL RDT 4 6AL RCS	Passage										\$75.00	12
97200-948	720HFL RDT 514 6AL FD RCS	Passage									•	\$77.50	12
97200-929	720HFL RDT 514 6AL RCS	Passage									•	\$75.00	12
97301-004	730HFL RDT 11P 6AL RCS	Privacy					•					\$74.70	12
97300-970	730HFL RDT 15 6AL RCS	Privacy						•				\$74.70	12
97301-005	730HFL RDT 26 6AL RCS	Privacy							•			\$74.70	12
97301-006	730HFL RDT 26D 6AL RCS	Privacy								•		\$74.70	12
97301-020	730HFL RDT 4 6AL RCS	Privacy										\$78.30	12
97300-971	730HFL RDT 514 6AL RCS	Privacy									•	\$78.30	12
97403-018	740HFL RDT 11P SMT 6AL RCS	Entry					•					\$124.30	12
97403-019	740HFL RDT 11P SMT 6AL RCS K3	Entry					•					\$124.30	12
97403-020	740HFL RDT 15 SMT 6AL RCS	Entry						•				\$124.30	12
97402-936	740HFL RDT 15 SMT 6AL RCS K3	Entry						•				\$124.30	12
97403-021	740HFL RDT 26 SMT 6AL RCS	Entry							•			\$124.30	12
97403-022	740HFL RDT 26 SMT 6AL RCS K3	Entry							•			\$124.30	12
97403-023	740HFL RDT 26D SMT 6AL RCS	Entry								•		\$124.30	12
97403-024	740HFL RDT 26D SMT 6AL RCS K3	Entry								•		\$124.30	12
97403-060	740HFL RDT 4 SMT 6AL RCS	Entry										\$127.90	12
97403-061	740HFL RDT 4 SMT 6AL RCS K3	Entry										\$127.90	12
97403-025	740HFL RDT 514 SMT 6AL RCS	Entry									•	\$127.90	12
97402-937	740HFL RDT 514 SMT 6AL RCS K3	Entry									•	\$127.90	12
97881-002	788HFL RDT 11P	Dummy					•					\$35.70	20
97880-967	788HFL RDT 15	Dummy						•				\$35.70	20
97881-003	788HFL RDT 26	Dummy							•			\$35.70	20
97881-004	788HFL RDT 26D	Dummy								•		\$35.70	20
97881-020	788HFL RDT 4	Dummy										\$37.50	20
97880-968	788HFL RDT 514	Dummy									•	\$37.50	20



Katella

MFG Pro #	Item Description	Function	3	L03	4	5	11P	15	26	26D	514	List Price	QTY
97200-907	720KAL 15 6AL RCS	Passage						•				\$71.40	12
97200-908	720KAL 514 6AL RCS	Passage									•	\$75.00	12
97300-950	730KAL 15 6AL RCS	Privacy						•				\$74.70	12
97300-951	730KAL 514 6AL RCS	Privacy									•	\$78.30	12
97402-989	740KAL 15 SMT 6AL RCS	Entry						•				\$124.30	12
97402-921	740KAL 15 SMT 6AL RCS K3	Entry						•				\$124.30	12
97402-990	740KAL 514 SMT 6AL RCS	Entry									•	\$127.90	12
97402-922	740KAL 514 SMT 6AL RCS K3	Entry									•	\$127.90	12

97402-940	740SAL SQT 4 SMT 6AL RCS K3	Entry													\$127.90	12
97880-944	788SAL 15 SQT	Dummy								•					\$35.70	20
97880-945	788SAL 26 SQT	Dummy									•				\$35.70	20
97880-946	788SAL 514 SQT	Dummy											•		\$37.50	20
97880-994	788SAL SQT 11P	Dummy							•						\$35.70	20
97880-971	788SAL SQT 4	Dummy													\$37.50	20

Trafford



MFG Pro #	Item Description	Function	3	L03	4	5	11P	15	26	26D	514	List Price	QTY
97200-939	720TDL 11P 6AL RCS	Passage					•					\$71.40	12
97200-941	720TDL 15 6AL RCS	Passage						•				\$71.40	12
97200-998	720TDL 514 6AL RCS	Passage									•	\$75.00	12
97300-981	730TDL 11P 6AL RCS	Privacy					•					\$74.70	12
97300-983	730TDL 15 6AL RCS	Privacy						•				\$74.70	12
97301-022	730TDL 514 6AL RCS	Privacy									•	\$78.30	12
97402-950	740TDL 11P SMT 6AL RCS	Keyed Entry					•					\$124.30	12
97402-951	740TDL 11P SMT 6AL RCS K3	Keyed Entry					•					\$124.30	12
97402-953	740TDL 15 SMT 6AL RCS	Keyed Entry						•				\$124.30	12
97402-954	740TDL 15 SMT 6AL RCS K3	Keyed Entry						•				\$124.30	12
97403-067	740TDL 514 SMT 6AL RCS	Keyed Entry									•	\$127.90	12
97403-068	740TDL 514 SMT 6AL RCS K3	Keyed Entry									•	\$127.90	12
97880-979	788TDL 11P	Dummy					•					\$35.70	20
97880-980	788TDL 15	Dummy						•				\$35.70	20
97881-023	788TDL 514	Dummy									•	\$37.50	20

Tripoli MDT



MFG Pro #	Item Description	Function	3	L03	4	5	11P	15	26	26D	514	List Price	QTY
97200-924	720TPL MDT 15 6AL RCS	Passage						•				\$71.40	12
97200-925	720TPL MDT 26 6AL RCS	Passage							•			\$71.40	12
97200-919	720TPL MDT 514 6AL RCS	Passage									•	\$75.00	12
97300-956	730TPL MDT 15 6AL RCS	Privacy					•					\$74.70	12
97300-960	730TPL MDT 26 6AL RCS	Privacy						•				\$74.70	12
97300-963	730TPL MDT 514 6AL RCS	Privacy									•	\$78.30	12
97403-009	740TPL MDT 15 SMT 6AL RCS	Entry						•				\$124.30	12
97402-927	740TPL MDT 15 SMT 6AL RCS K3	Entry						•				\$124.30	12
97403-010	740TPL MDT 26 SMT 6AL RCS	Entry							•			\$124.30	12
97402-928	740TPL MDT 26 SMT 6AL RCS K3	Entry							•			\$124.30	12
97403-011	740TPL MDT 514 SMT 6AL RCS	Entry									•	\$127.90	12
97402-929	740TPL MDT 514 SMT 6AL RCS K3	Entry									•	\$127.90	12
97880-963	788TPL MDT 15	Dummy						•				\$35.70	20
97880-964	788TPL MDT 26	Dummy							•			\$35.70	20
97880-954	788TPL MDT 514	Dummy									•	\$37.50	20



Tustin

MFG Pro #	Item Description	Function	3	L03	4	5	11P	15	26	26D	514	List Price	QTY
97200-705	720TNL 11P 6AL RCS	Passage					•					\$60.60	12
97200-706	720TNL 15 6AL RCS	Passage						•				\$60.60	12
97200-703	720TNL 26 6AL RCS	Passage							•			\$60.60	12
97200-704	720TNL 26D 6AL RCS	Passage								•		\$60.60	12
97200-970	720TNL 3 6AL RCS	Passage	•									\$55.00	12
97200-816	720TNL 514 6AL RCS	Passage									•	\$64.20	12
97300-730	730TNL 11P 6AL RCS	Privacy					•					\$63.90	12
97300-731	730TNL 15 6AL RCS	Privacy						•				\$63.90	12
97300-728	730TNL 26 6AL RCS	Privacy							•			\$63.90	12
97300-729	730TNL 26D 6AL RCS	Privacy								•		\$63.90	12
97301-001	730TNL 3 6AL RCS	Privacy	•									\$58.30	12
97300-860	730TNL 514 6AL RCS	Privacy									•	\$67.50	12
97402-655	740TNL 11P SMT 6AL RCS	Entry					•					\$89.50	12
97402-898	740TNL 11P SMT 6AL RCS K4	Entry					•					\$89.50	12
97402-656	740TNL 15 SMT 6AL RCS	Entry						•				\$89.50	12
97402-902	740TNL 15 SMT 6AL RCS K4	Entry						•				\$89.50	12
97403-012	740TNL 26 SMT 6AL RCS	Entry							•			\$89.50	12
97402-905	740TNL 26 SMT 6AL RCS K4	Entry							•			\$89.50	12
97403-013	740TNL 26D SMT 6AL RCS	Entry								•		\$89.50	12
97402-906	740TNL 26D SMT 6AL RCS K4	Entry								•		\$89.50	12
97403-015	740TNL 3 SMT 6AL RCS K4	Entry	•									\$83.90	12
97403-014	740TNL 3 SMT 6AL RCS V1	Entry	•									\$83.90	12
97403-016	740TNL 514 SMT 6AL RCS K4	Entry									•	\$93.10	12
97401-026	740TNL 514 SMT RCAL RCS	Entry									•	\$93.10	12
97403-017	740TNL 514 SMT RCAL RCS 56566	Entry									•	\$93.10	12
97880-754	788TNL LH 11P	Dummy					•					\$30.30	20
97880-755	788TNL LH 15	Dummy						•				\$30.30	20
97880-757	788TNL LH 26	Dummy							•			\$30.30	20
97880-758	788TNL LH 26D	Dummy								•		\$30.30	20
97880-752	788TNL LH 3	Dummy	•									\$27.50	20
97880-861	788TNL LH 514	Dummy									•	\$32.10	20
97880-761	788TNL RH 11P	Dummy					•					\$30.30	20
97880-762	788TNL RH 15	Dummy						•				\$30.30	20
97880-764	788TNL RH 26	Dummy							•			\$30.30	20
97880-765	788TNL RH 26D	Dummy								•		\$30.30	20
97880-759	788TNL RH 3	Dummy	•									\$27.50	20
97880-862	788TNL RH 514	Dummy									•	\$32.10	20



Abbey

MFG Pro #	Item Description	Function	3	L03	5	11P	15	26	26D	514	List Price	QTY	
97200-833	720A 26D 6AL RCS KI GC	Passage								•		\$39.80	12
97200-834	720A 3 6AL RCS KI GC	Passage	•									\$33.90	12
97300-874	730A 26D 6AL RCS KI GC	Privacy								•		\$43.40	12
97300-875	730A 3 6AL RCS KI GC	Privacy	•									\$37.50	12
97402-778	740A 26D SMT 6AL RCS GC	Entry								•		\$68.20	12
97402-962	740A 26D SMT 6AL RCS K3	Entry								•		\$68.20	12

97402-779	740A 3 SMT 6AL RCS GC	Entry	•											\$62.30	12
97402-963	740A 3 SMT 6AL RCS K3	Entry	•											\$62.30	12
97500-074	750A 26D SMT 6AL RCS GC	Storeroom								•				\$73.20	12
97500-075	750A 3 SMT 6AL RCS	Storeroom	•											\$67.30	12
97880-984	788A 26D	Dummy								•				\$19.90	20
97880-995	788A 3 KI V1	Dummy	•											\$16.95	20
97880-963	788TPL MDT 15	Dummy							•					\$35.70	20
97880-964	788TPL MDT 26	Dummy								•				\$35.70	20
97880-954	788TPL MDT 514	Dummy										•		\$37.50	20

Arroyo



MFG Pro #	Item Description	Function	3	L03	5	11P	15	26	26D	514	List Price	QTY
97200-920	720AYK MDT 15 6AL RCS	Passage					•				\$50.20	12
97200-921	720AYK MDT 26 6AL RCS	Passage						•			\$50.20	12
97200-922	720AYK MDT 514 6AL RCS	Passage								•	\$53.70	12
97300-964	730AYK MDT 15 6AL RCS	Privacy					•				\$53.80	12
97300-965	730AYK MDT 26 6AL RCS	Privacy						•			\$53.80	12
97300-966	730AYK MDT 514 6AL RCS	Privacy								•	\$57.30	12
97402-982	740AYK MDT 15 SMT 6AL RCS	Entry					•				\$78.60	12
97402-930	740AYK MDT 15 SMT 6AL RCS K3	Entry					•				\$78.60	12
97402-983	740AYK MDT 26 SMT 6AL RCS	Entry						•			\$78.60	12
97402-931	740AYK MDT 26 SMT 6AL RCS K3	Entry						•			\$78.60	12
97402-984	740AYK MDT 514 SMT 6AL RCS	Entry								•	\$82.10	12
97402-932	740AYK MDT 514 SMT 6AL RCS K3	Entry								•	\$82.10	12
97880-955	788AYK MDT 15	Dummy					•				\$25.10	20
97880-956	788AYK MDT 26	Dummy						•			\$25.10	20
97880-957	788AYK MDT 514	Dummy								•	\$26.85	20

Hancock



MFG Pro #	Item Description	Function	3	L03	5	11P	15	26	26D	514	List Price	QTY
97200-835	720H 11P 6AL RCS GC	Passage				•					\$41.70	12
97200-955	720H 11Px26 6AL RCS	Passage				•					\$41.70	12
97200-826	720H 15 6AL RCS KI GC	Passage					•				\$41.70	12
97200-821	720H 26 RCAL RCS KI GC	Passage						•			\$41.70	12
97200-956	720H 26D 6AL RCS	Passage							•		\$41.70	12
97200-957	720H 3 6AL RCS	Passage	•								\$35.80	12
97200-897	720H 514 6AL RCS KI V1	Passage								•	\$45.20	12
97300-876	730H 11P 6AL RCS GC	Privacy				•					\$45.30	12
97300-869	730H 15 6AL RCS KI GC	Privacy					•				\$45.30	12
97300-863	730H 26 RCAL RCS KI GC	Privacy						•			\$45.30	12
97300-987	730H 26D 6AL RCS	Privacy							•		\$45.30	12
97300-988	730H 3 6AL RCS	Privacy	•								\$39.40	12
97300-940	730H 514 6AL RCS KI V1	Privacy								•	\$48.80	12
97402-964	740H 11P 6AL RCS K3	Entry				•					\$65.10	12
97402-795	740H 11P SMT 6AL RCS GC	Entry				•					\$70.10	12
97402-871	740H 11P SMT 6AL RCS K3 V1	Entry				•					\$70.10	12
97402-873	740H 15 6AL RCS K3 KI V1	Entry					•				\$65.10	12



Midtown Deadbolt 258 MDT

MFG Pro #	Item Description	Function	3	L03	4	5	11P	15	26	26D	514	List Price	QTY
92580-041	258 MDT 15 SMT 6AL STRKP	Single Cyl						•				\$87.90	12
92580-036	258 MDT 15 SMT 6AL STRKP K3	Single Cyl						•				\$87.90	12
92580-042	258 MDT 26 SMT 6AL STRKP	Single Cyl							•			\$87.90	12
92580-037	258 MDT 26 SMT 6AL STRKP K3	Single Cyl							•			\$87.90	12
92580-043	258 MDT 514 SMT 6AL STRKP	Single Cyl									•	\$91.50	12
92580-038	258 MDT 514 SMT 6AL STRKP K3	Single Cyl									•	\$91.50	12



Milan Deadbolt 158/159 RDT

MFG Pro #	Item Description	Function	3	L03	4	5	11P	15	26	26D	514	List Price	QTY
91580-066	158 RDT 11P SMT 6AL STRKP	Single Cyl					•					\$78.20	12
91580-067	158 RDT 11P SMT 6AL STRKP K3	Single Cyl					•					\$78.20	12
91580-068	158 RDT 15 SMT 6AL STRKP	Single Cyl						•				\$78.20	12
91580-069	158 RDT 15 SMT 6AL STRKP K3	Single Cyl						•				\$78.20	12
91580-055	158 RDT 15 SMT RCALFDRCS-530323155LESSKE	Single Cyl						•				\$80.70	12
91580-070	158 RDT 26 SMT 6AL STRKP	Single Cyl							•			\$78.20	12
91580-071	158 RDT 26 SMT 6AL STRKP K3	Single Cyl							•			\$78.20	12
91580-072	158 RDT 26D SMT 6AL STRKP	Single Cyl								•		\$78.20	12
91580-073	158 RDT 26D SMT 6AL STRKP K3	Single Cyl								•		\$78.20	12
91580-074	158 RDT 514 SMT 6AL STRKP	Single Cyl									•	\$81.90	12
91580-075	158 RDT 514 SMT 6AL STRKP K3	Single Cyl									•	\$81.90	12
91580-056	158 RDT 514 SMTRCALFDRCS RCS-530323155LESSKEY	Single Cyl									•	\$84.40	12
91580-076	158 RDT 514x26 SMT 6AL STRKP	Single Cyl									•	\$81.90	12
91580-097	158RDT 15 SMT 6AL FD RCS/5303 65665 LK	Single Cyl						•				\$80.70	12
91580-103	158RDT 26 SMT 6AL FD RCS/5303 23155 LK	Single Cyl							•			\$80.70	12
91580-098	158RDT 26 SMT 6AL FD RCS/5303 65665 LK	Single Cyl							•			\$80.70	12
91580-104	158RDT 26D SMT 6AL FD RCS/5303 23155 LK	Single Cyl								•		\$80.70	12
91580-099	158RDT 26D SMT 6AL FD RCS/5303 65665 LK	Single Cyl								•		\$80.70	12
91580-100	158RDT 514 SMT 6AL FD RCS/5303 65665 LK	Single Cyl									•	\$84.40	12
91590-013	159 RDT 11P SMT 6AL STRKP K3	Double Cyl					•					\$111.00	12
91590-014	159 RDT 15 SMT 6AL STRKP K3	Double Cyl						•				\$111.00	12
91590-015	159 RDT 26 SMT 6AL STRKP K3	Double Cyl							•			\$111.00	12
91590-016	159 RDT 26D SMT 6AL STRKP K3	Double Cyl								•		\$111.00	12
91590-017	159 RDT 514 SMT 6AL STRKP K3	Double Cyl									•	\$114.80	12
99820-003	982 RDT 15 SMT RCAL RCS/5303 UL K3	Single Cyl UL						•				\$80.50	12
99820-004	982 RDT 15 SMT SCAL SCS UL K3	Single Cyl UL						•				\$80.50	12
99820-005	982 RDT 26 SMT RCAL RCS/5303 UL K3	Single Cyl UL							•			\$80.50	12
99820-006	982 RDT 26 SMT SCAL SCS UL K3	Single Cyl UL							•			\$80.50	12
99820-009	982 RDT 26D SMT RCAL RCS /5303 UL K3	Single Cyl UL								•		\$80.50	12
99820-010	982 RDT 26D SMT SCAL SCS UL K3	Single Cyl UL								•		\$80.50	12
99820-007	982 RDT 514 SMT RCAL RCS /5303 UL K3	Single Cyl UL									•	\$84.10	12
99820-008	982 RDT 514 SMT SCAL SCS UL K3	Single Cyl UL									•	\$84.10	12

San Clemente Deadbolt 258 RCT



MFG Pro #	Item Description	Function	3	L03	4	5	11P	15	26	26D	514	List Price	QTY
92580-070	258 RCT 4 SMT 6AL STRKP	Single Cyl			•							\$100.10	12
92580-071	258 RCT 4 SMT 6AL STRKP K3	Single Cyl			•							\$100.10	12
92580-044	258 RCT 15 SMT 6AL STRKP	Single Cyl						•				\$96.60	12
92580-045	258 RCT 15 SMT 6AL STRKP K3	Single Cyl						•				\$96.60	12
92580-046	258 RCT 26 SMT 6AL STRKP	Single Cyl							•			\$96.60	12
92580-047	258 RCT 26 SMT 6AL STRKP K3	Single Cyl							•			\$96.60	12
92580-048	258 RCT 514 SMT 6AL STRKP	Single Cyl									•	\$100.10	12
92580-049	258 RCT 514 SMT 6AL STRKP K3	Single Cyl									•	\$100.10	12

Uptown Deadbolt 258 RDT



MFG Pro #	Item Description	Function	3	L03	4	5	11P	15	26	26D	514	List Price	QTY
92580-050	258 RDT 11P SMT 6AL STRKP	Single Cyl					•					\$87.90	12
92580-023	258 RDT 11P SMT 6AL STRKP K3	Single Cyl					•					\$87.90	12
92580-051	258 RDT 15 SMT 6AL STRKP	Single Cyl						•				\$87.90	12
92580-024	258 RDT 15 SMT 6AL STRKP K3	Single Cyl						•				\$87.90	12
92580-052	258 RDT 26 SMT 6AL STRKP	Single Cyl							•			\$87.90	12
92580-025	258 RDT 26 SMT 6AL STRKP K3	Single Cyl							•			\$87.90	12
92580-053	258 RDT 26D SMT 6AL STRKP	Single Cyl								•		\$87.90	12
92580-054	258 RDT 26D SMT 6AL STRKP K3	Single Cyl								•		\$87.90	12
92580-062	258 RDT 4 SMT 6AL STRKP	Single Cyl										\$91.50	12
92580-040	258 RDT 4 SMT 6AL STRKP K3	Single Cyl										\$91.50	12
92580-055	258 RDT 514 SMT 6AL STRKP	Single Cyl									•	\$91.50	12
92580-026	258 RDT 514 SMT 6AL STRKP K3	Single Cyl									•	\$91.50	12
92580-032	258 RDT 514 SMTRCALFDRCS-530323155LESSKEY	Single Cyl									•	\$94.00	12
92580-056	258 SQT 11P SMT 6AL STRKP	Single Cyl					•					\$87.90	12
92580-027	258 SQT 11P SMT 6AL STRKP K3	Single Cyl					•					\$87.90	12
92580-057	258 SQT 15 SMT 6AL STRKP	Single Cyl						•				\$87.90	12
92580-028	258 SQT 15 SMT 6AL STRKP K3	Single Cyl						•				\$87.90	12
92580-058	258 SQT 26 SMT 6AL STRKP	Single Cyl							•			\$87.90	12
92580-029	258 SQT 26 SMT 6AL STRKP K3	Single Cyl							•			\$87.90	12
92580-059	258 SQT 26D SMT 6AL STRKP	Single Cyl								•		\$87.90	12
92580-060	258 SQT 26D SMT 6AL STRKP K3	Single Cyl								•		\$87.90	12
92580-063	258 SQT 4 SMT 6AL STRKP	Single Cyl										\$91.50	12
92580-039	258 SQT 4 SMT 6AL STRKP K3	Single Cyl										\$91.50	12
92580-061	258 SQT 514 SMT 6AL STRKP	Single Cyl									•	\$91.50	12
92580-030	258 SQT 514 SMT 6AL STRKP K3	Single Cyl									•	\$91.50	12
92580-031	258 SQT 514 SMTRCALFDRCS-530323155LESSKEY	Single Cyl									•	\$94.00	12



KWIKSET SIGNATURE SERIES HANDLESETS

Door Prep	Deadbolt: Cross Bore 2-1/8" or 1-1/2". Edge Bore 1". Handle: Cross Bore 2-1/8". Edge Bore 1".
Backset	Deadbolt: Adjustable to 2-3/8" or 2-3/4". Handle: Adjustable to 2-3/8" or 2-3/4".
Door Thickness	1-3/4" doors standard. 2-1/4" doors optional. Not designed for use on 1-3/8" doors.
Cylinder	SmartKey Security
Faceplate	1" x 2-1/4". Specify round corner, square corner or drive-in.
Strikes	Deadbolt: 2.74" x 1.115" round corner and square corner. 2.25" x 1.75" 5303 round corner full lip strike (grade 3 when used) Other strikes are available as service parts. Handle: 2-1/4" round corner and square corner full lip. Other options available as service parts.
Bolt	Deadbolt: 1" throw. Handle: 1/2" throw.
Door Handing	Reversible for right or left-hand doors.
ANSI/BHMA	Deadbolt is Grade 1 Certified.
ADA	N/A
UL	N/A

KWIKSET SIGNATURE SERIES LEVERS

Door Prep	Cross Bore 2-1/8" Edge Bore 1" Latch Face 1" x 2-1/4"
Backset	Adjustable 2-3/8" or 2-3/4".
Door Thickness	1-3/8" - 1-3/4" doors standard. 2-1/4" doors optional on 720 and 740 models. Up to 2-1/8" doors optional on HFL/MIL/LSL/MRL/SAL
Cylinder	SmartKey Security
Rose	Specify round or square rose - HFL, LSL, MIL, SAL
Faceplate	1" x 2-1/4" round corner, square corner and drive in collar. Round front comes staked.
Strikes	2-1/4" round corner full lip. Other options available as service parts.
Bolt	1/2" throw
Door Handing	Specify handing only with Tustin and Sedona inactive levers
ANSI/BHMA	Grade 2 Certified.
ADA	All families except Tustin in Functions Passage, Privacy are in compliance with the American National Standards Institute (ANSI A117.1) and the Americans with Disabilities Act (ADA).
UL	UL 3 hour fire rating and 1/3 hour fire rating available on select families.

KWIKSET SIGNATURE SERIES KNOBS

Door Prep	Cross Bore: 2-1/8" Edge Bore: 1" Latch Face: 1"x 2-1/4".
Backset	Adjustable to 2-3/8" or 2-3/4".
Door Thickness	1-3/8" - 1-3/4" doors standard.
Cylinder	SmartKey Security or Pin & Tumbler.
Faceplate	1" x 2-1/4" round corner, square corner and drive-in collar.
Strikes	2-1/4" round corner full lip. Other options available as service parts.
Bolt	1/2" throw.
Door Handing	Reversible for right- or left-hand doors.
ANSI/BHMA	Grade 2 Certified
ADA	N/A
UL	N/A

VANCOUVER HANDLESET

Door Prep (Deadbolt/Handle)	Crossbore 2-1/8". Edge Bore 1". Latch Face 1" x 2-1/4" Deadbolt & Handle bore holes must be 5-1/2" apart
Backset (Deadbolt/Handle)	Adjustable 2-3/8" or 2-3/4"
Door Thickness	1-3/4" Standard. Thick door service part available for up to 2-1/4"
Cylinder	SmartKey Security
Faceplate	1" x 2-1/4". Square, round, or drive in
Strikes	Deadbolt: 2.74" x 1.115" round corner and square corner 2.25" x 1.75" 5303 round corner full lip strike (grade 3 when used) Other strikes are available as service parts. Handle: 2-1/4" round corner and square corner full lip. Other options available as service parts.
Bolt	Deadbolt: 1" Throw Handle: 1/2" Throw
Door Handing	Reversible for right or left-hand doors.
ANSI/BHMA	Deadbolt - A156.39 Grade AAA Certified
ADA	N/A
UL	N/A

*Optional UL 1/3 hour list price charge is \$2.50.

KWIKSET SIGNATURE SERIES 158/159 CONTEMPORARY DEADBOLTS

Door Prep	Cross Bore 2-1/8" or 1-1/2". Edge Bore 1".
Backset	Adjustable 2-3/8" or 2-3/4".
Door Thickness	1-3/8" - 1-3/4".
Cylinder	SmartKey Security
Rose	Specify round or square rose
Strikes	2.74" x 1.115" round corner and square corner 2.25" x 1.75" 5303 round corner full lip strike (grade 3 when used) Other strikes are available as service parts.
Bolt	1" Throw Steel.
ANSI/BHMA	A156.36 Grade 2
ADA	Interior turn pieces are in compliance with the American National Standards Institute (ANSI A117.1) and the Americans with Disabilities Act (ADA).
UL	UL 3 hour and 1/3 hour fire rating available on select SKUs.

KWIKSET SIGNATURE SERIES 980/985 DEADBOLTS

Door Prep	980: Crossbore 2-1/8" or 1-1/2". Edge Bore 1". 982: Crossbore 2-1/8".
Backset	Adjustable 2-3/8" or 2-3/4".
Door Thickness	1-3/8" - 1-3/4" doors standard. 1-7/8" - 2-1/4" optional.
Cylinder	SmartKey Security
Faceplate	1" x 2-1/4" round corner, square corner and drive-in collar
Strikes	2.74" x 1.115" round corner and square corner 2.25" x 1.75" 5303 round corner full lip strike (grade 3 when used) Other strikes are available as service parts.
Bolt	1" throw.
Door Handing	Reversible for right or left-hand doors.
ANSI/BHMA	Grade 1 Certified.
ADA	Interior turn pieces are in compliance with the American National Standards Institute (ANSI A117.1) and the Americans with Disabilities Act (ADA).
UL	Meets UL 3 hour fire rating for 982 UL 1/3 hour fire rating available on select SKUs.

KWIKSET SIGNATURE SERIES 780-785 DEADBOLTS

Door Prep	780, 785: Crossbore 2-1/8" or 1-1/2". Edge Bore 1".
Backset	Adjustable 2-3/8" or 2-3/4" standard.
Door Thickness	1-3/8" - 1-3/4" doors standard. 1-7/8" - 2-1/4" optional.
Cylinder	SmartKey Security or 6-pin removable core.
Faceplate	1" x 2-1/4" round corner, square corner and drive-in collar
Strikes	2.74" x 1.115" round corner and square corner 2.25" x 1.75" 5303 round corner full lip strike (grade 3 when used) Other strikes are available as service parts.
Bolt	1" throw.
Door Handing	Reversible for right or left-hand doors.
ANSI/BHMA	Grade 2 Certified.
ADA	Interior turn pieces are in compliance with the American National Standards Institute (ANSI A117.1) and the Americans with Disabilities Act (ADA).
UL	Meets UL 3 hour fire rating for 782. UL 1/3 hour fire rating available on select SKUs.

KWIKSET SIGNATURE SERIES 258 DEADBOLTS

Door Prep	Cross Bore 2-1/8". Edge Bore 1".
Backset	Adjustable 2-3/8" or 2-3/4".
Door Thickness	1-3/8" - 1-3/4" Standard. Thick door service part available for up to 2'1/4".
Cylinder	Smartkey Security
Faceplate	1" x 2-1/4" round corner, square corner and drive-in collar
Rose	Specify round (Uptown) or square (Downtown) rose.
Strikes	2.74" x 1.115" round corner and square corner 2.25" x 1.75" 5303 round corner full lip strike (grade 3 when used) Other strikes are available as service parts.
Bolt	1" Throw Steel.
ANSI/BHMA	A156.36 Grade 1
ADA	Interior turn pieces are in compliance with the American National Standards Institute (ANSI A117.1) and the Americans with Disabilities Act (ADA).
UL	UL 1/3 hour fire rating available on select SKUs.

KWIKSET SIGNATURE SERIES HANDLESET

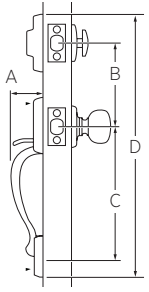

Design	A	B	C	D	E
Arlington*	2-1/2"	5-1/2"	11"	19-1/16"	15"
Austin	3-1/8"	5-1/2"	8-13/32" 9-1/8" 9-11/16"	18-13/32"	13-17/20"
Avalon™	2-7/8"	5-1/2"	8-13/32"	18- 5/32" 12-13/20"	13"
Chelsea*	2-3/16"	5-1/2"	9-11/16"	18 -1/2"	13"
Hawthorne™	2-7/8"	5-1/2"	8-13/32"	17-7/16"	13-2/5"
Prague	2-25/32"	5-1/2"	8-13/32"	17-23/32"	
Prava	2-21/32"	5-1/2"	8-13/32"	17-15/16"	13-7/16"
Prescott	2-25/32"	5-1/2"	8-13/32"	17-23/32"	
San Clemente	2-5/8"	5-1/2"	8-13/32"	17-15/16"	
Tavaris	2-17/32"	5-1/2"	8-13/32"	18"	12-19/25"
Vancouver	2-1/32"	5-1/2"	8-13/32" 9-11/16"	17-15/16"	

KWIKSET SIGNATURE SERIES KNOBS

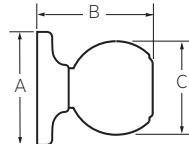

Design	A	B	C
Arroyo	2-5/8"	2-7/16"	2-3/16"
Abbey*	2-5/8"	2-7/16"	2"
Hancock*	2-5/8"	2-1/2"	2-3/8"
Laurel*	2-5/8"	2-7/16"	2-7/16"
Pismo	2-5/8"	2-13/32"	2-6/7"

KWIKSET SIGNATURE SERIES LEVERS

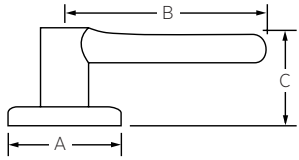

Design	A	B	C	B (Keyed)	C (Keyed)
Halifax	2-5/8"	4-15/32"	2-19/32"		2-3/8"
Katella	2-21/32"	4-1/4"	2-15/32"		2-9/16"
Lisbon	2-5/8"	4-5/32"	2-9/16"		2-3/8"
Milan	2-5/8"	4-5/32"	2-9/16"		2-3/8"
Perth	2-21/32"	4-1/4"	2-7/16"		2-11/32"
Prava	2-25/32"	4-1/4"	2-3/8"		
Sedona	2-21/32"	4-1/4"	2-17/32"	4-9/32"	2-5/16"
Singapore Square	2-11/16"	4-7/32"	2-1/2"		2-1/4"
Trafford	2-21/32"	4-5/32"	2-19/32"		2-9/16"
Tustin*	2-5/8"	4-7/32"	2-3/32"		2-19/32"
Tripoli	2-11/16"	4-1/14"	2-9/16"		2-9/16"

KWIKSET SIGNATURE SERIES 158-159 DEADBOLT

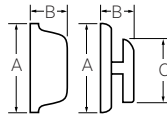

Round Design	A	B	C
158 Interior	2-17/32"	1-13/32"	1-11/16"
158 Exterior	2-17/32"	15/16"	
159 Interior	2-17/32"	1-13/32"	1-11/16"
159 Exterior	2-17/32"	15/16"	

Square Design	A	B	C
158 Interior	2-17/32"	1-13/32"	1-11/16"
158 Exterior	2-19/32"	15/16"	
159 Interior	2-17/32"	1-13/32"	1-11/16"
159 Exterior	2-19/32"	15/16"	

KWIKSET SIGNATURE SERIES 980-985 DEADBOLT

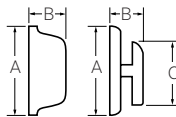

Design	A	B	C
980 Interior	2-19/32"	1-5/32"	1-13/16"
980 Exterior	2-5/8"	1-1/32"	
985 Interior	2-5/8"	1-1/32"	
985 Exterior	2-5/8"	1-1/32"	

KWIKSET SIGNATURE SERIES 780-785 DEADBOLT

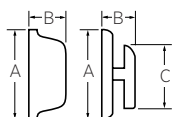

Design	A	B	C
780	2-1/2"	15/16"	1-25/32"
780	2-5/8"	1-1/8"	
785 Interior	2-5/8"	1-1/8"	
785 Exterior	2-5/8"	1-1/8"	

KWIKSET SIGNATURE SERIES 258 UPTOWN, DOWNTOWN & MIDTOWN

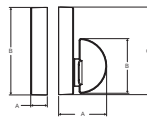

Design	A	B	C
258 Round Interior	1-3/8"	1-21/32"	2-5/8"
258 Round Exterior	9/16"	2-5/8"	

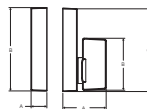

Design	A	B	C
258 Square Interior	1-7/16"	1-21/32"	2-5/8"
258 Square Exterior	1/2"	2-5/8"	

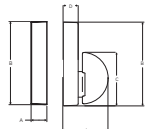

Design	A	B	C	D
258 MDT Interior	1-7/16"	2-11/16"	1-21/32"	1/2"
258 MDT Exterior	1/2"	2-11/16"		

Trusted Security



- ANSI/BHMA Grade 3
- Easy Installation
- Available with SmartKey® Security
- Most Recognized Styles

Warranty

- Lifetime Mechanical
- Lifetime Finish



| Aliso™

| Cove™

| Polo®

| Tylo®



| Balboa™

| Breton

| Casey

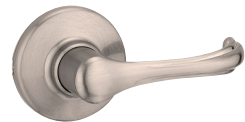

| Delta™

| Dorian®



| 660 RDT
Contemporary

| 660 SQT
Deadbolt

| 660/665
Deadbolt



| Henley



| Ladera®



Amador

MFG Pro #	Item Description	Function	3	L03	5	11P	15	26	26D	514	List Price	QTY
96870-145	687AMD LIP 15 SMT RCAL RCS/5303	Single Cyl					•				\$189.80	6
96870-176	687AMD LIP 26 SMT RCAL RCS/5303	Single Cyl						•			\$189.80	6
96870-177	687AMD LIP 26D SMT RCAL RCS/5303	Single Cyl							•		\$171.00	6
96870-148	687AMD LIP 514 SMT RCAL RCS/5303	Single Cyl								•	\$199.00	6
98980-014	898AMD 15 RCAL RCS BP	Grip Only					•				\$156.80	6
98980-016	898AMD 26 RCAL RCS BP	Grip Only						•			\$156.80	6
98980-017	898AMD LIP 514 RCAL RCS BP	Grip Only								•	\$166.00	6



Bellevue

MFG Pro #	Item Description	Function	3	L03	5	11P	15	26	26D	514	List Price	QTY
96870-178	687BW LIP 15 RCAL RCS/5303	Single Cyl					•				\$146.20	6
96870-095	687BW LIP 15 SMT RCAL RCS/5303	Single Cyl					•				\$151.20	6
96870-179	687BW LIP 26D SMT RCAL RCS/5303	Single Cyl							•		\$132.40	6
96870-158	687BW LIP 514 SMT RCAL RCS/5303	Single Cyl								•	\$160.50	6



Dakota

MFG Pro #	Item Description	Function	3	L03	5	11P	15	26	26D	514	List Price	QTY
96870-180	687DA LIP 11P RCAL RCS/5303	Single Cyl				•					\$146.20	6
96870-086	687DA LIP 11P SMT RCAL RCS/5303	Single Cyl				•					\$151.20	6
96870-078	687DA LIP 15 RCAL RCS/5303	Single Cyl					•				\$146.20	6
96870-085	687DA LIP 15 SMT RCAL RCS/5303	Single Cyl					•				\$151.20	6
96870-181	687DA LIP 26D SMT RCAL RCS/5303	Single Cyl							•		\$132.40	6
96870-182	687DA LIP 5 SMT RCAL RCS/5303	Single Cyl			•						\$132.40	6
96870-174	687DA LIP 514 SMT RCAL RCS/5303	Single Cyl								•	\$160.50	6
98980-011	898DA 11P RCAL RCS BP	Grip Only				•					\$113.20	6
98980-010	898DA 15 RCAL RCS BP	Grip Only					•				\$113.20	6



Henley

MFG Pro #	Item Description	Function	3	L03	5	11P	15	26	26D	514	List Price	QTY
96870-169	687HYH LIP 15 SMT RCAL RCS/5303	Single Cyl					•				\$189.00	6
96870-170	687HYH LIP 514 SMT RCAL RCS/5303	Single Cyl								•	\$199.80	6
98980-020	898HYH 11P 6AL RCS	Grip Only				•					\$156.80	6
98980-018	898HYH 15 6AL RCS	Grip Only					•				\$156.80	6
98980-019	898HYH 514 6AL RCS	Grip Only								•	\$166.00	6



Balboa

MFG Pro #	Item Description	Function	3	L03	5	11P	15	26	26D	514	List Price	QTY
92001-527	200BL 11P 6AL RCS RLVR V1	Passage				•					\$48.60	20
92001-629	200BL 15 6AL FD RCS	Passage					•				\$51.10	20
92001-528	200BL 15 6AL RCS RLVR V1	Passage					•				\$48.60	20
92001-529	200BL 26 6AL RCS V1	Passage						•			\$48.60	20
92001-638	200BL 26D 6AL RCS	Passage							•		\$44.50	20
92001-639	200BL 3 6AL RCS	Passage	•								\$44.50	20
92001-640	200BL 5 6AL RCS	Passage			•						\$44.50	20
92001-599	200BL 514 6AL RCS V1	Passage								•	\$51.60	20
93001-884	300BL 11P 6AL RCS RLVR V1	Privacy				•					\$51.60	20
93001-885	300BL 15 6AL RCS RLVR V1	Privacy					•				\$51.60	20
93001-886	300BL 26 6AL RCS V1	Privacy						•			\$51.60	20
93002-044	300BL 26D 6AL RCS	Privacy							•		\$47.50	20
93002-045	300BL 3 6AL RCS V1	Privacy	•								\$47.50	20
93002-046	300BL 5 6AL RCS V1	Privacy			•						\$47.50	20
93002-024	300BL 514 6AL RCS V1	Privacy								•	\$54.60	20
94050-709	405BL 11P 6AL RCS K4	Entry				•					\$67.10	20
94050-640	405BL 11P SMT 6AL RCS K4 RLVR V1	Entry				•					\$72.10	20
94050-641	405BL 15 6AL RCS K4 RLVR V1	Entry					•				\$67.10	20
94050-730	405BL 15 SMT 6AL RCS	Entry					•				\$72.10	20
94050-708	405BL 15 SMT 6AL RCS 56665 LK	Entry					•				\$72.10	20
94050-642	405BL 15 SMT 6AL RCS K4 RLVR V1	Entry					•				\$72.10	20
94050-644	405BL 26 SMT 6AL RCS K4 V1	Entry						•			\$72.10	20
94050-710	405BL 26D 6AL RCS K4	Entry							•		\$63.00	20
94050-711	405BL 26D SMT 6AL RCS K4	Entry							•		\$68.00	20
94050-712	405BL 3 SMT 6AL RCS K4 V1	Entry	•								\$68.00	20
94050-713	405BL 5 6AL RCS K4 V1	Entry			•						\$63.00	20
94050-714	405BL 5 SMT 6AL RCS K4 V1	Entry			•						\$68.00	20
94050-671	405BL 514 SMT 6AL RCS K4 V1	Entry								•	\$75.10	20
94880-534	488BL LH 11P V1	Dummy				•					\$24.30	20
94880-535	488BL LH 15 V1	Dummy					•				\$24.30	20
94880-536	488BL LH 26 V1	Dummy						•			\$24.30	20
94880-645	488BL LH 26D	Dummy							•		\$22.30	20
94880-646	488BL LH 3 V1	Dummy	•								\$22.30	20
94880-647	488BL LH 5 V1	Dummy			•						\$22.30	20
94880-610	488BL LH 514 V1	Dummy								•	\$25.80	20
94880-537	488BL RH 11P V1	Dummy				•					\$24.30	20
94880-538	488BL RH 15 V1	Dummy					•				\$24.30	20
94880-539	488BL RH 26 V1	Dummy						•			\$24.30	20
94880-648	488BL RH 26D	Dummy							•		\$22.30	20
94880-649	488BL RH 3 V1	Dummy	•								\$22.30	20
94880-650	488BL RH 5 V1	Dummy			•						\$22.30	20
94880-609	488BL RH 514 V1	Dummy								•	\$25.80	20



Breton RDT

MFG Pro #	Item Description	Function	3	L03	5	11P	15	26	26D	514	List Price	QTY
92001-641	200BRNL RDT 15 6AL RCS	Passage					•				\$53.30	12
92001-642	200BRNL RDT 26 6AL RCS	Passage						•			\$53.30	12
92001-643	200BRNL RDT 514 6AL RCS	Passage								•	\$56.30	12
93002-047	300BRNL RDT 15 6AL RCS	Privacy					•				\$56.30	12
93002-048	300BRNL RDT 26 6AL RCS	Privacy						•			\$56.30	12
93002-049	300BRNL RDT 514 6AL RCS	Privacy								•	\$59.30	12
94050-715	405BRNL RDT 15 SMT 6AL RCS K4	Entry					•				\$76.80	12
94050-716	405BRNL RDT 26 SMT 6AL RCS K4	Entry						•			\$76.80	12
94050-717	405BRNL RDT 514 SMT 6AL RCS K4	Entry								•	\$79.80	12
94880-651	488BRNL RDT 15	Dummy					•				\$26.70	20
94880-652	488BRNL RDT 26	Dummy						•			\$26.70	20
94880-653	488BRNL RDT 514	Dummy								•	\$28.20	20



Breton SQT

MFG Pro #	Item Description	Function	3	L03	5	11P	15	26	26D	514	List Price	QTY
92001-591	200BRNL SQT 15 6AL RCS	Passage					•				\$53.30	12
92001-592	200BRNL SQT 26 6AL RCS	Passage						•			\$53.30	12
92001-593	200BRNL SQT 514 6AL RCS	Passage								•	\$56.30	12
92001-653	200BRNL SQT 514 6AL RCS 10CT	Passage								•	\$478.50	12
92001-652	200BRNL SQT 514 6AL RCS 4CT	Passage								•	\$202.70	12
93002-019	300BRNL SQT 15 6AL RCS	Privacy					•				\$56.30	12
93002-020	300BRNL SQT 26 6AL RCS	Privacy						•			\$56.30	12
93002-021	300BRNL SQT 514 6AL RCS	Privacy								•	\$59.30	12
93002-946	300BRNL SQT 514 6AL RCS 10CT	Privacy								•	\$504.00	12
93002-945	300BRNL SQT 514 6AL RCS 4CT	Privacy								•	\$213.50	12
94050-652	405BRNL SQT 15 SMT 6AL RCS K4	Entry					•				\$76.80	12
94050-653	405BRNL SQT 26 SMT 6AL RCS K4	Entry						•			\$76.80	12
94050-654	405BRNL SQT 514 SMT 6AL RCS K4	Entry								•	\$79.80	12
94880-602	488BRNL SQT 15	Dummy					•				\$26.70	12
94880-603	488BRNL SQT 26	Dummy						•			\$26.70	12
94880-604	488BRNL SQT 514	Dummy								•	\$28.20	12



Casey RDT

MFG Pro #	Item Description	Function	3	L03	5	11P	15	26	26D	514	List Price	QTY
92001-612	200CSL RDT 15 6AL FD RCS	Passage					•				\$55.80	12
92001-600	200CSL RDT 15 6AL RCS	Passage					•				\$53.30	12
92001-631	200CSL RDT 26 6AL FD RCS	Passage						•			\$55.80	12
92001-645	200CSL RDT 26 6AL RCS	Passage						•			\$53.30	12
92001-613	200CSL RDT 514 6AL FD RCS	Passage								•	\$58.80	12
92001-602	200CSL RDT 514 6AL RCS	Passage								•	\$56.30	12
93002-050	300CSL RDT 15 6AL RCS	Privacy					•				\$56.30	12
93002-051	300CSL RDT 26 6AL RCS	Privacy						•			\$56.30	12
93002-052	300CSL RDT 514 6AL RCS	Privacy								•	\$59.30	12
94050-718	405CSL RDT 15 SMT 6AL RCS K4	Entry					•				\$76.80	12
94050-719	405CSL RDT 26 SMT 6AL RCS K4	Entry						•			\$76.80	12

94050-622	405DL 26D SMT 6AL RCS K4 V1	Entry								•			\$68.00	12
94050-735	405DL 26D SMT 6AL RCS	Entry								•			\$68.00	12
94050-722	405DL 3 SMT 6AL RCS K4 V1	Entry	•										\$68.00	12
94090-011	409DL 15 SMT 23/4SCL SCS UL K4	Entry UL								•			\$78.10	12
94090-012	409DL 15 SMT 23/8SCL SCS UL K4	Entry UL								•			\$78.10	12
94090-013	409DL 26D SMT 23/4SCL SCS UL K4	Entry UL								•			\$74.00	12
94090-014	409DL 26D SMT 23/8SCL SCS UL K4	Entry UL								•			\$74.00	12
94120-001	412DL 26D SMT 23/8SCL 3030 UL K4	Storeroom UL								•			\$77.00	12
94200-027	420DL 15 23/4SCL SCS UL	Passage UL								•			\$57.60	12
94200-028	420DL 15 23/8SCL SCS UL	Passage UL								•			\$57.60	12
94200-029	420DL 26D 23/4SCL SCS UL	Passage UL								•			\$53.50	12
94200-030	420DL 26D 23/8SCL SCS UL	Passage UL								•			\$53.50	12
94620-007	462DL 26 SMT 6AL RCS K4	0								•			\$75.10	12
94620-008	462DL 26D 6AL RCS K4	0								•			\$66.00	12
94620-009	462DL 26D SMT 6AL RCS K4	0								•			\$71.00	12
94880-540	488DL 11P V1	Dummy								•			\$24.30	20
94880-541	488DL 15 V1	Dummy								•			\$24.30	20
94880-542	488DL 26 V1	Dummy								•			\$24.30	20
94880-543	488DL 26D V1	Dummy								•			\$22.30	20

Dorian



MFG Pro #	Item Description	Function	3	L03	5	11P	15	26	26D	514	List Price	QTY
92001-537	200DNL 11P 6AL RCS V1	Passage				•					\$48.60	12
92001-539	200DNL 15 6AL RCS V1	Passage					•				\$48.60	12
93001-894	300DNL 11P 6AL RCS V1	Privacy				•					\$51.60	12
93001-896	300DNL 15 6AL RCS V1	Privacy					•				\$51.60	12
94050-625	405DNL 11P 6AL RCS K4 V1	Entry				•					\$67.10	12
94050-724	405DNL 11P SMT 6AL RCS K4	Entry				•					\$72.10	12
94050-627	405DNL 15 6AL RCS K4 V1	Entry					•				\$67.10	12
94050-628	405DNL 15 SMT 6AL RCS K4 V1	Entry					•				\$72.10	12
94200-031	420DNL 15 2-3/8 SCL SCS UL	Passage UL					•				\$57.60	12
94880-546	488DNL 11P V1	Dummy				•					\$24.30	20
94880-548	488DNL 15 V1	Dummy					•				\$24.30	20

Henley Lever



MFG Pro #	Item Description	Function	3	L03	5	11P	15	26	26D	514	List Price	QTY
92001-624	200HYL 15 6AL RCS	Passage					•				\$53.30	20
92001-625	200HYL 514 6AL RCS	Passage								•	\$56.30	20
93002-938	300HYL 15 6AL RCS	Privacy					•				\$56.30	20
93002-939	300HYL 514 6AL RCS	Privacy								•	\$59.30	20
94050-702	405HYL 15 SMT 6AL RCS K4	Entry					•				\$76.80	20
94050-703	405HYL 514 SMT 6AL RCS K4	Entry								•	\$79.80	20
94880-634	488HYL 15	Dummy					•				\$26.70	20
94880-635	488HYL 514	Dummy								•	\$28.20	20



Ladera RDT

MFG Pro #	Item Description	Function	3	L03	5	11P	15	26	26D	514	List Price	QTY
92001-547	200LRL RDT 15 6AL RCS V1	Passage					•				\$48.60	12
92001-649	200LRL RDT 26 6AL RCS	Passage						•			\$48.60	12
92001-549	200LRL RDT 26D 6AL RCS V1	Passage							•		\$44.50	12
92001-598	200LRL RDT 514 6AL RCS V1	Passage								•	\$51.60	12
93001-903	300LRL RDT 15 6AL RCS V1	Privacy					•				\$51.60	12
93002-055	300LRL RDT 26 6AL RCSV1	Privacy						•			\$51.60	12
93002-056	300LRL RDT 26D 6AL RCSV1	Privacy							•		\$47.50	12
93002-023	300LRL RDT 514 6AL RCS V1	Privacy								•	\$54.60	12
94050-725	405LRL RDT 15 6AL RCS K4 V1	Entry					•				\$67.10	12
94050-633	405LRL RDT 15 SMT 6AL RCS K4 V1	Entry					•				\$72.10	12
94050-726	405LRL RDT 26 SMT 6AL RCS K4 V1	Entry						•			\$72.10	12
94050-727	405LRL RDT 26D 6AL RCS K4 V1	Entry							•		\$63.00	12
94050-635	405LRL RDT 26D SMT 6AL RCS K4 V1	Entry							•		\$68.00	12
94050-670	405LRL RDT 514 SMT 6AL RCS K4 V1	Entry								•	\$75.10	12
94880-659	488LRL RDT 26 LH	Dummy						•			\$24.30	20
94880-660	488LRL RDT 26 RH	Dummy						•			\$24.30	20
94880-661	488LRL RDT 26D LH	Dummy							•		\$22.30	20
94880-662	488LRL RDT 26D RH	Dummy							•		\$22.30	20
94880-555	488LRL RDT LH 15 V1	Dummy					•				\$24.30	20
94880-608	488LRL RDT LH 514 V1	Dummy								•	\$25.80	20
94880-559	488LRL RDT RH 15 V1	Dummy					•				\$24.30	20
94880-607	488LRL RDT RH 514 V1	Dummy								•	\$25.80	20



Ladera SQT

MFG Pro #	Item Description	Function	3	L03	5	11P	15	26	26D	514	List Price	QTY
92001-584	200LRL SQT 15 6AL RCS	Passage					•				\$48.60	12
92001-585	200LRL SQT 26 6AL RCS	Passage						•			\$48.60	12
92001-586	200LRL SQT 26D 6AL RCS	Passage							•		\$44.50	12
92001-597	200LRL SQT 514 6AL RCS	Passage								•	\$51.60	12
93002-010	300LRL SQT 15 6AL RCS	Privacy					•				\$51.60	12
93002-011	300LRL SQT 26 6AL RCS	Privacy						•			\$51.60	12
93002-012	300LRL SQT 26D 6AL RCS	Privacy							•		\$47.50	12
93002-022	300LRL SQT 514 6AL RCS	Privacy								•	\$54.60	12
94050-638	405LRL SQT 15 SMT 6AL RCS K4	Entry					•				\$72.10	12
94050-639	405LRL SQT 26 SMT 6AL RS K4	Entry						•			\$72.10	12
94050-728	405LRL SQT 26D SMT 6AL RCS K4	Entry							•		\$68.00	12
94050-659	405LRL SQT 514 SMT 6AL RCS K4	Entry								•	\$75.10	12
94880-590	488LRL SQT LH 15	Dummy					•				\$24.30	12
94880-591	488LRL SQT LH 26	Dummy						•			\$24.30	12
94880-592	488LRL SQT LH 26D	Dummy							•		\$22.30	12
94880-606	488LRL SQT LH 514	Dummy								•	\$25.80	12
94880-594	488LRL SQT RH 15	Dummy					•				\$24.30	12
94880-595	488LRL SQT RH 26	Dummy						•			\$24.30	12
94880-596	488LRL SQT RH 26D	Dummy							•		\$22.30	12
94880-605	488LRL SQT RH 514	Dummy								•	\$25.80	12



Aliso

MFG Pro #	Item Description	Function	3	L03	5	11P	15	26	26D	514	List Price	QTY
92001-576	200AO 15 6AL RCS V1	Passage					•				\$33.00	30
93001-935	300AO 15 6AL RCS V1	Privacy					•				\$36.20	30
94002-987	400AO 15 SMT 6AL RCS K3	Entry					•				\$47.50	30
94880-578	488AO 15 V1	Dummy					•				\$16.50	20



Cove

MFG Pro #	Item Description	Function	3	L03	5	11P	15	26	26D	514	List Price	QTY
92001-574	200CV 11P 6AL RCS V1	Passage				•					\$33.00	30
92001-572	200CV 15 6AL RCS V1	Passage					•				\$33.00	30
92001-604	200CV 514 6AL RCS V1	Passage								•	\$36.00	30
93001-933	300CV 11P 6AL RCS V1	Privacy				•					\$36.20	30
93001-931	300CV 15 6AL RCS V1	Privacy					•				\$36.20	30
93002-920	300CV 514 6AL RCS V1	Privacy								•	\$39.20	30
94002-988	400CV 11P 6AL RCS K3 V1	Entry				•					\$42.50	30
94002-923	400CV 11P SMT 6AL RCS K3 V1	Entry				•					\$47.50	30
94002-989	400CV 15 6AL RCS K3 V1	Entry					•				\$42.50	30
94002-981	400CV 15 SMT 6AL RCS 56665 LK	Entry					•				\$47.50	30
94002-982	400CV 15 SMT 6AL RCS 64446 LK	Entry					•				\$47.50	30
94002-925	400CV 15 SMT 6AL RCS K3 V1	Entry					•				\$47.50	30
94002-950	400CV 514 SMT 6AL RCS K3 V1	Entry								•	\$50.50	30
94003-100	400CV 11P SMT 6AL RCS	Entry				•					\$47.50	30
94003-098	400CV 15 SMT 6AL RCS	Entry					•				\$47.50	30
94003-099	400CV 514 SMT 6AL RCS	Entry								•	\$50.50	30
94003-101	400CV 514 SMT 6AL RCS 65665 LK	Entry								•	\$50.50	30
94880-576	488CV 11P V1	Dummy				•					\$16.50	20
94880-575	488CV 15 V1	Dummy					•				\$16.50	20
94880-615	488CV 514 V1	Dummy								•	\$18.00	20



Maven

MFG Pro #	Item Description	Function	3	L03	5	11P	15	26	26D	514	List Price	QTY
92001-656	200MNK RDT 15 6AL RCS	Passage					•				\$38.00	30
92001-660	200MNK RDT 26 6AL RCS	Passage						•			\$38.00	30
92001-658	200MNK RDT 514 6AL RCS	Passage								•	\$41.00	30
92001-657	200MNK SQT 15 6AL RCS	Passage					•				\$38.00	30
92001-661	200MNK SQT 26 6AL RCS	Passage						•			\$38.00	30
92001-659	200MNK SQT 514 6AL RCS	Passage								•	\$41.00	30
93002-057	300MNK RDT 15 6AL RCS	Privacy					•				\$41.20	30
93002-061	300MNK RDT 26 6AL RCS	Privacy						•			\$41.20	30
93002-059	300MNK RDT 514 6AL RCS	Privacy								•	\$44.20	30
93002-058	300MNK SQT 15 6AL RCS	Privacy					•				\$41.20	30
93002-062	300MNK SQT 26 6AL RCS	Privacy						•			\$41.20	30
93002-060	300MNK SQT 514 6AL RCS	Privacy								•	\$44.20	30
94003-090	400MNK RDT 15 SMT 6AL RCS K3	Entry					•				\$52.50	30
94003-094	400MNK RDT 26 SMT 6AL RCS K3	Entry						•			\$52.50	30
94003-092	400MNK RDT 514 SMT 6AL RCS K3	Entry								•	\$55.50	30



660 Deadbolt

MFG Pro #	Item Description	Function	3	L03	5	11P	15	26	26D	514	List Price	QTY
96600-722	660 11P RCAL RCS/5303 K3	Single Cyl				•					\$37.70	12
96600-777	660 11P SMT RCAL RCS/5303 56665 LK	Single Cyl				•					\$42.70	12
96600-726	660 11P SMT RCAL RCS/5303 K3	Single Cyl				•					\$42.70	12
96600-831	660 11P SMT RCAL RCS/5303	Single Cyl				•					\$42.70	12
96600-827	660 11P SMT RCALFD RCS/5303 K3	Single Cyl				•					\$45.20	12
96600-532	660 15 RCAL RCS/5303	Single Cyl					•				\$37.70	12
96600-712	660 15 RCAL RCS/5303 K3	Single Cyl					•				\$37.70	12
96600-789	660 15 SCAL SCS K3	Single Cyl					•				\$37.70	12
96600-678	660 15 SMT KCCYL RCAL RCS 4 KC IN BOX	Single Cyl					•				\$42.70	12
96600-575	660 15 SMT RCAL RCS/5303	Single Cyl					•				\$42.70	12
96600-778	660 15 SMT RCAL RCS/5303 33456 LK	Single Cyl					•				\$42.70	12
96600-779	660 15 SMT RCAL RCS/5303 43443 LK	Single Cyl					•				\$42.70	12
96600-780	660 15 SMT RCAL RCS/5303 55444 LK	Single Cyl					•				\$42.70	12
96600-781	660 15 SMT RCAL RCS/5303 55655 LK	Single Cyl					•				\$42.70	12
96600-782	660 15 SMT RCAL RCS/5303 55665 LK	Single Cyl					•				\$42.70	12
96600-783	660 15 SMT RCAL RCS/5303 56665 LK	Single Cyl					•				\$42.70	12
96600-784	660 15 SMT RCAL RCS/5303 65556 LK	Single Cyl					•				\$42.70	12
96600-785	660 15 SMT RCAL RCS/5303 65656 LK	Single Cyl					•				\$42.70	12
96600-786	660 15 SMT RCAL RCS/5303 65665 LK	Single Cyl					•				\$42.70	12
96600-724	660 15 SMT RCAL RCS/5303 K3	Single Cyl					•				\$42.70	12
96600-805	660 15 SMT RCALFD RCS/5303 65665 LK	Single Cyl					•				\$45.20	12
96600-790	660 15 SMT RFAL RCS K3	Single Cyl					•				\$42.70	12
96600-828	660 15 SMT RCAL 5279 23155 LK	Single Cyl					•				\$42.70	12
96600-825	660 15 SMT RCALFD RCS/5303 K3	Single Cyl					•				\$45.20	12
96600-830	660 15 SMT SCAL SCS K3	Single Cyl					•				\$42.70	12
96600-764	660 SMT 15 RCALFD RCS 5303 23155 LESSKEY	Single Cyl					•				\$45.20	12
96600-721	660 26 RCAL RCS/5303 K3	Single Cyl						•			\$37.70	12
96600-775	660 26 SMT RCAL FD RCS 5303 K3	Single Cyl						•			\$45.20	12
96600-787	660 26 SMT RCAL FD RCS/5303 55455 LK	Single Cyl						•			\$45.20	12
96600-705	660 26 SMT RCAL RCS/5303	Single Cyl						•			\$42.70	12
96600-791	660 26 SMT RCAL RCS/5303 K3	Single Cyl						•			\$42.70	12
96600-809	660 26 SMT RCALFD RCS/5303 23155 LK	Single Cyl						•			\$45.20	12
96600-806	660 26 SMT RCALFD RCS/5303 65665 LK	Single Cyl						•			\$45.20	12
96600-483	660 26D RCAL RCS/5303	Single Cyl							•		\$34.70	12
96600-715	660 26D RCAL RCS/5303 K3	Single Cyl							•		\$34.70	12
96600-032	660 26D SCAL SCS	Single Cyl							•		\$34.70	12
96600-714	660 26D SCAL SCS K3 V1	Single Cyl							•		\$34.70	12
96600-776	660 26D SMT RCAL FD RCS 5303 K3	Single Cyl							•		\$42.20	12
96600-576	660 26D SMT RCAL RCS/5303	Single Cyl							•		\$39.70	12
96600-788	660 26D SMT RCAL RCS/5303 55666 LK	Single Cyl							•		\$39.70	12
96600-725	660 26D SMT RCAL RCS/5303 K3	Single Cyl							•		\$39.70	12
96600-810	660 26D SMT RCALFD RCS/5303 23155 LK	Single Cyl							•		\$42.20	12
96600-807	660 26D SMT RCALFD RCS/5303 65665 LK	Single Cyl							•		\$42.20	12
96600-792	660 26D SMT RFAL RCS K3	Single Cyl							•		\$39.70	12

Tylo - Combo Pack



MFG Pro #	Item Description	Function	3	L03	5	11P	15	26	26D	514	List Price	QTY
96900-381	690T 15 SMT BBPKG	Combo Pack					•				\$75.90	30
96900-452	690T 15 V1	Combo Pack					•				\$66.90	30
96900-307	690T 26D RCAL RCS	Combo Pack							•		\$61.50	30
96900-339	690T 26D SMT RCAL RCS	Combo Pack							•		\$70.50	30
96900-305	690T 3 6AL RCS KI BBPKG	Combo Pack	•								\$61.50	30
96900-417	690T 3 CODE RCAL RCS K6 KI V1	Combo Pack	•								\$61.50	30
96900-336	690T 3 SMT 6AL RCS	Combo Pack	•								\$70.50	30
96900-338	690T 5 SMT 6AL RCS	Combo Pack			•						\$70.50	30

GateLatch



MFG Pro #	Item Description	Function	3	L03	5	11P	15	26	26D	514	List Price	QTY
95990-006	599 26D SMT SCL 3028 K3	Double Cyl							•		\$123.40	12

One-Sided 663 Deadbolt



MFG Pro #	Item Description	Function	3	L03	5	11P	15	26	26D	514	List Price	QTY
96630-069	663 15 2-3/8 RCL UL RCS 5303	One Sided					•				\$27.10	12
96630-067	663 15 2-3/8RCL RCS/5303	One Sided					•				\$21.10	12
96630-083	663 15 23/8RFL 5303	One Sided					•				\$21.10	12
96630-090	663 15 2-3/4RCL UL RCS/5303	One Sided					•				\$27.10	12
96630-077	663 26 2-3/8 RCL RCS/5303	One Sided						•			\$21.10	12
96630-070	663 26 2-3/8 RCL UL RCS 5303	One Sided						•			\$27.10	12
96630-071	663 26D 2-3/8 RCL UL RCS 5303	One Sided							•		\$25.40	12
96630-055	663 26D 2-3/8RCL RCS/5303	One Sided							•		\$19.40	12
96630-084	663 26D 23/8RFL 5303	One Sided							•		\$19.40	12
96630-085	663 26D 23/8RFL RCS	One Sided							•		\$19.40	12
96630-089	663 26D 2-3/4RCL UL RCS/5303	One Sided							•		\$25.40	12
96630-078	663 514 2-3/8 RCL RCS/5303	One Sided								•	\$22.80	12
96630-072	663 514 2-3/8 RCL UL RCS 5303	One Sided								•	\$28.80	12
96630-091	663 514 2-3/4RCL UL RCS/5303	One Sided								•	\$28.80	12
96630-085	663 26D 23/8RFL RCS	One Sided							•		\$19.40	12
96630-078	663 514 2-3/8 RCL RCS/5303	One Sided								•	\$22.80	12
96630-072	663 514 2-3/8 RCL UL RCS 5303	One Sided								•	\$28.80	12



One-Sided 664 Deadbolt

MFG Pro #	Item Description	Function	3	L03	5	11P	15	26	26D	514	List Price	QTY
96640-011	664 11P CONV KIT 663 V1	Conversion Kit				•					\$15.10	12
96640-010	664 15 CONV KIT 663 V1	Conversion Kit					•				\$15.10	12
96640-009	664 26D CONV KIT 663 V1	Conversion Kit							•		\$13.90	12
96640-008	664 3 CONV KIT 663 V1	Conversion Kit	•								\$13.90	12



One-Sided 667 Deadbolt

MFG Pro #	Item Description	Function	3	L03	5	11P	15	26	26D	514	List Price	QTY
96670-015	667 11P RCAL RCS/5303	One Sided				•					\$37.70	12
96670-016	667 15 RCAL RCS/5303	One Sided					•				\$37.70	12
96670-017	667 26D RCAL/5303 RCS	One Sided							•		\$37.70	12
96670-017	667 26D RCAL/5303 RCS	One Sided							•		\$37.70	12
96670-018	667 514 RCAL/5303 RCS	One Sided								•	\$40.70	12
96670-018	667 514 RCAL/5303 RCS	One Sided								•	\$40.70	12

KWIKSET HANDLESETS

Door Prep	Deadbolt: Crossbore 2-1/8" or 1-1/2". Edge Bore 1". Handle: Crossbore 2-1/8". Edge Bore 1".
Backset	Deadbolt: Adjustable to 2-3/8" or 2-3/4". Handle: Adjustable to 2-3/8" or 2-3/4".
Door Thickness	1-3/4" doors standard. 2-1/4" doors optional. Not designed for use on 1-3/8" doors.
Cylinder	SmartKey Security or traditional 5-Pin, Pin & Tumbler.
Faceplate	1" x 2-1/4" round corner. Other options available as service parts.
Strikes	Deadbolt: 1" x 2-1/4" round corner. Other options available as service parts Handle: 2-1/4" round corner full lip. Other options available as service parts.
Bolt	Deadbolt: 1" throw. Handle: 1/2" throw.
Door Handing	Reversible for right or left-hand doors.
ANSI/BHMA	Deadbolt is Grade 3 Certified.
ADA	N/A
UL	N/A

KWIKSET LEVERS

Door Prep	Cross Bore 2-1/8". Edge Bore 1".
Backset	Adjustable to 2-3/8" or 2-3/4". UL 2-3/4" standard 2-3/8" optional.
Door Thickness	1-3/8" - 1-3/4" doors standard. 2-1/4" doors optional on 200 and 400 functions only.
Cylinder	SmartKey Security or Pin & Tumbler.
Faceplate	1" x 2-1/4" round corner, square corner and drive-in collar.
Strikes	1" x 2-1/4" round corner. Other options available.
Bolt	1/2" throw.
Door Handing	Specify handing for dummy and interior pack levers.
ANSI/BHMA	Grade 3 Certified. (all functions except 488)
ADA	Functions 200 and 420 in compliance with the American National Standards Institute (ANSI A117.1) and the Americans with Disabilities Act (ADA).
UL	Meets UL 3 hour fire rating for 409, 412, 420 Optional UL 1/3 hour fire rating on select SKUs.

KWIKSET DEADBOLTS

Door Prep	660, 665: Crossbore 2-1/8". Edge Bore 1". 663: Crossbore 1-5/8". Edge Bore 1". 667: Crossbore 2-1/8" or 1-1/2". Edge Bore 1".
Backset	660, 665, 667: Adjustable latch standard. 663: 2-3/8" standard. 2-3/4" optional.
Door Thickness	660, 663, 665, 667: 1-3/8" - 1-3/4" doors standard.
Cylinder	660, 665: SmartKey Security or Pin & Tumbler.
Faceplate	1" x 2-1/4". Specify round corner, square corner or drive-in.
Strikes	1" x 2-1/4". Specify round corner or square corner. Other options available.
Bolt	1" throw.
Door Handing	Reversible for right or left-hand doors.
ANSI/BHMA	Grade 3 Certified.
ADA	Interior turn pieces are in compliance with the American National Standards Institute (ANSI A117.1) and the Americans with Disabilities Act (ADA).
UL	Meets UL 3 hour fire rating for 663 Optional UL 1/3 hour fire rating on select SKUs.

KWIKSET KNOBS

Door Prep	Cross Bore 2-1/8". Edge Bore 1".
Backset	Adjustable to 2-3/8" or 2-3/4". 5" available as service part
Door Thickness	1-3/8" - 1-3/4" doors standard. 2-1/4" doors optional on 200 and 400 models only.
Cylinder	SmartKey Security or Pin & Tumbler.
Faceplate	1" x 2-1/4" round corner, square corner and drive-in collar.
Strikes	1" x 2-1/4" round corner. Other options available.
Bolt	1/2" throw.
Door Handing	Reversible for right or left hand doors.
ANSI/BHMA	Grade 3 Certified. (all functions except 488)
ADA	N/A
UL	N/A

KWIKSET HANDLESET

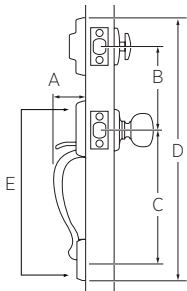

Design	A	B	C	D	E
Amador	2-5/32"	5-1/2"	9-11/16"	17-15/32"	12-14/28"
Belleview™	2-5/32"	5-1/2"	8-13/32"	18-1/16"	12-1/10"
Dakota™	2-5/32"	5-1/2"	8-13/32"	17-3/16"	12-1/10"
Henley	4-5/32"	5-1/2"	8-13/32"	17-5/8"	12-1/4"

KWIKSET KNOB

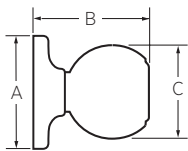

Design	A	B	C
Aliso™	2-5/8"	2-3/4"	2-2/5"
Cove™	2-5/8"	2-1/2"	2-3/16"
Polo™	2-5/8"	2-23/32"	1-7/8"
Tylo™	2-5/8"	2-1/2"	1-7/8"

KWIKSET LEVER

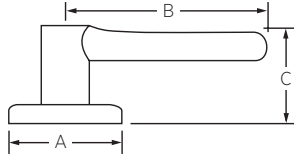

Design	A	B	C	C (Keyed)	Design	A	B	C	C (Keyed)
Balboa™	2-5/8"	4-7/32"	1-15/16"	2-13/32"	Dorian*	2-5/8"	3-3/4"	2-1/8"	2-11/16"
Breton	2-5/8"	4"	2-7/16"	2-15/32"	Henley	2-5/8"	4-3/32"	2-9/16"	2-19/32"
Casey	2-5/8"	4-1/10"	2-3/5"	2-7/16"	Ladera*	2-5/8"	4-3/16"	1-7/8"	2-7/16"
Delta*	2-5/8"	3-5/8"	1-7/8"	2-15/32"					

KWIKSET DEADBOLT

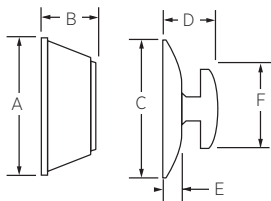

Design	A	B	C	D	E	F
660	2-7/16"	1-1/16"	2-1/2"	2-7/32"	5/16"	1-3/4"
660RDT	2-7/16"	1-1/16"	2-1/2"	3-1/32"	1-3/4"	
660SQT	2-7/16"	1-1/16"	2-1/2"	3-1/32"	1-3/4"	
663		2-1/2"	2-7/32"	5/16"	1-3/4"	
663SQT	2-7/16"	1-1/16"	2-1/2"	3-1/32"	1-3/4"	
665	2-7/16"	1-1/16"	2-1/2"	1-1/16"		
667	2-17/32"	3/8"	2-1/2"	2-7/32"	5/16"	1-3/4"

SMART LOCKS AND KEYLESS ENTRY LOCKS

Kwikset's electronic door locks offer users the convenience of keyless entry, virtually eliminating the need for keys. All of our electronic locks are easy to install and program while complementing any Kwikset knob, lever or handleset.



Features



- Smart Locks Replace any Deadbolt for Keyless Entry Convenience
- SmartCode™ Lever Ideal for - Small/Home Office, Utility/Storage Room, Interior Garage/ Side Door
- Lock Your Door with the Touch of a Button
- Customizable Access Codes for Increased Security
- Back-Lit Keypad for Increased Visibility
- Customizable Automatic Door Locking After 30 Seconds for Peace Of Mind
- Installs In Minutes with Just a Screwdriver - No Hard Wiring Required
- Fits Standard Doors (1 3/8" - 2") with No Screw Holes Required

Warranty

- 1 Year Electronic Warranty
- Lifetime Finish & Mechanical Warranty

Kwikset



HALO SELECT™

WI-FI AND MATTER ENABLED SMART LOCK

Meet the smart lock that brings convenience, intelligence and security to your front door. Control Halo Select™ from anywhere using Wi-Fi and the full-featured Kwikset® app, or easily integrate it into your favorite smart home ecosystem with a compatible Matter hub. Enjoy the freedom and flexibility of remote access, keyless entry and customizable access codes for all your family's needs.

HALO™

TOUCH
FINGERPRINT SMART LOCK



The Halo Touch Wi-Fi enabled smart lock with fingerprint access technology allows you to simply use your unique fingerprint to lock and unlock your door.

HALO™

WI-FI ENABLED SMART LOCKS



Halo smart locks connect directly to your existing home Wi-Fi network and smartphone to create a simple and secure smart home, without a third-party hub, panel or subscription service.



Works with the
Kwikset App



Halo Select



Model	Function	Case		
		15	514	Qty
998000-001	9800 WIFI THRD TSCR 15 SMT TPR RCALFD	\$545.00		1
998000-002	9800 WIFI THRD TSCR 514 SMT TPR RCALFD		\$545.00	1

Halo Wi-Fi Enabled Smart Locks



Model	Function	Finish				Qty
		11P	15	26	514	
99390-001	939 WIFI TSCR 15 SMT TPR RCALFD		\$504.00			1
99390-002	939 WIFI TSCR 11P SMT TPR RCALFD	\$504.00				1
99390-003	939 WIFI TSCR 26 SMT TPR RCALFD			\$504.00		1
99390-004	939 WIFI TSCR 514 SMT TPR RCALFD				\$504.00	1
99380-001	938 WIFI KYPD 15 SMT TPR RCALFD		\$438.00			1
99380-002	938 WIFI KYPD 11P SMT TPR RCALFD	\$438.00				1
99380-003	938 WIFI KYPD 514 SMT TPR RCALFD				\$438.00	1
99590-001	959 TRL FPRT WIFI 15 RCAL RCS		\$517.00			1
99590-002	959 TRL FPRT WIFI 11P RCAL RCS	\$517.00				1
99590-003	959 CNT FPRT WIFI 15 RCAL RCS		\$517.00			1
99590-004	959 CNT FPRT WIFI 514 RCAL RCS				\$517.00	1

How it Works

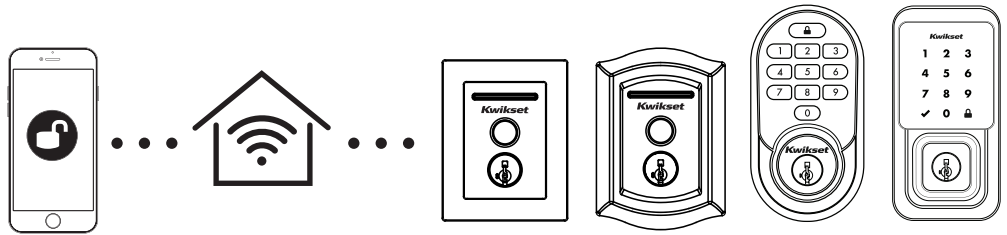

Control your lock from your smartphone

Check the current status of your lock and know your home is secure

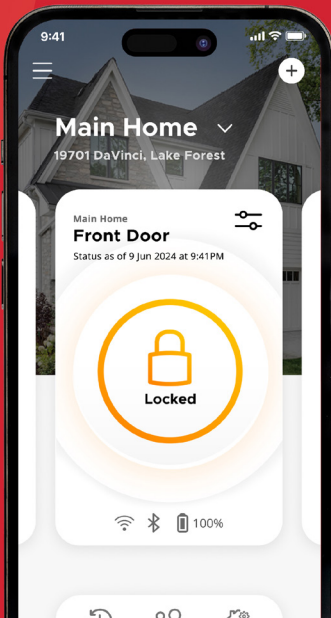

Schedule access windows or share one-time codes with guests

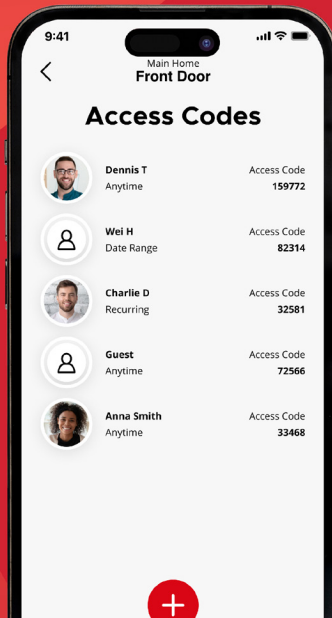

Review your lock history and see what's happening while you're away

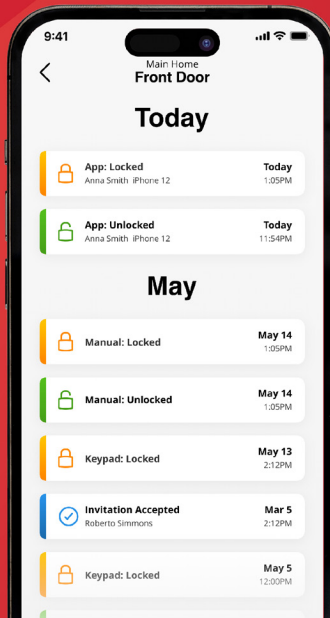

Add additional locks and homes for a complete security solution

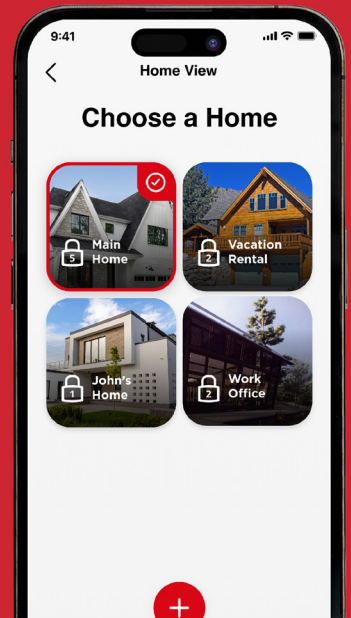



Aura™



**Powerbolt
240 TRL**



**Powerbolt
240 CNT**



**Powerbolt
250 TRS**



**SmartCode™
260 TRL**



**SmartCode™
260 CNT**

Aura™

Model	Description	3	L03	5	11P	15	26	26D	514	QTY
942 BLE	Touchscreen Electronic Deadbolt				\$328.00	\$328.00			\$328.00	2

Powerbolt 240 TRL

MFG Pro #	Item Description	3	L03	5	11P	15	26	26D	514	QTY
992400-001	9240 TRL L03 RBP 4AL RCS		\$100.00							2
992400-002	9240 TRL 15 RBP 4AL RCS					\$100.00				2
992400-003	9240 TRL 11P RBP 4AL RCS				\$100.00					2
992400-012	9240 TRL 514 RBP 4AL RCS								\$100.00	2

Powerbolt 240 CNT

MFG Pro #	Item Description	3	L03	5	11P	15	26	26D	514	QTY
992400-004	9240 CNT 15 RBP 4AL RCS					\$100.00				2
992400-005	9240 CNT 514 RBP 4AL RCS								\$100.00	2

Powerbolt 250 TRS

MFG Pro #	Item Description	3	L03	5	11P	15	26	26D	514	QTY
992500-001	9250 TRS L03 SMT RBP 4AL RCS		\$143.00							2
992500-002	9250 TRS 15 SMT RBP 4AL RCS					\$143.00				2
992500-003	9250 TRS 11P SMT RBP 4AL RCS				\$143.00					2
992500-004	9250 TRS 514 SMT RBP 4AL RCS								\$143.00	2

SmartCode™ 260 TRL

MFG Pro #	Item Description	3	L03	5	11P	15	26	26D	514	QTY
992600-001	9260 TRL L03 SMT RBP RCALFD		\$231.00							2
992600-002	9260 TRL 15 SMT RBP RCALF					\$231.00				2
992600-003	9260 TRL 11P SMT RBP RCALFD				\$231.00					2

SmartCode™ 260 CNT

MFG Pro #	Item Description	3	L03	5	11P	15	26	26D	514	QTY
992600-004	9260 CNT 15 SMT RBP RCALFD					\$231.00				2
992600-005	9260 CNT 26 SMT RBP RCALFD						\$231.00			2
992600-006	9260 CNT 514 SMT RBP RCALFD								\$231.00	2



**SmartCode™
270 TRL**



**SmartCode™
270 CNT**



**SmartCode™
917 TNL**



**SmartCode™
917 HFL**



**SmartCode™
955 Pembroke**



**SmartCode™
955 Kingston**

SmartCode™ 270 TRL

Model	Description	3	L03	5	11P	15	26	26D	514	QTY
992700-002	9270 TRL 15 SMT RBP RCALFD					\$275.00				2
992700-003	9270 TRL 11P SMT RBP RCALFD				\$275.00					2
992700-012	9270 TRL 514 RBP 4AL RCS								\$275.00	2

SmartCode™ 270 CNT

MFG Pro #	Item Description	3	L03	5	11P	15	26	26D	514	QTY
992700-004	9270 CNT 15 SMT RBP RCALFD					\$275.00				2
992700-005	9270 CNT 514 SMT RBP RCALFD								\$275.00	2

SmartCode™ 917 TNL

MFG Pro #	Item Description	3	L03	5	11P	15	26	26D	514	QTY
917 TNL	Touchpad Electronic Lever Tustin				\$262.00	\$262.00				2

SmartCode™ 917 HFL

MFG Pro #	Item Description	3	L03	5	11P	15	26	26D	514	QTY
917 HFL	Touchpad Electronic Lever Halifax				\$262.00		\$262.00		\$262.00	2

SmartCode™ 955 Pembroke

Model	Description	3	L03	5	11P	15	26	26D	514	QTY
99550-001	955PML 26D SMT CP							\$237.00		1
99550-002	955PML 15 SMT CP					\$237.00				1
99550-003	955PML 11P SMT CP				\$237.00					1
99550-004	955PML 514 SMT CP								\$237.00	1

SmartCode™ 955 Kingston

Model	Description	3	L03	5	11P	15	26	26D	514	QTY
99550-005	955KNL 15 SMT RBP					\$237.00				1
99550-006	955KNL 26D SMT RBP							\$237.00		1
99550-007	955KNL 514 SMT RBP								\$237.00	1



**HOME
CONNECT™**
ELECTRONIC SMART LOCKS

Control your lock from anywhere on your smart phone, tablet, or internet connected device and never worry about forgetting to lock your door again.

- Remotely lock and unlock your door from anywhere
- Receive notifications of your lock's activity
- Control when others have access to your home
- Arm or disarm your security panel
- Wirelessly communicate to other devices in your home



Features

- Full 128-Bit Encryption Security
- Motorized locking mechanism enables true remote locking & unlocking
- SmartKey Security - providing superior security against advanced break-in techniques.
- Easy Integration
- Z-Wave Wireless Protocol
- Fits Standard Doors (1 3/8"-2") with No Screw Holes Required
- 4 AA Alkaline Batteries (no hard wiring) - batteries last for approximately 1 year

Electronic Locks with Home Connect (Z-Wave)

Item Number	Function	Finish						Case Qty.	Price
		LO3	11P	15	26	26D	514		
HomeConnect 620 Traditional		LO3	11P	15	26	26D	514		
98930-001	HC620 TRL ZW700 15 SMT RCALFD RCS BP			•				1	\$297.00
98930-002	HC620 TRL ZW700 11P SMT RCALFD RCS BP		•					1	\$297.00
98930-003	HC620 TRL ZW700 LO3 SMT RCALFD RCS BP	•						1	\$297.00

*Product must be ordered by item number and not description

Item Number	Function	Finish						Case Qty.	Price
		LO3	11P	15	26	26D	514		
HomeConnect 620 Contemporary		LO3	11P	15	26	26D	514		
98930-004	HC620 CNT ZW700 15 SMT RCALFD RCS BP			•				1	\$297.00
98930-005	HC620 CNT ZW700 11P SMT RCALFD RCS BP		•					1	\$297.00
98930-006	HC620 CNT ZW700 26 SMT RCALFD RCS BP				•			1	\$297.00
98930-007	HC620 CNT ZW700 514 SMT RCALFD RCS BP						•	1	\$297.00

*Product must be ordered by item number and not description

Item Number	Function	Finish						Case Qty.	Price
		LO3	11P	15	26	26D	514		
SmartCode™ 916 Contemporary with Home Connect		LO3	11P	15	26	26D	514		
99160-041	916CNT 500 15 SMT CP TPR RCALFD V2			•				1	\$506.00
99160-042	916CNT 500 11P SMT CP TPR RCALFD V2		•					1	\$506.00
99160-043	916CNT 500 26 SMT CP TPR RCALFD V2				•			1	\$506.00
99160-044	916CNT 500 514 SMT CP TPR RCALFD V2						•	1	\$506.00

*Product must be ordered by item number and not description

Item Number	Function	Finish						Case Qty.	Price
		LO3	11P	15	26	26D	514		
SmartCode™ 916 with Home Connect		LO3	11P	15	26	26D	514		
99160-038	916TRL 500 15 SMT CP TPR RCALFD V2			•				1	\$506.00
99160-039	916TRL 500 11P SMT CP TPR RCALFD V2		•					1	\$506.00

*Product must be ordered by item number and not description

Item Number	Function	Finish						Case Qty.	Price
		LO3	11P	15	26	26D	514		
SmartCode™ 912 with Home Connect		LO3	11P	15	26	26D	514		
99120-037	912TNL ZW500 15 RCALFD			•				1	\$413.00
99120-038	912TNL ZW500 11P RCALFD		•					1	\$413.00

*Product must be ordered by item number and not description





UNITE

Experience convenience, connectivity and seamless access control with the Kwikset UNITE™ EAC Platform. Electronic locks, cloud-based web and mobile software, smart credentials and smart reader controllers work together to deliver a simple yet comprehensive solution for managing your multifamily property.

Kwikset UNITE™ Electronic Locks

Kwikset UNITE™ electronic locks are the smart multifamily property upgrade for your mechanical locks.

Kwikset UNITE™ Electronic Locks provide multifamily property managers and tenants with a convenient, stylish and efficient way to manage resident door access. They come in a standard lock and interconnect variant and can be controlled by mobile, desktop or physical credentials (fob or card). Kwikset's trusted electronic locks and intuitive software platform offer a cohesive, simple and seamless access control experience.



3 Easy Ways to Engage

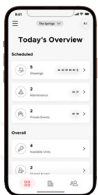

Phone App

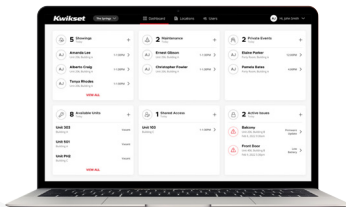

Desktop Portal



Card/FOB

Kwikset UNITE



Item Number	Family	Finish					Case Qty.
		15	26	26D	514	Mixed	
Deabолts							
1000 FD 4L STRKP KS	Unit Entry Deadbolt	\$516.00	\$516.00	\$516.00	\$516.00	\$516.00	2

*Product must be ordered by item number and not description

Item Number	Family	Finish					Case Qty.
		15	26	26D	514	Mixed	
Interconnect							
1100BRNL FD 4L STRKP KS	Breton	\$768.00	\$768.00	\$768.00	\$768.00	\$768.00	2
1100DL FD 4L STRKP KS	Delta	\$768.00	\$768.00	\$768.00	\$768.00	\$768.00	2
1100HFL FD 4L STRKP KS	Halifax	\$768.00	\$768.00	\$768.00	\$768.00	\$768.00	2
1100HRL FD 4L STRKP KS	Halifax RTD	\$768.00	\$768.00	\$768.00	\$768.00	\$768.00	2
1100KNL FD 4L STRKP KS	Kingston	\$768.00	\$768.00	\$768.00	\$768.00	\$768.00	2

*Product must be ordered by item number and not description

Item Number	Family	Finish					Case Qty.
		15	26	26D	514	Mixed	
Encoder Mount							
KS 1000 FD 4L Encoder Mount		\$650.00		•			1

*Product must be ordered by item number and not description

Physical Credentials							List
KS DF EV3 & Prox Access Card	942100-001						\$11.70
KS DF EV3 & Prox Fob	941100-001						\$17.25
Construction Master Card	942330-001						\$11.70
Construction User Card	942420-001						\$11.70

*Product must be ordered by item number and not description

Software							List
Kwikset UNITE Software	950000-001						\$9,700.00

*Product must be ordered by item number and not description

Mobile Invitations							List
50 Invitation Bundle	951100-001						\$900.00
250 Invitation Bundle	951200-001						\$4,050.00
500 Invitation Bundle	951300-001						\$7,200.00
1000 Invitation Bundle	951400-001						\$10,800.00

Kwikset UNITE™ 1000 Series Deadbolt and Kwikset UNITE™ 1100 Series Interconnect

Mechanical Specifications	
Deadbolt & Interconnect	
Materials	All-metal chassis and escutcheon
Door thickness	1 3/8" to 1 3/4" (thick kits available up to 2 1/4" for DB, up to 2" for IC)
Backsets	Deadbolts and latches (IC) adjustable to fit 2 3/8" or 2 3/4" backsets
Latch Plates	1" x 2 1/4" square & round corner (round standard, square in box)
Deadbolt	Manual Throw Deadbolt 1" (25 mm) tapered throw
Deadbolt Strike Package	Round & Square corner, 1 1/8" x 2 3/4" Round & Square corner, Full lip, 1 3/4" x 2 1/4" (lip length: 1 7/64") Additional options available.
Bore	2 1/8"
Stile Width	Minimum 4 1/2" stile for 2 3/8" backset, minimum 5" stile for 2 3/4" backset
Battery Cover	Snap-to-Secure cover. No tools required.
Thumb-turn	Spring-loaded return to vertical
Interconnect Only	
Interconnect Size	5.5" and 4.0" CTC (center to center)
Anti-microbial	Microban™ on all levers (IC). Excluding 26 & 26D
Lever Strike Package (IC Only)	Square corner, T-strike, box, 1 1/8" x 2 3/4" Full Lip Square Corner, 1 3/4" x 2 1/4" Full Lip 1/4" Round Corner, 1 3/4" x 2 1/4" Additional options available
Handing	Field reversible (1100 IC)

Electronic Specifications	
Users Capacity	Up to 500 users per lock (additional users with software)
Audits Capacity	Up to 1000 events
Visual and Audible Communications	Exterior LED (red, amber, green) and Audible indicators
Wake-up	Responds to host command in <5 seconds
Communication	BLE Bluetooth RFID (built-in reader)
Connectivity options	Mobile (send updates at the lock) No-Tour with enroll reader & smart credential Off-line No touring: Mobile/app shares updates w/ lock
Available status signals	Battery status
Power	4 AA Batteries Easy access 9v Back-up ports Battery Life: 18 months
OTA Firmware Upgrades	Available
Memory	Non-volatile memory: Retains data w/battery removed
Diagnostics	Diagnostics with software
Operating humidity	0 - 100% non-condensing
Operating Temperature	Exterior: -31° to 185°F (-35° to 85°C) Interior: 32° to 130°F (0° to 54°C)

Certifications	Warranty
1000 DB: ANSI/BHMA A156.36 Grade 2.	Mechanical and Finish: Limited Lifetime
1100 IC: ANSI/BHMA A156.12 Grade 2	Electronics: 2-year limited electronics
ANSI/BHMA A156.25.	
Industry Canada RSS-247.	
ADA compliant - ANSI A117.1	
UL 90 minute, Canada UL 20-minute wood door rated	
Florida Building Code HVHZ	
FCC Certification 15C & CE: RE 2014/53/EU	
AES-256 Bit encryption	

Deadbolt Model #: 1000

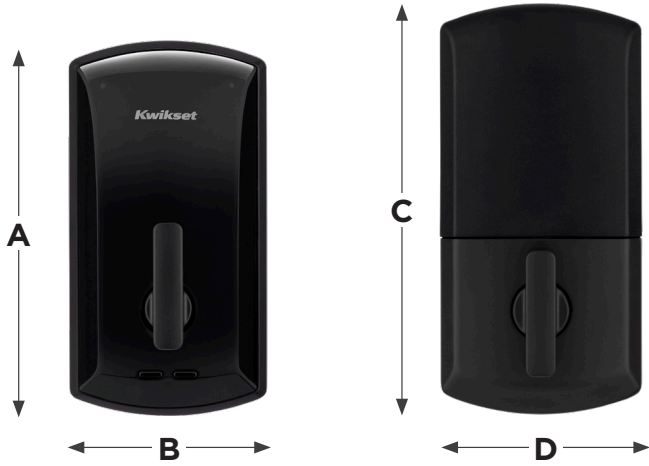

Design	A	B	C	D
Deadbolt	5 11/32"	2 27/32"	5 21/32"	2 27/32"

Interconnect Model #: 1100

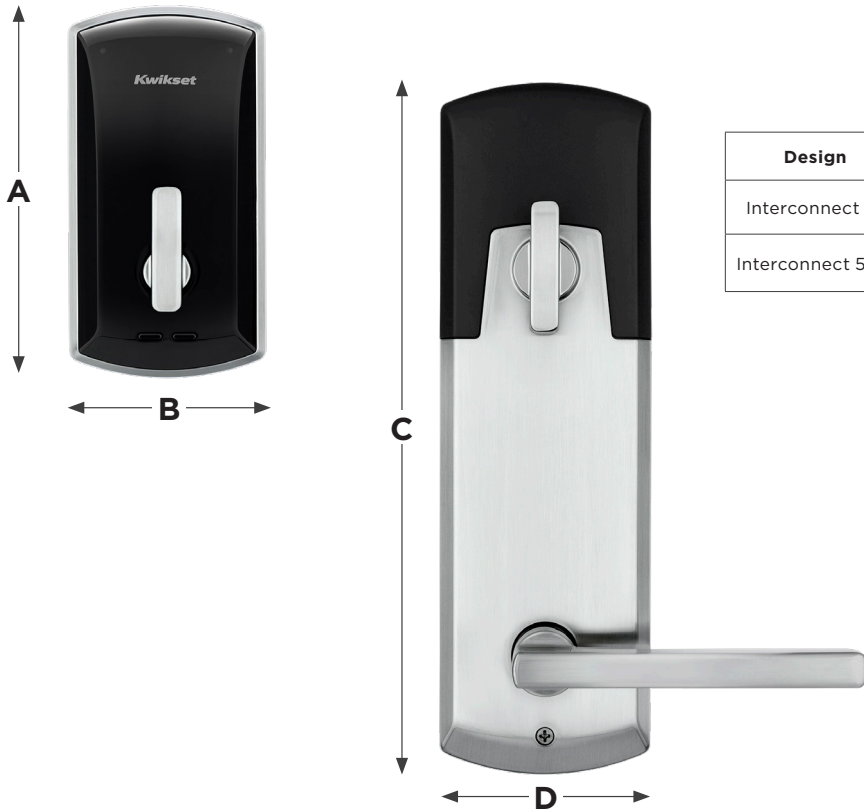

Design	A	B	C	D
Interconnect 4"	5 11/32"	2 27/32"	8 1/4"	3"
Interconnect 5 1/2"	5 11/32"	2 27/32"	9 3/4"	3"

Halo™, Halo™ Touch

Function	Single cylinder deadbolt
Door Prep	2 1/8" diameter bore hole & 1" diameter latch hole
Backset	Adjustable 2 3/8" or 2 3/4"
Door Thickness	1 3/8" - 2" automatic adjustment
Faceplates	1" x 2 1/4" round corner standard
Strikes	Round corner, 4 hole strike, 2 3/4" x 1 1/8"
Latch	Round corner adjustable 2 3/8" x 2 3/4"
Bolt	1" throw, steel deadbolt
Door Handing	Reversible
Cylinder	SmartKey Security™

SMARTCODE™ 912 LEVER

Door Prep	2-1/8" diameter face hole & 1" diameter latch hole
Backset	Adjustable to 2-3/8" or 2-3/4"
Door Thickness	1-3/8" to 2" automatic adjustment
Cylinder	SmartKey Security
Faceplate	1" x 2-1/4". Round corner standard
Strikes	2-1/4" full lip. Round corner
Bolt	1/2" throw
Door Handing	Reversible
Batteries	4 AA Alkaline
Wireless Communication	Z-Wave wireless technology
Operation	908.42 MHz (US)
Range	Typical 100ft line of sight

HomeConnect™ 620

Electrical:	
Input Power	6V (4 x AA alkaline batteries)
Mechanical:	
Door Prep	1 1/2" & 2 1/8" diameter bore hole & 1" deep latch hole
Backset	Adjustable 2 3/8" or 2 3/4"
Door Thickness	1 3/8" - 2" automatic adjustment
Faceplates	1" x 2 1/4" round corner standard
Strikes	Round corner strike 1 1/8" x 2 3/4"
Latch	Round corner adjustable 2 3/8" x 2 3/4"
Bolt	1" throw, steel deadbolt
Door Handing	Reversible
Cylinder	SmartKey® Keyway
Environmental:	
Temperature Range	Exterior: -40°F to 150°F Interior: 32°F to 140°F
Humidity	Exterior: 100% condensing Interior: 30% - 95% non-condensing

SMARTCODE™ 916

Function	Single cylinder deadbolt
Door Prep	2-1/8" or 1-1/2" diameter face hole & 1" diameter latch hole
Backset	Adjustable to 2-3/8" or 2-3/4"
Door Thickness	1-3/8" to 2-1/8" automatic adjustment
Cylinder	SmartKey Security
Faceplates	1" x 2-1/4" round corner standard
Strikes	Round corner, 4 hole strike, 2-3/4" x 1-1/8"
Latch	Round corner adjustable 2-3/8" or 2-3/4"
Bolt	1" throw, steel deadbolt
Door Handing	Reversible
Batteries	4 AA Required
Wireless Communication	Z-Wave wireless technology
Operation	908.42 MHz (US)
Range	Typical 100ft line of sight

AURA™ DEADBOLT

Door Prep	2-1/8" diameter face hole & 1" diameter latch hole
Backset	Adjustable to 2-3/8" or 2-3/4"
Door Thickness	1-3/8" to 2" automatic adjustment
Cylinder	SmartKey Security
Faceplate	1" x 2-1/4". Round corner standard
Strikes	2-3/4" x 1-1/8". Round corner 4 hole strike
Bolt	1" throw
Door Handing	Reversible
Batteries	4 AA Alkaline

POWERBOLT 240/250

Power	6V, 4 x AA alkaline batteries, 12-month battery life (batteries not included)
Door Prep	1-1/2" or 2-1/8" diameter cross bore hole and 1" diameter edge bore hole
Latch Backset	Adjustable 2-3/8" or 2-3/4"
Door Thickness	1-3/8" to 1-3/4" standard. Service part available for 2-1/4" thick doors.
Faceplates	1" x 2-1/4" round corner faceplate with drive-in collar standard
Strike	2-3/4" x 1-1/8" round corner 2-hole strike
Bolt	1" throw, steel bolt
Door Handing	Reversible for right or left-hand doors
Cylinder (240)	KW1 P&T cylinder
Cylinder (250)	SmartKey Security™ KW1 cylinder
UL Rated	N/A
Security	Deadbolt: A156.36 Grade 3 Certified
Temperature Range	Exterior: -40F to 150F, Interior: 32F to 130F
Humidity	Exterior: 100% condensing, Interior: 30% to 95% non-condensing
Warranty	Lifetime Limited Mechanical and Finish Warranty One Year Limited Electronics Warranty

SMARTCODE™ 917

Function	Keyed entry electronic lever
Door Prep	Cross Bore 2- 1/8". Edge Bore 1".
Backset	2 3/8" or 2 3/4"
Door Thickness	1 3/8" - 1 3/4"
Faceplates	1" x 2 1/4" round corner standard, drive in available
Strikes	2 1/4" full lip round corner
Latch	Adjustable 2 3/8" x 2 3/4"
Bolt	1/2" throw, dead latch
Door Handing	Reversible for right or left-handed doors
Cylinder	SmartKey Security™
UL Rating	20 min
Temperature Range	Exterior: -40F to 150F Interior: 32F to 130F
Humidity	Exterior: - 100% condensing Interior: 30% - 95% non-condensing

SMARTCODE™ 260/270

Battery	Uses 4 x AA 6V alkaline cell batteries with approximately 1 year battery life
Function	Single cylinder deadbolt
Door Prep	1 1/2" (38mm) or 2 1/8" (54mm) diameter cross bore hole and 1" diameter edge bore hole
Backset	Adjustable 2 3/8" (60mm) or 2 3/4" (70mm)
Door Thickness	1 3/8" (35mm) to 1 3/4" (44mm) standard. Thick door service part available for 2-1/4" (57mm) thick doors
Faceplates	1" (25 mm) x 2 1/4" (57 mm) round corner faceplate with drive-in collar standard
Strikes	2 3/4" (70mm) x 1 1/8" (29mm) round corner 4 hole strike
Bolt	1" (25mm) throw, steel bolt with anti-saw security pin
Door Handing	Reversible
Cylinder	SmartKey Security™ with 2 KW1 keys
Temperature Range	Exterior: -40°F to 150°F (-40°C to 66°C) Interior: 32°F to 130°F (0°C to 54°C)
Humidity	Exterior: 100% condensing Interior: 30% to 95% non-condensing
Codes	Up to 50 user codes and 10 one-time user codes with optional programming code

AURA

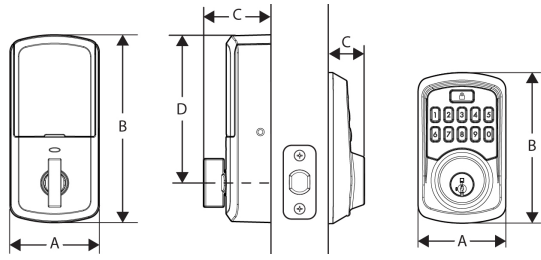

Design	A	B	C	D
Outer Trim	2 3/4"	5 13/16"	2 1/8"	4 9/16"
Inner Trim	2 23/32"	4 5/8"	1 3/16"	---

HALO TOUCH

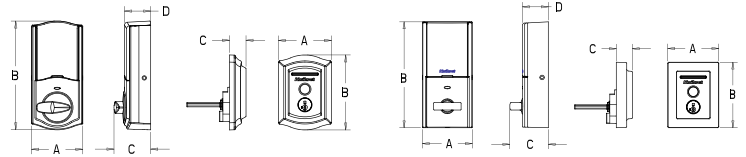

TRL	A	B	C	D	CNT	A	B	C	D
Interior	2 22/32"	5 25/32"	1 15/16"	1 7/16"	Interior	2 22/32"	5 25/32"	2 2/32"	1 13/32"
Exterior	2 13/16"	3 31/32"	7/8"	---	Exterior	2 28/32"	3 9/16"	7/8"	---

HALO TOUCHSCREEN

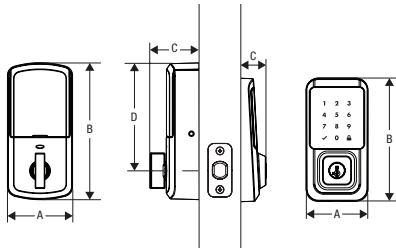

Design	A	B	C	D
Interior	2 3/4"	5 13/16"	2 1/8"	4 9/16"
Exterior	2 28/32"	5 5/8"	1 3/16"	---

HALO KEYPAD

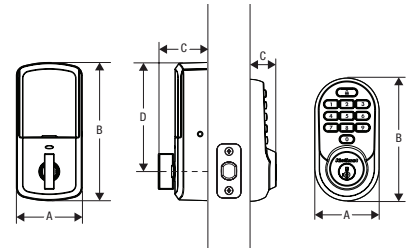

Design	A	B	C	D
Interior	2 3/4"	5 13/16"	2 1/8"	4 9/16"
Exterior	2 28/32"	5 15/32"	1 3/16"	---

SMARTCODE™ 917 TNL

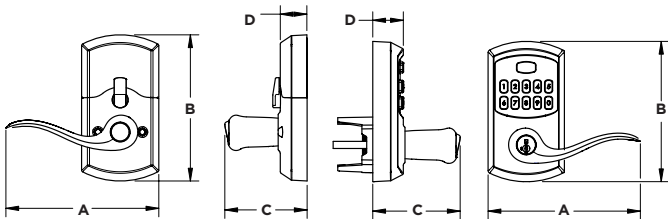

Design	A	B	C	D
Outer Trim	5 9/32"	5 5/32"	3 3/32"	1 1/8"
Inner Trim	5 5/8"	5 3/8"	2 29/32"	3 1/32"

SMARTCODE™ 917 HNL

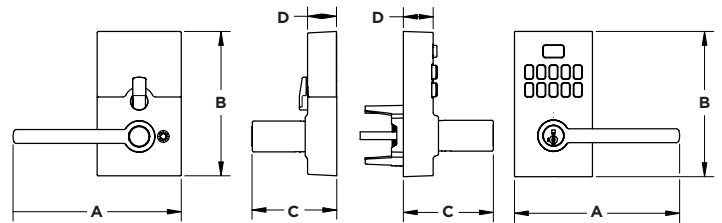

Design	A	B	C	D
Outer Trim	5 9/16"	4 29/32"	3 1/32"	1"
Inner Trim	5 1/32"	4 7/8"	2 27/32"	3 1/32"

SMARTCODE™ 916

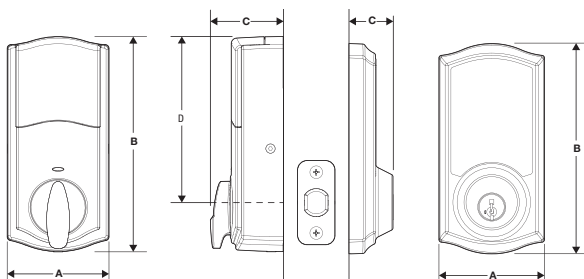

Design	A	B	C	D
Outer Trim	2-13/16"	5-3/8"	1-3/16"	
Inner Trim	2-3/4"	5-3/4"	1-15/16"	4-9/16"

SMARTCODE™ 916 CNT

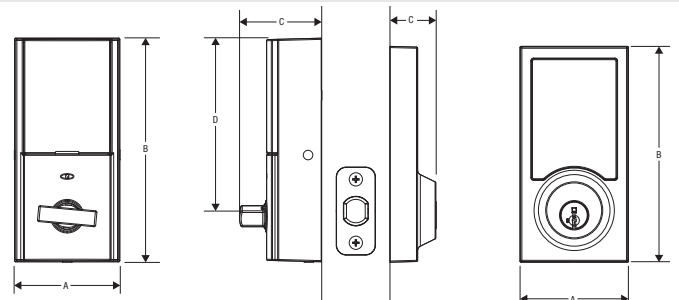

Design	A	B	C	D
Outer Trim	2 11/16"	5 3/4"	2 3/32"	4 9/16"
Inner Trim	2 25/32"	5 7/32"	1 13/16"	---

SMARTCODE™ 912

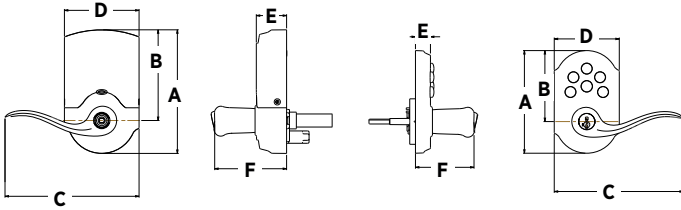

Design	A	B	C	D	E	F
Outer Trim	4 7/16"	3 1/16"	5 19/32"	2 13/16"	2 1/32"	2 17/32"
Inner Trim	5 11/32"	3 15/16"	5 13/16"	3 1/4"	1 5/16"	3 1/8"

SMARTCODE™ 260 TRL

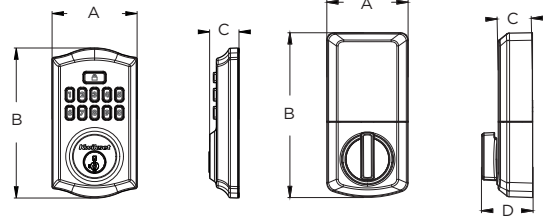

Design	A	B	C	D
Outer Trim	2 13/16"	5"	1"	
Inner Trim	2 3/4"	5 1/2"	1 1/8"	1 1/16"

SMARTCODE™ 260 CNT

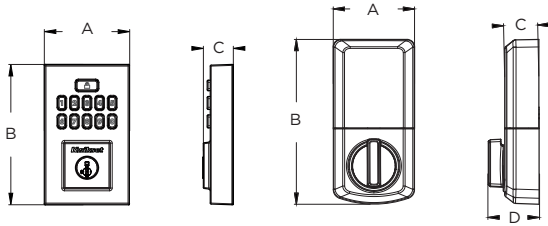

Design	A	B	C	D
Outer Trim	2 3/4"	4 9/16"	1"	
Inner Trim	2 3/4"	5 1/2"	1 1/8"	1 11/16"

SMARTCODE™ 270 TRL

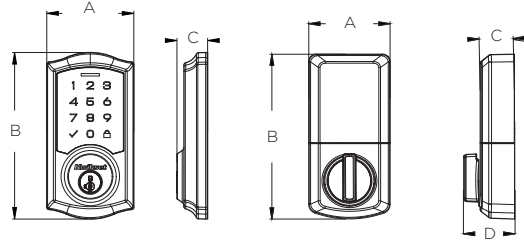

Design	A	B	C	D
Outer Trim	2 3/4"	5 3/16"	1"	
Inner Trim	2 3/4"	5 1/2"	1 1/8"	1 11/16"

SMARTCODE™ 270 CNT

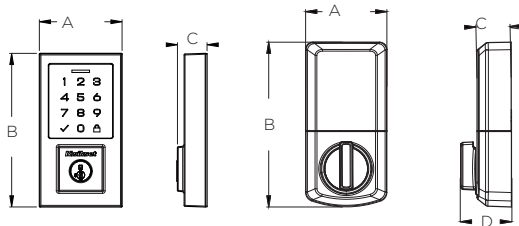

Design	A	B	C	D
Outer Trim	2 3/4"	5 3/16"	1"	
Inner Trim	2 3/4"	5 1/2"	1 1/8"	1 11/16"

POWERBOLT™ 250 TRS

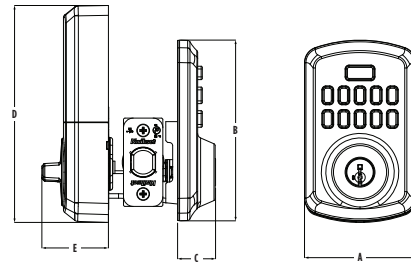

Design	A	B	C	D	E
250 TRS	2 13/16"	4 19/32"	3 1/32"	5 1/2"	1 11/16"

POWERBOLT 240 CNT

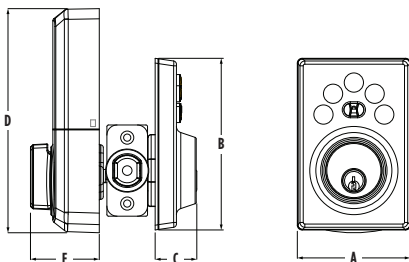

Design	A	B	C	D	E
240 TRL	2 25/32"	4 7/32"	1 1/32"	5 1/2"	1 11/16"

POWERBOLT 240 TRL

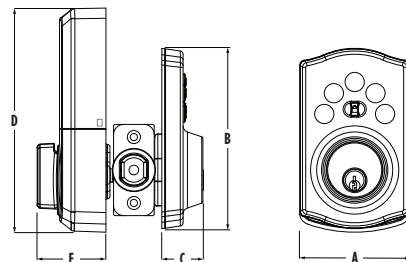

Design	A	B	C	D	E
240 TRL	2 25/32"	4 7/16"	1 1/32"	5 1/2"	1 11/16"

1921423-11/24

KEY CONTROL™ DEADBOLT

THE SMART ALTERNATIVE TO MASTER KEYING IN A NEW CONTEMPORARY STYLE

Re-keying & managing a traditional master key system is labor intensive, time consuming & costly. With the first & only two cylinder Key Control Deadbolt, either cylinder can be re-keyed in seconds, without removing the lock from the door.

Key Control

- Two separate cylinders, Tenant & Property Manager, allows for more tenant key cuts than a traditional master key system
- New proprietary keyway adds security - the tenant key will never fit into the Property Manager Cylinder
- The Property Manager Cylinder is concealed when not in use to avoid tenant confusion

Increased Efficiency

- Re-key the lock without removing from the door
- Save time & money by re-keying yourself
- Maintain key control throughout tenant and employee turnover



Perfect for multi-family dwellings, student housing, assisted living & rental properties.





Carson

MFG Pro #	Item Description	Function	3	L03	5	11P	15	26	26D	514	List Price
94070-005	407CNL 11P RCAL UL 3031	Passage				•					\$47.70
94070-001	407CNL 15 RCAL UL 3031	Passage					•				\$47.70
94070-002	407CNL 26D RCAL UL 3031	Passage							•		\$42.70
94070-004	407CNL 514 RCAL UL 3031	Passage								•	\$50.70
94080-005	408CNL 11P RCAL UL 3031	Privacy				•					\$51.70
94080-001	408CNL 15 RCAL UL 3031	Privacy					•				\$51.70
94080-002	408CNL 26D RCAL UL 3031	Privacy							•		\$46.70
94080-004	408CNL 514 RCAL UL 3031	Privacy								•	\$54.70
94380-005	438CNL 11P SMT RCAL UL 3031 23155 NO KEY	Entry				•					\$77.40
94380-010	438CNL 15 SMT RCAL UL 3031	Entry					•				\$77.40
94380-001	438CNL 15 SMT RCAL UL 3031 23155 LESSKEY	Entry					•				\$77.40
94380-002	438CNL 26D SMT RCAL UL 3031 23155LESSKEY	Entry							•		\$72.40
94380-004	438CNL 514 SMT RCAL UL 3031 23155 NO KEY	Entry								•	\$80.40
94390-005	439CNL 11P SMT RCAL UL 3031 23155 NO KEY	Storeroom				•					\$80.40
94390-001	439CNL 15 SMT RCAL UL 3031 23155 LESSKEY	Storeroom					•				\$80.40
94390-002	439CNL 26D SMT RCAL UL 3031 23155LESSKEY	Storeroom							•		\$75.40
94390-004	439CNL 514 SMT RCAL UL 3031 23155 NO KEY	Storeroom								•	\$83.40
94880-663	488CNL 11P	Dummy				•					\$23.90
94880-628	488CNL 15	Dummy					•				\$23.90
94880-629	488CNL 26D	Dummy							•		\$21.40

Contemporary Interconnect Levers - 780 Deadbolt Options Hali RDT



MFG Pro #	Item Description	Function	3	L03	5	11P	15	26	26D	514	List Price
95080-026	508HRL RDT 15 SMT 23/4RCL 5279 23155 LK	Interconnect					•				\$275.30
95080-031	508HRL RDT 15 SMT 23/4SCL 3028 23155 LK	Interconnect					•				\$275.30
95080-030	508HRL RDT 15 SMT 23/8RCL 3223 23155 LK	Interconnect					•				\$275.30
95080-028	508HRL RDT 15 SMT 23/8SCL 5278 23155 LK	Interconnect					•				\$275.30
95080-040	508HRL RDT 26 SMT 23/4RCL 5279 23155 LK	Interconnect							•		\$275.30
95080-045	508HRL RDT 26 SMT 23/4SCL 3028 23155 LK	Interconnect							•		\$275.30
95080-044	508HRL RDT 26 SMT 23/8RCL 3223 23155 LK	Interconnect							•		\$275.30
95080-042	508HRL RDT 26 SMT 23/8SCL 5278 23155 LK	Interconnect							•		\$275.30
95080-033	508HRL RDT 514 SMT 23/4RCL 5279 23155 LK	Interconnect								•	\$279.60
95080-038	508HRL RDT 514 SMT 23/4SCL 3028 23155 LK	Interconnect								•	\$279.60
95080-037	508HRL RDT 514 SMT 23/8RCL 3223 23155 LK	Interconnect								•	\$279.60
95080-035	508HRL RDT 514 SMT 23/8SCL 5278 23155 LK	Interconnect								•	\$279.60

Contemporary Interconnect Levers - KCDB Hali SQT



MFG Pro #	Item Description	Function	3	L03	5	11P	15	26	26D	514	List Price
95080-027	508HRL SQT 15 KCDB SMT 23/4 RCL 5279 23155 LK	Interconnect KCDB					•				\$282.30
95080-032	508HRL SQT 15 KCDB SMT23 /4SCL302823155LK	Interconnect KCDB					•				\$282.30
95080-029	508HRL SQT 15 KCDB SMT 23/8 SCL 5278 23155 LK	Interconnect KCDB					•				\$282.30
95080-041	508HRL SQT 26 KCDB SMT23 /4RCL527923155LK	Interconnect KCDB							•		\$282.30
95080-046	508HRL SQT 26 KCDB SMT23 /4SCL302823155LK	Interconnect KCDB							•		\$282.30



Key Control Deadbolt

MFG Pro #	Item Description	Function	3	L03	5	11P	15	26	26D	514	List Price
98160-011	816 15 SMT KCCYL RCAL RCS 4 KC IN BOX	Key Control					•				\$86.90
98170-006	817 11P SMT RCAL UL RCS KC IN BOX	Key Control				•					\$88.90
98170-007	817 15 SMT RCAL UL RCS KC IN BOX	Key Control					•				\$88.90
98170-017	817 15 SMT RCAL UL RCS/5303 23155 LK	Key Control					•				\$88.90
98170-013	817 15 SMT RCAL UL RCS/5303 65665 LK	Key Control					•				\$88.90
98170-010	817 26D SMT RCAL UL RCS KC IN BOX	Key Control							•		\$80.90
98170-018	817 26D SMT RCAL UL RCS/5303 23155 LK	Key Control							•		\$80.90
98170-014	817 26D SMT RCAL UL RCS/5303 65665 LK	Key Control							•		\$80.90
98170-008	817 3 SMT RCAL UL RCS KC IN BOX	Key Control	•								\$80.90
98170-009	817 514 SMT RCAL UL RCS KC IN BOX	Key Control								•	\$91.90



Key Control SQT

MFG Pro #	Item Description	Function	3	L03	5	11P	15	26	26D	514	List Price
98170-011	817SQT 15 SMT RCAL UL RCS KC IN BOX	Key Control					•				\$88.90
98170-019	817SQT 15 SMT RCAL UL RCS/5303 23155 LK	Key Control					•				\$88.90
98170-015	817SQT 15 SMT RCAL UL RCS/5303 65665 LK	Key Control					•				\$88.90
98170-012	817SQT 514 SMT RCAL UL RCS KC IN BOX	Key Control								•	\$91.90
98170-020	817SQT 514 SMT RCAL UL RCS/5303 23155 LK	Key Control								•	\$91.90
98170-016	817SQT 514 SMT RCAL UL RCS/5303 65665 LK	Key Control								•	\$91.90



Kingston

MFG Pro #	Item Description	Function	3	L03	5	11P	15	26	26D	514	List Price
97210-006	721KNL 11P RCAL UL 3031	Passage				•					\$64.10
97210-002	721KNL 15 RCAL UL 3031	Passage					•				\$64.10
97210-003	721KNL 26D RCAL UL 3031	Passage							•		\$59.10
97210-004	721KNL 3 RCAL UL 3031	Passage	•								\$59.10
97210-005	721KNL 514 RCAL UL 3031	Passage								•	\$67.10
97330-006	733KNL 11P RCAL UL 3031	Privacy				•					\$68.10
97330-002	733KNL 15 RCAL UL 3031	Privacy					•				\$68.10
97330-003	733KNL 26D RCAL UL 3031	Privacy							•		\$63.10
97330-004	733KNL 3 RCAL UL 3031	Privacy	•								\$63.10
97330-005	733KNL 514 RCAL UL 3031	Privacy								•	\$71.10
97560-013	756KNL 11P SMT RCAL UL 3031	Entry				•					\$93.80
97560-006	756KNL 11P SMT RCAL UL 3031 23155 LK	Entry				•					\$93.80
97560-007	756KNL 15 RCAL UL 3031 23155 LK	Entry					•				\$93.80
97560-009	756KNL 15 SMT RCAL UL 3031	Entry					•				\$93.80
97560-002	756KNL 15 SMT RCAL UL 3031 23155 LESSKEY	Entry					•				\$93.80
97560-008	756KNL 26D RCAL UL 3031 23155 LK	Entry							•		\$88.80
97560-010	756KNL 26D SMT RCAL UL 3031	Entry							•		\$88.80
97560-003	756KNL 26D SMT RCAL UL 3031 23155LESSKEY	Entry							•		\$88.80
97560-011	756KNL 3 SMT RCAL UL 3031	Entry	•								\$88.80
97560-004	756KNL 3 SMT RCAL UL 3031 23155 LK	Entry	•								\$88.80
97560-012	756KNL 514 SMT RCAL UL 3031	Entry								•	\$96.80
97560-005	756KNL 514 SMT RCAL UL 3031 23155 LK	Entry								•	\$96.80

INTERCONNECT

Door Prep	Crossbore 2-1/8" Edge Bore 1" 5-1/2 center-to-center only.
Backset	Must specify backset 2-3/8" or 2-3/4".
Door Thickness	1-3/4"
Cylinder	SmartKey Security or Pin & Tumbler.
Faceplates	Available in round corner or square corner
Strikes	Depends on if a round corner or square corner latch is ordered. Round corner latch orders come with the following: 2.74" x 1.115" round corner deadbolt strike, 2.25" x 1.75" 5303 round corner full lip deadbolt strike (grade 3 when used) and 1" x 2-1/4" round corner full lip lever strike. Square corner latch orders come with the following: 2.74" x 1.115" square corner deadbolt strike, 2.25" x 1.75" 5303 square corner full lip deadbolt strike (grade 3 when used), 1" x 2-1/4" square corner full lip lever strike, and square corner T-strike.
Door Handing	508 - reversible.
ANSI/BHMA	Grade 2 Certified
ADA	Lever options are in compliance with the American National Standards Institute (ANSI A117.1) and the Americans with Disabilities Act (ADA).
UL	Meets UL 3 hour fire rating for all functions.

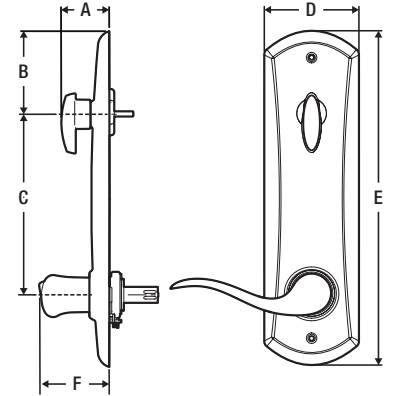

Design	A	B	C	D	E	F
Kingston and Tustin	1 7/16"	2 15/32"	5 1/2"	2 27/32"	10"	2 1/2"

CONTEMPORARY INTERCONNECT

Door Prep	Crossbore 2-1/8" Edge Bore 1"
Backset	Must specify backset 2-3/8" or 2-3/4".
Door Thickness	1-3/4"
Cylinder	SmartKey Security
Faceplates	Available in round corner or square corner
Strikes	Depends on if a round corner or square corner latch is ordered. Round corner latch orders come with the following: 2.74" x 1.115" round corner deadbolt strike, 2.25" x 1.75" 5303 round corner full lip deadbolt strike (grade 3 when used) and 1" x 2-1/4" round corner full lip lever strike. Square corner latch orders come with the following: 2.74" x 1.115" square corner deadbolt strike, 2.25" x 1.75" 5303 square corner full lip deadbolt strike (grade 3 when used), 1" x 2-1/4" square corner full lip lever strike, and square corner T-strike.
Door Handing	508 - reversible.
ANSI/BHMA	Grade 2 Certified
ADA	Lever options are in compliance with the American National Standards Institute (ANSI A117.1) and the Americans with Disabilities Act (ADA).
UL	Meets 3 hour fire rating.

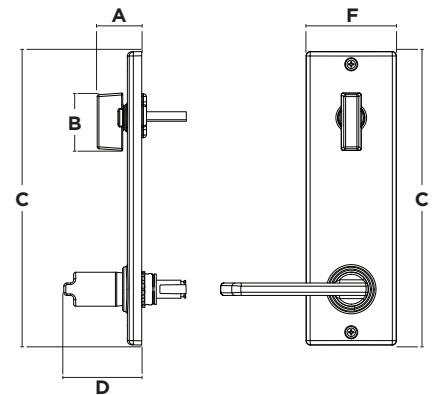

Design	A	B	C	D	F
Hali	1 13/32"	1 25/32"	9 3/16"	2 7/16"	2 27/32"

1921423-11/24

KEY CONTROL

Standard Door Prep Cross Bore 2-1/8". Edge Bore 1" Latch Face 1" x 2-1/4"

Door Thickness 1-3/4"

Cylinder 2 SmartKey Security™ cylinders: 1 standard Kwikset for users, 1 unique patented keyway for 1-Key Control

Faceplate 1" x 2-1/4" round corner

Strike 1-1/8" x 2-3/4" round corner and 2-1/4" x 1-3/4" round corner full lip strike (grade 3 when used) Other strikes are available as service parts.

Bolt 1" throw

ANSI/BHMA A156.5 Grade 2

ADA Interior turn piece meets 4.13.9 ADA

UL Meets UL 3 hour fire rating for UL function. UL Ref# R10923

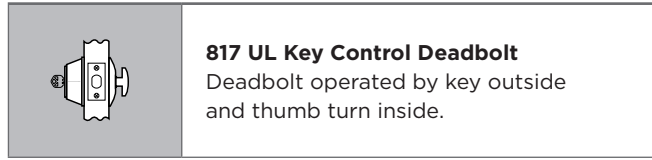

Traditional Design

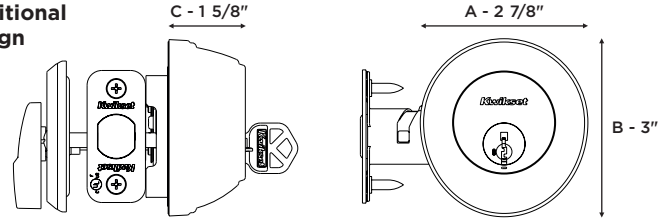

Contemporary Design

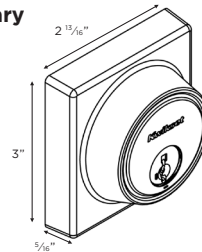

SMARTCODE 955

Function Keyed entry electronic lever

Door Prep 2 1/8" diameter face hole & 1" diameter latch hole

Backset Adjustable 2 3/8" or 2 3/4"

Door Thickness 1 3/8" - 1 3/4"

Faceplates 1" x 2 1/4" round corner standard

Strikes Round corner, 4 hole strike, 2 3/4" x 1 1/8"

Latch Round corner adjustable 2 3/8" x 2 3/4"

Bolt 1/2" throw, dead latch

Door Handing Reversible

Cylinder SmartKey Security™

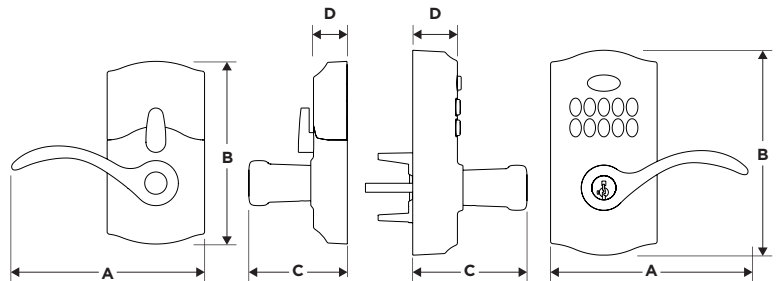

Design	A	B	C	D
Interior	5 5/8" (142.9)	5 5/16" (134.9 mm)	2 7/8" (73 mm)	31/32" (24.6 mm)
Exterior	5 3/4" (146 mm)	5 31/32" (151.6 mm)	3 5/16" (84.1 mm)	1 13/32" (35.7 mm)

KINGSTON LEVER

ANSI/BHMA	Grade 2 Certified
Door Prep	Crossbore 2-1/8" Edge Bore 1"
Backset	Adjustable to 2-3/8" or 2-3/4".
Door Thickness	1-3/8" - 1-3/4" doors standard
Cylinder	SmartKey Security or Pin & Tumbler.
Latch	Adjustable to 2-3/8" or 2-3/4" round corner.
Strikes	1" x 2-1/4" round corner
Bolt	1/2" throw.
Door Handing	Reversible for right or left-hand doors.
ADA	Lever options are in compliance with the American National Standards Institute (ANSI A117.1) and the Americans with Disabilities Act (ADA).
UL	Meets UL 3 hour fire rating for all functions
Warranty	Lifetime Mechanical, 5 Year Finish
Interior Locking Push button	

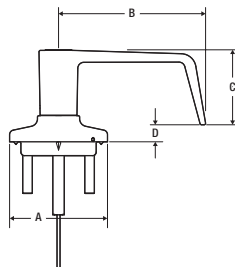

Design	A	B	C	D
Kingston	2.56"	3.84"	1.96"	.44"

CARSON LEVER

ANSI/BHMA	Grade 3 Certified
Door Prep	Crossbore 2-1/8" Edge Bore 1"
Backset	Adjustable to 2-3/8" or 2-3/4".
Door Thickness	1-3/8" - 1-3/4" doors standard
Cylinder	SmartKey Security or Pin & Tumbler.
Latch	Adjustable to 2-3/8" or 2-3/4" round corner.
Strikes	1" x 2-1/4" round corner
Bolt	1/2" throw.
Door Handing	Reversible for right or left-hand doors.
ADA	Lever options are in compliance with the American National Standards Institute (ANSI A117.1) and the Americans with Disabilities Act (ADA).
UL	Meets UL 3 hour fire rating for all functions
Warranty	Lifetime Mechanical, 5 Year Finish
Interior Locking Push button	

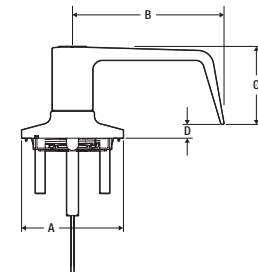

Design	A	B	C	D
Carson	2.56"	3.80"	1.96"	.35"

PALMINA LEVER

ANSI/BHMA	Grade 3 Certified
Door Prep	Crossbore 2-1/8" Edge Bore 1"
Backset	Adjustable to 2-3/8" or 2-3/4".
Door Thickness	1-3/8" - 1-3/4" doors standard
Cylinder	SmartKey Security or Pin & Tumbler.
Latch	Adjustable to 2-3/8" or 2-3/4" round corner.
Strikes	1" x 2-1/4" round corner
Bolt	1/2" throw.
Door Handing	Reversible for right or left-hand doors.
ADA	Lever options are in compliance with the American National Standards Institute (ANSI A117.1) and the Americans with Disabilities Act (ADA).
UL	Meets UL 3 hour fire rating for all functions
Warranty	Lifetime Mechanical, 5 Year Finish
Interior Locking Push button	

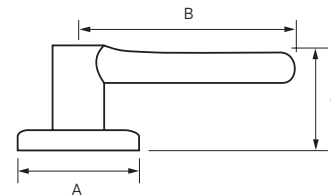

Design	A	B	C
Palmina	2.56"	3.75"	1.96"

Round Pocket Door Lock



MFG Pro #	Item Description	Function	3	L03	5	11P	15	26	26D	514	List Price	QTY
93340-044	334 11P RND PCKT DR LCK	Passage				•					\$42.70	12
93340-003	334 15 RND PCKT DR LCK	Passage					•				\$42.70	12
93340-021	334 26D RND PCKT DR LCK	Passage							•		\$42.70	12
93350-048	335 11P RND PCKT DR LCK	Privacy				•					\$46.80	12
93350-003	335 15 RND PCKT DR LCK	Privacy					•				\$46.80	12
93350-021	335 26D RND PCKT DR LCK	Privacy							•		\$46.80	12
93350-054	335 514 RND PCKT DR LCK	Privacy								•	\$46.80	12
96900-338	690T 5 SMT 6AL RCS	Combo Pack			•						\$70.50	30

Contemporary Pocket Door Lock



MFG Pro #	Item Description	Function	3	L03	5	11P	15	26	26D	514	List Price	QTY
93340-050	334 514 RDT PCKT DR LCK	Passage								•	42.7	12
93340-048	334 11P SQT PCKT DR LCK	Passage				•					42.7	12
93340-045	334 15 SQT PCKT DR LCK	Passage					•				42.7	12
93340-046	334 26 SQT PCKT DR LCK	Passage						•			42.7	12
93340-049	334 26D SQT PCKT DR LCK	Passage							•		42.7	12
93340-047	334 514 SQT PCKT DR LCK	Passage								•	42.7	12
93350-052	335 11P SQT PCKT DR LCK	Privacy				•					46.8	12
93350-049	335 15 SQT PCKT DR LCK	Privacy					•				46.8	12
93350-050	335 26 SQT PCKT DR LCK	Privacy						•			46.8	12
93350-053	335 26D SQT PCKT DR LCK	Privacy							•		46.8	12
93350-051	335 514 SQT PCKT DR LCK	Privacy								•	46.8	12











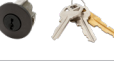

SERVICE PARTS

















LEVERS	EA. QTY	SKU No.	STYLE COMPATIBILITY													List Price			
			3	4	5	15	26	26D	TIP	514	BLK	GLD	SLVR	NO FINISH	TNL		HFL, LSL, MIL, SAL, TPL	KAL, PTH, SEL, TDL	BL, DL, DNL, HYL LRL
STRIKES																			
	1	80318				-007	-005	-005	-008	-008									\$4,440
	1	83929				-002	-006	-003	-003	-008	-008								\$10.80
	1	83796	-021			-022	-011	-011	-019	-019									\$10.80
	1	83437	-047			-048	-045	-036	-036	-040	-040								\$10.80
	1	83536	-001			-003	-002	-002	-005	-005									\$10.80
	1	83537				-003	-002	-002	-004	-004									\$10.80
	1	83534	-001			-003	-004	-004	-002	-002									\$10.80
	1	83028	-024			-021	-019	-010	-010	-023	-023								\$10.80
	1	83288												-001					\$10.80
	1	81231												-001					\$10.80
	1	83031	-001			-005	-003	-003	-007	-007									\$10.80
	1	83030	-001			-005	-003	-003	-007	-007									\$10.80
	1	83846				-015	-004	-004	-017	-017									\$14.80
LATCHES																			
	1	83714	-001			-003	-004	-004	-002	-002									\$21.80
	1	81844	-011			-012	-008	-003	-003	-013	-013								\$21.80

LEVERS	EA. QTY	SKU No.	STYLE COMPATIBILITY														List Price						
			3	4	5	15	26	26D	11P	514	BLK	GLD	SLVR	NO FINISH	TNL	HFL, LSL, MIL, SAL, TPL		KAL, PTH, SEL, TDL	BL, DL, DNL, HYL, LRL	BRNL, CSL, HSL			
Thick Door Flat Head Screws (RLEVER 2+ Contemporary)	1	89933				-003	-001	-001	-002	-002							•					\$9.80	
Thick Door Passage Kit (RLEVER 2+)	1	83752	-002			-003	-001	-001	-004	-004							•	•				\$18.80	
Chassis Screws for Levers (RLEVER 2+ Traditional)	1	85201		-003		-001	-001	-001	-002	-002								•				\$9.80	
Thick Door Flat Head Screws (RLEVER 2+ Traditional)	1	85202				-001	-001	-001	-002	-002								•				\$9.80	
PARTS MISC																							
Set Screw for Passage, Privacy and SMT Entry Interiors	1	83254															-001	•	•	•	•	•	\$3.80
Set Screw for SMT Entry Exteriors	1	83257															-001	•	•	•	•	•	\$3.80
Set Screw for P&T Entry Interiors	1	83255															-001				•		\$3.80
Set Screw for P&T Entry Exteriors	1	83256															-001				•		\$3.80
Privacy Emergency Tool 100CT	1	81087															-001	•			•	•	\$40.00
Privacy Emergency Tool	1	81087															-006	•			•	•	\$8.80
Hex Wrench Tool	1	83258															-001		•	•			\$7.80



KNOBS	EA. QTY	SKU No.	STYLE COMPATIBILITY														List Price											
			3	4	5	15	26	26D	11P	514	BLK	GLD	SLVR	NO FINISH	PSK	AYK		A	CN	H	J	L	T	P	AO	CV		
STRIKES																												
	Adjustable Round Circle Strike 500CT	1	80318					-007	-005	-005	-008	-008																\$4,440
	Round Circle Strike	1	83929					-002	-006	-003	-003	-008	-008													*	\$10.80	
	Round Corner Full Lip Strike	1	83796	-021				-022	-011	-011	-019	-019														*	\$10.80	
	Square Corner Full Lip Strike	1	83437	-047				-048	-045	-036	-036	-040	-040													*	\$10.80	
	Round Corner Extended Lip Strike	1	83536	-001				-003	-002	-002	-005	-005														*	\$10.80	
	Square Corner Extended Lip Strike	1	83537					-003	-002	-002	-004	-004														*	\$10.80	
	Round Corner Adjustable Extended Lip Strike	1	83534	-001				-003	-004	-004	-002	-002												*	*	\$10.80		
	T-Strike - Knob/Lever/Gate latch	1	83028	-024				-021	-019	-010	-010	-023	-023													*	\$10.80	
	Dust Box for Round & Square Full Lip Strikes (83796/83437)	1	83288											-001	*	*	*	*	*	*	*	*	*	*	*	*	\$10.80	
	Dust Box for T-Strike (83028)	1	81231											-001	*	*	*	*	*	*	*	*	*	*	*	*	\$10.80	
	ASA Full Lip Strike	1	83846					-015	-004	-004	-017	-017			*	*	*	*	*	*	*	*	*	*	*	*	\$14.80	
LATCHES																												
	Plain Latch 6AL (FD Rated Latch with Sticker)	1	83714	-001				-003	-004	-004	-002	-002														*	\$21.80	
	Deadlatch 6AL	1	81844	-011				-012	-008	-003	-003	-013	-013													*	\$21.80	
	Square Corner 5" Deadlatch	1	83014	-016				-018		-017	-017															*	\$21.80	
CYLINDERS																												
	SMC Cylinder, KD	1	85172											-001	-002	-003	*	*	*	*	*	*	*	*	*	*	\$28.80	















KNOBS	EA. QTY	SKU No.	STYLE COMPATIBILITY													List Price																							
			3	4	5	15	26	26D	11P	514	BLK	GLD	SLVR	NO FINISH	PSK		AYK	A	CN	H	J	L	T	P	AO	CV													
 SMT Cylinder, KD	1	83279													-004	-005	-006										•	•	•	•	•	•	•	•	•	•	•	•	\$28.80
 P&T Cylinder and Cover for Polo, KD	1	83737	-002				-005	-003	-004	-001																										•		\$25.80	
 P&T Cylinder and Cover for Hancock, KD or Config Cut	1	83733	-002				-005	-003	-004	-006	-001								•																		\$25.80		
 P&T Cylinder and Cover for Tylo & Cove, KD	1	83734	-002				-005	-003	-004	-001	-006																							•		•	\$25.80		
SCREW PACKS: LATCHES AND STRIKES																																							
 Latch & Strike Screw Pack	1	81711	-001	-001	-001	-002	-002	-002	-004	-004									•	•	•	•	•	•	•	•	•	•	•	•	•	•	•	•	\$5.80				
SCREW PACKS: DUMMY FUNCTION																																							
 Dummy Mounting Screws for 488 & 788	1	81708	-001				-004	-002	-002	-003	-003								•	•	•	•	•	•	•	•	•	•	•	•	•	•	•	•	\$8.80				
SCREW PACKS: CHASSIS MOUNTING																																							
 Chassis Screws (Excluding RLever2+)	1	81835	-001				-005	-002	-002	-006	-006								•	•	•	•	•	•	•	•	•	•	•	•	•	•	•	•	\$8.80				
 Thick Door Screw Pack w/ Spindle Extension	1	81706	-005				-006	-002	-002	-007	-007								•	•	•	•	•	•	•	•	•	•	•	•	•	•	•	•	•	\$9.80			
PARTS MISC																																							
 Set Screw for Passage, Privacy and SMT Entry Interiors	1	83254													-001					•	•															\$3.80			
 Set Screw for SMT Entry Exteriors	1	83257													-001					•	•																\$3.80		
 Privacy Emergency Tool 100CT	1	81087													-001					•	•	•	•	•	•	•	•	•	•	•	•	•	•	•	•	•	\$40.00		
 Privacy Emergency Tool	1	81087													-006					•	•	•	•	•	•	•	•	•	•	•	•	•	•	•	•	•	\$8.80		
 Screw Driver Bit 3.5 12CT	1	85624													-002						•	•	•	•	•	•	•	•	•	•	•	•	•	•	•	•	\$80.80		

DEADBOLTS - SECURITY SERIES		EA. QTY	SKU No.	3	4	5	15	26	26D	11P	514	BLK	GLD	SLVR	NO FINISH	660	665	663	664	667	677	817	599	List Price
STRIKES																								
	Deadbolt Round Corner Strike, 1" x 2-1/4"	1	85063	-001			-014	-013	-013	-008	-008					•	•	•		•	•	•		\$10.80
	Deadbolt Square Corner Strike, 1" x 2-1/4"	1	85072	-020			-019	-004	-004	-018	-018					•	•	•		•	•			\$10.80
	Deadbolt Round Corner Strike, 1-1/8" x 2-3/4"	1	85279	-003			-009	-002	-002	-015	-015					•	•	•		•	•			\$10.80
	Deadbolt Square Corner Strike, 1-1/8" x 2-3/4"	1	85278	-001			-020	-021	-021	-019	-019					•	•	•		•	•			\$10.80
	Deadbolt Round Corner Full Lip Strike	1	85303	-001			-018	-016	-016	-017	-017					•	•	•		•				\$10.80
	Deadbolt Square Corner Full Lip Strike	1	84638	-001			-008	-002	-002	-010	-010					•	•	•		•				\$10.80
	Deadbolt T-Strike	1	84632	-001			-005	-002	-002	-007	-007					•	•	•						\$10.80
	Deadbolt Round Corner Strike, 4-Hole Offset, 1-1/4" x 3-5/8"	1	83223	-019			-022	-020	-020	-017	-017											•		\$10.80
	Deadbolt Square Corner Strike, 4-Hole Offset, 1-1/4" x 3-5/8"	1	83222	-002			-029	-005	-005	-027	-027											•		\$10.80
	Gatelatch T-Strike	1	83028	-024			-021	-019	-010	-010	-023	-023											•	\$10.80
	Deadbolt Strike Box - use with 83222/83223	1	81640												-003							•		\$6.80
LATCHES																								
	Deadbolt 5" Latch	1	82730	-001				-002	-002							•	•	•		•				\$21.80
	Gatelatch Deadlatch 2-3/8"	1	83277	-001				-002	-002													•		\$45.80
	Deadbolt 6-Way Adjustable Latch	1	83703				-001	-003	-003	-002	-002					•	•	•		•	•			\$21.80

DEADBOLTS - SECURITY SERIES		EA. QTY	SKU No.	3	4	5	15	26	26D	11P	514	BLK	GLD	SLVR	NO FINISH	660	665	663	664	667	677	817	599	List Price	
	3HR UL Deadbolt Square Corner Adjustable Latch	1	83704	-001			-003	-004	-004	-002	-002												•	\$21.80	
	3HR UL Deadbolt Round Corner Adjustable Latch	1	83705	-001			-003	-004	-004	-002	-002												•	\$21.80	
	3HR UL Deadbolt Round Corner Latch 2 3/8"	1	83746				-002	-003	-003	-001	-001							•						\$21.80	
	3HR UL Deadbolt Square Corner Latch 2 3/8"	1	83747				-002	-003	-003	-001	-001							•						\$21.80	
	3HR UL Deadbolt Round Corner Latch 2 3/4"	1	83748				-002	-003	-003	-001	-001							•						\$21.80	
	3HR UL Deadbolt Square Corner Latch 2 3/4"	1	83749				-002	-003	-003	-001	-001							•						\$21.80	
	20 Min FD Deadbolt Round Corner Adjustable Latch	1	83755	-001			-002	-003	-003	-004	-004						•	•	•					\$21.80	
	20 Min FD Deadbolt Square Corner Adjustable Latch	1	83756	-001			-002	-003	-003	-004	-004						•	•	•					\$21.80	
CYLINDERS - PIN & TUMBLER																									
	Deadbolt Exterior Single Cylinder 5 Pin, KD or Config Cut	1	83735	-001			-002	-004	-005	-006	-003						•							\$25.80	
	Interior and Exterior Cylinder 5 Pin, KD	1	83736	-001			-002	-004	-005	-006	-003						•							\$25.80	
CYLINDERS - SMT																									
	SMT Exterior Single Cylinder Plug, KD or Config	1	83373														•						•	\$28.80	
	SMT Exterior Single Cylinder w/Housing, KD	1	83343	-001			-002	-003	-005	-006	-007	-008					•							\$28.80	
	SMT Exterior Double Cylinder Plug, KD or Config	1	84301														•						•	\$28.80	

DEADBOLTS - SECURITY SERIES		EA. QTY	SKU No.	3	4	5	15	26	26D	11P	514	BLK	GLD	SLVR	NO FINISH	660	665	663	664	667	677	817	599	List Price	
	SMT Interior Double Cylinder Plug, KD or Config	1	84302										-001	-003	-002		•								\$28.80
	SMT Exterior Double cylinder w/housing, KD	1	84303										-001	-003	-002		•								\$28.80
CYLINDERS - SMC																									
	SMC Exterior Single Cylinder, KD	1	85174										-001	-002	-003		•						•		\$28.80
	SMC Exterior Double Cylinder, KD	1	85170										-001	-002	-003		•								\$28.80
	SMC Interior Double Cylinder, KD	1	85171										-001	-002	-003		•								\$28.80
SCREWS																									
	Deadbolt Single Cylinder Screw Pack	1	86171	-001			-003	-002	-002	-004	-004						•								\$8.80
	Deadbolt Single Cylinder Screw Pack - Thick Door w/ Spindle Extender	1	86129	-001			-007	-006	-006	-008	-008						•								\$9.80
	Deadbolt Double Cylinder Screw Pack	1	86099	-001			-003	-002	-002	-004	-004						•								\$8.80
	Deadbolt Double Cylinder Screw Pack - Thick Door w/ Spindle Extender	1	86130	-001			-008	-006	-006	-009	-009						•								\$18.80
	Deadbolt One-Sided Screw Pack	1	83720				-001	-002	-002									•							\$8.80
	Deadbolt Screw Pack	1	83474	-001			-003	-002	-002	-005	-005												•		\$12.80
	Latch & Strike Screw Pack	1	81711	-001	-001	-001	-002	-002	-002	-004	-004						•	•	•	•	•	•	•	•	\$5.80
	Deadbolt Strike Screws - use with 83222/83223 Strike	1	86356	-004			-008	-006	-006	-007	-007											•			\$8.80

DEADBOLTS - SECURITY SERIES		EA. QTY	SKU No.	3	4	5	15	26	26D	11P	514	BLK	GLD	SLVR	NO FINISH	660	665	663	664	667	677	817	599	List Price	
PARTS - MISC																									
	Key Control Deadbolt Thin Door Kit	1	83397	-001			-002		-004	-003	-003													•	\$18.80
	Key Control Deadbolt Cylinder Cover	1	83389	-001			-002	-002	-002	-005	-005													•	\$8.80













DEADBOLTS - SIGNATURE SERIES		EA. QTY	SKU No.	3	4	5	15	26	26D	11P	514	BLK	GLD	SLVR	NO FINISH	158	159	258	780	785	782	980	985	982	List Price		
STRIKES																											
	Deadbolt Round Corner Strike, 1" x 2-1/4"	1	85063	-001			-014	-013	-013	-008	-008															\$10.80	
	Deadbolt Square Corner Strike, 1" x 2-1/4"	1	85072	-020			-019	-004	-004	-018	-018															\$10.80	
	Deadbolt Round Corner Strike, 1-1/8" x 2-3/4"	1	85279	-003			-009	-002	-002	-015	-015															\$10.80	
	Deadbolt Square Corner Strike, 1-1/8" x 2-3/4"	1	85278	-001			-020	-021	-021	-019	-019															\$10.80	
	Deadbolt Round Corner Full Lip Strike	1	85303	-001			-018	-016	-016	-017	-017															\$10.80	
	Deadbolt Square Corner Full Lip Strike	1	84638	-001			-008	-002	-002	-010	-010															\$10.80	
	Deadbolt T-Strike	1	84632	-001			-005	-002	-002	-007	-007															\$10.80	
	Deadbolt Round Corner Strike, 4-Hole Offset, 1-1/4" x 3-5/8"	1	83223	-019			-022	-020	-020	-017	-017															\$10.80	
	Deadbolt Square Corner Strike, 4-Hole Offset, 1-1/4" x 3-5/8"	1	83222	-002			-029	-005	-005	-027	-027															\$10.80	
	Deadbolt Round Corner Strike, 4-Hole, 1-1/8" x 2-3/4"	1	820050				-005	-003	-003	-004	-004															\$10.80	
	Deadbolt Square Corner Strike, 4-Hole, 1-1/8" x 2-3/4"	1	820049				-005	-003	-003	-007	-007															\$10.80	
	Deadbolt Strike Box - use with 83222/83223	1	81640												-003											\$6.80	
LATCHES																											
	Deadbolt 6 Way Adj Latch	1	83703				-001	-003	-003	-002	-002																
	Deadbolt 6 Way Adj Latch (FD Rated with Label)	1	83707				-001	-003	-003	-002	-002															\$21.80	
	Deadbolt 5" Latch	1	82730	-001			-002	-002																		\$21.80	







DEADBOLTS - SIGNATURE SERIES		EA. QTY	SKU No.	3	4	5	15	26	26D	11P	514	BLK	GLD	SLVR	NO FINISH	158	159	258	780	785	782	980	985	982	List Price		
	3HR UL Deadbolt Square Corner Adjustable Latch	1	83704	-001			-003	-004	-004	-002	-002					•	•				•		•		\$21.80		
	3HR UL Deadbolt Round Corner Adjustable Latch	1	83705	-001			-003	-004	-004	-002	-002					•	•				•		•		\$21.80		
CYLINDERS - PIN & TUMBLER																											
	Deadbolt Exterior Cylinder 6 Pin, KD or Config Cut	1	83738	-002			-001	-003	-004		-005										•	•				\$25.80	
CYLINDERS - SMT																											
	SMT Exterior Single Cylinder Plug, KD or Config Cut	1	83373										-007	-005	-008	•			•		•	•		•		\$28.80	
	SMT Exterior Single Cylinder Plug, KD	1	83025										-003	-002	-001				•							\$28.80	
	SMT Exterior Single Cylinder w/Housing, KD	1	83326	-013			-007	-005	-006	-004	-012					•			•		•	•		•		\$57.60	
	SMT Exterior Double Cylinder Plug, KD or Config Cut	1	84301										-001	-003	-002				•		•		•			\$28.80	
	SMT Interior Double Cylinder Plug, KD or Config Cut	1	84302										-001	-003	-002				•				•			\$28.80	
	SMT Exterior Double Cylinder w/Housing, KD		84303										-001	-003	-002				•		•		•			\$28.80	
CYLINDERS - SMC																											
	SMC Exterior Single Cylinder, KD	1	85174										-001	-002	-003	•			•		•	•		•		\$28.80	
	SMC Exterior Single Cylinder, KD	1	85173										-001	-002	-003				•							\$28.80	
	SMC Exterior Double Cylinder, KD	1	85170										-001	-002	-003				•		•		•			\$28.80	
	SMC Interior Double Cylinder, KD	1	85171										-001	-002	-003				•		•		•			\$28.80	

DEADBOLTS - SIGNATURE SERIES		EA. QTY	SKU No.	3	4	5	15	26	26D	11P	514	BLK	GLD	SLVR	NO FINISH	158	159	258	780	785	782	980	985	982	List Price		
SCREWS - MPP																											
	Deadbolt Screw Pack	1	81247	-007			-006	-001	-001	-008	-008															\$8.80	
	Deadbolt Screw Pack for Thick Door w/ Spindle Extender	1	81691	-006			-007	-002	-002	-005	-005															\$9.80	
	Deadbolt Thick Door Extension Kit w/ Spindle and Screw Extenders	1	84221												-001											\$18.80	
	Deadbolt Screw Pack	1	83474	-001			-003	-002	-002	-005	-005															\$12.80	
	Deadbolt Mounting Screws	1	83015				-002	-001	-001	-003	-003															\$8.80	
	Deadbolt Mounting Screws for Thin Door	1	83017				-002	-001	-001	-003	-003															\$8.80	
	Deadbolt Mounting Screws for Thick Door	1	83022				-002	-001	-001	-003	-003															\$9.80	
	Deadbolt Mounting Screws	1	820285				-002	-001	-001	-003	-003															\$8.80	
	Deadbolt Mounting Screws for Thick Door w/ Spindle Extender	1	820289				-002	-001	-001	-003	-003															\$9.80	
	Deadbolt Mounting Screws	1	820286				-002	-001	-001	-003	-003															\$12.80	
	Deadbolt Mounting Screws for Thick Door w/ Spindle Extender	1	820290				-002	-001	-001	-003	-003															\$9.80	
SCREW - LATCHES AND STRIKES																											
	Latch & Strike Screw Pack	1	81711	-001	-001	-001	-002	-002	-002	-004	-004															\$5.80	
	Deadbolt Strike Screws - use with 83222/83223 Strike	1	86356	-004			-008	-006	-006	-007	-007															\$8.80	





															STYLE COMPATIBILITY				
HANDLESETS	EA. QTY	SKU No.	3	4	5	15	26	26D	11P	514	BLK	GLD	SLVR	NO FINISH	AMD, BW, DA, HYH	ADH, AN AT, AUH, AVH, CE, HE, SE, TVH	PGH PTH, SCE, VNH	List Price	
HANDLESET COMPONENTS																			
	Handleset Mechanism Thick Door	1	83669												-001	•	•	•	\$30.80
	Handleset Mechanism Standard Door	1	820309												-001	•	•	•	\$25.80
STRIKE - DEADBOLT																			
	Deadbolt Round Corner Strike, 4-Hole Offset, 1-1/4" x 3-5/8"	1	83223	-019			-022	-020	-020	-017	-017					•	•	•	\$10.80
	Deadbolt Square Corner Strike, 4-Hole Offset, 1-1/4" x 3-5/8"	1	83222	-002			-029	-005	-005	-027	-027					•	•	•	\$10.80
	Deadbolt Round Corner Strike, 1-1/8" x 2-3/4"	1	85279	-003			-009	-002	-002	-015	-015					•		•	\$10.80
	Deadbolt Square Corner Strike, 1-1/8" x 2-3/4"	1	85278	-001			-018	-016	-016	-017	-017					•			\$10.80
	Deadbolt Round Corner Full Lip Strike	1	85303	-001			-018	-016	-016	-017	-017					•	•	•	\$10.80
	Deadbolt Square Corner Full Lip Strike	1	84638	-001			-008	-002	-002	-010	-010					•	•	•	\$10.80
	Deadbolt Round Corner Strike, 1" x 2-1/4"	1	85063	-001			-014	-013	-013	-008	-008					•	•	•	\$10.80
	Deadbolt Square Corner Strike, 1" x 2-1/4"	1	85072	-020			-019	-004	-004	-018	-018					•	•	•	\$10.80
	Deadbolt Square Corner Strike, 4-Hole, 1-1/8" x 2-3/4" (Grade 1)	1	820049				-005	-003	-003	-007	-007							•	\$10.80
	Deadbolt Round Corner Strike, 4-Hole, 1-1/8" x 2-3/4" (Grade 1)	1	820050				-005	-003	-003	-004	-004							•	\$10.80
	Deadbolt T-Strike	1	84632	-001			-005	-002	-002	-007	-007					•			\$10.80
STRIKE - KNOB/LEVER																			
	Knob/Lever Round Corner Full Lip Strike	1	83796	-021			-022	-011	-011	-019	-019					•	•	•	\$10.80
	Knob/Lever Round Corner Adjustable Extended Lip Strike	1	83534	-001			-003	-004	-004	-002	-002					•			\$10.80
	Knob/Lever Round Corner Extended Lip Strike	1	83536	-001			-003	-002	-002	-005	-005							•	\$10.80

															STYLE COMPATIBILITY			List Price			
HANDLESETS	EA. QTY	SKU No.	3	4	5	15	26	26D	11P	514	BLK	GLD	SLVR	NO FINISH	AMD, BW, DA, HYH	ADH, AN AT, AUH, AVH, CE, HE, SE, TVH	PGH PTH, SCE, VNH				
		Knob/Lever Square Corner Full Lip Strike	1	83437	-047		-048	-045	-036	-036	-040	-040					•	•	•	\$10.80	
		T-Strike	1	83028	-024		-021	-019	-010	-023							•	•	•	\$10.80	
		Handleset Strike ASA 1 1/4" Strike	1	83846				-015	-004	-017								•	•	\$14.80	
SCREWS - LATCH & STRIKE																					
		Deadbolt 3 Strike Screws - use with 833222/3223 Strike	1	86356	-004			-008	-006	-006	-007	-007							•	\$8.80	
		Latch & Strike Screw Pack	1	81711	-001	-001	-001	-002	-002	-002	-004	-004							•	•	\$5.80
LATCHES - DEADBOLT																					
		Deadbolt 6 Way Adj Latch	1	83703				-001	-003	-003	-002	-002							•	\$21.80	
		Deadbolt 6 Way Adj Latch - Low Profile	1	83023				-001	-002	-002	-004	-004								•	\$30.80
		Deadbolt Round Corner Adj Latch	1	83347	-008														•	\$21.80	
		Deadbolt Drive In Adj Latch	1	81306											-003				•	\$21.80	
CYLINDERS																					
		SMT Cylinder with Housing (does not work on Austin), KD	1	83326	-013			-007	-005	-006	-004	-012							•	\$57.60	
		SMT Cylinder Plug, KD	1	83025									-003	-002	-001					•	\$28.80
		SMT Cylinder with Housing, KD	1	83343	-001		-002	-003	-005	-006	-007	-008							•	\$28.80	
		SMC Cylinder Plug, KD	1	85173									-001	-002	-003					•	\$28.80
		P&T Cylinder with Housing, KD or Config Cut	1	83735	-001		-002	-004	-005	-006	-003								•	\$25.80	

																STYLE COMPATIBILITY			
HANDLESETS	EA. QTY	SKU No.	3	4	5	15	26	26D	TIP	514	BLK	GLD	SLVR	NO FINISH	AMD, BW, DA, HYH	ADH, AN AT, AUH, AVH, CE, HE, SE, TVH	PGH PTH, SCE, VNH	List Price	
 SMC Cylinder with Housing, KD	1	83745				-002		-003	-001	-004						•		\$28.80	
 SMC Cylinder Plug, KD	1	85174									-001	-002	-003			•		\$28.80	
DEADBOLT MOUNTING SCREWS																			
 Standard Door Mounting Screws	1	84235				-001	-003	-003	-002	-002						•		\$8.80	
 Standard Door Mounting Screws	1	83015				-002	-001	-001	-003	-003							•	\$8.80	
	1	81248				-004	-005	-005	-003	-003							•	\$9.80	
 Thick Door Chassis Screws	1	83022				-002	-001	-001	-003	-003								\$9.80	
	1	83729				-002	-003	-003	-001	-001							Pairs with 966 & 971	\$9.80	
LEVER & KNOB CHASSIS SCREWS																			
 Standard Door Mounting Screws	1	89930				-003	-001	-001	-002	-002							Pairs with 966 & 971	\$8.80	
 Standard Door Mounting Screws	1	81835	-001			-005	-002	-002	-006	-006						•	•	\$8.80	
 Chassis Thick Door Screw Pack for MPP Contemporary Levers	1	89933				-003	-001	-001	-002	-002							Pairs with 966 & 971	\$9.80	
 Chassis Thick Door Screw Packs (LPP Levers + TNL + PSK + AYK)	1	81780	-001	-001	-004	-002	-002	-002	-003	-003								\$9.80	
HANDLESET BOTTOM CONNECTION																			
 Bottom Screw and Washer - Austin Only	1	84307												-001		•		\$7.60	
 Bottom Screw and Washer - HE, SE, ADH, AVH, TVH	1	82213												-002		•		\$7.60	
 Bottom Screw and Washer Thick Door - HE, SE, ADH, AVH, TVH	1	83724												-001		•		\$7.60	

HANDLESETS	EA. QTY	SKU No.	3	4	5	15	26	26D	11P	514	BLK	GLD	SLVR	NO FINISH	STYLE COMPATIBILITY			List Price	
															AMD, BW, DA, HYH	ADH, AN AT, AUH, AVH, CE, HE, SE, TVH	PGH PTH, SCE, VNH		
 Door Screw Exterior - AMD, AN, BW, CE, DA, HYH	1	83721				-002	-003	-003	-001	-001						•	•		\$8.80
 Door Screw Exterior Thick Door - AMD, AN, BW, CE, DA, HYH	1	88376				-004	-005	-005	-003	-003						•	•		\$9.80
 Sex Nut Interior - AMD, AN, BW, CE, DA, HYH	1	88410				-007	-008	-008	-006	-006						•	•		\$8.80
 Bottom Screw and Washer - 818 Handlesets	1	83004												-001			•		\$7.60
 Bottom Screw and Washer Thick Door - 818 Handlesets	1	81861												-001			•		\$9.80
 Bottom Screw Decorative Cap	1	81696				-002	-003			-005									\$8.80

INTERCONNECT		EA. QTY	SKU No.	3	5	15	26	26D	11P	514	BLK	GLD	SLVR	NO FINISH	508 P&T	508 SMT	List Price	
STRIKES - DEADBOLT																		
	Deadbolt Square Corner No Logo Metal Door Strike	1	85278	-001		-020	-021	-021	-019	-019					•	•	\$10.80	
	Deadbolt T Strike	1	84632	-001		-005	-002	-002	-007	-007					•	•	\$10.80	
	Deadbolt Round Corner Strike, 1-1/8" x 2-3/4"	1	85279	-003		-009	-002	-002	-015	-015					•	•	\$10.80	
	Deadbolt Square Corner Strike, 1-1/8" x 2-3/4"	1	85278	-001		-020	-021	-021	-019	-019					•	•	\$10.80	
	Deadbolt Round Corner Strike, 4-Hole Offset, 1-1/4" x 3-5/8"	1	83223	-019		-022	-020	-020	-017	-017					•	•	\$10.80	
	Deadbolt Square Corner Strike, 4-Hole Offset, 1-1/4" x 3-5/8"	1	83222	-002		-029	-005	-005	-027	-027					•	•	\$10.80	
STRIKES - LEVER																		
	Interconnect UL Strike Box	1	83288											-001	•	•	\$10.80	
	Interconnect ASA 1-1/4" Lip Strike	1	83846			-015	-004	-004	-017	-017					•	•	\$14.80	
	Interconnect T-Strike	1	83028	-024	-021	-019	-010	-010	-023	-023					•	•	\$10.80	
	Interconnect Round Corner UL Full Lip Strike	1	83031	-001		-005	-003	-003	-007	-007					•	•	\$10.80	
LATCH - LEVER																		
	3Hr UL Plain Latch Round Corner Vestibule 2-3/8"	1	84262			-001	-003	-003	-002	-002					•	•	\$21.80	
	3Hr UL Plain Latch Round Corner Vestibule 2-3/4"	1	84263			-001	-003	-003	-002	-002					•	•	\$21.80	
	3Hr UL Plain Latch Square Corner Vestibule 2-3/8"	1	83753			-001	-002	-002	-003	-003					•	•	\$21.80	
	3Hr UL Plain Latch Square Corner Vestibule 2-3/4"	1	83754			-001	-002	-002	-003	-003					•	•	\$21.80	
LATCH - DEADBOLT																		
	3HR UL Deadbolt Square Corner Adjustable Latch	1	83704	-001		-003	-004	-004	-002	-002					•	•	\$21.80	
	3HR UL Deadbolt Round Corner Adjustable Latch	1	83705	-001		-003	-004	-004	-002	-002					•	•	\$21.80	
CYLINDERS																		

INTERCONNECT		EA. QTY	SKU No.	3	5	15	26	26D	11P	514	BLK	GLD	SLVR	NO FINISH	508 P&T	508 SMT	List Price
	KCDB Cylinder with Housing, KD	1	83744			-002	-003	-004	-001	-005						•	\$57.60
	SMT Exterior Cylinder with Housing, KD	1	83326	-013		-007	-005	-006	-004	-012						•	\$57.60
	SMC Cylinder Plug, KD	1	85174								-001	-002	-003			•	\$28.80
SCREWS - DEADBOLT																	
	Interconnect Screw Pack - KCDB	1	83728			-002	-003	-003	-001	-001						•	\$9.80
	Interconnect Screw Pack - 780 deadbolt	1	83722			-002	-003	-003	-001	-001					•	•	\$8.80

PUSH BUTTON LEVER		EA. QTY	SKU No.	3	5	15	26	26D	514	BLK	GLD	SLVR	NO FINISH	407	408	438PT	438SMT	439PT	439SMT	List Price	
STRIKES																					
	Knob/Lever Round Corner Full Lip Strike - 3HR UL	1	83031	-001		-005	-003	-003	-007												\$10.80
	Knob/Lever Square Corner Full Lip Strike - 3HR UL	1	83030	-001		-005	-003	-003	-007												\$10.80
	ASA 1-1/4" Strike	1	83846			-015	-004	-004	-017												\$14.80
	T-Strike - Knob/Lever/Gate latch	1	83028	-024	-021	-019	-010	-010	-023												\$10.80
	Knob/Lever Round Corner Full Lip Strike	1	83796	-021		-022	-011	-011	-019												\$10.80
	Knob/Lever Square Corner Full Lip Strike	1	83437	-047	-048	-045	-036	-036	-040												\$10.80
	"Dust Box for Knob/Lever Round & Square Full Lip Strikes (83796/83437)"	1	83288										-001								\$10.80
	Dust Box for Knob/Lever T-Strike (83028)	1	81231										-001								\$10.80
PLAIN LATCH																					
	Square Corner Adj Plain Latch 3HR UL	1	83520	-001		-003	-004	-004	-002												\$21.80
	Round Corner Adj Plain Latch 3HR UL	1	83521	-001		-003	-004	-004	-002												\$21.80
DEAD LATCH																					
	Square Corner Adj Deadlatch UL 3hr	1	83517	-001		-003	-004	-004	-002												\$21.80
	Round Corner Adj Deadlatch UL 3hr	1	83518	-001		-003	-004	-004	-002												\$21.80
CYLINDER: SMT																					
	SMT Knob & Lever Cylinder, KD	1	83279										-004	-005	-006						\$28.80
	SMC Knob & Lever Cylinder, KD	1	85172										-001	-002	-003						\$28.80

PUSH BUTTON LEVER		EA. QTY	SKU No.	3	5	15	26	26D	514	BLK	GLD	SLVR	NO FINISH	407	408	438PT	438SMT	439PT	439SMT	List Price
	SMT Knob & Lever Square Drive Chassis, KD	1	85200							-002	-001	-003					•		•	\$28.80

SCREWS																						
	Light Commercial Screw Pack	1	83524				-003	-004	-004								•	•	•	•	•	\$8.80





PUSH BUTTON LEVER														STYLE COMPATIBILITY						List Price
EA. QTY	SKU No.	3	5	15	26	26D	514	BLK	GLD	SLVR	NO FINISH	721	733	756PT	756SMT	781PT	781SMT	List Price		

STRIKE																				
	Knob/Lever Round Corner Full Lip Strike - 3HR UL	1	83031	-001	-005	-003	-003	-007						•	•	•	•	•	•	\$10.80
	Knob/Lever Square Corner Full Lip Strike - 3HR UL	1	83030	-001	-005	-003	-003	-007						•	•	•	•	•	•	\$10.80
	ASA 1-1/4" Strike	1	83846		-015	-004	-004	-017						•	•	•	•	•	•	\$14.80
	T-Strike - Knob/Lever/Gate latch	1	83028	-024	-021	-019	-010	-010	-023					•	•	•	•	•	•	\$10.80
	Knob/Lever Round Corner Full Lip Strike	1	83796	-021	-022	-011	-011	-019						•	•	•				\$10.80
	Knob/Lever Square Corner Full Lip Strike	1	83437	-047	-048	-045	-036	-036	-040					•	•	•				\$10.80
	Dust Box for Knob/Lever Round & Square Full Lip Strikes (83796/83437)	1	83288								-001	•	•	•	•					\$10.80
	Dust Box for Knob/Lever T-Strike (83028)	1	81231								-001	•	•	•	•				•	\$10.80

PLAIN LATCH																				
	Square Corner Adj Plain Latch 3HR UL	1	83520	-001	-003	-004	-004	-002						•	•					\$21.80
	Round Corner Adj Plain Latch 3HR UL	1	83521	-001	-003	-004	-004	-002						•	•					\$21.80

DEAD LATCH																				
	Square Corner Adj Deadlatch UL 3HR	1	83517	-001	-003	-004	-004	-002								•	•	•	•	\$21.80

													STYLE COMPATIBILITY								
PUSH BUTTON LEVER		EA. QTY	SKU No.	3	5	15	26	26D	514	BLK	GLD	SLVR	NO FINISH	721	733	756PT	756SMT	781PT	781SMT	List Price	
	Round Corner Adj Deadlatch UL 3HR	1	83518	-001		-003	-004	-004	-002								•	•	•	•	\$21.80
	6AL Dead Latch (Non-UL)	1	83000			-002	-001	-001	-004												\$21.80
CYLINDER: SMT																					
	SMT Knob & Lever Cylinder, KD	1	83279							-004	-005	-006					•		•	\$28.80	
	SMC Knob & Lever Cylinder, KD	1	85172							-001	-002	-003					•		•	\$28.80	
	SMT Knob & Lever Square Drive Chassis, KD	1	85200							-002	-001	-003					•		•	\$28.80	
SCREWS																					
	Light Commercial Screw Pack	1	83523			-003	-003	-002	-002					•	•	•	•	•	•	•	\$8.80

KEYS, RE-KEYING KITS & MISC.		CUT TYPE	CONFIGURATION EXPLANATION	EA. QTY	SKU No.	List Price
KEY- KCDB LANDLORD ONLY						
	KCDB "KC" Key Control Key Blank, 10CT	Blank	All loose in a bag	1	83382-001	\$20.00
	KCDB "KC" Cut Key, 4CT	Random Cut	4 keys all KA	1	83383-002	\$17.80
	KCDB "KC" Key Control Key, Specific Cut	Specific Cut	Single key	1	90009-102	\$6.00
SPIN - K BOWS						
	5 Pin, K Bow, 50 CT	Blank	All loose in a box	1	81063-009	\$100.00
	5 Pin, K Bow	Blank	Single key	1	81063-019	\$2.00
	5 Pin, K Bow	Random Cut	4 key rings with 2 cut keys on each that are all KA	1	81057-007	\$32.00
	5 Pin, K Bow	Random Cut	2 key rings with 2 cut keys on each that are all KA with rekey tool loose	1	83335-002	\$17.80
	5 Pin, K Bow	Random Cut	3 key rings with 2 cut keys on each that are all KA with rekey tool loose	1	83336-001	\$25.80
	5 Pin, K Bow	Specific Cut	Single key	1	90009-101	\$4.00
	5 Pin, K Bow 10CT	Specific Cut	10 keys that are all KA to 23155	1	81063-021	\$40.00
	5 Pin, K Bow, 10CT	Specific Cut	10 keys that are all KA to 42444	1	81063-022	\$40.00
	5 Pin, K Bow, 10CT	Specific Cut	10 keys that are all KA to 66664	1	81063-023	\$40.00
	5 Pin, K Bow, 10CT	Specific Cut	10 keys that are all KA to 77667	1	81063-024	\$40.00
	5 Pin, K Bow, 10CT	Specific Cut	10 keys that are all KA to 65466	1	81063-025	\$40.00
	5 Pin, K Bow, 10CT	Specific Cut	10 keys that are all KA to 65556	1	81063-026	\$40.00
	5 Pin, K Bow, 10CT	Specific Cut	10 keys that are all KA to 55655	1	81063-027	\$40.00
	5 Pin, K Bow, 10CT	Specific Cut	10 keys that are all KA to 66556	1	81063-028	\$40.00





KEYS, RE-KEYING KITS & MISC.	CUT TYPE	CONFIGURATION EXPLANATION	EA. QTY	SKU No.	List Price
5 Pin, K Bow, 10CT	Specific Cut	10 keys that are all KA to 44644	1	81063-029	\$40.00
5 Pin, K Bow, 10CT	Specific Cut	10 keys that are all KA to 65656	1	81063-030	\$40.00
5 Pin, K Bow, 10CT	Specific Cut	10 keys that are all KA to 56656	1	81063-031	\$40.00
5 Pin, K Bow, 10CT	Specific Cut	10 keys that are all KA to 42222	1	81063-032	\$40.00
5 Pin, K Bow, 10CT	Specific Cut	10 keys that are all KA to 65665	1	81063-020	\$40.00
5 Pin, K Bow, 10CT	Specific Cut	10 keys that are all KA to 22226	1	81063-033	\$40.00
5 Pin, K Bow, 10CT	Specific Cut	10 keys that are all KA to 24444	1	81063-034	\$40.00
5 Pin, K Bow, 10CT	Specific Cut	10 keys that are all KA to 66555	1	81063-035	\$40.00
5 Pin, K Bow, 10CT	Specific Cut	10 keys that are all KA to 56665	1	81063-036	\$40.00
5 Pin, K Bow, 10CT	Specific Cut	10 keys that are all KA to 55666	1	81063-037	\$40.00
5 Pin, K Bow, 10CT	Specific Cut	10 keys that are all KA to 66656	1	81063-038	\$40.00
5 Pin, K Bow, 10CT	Specific Cut	10 keys that are all KA to 56556	1	81063-039	\$40.00
5 Pin, K Bow, 10CT	Specific Cut	10 keys that are all KA to 66766	1	81063-040	\$40.00
5 Pin, K Bow, 10CT	Specific Cut	10 keys that are all KA to 66646	1	81063-041	\$40.00
5 Pin, K Bow, 10CT	Specific Cut	10 keys that are all KA to 56566	1	81063-042	\$40.00
5 Pin, K Bow, 10CT	Specific Cut	10 keys that are all KA to 66566	1	81063-043	\$40.00
5 Pin, K Bow, 10CT	Specific Cut	10 keys that are all KA to 55665	1	81063-044	\$40.00
5 Pin, K Bow, 10CT	Specific Cut	10 keys that are all KA to 56555	1	81063-045	\$40.00
5 Pin, K Bow, 10CT	Specific Cut	10 keys that are all KA to 56655	1	81063-046	\$40.00

KEYS, RE-KEYING KITS & MISC.		CUT TYPE	CONFIGURATION EXPLANATION	EA. QTY	SKU No.	List Price
SPIN - BUILDER KEYS						
	5 Pin, Solid Bow, Builders Key, 50CT	Blank	Single key	1	82205-032	\$100.00
	5 Pin, Solid Bow, Builders Key, Specific Cut	Specific Cut	Single key	1	90009-107	\$6.00
	5 Pin, Solid Bow, Builders Key	Any Cut	Single key	1	90009-108	\$6.00
	5 Pin, Solid Bow, Master Key, 50CT	Blank	Single key	1	81210-001	\$4.00
	5 Pin, Solid Bow, Master Key, Specific Cut	Specific Cut	Single key	1	90009-109	\$6.00
	5 Pin, Solid Bow, Master Key	Any Cut	Single key	1	90009-110	\$6.00
	5 Pin, Solid Bow, Grand Master Key	Any Cut	Single key	1	90009-111	\$6.00
SPIN - SMC						
	5 Pin, Solid Bow, SMC, 50CT	Blank	All loose in a box	1	85178-001	\$100.00
	5 Pin, Solid Bow, SMC	Random Cut	4 keys all KA	1	85175-002	\$17.80
	5 Pin, Solid Bow, SMC	Specific Cut	Single key	1	90009-118	\$6.00
	5 Pin, Solid Bow, KCDB Control Key, 50CT	Blank	All loose in a box	1	85182-001	\$100.00
	5 Pin, Solid Bow, KCDB Control Key	Specific Cut	Single key	1	90009-117	\$6.00
6PIN						
	6 Pin, K Bow, Nickel Plated, Blank, 50CT	Blank	All loose in a box	1	81208-001	\$100.00
	6 Pin, K Bow, Nickel Plated, Specific Cut	Specific Cut	Single key	1	90009-104	\$6.00
	6 Pin, K Bow, Nickel Plated	Any Cut	Single key	1	90009-119	\$6.00
	6 Pin, Solid Bow, Do Not Duplicate, Blank, 50CT	Blank	All loose in a box	1	81693-001	\$100.00

KEYS, RE-KEYING KITS & MISC.		CUT TYPE	CONFIGURATION EXPLANATION	EA. QTY	SKU No.	List Price
	6 Pin, Solid Bow, Do Not Duplicate, Specific Cut	Specific Cut	Single key	1	90009-105	\$6.00
	6 Pin, Solid Bow, Do Not Duplicate, Any Cut	Any Cut	Single key	1	90009-120	\$6.00
	6 Pin, Front Removable Cyl, Control Key, Blank, 50CT	Blank	All loose in a box	1	87615-001	\$92.20
	6 Pin, Front Removable Cyl, Control Key, Specific Cut	Specific Cut	Single key	1	90009-106	\$6.00
	6 Pin, Solid Bow, PK	Specific Cut	Single key	1	90009-112	\$6.00
	6 Pin, Solid Bow, Any	Any Cut	Single key	1	90009-113	\$6.00
	6 Pin, Solid Bow, Master Key Config	Specific Cut	Single key	1	90009-114	\$6.00
	6 Pin, Solid Bow, Master Key	Any Cut	Single key	1	90009-115	\$6.00
	6 Pin, Solid Bow, Grand Master Key	Any Cut	Single key	1	90009-116	\$6.00

KEYS, RE-KEYING KITS & MISC.		EA. QTY	SKU No.	List Price
MISCELLANEOUS PARTS				
	272 P&T Keying Kit	1	92720-001	\$420.80
	Knob Plug Retainer Clip	1	84345-001	\$4.80
	Spring for Control Lug Locking Bar, 100CT	1	87632-001	\$20.80
	Deadbolt Control Lug Locking Bar	1	87809-001	\$6.80
	Deadbolt Plug Retainer Clip	1	84215-001	\$4.80
	PK/Construction Balls, 100CT	1	82208-001	\$20.80
	5 Pin Spring Cover, 50CT	1	85757-001	\$40.00
	Tumbler Spring, 100CT	1	81777-001	\$20.80
	6 Pin Spring Cover	1	83561-001	\$4.80
	Cylinder Removal Tool	1	81467-003	\$8.80
	Key Gauge	1	80049-001	\$16.80
P&T KEYING KIT 236				
	236 P&T Builder Keying Kit	1	92360-001	\$420.80
	#3 Bottom Pin Silver .218", 100CT	1	83103-001	\$20.80
	#2 Bottom Pin Purple .195", 100CT	1	83101-001	\$20.80
	#1 Bottom Pin Gold .172", 100CT	1	83100-001	\$20.80
	#6 Bottom Pin Gold .287", 100CT	1	83107-001	\$20.80
	#5 Bottom Pin Red .264", 100CT	1	83106-001	\$20.80
	#4 Bottom Pin Green .241", 100CT	1	83105-001	\$20.80

KEYS, RE-KEYING KITS & MISC.		EA. QTY	SKU No.	List Price
	#6 Master Pin Gold .138", 100CT	1	83125-001	\$20.80
	#5 Master Pin Red .115", 100CT	1	83114-001	\$20.80
	#4 Master Pin Green .092", 100CT	1	83113-001	\$20.80
	#3 Master Pin Silver .069", 100CT	1	83112-001	\$20.80
	#2 Master Pin Purple .046", 100CT	1	83110-001	\$20.80
	#1 Master Pin Gold .023", 100CT	1	83108-001	\$20.80
	Regular Top Pin Gold .180", 100CT	1	81858-001	\$20.80
	PK Top Pin Red .160", 100CT	1	83117-001	\$20.80
	Plug Follower	1	80152-001	\$16.80
LEARN TOOL				
	Reset Cradle SMT	1	83260-001	\$64.20
	Reset Cradle SMC	1	85181-001	\$28.80
	Learn Tool	1	83282-003	\$7.80
	Plastic SMT Learn Tool	1	83283-001	\$5.00
ADDITIONAL ITEMS				
	3103-21 BRS PIN BTM .218 LVR, 100CT	1	83103-001	\$20.80
	3101-21 BRS PIN BTM .195 PRPL, 100CT	1	83101-001	\$20.80
	3105-21 BRS PIN BTM .241 GRN, 100CT	1	83105-001	\$20.80
	3100-21 BRS PIN BTM .172 NTRL, 100CT	1	83100-001	\$20.80
	3106-21 BRS PIN BTM .264 RED, 100CT	1	83106-001	\$20.80

KEYS, RE-KEYING KITS & MISC.		EA. QTY	SKU No.	List Price
	3107-21 BRS PIN BTM .287 NTRL, 100CT	1	83107-001	\$20.80
	12980 BRS PIN TOP.160 RED, 100CT	1	80369-001	\$40.00
	12981 BRS PIN TOP .180, 100CT	1	80370-001	\$40.00
	10842 LCK BAR TTN L/S	1	87619-001	\$7.80
	Finishing Ring	1	83621-001	\$18.40

Electronic Service Parts		SKU No.	L03	5	15	11P	26	15/26	11P/514	690/11P	690	514	NA	List Price
	909, 911 & 912 Top Battery Holder	83307											•	\$1.90
	913, 914, 915, 916, 919 and 953 Battery Pack without Pull Tab (for use with 83580)	83581											•	\$1.90
	888, 938, 939, 942, and HC620 Battery Pack with Pull Tab (For use with: 83813/83814)	83502											•	\$1.90
	938 Halo Exterior Keypad	85133			•				•					\$57.56
	939 Halo Exterior Touchscreen	85134			•		•		•					\$113.01
	942 Aura Exterior Keypad	85135			•				•					\$49.70
	942 Aura Keypad Interior Chassis	85140											•	\$118.30
	938 Halo Keypad Interior Chassis	85138											•	\$180.57
	939 Halo Touchscreen Interior Chassis	85139											•	\$179.54
	Electronics Deadbolt Adapter Ring	83583											•	\$3.05
	Tapered Deadbolt, RC, 2-Way	83187	•		•				•		•			\$5.00
	913, 914, 915, 916, 919, 938, 939, 942, 953, 954, and 959 Interior Mounting Plate	85137											•	\$5.45
	HC620 Interior Mounting Plate	83154											•	\$5.45
	909 TRL Top Cover	83306	•		•				•					\$12.60
	917 HFL Interior Battery Cover	85143											•	\$4.50
	917, 955 TNL Interior Battery Cover	85145											•	\$4.50

Electronic Service Parts		SKU No.	L03	5	15	11P	26	15/26	11P/514	690/11P	690	514	NA	List Price
	938, 939, and 942 Interior Cover	85141			•		•		•					\$32.10
	Interior Cover, CNT (For use with: Battery Pack with Pull Tab 83502)	83814			•				•					\$32.10
	Interior Cover, TRL (For use with: Battery Pack with Pull Tab 83502)	83813			•				•					\$32.10
	Security Screw for black interior RF Window	85196			•				•					\$0.50
	909 and 910 Interior Cover Screws	80435			•									\$1.00
	913, 914, 915, 916, 919, 938, 939, 942, 953, 954, and 959 Interior Cover Screws (For use with 85137)	83585	•		•				•					\$1.15
	HC 620 Interior Cover Screws (For use with 83154)	83137	•		•				•					\$1.15
	913, 914, 915, 916, 938, 939, 942, and HC620 Mounting Screws & Spindle for 2-1/4" Door Thickness	83159											•	\$5.35
	917 & 955 Replacement Mounting Screws with Spindle	85144			•		•		•					\$6.00
	953, 954 Mounting Screws for 1-3/8" Door Thickness	83651											•	\$5.50
	953, 954 Mounting Screws for 2" Door Thickness	83653											•	\$5.35
	2 1/4" Thick Door Kit for 953, 938, 939, 959	83033											•	\$5.35
	Electronics tapered deadbolt adjustable drive-in latch (excluding Smart Code 260 and 270)	83186											•	\$5.05
	53709 - 9240 Electronic Deadbolt (5-Pin), with One KW1 Key	84350	•		•				•					\$18.30
	RCAL 9240/9250 Series Electronic Deadbolt	84351	•		•					•				\$12.20

Electronic Service Parts		SKU No.	L03	5	15	11P	26	15/26	11P/514	690/11P	690	514	NA	List Price
	SMT 9270/9260/9250 Electronic Deadbolt Cylinder Only	84242	•					•	•					\$20.00
	9270/9260 Interior Battery Cover	84253											•	\$6.00
	9270/9260 Mounting Plate	84249											•	\$6.00
	9270/9260 Electronic Deadbolt RC Strike and Screws	84271	•		•	•	•					•		\$8.00
	9270/9260/9250 Electronic Deadbolt Thick Door Pack with SMT Cylinder & Keys	84251	•					•	•					\$25.00
	9270/9260 Electronic Deadbolt Mounting Screws	84250											•	\$4.00
	9270/9260 Electronic Deadbolt Interior Mounting Screws	84252											•	\$3.00

KNOBS	
A	Abbey
AO	Aliso
AYK	Arroyo
CV	Cove
H	Hancock
L	Laurel
P	Polo
PSK	Pismo
T	Tylo

LEVERS	
ADL	Ashfield
AUL	Austin
AVL	Avalon
BL	Balboa
BRNL	Breton
CSL	Casey
CNL	Carson
DL	Delta
DNL	Dorian
HFL	Halifax
HRL	Hali
HYL	Henley
KAL	Katella
KNL	Kingston
LRL	Ladera
LSL	Lisbon
MIL	Milan
PLL	Palmina
PTH	Perth
SEL	Sedona
SAL	Singapore
TDL	Trafford
TPL	Tripoli
TNL	Tustin

HANDLESET	
AMD	Amador
AN	Arlington
ADH	Ashfield
AVH	Avalon
BW	Belleview
CE	Chelsea
DA	Dakota
HE	Hawthorne
PGH	Prague
PTH	Prescott
SCE	San Clemente
TVH	Tavaris
VNH	Vancouver

DEADBOLT	
KCDB	Key Control

November 2024

Kwikset



@KwiksetLocks



@Kwikset



@Kwikset



@KwiksetCorp



@Kwikset

www.kwikset.com

19701 DaVinci • Lake Forest, CA • 92610 • 1-800-327-LOCK (5625)

Copyright © 2024 ASSA ABLOY Americas Residential Inc. • KW-1840891_07/24