

FEATURING THE LATEST PRODUCTS FROM WIDIA™

ADVANCES

2019 INCH



WIDIA 

INTRODUCING...

NEW PRODUCTS

VSM890™-12

pages 4–11

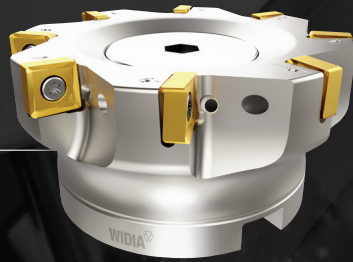

7FNS

pages 22–25

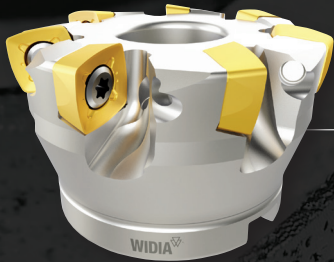

VXF™-12

pages 12–18

VT-AFT

pages 78–82



WGC

pages 84–103



INDEXABLE MILLING 4-18

VSM890-12
VXF-12

SOLID END MILLING 20-33

The VariMill Family
7FNS X-Feed
4U50
4U80
AluSurf

HOLEMAKING 34-77

TDMX
Top Cut 4

TAPPING 78-82

VT-AFT Aero Fastener Taps

TURNING 84-103

WGC

ORDERING INFORMATION 104-108

Informational Icons Guide
Material Overview



Top Cut 4™
pages 46-77



**AluSurf
5AN2**
pages 30-33



4U50
pages 26, 28



4U80
pages 26, 29



TDMX™
pages 34-44

WIDIA 

COMING SOON!

AN ALL-INCLUSIVE CATALOG SHOWCASING
WIDIA™ TOOLING AND MACHINING STRATEGIES
THAT REDUCE CYCLE TIME AND INCREASE
TOOLING COST SAVINGS.



WIDIA 

MACHINING **BRILLIANCE**

2019

AEROSPACE

FEATURING THE BEST
AEROSPACE COMPONENT
MACHINING SOLUTIONS
FROM WIDIA™

WIDIA [™]
MACHINING **BRILLIANCE**



VSM890™-12



UNIQUE 8-EDGED SOLUTION FOR
SHOULDER AND FACE MILLING





VSM890™ -12

Weldon® End Mills: 1.25" and 1.5"

Shell Mills: 2–10"

8-Edged, Double-Sided True 0° Victory™ Shoulder-Face Mill (VSM)

Superior Metal Removal Rates (MRR) delivered through high-performance grades and chipbreakers.

Coarse, medium, and fine pitch cutter density to perfectly translate machining capability into higher productivity.

New pocket seat design for improved insert seating and great stability at roughing applications.

Applicable in a wide range of workpiece materials: aluminum, steel, cast iron, titanium, stainless steel, and high-temp alloys.

Comprehensive standard offering for cutter bodies and inserts to address light machining to heavy roughing jobs.



Available in the new WU10PM and WS40PM grades.

WIDIA 

widia.com

VSM890™ -12

8-Edged, Double-Sided True 0° Victory™ Shoulder-Face Mill

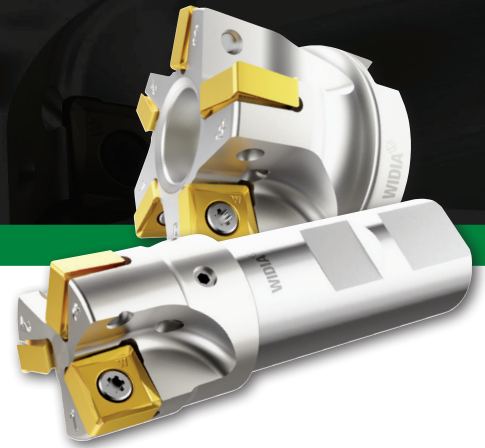

- True 0° wall and stepping down capability.
- Axial depth of cut capability; Ap1 max up to .386".
- Optimized chip gash design for proper chip evacuation.
- User-friendly pocket numbering system.
- Cutter bodies with internal coolant supply.
- Less bur creation on the workpiece.

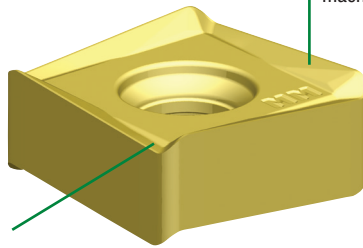

Integrated wiper facet for excellent surface floor finish.

Super-positive rake design for low machine power consumption.

**Unique insert rake design to reduce and perfectly balance axial and radial cutting forces.
Engineered for light machining to heavy roughing in all material groups.**

-ALP



N

First choice for Non-Ferrous materials.

-ML



P M S

First choice for Stainless Steel, light machining, and finishing jobs.

-MM

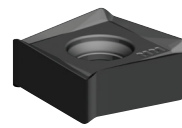

P M K S H

First choice for general purpose in all workpiece materials. Engineered for high-feed rates.

Finishing Capabilities/Lower Cutting Forces

Geometry Strengthening/Stronger Cutting Edge Protection

Applications

1. Face milling.
2. Full slotting with 100% radial engagement.
3. Shoulder milling with stepping down and great wall finish.
4. Shoulder milling with low axial and high radial engagement.
5. Shoulder milling with low radial and high axial engagement.
6. HPC face milling. First choice to clean up castings.
7. Dynamic/trochoidal slot milling.
8. Z-axis plunge milling.
9. Z-axis contour plunge milling.
10. Z-axis zig-zag slot plunge milling.

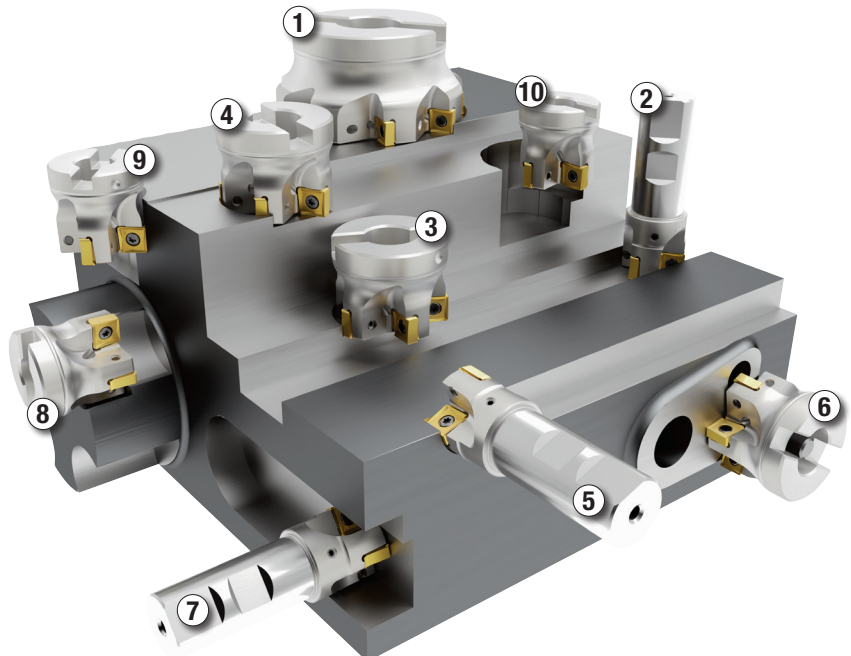

Victory™ Shoulder-Face Mills • VSM890™-12 Series

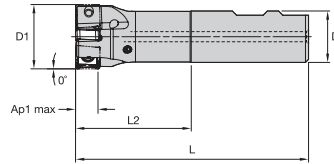

▼ Weldon® End Mills

order number	catalog number	D1	D	L	L2	Ap1 max	Z	max RPM	coolant supply	lbs
6596129	VSM890D125Z03W100SN12	1.250	1.000	4.530	2.250	.387	3	33400	Yes	.89
6596130	VSM890D150Z04W100SN12	1.500	1.000	4.530	2.250	.387	4	29100	Yes	1.18

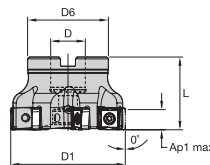

▼ Shell Mills

order number	catalog number	D1	D	D6	L	Ap1 max	Z	max RPM	coolant supply	lbs
6596131	VSM890D200Z04S075SN12	2.000	.750	1.750	1.575	.387	4	23800	Yes	.73
6596132	VSM890D200Z05S075SN12	2.000	.750	1.750	1.575	.387	5	23800	Yes	.70
6596133	VSM890D250Z05S075SN12	2.500	.750	1.750	1.575	.387	5	20700	Yes	1.06
6596134	VSM890D250Z07S075SN12	2.500	.750	1.750	1.575	.387	7	20700	Yes	.99
6596135	VSM890D300Z05S100SN12	3.000	1.000	2.190	1.750	.387	5	18500	Yes	1.63
6596136	VSM890D300Z07S100SN12	3.000	1.000	2.190	1.750	.387	7	18500	Yes	1.73
6596137	VSM890D300Z09S100SN12	3.000	1.000	2.190	1.750	.387	9	18500	Yes	1.69
6596138	VSM890D400Z06S150SN12	4.000	1.500	3.810	2.000	.387	6	15700	Yes	3.51
6596139	VSM890D400Z08S150SN12	4.000	1.500	3.810	2.000	.387	8	15700	Yes	3.76
6596151	VSM890D400Z11S150SN12	4.000	1.500	3.810	2.000	.387	11	15700	Yes	3.67
6596152	VSM890D500Z07S150SN12	5.000	1.500	3.810	2.380	.387	7	13800	Yes	6.06
6596153	VSM890D500Z10S150SN12	5.000	1.500	3.810	2.380	.387	10	13800	Yes	6.44
6596154	VSM890D500Z14S150SN12	5.000	1.500	3.810	2.380	.387	14	13800	Yes	6.18
6596155	VSM890D600Z08S200SN12	6.000	2.000	4.875	2.380	.387	8	12500	Yes	11.19
6596156	VSM890D600Z12S200SN12	6.000	2.000	4.875	2.380	.387	12	12500	Yes	9.49
6596157	VSM890D600Z16S200SN12	6.000	2.000	4.875	2.380	.387	16	12500	Yes	9.70
6596158	VSM890D800Z10S250SN12	8.000	2.500	5.118	2.380	.387	10	10700	Yes	12.08
6596159	VSM890D800Z14S250SN12	8.000	2.500	5.118	2.380	.387	14	10700	Yes	12.60
6596160	VSM890D800Z22S250SN12	8.000	2.500	5.118	2.380	.387	22	10700	Yes	12.45
6613696	VSM890D1000Z16S250SN12	10.000	2.500	5.118	2.380	.387	16	9500	Yes	18.01

▼ Spare Parts

D1	insert screw	in. lbs.	wrench
1.250-10.000	MS-2071	35	DT151P

NOTE: Please order Torx Plus driver separately.

VSM890™ -12

Victory™ Shoulder-Face Mills • VSM890-12 Series

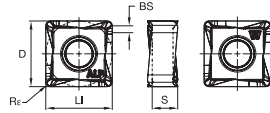

● first choice
○ alternate choice

P					●	●	●	○
M					●	○	●	●
K	●	●			○	○	○	●
N					●			
S					●		○	●
H								●

▼ SNHX-ALP • For Aluminum and Other Non-Ferrous Alloys

ISO catalog number	ANSI catalog number	cutting edges	LI		S		D		BS		R _ε		WK15CM	WK15PM	WN25PM	WP25PM	WP35CM	WP40PM	WS40PM	WU10PM		
			mm	in	mm	in	mm	in	mm	in	mm	in										
SNHX120408PNERALP	SNHX1202PNERALP	8	12,00	.472	4,61	.181	12,00	.472	1,34	.053	0,80	.032	●	●	●	○	○	○	○	○	○	○

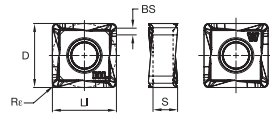

▼ SNHX-ML • Precision Finishing and Light Machining

ISO catalog number	ANSI catalog number	cutting edges	LI		S		D		BS		R _ε		WK15CM	WK15PM	WN25PM	WP25PM	WP35CM	WP40PM	WS40PM	WU10PM		
			mm	in	mm	in	mm	in	mm	in	mm	in										
SNHX120408PNERML	SNHX1202PNERML	8	12,00	.472	4,61	.181	12,00	.472	1,34	.053	0,80	.032	●	●	●	○	○	○	○	○	○	○

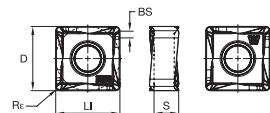

▼ SNHX-MM • Universal Geometry for Medium Machining

ISO catalog number	ANSI catalog number	cutting edges	LI		S		D		BS		R _ε		WK15CM	WK15PM	WN25PM	WP25PM	WP35CM	WP40PM	WS40PM	WU10PM	
			mm	in	mm	in	mm	in	mm	in	mm	in									
SNHX120408PNSRMM	SNHX1202PNSRMM	8	12,00	.472	4,61	.181	12,00	.472	1,34	.053	0,80	.032	●	●	●	○	○	○	○	○	○

▼ SNPX-MM • Universal Geometry for Heavy Roughing

ISO catalog number	ANSI catalog number	cutting edges	LI		S		D		BS		R _ε		WK15CM	WK15PM	WN25PM	WP25PM	WP35CM	WP40PM	WS40PM	WU10PM	
			mm	in	mm	in	mm	in	mm	in	mm	in									
SNPX120408PNSRMM	SNPX1202PNSRMM	8	12,00	.472	4,61	.181	12,00	.472	1,34	.053	0,80	.032	●	●	●	○	○	○	○	○	○

Victory™ Shoulder-Face Mills • VSM890™-12 Series

▼ Insert Selection Guide

Material Group	Light Machining		General Purpose		Heavy Machining	
	Geometry	Grade	Geometry	Grade	Geometry	Grade
P1-P2	SNHX-ML	WS40PM	SNPX-MM	WP40PM	SNPX-MM	WP40PM
P3-P4	SNHX-ML	WS40PM	SNPX-MM	WP40PM	SNPX-MM	WP40PM
P5-P6	SNHX-ML	WP25PM	SNPX-MM	WP35CM	SNPX-MM	WP40PM
M1-M2	SNHX-ML	WS40PM	SNHX-ML	WS40PM	SNPX-MM	WS40PM
M3	SNHX-ML	WS40PM	SNHX-ML	WS40PM	SNPX-MM	WS40PM
K1-K2	SNPX-MM	WK15PM	SNPX-MM	WK15CM	SNPX-MM	WK15CM
K3	SNPX-MM	WK15PM	SNPX-MM	WP35CM	SNPX-MM	WP35CM
N1-N2	SNHX-ALP	WN25PM	SNHX-ALP	WN25PM	SNHX-ALP	WN25PM
N3	SNHX-ALP	WN25PM	SNHX-ALP	WN25PM	SNHX-ALP	WN25PM
S1-S2	SNHX-ML	WP25PM	SNHX-ML	WS40PM	SNPX-MM	WS40PM
S3	SNHX-ML	WS40PM	SNHX-ML	WS40PM	SNPX-MM	WS40PM
S4	SNHX-ML	WS40PM	SNHX-ML	WS40PM	SNPX-MM	WS40PM
H1	SNHX-MM	WU10PM	SNHX-MM	WU10PM	-	-

▼ Recommended Starting Speeds [SFM]*

Material Group		WK15CM	WK15PM	WN25PM	WP25PM	WP35CM	WP40PM	WS40PM	WU10PM
P	1	-	-	-	1085 935 885	1495 1295 1215	970 855 805	-	-
	2	-	-	-	900 785 655	920 835 755	820 705 590	-	-
	3	-	-	-	835 705 575	835 755 675	755 640 525	-	-
	4	-	-	-	740 605 490	625 575 525	675 560 445	-	-
	5	-	-	-	605 560 490	855 755 690	560 510 445	560 475 395	-
	6	-	-	-	540 410 330	525 445 360	490 375 295	490 360 260	-
M	1	-	-	-	675 590 540	675 605 510	640 560 510	690 560 460	-
	2	-	-	-	605 525 425	605 525 460	575 490 410	590 475 395	-
	3	-	-	-	460 395 310	475 425 375	425 375 295	475 360 280	-
K	1	1380 1265 1115	885 805 705	-	755 675 605	970 870 785	-	-	970 870 785
	2	1100 970 900	690 625 575	-	590 525 490	770 690 625	-	-	755 675 625
	3	920 820 755	575 525 475	-	490 445 395	640 575 525	-	-	640 575 525
N	1	-	-	3525 3100 2870	-	-	-	-	-
	2	-	-	3100 2870 2495	-	-	-	-	-
	3	-	-	3100 2870 2495	-	-	-	-	-
S	1	-	-	-	130 115 80	-	-	130 115 80	-
	2	-	-	-	130 115 80	-	-	130 115 80	-
	3	-	-	-	165 130 80	-	-	165 130 80	-
	4	-	-	-	230 165 115	-	-	195 165 100	-
H	1	-	-	-	-	-	-	-	525 425 295

NOTE: FIRST choice starting speeds are in **bold** type. As the average chip thickness increases, the speed should be decreased.
 *Material groups P, M, K, and H show recommended starting speeds for dry machining. For wet machining, reduce speed by 20%.
 *Material groups N and S show recommended starting speeds for wet machining. Not recommended for dry machining.

Light Machining	General Purpose	Heavy Machining
-----------------	-----------------	-----------------

▼ Recommended Starting Feeds [IPT]

Insert Geometry	Programmed Feed per Tooth (fz) as a % of Radial Depth of Cut (ae)														Insert Geometry	
	5%			10%			20%			30%			40-100%			
.E..ALP	.005	.010	.015	.003	.007	.011	.003	.005	.008	.002	.005	.007	.002	.004	.006	.E..ALP
.E..ML	.007	.012	.023	.005	.009	.017	.004	.007	.012	.003	.006	.011	.003	.005	.010	.E..ML
.S..MM	.009	.014	.032	.007	.010	.023	.005	.008	.017	.004	.007	.015	.004	.006	.014	.S..MM

NOTE: Use "Light Machining" values as starting feed rate.

VSM890™ -12

Victory™ Shoulder-Face Mills • VSM890-12 Series

Best Practices

True 0° roughing tool with embedded finishing capabilities all in one tool.

Best-in-class wall finish with VSM890-12 in axial stepping-down jobs. For many shop floor setups, no additional finishing is required resulting in shorter machining time and lower tooling cost.

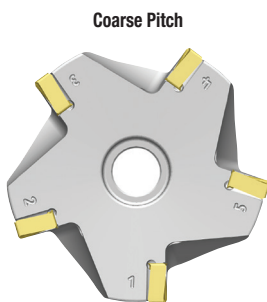
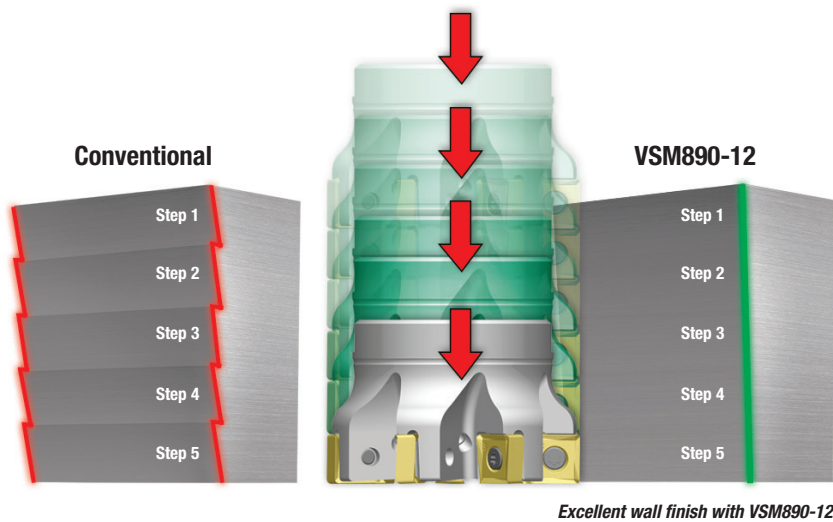

- Unstable setup.
- Low spindle power.
- High axial depth of cut A_{p1} .
- Low feed rate.
- Machining aluminum.
- Driven tools.

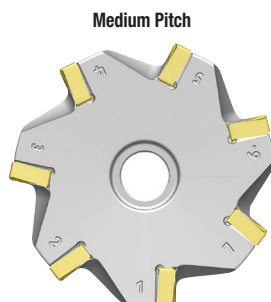

- Regular setup.
- Regular spindle power.
- Medium feed rate.

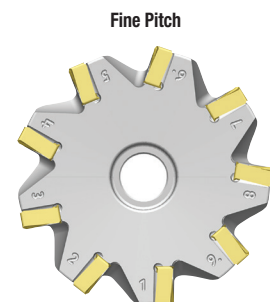

- Rigid setup.
- High spindle power.
- Low axial depth of cut A_{p1} .
- High feed rate.
- Boost productivity and cut into cycle time.

Machining Stability



Victory™ Shoulder-Face Mills • VSM890™-12 Series

▼ VSM890-12 Z-Axis Plunge Milling

cutting diameter (D1)	Y max	X
1.25	0.3504	1.1228
1.5	0.3504	1.2693
2	0.3504	1.5205
2.5	0.3504	1.7358
3	0.3504	1.9272
4	0.3504	2.2618
5	0.3504	2.5528
6	0.3504	2.8138
8	0.3504	3.2744
10	0.3504	3.6776

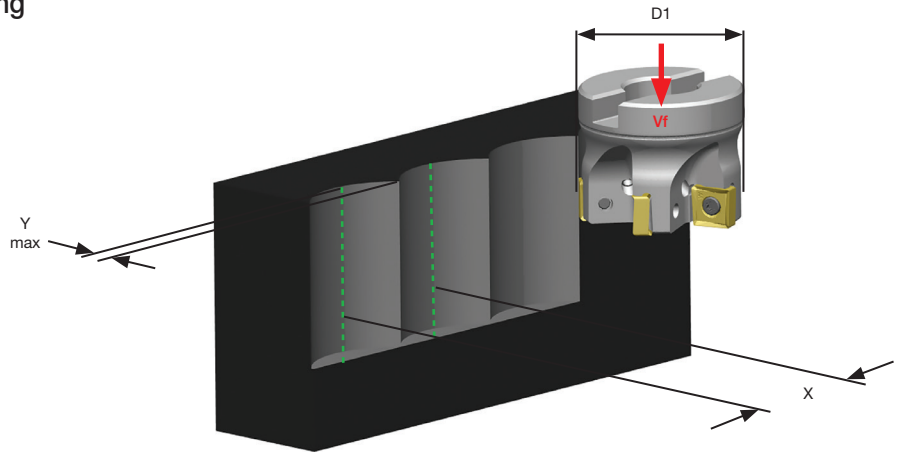

VSM890-12 Cartridge for M4000

M4000CA-SNHX12
(MM6602179)

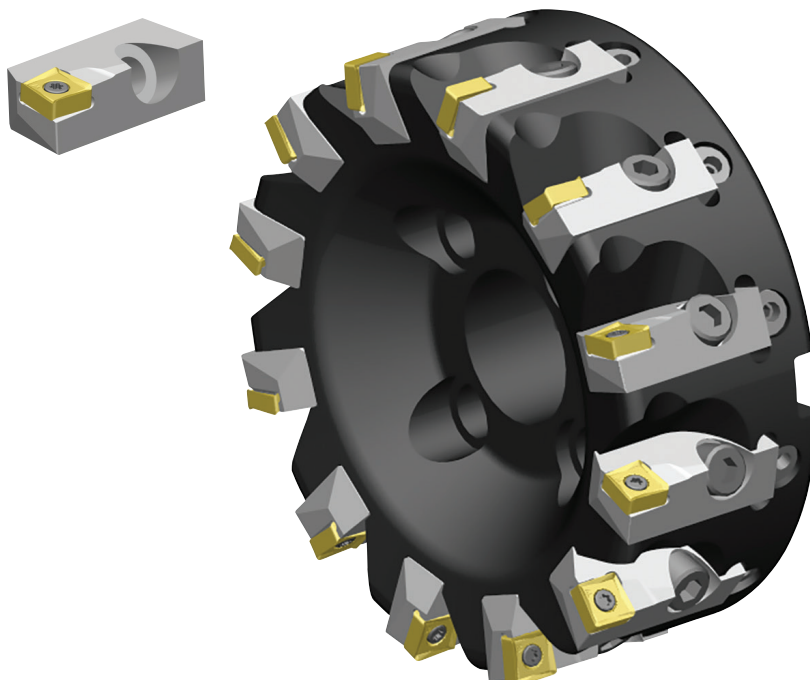

VXF™

VICTORY™ X-FEED™



NEXT LEVEL OF HIGH-FEED MILLING





VXF™ -12 Series

VXF-12: A_p1 max: .098"
VXF-12: f_z max: .078" IPT

16.5° lead angle redistributes cutting forces in the spindle z-axis direction.

Feed rates up to .078" IPT significantly reduce machining cycle times.

Optimized cutter body and chip gash design perfectly serves high-feed requirements.

PSTS inserts for powerful low cost per edge high-feed milling.

Cutters with internal coolant supply.

Nickel-plated surface protection.

VXF is a high-feed productivity booster designed to establish new industry standards with market-leading milling grades like WS40PM.

WIDIA 

widia.com

VXF™ -12

4-Edged, Victory™ X-Feed™ Mills



- 16.5° lead angle redistributes cutting forces in the spindle z-axis direction.
- Greatly reduces tool deflection and vibrations for improved tool life.
- Suitable for long tool reach.
- Unique integrated radial wiping facet to achieve a nice wall finish at pocket and helical interpolation milling.
- Durable cutting edges qualified to machine a wide range of materials.
- WS40PM — best-in-class milling grade for machining stainless steel and HTA.

Perfect combination of round and square insert style.

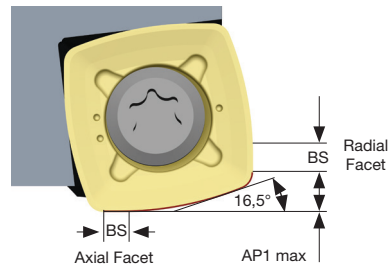

Specifically engineered chipbreakers for powerful high-feed milling.

-MM



P M S

First choice for Soft Steel, Stainless Steel, and High-Temp Alloys. Best fit for pocketing and profiling operations.

-MH

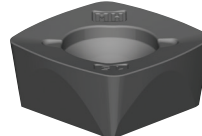

P

First choice for P3 and P4 materials. Stronger edge protection for heavy roughing jobs.

Lower Cutting Forces

Geometry Strengthening/Stronger Cutting Edge Protection

Applications

1. Face milling.
2. 3D profile milling.
3. Pocket milling into full material.
4. Helical interpolation into full material.
5. Deep pocket milling into full material.
6. Dynamic/trochoidal milling.
7. Aggressive ramp milling.
8. Contour Milling.
9. Face milling deep cavities with long tool reach.
10. Z-axis contour plunge milling.

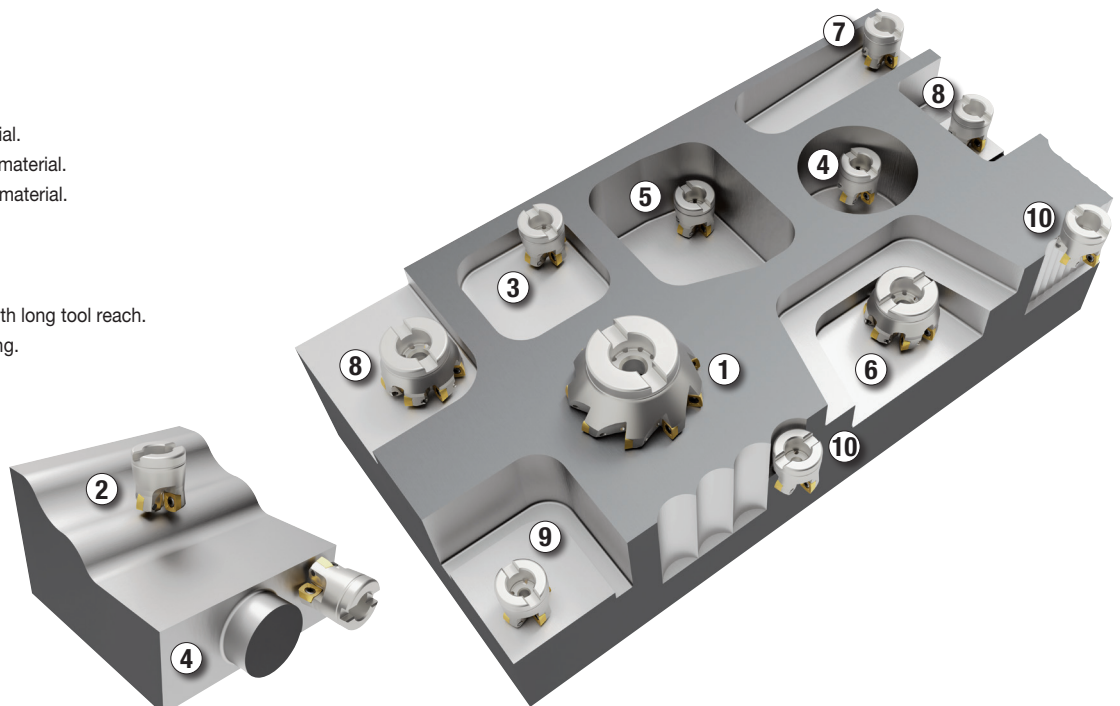

Victory™ High-Feed Mills • VXF™-12 Series

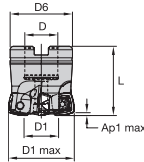

▼ Shell Mills

order number	catalog number	D1 max	D1	D	D6	L	Ap1 max	Z	max ramp angle	max RPM	coolant supply	lbs
6596763	VXF150Z04S075XD12	1.500	.785	.750	1.417	1.575	.098	4	1.0°	27500	Yes	.39
6596764	VXF200Z05S075XD12	2.000	1.284	.750	1.811	1.575	.098	5	.9°	22500	Yes	.70
6596765	VXF200Z06S075XD12	2.000	1.284	.750	1.811	1.575	.098	6	.9°	22500	Yes	.71
6596766	VXF250Z05S100XD12	2.500	1.784	1.000	1.969	1.575	.098	5	.6°	19500	Yes	.96
6596767	VXF250Z07S100XD12	2.500	1.784	1.000	1.969	1.575	.098	7	.6°	19500	Yes	1.12
6596768	VXF300Z05S100XD12	3.000	2.283	1.000	2.087	1.969	.098	5	.5°	17500	Yes	1.62
6596769	VXF300Z08S100XD12	3.000	2.283	1.000	2.087	1.969	.098	8	.5°	17500	Yes	1.86
6596770	VXF400Z06S125XD12	4.000	3.283	1.250	2.559	1.969	.098	6	.3°	14500	Yes	3.20
6596780	VXF400Z09S125XD12	4.000	3.283	1.250	2.559	1.969	.098	9	.3°	14500	Yes	3.34
6596781	VXF500Z08S150XD12	5.000	4.283	1.500	3.150	2.480	.098	8	.2°	13000	Yes	6.77

▼ Spare Parts

D1 max	insert screw	in. lbs.	wrench
1.500 - 5.000	12148007200	34	12148099400

NOTE: Please order wrench separately.

VXF™ -12

Victory™ High-Feed Mills • VXF-12 Series

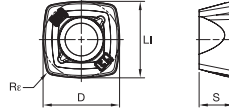

● first choice
○ alternate choice

P	●	●	○
M	●	●	●
K	○	○	○
N	○	○	○
S	●	○	●
H	○	○	○

▼ XDPT-MM • Best Fit for Pocketing and Profiling Operations

ISO catalog number	ANSI catalog number	cutting edges	LI		S		D		Re		WP25PM	WP40PM	WS40PM
			mm	in	mm	in	mm	in	mm	in			
XDPT120512ERMM	XDPT120512ERMM	4	12,70	.500	5,56	.219	12,70	.500	1,20	.047	6596438	6596439	6596439

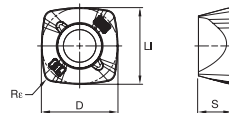

▼ XDPT-MH • Dedicated Geometry for Heavy Roughing

ISO catalog number	ANSI catalog number	cutting edges	LI		S		D		Re		WP25PM	WP40PM	WS40PM
			mm	in	mm	in	mm	in	mm	in			
XDPT120515SRMH	XDPT120515SRMH	4	12,70	.500	5,56	.219	12,70	.500	1,50	.059	6596440	6596440	6596440

▼ Insert Selection Guide

Material Group	Light Machining		General Purpose		Heavy Machining	
	Geometry	Grade	Geometry	Grade	Geometry	Grade
P1-P2	XDPT-MM	WP25PM	XDPT-MM	WS40PM	XDPT-MH	WP40PM
P3-P4	XDPT-MM	WP25PM	XDPT-MM	WS40PM	XDPT-MH	WP40PM
P5-P6	XDPT-MM	WP25PM	XDPT-MM	WS40PM	XDPT-MH	WP40PM
M1-M2	XDPT-MM	WS40PM	XDPT-MM	WS40PM	XDPT-MH	WP40PM
M3	XDPT-MM	WS40PM	XDPT-MM	WS40PM	XDPT-MH	WP40PM
S1-S2	XDPT-MM	WP25PM	XDPT-MM	WS40PM	XDPT-MH	WP40PM
S3	XDPT-MM	WS40PM	XDPT-MM	WS40PM	XDPT-MH	WP40PM
S4	XDPT-MM	WS40PM	XDPT-MM	WS40PM	XDPT-MH	WP40PM

Victory™ High-Feed Mills • VXF™-12 Series

▼ Recommended Starting Speeds [SFM]*

Material Group		WP25PM			WP40PM			WS40PM		
P	1	1295	1115	1065	1165	1015	970	-	-	-
	2	1085	950	785	985	855	705	-	-	-
	3	1000	855	690	900	770	625	-	-	-
	4	885	720	590	805	675	525	-	-	-
	5	720	675	590	675	605	525	675	575	475
	6	655	490	395	590	460	360	590	425	310
M	1	805	705	655	770	675	605	820	675	560
	2	720	625	510	690	590	490	705	575	475
	3	560	475	375	510	460	360	575	425	330
S	1	165	130	100	165	130	115	165	130	100
	2	165	130	100	165	130	115	165	130	100
	3	195	165	100	195	165	115	195	165	100
	4	280	195	130	260	195	130	230	195	115

NOTE: FIRST choice starting speeds are in **bold** type. As the average chip thickness increases, the speed should be decreased.
 *Material groups P, M, K, and H show recommended starting speeds for dry machining. For wet machining, reduce speed by 20%.
 *Material groups N and S show recommended starting speeds for wet machining. Not recommended for dry machining.

▼ Recommended Starting Feeds [IPT]

Light Machining	General Purpose	Heavy Machining
-----------------	-----------------	-----------------

At .020 Axial Depth of Cut (AP1)

Insert Geometry	Recommended Starting Feed per Tooth (Fz) in Relation to % of Radial Engagement (ae)															Insert Geometry
	5%			10%			20%			30%			40-100%			
.E..MM	.020	.058	.109	.014	.039	.067	.010	.028	.047	.009	.025	.041	.008	.022	.037	.E..MM
.S..MH	.036	.080	.141	.025	.052	.080	.019	.037	.056	.016	.032	.048	.015	.029	.043	.S..MH

At .025 Axial Depth of Cut (AP1)

Insert Geometry	Recommended Starting Feed per Tooth (Fz) in Relation to % of Radial Engagement (ae)															Insert Geometry
	5%			10%			20%			30%			40-100%			
.E..MM	.018	.051	.094	.013	.035	.059	.009	.025	.042	.008	.022	.037	.007	.020	.033	.E..MM
.S..MH	.032	.070	.118	.023	.046	.071	.017	.033	.050	.014	.029	.043	.013	.026	.039	.S..MH

At .035 Axial Depth of Cut (AP1)

Insert Geometry	Recommended Starting Feed per Tooth (Fz) in Relation to % of Radial Engagement (ae)															Insert Geometry
	5%			10%			20%			30%			40-100%			
.E..MM	.015	.043	.076	.011	.029	.050	.008	.022	.036	.007	.019	.031	.006	.017	.028	.E..MM
.S..MH	.027	.058	.093	.019	.039	.059	.014	.028	.042	.012	.024	.036	.011	.022	.033	.S..MH

NOTE: Use "Light Machining" values as starting feed rate.

▼ CAM Programming

Programming Data			
insert size	insert radius	R (to be programmed)	t
12	3/64	0.106	0.038
	1.5	0.110	0.037

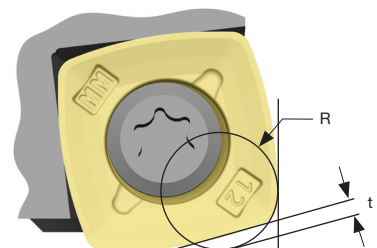

VXF™ -12

Victory™ High-Feed Mills • VXF-12 Series

Best Practices

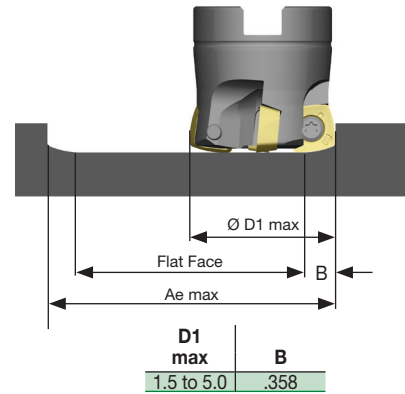
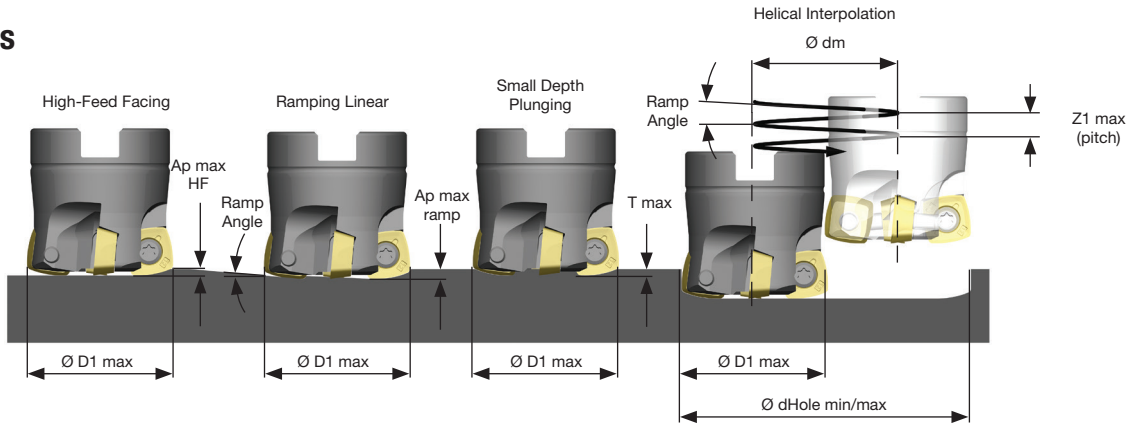

D1 max	High-feed Facing	Ramping Linear			Helical Interpolation			Small Depth Plunging
	Ap max HF	Ramp Angle max	Ap max Ramp	Ramp Angle max	d Hole min	d Hole max	Z1 max Helical	T max
1.5	.050	0.95	.070	0.95	2.130	2.920	.070	.031
2.0	.050	0.90	.070	0.90	3.370	3.920	.070	.031
2.5	.050	0.60	.070	0.60	4.130	4.920	.070	.031
3.0	.050	0.45	.070	0.45	5.130	5.920	.070	.031
4.0	.050	0.31	.070	0.31	7.130	7.920	.070	.031
5.0	.050	0.24	.070	0.24	9.130	9.920	.070	.031

$\emptyset dm = \emptyset Hole - \emptyset D1 \text{ max}$
 $Z1 = \emptyset dm \times 3,14 \times \tan \text{ ramp angle}$. $Z1 \leq Z1 \text{ max}$ and $\leq \text{ramp angle max}$
 $\text{Ramp angle} = \arcsin \left(\frac{Z1}{\emptyset dm \times 3,14} \right)$

$Ae \text{ max} \leq 2 \times \emptyset D1 \text{ max} - 2 \times B$
 $\text{Flat Face} = Ae \text{ max} - 2 \times B$

Z-Axis Plunge Milling

cutting diameter (D1)	Y max	X
1.5	0.354	1.274
2	0.354	1.527
2.5	0.354	1.743
3	0.354	1.936
4	0.354	2.272
5	0.354	2.565

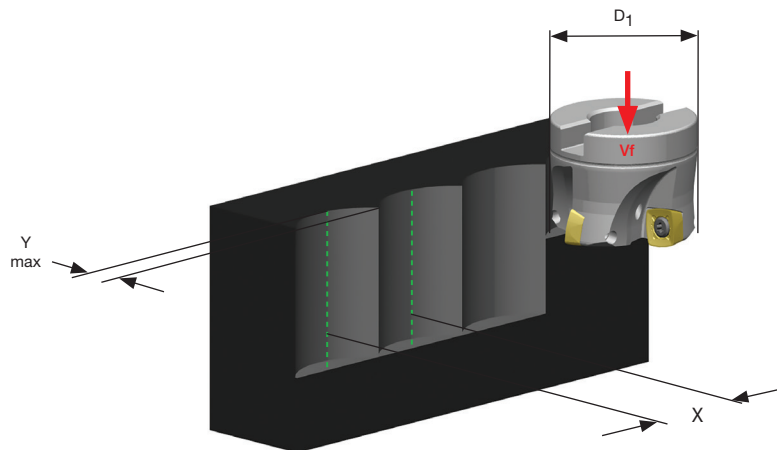

Feed Rate Guide • Z-Axis Plunge Milling • fz (mm/tooth)

Light Machining	General Purpose	Heavy Machining
-----------------	-----------------	-----------------

Insert Geometry	Recommended Starting Feed per Tooth (Fz)			Insert Geometry	Y max
.E..MM	.003	.008	.012	.E..MM	.358
.S..MH	.004	.010	.014	.S..MH	.358

Designed to Make Your Workplace More Productive

WIDIA™ X-Feed™

WIDIA-branded X-Feed tooling was created as an application-specific portfolio to remove as much material as possible in the shortest amount of time, using a shallow depth of cut to achieve higher MRR and boost productivity.



HIGH-FEED MILLING



BOOST PRODUCTIVITY



Victory™ X-Feed For Machining Stainless Steel and Titanium

7FNS Series

Designed for circular plunging and ramping, 3D machining, face milling, and pocketing applications.



Victory X-Feed To Speed Up High-Feed Machining

VXF™-12 Series

VXF is a high-feed productivity booster designed to establish new industry standards with market-leading milling grades like WS40PM.

WIDIA-HANITA™

A SOLID FOUNDATION THE VARIMILL™ FAMILY

The WIDIA-Hanita VariMill family continues to provide leading-edge solutions for some of the most advanced applications in the general engineering, aerospace, and defense industries. These industries require complex machining techniques in some of the most exotic materials.

VariMill I™

This 4-flute geometry is designed with unequal flute spacing for plunging, slotting, and profiling at the highest possible feed rates for a wide range of materials.





VariMill II™

This 5-flute geometry is designed with unequal flute spacing for advanced milling jobs in a wide range of materials.



VariMill III™

This 7-flute geometry is designed with unequal flute spacing and is designed to provide the highest Metal Removal Rates (MRR) and extended tool life in the most demanding materials in the aerospace industry.

COMING SOON!

See the entire VariMill™ platform in the 2019 VariMill Family Catalog coming soon!

WIDIA™ HANITA 

widia.com

7FNS

VICTORY™ X-FEED™



PRODUCTIVITY IMPROVED IN
HIGH-FEED MILLING OF STAINLESS
STEEL AND TITANIUM MATERIALS



7FNS Series

Designed for high-feed rates.

6 flutes and 3 x D diameter neck reach.

Designed for circular plunging and ramping, 3D machining, face milling, and pocketing applications.

Stainless steel and high-temp alloys.

Improved tool life due to reduced radial forces.

Larger radial engagement vs. standard ball nose end mills.



5-10%
Radial engagement



55%
Radial engagement



▼ 7FNS Series • X-Feed

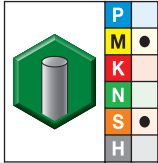

grade AlTiN-MT
AlTiN

- first choice
- alternate choice

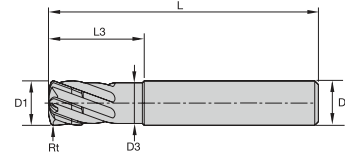
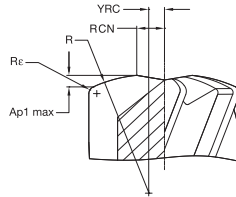

order #	catalog #	D1	D	D3	L3	length L	Re	Rt
6441876	7FNS07002	1/4	1/4	.21	.73	2 1/2	.016	.027
6441877	7FNS10004	3/8	3/8	.34	1.23	3 1/2	.023	.040
6441878	7FNS13005	1/2	1/2	.46	1.48	4	.031	.054
6441879	7FNS16006	5/8	5/8	.59	1.98	4 1/2	.039	.067
6441880	7FNS19007	3/4	3/4	.71	2.48	5	.047	.080
6441881	7FNS25008	1	1	.96	2.98	5 1/2	.063	.106

NOTE: YRC = distance from center line to the crown of the R radius.
 RCN = distance from center line to the start of the cutting edge. This dimension can also help determine the minimum circle size when helical ramping.
 R = the head radius size.
 Re = the shoulder radius or radius at the corner of the cutter.



End Mill Tolerances

D1	tolerance	D	tolerance h6 + / -
All	+.000/-.002	< 1/8"	0/.00024
-	-	1/8-7/32"	0/.00031
-	-	1/4-3/8"	0/.00035
-	-	13/32-11/16"	0/.00043
-	-	23/32-1 3/16"	0/.00051

▼ Programming Data

7FNS Inch																
Geometrical Parameters									Ramping Guide for Circular and Linear Interpolation							
									Circular Interpolation				Linear Interpolation			
									Allowed Range of Hole Diameter		Calculated Length (mm) per Ramp Angle					
diameter	Ap1 max	Rfm	Rt	Rc	Xfm	Yfm	YD	Number	Smallest	Largest	Ramp Angle (degree)					
[inch]	[inch]	[inch]	[inch]	[inch]	[inch]	[inch]	[inch]	flutes			1	2	3	4	5	
1/4	0.0133	1/4	0.0269	0.0160	0.0133	0.0313	0.0525	6	0.355	0.5	0.76	0.38	0.25	0.19	0.15	
3/8	0.0200	3/8	0.0399	0.0235	0.0200	0.0469	0.0788	6	0.5325	0.75	1.14	0.57	0.38	0.29	0.23	
1/2	0.0266	1/2	0.0538	0.0320	0.0266	0.0625	0.1050	6	0.71	1	1.52	0.76	0.51	0.38	0.30	
5/8	0.0333	5/8	0.0672	0.0400	0.0333	0.0781	0.1313	6	0.8875	1.25	1.91	0.95	0.63	0.48	0.38	
3/4	0.0399	3/4	0.0798	0.0470	0.0399	0.0938	0.1575	6	1.065	1.5	2.29	1.14	0.76	0.57	0.46	
1	0.0532	1	0.1059	0.0620	0.0532	0.1250	0.2100	6	1.42	2	3.05	1.52	1.02	0.76	0.61	
Recommended Feed											30%	30%	30%	30%	10%	

▼ 7FNS Series • X-Feed

Material Group														
	Profile Milling		AlTiN-MT			Recommended feed per tooth (IPT = inch/th) for 3D milling/profiling (A)								
	A		Cutting Speed – Vc SFM			frac.	D1 – Diameter							
	ap	ae	min		max		dec.	1/4	5/16	3/8	1/2	5/8	3/4	1
M	1	0.5 x D	0.55 x D	290	–	375	IPT	.0118	.0156	.0188	.0213	.0281	.0338	.0450
	2	0.5 x D	0.55 x D	190	–	260	IPT	.0094	.0125	.0150	.0189	.0250	.0300	.0400
	3	0.5 x D	0.55 x D	190	–	230	IPT	.0094	.0125	.0150	.0189	.0250	.0300	.0400
S	1	0.5 x D	0.55 x D	165	–	295	IPT	.0106	.0141	.0169	.0197	.0254	.0300	.0400
	2	0.5 x D	0.55 x D	165	–	260	IPT	.0094	.0125	.0150	.0189	.0234	.0263	.0360
	3	0.5 x D	0.55 x D	80	–	130	IPT	.0071	.0094	.0113	.0138	.0168	.0188	.0240
	4	0.5 x D	0.55 x D	165	–	190	IPT	.0083	.0109	.0131	.0165	.0219	.0263	.0350

NOTE: Lower value of cutting speed is used for high-stock removal applications or for higher hardness (machinability) within group.
 Higher value of cutting speed is used for finishing applications or for lower hardness (machinability) within group.
 For smaller taper machining centers, please adjust parameters accordingly on diameters greater than 1/2".

4U50 & 4U80



AEROSPACE ROUGHING

NEW!



4U50

Shallow pitch rougher.

4–6 flutes with variable spacing.

Short length of cut and 3 x D diameter neck length.

Stainless steel and high-temp alloys.

Center cutting.



4U80

Shallow pitch rougher.

4–6 flutes with variable spacing.

Regular length of cut.

Stainless steel and high-temp alloys.

Center cutting.

WIDIA 

widia.com

High-Performance Roughers

4U50 Series



▼ 4U50 Series

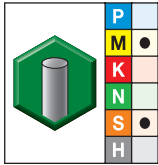

grade AITiN-MT
AITiN

- first choice
- alternate choice

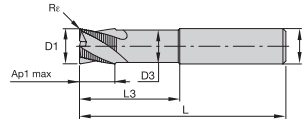

order #	catalog #	D1	D	D3	length of cut Ap1 max	L3	length L	Re	ZU
6441870	4U50E0700R2BT	1/4	1/4	.24	3/8	.75	2 1/2	.030	4
6441871	4U50E1000R4BT	3/8	3/8	.35	1/2	1.13	3	.030	4
6441872	4U50E1300R5BT	1/2	1/2	.47	5/8	1.50	3 1/2	.030	4
6441873	4U50E1601R6BT	5/8	5/8	.59	5/8	1.88	4	.030	6
6441874	4U50E1901R7XT	3/4	3/4	.71	3/4	2.25	4 1/2	.050	6
6441875	4U50E2501R8XT	1	1	.94	1	3.00	5 1/2	.050	6

End Mill Tolerances

D1	tolerance d11	D	tolerance h6 + / -
< 1/8"	-.0008/-0.0031	< 1/8"	0/.00024
1/8-7/32"	-.0012/-0.0041	1/8-7/32"	0/.00031
1/4-3/8"	-.0016/-0.0051	1/4-3/8"	0/.00035
13/32-11/16"	-.002/-0.0063	13/32-11/16"	0/.00043
23/32-1-3/16"	-.0026/-0.0077	23/32-1 3/16"	0/.00051

▼ 4U50 Series

Material Group	Side Milling (A) and Slotting (B)		AITiN-MT		Recommended feed per tooth (IPT = inch/th) for side milling (A). For slotting (B), reduce IPT by 20%.										
	A		B	Cutting Speed – Vc SFM		D1 – Diameter									
	ap	ae	ap	min	max	frac.	1/4	5/16	3/8	1/2	5/8	3/4	1		
						dec.	.2500	.3125	.3750	.5000	.6250	.7500	1.0000		
M	1	1 x D	0.5 x D	0.75 x D	297	–	379.5	IPT	.0015	.0020	.0023	.0029	.0034	.0038	.0046
	2	1 x D	0.5 x D	0.75 x D	198	–	264	IPT	.0012	.0016	.0018	.0023	.0027	.0030	.0036
	3	1 x D	0.5 x D	0.75 x D	198	–	231	IPT	.0010	.0013	.0015	.0019	.0022	.0024	.0028
S	1	1 x D	0.3 x D	0.75 x D	165	–	297	IPT	.0015	.0020	.0023	.0029	.0034	.0038	.0046
	2	1 x D	0.3 x D	0.3 x D	82.5	–	132	IPT	.0008	.0010	.0012	.0016	.0018	.0020	.0025
	3	1 x D	0.4 x D	0.75 x D	198	–	264	IPT	.0012	.0016	.0018	.0023	.0027	.0030	.0036
	4	1 x D	0.4 x D	0.75 x D	165	–	198	IPT	.0011	.0014	.0017	.0022	.0025	.0028	.0033

NOTE: Lower value of cutting speed is used for high-stock removal applications or for higher hardness (machinability) within group.

Higher value of cutting speed is used for finishing applications or for lower hardness (machinability) within group.

Above parameters are based on ideal conditions. For smaller taper machining centers, please adjust parameters accordingly on diameters greater than 1/2".



▼ 4U80 Series

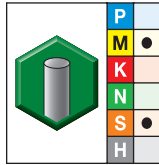

grade AlTiN-MT
AlTiN

- first choice
- alternate choice

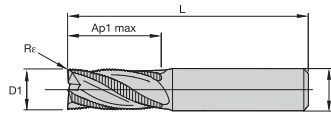

order #	catalog #	D1	D	length of cut Ap1 max	length L	Re	ZU
6441861	4U80E0700R2BT	1/4	1/4	3/4	2 1/2	.030	4
6441862	4U80E0800R3BT	5/16	5/16	13/16	2 1/2	.030	4
6441863	4U80E1000R4BT	3/8	3/8	7/8	2 1/2	.030	4
6441864	4U80E1300R5BT	1/2	1/2	1 1/4	3	.030	4
6441865	4U80E1600R6BT	5/8	5/8	1 7/8	4	.030	6
6441866	4U80E1900R7XT	3/4	3/4	1 1/2	4	.050	4
6441867	4U80E1901R7XT	3/4	3/4	1 1/2	4	.050	6
6441868	4U80E2500R8XT	1	1	1 1/2	4	.050	4
6441869	4U80E2501R8XT	1	1	1 1/2	4	.050	6

End Mill Tolerances

D1	tolerance d11	D	tolerance h6 + / -
< 1/8"	-.0008/-.0031	< 1/8"	0/.00024
1/8-7/32"	-.0012/-.0041	1/8-7/32"	0/.00031
1/4-3/8"	-.0016/-.0051	1/4-3/8"	0/.00035
13/32-11/16"	-.002/-0.0063	13/32-11/16"	0/.00043
23/32-1-3/16"	-.0026/-.0077	23/32-1 3/16"	0/.00051

▼ 4U80 Series

Material Group	Side Milling (A) and Slotting (B)		AITiN-MT		Recommended feed per tooth (IPT = inch/th) for side milling (A). For slotting (B), reduce IPT by 20%.										
	A		B		Cutting Speed – Vc SFM	D1 – Diameter									
	ap	ae	ap	min		max	frac.	1/4	5/16	3/8	1/2	5/8	3/4	1	
					dec.		.2500	.3125	.3750	.5000	.6250	.7500	1.0000		
M	1	1 x D	0.5 x D	0.75 x D	290	–	380	IPT	.0015	.0020	.0023	.0029	.0034	.0038	.0046
	2	1 x D	0.5 x D	0.75 x D	200	–	265	IPT	.0012	.0016	.0018	.0023	.0027	.0030	.0036
	3	1 x D	0.5 x D	0.75 x D	200	–	230	IPT	.0010	.0013	.0015	.0019	.0022	.0024	.0028
S	1	1 x D	0.3 x D	0.75 x D	160	–	300	IPT	.0015	.0020	.0023	.0029	.0034	.0038	.0046
	2	1 x D	0.3 x D	0.3 x D	80	–	130	IPT	.0008	.0010	.0012	.0016	.0018	.0020	.0025
	3	1 x D	0.4 x D	0.75 x D	200	–	265	IPT	.0012	.0016	.0018	.0023	.0027	.0030	.0036
	4	1 x D	0.4 x D	0.75 x D	165	–	200	IPT	.0011	.0014	.0017	.0022	.0025	.0028	.0033

NOTE: Lower value of cutting speed is used for high-stock removal applications or for higher hardness (machinability) within group.
Higher value of cutting speed is used for finishing applications or for lower hardness (machinability) within group.
Above parameters are based on ideal conditions. For smaller taper machining centers, please adjust parameters accordingly on diameters greater than 1/2".

ALUSURF™ 5AN2



LINE EXPANSION

AluSurf end mills provide extraordinary Metal Removal Rates (MRR) by combining roughing and finishing operations for any aluminum plunging, slotting, and profiling application. Its proprietary flute geometry is designed for rigidity and improved chip evacuation generating exceptional wall-to-floor perpendicularity, even in thin wall applications. To ensure a superior floor surface finish, the AluSurf front geometry is equipped with a wiper facet grind.

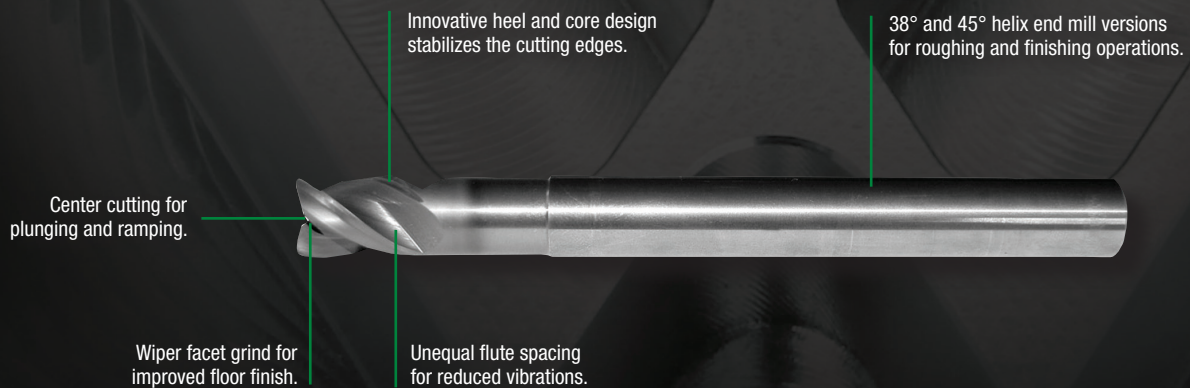



AluSurf™ 5AN2 Series

One tool for roughing and finishing operations.

Slotting depths up to $1 \times D$ and peripheral milling up to $1.5 \times D$ axial at $.5 \times D$ radially.

Unequal flute spacing for chatter-free performance (3-flute series only).

Multiple corner radii and extended neck configurations available as standard.

Increase your output due to less tool changes and increased Metal Removal Rates (MRR).

No specific tools for roughing and finishing necessary.

Less passes due to $1 \times D$ slotting capability.

Perfect for MQL (Minimum Quantity Lubrication) methods.

WIDIA 

widia.com



▼ 5AN2 Series • AluSurf

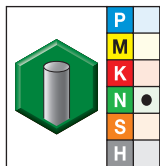

grade UNCOATED

- first choice
- alternate choice

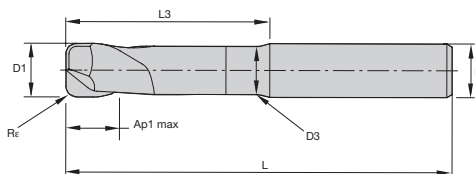

order #	catalog #	D1	D	D3	length of cut Ap1 max	L3	length L	Re
3336000	5AN203042A	1/8	1/4	.12	3/16	1/2	3	.015
3336001	5AN205042A	3/16	1/4	.18	1/4	9/16	3	.015
3336002	5AN207042A	1/4	1/4	.23	5/16	3/4	3	.015
3659287	5AN207042	1/4	1/4	.23	5/16	3/4	3	—
3683906	5AN207012B	1/4	1/4	.23	3/8	2 1/4	4	.030
3659288	5AN207012	1/4	1/4	.23	3/8	2 1/4	4	—
3336083	5AN208043B	5/16	5/16	.29	3/8	1	4	.030
3659289	5AN208023	5/16	5/16	.29	3/8	2	4	—
3336084	5AN210044B	3/8	3/8	.35	7/16	1 1/8	4	.030
3683910	5AN210014C	3/8	3/8	.35	7/16	2 1/4	4	.060
3474843	5AN210014	3/8	3/8	.35	7/16	2 1/4	4	—
3683911	5AN213045C	1/2	1/2	.47	9/16	1 1/2	5	.060
6457780	5AN213045E	1/2	1/2	.47	9/16	1 1/2	5	.120
3659292	5AN213045	1/2	1/2	.47	9/16	1 1/2	5	—
3683913	5AN213005B	1/2	1/2	.47	9/16	2 1/4	5	.030
3683914	5AN213005C	1/2	1/2	.47	9/16	2 1/4	5	.060
6457801	5AN213005E	1/2	1/2	.47	9/16	2 1/4	5	.120
3474844	5AN213005	1/2	1/2	.47	9/16	2 1/4	5	—
3683916	5AN213015B	1/2	1/2	.47	9/16	3 1/4	6	.030
6457802	5AN213015E	1/2	1/2	.47	9/16	3 1/4	6	.120
3659487	5AN213015	1/2	1/2	.47	9/16	3 1/4	6	—
3683919	5AN216016B	5/8	5/8	.59	3/4	3 1/4	6	.030
3659488	5AN216016	5/8	5/8	.59	3/4	3 1/4	6	—
3683922	5AN219057B	3/4	3/4	.70	1	1 1/2	6	.030
3683923	5AN219057C	3/4	3/4	.70	1	1 1/2	6	.060
3659489	5AN219057	3/4	3/4	.70	1	1 1/2	6	—
6457803	5AN219057E	3/4	3/4	.71	1	1 1/2	6	.120
3683925	5AN219077B	3/4	3/4	.70	1	2 1/4	6	.030
3683926	5AN219077C	3/4	3/4	.70	1	2 1/4	6	.060
6457804	5AN219077E	3/4	3/4	.71	1	2 1/4	6	.120
3683928	5AN219017B	3/4	3/4	.70	1	3 1/4	6	.030
3683929	5AN219017C	3/4	3/4	.70	1	3 1/4	6	.060

(continued)

5AN2 Series

(5AN2 Series • AluSurf™ — continued)

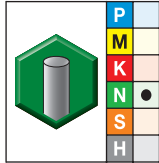

grade UNCOATED

- first choice
- alternate choice

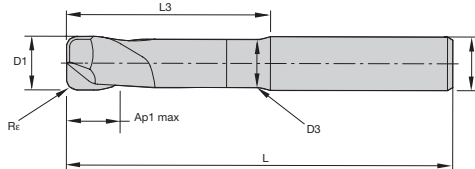

order #	catalog #	D1	D	D3	length of cut Ap1 max	L3	length L	Re
3683930	5AN219017D	3/4	3/4	.70	1	3 1/4	6	.090
3659491	5AN219017	3/4	3/4	.70	1	3 1/4	6	—
6457805	5AN219017E	3/4	3/4	.71	1	3 1/4	6	.120
3683931	5AN225048B	1	1	.94	1 1/8	3	5 1/2	.030
3336088	5AN225048C	1	1	.94	1 1/8	3	5 1/2	.060
6457806	5AN225048E	1	1	.94	1 1/2	3	5 1/2	.120
3659492	5AN225048	1	1	.94	1 1/8	3	5 1/2	—
3683933	5AN225028C	1	1	.94	1 1/8	4 1/4	7	.060
6457807	5AN225028E	1	1	.94	1 1/2	4 1/4	7	.120

End Mill Tolerances

D1	tolerance	D	tolerance h6 + / -
< 1/8"	0/.00024	< 1/8"	0/.00024
1/8–7/32"	0/.00031	1/8–7/32"	0/.00031
1/4–3/8"	0/.00035	1/4–3/8"	0/.00035
13/32–11/16"	0/.00043	13/32–11/16"	0/.00043
23/32–1 3/16"	0/.00051	23/32–1 3/16"	0/.00051

▼ 5AN2 Series • AluSurf

Material Group	Side Milling (A) and Slotting (B)		Uncoated		Recommended feed per tooth (IPT = inch/th) for side milling (A). For slotting (B), reduce IPT by 20%.													
	A		B		Cutting Speed – vc SFM		D1 – Diameter											
	ap		ae		min		max		frac.	1/8	3/16	1/4	5/16	3/8	1/2	5/8	3/4	1
	ap	ae	ap	ae	min	max	dec.	.1250	.1880	.2500	.3130	.3750	.5000	.6250	.7500	1.000		
N	1	1 x D	0.5 x D	1 x D	1640	–	6560	IPT	.0013	.0019	.0025	.0031	.0038	.0050	.0063	.0075	.0100	
	2	1 x D	0.5 x D	1 x D	1640	–	4920	IPT	.0010	.0015	.0020	.0025	.0030	.0040	.0050	.0060	.0080	
	3	1 x D	0.5 x D	1 x D	1640	–	4920	IPT	.0009	.0013	.0018	.0022	.0026	.0035	.0044	.0053	.0070	
	4	1 x D	0.5 x D	1 x D	1310	–	2460	IPT	.0009	.0013	.0018	.0022	.0026	.0035	.0044	.0053	.0070	
	4	1 x D	0.5 x D	1 x D	820	–	3280	IPT	.0011	.0017	.0023	.0028	.0034	.0045	.0056	.0068	.0090	

NOTE: Side milling applications — For longest reach (L3) tools, reduce ae by 30%.
 Slot milling applications — For longest reach (L3) tools, reduce ap by 30%.
 For cutting aluminum with high silicon, coating is recommended.
 For spindles with ceramic bearings, multiply ap by 0.5.
 For better surface finish, reduce feed per tooth.
 Above parameters are based on ideal conditions. For smaller taper machining centers, please adjust parameters accordingly on diameters greater than 1/2".

TDMX

TOP DRILL™ MODULAR X



STABILITY AND RELIABILITY
COMBINED INTO ONE MODULAR
DRILL SYSTEM





Platform

Standard cutter bodies in 3 x D, 5 x D, and 8 x D lengths.

Insert diameter range from .629" up to 1.574".

One geometry and grade to cover steel and cast iron applications.

Easy to Apply

Front clamping design. No need to disassemble the body from the holder to change insert.

Easy insert nomenclature logic to identify the targeted material group.

Increased Stability and Performance

Highly engineered pocket seat design to ensure maximum stability, even in challenging applications like cross hole, inclined entry/exit, and interrupted cuts.

Suitable for high feed rates.

Flanged shank for higher rigidity.

Polished flutes for improved chip evacuation.

Brand new WP40PD grade for longer tool life in steel and cast iron applications.

WIDIA™ TOP DRILL™ Modular X (TDMX) is the ultimate choice for high-demanding drilling applications when stability and reliability are required.

WIDIA 

widia.com

TDMX — TOP DRILL™ Modular X

Extra-Stable Modular Drill up to 1.574" Diameter

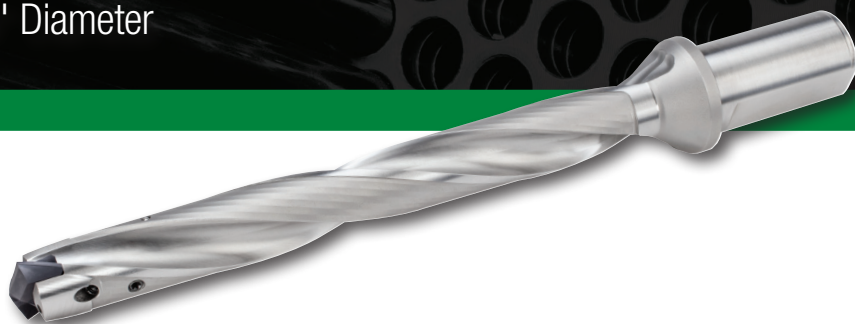

- Augmented insert stability thanks to the highly engineered pocket seat design.
- Front clamping for an easy insert change, without disassembling the holder from the machine spindle.
- Diameter range from .629" up to 1.574".
- L/D ratio of 3 x D, 5 x D, and 8 x D.

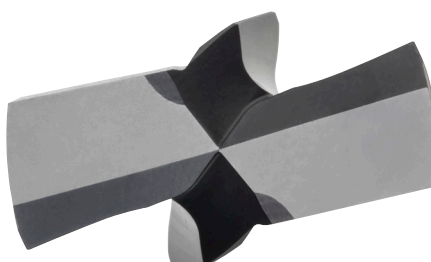

One geometry to cover two material groups in modular drilling.

PK



First choice for Steel and Cast Iron drilling.

TDMX — Tube Sheet Drilling

P Steel

Material: Fe510/1.0553/A441
Condition: rough surface

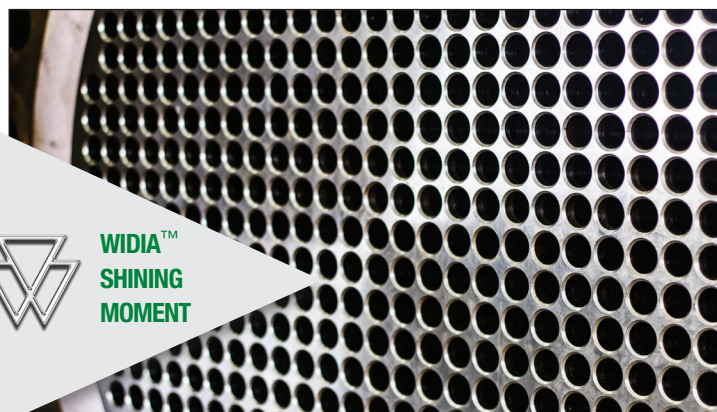

Specifications	Competitor	WIDIA
Diameter (Inch)	1.00"	1.00"
Grade	—	WP40PD
Geometry	—	PK
Vc (SFM)	300	300
n (rev/min)	1.247	1.247
f (IPR)	0.013	0.014
Vf (in/min)	15.7	17.2
LOC (in)	2	2
Coolant	Internal Emulsion	Internal Emulsion
Tool Life (ft)	98.4	157.4



WIDIA™
SHINING
MOMENT

▼ TDMX Body – Technical Details

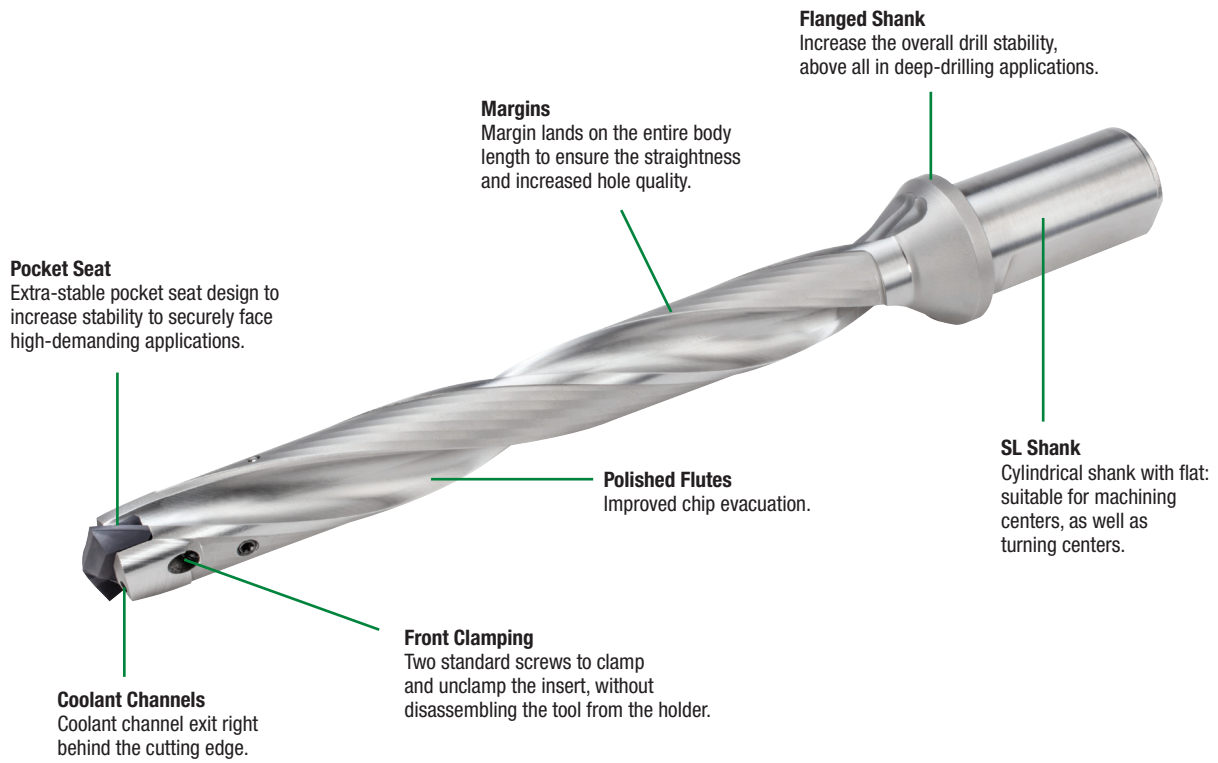

▼ TDMX Pocket Seat – Technical Details

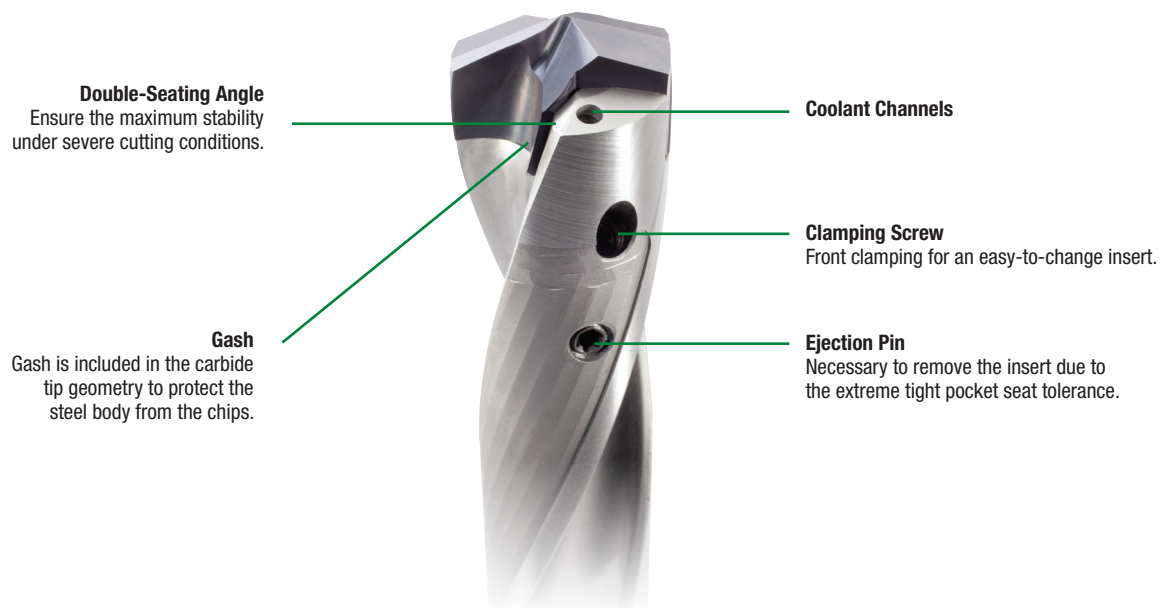

TDMX — TOP DRILL™ Modular X

Modular Drill System • TDMX

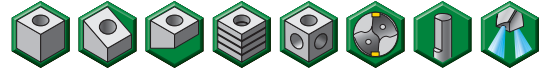
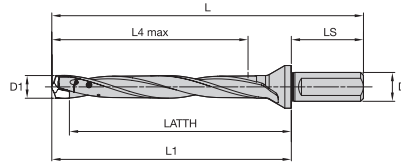

▼ TOP DRILL Modular X • 3 x D / 5 x D / 8 x D • Side Lock Shank • Inch



3 x D		5 x D		8 x D		D1			clamping screw wrench	
order #	catalog #	order #	catalog #	order #	catalog #	SSC	min	max		
6572186	TDMX0630R3SL075	6572206	TDMX0630R5SL075	6572247	TDMX0630R8SL075	A	.6300	.6692	193.537	12148086600
6572187	TDMX0670R3SL075	6572207	TDMX0670R5SL075	6572248	TDMX0670R8SL075	B	.6693	.7086	193.537	12148086600
6572188	TDMX0709R3SL100	6572208	TDMX0709R5SL100	6572249	TDMX0709R8SL100	C	.7087	.7480	193.537	12148086600
6572189	TDMX0749R3SL100	6572210	TDMX0749R5SL100	6572250	TDMX0749R8SL100	D	.7481	.7874	193.537	12148086600
6572190	TDMX0788R3SL100	6572231	TDMX0788R5SL100	6572251	TDMX0788R8SL100	E	.7875	.8267	193.523	170.0240
6572191	TDMX0827R3SL100	6572232	TDMX0827R5SL100	6572252	TDMX0827R8SL100	F	.8268	.8661	193.523	170.0240
6572192	TDMX0867R3SL100	6572233	TDMX0867R5SL100	6572253	TDMX0867R8SL100	G	.8662	.9055	193.523	170.0240
6572193	TDMX0906R3SL100	6572234	TDMX0906R5SL100	6572254	TDMX0906R8SL100	H	.9056	.9448	193.523	170.0240
6572194	TDMX0945R3SL125	6572235	TDMX0945R5SL125	6572255	TDMX0945R8SL125	I	.9449	.9842	193.524	12148082400
6572195	TDMX0985R3SL125	6572236	TDMX0985R5SL125	6572256	TDMX0985R8SL125	J	.9843	1.0236	193.524	12148082400
6572196	TDMX1024R3SL125	6572237	TDMX1024R5SL125	6572257	TDMX1024R8SL125	K	1.0237	1.0629	193.524	12148082400
6572197	TDMX1063R3SL125	6572238	TDMX1063R5SL125	6572258	TDMX1063R8SL125	L	1.0630	1.1023	193.524	12148082400
6572198	TDMX1103R3SL125	6572239	TDMX1103R5SL125	6572259	TDMX1103R8SL125	M	1.1024	1.1417	193.525	TT15
6572199	TDMX1142R3SL125	6572240	TDMX1142R5SL125	6572260	TDMX1142R8SL125	N	1.1418	1.1811	193.525	TT15
6572200	TDMX1182R3SL125	6572241	TDMX1182R5SL125	6572261	TDMX1182R8SL125	O	1.1812	1.2204	193.525	TT15
6572201	TDMX1221R3SL125	6572242	TDMX1221R5SL125	6572262	TDMX1221R8SL125	P	1.2205	1.2598	193.525	TT15
6572202	TDMX1260R3SL150	6572243	TDMX1260R5SL150	6572263	TDMX1260R8SL150	Q	1.2599	1.3385	193.525	TT15
6572203	TDMX1339R3SL150	6572244	TDMX1339R5SL150	6572264	TDMX1339R8SL150	R	1.3386	1.4173	193.525	TT15
6572204	TDMX1418R3SL150	6572245	TDMX1418R5SL150	6572265	TDMX1418R8SL150	S	1.4174	1.4960	193.585	TT15
6572205	TDMX1497R3SL150	6572246	TDMX1497R5SL150	6572266	TDMX1497R8SL150	T	1.4961	1.5748	193.585	TT15

NOTE: SSC = Pocket Seat Reference. To correspond with the SSC on the inserts.

▼ Dimensions

SSC	in ∅		SHORT ~3 x D						LONG ~5 x D				EXTRA LONG ~8 x D			
	D1 min	D1 max	LS	D	LATTH	L	L1	L4 max	LATTH	L	L1	L4 max	LATTH	L	L1	L4 max
A	.6300	.6692	1.97	.75	2.71	5.16	3.19	2.01	4.05	6.50	4.53	3.35	6.06	8.50	6.54	5.35
B	.6693	.7086	1.97	.75	2.91	5.35	3.39	2.13	4.32	6.77	4.80	3.54	6.45	8.90	6.93	5.67
C	.7087	.7480	2.20	1.00	3.02	5.75	3.54	2.24	4.52	7.24	5.04	3.74	6.76	9.49	7.28	5.98
D	.7481	.7874	2.20	1.00	3.22	5.94	3.74	2.36	4.79	7.52	5.31	3.94	7.15	9.88	7.68	6.30
E	.7875	.8267	2.20	1.00	3.33	6.10	3.90	2.48	4.98	7.76	5.55	4.13	7.46	10.24	8.03	6.61
F	.8268	.8661	2.20	1.00	3.53	6.30	4.09	2.60	5.26	8.03	5.83	4.33	7.86	10.63	8.43	6.93
G	.8662	.9055	2.20	1.00	3.64	6.46	4.25	2.72	5.45	8.27	6.06	4.53	8.17	10.98	8.78	7.24
H	.9056	.9448	2.20	1.00	3.84	6.65	4.45	2.83	5.73	8.54	6.34	4.72	8.56	11.38	9.17	7.56
I	.9449	.9842	2.36	1.25	3.95	6.97	4.61	2.95	5.92	8.94	6.57	4.92	8.87	11.89	9.53	7.87
J	.9843	1.0236	2.36	1.25	4.15	7.17	4.80	3.07	6.20	9.21	6.85	5.12	9.27	12.28	9.92	8.19
K	1.0237	1.0629	2.36	1.25	4.26	7.32	4.96	3.19	6.39	9.45	7.09	5.31	9.58	12.64	10.28	8.50
L	1.0630	1.1023	2.36	1.25	4.46	7.52	5.16	3.31	6.67	9.72	7.36	5.51	9.97	13.03	10.67	8.82
M	1.1024	1.1417	2.36	1.25	4.57	7.68	5.31	3.43	6.86	9.96	7.60	5.71	10.28	13.39	11.02	9.13
N	1.1418	1.1811	2.36	1.25	4.77	7.87	5.51	3.54	7.13	10.24	7.87	5.91	10.68	13.78	11.42	9.45
O	1.1812	1.2204	2.36	1.25	4.89	8.03	5.67	3.66	7.33	10.47	8.11	6.10	10.99	14.13	11.77	9.76
P	1.2205	1.2598	2.36	1.25	5.08	8.23	5.87	3.78	7.60	10.75	8.39	6.30	11.38	14.53	12.17	10.08
Q	1.2599	1.3385	2.76	1.50	5.35	8.98	6.22	4.02	8.03	11.65	8.90	6.69	12.05	15.67	12.91	10.71
R	1.3386	1.4173	2.76	1.50	5.71	9.33	6.57	4.25	8.54	12.17	9.41	7.09	12.80	16.42	13.66	11.34
S	1.4174	1.4960	2.76	1.50	5.98	9.69	6.93	4.49	8.97	12.68	9.92	7.48	13.46	17.17	14.41	11.97
T	1.4961	1.5748	2.76	1.50	6.33	10.04	7.28	4.72	9.48	13.19	10.43	7.87	14.20	17.91	15.16	12.60

Modular Drill System • TDMX

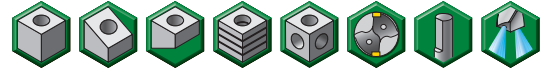
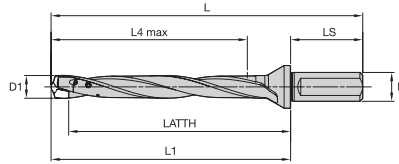

▼ TOP DRILL Modular X • 3 x D / 5 x D / 8 x D • Side Lock Shank • Metric



3 x D		5 x D		8 x D		SSC	D1		clamping screw	wrench
order #	catalog #	order #	catalog #	order #	catalog #		min	max		
6572091	TDMX160R3SL20M	6572125	TDMX160R5SL20M	6572155	TDMX160R8SL20M	A	16,000	16,999	193.537	12148086600
6572092	TDMX170R3SL20M	6572126	TDMX170R5SL20M	6572156	TDMX170R8SL20M	B	17,000	17,999	193.537	12148086600
6572093	TDMX180R3SL25M	6572127	TDMX180R5SL25M	6572157	TDMX180R8SL25M	C	18,000	18,999	193.537	12148086600
6572094	TDMX190R3SL25M	6572128	TDMX190R5SL25M	6572158	TDMX190R8SL25M	D	19,000	19,999	193.537	12148086600
6572096	TDMX200R3SL25M	6572129	TDMX200R5SL25M	6572159	TDMX200R8SL25M	E	20,000	20,999	193.523	170.0240
6572097	TDMX210R3SL25M	6572130	TDMX210R5SL25M	6572160	TDMX210R8SL25M	F	21,000	21,999	193.523	170.0240
6572098	TDMX220R3SL25M	6572141	TDMX220R5SL25M	6572171	TDMX220R8SL25M	G	22,000	22,999	193.523	170.0240
6572099	TDMX230R3SL25M	6572142	TDMX230R5SL25M	6572172	TDMX230R8SL25M	H	23,000	23,999	193.523	170.0240
6572100	TDMX240R3SL32M	6572143	TDMX240R5SL32M	6572173	TDMX240R8SL32M	I	24,000	24,999	193.524	12148082400
6572101	TDMX250R3SL32M	6572144	TDMX250R5SL32M	6572174	TDMX250R8SL32M	J	25,000	25,999	193.524	12148082400
6572102	TDMX260R3SL32M	6572145	TDMX260R5SL32M	6572175	TDMX260R8SL32M	K	26,000	26,999	193.524	12148082400
6572104	TDMX270R3SL32M	6572146	TDMX270R5SL32M	6572176	TDMX270R8SL32M	L	27,000	27,999	193.524	12148082400
6572105	TDMX280R3SL32M	6572147	TDMX280R5SL32M	6572177	TDMX280R8SL32M	M	28,000	28,999	193.525	TT15
6572106	TDMX290R3SL32M	6572148	TDMX290R5SL32M	6572178	TDMX290R8SL32M	N	29,000	29,999	193.525	TT15
6572107	TDMX300R3SL32M	6572149	TDMX300R5SL32M	6572179	TDMX300R8SL32M	O	30,000	30,999	193.525	TT15
6572108	TDMX310R3SL32M	6572150	TDMX310R5SL32M	6572180	TDMX310R8SL32M	P	31,000	31,999	193.525	TT15
6572109	TDMX320R3SL40M	6572151	TDMX320R5SL40M	6572181	TDMX320R8SL40M	Q	32,000	33,999	193.525	TT15
6572110	TDMX340R3SL40M	6572152	TDMX340R5SL40M	6572182	TDMX340R8SL40M	R	34,000	35,999	193.525	TT15
6572121	TDMX360R3SL40M	6572153	TDMX360R5SL40M	6572183	TDMX360R8SL40M	S	36,000	37,999	193.585	TT15
6572122	TDMX380R3SL40M	6572154	TDMX380R5SL40M	6572184	TDMX380R8SL40M	T	38,000	40,000	193.585	TT15

NOTE: SSC = Pocket Seat Reference. To correspond with the SSC on the inserts.

▼ Dimensions

SSC	mm ∅			LS	D	SHORT ~3 x D				LONG ~5 x D				EXTRA LONG ~8 x D			
	D1 min	D1 max				LATTH	L	L1	L4 max	LATTH	L	L1	L4 max	LATTH	L	L1	L4 max
A	16,000	16,999		50	20	68,8	131	81	51	102,8	165	115	85	153,8	216	166	136
B	17,000	17,999		50	20	73,8	136	86	54	109,8	172	122	90	163,8	226	176	144
C	18,000	18,999		56	25	76,7	146	90	57	114,7	184	128	95	171,7	241	185	152
D	19,000	19,999		56	25	81,7	151	95	60	121,7	191	135	100	181,7	251	195	160
E	20,000	20,999		56	25	84,6	155	99	63	126,6	197	141	105	189,6	260	204	168
F	21,000	21,999		56	25	89,6	160	104	66	133,6	204	148	110	199,6	270	214	176
G	22,000	22,999		56	25	92,5	164	108	69	138,5	210	154	115	207,5	279	223	184
H	23,000	23,999		56	25	97,5	169	113	72	145,5	217	161	120	217,5	289	233	192
I	24,000	24,999		60	32	100,4	177	117	75	150,4	227	167	125	225,4	302	242	200
J	25,000	25,999		60	32	105,4	182	122	78	157,4	234	174	130	235,4	312	252	208
K	26,000	26,999		60	32	108,3	186	126	81	162,3	240	180	135	243,3	321	261	216
L	27,000	27,999		60	32	113,3	191	131	84	169,3	247	187	140	253,3	331	271	224
M	28,000	28,999		60	32	116,2	195	135	87	174,2	253	193	145	261,2	340	280	232
N	29,000	29,999		60	32	121,2	200	140	90	181,2	260	200	150	271,2	350	290	240
O	30,000	30,999		60	32	124,1	204	144	93	186,1	266	206	155	279,1	359	299	248
P	31,000	31,999		60	32	129,1	209	149	96	193,1	273	213	160	289,1	369	309	256
Q	32,000	33,999		70	40	136,0	228	158	102	204,0	296	226	170	306,0	398	328	272
R	34,000	35,999		70	40	145,0	237	167	108	217,0	309	239	180	325,0	417	347	288
S	36,000	37,999		70	40	151,8	246	176	114	227,8	322	252	190	341,8	436	366	304
T	38,000	40,000		70	40	160,8	255	185	120	240,8	335	265	200	360,8	455	385	320

TDMX — TOP DRILL™ Modular X

Modular Drill System • TDMX

▼ TOP DRILL Modular X • PK(M)



● first choice
○ alternate choice

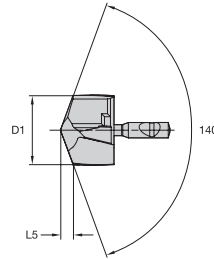

grade WP40PD TiAlN		D1		L5		SSC
order #	catalog #	mm	in	mm	in	
6568446	TDMX16000PKM	16,00	.630	3,21	.126	A
6568447	TDMX16200PKM	16,20	.638	3,25	.128	A
6568448	TDMX06410PK	16,28	.641	3,26	.128	A
6568449	TDMX16500PKM	16,50	.650	3,30	.130	A
6568450	TDMX06562PK	16,67	.656	3,33	.131	A
6568461	TDMX17000PKM	17,00	.669	3,39	.134	B
6568462	TDMX06718PK	17,06	.672	3,41	.134	B
6568464	TDMX06875PK	17,46	.688	3,48	.137	B
6568465	TDMX17500PKM	17,50	.689	3,49	.137	B
6568467	TDMX17600PKM	17,60	.693	3,50	.138	B
6568471	TDMX17800PKM	17,80	.701	3,54	.139	B
6568472	TDMX07031PK	17,86	.703	3,55	.140	B
6568473	TDMX18000PKM	18,00	.709	3,58	.141	C
6568474	TDMX07187PK	18,26	.719	3,64	.143	C
6568475	TDMX18500PKM	18,50	.728	3,68	.145	C
6568476	TDMX07343PK	18,65	.734	3,71	.146	C
6568477	TDMX18800PKM	18,80	.740	3,74	.147	C
6568478	TDMX19000PKM	19,00	.748	3,78	.149	D
6568479	TDMX07500PK	19,05	.750	3,78	.149	D
6568480	TDMX19200PKM	19,20	.756	3,81	.150	D
6568481	TDMX19270PKM	19,27	.759	3,82	.150	D
6568482	TDMX19450PKM	19,45	.766	3,86	.152	D
6568483	TDMX19500PKM	19,50	.768	3,87	.152	D
6568484	TDMX19700PKM	19,70	.776	3,90	.154	D
6568485	TDMX19840PKM	19,84	.781	3,93	.155	D
6568813	TDMX20000PKM	20,00	.787	3,97	.156	E
6568814	TDMX20100PKM	20,10	.791	3,99	.157	E
6568815	TDMX20200PKM	20,20	.795	4,01	.158	E
6568816	TDMX07968PK	20,24	.797	4,02	.158	E
6568817	TDMX20300PKM	20,30	.799	4,03	.159	E
6568818	TDMX20400PKM	20,40	.803	4,05	.159	E
6568819	TDMX20500PKM	20,50	.807	4,06	.160	E
6568820	TDMX20600PKM	20,60	.811	4,08	.161	E
6568841	TDMX08130PK	20,65	.813	4,09	.161	E
6568842	TDMX20700PKM	20,70	.815	4,10	.161	E
6568843	TDMX20800PKM	20,80	.819	4,12	.162	E
6568844	TDMX20900PKM	20,90	.823	4,14	.163	E
6568845	TDMX21000PKM	21,00	.827	4,16	.164	F
6568846	TDMX08437PK	21,43	.844	4,23	.167	F
6568847	TDMX21500PKM	21,50	.847	4,25	.167	F
6568848	TDMX22000PKM	22,00	.866	4,35	.171	G
6568849	TDMX08750PK	22,23	.875	4,39	.173	G
6568850	TDMX22450PKM	22,45	.884	4,44	.175	G
6568851	TDMX22500PKM	22,50	.886	4,44	.175	G
6568852	TDMX23000PKM	23,00	.906	4,54	.179	H
6568853	TDMX23500PKM	23,50	.925	4,63	.182	H
6568854	TDMX09375PK	23,81	.938	4,68	.184	H
6568856	TDMX24000PKM	24,00	.945	4,73	.186	I
6568857	TDMX24500PKM	24,50	.965	4,82	.190	I
6568858	TDMX09687PK	24,61	.969	4,84	.191	I
6568859	TDMX25000PKM	25,00	.984	4,91	.193	J
6568860	TDMX10000PK	25,40	1.000	4,99	.197	J
6568861	TDMX25500PKM	25,50	1.004	5,01	.197	J
6568862	TDMX25670PKM	25,67	1.011	5,04	.198	J
6568863	TDMX25700PKM	25,70	1.012	5,04	.198	J
6568864	TDMX25760PKM	25,76	1.014	5,05	.199	J

(continued)

Modular Drill System • TDMX

(TOP DRILL Modular X • PK(M) – continued)

P	●
M	○
K	●
N	○
S	○
H	○

● first choice
○ alternate choice

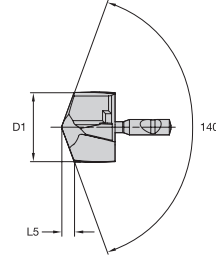

grade WP40PD
TiAlN

order #	catalog #	D1		L5		SSC
		mm	in	mm	in	
6568865	TDMX10156PK	25,80	1.016	5,06	.199	J
6568866	TDMX26000PKM	26,00	1.024	5,11	.201	K
6568867	TDMX10312PK	26,19	1.031	5,15	.203	K
6568868	TDMX26400PKM	26,40	1.039	5,18	.204	K
6568869	TDMX26500PKM	26,50	1.043	5,20	.205	K
6568870	TDMX10468PK	26,59	1.047	5,22	.206	K
6568871	TDMX27000PKM	27,00	1.063	5,29	.208	L
6568872	TDMX27500PKM	27,50	1.083	5,38	.212	L
6568873	TDMX10937PK	27,78	1.094	5,43	.214	L
6568874	TDMX28000PKM	28,00	1.102	5,49	.216	M
6568875	TDMX11093PK	28,18	1.109	5,52	.217	M
6568876	TDMX28500PKM	28,50	1.122	5,58	.220	M
6568877	TDMX11250PK	28,58	1.125	5,59	.220	M
6568878	TDMX29000PKM	29,00	1.142	5,67	.223	N
6568879	TDMX11562PK	29,37	1.156	5,74	.226	N
6568880	TDMX29500PKM	29,50	1.161	5,76	.227	N
6568891	TDMX11718PK	29,76	1.172	5,81	.229	N
6568892	TDMX30000PKM	30,00	1.181	5,87	.231	O
6568893	TDMX11875PK	30,16	1.188	5,90	.232	O
6568896	TDMX30500PKM	30,50	1.201	5,96	.235	O
6568897	TDMX12187PK	30,96	1.219	6,04	.238	O
6568898	TDMX31000PKM	31,00	1.221	6,05	.238	P
6568899	TDMX31500PKM	31,50	1.240	6,14	.242	P
6568900	TDMX12500PK	31,75	1.250	6,18	.243	P
6568901	TDMX32000PKM	32,00	1.260	6,25	.246	Q
6568902	TDMX32500PKM	32,50	1.280	6,34	.250	Q
6568903	TDMX33000PKM	33,00	1.299	6,43	.253	Q
6568904	TDMX13125PK	33,34	1.313	6,49	.256	Q
6568905	TDMX34000PKM	34,00	1.339	6,61	.260	R
6568906	TDMX13437PK	34,13	1.344	6,64	.261	R
6568907	TDMX13750PK	34,93	1.375	6,78	.267	R
6568908	TDMX35000PKM	35,00	1.378	6,79	.267	R
6568909	TDMX35500PKM	35,50	1.398	6,89	.271	R
6568910	TDMX36000PKM	36,00	1.417	7,00	.276	S
6568911	TDMX36500PKM	36,50	1.437	7,09	.279	S
6568912	TDMX37000PKM	37,00	1.457	7,18	.283	S
6568913	TDMX37500PKM	37,50	1.476	7,27	.286	S
6568914	TDMX38000PKM	38,00	1.496	7,36	.290	T
6568915	TDMX15000PK	38,10	1.500	7,38	.291	T
6568916	TDMX38500PKM	38,50	1.516	7,46	.294	T
6568917	TDMX39000PKM	39,00	1.535	7,55	.297	T
6568918	TDMX15468PK	39,29	1.547	7,60	.299	T
6568919	TDMX39500PKM	39,50	1.555	7,64	.301	T
6568920	TDMX40000PKM	40,00	1.575	7,73	.304	T

NOTE: SSC = Pocket Seat Reference. To correspond with the SSC on the toolholder.

Inch tolerance	
D1	tolerance k8
.3125-.3906	.000/+0.009
>.3906-.6250	.000/+0.011
>.6692-.7090	.000/+0.010
>.7090-.8228	.000/+0.013

TDMX — TOP DRILL™ Modular X

Modular Drill System • TDMX

▼ TOP DRILL™ Modular X • PK(M) • WP40PD • Speed and Feed Chart • Metric

Material Group		Cutting Speed – Vc Range – m/min			Recommended Feed Rate (f) by Diameter					
		min	Starting Value	max	Tool Diameter (mm)	16,0	20,0	25,0	32,0	40,0
		P	1	90	125	170	mm/r	0,19–0,45	0,25–0,48	0,25–0,52
2	105		140	180	mm/r	0,23–0,46	0,28–0,50	0,30–0,52	0,33–0,57	0,35–0,60
3	50		75	100	mm/r	0,23–0,46	0,28–0,50	0,30–0,52	0,33–0,57	0,35–0,60
4	50		75	100	mm/r	0,19–0,45	0,22–0,48	0,25–0,50	0,28–0,55	0,29–0,58
5	50		65	80	mm/r	0,16–0,32	0,18–0,36	0,22–0,42	0,24–0,46	0,25–0,48
6	50		65	80	mm/r	0,16–0,32	0,18–0,36	0,22–0,42	0,24–0,46	0,25–0,48
M	1	40	80	110	mm/r	0,11–0,26	0,13–0,28	0,13–0,32	0,14–0,35	0,15–0,37
	2	35	55	75	mm/r	0,11–0,26	0,13–0,28	0,13–0,32	0,14–0,35	0,15–0,37
	3	20	35	50	mm/r	0,11–0,26	0,13–0,28	0,13–0,32	0,14–0,35	0,15–0,37
K	1	60	95	170	mm/r	0,25–0,48	0,28–0,52	0,32–0,56	0,35–0,62	0,37–0,65
	2	60	75	90	mm/r	0,25–0,48	0,28–0,52	0,32–0,56	0,35–0,62	0,37–0,65
	3	40	65	90	mm/r	0,21–0,44	0,23–0,48	0,25–0,50	0,28–0,55	0,29–0,58

NOTE: Through coolant recommended for greater than 3 x D applications.
Material group M is recommended for secondary applications.

▼ TOP DRILL Modular X • PK(M) • WP40PD • Speed and Feed Chart • Inch

Material Group		Cutting Speed – Vc Range – SFM			Recommended Feed Rate (f) by Diameter					
		min	Starting Value	max	Tool Diameter (inch)	.630	.787	1.000	1.260	1.575
		P	1	295	410	558	IPR	.007–.018	.010–.019	.010–.020
2	344		459	590	IPR	.009–.018	.011–.020	.012–.020	.013–.022	.014–.024
3	164		246	328	IPR	.009–.018	.011–.020	.012–.020	.013–.022	.014–.024
4	164		246	328	IPR	.007–.018	.009–.019	.010–.020	.011–.022	.011–.023
5	164		213	262	IPR	.006–.013	.007–.014	.009–.017	.009–.018	.010–.019
6	164		213	262	IPR	.006–.013	.007–.014	.009–.017	.009–.018	.010–.019
M	1	131	262	361	IPR	.004–.010	.005–.012	.005–.013	.006–.014	.006–.015
	2	115	180	246	IPR	.004–.010	.005–.012	.005–.013	.006–.014	.006–.015
	3	66	115	164	IPR	.004–.010	.005–.012	.005–.013	.006–.014	.006–.015
K	1	197	312	558	IPR	.010–.019	.011–.020	.013–.022	.014–.024	.015–.026
	2	197	246	295	IPR	.010–.019	.011–.020	.013–.022	.014–.024	.015–.026
	3	131	213	295	IPR	.008–.017	.009–.019	.010–.020	.011–.022	.011–.023

NOTE: Through coolant recommended for greater than 3 x D applications.
Material group M is recommended for secondary applications.

Assembling and Disassembling Instructions

▼ Assembly

1 Insert positioning

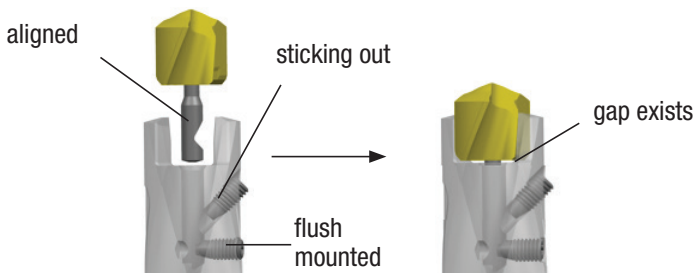

2 Insert clamping

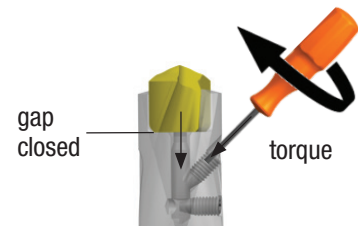

Drill diameter	Torque
ø .6300–.7874"	1.1 ft. lbs.
ø .7875–.9448"	1.5 ft. lbs.
ø .9449–1.1023"	2.2 ft. lbs.
ø 1.1024–1.5748"	3.3 ft. lbs.

▼ Disassembly

1 Clamping screw loosening

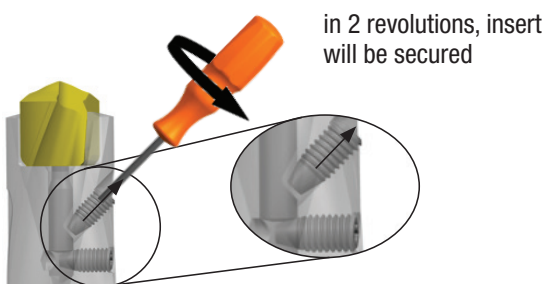

2 Insert pushing out

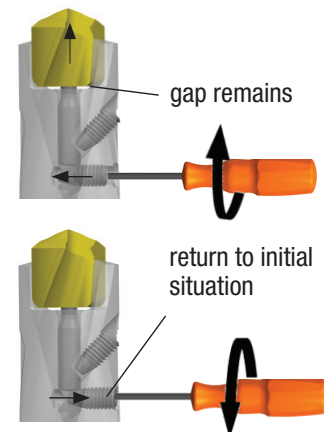

3 Further clamping screw loosening

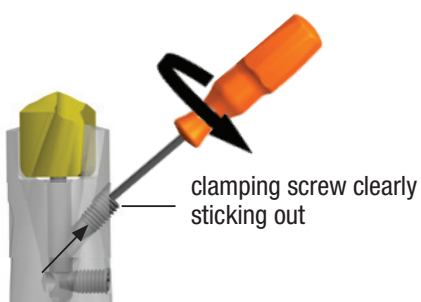

4 Insert removal



TDMX — TOP DRILL™ Modular X

Modular Drill System • TDMX

TDMX Application Notes • Power and Coolant Requirements

Drive Power (kW)

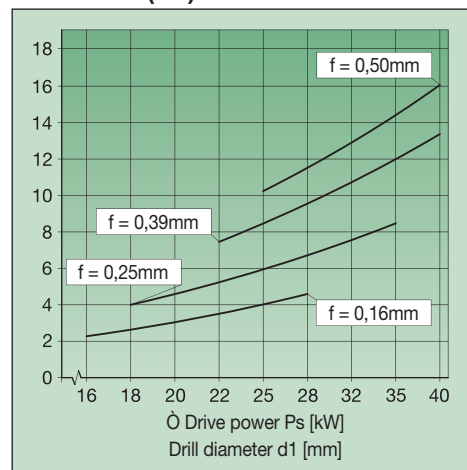

Feed Force (kN)

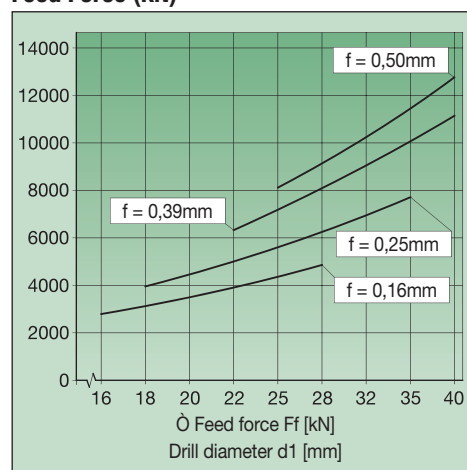

Torque (Nm)

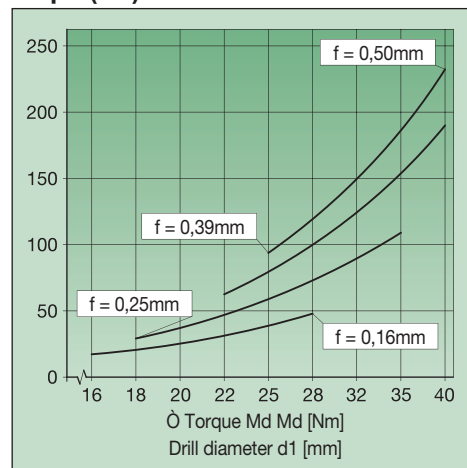

NOTE: The diagrams above are used to determine the drive power, feed force, and torque. They are based on cutting force measurement in tempered steels in Cgr. 6. Tensile strength: $R_m = 600 \text{ N/mm}^2$. The base cutting speed used is: $v_c = 80 \text{ m/min}$.

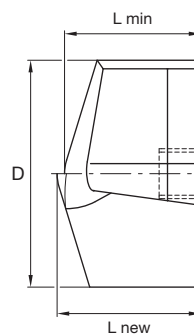

The following coolant pressure is recommended:

relative drilling depth	coolant pressure
1–3 x D	8 bars
5 x D	12 bars
7 x D	20 bars
10 x D	30 bars

SSC	diameter range D (inch)	L min. (inch)	L new (inch)
A	0.63–0.6692	0.4409	0.4921
B	0.6693–0.7086	0.4409	0.4921
C	0.7087–0.748	0.4803	0.5354
D	0.7481–0.7874	0.4803	0.5354
E	0.7875–0.8267	0.5197	0.5787
F	0.8268–0.8661	0.5197	0.5787
G	0.8662–0.9055	0.5591	0.622
H	0.9056–0.9448	0.5591	0.622
I	0.9449–0.9842	0.5984	0.6654
J	0.9843–1.0236	0.5984	0.6654
K	1.0237–1.0629	0.6378	0.7087
L	1.063–1.1023	0.6378	0.7087
M	1.1024–1.1417	0.6772	0.752
N	1.1418–1.1811	0.6772	0.752
O	1.1812–1.2204	0.7165	0.7953
P	1.2205–1.2598	0.7165	0.7953
Q	1.2599–1.3385	0.7913	0.878
R	1.3386–1.4173	0.7913	0.878
S	1.4174–1.496	0.8701	0.9646
T	1.4961–1.5748	0.8701	0.9646

NOTE: SSC = Pocket Seat Reference. To correspond with the SSC on the inserts.

WIDIA™ Digital Solutions

Tools and Resources at Your Fingertips

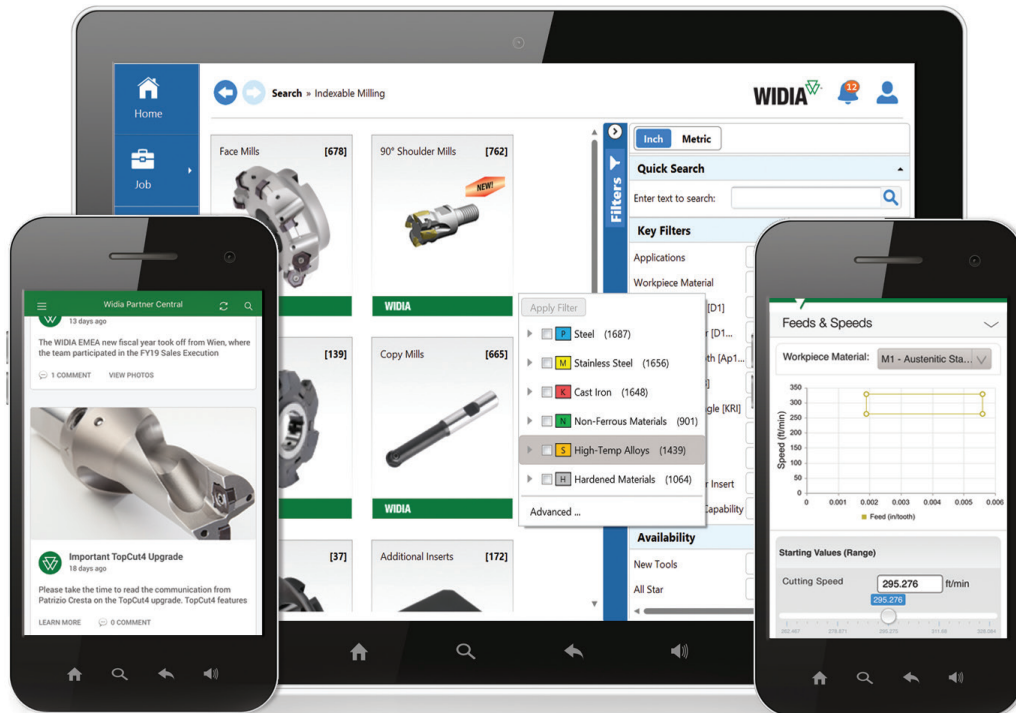

**WIDIA
Machining
Central**



**WIDIA
NOVO™**



**WIDIA
Partner
Central**

PRODUCT DATA

- Tooling Dimensional Data
- Feeds and Speeds
- Inventory Availability
- ...and More!

ELECTRONIC CATALOG

- Complete cutting tool assortment, cutting data, and 2D/3D models.
- Build cutting tool assemblies for easy import into CAD/CAM software, pre-setters, and tool management systems.

PARTNER RESOURCES

- News and updates about our products and services.
- Partner Resources — training, product sheets, marketing templates, campaign collateral, emails, branding elements, merchandise, upcoming webinars, etc.

DOWNLOAD THE WIDIA MOBILE APPS TODAY!



WIDIA.COM



facebook.com/WIDIAProductGrp



youtube.com/WIDIASolutions



twitter.com/WIDIAProductGrp

WIDIA 

TOP CUT 4™



THE NEXT GENERATION
OF INDEXABLE DRILLING





One Comprehensive Platform

Standard diameter range covering .473–2.677" in 2 x D, 3 x D, 4 x D, and 5 x D.

Four real cutting edges on each insert for entire platform.

Eight insert sizes to cover complete diameter range.

Easy to Apply

No risk of mixing up inner and outer insert due to clear visual differences.

Easy-to-change inserts, laser marked with geometries and grades.

Easy-to-use nomenclature guide enabling the tool body and the related insert selection to avoid order failures.

Highly Versatile

Breadth of application capabilities include through and cross holes, inclined entry and exit opportunity, 45° corner, half cylindrical, concave, or chain drilling.

Various geometries and grades available.

WIDIA™ Top Cut 4™ (TC4) portfolio is a broad offering for customers looking for a versatile indexable drilling platform.

WIDIA 

widia.com

Top Cut 4™

New Generation Indexable Drilling System



- 2x four true cutting edges.
- Cutting edge profile of central and periphery insert work together, leading to high stabilization of the drill, preventing drifting of the tool even on irregular surfaces.
- X-offset design to adjust diameter size on turning machines and optimize tolerances on machining centers.
- Apply where speed and economy are prime considerations.
- Four grades to achieve higher tool life at accelerated speeds:
 - WU25CH grade for highest metal removal rate in general applications.
 - WU40PH grade for high toughness demands.
 - WPK10CH grade for high-speed applications.
 - WN10PH grade specific for aluminum and other non-ferrous materials.

Chip Flute Exit

Steeper chip flute exit to reduce the overall length and increase rigidity.

Coolant Channels

Enhanced coolant holes to get more lubrication at the cutting edge.

SL Shank Style

Inch portfolio: shank is now in the single flat configuration, resulting in stiffer clamping. Shank diameters are .75, 1, and 1.5" based on the cutting diameter for all the L/D ratios.

Insert Positioning

Optimized insert positioning to achieve the maximum drill stability, hole tolerance, and surface quality, above all in deep-drilling applications.

Gash

Improved gash design on both insert pocket seats for a better chip evacuation.

Top Cut 4 Inserts Expansion — Long Chip Materials — Non-Ferrous Materials.

-V34



P K

First choice for machining Steel, Cast Iron, and short chipping materials. Suitable for severe cutting conditions.

-V36



P M K

First choice for Stainless Steel. Suitable for deep drilling and where low power consumption is required.



-V36 WN10PH



N

First choice for Non-Ferrous materials.



-V38

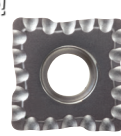

P M S

Ideal for long chipping materials.

New Generation Indexable Drilling System

Top Cut 4™ Bodies Upgrade

Diameter 30mm, 4 x D example

Current

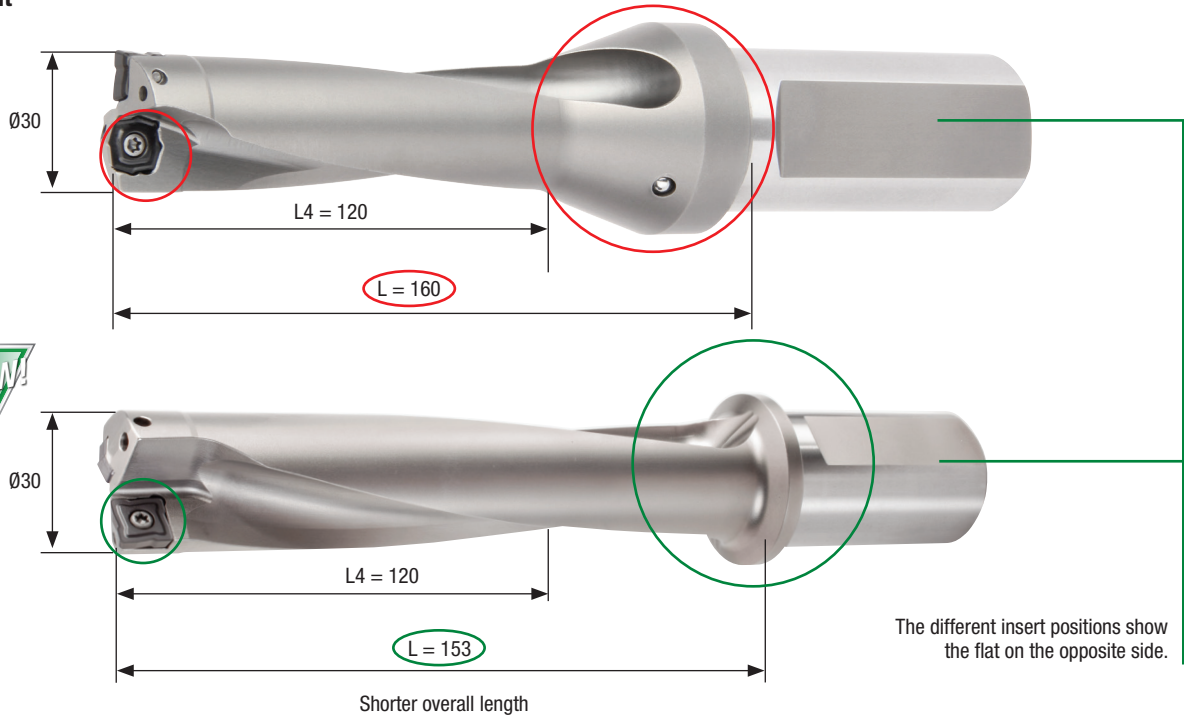

Gash

Optimized gash for improved chip flow and more precise **insert pocket seat positioning**.

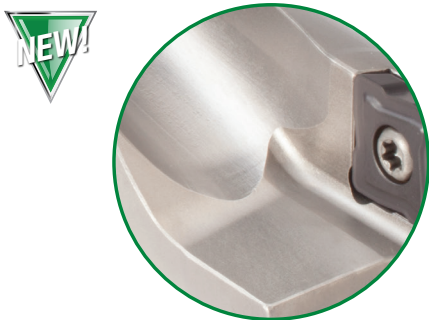

Shank

The SSF style shank (double flat) will be moved to SL style with inch dimensions (industry standard).

Current



NEW!



Top Cut 4™

Geometry and Grade Expansion for Augmented Versatility

-V36 WN10PH for Non-Ferrous Materials

Productivity

- Perfect combination of edge preparation and grade for aluminum machining.
- TiB₂ based coating specific for non-ferrous materials.
- Optimal chip control and no built-up edge, even in very soft aluminums.

Performance

- High cutting speed capability thanks to the state-of-the-art TiB₂ coating.
- The WN10PH grade geometry is available on the inboard insert, as well as on the outboard insert.
- Better general hole quality (surface and dimension) thanks to edge preparation and coating combination when compared to a standard universal insert.
- Longer and predictable tool life leads to avoiding the generation of built-up edge.

Technical Details

- PSTS inserts.
- Positive and sharp cutting edge.
- First choice for aluminum and other non-ferrous materials.
- Periphery insert with wiper land.

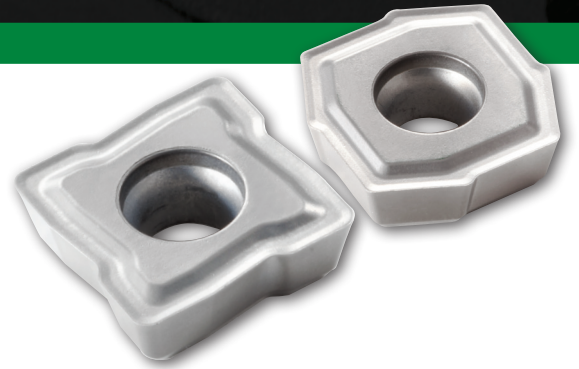

Top Cut 4 Inserts Expansion — Non-Ferrous Materials.

-V36 WN10PH



First choice for Non-Ferrous materials.

Hole Quality — Surface Finish

Diameter: 1,1811" 4 x D hole
Material: GAISI 7 Mg

-V36 WN10PH

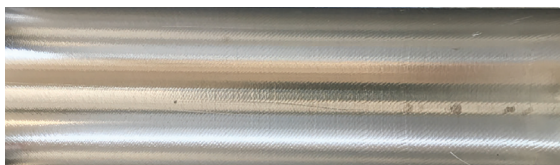

Standard multipurpose grade and geometry

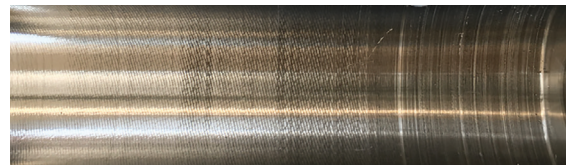

Geometry and Grade Expansion for Augmented Versatility

-V38 Chipbreaker

Productivity

- Eliminates the formation of bird-nesting on the tool in long chip materials drilling.
- Improves the chip formation dramatically to guarantee a smooth chip flow.
- No machine stops due to bad chip evacuation on low carbon steels, stainless steels, and titanium — high process reliability.

Performance

- Larger feed rate window compared to the -V36 geometry when applied to low carbon steels and stainless steel.
- -V38 geometry is available on the inboard insert, as well as on the outboard insert.
- Better general hole quality (surface and dimension) thanks to the improved chip flow:
 - No drifting of the tool body causing deviation in the hole size.
 - No contact of the chips with the hole surface causing bad finishing.

Technical Details

- PSTS inserts.
- Special edge geometry for more effective chipbreaking action.
- First choice for low carbon steel, stainless steel, and super alloys.
- Periphery insert with wiper land.



-V38 Chipbreaker Application Areas

The new -V38 geometry is the first choice when:

- The drilling application with Top Cut 4™ platform bodies and inserts is applied to:
 - Low carbon steel (typically P0 and P1).
 - Stainless steels, such as AISI304, AISI316, and similar materials.
 - Titanium alloys, like Grade 2 and Grade 5.
- Bird-nesting on the tool body is an issue.
- Vibrations are generated due to a bad chip flow. Chip can't evacuate from the hole and generates big noise during machining.
- Bad surface quality caused by the chip in contact with the hole.
- Bigger hole size. Bad chip flow can generate tool drifting.
- Lower power consumption and less torque are needed.

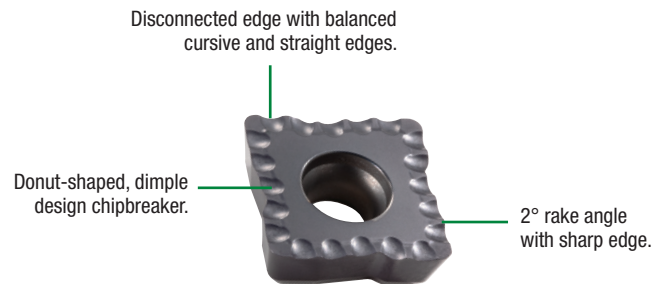

Top Cut 4 Inserts Expansion — Long Chip Materials.



P M S

Ideal for long chip materials.

Top Cut 4™

Top Cut 4 Shanks

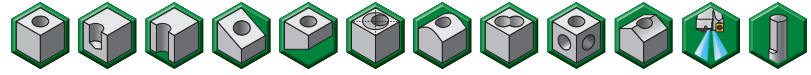

▼ Top Cut 4 Drill • Inch • 2 x D • SLR Shanks

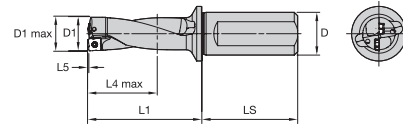

For information on LS, see the table on page 53.

order number	catalog number	D1	D1 max	D	L1	L4 max	L5	SSC	periphery insert	center insert
5537879	TCF0473R2SLR075A	.473	.493	.75	1.688	.963	.017	A	TCF040204AP	TCF040203AC
5537880	TCF0500R2SLR075A	.500	.520	.75	1.776	1.018	.018	A	TCF040204AP	TCF040203AC
5537881	TCF0531R2SLR075A	.531	.551	.75	1.876	1.081	.019	A	TCF040204AP	TCF040203AC
5578226	TCF0563R2SLR075B	.563	.583	.75	1.923	1.146	.020	B	TCF050204BP	TCF060203BC
5578227	TCF0594R2SLR075B	.594	.614	.75	2.021	1.210	.022	B	TCF050204BP	TCF060203BC
5578228	TCF0625R2SLR075B	.625	.645	.75	2.118	1.273	.023	B	TCF050204BP	TCF060203BC
5578229	TCF0656R2SLR075B	.656	.676	.75	2.215	1.336	.024	B	TCF050204BP	TCF060203BC
5578300	TCF0688R2SLR075B	.688	.708	.75	2.315	1.401	.025	B	TCF050204BP	TCF060203BC
5578301	TCF0703R2SLR075B	.703	.723	.75	2.362	1.431	.025	B	TCF050204BP	TCF060203BC
5578302	TCF0719R2SLR075B	.719	.739	.75	2.412	1.463	.026	B	TCF050204BP	TCF060203BC
5578303	TCF0734R2SLR075B	.734	.754	.75	2.459	1.494	.026	B	TCF050204BP	TCF060203BC
5578379	TCF0750R2SLR100C	.750	.770	1.00	2.510	1.527	.027	C	TCF070306CP	TCF070304CC
5578400	TCF0781R2SLR100C	.781	.801	1.00	2.607	1.590	.028	C	TCF070306CP	TCF070304CC
5578401	TCF0813R2SLR100C	.813	.833	1.00	2.707	1.655	.029	C	TCF070306CP	TCF070304CC
5578402	TCF0844R2SLR100C	.844	.864	1.00	2.804	1.718	.030	C	TCF070306CP	TCF070304CC
5578403	TCF0875R2SLR100C	.875	.895	1.00	2.901	1.781	.031	C	TCF070306CP	TCF070304CC
5578404	TCF0906R2SLR100C	.906	.926	1.00	2.998	1.844	.032	C	TCF070306CP	TCF070304CC
5578405	TCF0938R2SLR100C	.938	.958	1.00	3.097	1.908	.032	C	TCF070306CP	TCF070304CC
5537845	TCF0969R2SLR100D	.969	1.008	1.00	3.100	1.973	.035	D	TCF080308DP	TCF090305DC
5537846	TCF0984R2SLR100D	.984	1.023	1.00	3.146	2.004	.036	D	TCF080308DP	TCF090305DC
5537847	TCF1000R2SLR100D	1.000	1.039	1.00	3.194	2.036	.036	D	TCF080308DP	TCF090305DC
5537848	TCF1031R2SLR125D	1.031	1.070	1.25	3.327	2.099	.037	D	TCF080308DP	TCF090305DC
5537849	TCF1063R2SLR125D	1.063	1.102	1.25	3.424	2.164	.038	D	TCF080308DP	TCF090305DC
5537910	TCF1094R2SLR125D	1.094	1.133	1.25	3.518	2.227	.039	D	TCF080308DP	TCF090305DC
5537911	TCF1125R2SLR125D	1.125	1.164	1.25	3.612	2.290	.040	D	TCF080308DP	TCF090305DC
5537912	TCF1156R2SLR125D	1.156	1.195	1.25	3.706	2.353	.041	D	TCF080308DP	TCF090305DC
5537965	TCF1188R2SLR125E	1.188	1.227	1.25	3.685	2.419	.043	E	TCF100408EP	TCF120405EC
5537966	TCF1210R2SLR125E	1.210	1.249	1.25	3.750	2.464	.044	E	TCF100408EP	TCF120405EC
5537967	TCF1219R2SLR125E	1.219	1.258	1.25	3.776	2.482	.044	E	TCF100408EP	TCF120405EC
5537968	TCF1250R2SLR125E	1.250	1.289	1.25	3.867	2.545	.045	E	TCF100408EP	TCF120405EC
5537969	TCF1280R2SLR125E	1.281	1.320	1.25	3.958	2.608	.046	E	TCF100408EP	TCF120405EC
5538060	TCF1313R2SLR125E	1.313	1.352	1.25	4.052	2.673	.047	E	TCF100408EP	TCF120405EC
5538061	TCF1375R2SLR125E	1.375	1.414	1.25	4.233	2.799	.049	E	TCF100408EP	TCF120405EC
5538062	TCF1406R2SLR150E	1.406	1.445	1.50	4.364	2.862	.050	E	TCF100408EP	TCF120405EC
5538063	TCF1438R2SLR150E	1.438	1.438	1.50	4.457	2.926	.050	E	TCF100408EP	TCF120405EC
5578651	TCF1469R2SLR150F	1.469	1.508	1.50	4.550	2.991	.054	F	TCF120412FP	TCF150406FC
5578652	TCF1500R2SLR150F	1.500	1.539	1.50	4.641	3.055	.055	F	TCF120412FP	TCF150406FC
5578653	TCF1531R2SLR150F	1.531	1.570	1.50	4.732	3.118	.056	F	TCF120412FP	TCF150406FC
5578654	TCF1563R2SLR150F	1.563	1.602	1.50	4.826	3.183	.057	F	TCF120412FP	TCF150406FC
5578655	TCF1625R2SLR150F	1.625	1.664	1.50	5.007	3.308	.058	F	TCF120412FP	TCF150406FC
5578656	TCF1656R2SLR150F	1.656	1.695	1.50	5.098	3.371	.059	F	TCF120412FP	TCF150406FC
5578657	TCF1688R2SLR150F	1.688	1.727	1.50	5.192	3.436	.060	F	TCF120412FP	TCF150406FC
5578658	TCF1750R2SLR150F	1.750	1.789	1.50	5.373	3.562	.062	F	TCF120412FP	TCF150406FC
5578765	TCF1813R2SLR150G	1.813	1.852	1.50	5.379	3.692	.066	G	TCF150512GP	TCF180508GC
5578766	TCF1875R2SLR150G	1.875	1.914	1.50	5.554	3.818	.068	G	TCF150512GP	TCF180508GC
5578767	TCF1938R2SLR150G	1.938	1.977	1.50	5.732	3.945	.069	G	TCF150512GP	TCF180508GC
5578768	TCF2000R2SLR150G	2.000	2.039	1.50	5.907	4.071	.071	G	TCF150512GP	TCF180508GC
5578769	TCF2125R2SLR150G	2.125	2.164	1.50	6.261	4.324	.075	G	TCF150512GP	TCF180508GC
5578790	TCF2219R2SLR150G	2.219	2.258	1.50	6.527	4.515	.077	G	TCF150512GP	TCF180508GC
5538500	TCF2250R2SLR150H	2.250	2.289	1.50	6.392	4.581	.081	H	TCF180614HP	TCF210608HC
5538501	TCF2375R2SLR150H	2.375	2.414	1.50	6.734	4.835	.085	H	TCF180614HP	TCF210608HC
5538502	TCF2500R2SLR150H	2.500	2.539	1.50	7.074	5.088	.088	H	TCF180614HP	TCF210608HC

NOTE: SSC = Pocket Seat Reference. To correspond with the SSC on the inserts.

(continued)

(Top Cut 4 Drill • Inch • 2 x D • SLR Shanks — continued)

▼ Spare Parts



SSC	periphery insert	center insert	insert screw order number	Torx size	Torx driver order number	tightening torque Nm	tightening torque ft. lbs
A	TCF040204AP	TCF040203AC	2025073	T5	2029221	0,40	.295
B	TCF050204BP	TCF060203BC	1175225	T6	1138455	0,53	.390
C	TCF070306CP	TCF070304CC	1021337	T7	2029266	0,90	.663
D	TCF080308DP	TCF090305DC	1134385	T8	2029598	1,10	.811
E	TCF100408EP	TCF120405EC	2018194	T9	1138455	2,00	1.475
F	TCF120412FP	TCF150406FC	1756815	T15	2029596	4,00	2.950
G	TCF150512GP	TCF180508GC	1099645	T20	1138455	6,30	4.646
H	TCF180614HP	TCF210608HC	1823871	T25	2585812	8,80	6.490

NOTE: Drilling in stacked plates possible in certain applications. Ask for technical support.
 Drill shipped with insert screws and Torx wrench.
 See pages 68–71 for inserts.
 SSC = Pocket Seat Reference.
 SLR = Side Lock.
 D1 max is an achievable diameter using x-offset.

D	LS	
	mm	in
.75	50	1.9685
1.00	56	2.2047
1.25	60	2.3622
1.50	70	2.7559

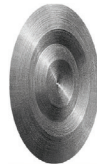

WARNING
 During through-hole operations, a slug or disc is produced as the tool breaks through the workpiece. When the drill is stationary and the workpiece is rotating, this slug may be hurled from the chuck by centrifugal force. Provide adequate shielding to protect bystanders.

Top Cut 4™

Top Cut 4 Shanks

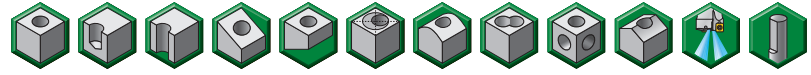

▼ Top Cut 4 Drill • Metric • 2 x D • SLR Shanks

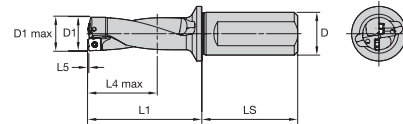

For information on LS, see the table on page 55.

order number	catalog number	D1	D1 max	D	L1	L4 max	L5	SSC	periphery insert	center insert
5537778	TCF120R2SLR20MA	12,00	12,50	20	43,4	24,4	0,43	A	TCF040204AP	TCF040203AC
5537779	TCF125R2SLR20MA	12,50	13,00	20	44,5	25,5	0,45	A	TCF040204AP	TCF040203AC
5537860	TCF127R2SLR20MA	12,70	13,20	20	45,9	25,9	0,46	A	TCF040204AP	TCF040203AC
5537861	TCF130R2SLR20MA	13,00	13,50	20	46,5	26,5	0,47	A	TCF040204AP	TCF040203AC
5537862	TCF135R2SLR20MA	13,50	14,00	20	48,5	27,5	0,48	A	TCF040204AP	TCF040203AC
5577828	TCF140R2SLR25MB	14,00	14,50	25	48,5	28,5	0,49	B	TCF050204BP	TCF060203BC
5577829	TCF145R2SLR25MB	14,50	15,00	25	49,5	29,5	0,52	B	TCF050204BP	TCF060203BC
5577920	TCF150R2SLR25MB	15,00	15,50	25	51,5	30,5	0,55	B	TCF050204BP	TCF060203BC
5577921	TCF155R2SLR25MB	15,50	16,00	25	53,6	31,6	0,56	B	TCF050204BP	TCF060203BC
5577922	TCF160R2SLR25MB	16,00	16,50	25	54,6	32,6	0,58	B	TCF050204BP	TCF060203BC
5577923	TCF165R2SLR25MB	16,50	17,00	25	56,6	33,6	0,60	B	TCF050204BP	TCF060203BC
5577924	TCF170R2SLR25MB	17,00	17,50	25	57,6	34,6	0,61	B	TCF050204BP	TCF060203BC
5577925	TCF175R2SLR25MB	17,50	18,00	25	59,6	35,6	0,63	B	TCF050204BP	TCF060203BC
5577926	TCF180R2SLR25MB	18,00	18,50	25	60,6	36,6	0,64	B	TCF050204BP	TCF060203BC
5577927	TCF185R2SLR25MB	18,50	19,00	25	62,7	37,7	0,65	B	TCF050204BP	TCF060203BC
5578820	TCF190R2SLR25MC	19,00	19,50	25	63,7	38,7	0,68	C	TCF070306CP	TCF070304CC
5578821	TCF195R2SLR25MC	19,50	20,00	25	65,7	39,7	0,71	C	TCF070306CP	TCF070304CC
5578822	TCF200R2SLR25MC	20,00	20,50	25	66,7	40,7	0,72	C	TCF070306CP	TCF070304CC
5578823	TCF205R2SLR25MC	20,50	21,00	25	68,7	41,7	0,74	C	TCF070306CP	TCF070304CC
5578824	TCF210R2SLR25MC	21,00	21,50	25	70,8	42,8	0,75	C	TCF070306CP	TCF070304CC
5578825	TCF220R2SLR25MC	22,00	22,50	25	73,8	44,8	0,78	C	TCF070306CP	TCF070304CC
5578826	TCF225R2SLR25MC	22,50	23,00	25	74,8	45,8	0,79	C	TCF070306CP	TCF070304CC
5578827	TCF230R2SLR25MC	23,00	23,50	25	76,8	46,8	0,80	C	TCF070306CP	TCF070304CC
5537167	TCF240R2SLR25MD	24,00	25,00	25	76,9	48,9	0,87	D	TCF080308DP	TCF090305DC
5537168	TCF250R2SLR32MD	25,00	26,00	32	80,9	50,9	0,91	D	TCF080308DP	TCF090305DC
5537169	TCF260R2SLR32MD	26,00	27,00	32	83,9	52,9	0,94	D	TCF080308DP	TCF090305DC
5537820	TCF265R2SLR32MD	26,50	27,50	32	86,0	54,0	0,95	D	TCF080308DP	TCF090305DC
5537821	TCF270R2SLR32MD	27,00	28,00	32	87,0	55,0	0,97	D	TCF080308DP	TCF090305DC
5537822	TCF280R2SLR32MD	28,00	29,00	32	90,0	57,0	0,99	D	TCF080308DP	TCF090305DC
5537823	TCF290R2SLR32MD	29,00	30,00	32	93,0	59,0	1,02	D	TCF080308DP	TCF090305DC
5537937	TCF300R2SLR32ME	30,00	31,00	32	93,1	61,1	1,09	E	TCF100408EP	TCF120405EC
5537938	TCF310R2SLR32ME	31,00	32,00	32	96,1	63,1	1,12	E	TCF100408EP	TCF120405EC
5537939	TCF320R2SLR32ME	32,00	33,00	32	99,2	65,2	1,15	E	TCF100408EP	TCF120405EC
5537940	TCF330R2SLR40ME	33,00	34,00	40	103,2	67,2	1,18	E	TCF100408EP	TCF120405EC
5537941	TCF340R2SLR40ME	34,00	35,00	40	106,2	69,2	1,21	E	TCF100408EP	TCF120405EC
5537942	TCF350R2SLR40ME	35,00	36,00	40	109,2	71,2	1,24	E	TCF100408EP	TCF120405EC
5537943	TCF360R2SLR40ME	36,00	37,00	40	112,3	73,3	1,27	E	TCF100408EP	TCF120405EC
5578539	TCF370R2SLR40MF	37,00	38,00	40	115,3	75,3	1,35	F	TCF120412FP	TCF150406FC
5578600	TCF375R2SLR40MF	37,50	38,50	40	116,4	76,4	1,36	F	TCF120412FP	TCF150406FC
5578601	TCF380R2SLR40MF	38,00	39,00	40	118,4	77,4	1,38	F	TCF120412FP	TCF150406FC
5578602	TCF390R2SLR40MF	39,00	40,00	40	121,4	79,4	1,41	F	TCF120412FP	TCF150406FC
5578603	TCF400R2SLR40MF	40,00	41,00	40	123,4	81,4	1,45	F	TCF120412FP	TCF150406FC
5578604	TCF410R2SLR40MF	41,00	42,00	40	126,5	83,5	1,48	F	TCF120412FP	TCF150406FC
5578605	TCF420R2SLR40MF	42,00	43,00	40	129,5	85,5	1,51	F	TCF120412FP	TCF150406FC
5578606	TCF430R2SLR40MF	43,00	44,00	40	132,5	87,5	1,53	F	TCF120412FP	TCF150406FC
5578607	TCF440R2SLR40MF	44,00	45,00	40	135,6	89,6	1,56	F	TCF120412FP	TCF150406FC
5578608	TCF450R2SLR40MF	45,00	46,00	40	138,6	91,6	1,59	F	TCF120412FP	TCF150406FC
5578694	TCF460R2SLR40MG	46,00	47,00	40	136,7	93,7	1,67	G	TCF150512GP	TCF180508GC
5578695	TCF470R2SLR40MG	47,00	48,00	40	139,7	95,7	1,70	G	TCF150512GP	TCF180508GC
5578696	TCF480R2SLR40MG	48,00	49,00	40	142,7	97,7	1,73	G	TCF150512GP	TCF180508GC
5578697	TCF490R2SLR40MG	49,00	50,00	40	145,8	99,8	1,76	G	TCF150512GP	TCF180508GC
5578698	TCF500R2SLR40MG	50,00	51,00	40	147,8	101,8	1,79	G	TCF150512GP	TCF180508GC

(continued)

(Top Cut 4 Drill • Metric • 2 x D • SLR Shanks — continued)

order number	catalog number	D1	D1 max	D	L1	L4 max	L5	SSC	periphery insert	center insert
5578699	TCF505R2SLR40MG	50,50	51,50	40	149,8	102,8	1,80	G	TCF150512GP	TCF180508GC
5578710	TCF510R2SLR40MG	51,00	52,00	40	150,8	103,8	1,81	G	TCF150512GP	TCF180508GC
5578711	TCF520R2SLR40MG	52,00	53,00	40	153,8	105,8	1,84	G	TCF150512GP	TCF180508GC
5578712	TCF530R2SLR40MG	53,00	54,00	40	156,9	107,9	1,87	G	TCF150512GP	TCF180508GC
5578713	TCF540R2SLR40MG	54,00	55,00	40	159,9	109,9	1,89	G	TCF150512GP	TCF180508GC
5578714	TCF550R2SLR40MG	55,00	56,00	40	161,9	111,9	1,92	G	TCF150512GP	TCF180508GC
5578715	TCF560R2SLR40MG	56,00	57,00	40	164,9	113,9	1,94	G	TCF150512GP	TCF180508GC
5538613	TCF570R2SLR40MH	57,00	58,00	40	162,1	116,1	2,06	H	TCF180614HP	TCF210608HC
5538614	TCF580R2SLR40MH	58,00	59,00	40	165,1	118,1	2,09	H	TCF180614HP	TCF210608HC
5538615	TCF590R2SLR40MH	59,00	60,00	40	168,1	120,1	2,12	H	TCF180614HP	TCF210608HC
5538616	TCF600R2SLR40MH	60,00	61,00	40	170,1	122,1	2,15	H	TCF180614HP	TCF210608HC
5538617	TCF610R2SLR40MH	61,00	62,00	40	173,2	124,2	2,18	H	TCF180614HP	TCF210608HC
5538618	TCF620R2SLR40MH	62,00	63,00	40	176,2	126,2	2,20	H	TCF180614HP	TCF210608HC
5538619	TCF630R2SLR40MH	63,00	64,00	40	179,2	128,2	2,23	H	TCF180614HP	TCF210608HC
5538630	TCF640R2SLR40MH	64,00	65,00	40	181,3	130,3	2,26	H	TCF180614HP	TCF210608HC
5538631	TCF650R2SLR40MH	65,00	66,00	40	184,3	132,3	2,28	H	TCF180614HP	TCF210608HC
5538632	TCF660R2SLR40MH	66,00	67,00	40	187,3	134,3	2,31	H	TCF180614HP	TCF210608HC
5538633	TCF670R2SLR40MH	67,00	68,00	40	189,3	136,3	2,33	H	TCF180614HP	TCF210608HC
5538634	TCF680R2SLR40MH	68,00	69,00	40	192,4	138,4	2,36	H	TCF180614HP	TCF210608HC

NOTE: SSC = Pocket Seat Reference. To correspond with the SSC on the inserts.

▼ Spare Parts



SSC	periphery insert	center insert	insert screw order number	Torx size	Torx driver order number	tightening torque Nm	tightening torque ft. lbs
A	TCF040204AP	TCF040203AC	2025073	T5	2029221	0,40	.295
B	TCF050204BP	TCF060203BC	1175225	T6	1138455	0,53	.390
C	TCF070306CP	TCF070304CC	1021337	T7	2029266	0,90	.663
D	TCF080308DP	TCF090305DC	1134385	T8	2029598	1,10	.811
E	TCF100408EP	TCF120405EC	2018194	T9	1138430	2,00	1.475
F	TCF120412FP	TCF150406FC	1756815	T15	1138455	4,00	2.950
G	TCF150512GP	TCF180508GC	1099645	T20	1138455	6,30	4.646
H	TCF180614HP	TCF210608HC	1823871	T25	1022519	8,80	6.490
H	TCF180614HP	TCF210608HC	1823871	T25	1138455	8,80	6.490

NOTE: Drilling in stacked plates possible in certain applications. Ask for technical support.

Drill shipped with insert screws and Torx wrench.

See pages 68–71 for inserts.

SSC = Pocket Seat Reference.

SLR = Side Lock.

D1 max is an achievable diameter using x-offset.

D	LS	
	mm	in
20,00	50	1.969
25,00	56	2.205
32,00	60	2.362
40,00	70	2.756

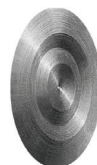

WARNING
 During through-hole operations, a slug or disc is produced as the tool breaks through the workpiece. When the drill is stationary and the workpiece is rotating, this slug may be hurled from the chuck by centrifugal force. Provide adequate shielding to protect bystanders.

Top Cut 4™

Top Cut 4 Shanks

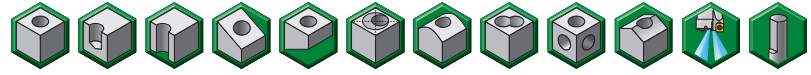

▼ Top Cut 4 Drill • Inch • 3 x D • SLR Shanks

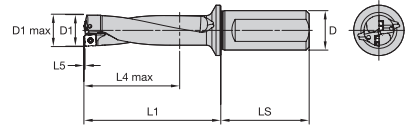

For information on LS, see the table on page 57.

order number	catalog number	D1	D1 max	D	L1	L4 max	L5	SSC	periphery insert	center insert
5537882	TCF0473R3SLR075A	.473	.493	.75	2.161	1.436	.017	A	TCF040204AP	TCF040203AC
5537883	TCF0500R3SLR075A	.500	.520	.75	2.276	1.518	.018	A	TCF040204AP	TCF040203AC
5537884	TCF0531R3SLR075A	.531	.551	.75	2.407	1.612	.019	A	TCF040204AP	TCF040203AC
5578304	TCF0563R3SLR075B	.563	.583	.75	2.486	1.709	.020	B	TCF050204BP	TCF060203BC
5578305	TCF0594R3SLR075B	.594	.614	.75	2.615	1.804	.022	B	TCF050204BP	TCF060203BC
5578306	TCF0625R3SLR075B	.625	.645	.75	2.743	1.898	.023	B	TCF050204BP	TCF060203BC
5578307	TCF0656R3SLR075B	.656	.676	.75	2.871	1.992	.024	B	TCF050204BP	TCF060203BC
5578308	TCF0688R3SLR075B	.688	.708	.75	3.003	2.089	.025	B	TCF050204BP	TCF060203BC
5578309	TCF0703R3SLR075B	.703	.723	.75	3.065	2.134	.025	B	TCF050204BP	TCF060203BC
5578310	TCF0719R3SLR075B	.719	.739	.75	3.131	2.182	.026	B	TCF050204BP	TCF060203BC
5578311	TCF0734R3SLR075B	.734	.754	.75	3.193	2.228	.026	B	TCF050204BP	TCF060203BC
5578406	TCF0750R3SLR100C	.750	.770	1.00	3.260	2.277	.027	C	TCF070306CP	TCF070304CC
5578407	TCF0781R3SLR100C	.781	.801	1.00	3.388	2.371	.028	C	TCF070306CP	TCF070304CC
5578408	TCF0813R3SLR100C	.813	.833	1.00	3.520	2.468	.029	C	TCF070306CP	TCF070304CC
5578409	TCF0844R3SLR100C	.844	.864	1.00	3.648	2.562	.030	C	TCF070306CP	TCF070304CC
5578410	TCF0875R3SLR100C	.875	.895	1.00	3.776	2.656	.031	C	TCF070306CP	TCF070304CC
5578411	TCF0906R3SLR100C	.906	.926	1.00	3.904	2.750	.032	C	TCF070306CP	TCF070304CC
5578412	TCF0938R3SLR100C	.938	.958	1.00	4.035	2.846	.032	C	TCF070306CP	TCF070304CC
5537913	TCF0969R3SLR100D	.969	1.008	1.00	4.069	2.942	.035	D	TCF080308DP	TCF090305DC
5537914	TCF0984R3SLR100D	.984	1.023	1.00	4.130	2.988	.036	D	TCF080308DP	TCF090305DC
5537915	TCF1000R3SLR100D	1.000	1.039	1.00	4.194	3.036	.036	D	TCF080308DP	TCF090305DC
5537916	TCF1031R3SLR125D	1.031	1.070	1.25	4.358	3.130	.037	D	TCF080308DP	TCF090305DC
5537917	TCF1063R3SLR125D	1.063	1.102	1.25	4.487	3.227	.038	D	TCF080308DP	TCF090305DC
5537918	TCF1094R3SLR125D	1.094	1.133	1.25	4.612	3.321	.039	D	TCF080308DP	TCF090305DC
5537919	TCF1125R3SLR125D	1.125	1.164	1.25	4.737	3.415	.040	D	TCF080308DP	TCF090305DC
5537920	TCF1156R3SLR125D	1.156	1.195	1.25	4.862	3.509	.041	D	TCF080308DP	TCF090305DC
5538064	TCF1188R3SLR125E	1.188	1.227	1.25	4.873	3.607	.043	E	TCF100408EP	TCF120405EC
5538065	TCF1210R3SLR125E	1.210	1.249	1.25	4.960	3.674	.044	E	TCF100408EP	TCF120405EC
5538066	TCF1219R3SLR125E	1.219	1.258	1.25	4.995	3.701	.044	E	TCF100408EP	TCF120405EC
5538067	TCF1250R3SLR125E	1.250	1.289	1.25	5.117	3.795	.045	E	TCF100408EP	TCF120405EC
5538068	TCF1280R3SLR125E	1.281	1.320	1.25	5.239	3.889	.046	E	TCF100408EP	TCF120405EC
5538069	TCF1313R3SLR125E	1.313	1.352	1.25	5.365	3.986	.047	E	TCF100408EP	TCF120405EC
5538080	TCF1375R3SLR125E	1.375	1.414	1.25	5.608	4.174	.049	E	TCF100408EP	TCF120405EC
5538081	TCF1406R3SLR150E	1.406	1.445	1.50	5.770	4.268	.050	E	TCF100408EP	TCF120405EC
5538082	TCF1438R3SLR150E	1.438	1.477	1.50	5.895	4.364	.050	E	TCF100408EP	TCF120405EC
5578659	TCF1469R3SLR150F	1.469	1.508	1.50	6.019	4.460	.054	F	TCF120412FP	TCF150406FC
5578670	TCF1500R3SLR150F	1.500	1.539	1.50	6.141	4.555	.055	F	TCF120412FP	TCF150406FC
5578671	TCF1531R3SLR150F	1.531	1.570	1.50	6.263	4.649	.056	F	TCF120412FP	TCF150406FC
5578672	TCF1563R3SLR150F	1.563	1.602	1.50	6.389	4.746	.057	F	TCF120412FP	TCF150406FC
5578673	TCF1625R3SLR150F	1.625	1.664	1.50	6.632	4.933	.058	F	TCF120412FP	TCF150406FC
5578674	TCF1656R3SLR150F	1.656	1.695	1.50	6.754	5.027	.059	F	TCF120412FP	TCF150406FC
5578675	TCF1688R3SLR150F	1.688	1.727	1.50	6.880	5.124	.060	F	TCF120412FP	TCF150406FC
5578676	TCF1750R3SLR150F	1.750	1.789	1.50	7.123	5.312	.062	F	TCF120412FP	TCF150406FC
5578791	TCF1813R3SLR150G	1.813	1.852	1.50	7.192	5.505	.066	G	TCF150512GP	TCF180508GC
5578792	TCF1875R3SLR150G	1.875	1.914	1.50	7.429	5.693	.068	G	TCF150512GP	TCF180508GC
5578793	TCF1938R3SLR150G	1.938	1.977	1.50	7.670	5.883	.069	G	TCF150512GP	TCF180508GC
5578794	TCF2000R3SLR150G	2.000	2.039	1.50	7.836	6.076	.071	G	TCF150512GP	TCF180508GC
5578795	TCF2125R3SLR150G	2.125	2.164	1.50	8.311	6.469	.075	G	TCF150512GP	TCF180508GC
5578796	TCF2219R3SLR150G	2.219	2.258	1.50	8.669	6.862	.077	G	TCF150512GP	TCF180508GC
5538503	TCF2250R3SLR150H	2.250	2.289	1.50	8.642	6.831	.081	H	TCF180614HP	TCF210608HC
5538504	TCF2375R3SLR150H	2.375	2.414	1.50	9.109	7.210	.085	H	TCF180614HP	TCF210608HC
5538505	TCF2500R3SLR150H	2.500	2.539	1.50	9.574	7.588	.088	H	TCF180614HP	TCF210608HC

NOTE: SSC = Pocket Seat Reference. To correspond with the SSC on the inserts.

(continued)

(Top Cut 4 Drill • Inch • 3 x D • SLR Shanks — continued)

▼ Spare Parts



SSC	periphery insert	center insert	insert screw order number	Torx size	Torx driver order number	tightening torque Nm	tightening torque ft. lbs
A	TCF040204AP	TCF040203AC	2025073	T5	2029221	0,40	.295
B	TCF050204BP	TCF060203BC	1175225	T6	1138455	0,53	.390
C	TCF070306CP	TCF070304CC	1021337	T7	2029266	0,90	.663
D	TCF080308DP	TCF090305DC	1134385	T8	2029598	1,10	.811
E	TCF100408EP	TCF120405EC	2018194	T9	1138430	2,00	1.475
E	TCF100408EP	TCF120405EC	2018194	T9	1138455	2,00	1.475
F	TCF120412FP	TCF150406FC	1756815	T15	2029596	4,00	2.950
G	TCF150512GP	TCF180508GC	1099645	T20	1138455	6,30	4.646
H	TCF180614HP	TCF210608HC	1823871	T25	2585812	8,80	6.490

NOTE: Drilling in stacked plates possible in certain applications. Ask for technical support.
 Drill shipped with insert screws and Torx wrench.
 See pages 68–71 for inserts.
 SSC = Pocket Seat Reference.
 SLR = Side Lock.
 D1 max is an achievable diameter using x-offset.

D	LS	
	mm	in
.75	50	1.9685
1.00	56	2.2047
1.25	60	2.3622
1.50	70	2.7559



WARNING
 During through-hole operations, a slug or disc is produced as the tool breaks through the workpiece. When the drill is stationary and the workpiece is rotating, this slug may be hurled from the chuck by centrifugal force. Provide adequate shielding to protect bystanders.

Top Cut 4™

Top Cut 4 Shanks

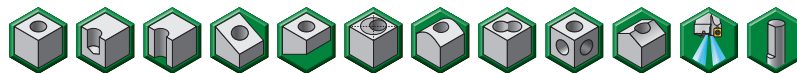

▼ Top Cut 4 Drill • Metric • 3 x D • SLR Shanks

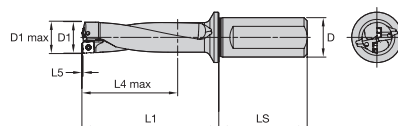

For information on LS, see the table on page 59.

order number	catalog number	D1	D1 max	D	L1	L4 max	L5	SSC	periphery insert	center insert
5537863	TCF120R3SLR20MA	12,00	12,50	20	55,4	36,4	0,43	A	TCF040204AP	TCF040203AC
5537864	TCF125R3SLR20MA	12,50	13,00	20	57,0	38,0	0,45	A	TCF040204AP	TCF040203AC
5537866	TCF127R3SLR20MA	12,70	13,20	20	58,6	38,6	0,46	A	TCF040204AP	TCF040203AC
5537867	TCF130R3SLR20MA	13,00	13,50	20	59,5	39,5	0,47	A	TCF040204AP	TCF040203AC
5537868	TCF135R3SLR20MA	13,50	14,00	20	61,0	41,0	0,48	A	TCF040204AP	TCF040203AC
5577928	TCF140R3SLR25MB	14,00	14,50	25	62,5	42,5	0,49	B	TCF050204BP	TCF060203BC
5577929	TCF145R3SLR25MB	14,50	15,00	25	64,0	44,0	0,52	B	TCF050204BP	TCF060203BC
5577930	TCF150R3SLR25MB	15,00	15,50	25	66,5	45,5	0,55	B	TCF050204BP	TCF060203BC
5577931	TCF155R3SLR25MB	15,50	16,00	25	69,1	47,1	0,56	B	TCF050204BP	TCF060203BC
5577932	TCF160R3SLR25MB	16,00	16,50	25	70,6	48,6	0,58	B	TCF050204BP	TCF060203BC
5577933	TCF165R3SLR25MB	16,50	17,00	25	73,1	50,1	0,60	B	TCF050204BP	TCF060203BC
5577934	TCF170R3SLR25MB	17,00	17,50	25	74,6	51,6	0,61	B	TCF050204BP	TCF060203BC
5577935	TCF175R3SLR25MB	17,50	18,00	25	77,1	53,1	0,63	B	TCF050204BP	TCF060203BC
5577936	TCF180R3SLR25MB	18,00	18,50	25	78,6	54,6	0,64	B	TCF050204BP	TCF060203BC
5577937	TCF185R3SLR25MB	18,50	19,00	25	81,2	56,2	0,65	B	TCF050204BP	TCF060203BC
5578828	TCF190R3SLR25MC	19,00	19,50	25	82,7	57,7	0,68	C	TCF070306CP	TCF070304CC
5578829	TCF195R3SLR25MC	19,50	20,00	25	85,2	59,2	0,71	C	TCF070306CP	TCF070304CC
5578830	TCF200R3SLR25MC	20,00	20,50	25	86,7	60,7	0,72	C	TCF070306CP	TCF070304CC
5578831	TCF205R3SLR25MC	20,50	21,00	25	89,2	62,2	0,74	C	TCF070306CP	TCF070304CC
5578832	TCF210R3SLR25MC	21,00	21,50	25	91,8	63,8	0,75	C	TCF070306CP	TCF070304CC
5578833	TCF220R3SLR25MC	22,00	22,50	25	95,8	66,8	0,78	C	TCF070306CP	TCF070304CC
5578834	TCF225R3SLR25MC	22,50	23,00	25	97,3	68,3	0,79	C	TCF070306CP	TCF070304CC
5578835	TCF230R3SLR25MC	23,00	23,50	25	99,8	69,8	0,80	C	TCF070306CP	TCF070304CC
5537824	TCF240R3SLR25MD	24,00	25,00	25	100,9	72,9	0,87	D	TCF080308DP	TCF090305DC
5537825	TCF250R3SLR32MD	25,00	26,00	32	105,9	75,9	0,91	D	TCF080308DP	TCF090305DC
5537826	TCF260R3SLR32MD	26,00	27,00	32	109,9	78,9	0,94	D	TCF080308DP	TCF090305DC
5537827	TCF265R3SLR32MD	26,50	27,50	32	112,5	80,5	0,95	D	TCF080308DP	TCF090305DC
5537828	TCF270R3SLR32MD	27,00	28,00	32	114,0	82,0	0,97	D	TCF080308DP	TCF090305DC
5537829	TCF280R3SLR32MD	28,00	29,00	32	118,0	85,0	0,99	D	TCF080308DP	TCF090305DC
5537830	TCF290R3SLR32MD	29,00	30,00	32	122,0	88,0	1,02	D	TCF080308DP	TCF090305DC
5537944	TCF300R3SLR32ME	30,00	31,00	32	123,1	91,1	1,09	E	TCF100408EP	TCF120405EC
5537945	TCF310R3SLR32ME	31,00	32,00	32	127,1	94,1	1,12	E	TCF100408EP	TCF120405EC
5537946	TCF320R3SLR32ME	32,00	33,00	32	131,2	97,2	1,15	E	TCF100408EP	TCF120405EC
5537947	TCF330R3SLR40ME	33,00	34,00	40	136,2	100,2	1,18	E	TCF100408EP	TCF120405EC
5537948	TCF340R3SLR40ME	34,00	35,00	40	140,2	103,2	1,21	E	TCF100408EP	TCF120405EC
5537949	TCF350R3SLR40ME	35,00	36,00	40	144,2	106,2	1,24	E	TCF100408EP	TCF120405EC
5537950	TCF360R3SLR40ME	36,00	37,00	40	148,3	109,3	1,27	E	TCF100408EP	TCF120405EC
5578609	TCF370R3SLR40MF	37,00	38,00	40	152,3	112,3	1,35	F	TCF120412FP	TCF150406FC
5578610	TCF375R3SLR40MF	37,50	38,50	40	153,9	113,9	1,36	F	TCF120412FP	TCF150406FC
5578611	TCF380R3SLR40MF	38,00	39,00	40	156,4	115,4	1,38	F	TCF120412FP	TCF150406FC
5578612	TCF390R3SLR40MF	39,00	40,00	40	160,4	118,4	1,41	F	TCF120412FP	TCF150406FC
5578613	TCF400R3SLR40MF	40,00	41,00	40	163,4	121,4	1,45	F	TCF120412FP	TCF150406FC
5578614	TCF410R3SLR40MF	41,00	42,00	40	167,5	124,5	1,48	F	TCF120412FP	TCF150406FC
5578615	TCF420R3SLR40MF	42,00	43,00	40	171,5	127,5	1,51	F	TCF120412FP	TCF150406FC
5578616	TCF430R3SLR40MF	43,00	44,00	40	175,5	130,5	1,53	F	TCF120412FP	TCF150406FC
5578617	TCF440R3SLR40MF	44,00	45,00	40	179,6	133,6	1,56	F	TCF120412FP	TCF150406FC
5578618	TCF450R3SLR40MF	45,00	46,00	40	183,6	136,6	1,59	F	TCF120412FP	TCF150406FC
5578716	TCF460R3SLR40MG	46,00	47,00	40	182,7	139,7	1,67	G	TCF150512GP	TCF180508GC
5578717	TCF470R3SLR40MG	47,00	48,00	40	186,7	142,7	1,70	G	TCF150512GP	TCF180508GC
5578718	TCF480R3SLR40MG	48,00	49,00	40	190,7	145,7	1,73	G	TCF150512GP	TCF180508GC
5578719	TCF490R3SLR40MG	49,00	50,00	40	194,8	148,8	1,76	G	TCF150512GP	TCF180508GC
5578720	TCF500R3SLR40MG	50,00	51,00	40	197,8	151,8	1,79	G	TCF150512GP	TCF180508GC

(continued)

(Top Cut 4 Drill • Metric • 3 x D • SLR Shanks — continued)

order number	catalog number	D1	D1 max	D	L1	L4 max	L5	SSC	periphery insert	center insert
5578721	TCF505R3SLR40MG	50,50	51,50	40	200,3	153,3	1,80	G	TCF150512GP	TCF180508GC
5578722	TCF510R3SLR40MG	51,00	52,00	40	201,8	154,8	1,81	G	TCF150512GP	TCF180508GC
5578723	TCF520R3SLR40MG	52,00	53,00	40	205,8	157,8	1,84	G	TCF150512GP	TCF180508GC
5578724	TCF530R3SLR40MG	53,00	54,00	40	209,9	160,9	1,87	G	TCF150512GP	TCF180508GC
5578726	TCF540R3SLR40MG	54,00	55,00	40	213,9	163,9	1,89	G	TCF150512GP	TCF180508GC
5578727	TCF550R3SLR40MG	55,00	56,00	40	216,9	166,9	1,92	G	TCF150512GP	TCF180508GC
5578728	TCF560R3SLR40MG	56,00	57,00	40	220,9	169,9	1,94	G	TCF150512GP	TCF180508GC
5538635	TCF570R3SLR40MH	57,00	58,00	40	219,1	173,1	2,06	H	TCF180614HP	TCF210608HC
5538636	TCF580R3SLR40MH	58,00	59,00	40	223,1	176,1	2,09	H	TCF180614HP	TCF210608HC
5538637	TCF590R3SLR40MH	59,00	60,00	40	227,1	179,1	2,12	H	TCF180614HP	TCF210608HC
5538638	TCF600R3SLR40MH	60,00	61,00	40	230,1	182,1	2,15	H	TCF180614HP	TCF210608HC
5538639	TCF610R3SLR40MH	61,00	62,00	40	234,2	185,2	2,18	H	TCF180614HP	TCF210608HC
5538640	TCF620R3SLR40MH	62,00	63,00	40	238,2	188,2	2,20	H	TCF180614HP	TCF210608HC
5538641	TCF630R3SLR40MH	63,00	64,00	40	242,2	191,2	2,23	H	TCF180614HP	TCF210608HC
5538642	TCF640R3SLR40MH	64,00	65,00	40	245,3	194,3	2,26	H	TCF180614HP	TCF210608HC
5538643	TCF650R3SLR40MH	65,00	66,00	40	249,3	197,3	2,28	H	TCF180614HP	TCF210608HC
5538644	TCF660R3SLR40MH	66,00	67,00	40	253,3	200,3	2,31	H	TCF180614HP	TCF210608HC
5538645	TCF670R3SLR40MH	67,00	68,00	40	256,3	203,3	2,33	H	TCF180614HP	TCF210608HC
5538646	TCF680R3SLR40MH	68,00	69,00	40	260,4	206,4	2,36	H	TCF180614HP	TCF210608HC

NOTE: SSC = Pocket Seat Reference. To correspond with the SSC on the inserts.

▼ Spare Parts



SSC	periphery insert	center insert	insert screw order number	Torx size	Torx driver order number	tightening torque Nm	tightening torque ft. lbs
A	TCF040204AP	TCF040203AC	2025073	T5	2029221	0,40	.295
B	TCF050204BP	TCF060203BC	1175225	T6	1138455	0,53	.390
C	TCF070306CP	TCF070304CC	1021337	T7	2029266	0,90	.663
D	TCF080308DP	TCF090305DC	1134385	T8	2029598	1,10	.811
E	TCF100408EP	TCF120405EC	2018194	T9	1138430	2,00	1.475
F	TCF120412FP	TCF150406FC	1756815	T15	1138455	4,00	2.950
F	TCF120412FP	TCF150406FC	1756815	T15	2029596	4,00	2.950
G	TCF150512GP	TCF180508GC	1099645	T20	1138455	6,30	4.646
H	TCF180614HP	TCF210608HC	1823871	T25	1022519	8,80	6.490
H	TCF180614HP	TCF210608HC	1823871	T25	1138455	8,80	6.490

NOTE: Drilling in stacked plates possible in certain applications. Ask for technical support.

Drill shipped with insert screws and Torx wrench.

See pages 68–71 for inserts.

SSC = Pocket Seat Reference.

SLR = Side Lock.

D1 max is an achievable diameter using x-offset.

D	LS	
	mm	in
20,00	50	1.969
25,00	56	2.205
32,00	60	2.362
40,00	70	2.756

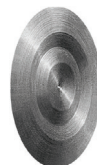

WARNING
During through-hole operations, a slug or disc is produced as the tool breaks through the workpiece. When the drill is stationary and the workpiece is rotating, this slug may be hurled from the chuck by centrifugal force. Provide adequate shielding to protect bystanders.

Top Cut 4™

Top Cut 4 Shanks

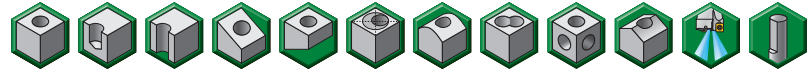

▼ Top Cut 4 Drill • Inch • 4 x D • SLR Shanks

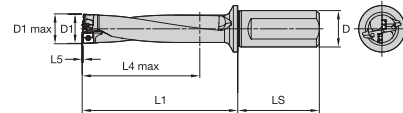

For information on LS, see the table on page 61.

order number	catalog number	D1	D1 max	D	L1	L4 max	L5	SSC	periphery insert	center insert
5537885	TCF0473R4SLR075A	.473	.493	.75	2.634	1.909	.017	A	TCF040204AP	TCF040203AC
5537886	TCF0500R4SLR075A	.500	.520	.75	2.776	2.018	.018	A	TCF040204AP	TCF040203AC
5537887	TCF0531R4SLR075A	.531	.551	.75	2.938	2.143	.019	A	TCF040204AP	TCF040203AC
5578312	TCF0563R4SLR075B	.563	.583	.75	3.049	2.272	.020	B	TCF050204BP	TCF060203BC
5578313	TCF0594R4SLR075B	.594	.614	.75	3.209	2.398	.022	B	TCF050204BP	TCF060203BC
5578314	TCF0625R4SLR075B	.625	.645	.75	3.368	2.523	.023	B	TCF050204BP	TCF060203BC
5578315	TCF0656R4SLR075B	.656	.676	.75	3.527	2.648	.024	B	TCF050204BP	TCF060203BC
5578316	TCF0688R4SLR075B	.688	.708	.75	3.691	2.777	.025	B	TCF050204BP	TCF060203BC
5578317	TCF0703R4SLR075B	.703	.723	.75	3.768	2.837	.025	B	TCF050204BP	TCF060203BC
5578318	TCF0719R4SLR075B	.719	.739	.75	3.850	2.901	.026	B	TCF050204BP	TCF060203BC
5578319	TCF0734R4SLR075B	.734	.754	.75	3.927	2.962	.026	B	TCF050204BP	TCF060203BC
5578413	TCF0750R4SLR100C	.750	.770	1.00	4.010	3.027	.027	C	TCF070306CP	TCF070304CC
5578414	TCF0781R4SLR100C	.781	.801	1.00	4.169	3.152	.028	C	TCF070306CP	TCF070304CC
5578415	TCF0813R4SLR100C	.813	.833	1.00	4.333	3.281	.029	C	TCF070306CP	TCF070304CC
5578416	TCF0844R4SLR100C	.844	.864	1.00	4.492	3.406	.030	C	TCF070306CP	TCF070304CC
5578417	TCF0875R4SLR100C	.875	.895	1.00	4.651	3.531	.031	C	TCF070306CP	TCF070304CC
5578418	TCF0906R4SLR100C	.906	.926	1.00	4.810	3.656	.032	C	TCF070306CP	TCF070304CC
5578419	TCF0938R4SLR100C	.938	.958	1.00	4.973	3.784	.032	C	TCF070306CP	TCF070304CC
5537921	TCF0969R4SLR100D	.969	1.008	1.00	5.038	3.911	.035	D	TCF080308DP	TCF090305DC
5537922	TCF0984R4SLR100D	.984	1.023	1.00	5.114	3.972	.036	D	TCF080308DP	TCF090305DC
5537923	TCF1000R4SLR100D	1.000	1.039	1.00	5.194	4.036	.036	D	TCF080308DP	TCF090305DC
5537924	TCF1031R4SLR125D	1.031	1.070	1.25	5.389	4.161	.037	D	TCF080308DP	TCF090305DC
5537925	TCF1063R4SLR125D	1.063	1.102	1.25	5.550	4.290	.038	D	TCF080308DP	TCF090305DC
5537926	TCF1094R4SLR125D	1.094	1.133	1.25	5.706	4.415	.039	D	TCF080308DP	TCF090305DC
5537927	TCF1125R4SLR125D	1.125	1.164	1.25	5.862	4.540	.040	D	TCF080308DP	TCF090305DC
5537928	TCF1156R4SLR125D	1.156	1.195	1.25	6.018	4.665	.041	D	TCF080308DP	TCF090305DC
5538083	TCF1188R4SLR125E	1.188	1.227	1.25	6.061	4.795	.043	E	TCF100408EP	TCF120405EC
5538084	TCF1210R4SLR125E	1.210	1.249	1.25	6.170	4.884	.044	E	TCF100408EP	TCF120405EC
5538085	TCF1219R4SLR125E	1.219	1.258	1.25	6.214	4.920	.044	E	TCF100408EP	TCF120405EC
5538086	TCF1250R4SLR125E	1.250	1.289	1.25	6.367	5.045	.045	E	TCF100408EP	TCF120405EC
5538087	TCF1280R4SLR125E	1.281	1.320	1.25	6.520	5.170	.046	E	TCF100408EP	TCF120405EC
5538088	TCF1313R4SLR125E	1.313	1.352	1.25	6.678	5.299	.047	E	TCF100408EP	TCF120405EC
5538089	TCF1375R4SLR125E	1.375	1.414	1.25	6.983	5.549	.049	E	TCF100408EP	TCF120405EC
5538090	TCF1406R4SLR150E	1.406	1.445	1.50	7.176	5.674	.050	E	TCF100408EP	TCF120405EC
5538091	TCF1438R4SLR150E	1.438	1.477	1.50	7.333	5.802	.050	E	TCF100408EP	TCF120405EC
5578677	TCF1469R4SLR150F	1.469	1.508	1.50	7.488	5.929	.054	F	TCF120412FP	TCF150406FC
5578678	TCF1500R4SLR150F	1.500	1.539	1.50	7.641	6.054	.055	F	TCF120412FP	TCF150406FC
5578679	TCF1531R4SLR150F	1.531	1.570	1.50	7.794	6.180	.056	F	TCF120412FP	TCF150406FC
5578680	TCF1563R4SLR150F	1.563	1.602	1.50	7.952	6.309	.057	F	TCF120412FP	TCF150406FC
5578681	TCF1625R4SLR150F	1.625	1.664	1.50	8.257	6.558	.058	F	TCF120412FP	TCF150406FC
5578682	TCF1656R4SLR150F	1.656	1.695	1.50	8.410	6.683	.059	F	TCF120412FP	TCF150406FC
5578683	TCF1688R4SLR150F	1.688	1.727	1.50	8.568	6.812	.060	F	TCF120412FP	TCF150406FC
5578684	TCF1750R4SLR150F	1.750	1.789	1.50	8.873	7.062	.062	F	TCF120412FP	TCF150406FC
5578797	TCF1813R4SLR150G	1.813	1.852	1.50	9.005	7.318	.066	G	TCF150512GP	TCF180508GC
5578798	TCF1875R4SLR150G	1.875	1.914	1.50	9.304	7.568	.068	G	TCF150512GP	TCF180508GC
5578799	TCF1938R4SLR150G	1.938	1.977	1.50	9.608	7.821	.069	G	TCF150512GP	TCF180508GC
5578800	TCF2000R4SLR150G	2.000	2.039	1.50	9.907	8.071	.071	G	TCF150512GP	TCF180508GC
5578801	TCF2125R4SLR150G	2.125	2.164	1.50	10.511	8.574	.075	G	TCF150512GP	TCF180508GC
5578802	TCF2219R4SLR150G	2.219	2.258	1.50	10.965	8.953	.077	G	TCF150512GP	TCF180508GC
5538506	TCF2250R4SLR150H	2.250	2.289	1.50	10.892	9.081	.081	H	TCF180614HP	TCF210608HC
5538507	TCF2375R4SLR150H	2.375	2.414	1.50	11.484	9.585	.085	H	TCF180614HP	TCF210608HC
5538508	TCF2500R4SLR150H	2.500	2.539	1.50	12.074	10.088	.088	H	TCF180614HP	TCF210608HC

NOTE: SSC = Pocket Seat Reference. To correspond with the SSC on the inserts.

(continued)

(Top Cut 4 Drill • Inch • 4 x D • SLR Shanks — continued)

▼ Spare Parts



SSC	periphery insert	center insert	insert screw order number	Torx size	Torx driver order number	tightening torque Nm	tightening torque ft. lbs
A	TCF040204AP	TCF040203AC	2025073	T5	2029221	0,40	.295
B	TCF050204BP	TCF060203BC	1175225	T6	1138455	0,53	.390
C	TCF070306CP	TCF070304CC	1021337	T7	2029266	0,90	.663
D	TCF080308DP	TCF090305DC	1134385	T8	2029598	1,10	.811
E	TCF100408EP	TCF120405EC	2018194	T9	1138430	2,00	1.475
E	TCF100408EP	TCF120405EC	2018194	T9	1138455	2,00	1.475
F	TCF120412FP	TCF150406FC	1756815	T15	2029596	4,00	2.950
G	TCF150512GP	TCF180508GC	1099645	T20	1138455	6,30	4.646
H	TCF180614HP	TCF210608HC	1823871	T25	2585812	8,80	6.490

NOTE: Drilling in stacked plates possible in certain applications. Ask for technical support.

Drill shipped with insert screws and Torx wrench.

See pages 68–71 for inserts.

SSC = Pocket Seat Reference.

SLR = Side Lock.

D1 max is an achievable diameter using x-offset.

D	LS	
	mm	in
.75	50	1.9685
1.00	56	2.2047
1.25	60	2.3622
1.50	70	2.7559

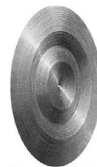

WARNING
 During through-hole operations, a slug or disc is produced as the tool breaks through the workpiece. When the drill is stationary and the workpiece is rotating, this slug may be hurled from the chuck by centrifugal force. Provide adequate shielding to protect bystanders.

Top Cut 4™

Top Cut 4 Shanks



▼ Top Cut 4 Drill • Metric • 4 x D • SLR Shanks

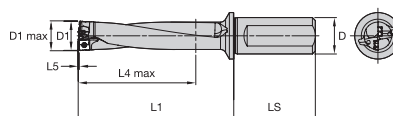

For information on LS, see the table on page 63.

order number	catalog number	D1	D1 max	D	L1	L4 max	L5	SSC	periphery insert	center insert
5537869	TCF120R4SLR20MA	12,00	12,50	20	67,4	48,4	0,43	A	TCF040204AP	TCF040203AC
5537870	TCF125R4SLR20MA	12,50	13,00	20	69,5	50,5	0,45	A	TCF040204AP	TCF040203AC
5537871	TCF127R4SLR20MA	12,70	13,20	20	71,3	51,3	0,46	A	TCF040204AP	TCF040203AC
5537872	TCF130R4SLR20MA	13,00	13,50	20	72,5	52,5	0,47	A	TCF040204AP	TCF040203AC
5537873	TCF135R4SLR20MA	13,50	14,00	20	75,5	54,5	0,48	A	TCF040204AP	TCF040203AC
5577938	TCF140R4SLR25MB	14,00	14,50	25	76,5	56,5	0,49	B	TCF050204BP	TCF060203BC
5577939	TCF145R4SLR25MB	14,50	15,00	25	78,5	58,5	0,52	B	TCF050204BP	TCF060203BC
5577940	TCF150R4SLR25MB	15,00	15,50	25	81,5	60,5	0,55	B	TCF050204BP	TCF060203BC
5577941	TCF155R4SLR25MB	15,50	16,00	25	84,6	62,6	0,56	B	TCF050204BP	TCF060203BC
5577942	TCF160R4SLR25MB	16,00	16,50	25	86,6	64,6	0,58	B	TCF050204BP	TCF060203BC
5577943	TCF165R4SLR25MB	16,50	17,00	25	89,6	66,6	0,60	B	TCF050204BP	TCF060203BC
5577944	TCF170R4SLR25MB	17,00	17,50	25	91,6	68,6	0,61	B	TCF050204BP	TCF060203BC
5577945	TCF175R4SLR25MB	17,50	18,00	25	94,6	70,6	0,63	B	TCF050204BP	TCF060203BC
5577946	TCF180R4SLR25MB	18,00	18,50	25	96,6	72,6	0,64	B	TCF050204BP	TCF060203BC
5577947	TCF185R4SLR25MB	18,50	19,00	25	99,7	74,7	0,65	B	TCF050204BP	TCF060203BC
5578836	TCF190R4SLR25MC	19,00	19,50	25	101,7	76,7	0,68	C	TCF070306CP	TCF070304CC
5578837	TCF195R4SLR25MC	19,50	20,00	25	104,7	78,7	0,71	C	TCF070306CP	TCF070304CC
5578838	TCF200R4SLR25MC	20,00	20,50	25	106,7	80,7	0,72	C	TCF070306CP	TCF070304CC
5578839	TCF205R4SLR25MC	20,50	21,00	25	109,7	82,7	0,74	C	TCF070306CP	TCF070304CC
5578840	TCF210R4SLR25MC	21,00	21,50	25	112,8	84,8	0,75	C	TCF070306CP	TCF070304CC
5578841	TCF220R4SLR25MC	22,00	22,50	25	117,8	88,8	0,78	C	TCF070306CP	TCF070304CC
5578842	TCF225R4SLR25MC	22,50	23,00	25	119,8	90,8	0,79	C	TCF070306CP	TCF070304CC
5578843	TCF230R4SLR25MC	23,00	23,50	25	122,8	92,8	0,80	C	TCF070306CP	TCF070304CC
5537831	TCF240R4SLR25MD	24,00	25,00	25	124,9	96,9	0,87	D	TCF080308DP	TCF090305DC
5537832	TCF250R4SLR32MD	25,00	26,00	32	130,9	100,9	0,91	D	TCF080308DP	TCF090305DC
5537833	TCF260R4SLR32MD	26,00	27,00	32	135,9	104,9	0,94	D	TCF080308DP	TCF090305DC
5537834	TCF265R4SLR32MD	26,50	27,50	32	139,0	107,0	0,95	D	TCF080308DP	TCF090305DC
5537835	TCF270R4SLR32MD	27,00	28,00	32	141,0	109,0	0,97	D	TCF080308DP	TCF090305DC
5537836	TCF280R4SLR32MD	28,00	29,00	32	146,0	113,0	0,99	D	TCF080308DP	TCF090305DC
5537837	TCF290R4SLR32MD	29,00	30,00	32	151,0	117,0	1,02	D	TCF080308DP	TCF090305DC
5537951	TCF300R4SLR32ME	30,00	31,00	32	153,1	121,1	1,09	E	TCF100408EP	TCF120405EC
5537952	TCF310R4SLR32ME	31,00	32,00	32	158,1	125,1	1,12	E	TCF100408EP	TCF120405EC
5537953	TCF320R4SLR32ME	32,00	33,00	32	163,2	129,2	1,15	E	TCF100408EP	TCF120405EC
5537954	TCF330R4SLR40ME	33,00	34,00	40	165,2	133,2	1,18	E	TCF100408EP	TCF120405EC
5537955	TCF340R4SLR40ME	34,00	35,00	40	174,2	137,2	1,21	E	TCF100408EP	TCF120405EC
5537956	TCF350R4SLR40ME	35,00	36,00	40	179,2	141,2	1,24	E	TCF100408EP	TCF120405EC
5537957	TCF360R4SLR40ME	36,00	37,00	40	184,3	145,3	1,27	E	TCF100408EP	TCF120405EC
5578619	TCF370R4SLR40MF	37,00	38,00	40	189,3	149,3	1,35	F	TCF120412FP	TCF150406FC
5578620	TCF375R4SLR40MF	37,50	38,50	40	191,4	151,4	1,36	F	TCF120412FP	TCF150406FC
5578621	TCF380R4SLR40MF	38,00	39,00	40	194,4	153,4	1,38	F	TCF120412FP	TCF150406FC
5578622	TCF390R4SLR40MF	39,00	40,00	40	199,4	157,4	1,41	F	TCF120412FP	TCF150406FC
5578623	TCF400R4SLR40MF	40,00	41,00	40	203,4	161,4	1,45	F	TCF120412FP	TCF150406FC
5578624	TCF410R4SLR40MF	41,00	42,00	40	208,5	165,5	1,48	F	TCF120412FP	TCF150406FC
5578625	TCF420R4SLR40MF	42,00	43,00	40	213,5	169,5	1,51	F	TCF120412FP	TCF150406FC
5578626	TCF430R4SLR40MF	43,00	44,00	40	218,5	173,5	1,53	F	TCF120412FP	TCF150406FC
5578627	TCF440R4SLR40MF	44,00	45,00	40	223,6	177,6	1,56	F	TCF120412FP	TCF150406FC
5578628	TCF450R4SLR40MF	45,00	46,00	40	228,6	181,6	1,59	F	TCF120412FP	TCF150406FC
5578729	TCF460R4SLR40MG	46,00	47,00	40	228,7	185,7	1,67	G	TCF150512GP	TCF180508GC
5578730	TCF470R4SLR40MG	47,00	48,00	40	233,7	189,7	1,70	G	TCF150512GP	TCF180508GC
5578731	TCF480R4SLR40MG	48,00	49,00	40	238,7	193,7	1,73	G	TCF150512GP	TCF180508GC
5578732	TCF490R4SLR40MG	49,00	50,00	40	243,8	197,8	1,76	G	TCF150512GP	TCF180508GC
5578733	TCF500R4SLR40MG	50,00	51,00	40	247,8	201,8	1,79	G	TCF150512GP	TCF180508GC

(continued)

(Top Cut 4 Drill • Metric • 4 x D • SLR Shanks — continued)

order number	catalog number	D1	D1 max	D	L1	L4 max	L5	SSC	periphery insert	center insert
5578734	TCF505R4SLR40MG	50,50	51,50	40	250,8	203,8	1,80	G	TCF150512GP	TCF180508GC
5578735	TCF510R4SLR40MG	51,00	52,00	40	252,8	205,8	1,81	G	TCF150512GP	TCF180508GC
5578736	TCF520R4SLR40MG	52,00	53,00	40	257,8	209,8	1,84	G	TCF150512GP	TCF180508GC
5578737	TCF530R4SLR40MG	53,00	54,00	40	262,9	213,9	1,87	G	TCF150512GP	TCF180508GC
5578738	TCF540R4SLR40MG	54,00	55,00	40	267,9	217,9	1,89	G	TCF150512GP	TCF180508GC
5578739	TCF550R4SLR40MG	55,00	56,00	40	271,9	221,9	1,92	G	TCF150512GP	TCF180508GC
5578750	TCF560R4SLR40MG	56,00	57,00	40	276,9	225,9	1,94	G	TCF150512GP	TCF180508GC
5538647	TCF570R4SLR40MH	57,00	58,00	40	276,1	230,1	2,06	H	TCF180614HP	TCF210608HC
5538648	TCF580R4SLR40MH	58,00	59,00	40	281,1	234,1	2,09	H	TCF180614HP	TCF210608HC
5538649	TCF590R4SLR40MH	59,00	60,00	40	286,1	238,1	2,12	H	TCF180614HP	TCF210608HC
5538650	TCF600R4SLR40MH	60,00	61,00	40	290,1	242,1	2,15	H	TCF180614HP	TCF210608HC
5538651	TCF610R4SLR40MH	61,00	62,00	40	295,2	246,2	2,18	H	TCF180614HP	TCF210608HC
5538652	TCF620R4SLR40MH	62,00	63,00	40	300,2	250,2	2,20	H	TCF180614HP	TCF210608HC
5538653	TCF630R4SLR40MH	63,00	64,00	40	305,2	254,2	2,23	H	TCF180614HP	TCF210608HC
5538654	TCF640R4SLR40MH	64,00	65,00	40	309,3	258,3	2,26	H	TCF180614HP	TCF210608HC
5538655	TCF650R4SLR40MH	65,00	66,00	40	314,3	262,3	2,28	H	TCF180614HP	TCF210608HC
5538656	TCF660R4SLR40MH	66,00	67,00	40	319,3	266,3	2,31	H	TCF180614HP	TCF210608HC
5538657	TCF670R4SLR40MH	67,00	68,00	40	323,3	270,3	2,33	H	TCF180614HP	TCF210608HC
5538658	TCF680R4SLR40MH	68,00	69,00	40	328,4	274,4	2,36	H	TCF180614HP	TCF210608HC

NOTE: SSC = Pocket Seat Reference. To correspond with the SSC on the inserts.

▼ Spare Parts



SSC	periphery insert	center insert	insert screw order number	Torx size	Torx driver order number	tightening torque Nm	tightening torque ft. lbs
A	TCF040204AP	TCF040203AC	2025073	T5	2029221	0,40	.295
B	TCF050204BP	TCF060203BC	1175225	T6	1138455	0,53	.390
C	TCF070306CP	TCF070304CC	1021337	T7	2029266	0,90	.663
D	TCF080308DP	TCF090305DC	1134385	T8	2029598	1,10	.811
E	TCF100408EP	TCF120405EC	2018194	T9	1138430	2,00	1.475
F	TCF120412FP	TCF150406FC	1756815	T15	1138455	4,00	2.950
F	TCF120412FP	TCF150406FC	1756815	T15	2029596	4,00	2.950
G	TCF150512GP	TCF180508GC	1099645	T20	1138455	6,30	4.646
H	TCF180614HP	TCF210608HC	1823871	T25	1022519	8,80	6.490
H	TCF180614HP	TCF210608HC	1823871	T25	1138455	8,80	6.490

NOTE: Drilling in stacked plates possible in certain applications. Ask for technical support.

Drill shipped with insert screws and Torx wrench.

See pages 68–71 for inserts.

SSC = Pocket Seat Reference.

SLR = Side Lock.

D1 max is an achievable diameter using x-offset.

D	LS	
	mm	in
20,00	50	1.969
25,00	56	2.205
32,00	60	2.362
40,00	70	2.756

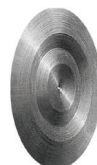

WARNING
During through-hole operations, a slug or disc is produced as the tool breaks through the workpiece. When the drill is stationary and the workpiece is rotating, this slug may be hurled from the chuck by centrifugal force. Provide adequate shielding to protect bystanders.

Top Cut 4™

Top Cut 4 Shanks

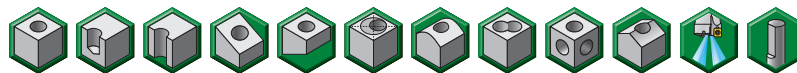

▼ Top Cut 4 Drill • Inch • 5 x D • SLR Shanks

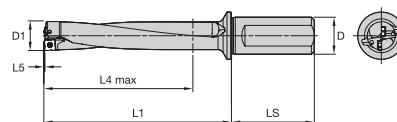

For information on L5, see the table on page 65.

order number	catalog number	D1	D	L1	L4 max	L5	SSC	periphery insert	center insert
5537888	TCF0473R5SLR075A	.473	.75	3.107	2.382	.017	A	TCF040204AP	TCF040203AC
5537889	TCF0500R5SLR075A	.500	.75	3.276	2.518	.018	A	TCF040204AP	TCF040203AC
5537890	TCF0531R5SLR075A	.531	.75	3.469	2.674	.019	A	TCF040204AP	TCF040203AC
5578320	TCF0563R5SLR075B	.563	.75	3.612	2.835	.020	B	TCF050204BP	TCF060203BC
5578321	TCF0594R5SLR075B	.594	.75	3.803	2.992	.022	B	TCF050204BP	TCF060203BC
5578322	TCF0625R5SLR075B	.625	.75	3.993	3.148	.023	B	TCF050204BP	TCF060203BC
5578323	TCF0656R5SLR075B	.656	.75	4.183	3.304	.024	B	TCF050204BP	TCF060203BC
5578324	TCF0688R5SLR075B	.688	.75	4.379	3.465	.025	B	TCF050204BP	TCF060203BC
5578325	TCF0703R5SLR075B	.703	.75	4.471	3.540	.025	B	TCF050204BP	TCF060203BC
5578326	TCF0719R5SLR075B	.719	.75	4.569	3.620	.026	B	TCF050204BP	TCF060203BC
5578327	TCF0734R5SLR075B	.734	.75	4.661	3.696	.026	B	TCF050204BP	TCF060203BC
5578420	TCF0750R5SLR100C	.750	1.00	4.760	3.777	.027	C	TCF070306CP	TCF070304CC
5578421	TCF0781R5SLR100C	.781	1.00	4.950	3.933	.028	C	TCF070306CP	TCF070304CC
5578422	TCF0813R5SLR100C	.813	1.00	5.146	4.094	.029	C	TCF070306CP	TCF070304CC
5578423	TCF0844R5SLR100C	.844	1.00	5.336	4.250	.030	C	TCF070306CP	TCF070304CC
5578424	TCF0875R5SLR100C	.875	1.00	5.526	4.406	.031	C	TCF070306CP	TCF070304CC
5578425	TCF0906R5SLR100C	.906	1.00	5.716	4.562	.032	C	TCF070306CP	TCF070304CC
5578426	TCF0938R5SLR100C	.938	1.00	5.911	4.722	.032	C	TCF070306CP	TCF070304CC
5537929	TCF0969R5SLR100D	.969	1.00	6.007	4.880	.035	D	TCF080308DP	TCF090305DC
5537930	TCF0984R5SLR100D	.984	1.00	6.098	4.956	.036	D	TCF080308DP	TCF090305DC
5537931	TCF1000R5SLR100D	1.000	1.00	6.194	5.036	.036	D	TCF080308DP	TCF090305DC
5537932	TCF1031R5SLR125D	1.031	1.25	6.420	5.192	.037	D	TCF080308DP	TCF090305DC
5537933	TCF1063R5SLR125D	1.063	1.25	6.613	5.353	.038	D	TCF080308DP	TCF090305DC
5537934	TCF1094R5SLR125D	1.094	1.25	6.800	5.509	.039	D	TCF080308DP	TCF090305DC
5537935	TCF1125R5SLR125D	1.125	1.25	6.987	5.665	.040	D	TCF080308DP	TCF090305DC
5537936	TCF1156R5SLR125D	1.156	1.25	7.174	5.821	.041	D	TCF080308DP	TCF090305DC
5538092	TCF1188R5SLR125E	1.188	1.25	7.249	5.983	.043	E	TCF100408EP	TCF120405EC
5538093	TCF1210R5SLR125E	1.210	1.25	7.380	6.094	.044	E	TCF100408EP	TCF120405EC
5538094	TCF1219R5SLR125E	1.219	1.25	7.433	6.139	.044	E	TCF100408EP	TCF120405EC
5538095	TCF1250R5SLR125E	1.250	1.25	7.617	6.295	.045	E	TCF100408EP	TCF120405EC
5538096	TCF1280R5SLR125E	1.281	1.25	7.801	6.451	.046	E	TCF100408EP	TCF120405EC
5538097	TCF1313R5SLR125E	1.313	1.25	7.991	6.612	.047	E	TCF100408EP	TCF120405EC
5538098	TCF1375R5SLR125E	1.375	1.25	8.358	6.924	.049	E	TCF100408EP	TCF120405EC
5538099	TCF1406R5SLR150E	1.406	1.50	8.582	7.080	.050	E	TCF100408EP	TCF120405EC
5538100	TCF1438R5SLR150E	1.438	1.50	8.771	7.240	.050	E	TCF100408EP	TCF120405EC
5578685	TCF1469R5SLR150F	1.469	1.50	8.957	7.398	.054	F	TCF120412FP	TCF150406FC
5578686	TCF1500R5SLR150F	1.500	1.50	9.141	7.554	.055	F	TCF120412FP	TCF150406FC
5578687	TCF1531R5SLR150F	1.531	1.50	9.325	7.711	.056	F	TCF120412FP	TCF150406FC
5578688	TCF1563R5SLR150F	1.563	1.50	9.515	7.872	.057	F	TCF120412FP	TCF150406FC
5578689	TCF1625R5SLR150F	1.625	1.50	9.882	8.183	.058	F	TCF120412FP	TCF150406FC
5578690	TCF1656R5SLR150F	1.656	1.50	10.066	8.339	.059	F	TCF120412FP	TCF150406FC
5578691	TCF1688R5SLR150F	1.688	1.50	10.256	8.500	.060	F	TCF120412FP	TCF150406FC
5578693	TCF1750R5SLR150F	1.750	1.50	10.623	8.812	.062	F	TCF120412FP	TCF150406FC
5578803	TCF1813R5SLR150G	1.813	1.50	10.818	9.131	.066	G	TCF150512GP	TCF180508GC
5578804	TCF1875R5SLR150G	1.875	1.50	11.179	9.443	.068	G	TCF150512GP	TCF180508GC
5578805	TCF1938R5SLR150G	1.938	1.50	11.546	9.759	.069	G	TCF150512GP	TCF180508GC
5578806	TCF2000R5SLR150G	2.000	1.50	11.907	10.071	.071	G	TCF150512GP	TCF180508GC
5578807	TCF2125R5SLR150G	2.125	1.50	12.636	10.699	.075	G	TCF150512GP	TCF180508GC
5578808	TCF2219R5SLR150G	2.219	1.50	13.184	11.172	.077	G	TCF150512GP	TCF180508GC
5538509	TCF2250R5SLR150H	2.250	1.50	13.142	11.331	.081	H	TCF180614HP	TCF210608HC
5538510	TCF2375R5SLR150H	2.375	1.50	13.859	11.960	.085	H	TCF180614HP	TCF210608HC
5538511	TCF2500R5SLR150H	2.500	1.50	14.574	12.588	.088	H	TCF180614HP	TCF210608HC

NOTE: SSC = Pocket Seat Reference. To correspond with the SSC on the inserts.

(continued)

(Top Cut 4 Drill • Inch • 5 x D • SLR Shank – continued)

▼ Spare Parts



SSC	periphery insert	center insert	insert screw order number	Torx size	Torx driver order number	tightening torque Nm	tightening torque ft. lbs
A	TCF040204AP	TCF040203AC	2025073	T5	2029221	0,40	.295
B	TCF050204BP	TCF060203BC	1175225	T6	1138455	0,53	.390
C	TCF070306CP	TCF070304CC	1021337	T7	2029266	0,90	.663
D	TCF080308DP	TCF090305DC	1134385	T8	2029598	1,10	.811
E	TCF100408EP	TCF120405EC	2018194	T9	1138430	2,00	1.475
E	TCF100408EP	TCF120405EC	2018194	T9	1138455	2,00	1.475
F	TCF120412FP	TCF150406FC	1756815	T15	2029596	4,00	2.950
G	TCF150512GP	TCF180508GC	1099645	T20	1138455	6,30	4.646
H	TCF180614HP	TCF210608HC	1823871	T25	2585812	8,80	6.490

NOTE: Drill shipped with insert screws and Torx wrench.
 See pages 68–71 for inserts.
 SSC = Pocket Seat Reference.
 SLR = Side Lock.

D	LS	
	mm	in
.75	50	1.9685
1.00	56	2.2047
1.25	60	2.3622
1.50	70	2.7559



WARNING
 During through-hole operations, a slug or disc is produced as the tool breaks through the workpiece. When the drill is stationary and the workpiece is rotating, this slug may be hurled from the chuck by centrifugal force. Provide adequate shielding to protect bystanders.

Top Cut 4™

Top Cut 4 Shanks



▼ Top Cut 4 Drill • Metric • 5 x D • SLR Shanks

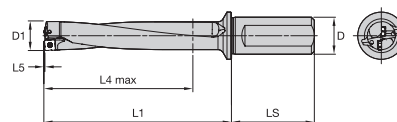

For information on L5, see the table on page 67.

order number	catalog number	D1	D	L1	L4 max	L5	SSC	periphery insert	center insert
5537874	TCF120R5SLR20MA	12,00	20	79,4	60,4	0,43	A	TCF040204AP	TCF040203AC
5537875	TCF125R5SLR20MA	12,50	20	82,0	63,0	0,45	A	TCF040204AP	TCF040203AC
5537876	TCF127R5SLR20MA	12,70	20	84,0	64,0	0,46	A	TCF040204AP	TCF040203AC
5537877	TCF130R5SLR20MA	13,00	20	85,5	65,5	0,47	A	TCF040204AP	TCF040203AC
5537878	TCF135R5SLR20MA	13,50	20	89,0	68,0	0,48	A	TCF040204AP	TCF040203AC
5577948	TCF140R5SLR25MB	14,00	25	90,5	70,5	0,49	B	TCF050204BP	TCF060203BC
5577949	TCF145R5SLR25MB	14,50	25	93,0	73,0	0,52	B	TCF050204BP	TCF060203BC
5577950	TCF150R5SLR25MB	15,00	25	96,5	75,5	0,55	B	TCF050204BP	TCF060203BC
5577951	TCF155R5SLR25MB	15,50	25	100,1	78,1	0,56	B	TCF050204BP	TCF060203BC
5577952	TCF160R5SLR25MB	16,00	25	102,6	80,6	0,58	B	TCF050204BP	TCF060203BC
5577953	TCF165R5SLR25MB	16,50	25	106,1	83,1	0,60	B	TCF050204BP	TCF060203BC
5577954	TCF170R5SLR25MB	17,00	25	108,6	85,6	0,61	B	TCF050204BP	TCF060203BC
5577955	TCF175R5SLR25MB	17,50	25	112,1	88,1	0,63	B	TCF050204BP	TCF060203BC
5577956	TCF180R5SLR25MB	18,00	25	114,6	90,6	0,64	B	TCF050204BP	TCF060203BC
5577957	TCF185R5SLR25MB	18,50	25	118,2	93,2	0,65	B	TCF050204BP	TCF060203BC
5578844	TCF190R5SLR25MC	19,00	25	120,7	95,7	0,68	C	TCF070306CP	TCF070304CC
5578845	TCF195R5SLR25MC	19,50	25	124,2	98,2	0,71	C	TCF070306CP	TCF070304CC
5578846	TCF200R5SLR25MC	20,00	25	126,7	100,7	0,72	C	TCF070306CP	TCF070304CC
5578847	TCF205R5SLR25MC	20,50	25	130,2	103,2	0,74	C	TCF070306CP	TCF070304CC
5578848	TCF210R5SLR25MC	21,00	25	133,8	105,8	0,75	C	TCF070306CP	TCF070304CC
5578849	TCF220R5SLR25MC	22,00	25	139,8	110,8	0,78	C	TCF070306CP	TCF070304CC
5578850	TCF225R5SLR25MC	22,50	25	142,3	113,3	0,79	C	TCF070306CP	TCF070304CC
5578851	TCF230R5SLR25MC	23,00	25	145,8	115,8	0,80	C	TCF070306CP	TCF070304CC
5537838	TCF240R5SLR25MD	24,00	25	148,9	120,9	0,87	D	TCF080308DP	TCF090305DC
5537839	TCF250R5SLR32MD	25,00	32	155,9	125,9	0,91	D	TCF080308DP	TCF090305DC
5537840	TCF260R5SLR32MD	26,00	32	161,9	130,9	0,94	D	TCF080308DP	TCF090305DC
5537841	TCF265R5SLR32MD	26,50	32	165,5	133,5	0,95	D	TCF080308DP	TCF090305DC
5537842	TCF270R5SLR32MD	27,00	32	168,0	136,0	0,97	D	TCF080308DP	TCF090305DC
5537843	TCF280R5SLR32MD	28,00	32	174,0	141,0	0,99	D	TCF080308DP	TCF090305DC
5537844	TCF290R5SLR32MD	29,00	32	180,0	146,0	1,02	D	TCF080308DP	TCF090305DC
5537958	TCF300R5SLR32ME	30,00	32	183,1	151,1	1,09	E	TCF100408EP	TCF120405EC
5537959	TCF310R5SLR32ME	31,00	32	189,1	156,1	1,12	E	TCF100408EP	TCF120405EC
5537960	TCF320R5SLR32ME	32,00	32	195,2	161,2	1,15	E	TCF100408EP	TCF120405EC
5537961	TCF330R5SLR40ME	33,00	40	202,2	166,2	1,18	E	TCF100408EP	TCF120405EC
5537962	TCF340R5SLR40ME	34,00	40	208,2	171,2	1,21	E	TCF100408EP	TCF120405EC
5537963	TCF350R5SLR40ME	35,00	40	214,2	176,2	1,24	E	TCF100408EP	TCF120405EC
5537964	TCF360R5SLR40ME	36,00	40	220,3	181,3	1,27	E	TCF100408EP	TCF120405EC
5578629	TCF370R5SLR40MF	37,00	40	226,3	186,3	1,35	F	TCF120412FP	TCF150406FC
5578640	TCF375R5SLR40MF	37,50	40	228,9	188,9	1,36	F	TCF120412FP	TCF150406FC
5578641	TCF380R5SLR40MF	38,00	40	232,4	191,4	1,38	F	TCF120412FP	TCF150406FC
5578642	TCF390R5SLR40MF	39,00	40	238,4	196,4	1,41	F	TCF120412FP	TCF150406FC
5578643	TCF400R5SLR40MF	40,00	40	243,4	201,4	1,45	F	TCF120412FP	TCF150406FC
5578644	TCF410R5SLR40MF	41,00	40	249,5	206,5	1,48	F	TCF120412FP	TCF150406FC
5578645	TCF420R5SLR40MF	42,00	40	255,5	211,5	1,51	F	TCF120412FP	TCF150406FC
5578646	TCF430R5SLR40MF	43,00	40	261,5	216,5	1,53	F	TCF120412FP	TCF150406FC
5578647	TCF440R5SLR40MF	44,00	40	267,6	221,6	1,56	F	TCF120412FP	TCF150406FC
5578648	TCF450R5SLR40MF	45,00	40	273,6	226,6	1,59	F	TCF120412FP	TCF150406FC
5578751	TCF460R5SLR40MG	46,00	40	274,7	231,7	1,67	G	TCF150512GP	TCF180508GC
5578752	TCF470R5SLR40MG	47,00	40	280,7	236,7	1,70	G	TCF150512GP	TCF180508GC
5578753	TCF480R5SLR40MG	48,00	40	286,7	241,7	1,73	G	TCF150512GP	TCF180508GC
5578754	TCF490R5SLR40MG	49,00	40	292,8	246,8	1,76	G	TCF150512GP	TCF180508GC
5578755	TCF500R5SLR40MG	50,00	40	297,8	251,8	1,79	G	TCF150512GP	TCF180508GC

(continued)

(Top Cut 4 Drill • Metric • 5 x D • SLR Shanks — continued)

order number	catalog number	D1	D	L1	L4 max	L5	SSC	periphery insert	center insert
5578756	TCF505R5SLR40MG	50,50	40	301,3	254,3	1,80	G	TCF150512GP	TCF180508GC
5578757	TCF510R5SLR40MG	51,00	40	303,8	256,8	1,81	G	TCF150512GP	TCF180508GC
5578758	TCF520R5SLR40MG	52,00	40	309,8	261,8	1,84	G	TCF150512GP	TCF180508GC
5578759	TCF530R5SLR40MG	53,00	40	315,9	266,9	1,87	G	TCF150512GP	TCF180508GC
5578760	TCF540R5SLR40MG	54,00	40	321,9	271,9	1,89	G	TCF150512GP	TCF180508GC
5578761	TCF550R5SLR40MG	55,00	40	326,9	276,9	1,92	G	TCF150512GP	TCF180508GC
5578762	TCF560R5SLR40MG	56,00	40	332,9	281,9	1,94	G	TCF150512GP	TCF180508GC
5538659	TCF570R5SLR40MH	57,00	40	333,1	287,1	2,06	H	TCF180614HP	TCF210608HC
5538680	TCF580R5SLR40MH	58,00	40	339,1	292,1	2,09	H	TCF180614HP	TCF210608HC
5538681	TCF590R5SLR40MH	59,00	40	345,1	297,1	2,12	H	TCF180614HP	TCF210608HC
5538682	TCF600R5SLR40MH	60,00	40	350,1	302,1	2,15	H	TCF180614HP	TCF210608HC
5538683	TCF610R5SLR40MH	61,00	40	356,2	307,2	2,18	H	TCF180614HP	TCF210608HC
5538684	TCF620R5SLR40MH	62,00	40	362,2	312,2	2,20	H	TCF180614HP	TCF210608HC
5538685	TCF630R5SLR40MH	63,00	40	368,2	317,2	2,23	H	TCF180614HP	TCF210608HC
5538686	TCF640R5SLR40MH	64,00	40	373,3	322,3	2,26	H	TCF180614HP	TCF210608HC
5538687	TCF650R5SLR40MH	65,00	40	379,3	327,3	2,28	H	TCF180614HP	TCF210608HC
5538688	TCF660R5SLR40MH	66,00	40	385,3	332,3	2,31	H	TCF180614HP	TCF210608HC
5538689	TCF670R5SLR40MH	67,00	40	390,3	337,3	2,33	H	TCF180614HP	TCF210608HC
5538700	TCF680R5SLR40MH	68,00	40	396,4	342,4	2,36	H	TCF180614HP	TCF210608HC

NOTE: SSC = Pocket Seat Reference. To correspond with the SSC on the inserts.

▼ Spare Parts



SSC	periphery insert	center insert	insert screw order number	Torx size	Torx driver order number	tightening torque Nm	tightening torque ft. lbs
A	TCF040204AP	TCF040203AC	2025073	T5	2029221	0,40	.295
B	TCF050204BP	TCF060203BC	1175225	T6	1138455	0,53	.390
C	TCF070306CP	TCF070304CC	1021337	T7	2029266	0,90	.663
D	TCF080308DP	TCF090305DC	1134385	T8	2029598	1,10	.811
E	TCF100408EP	TCF120405EC	2018194	T9	1138430	2,00	1.475
F	TCF120412FP	TCF150406FC	1756815	T15	1138455	4,00	2.950
F	TCF120412FP	TCF150406FC	1756815	T15	2029596	4,00	2.950
G	TCF150512GP	TCF180508GC	1099645	T20	1138455	6,30	4.646
H	TCF180614HP	TCF210608HC	1823871	T25	1022519	8,80	6.490
H	TCF180614HP	TCF210608HC	1823871	T25	1138455	8,80	6.490

NOTE: Drilling in stacked plates possible in certain applications. Ask for technical support.

Drill shipped with insert screws and Torx wrench.

See pages 68–71 for inserts.

SSC = Pocket Seat Reference.

SLR = Side Lock.

D	LS	
	mm	in
20,00	50	1.969
25,00	56	2.205
32,00	60	2.362
40,00	70	2.756

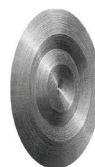

WARNING
During through-hole operations, a slug or disc is produced as the tool breaks through the workpiece. When the drill is stationary and the workpiece is rotating, this slug may be hurled from the chuck by centrifugal force. Provide adequate shielding to protect bystanders.

Top Cut 4™

Top Cut 4 Drill • Center Inserts • Aluminum V36

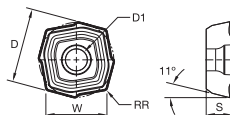

● first choice
○ alternate choice

P	●	●	●	●
M	●	●	●	●
K	●	●	●	●
N	●	●	●	●
S	●	●	●	●
H	●	●	●	●

▼ Top Cut 4 Drill • Center Inserts • Aluminum V36

catalog number	D		D1		W		S		RR		SSC	WPK10CH	WU25CH	WU40PH	WN10PH
	mm	in	mm	in	mm	in	mm	in	mm	in					
TCF040203ACV36	4,47	.176	2,10	.083	3,65	.144	2,00	.079	0,300	.011	A	•	•	•	•
TCF060203BCV36	6,00	.236	2,40	.094	4,90	.193	2,40	.095	0,300	.011	B	•	•	•	•
TCF070304CCV36	7,59	.299	2,60	.102	6,20	.244	2,80	.110	0,400	.015	C	•	•	•	•
TCF090305DCV36	9,55	.376	2,80	.110	7,80	.307	3,00	.118	0,500	.019	D	•	•	•	•
TCF120405ECV36	12,00	.473	3,40	.134	9,80	.386	3,60	.142	0,500	.019	E	•	•	•	•
TCF150406FCV36	14,94	.588	4,80	.189	12,20	.480	4,20	.165	0,600	.023	F	•	•	•	•
TCF180508GCV36	17,88	.704	6,00	.236	14,60	.575	5,40	.213	0,800	.031	G	•	•	•	•
TCF210608HCV36	21,68	.853	7,50	.295	17,70	.697	6,50	.256	0,800	.031	H	•	•	•	•

NOTE: SSC = Pocket Seat Reference. To correspond with the SSC on the toolholder.

Top Cut 4™ Drill • Periphery Inserts • Aluminum V36

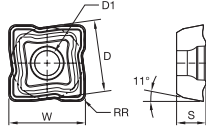

● first choice
○ alternate choice

P	●	●	●	●
M	●	●	●	●
K	●	●	●	●
N	●	●	●	●
S	●	●	●	●
H	●	●	●	●

▼ Top Cut 4 Drill • Periphery Inserts • Aluminum V36

catalog number	D		D1		W		S		RR		SSC	WPK10CH	WU25CH	WU40PH	WNI10PH
	mm	in	mm	in	mm	in	mm	in	mm	in					
TCF040204APV36	4,14	.163	2,10	.083	4,40	.173	2,00	.079	0,400	.015	A	•	•	•	•
TCF050204BPV36	5,07	.200	2,40	.094	5,40	.213	2,40	.094	0,400	.015	B	•	•	•	•
TCF070306CPV36	6,67	.263	2,60	.102	7,10	.280	2,80	.110	0,600	.023	C	•	•	•	•
TCF080308DPV36	8,08	.318	2,80	.110	8,60	.339	3,00	.118	0,800	.031	D	•	•	•	•
TCF100408EPV36	9,96	.392	3,40	.134	10,60	.417	3,60	.142	0,800	.031	E	•	•	•	•
TCF120412FPV36	12,59	.496	4,80	.189	13,40	.528	4,20	.165	1,200	.046	F	•	•	•	•
TCF150512GPV36	15,13	.596	6,00	.236	16,10	.634	5,40	.213	1,200	.046	G	•	•	•	•
TCF180614HPV36	18,04	.710	7,50	.295	19,20	.756	6,50	.256	1,400	.054	H	•	•	•	•

NOTE: SSC = Pocket Seat Reference. To correspond with the SSC on the toolholder.

Top Cut 4™

Top Cut 4 Drill • Center Inserts • Long Chip Materials V38

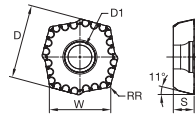

● first choice
○ alternate choice

P	●	●	●	●
M	●	●	●	●
K	●	●	●	●
N	●	●	●	●
S	●	●	●	●
H	●	●	●	●

▼ Top Cut 4 Drill • Center Inserts • Long Chip Materials V38

catalog number	D		D1		W		S		RR		SSC	WPK10CH	WU25CH	WU40PH
	mm	in	mm	in	mm	in	mm	in	mm	in				
TCF040203ACV38	4,47	.176	2,10	.083	3,65	.144	2,00	.079	0,300	.012	A			6429458
TCF060203BCV38	6,00	.236	2,40	.094	4,90	.193	2,40	.095	0,300	.012	B			6429459
TCF070304CCV38	7,59	.299	2,60	.102	6,20	.244	2,80	.110	0,400	.015	C			6429460
TCF090305DCV38	9,55	.376	2,80	.110	7,80	.307	3,00	.118	0,500	.019	D			6429461
TCF120405ECV38	12,00	.473	3,40	.134	9,80	.386	3,60	.142	0,500	.019	E			6429462
TCF150406FCV38	14,94	.588	4,80	.189	12,20	.480	4,20	.165	0,600	.023	F			6429463
TCF180508GCV38	17,88	.704	6,00	.236	14,60	.575	5,40	.213	0,800	.031	G			6324383
TCF210608HCV38	21,68	.853	7,50	.295	17,70	.697	6,50	.256	0,800	.031	H			6429464

NOTE: SSC = Pocket Seat Reference. To correspond with the SSC on the toolholder.
Refer to the WIDIA™ 2017 Master Catalog (A-15-04580EN_in) or the NOVO™ application for the complete geometry offering.

Top Cut 4™ Drill • Periphery Inserts • Long Chip Materials V38

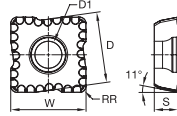

● first choice
○ alternate choice

P	●	●	●
M	●	●	●
K	●	●	●
N	○	○	○
S	○	○	○
H	○	○	○

▼ Top Cut 4 Drill • Periphery Inserts • Long Chip Materials V38

catalog number	D		D1		W		S		RR		SSC	WPK10CH	WU25CH	WU40PH
	mm	in	mm	in	mm	in	mm	in	mm	in				
TCF040204APV38	4,14	.163	2,10	.083	4,40	.173	2,00	.079	0,400	.015	A		6429424	6429425
TCF050204BPV38	5,07	.200	2,40	.094	5,40	.213	2,40	.094	0,400	.015	B		6429426	6429427
TCF070306CPV38	6,67	.263	2,60	.102	7,10	.280	2,80	.110	0,600	.023	C		6429466	6429428
TCF080308DPV38	8,08	.318	2,80	.110	8,60	.339	3,00	.118	0,800	.031	D		6429429	6429430
TCF100408EPV38	9,96	.392	3,40	.134	10,60	.417	3,60	.142	0,800	.031	E		6429451	6429452
TCF120412FPV38	12,59	.496	4,80	.189	13,40	.528	4,20	.165	1,200	.046	F		6429453	6429454
TCF150512GPV38	15,13	.596	6,00	.236	16,10	.634	5,40	.213	1,200	.046	G		6429455	6324381
TCF180614HPV38	18,04	.710	7,50	.295	19,20	.756	6,50	.256	1,400	.054	H		6429456	6429457

NOTE: SSC = Pocket Seat Reference. To correspond with the SSC on the toolholder.
Refer to the WIDIA™ 2017 Master Catalog (A-15-04580EN_in) or the NOVO™ application for the complete geometry offering.

Top Cut 4™

New Generation Indexable Drilling System

▼ Top Cut 4 • Insert Selection Guide

Material Group	Geometry	Stable Cutting Conditions		Unstable Cutting Conditions		Interrupted Cutting Conditions	
		periphery insert	center insert	periphery insert	center insert	periphery insert	center insert
P1	V38	WU25CH	WU40PH	WU40PH	WU40PH	WU40PH	WU40PH
P2-P4	V34	WPK10CH	WU40PH	WU25CH	WU40PH	WU40PH	WU40PH
P5-P6	V36	WU25CH	WU40PH	WU40PH	WU40PH	WU40PH	WU40PH
M1-M3	V36	WU25CH	WU40PH	WU40PH	WU40PH	WU40PH	WU40PH
K1-K3	V34	WPK10CH	WU40PH	WU40PH	WU40PH	WU40PH	WU40PH
N1-N4	V36	WN10PH	WN10PH	WN10PH	WN10PH	WN10PH	WN10PH
S1-S4	V38	WU40PH	WU40PH	WU40PH	WU40PH	WU40PH	WU40PH

▼ Top Cut 4 • Cutting Data • Inch

Material Group	Geometry	Grade		Cutting Speed – Vc SFM			Inch				
							Recommended Feed Rate per Revolution				
							Tool Diameter	.473–.531" Insert Size A	.563–.734" Insert Size B	.750–.938" Insert Size C	.969–1.156" Insert Size D
P0	-V38	WU40PH	WU25CH	360	540	780	IPR	0.0024–0.0031	0.0031–0.0043	0.0039–0.0051	0.0043–0.0055
P1	-V38	WU40PH	WU25CH	360	540	780	IPR	0.0024–0.0039	0.0031–0.0051	0.0039–0.0059	0.0043–0.0063
P2	-V34	WU40PH	WU25CH	360	570	840	IPR	0.0024–0.0039	0.0031–0.0059	0.0039–0.0063	0.0043–0.0067
P3	-V34	WU40PH	WPK10CH	360	600	930	IPR	0.0031–0.0059	0.0039–0.0063	0.0043–0.0071	0.0047–0.0079
P4	-V34	WU40PH	WPK10CH	360	570	930	IPR	0.0031–0.0059	0.0039–0.0063	0.0043–0.0071	0.0047–0.0079
P5	-V36	WU40PH	WU25CH	360	540	750	IPR	0.0024–0.0039	0.0031–0.0055	0.0039–0.0059	0.0043–0.0063
P6	-V36	WU40PH	WU25CH	360	480	630	IPR	0.0024–0.0039	0.0031–0.0055	0.0039–0.0059	0.0043–0.0063
M1	-V38	WU40PH	WU40PH	360	480	720	IPR	0.0024–0.0047	0.0028–0.0051	0.0031–0.0059	0.0039–0.0063
M2	-V36	WU40PH	WU40PH	330	420	630	IPR	0.0024–0.0047	0.0028–0.0051	0.0031–0.0059	0.0039–0.0063
M3	-V36	WU40PH	WU40PH	300	360	600	IPR	0.0024–0.0047	0.0028–0.0051	0.0031–0.0059	0.0039–0.0063
K1	-V34	WU25CH	WPK10CH	360	600	840	IPR	0.0031–0.0055	0.0031–0.0063	0.0039–0.0071	0.0047–0.0094
K2	-V34	WU40PH	WPK10CH	300	540	780	IPR	0.0031–0.0055	0.0031–0.0063	0.0039–0.0071	0.0047–0.0094
K3	-V34	WU40PH	WPK10CH	300	510	720	IPR	0.0031–0.0055	0.0031–0.0063	0.0039–0.0071	0.0047–0.0094
N1	-V36	WN10PH	WN10PH	750	1050	1500	IPR	0.0024–0.0039	0.0031–0.0055	0.0039–0.0059	0.0043–0.0063
N2	-V36	WN10PH	WN10PH	450	900	1350	IPR	0.0024–0.0039	0.0031–0.0055	0.0039–0.0059	0.0043–0.0063
N3	-V36	WN10PH	WN10PH	240	360	450	IPR	0.0024–0.0039	0.0028–0.0043	0.0031–0.0047	0.0039–0.0055
S3	-V38	WU40PH	WU40PH	60	90	135	IPR	0.0031–0.0047	0.0031–0.0051	0.0039–0.0059	0.0047–0.0075
S4	-V38	WU40PH	WU40PH	105	120	195	IPR	0.0031–0.0047	0.0031–0.0051	0.0039–0.0059	0.0047–0.0075

Material Group	Geometry	Grade		Cutting Speed – Vc SFM			Tool Diameter	Inch			
								Recommended Feed Rate per Revolution			
								1.188–1.438" Insert Size E	1.469–1.750" Insert Size F	1.813–2.219" Insert Size G	2.250–2.500" Insert Size H
P0	-V38	WU40PH	WU25CH	360	540	780	IPR	0.0051–0.0063	0.0059–0.0071	0.0063–0.0091	0.0067–0.0094
P1	-V38	WU40PH	WU25CH	360	540	780	IPR	0.0051–0.0071	0.0059–0.0079	0.0063–0.0106	0.0067–0.0114
P2	-V34	WU40PH	WU25CH	360	570	840	IPR	0.0051–0.0079	0.0059–0.0083	0.0063–0.0110	0.0067–0.0118
P3	-V34	WU40PH	WPK10CH	360	600	930	IPR	0.0053–0.0094	0.0063–0.0094	0.0071–0.0118	0.0075–0.0126
P4	-V34	WU40PH	WPK10CH	360	570	930	IPR	0.0055–0.0087	0.0063–0.0094	0.0071–0.0118	0.0075–0.0126
P5	-V36	WU40PH	WU25CH	360	540	750	IPR	0.0051–0.0071	0.0059–0.0079	0.0063–0.0110	0.0067–0.0118
P6	-V36	WU40PH	WU25CH	360	480	630	IPR	0.0051–0.0071	0.0059–0.0079	0.0063–0.0110	0.0067–0.0114
M1	-V38	WU40PH	WU40PH	360	480	720	IPR	0.0047–0.0079	0.0055–0.0098	0.0063–0.0110	0.0063–0.0118
M2	-V36	WU40PH	WU40PH	330	420	630	IPR	0.0047–0.0079	0.0055–0.0098	0.0063–0.0110	0.0063–0.0118
M3	-V36	WU40PH	WU40PH	300	360	600	IPR	0.0047–0.0079	0.0055–0.0098	0.0063–0.0110	0.0063–0.0118
K1	-V34	WU25CH	WPK10CH	360	600	840	IPR	0.0055–0.0102	0.0063–0.0118	0.0071–0.0126	0.0079–0.0142
K2	-V34	WU40PH	WPK10CH	300	540	780	IPR	0.0055–0.0102	0.0063–0.0118	0.0071–0.0126	0.0079–0.0142
K3	-V34	WU40PH	WPK10CH	300	510	720	IPR	0.0055–0.0102	0.0063–0.0118	0.0071–0.0126	0.0079–0.0142
N1	-V36	WN10PH	WN10PH	750	1050	1500	IPR	0.0051–0.0071	0.0059–0.0079	0.0063–0.0110	0.0067–0.0118
N2	-V36	WN10PH	WN10PH	450	900	1350	IPR	0.0051–0.0071	0.0059–0.0079	0.0063–0.0110	0.0067–0.0118
N3	-V36	WN10PH	WN10PH	240	360	450	IPR	0.0047–0.0067	0.0055–0.0083	0.0063–0.0091	0.0063–0.0094
S3	-V38	WU40PH	WU40PH	60	90	135	IPR	0.0055–0.0083	0.0063–0.0094	0.0071–0.0102	0.0079–0.0118
S4	-V38	WU40PH	WU40PH	105	120	195	IPR	0.0055–0.0083	0.0063–0.0094	0.0071–0.0102	0.0079–0.0118

NOTE: All speed conditions are for stable conditions. For unstable conditions, it is suggested to reduce starting speeds by 10%. For interrupted cuts, reduce by 20%.
 For 4 x D, it is highly recommended to start with feed and speed values reduced by 10% less than above data.
 For 5 x D, diameter range .473–.938" (insert sizes A to C), it is highly recommended to start with feed and speed values reduced by 20% less than above data.
 For 5 x D, diameter range .969–2.5" (insert sizes D to H), it is highly recommended to start with feed and speed values reduced by 15% less than above data.
 For 4 x D and 5 x D, it is recommended to reduce feed rate during entry and exit by 30–50%.

New Generation Indexable Drilling System

▼ Top Cut 4™ • Cutting Data • Metric

Material Group	Geometry	Grade		Cutting Speed – Vc m/min			Metric				
							Recommended Feed Rate per Revolution				
							Tool Diameter	12,00–13,99 Insert Size A	14,00–18,99 Insert Size B	19,00–23,99 Insert Size C	24,00–29,99 Insert Size D
center	periphery	min	Start	max							
P0	-V38	WU40PH	WU25CH	120	180	260	mm/rev	0,06–0,08	0,08–0,11	0,10–0,13	0,11–0,14
P1	-V38	WU40PH	WU25CH	120	180	260	mm/rev	0,06–0,10	0,08–0,13	0,10–0,15	0,11–0,16
P2	-V34	WU40PH	WU25CH	120	190	280	mm/rev	0,06–0,10	0,08–0,15	0,10–0,16	0,11–0,17
P3	-V34	WU40PH	WPK10CH	120	200	310	mm/rev	0,08–0,15	0,10–0,16	0,11–0,18	0,12–0,20
P4	-V34	WU40PH	WPK10CH	120	190	310	mm/rev	0,08–0,15	0,10–0,16	0,11–0,18	0,12–0,20
P5	-V36	WU40PH	WU25CH	120	180	250	mm/rev	0,06–0,10	0,08–0,14	0,10–0,15	0,11–0,16
P6	-V36	WU40PH	WU25CH	120	160	210	mm/rev	0,06–0,10	0,08–0,14	0,10–0,15	0,11–0,16
M1	-V38	WU40PH	WU40PH	120	160	240	mm/rev	0,06–0,11	0,07–0,11	0,08–0,12	0,10–0,14
M2	-V36	WU40PH	WU40PH	110	140	210	mm/rev	0,06–0,10	0,07–0,11	0,08–0,12	0,10–0,14
M3	-V36	WU40PH	WU40PH	100	120	200	mm/rev	0,06–0,10	0,07–0,11	0,08–0,12	0,10–0,14
K1	-V34	WU25CH	WPK10CH	120	200	280	mm/rev	0,08–0,14	0,08–0,16	0,10–0,18	0,12–0,24
K2	-V34	WU40PH	WPK10CH	100	180	260	mm/rev	0,08–0,14	0,08–0,16	0,10–0,18	0,12–0,24
K3	-V34	WU40PH	WPK10CH	100	170	240	mm/rev	0,08–0,14	0,08–0,16	0,10–0,18	0,12–0,24
N1	-V36	WN10PH	WN10PH	250	350	500	mm/rev	0,06–0,10	0,08–0,14	0,10–0,15	0,11–0,16
N2	-V36	WN10PH	WN10PH	150	300	450	mm/rev	0,06–0,10	0,08–0,14	0,10–0,15	0,11–0,16
N3	-V36	WN10PH	WN10PH	80	120	150	mm/rev	0,06–0,10	0,07–0,11	0,08–0,12	0,10–0,14
S3	-V38	WU40PH	WU40PH	20	30	45	mm/rev	0,08–0,12	0,08–0,13	0,10–0,15	0,12–0,19
S4	-V38	WU40PH	WU40PH	35	40	65	mm/rev	0,08–0,12	0,08–0,13	0,10–0,15	0,12–0,19

Material Group	Geometry	Grade		Cutting Speed – Vc m/min			Metric				
							Recommended Feed Rate per Revolution				
							Tool Diameter	30,00–36,99 Insert Size E	37,00–45,99 Insert Size F	46,00–56,99 Insert Size G	57,00–68,00 Insert Size H
center	periphery	min	Start	max							
P0	-V38	WU40PH	WU25CH	120	180	260	mm/rev	0,13–0,16	0,15–0,18	0,16–0,23	0,17–0,24
P1	-V38	WU40PH	WU25CH	120	180	260	mm/rev	0,13–0,17	0,15–0,19	0,16–0,24	0,17–0,25
P2	-V34	WU40PH	WU25CH	120	190	280	mm/rev	0,13–0,20	0,15–0,21	0,16–0,28	0,17–0,30
P3	-V34	WU40PH	WPK10CH	120	200	310	mm/rev	0,16–0,24	0,16–0,24	0,18–0,30	0,19–0,32
P4	-V34	WU40PH	WPK10CH	120	190	310	mm/rev	0,14–0,22	0,16–0,24	0,18–0,30	0,19–0,32
P5	-V36	WU40PH	WU25CH	120	180	250	mm/rev	0,13–0,18	0,15–0,20	0,16–0,28	0,17–0,30
P6	-V36	WU40PH	WU25CH	120	160	210	mm/rev	0,13–0,18	0,15–0,20	0,16–0,28	0,17–0,29
M1	-V38	WU40PH	WU40PH	120	160	240	mm/rev	0,12–0,17	0,14–0,21	0,16–0,23	0,16–0,24
M2	-V36	WU40PH	WU40PH	110	140	210	mm/rev	0,12–0,17	0,14–0,21	0,16–0,23	0,16–0,24
M3	-V36	WU40PH	WU40PH	100	120	200	mm/rev	0,12–0,17	0,14–0,21	0,16–0,23	0,16–0,24
K1	-V34	WU25CH	WPK10CH	120	200	280	mm/rev	0,14–0,26	0,16–0,30	0,18–0,32	0,20–0,36
K2	-V34	WU40PH	WPK10CH	100	180	260	mm/rev	0,14–0,26	0,16–0,30	0,18–0,32	0,20–0,36
K3	-V34	WU40PH	WPK10CH	100	170	240	mm/rev	0,14–0,26	0,16–0,30	0,18–0,32	0,20–0,36
N1	-V36	WN10PH	WN10PH	250	350	500	mm/rev	0,13–0,18	0,15–0,20	0,16–0,28	0,17–0,30
N2	-V36	WN10PH	WN10PH	150	300	450	mm/rev	0,13–0,18	0,15–0,20	0,16–0,28	0,17–0,30
N3	-V36	WN10PH	WN10PH	80	120	150	mm/rev	0,12–0,17	0,14–0,21	0,16–0,23	0,16–0,24
S3	-V38	WU40PH	WU40PH	20	30	45	mm/rev	0,14–0,21	0,16–0,24	0,18–0,26	0,20–0,30
S4	-V38	WU40PH	WU40PH	35	40	65	mm/rev	0,14–0,21	0,16–0,24	0,18–0,26	0,20–0,30

NOTE: All speed conditions are for stable conditions. For unstable conditions, it is suggested to reduce starting speeds by 10%. For interrupted cuts, reduce by 20%.
 For 4 x D, it is highly recommended to start with feed and speed values reduced by 10% less than above data.
 For 5 x D, diameter range 12–23,99mm (insert sizes A to C), it is highly recommended to start with feed and speed values reduced by 20% less than above data.
 For 5 x D, diameter range 25–68mm (inserts sizes D to H), it is highly recommended to start with feed and speed values reduced by 15% less than above data.
 For 4 x D and 5 x D, it is recommended to reduce feed rate during entry and exit by 30–50%.

Top Cut 4™

New Generation Indexable Drilling System

▼ Top Cut 4 • Drill Depth • X-Offset Capabilities • Hole Tolerance

Insert size	Diameter range mm (in)	2 x D/3 x D			4 x D			5 x D		
		X-offset value max. in mm (max. in inch)	D1 max value mm (in)	Hole tolerance mm (in)	X-offset value max. in mm (max. in inch)	D1 max value mm (in)	Hole tolerance mm (in)	X-offset value max. in mm (max. in inch)	D1 max value mm (in)	Hole tolerance mm (in)
A	12,00–13,99 (.473–.531)	0,5 (0.020)	D1 + 1mm (D1 + 0.039")	+/- 0,20 (+/- 0.008)	0,5 (0.020)	D1 + 1mm (D1 + 0.039")	+/- 0,35 (+/- 0.014)	—	—	+/- 0,35 (+/- 0.014)
B	14,00–18,99 (.563–.734)	0,5 (0.020)	D1 + 1mm (D1 + 0.039")	+/- 0,20 (+/- 0.008)	0,5 (0.020)	D1 + 1mm (D1 + 0.039")	+/- 0,35 (+/- 0.014)	—	—	+/- 0,35 (+/- 0.014)
C	19,00–23,99 (.750–.938)	0,5 (0.020)	D1 + 1mm (D1 + 0.039")	+/- 0,20 (+/- 0.008)	0,5 (0.020)	D1 + 1mm (D1 + 0.039")	+/- 0,35 (+/- 0.014)	—	—	+/- 0,35 (+/- 0.014)
D	24,00–29,99 (.969–1.156)	0,8 (0.031)	D1 + 1,6mm (D1 + 0.063")	+/- 0,20 (+/- 0.008)	0,8 (0.031)	D1 + 1mm (D1 + 0.039")	+/- 0,35 (+/- 0.014)	—	—	+/- 0,35 (+/- 0.014)
E	30,00–36,99 (1.188–1.438)	0,8 (0.031)	D1 + 1,6mm (D1 + 0.063")	+/- 0,20 (+/- 0.008)	0,8 (0.031)	D1 + 1mm (D1 + 0.039")	+/- 0,35 (+/- 0.014)	—	—	+/- 0,35 (+/- 0.014)
F	37,00–45,99 (1.469–1.750)	0,8 (0.031)	D1 + 1,6mm (D1 + 0.063")	+/- 0,25 (+/- 0.010)	0,8 (0.031)	D1 + 1mm (D1 + 0.039")	+/- 0,38 (+/- 0.015)	—	—	+/- 0,38 (+/- 0.015)
G	46,00–56,99 (1.813–2.219)	1 (0.039)	D1 + 2mm (D1 + 0.079")	+/- 0,25 (+/- 0.010)	0,8 (0.031)	D1 + 1mm (D1 + 0.039")	+/- 0,38 (+/- 0.015)	—	—	+/- 0,38 (+/- 0.015)
H	57,00–68,00 (2.250–2.500)	1 (0.039)	D1 + 2mm (D1 + 0.079")	+/- 0,28 (+/- 0.011)	0,8 (0.031)	D1 + 1mm (D1 + 0.039")	+/- 0,42 (+/- 0.017)	—	—	+/- 0,42 (+/- 0.017)

New Generation Indexable Drilling System

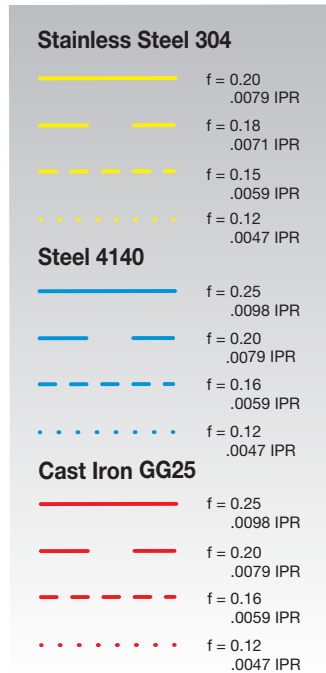
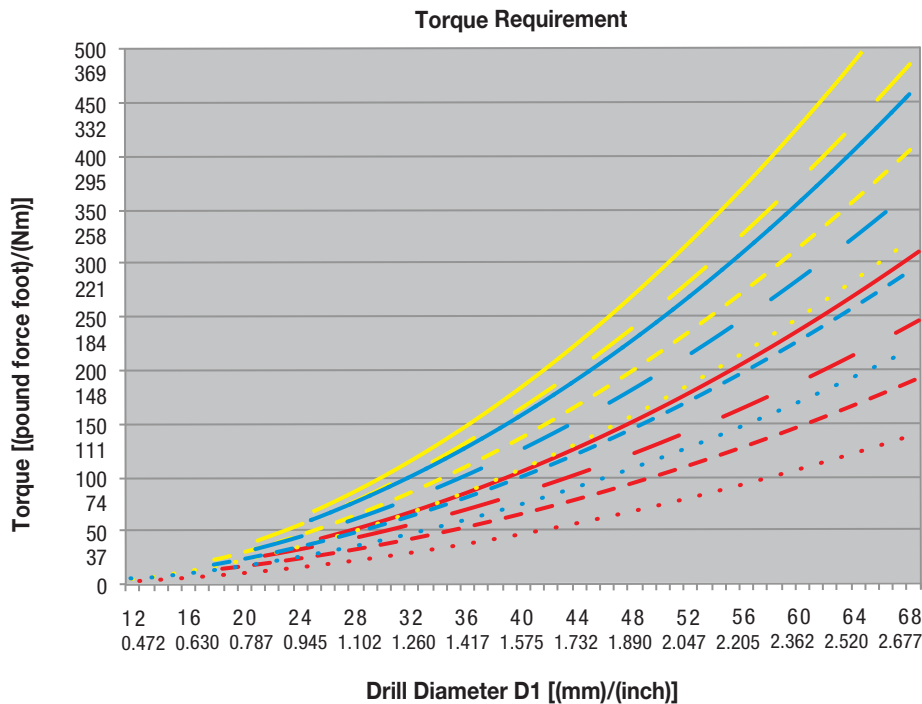
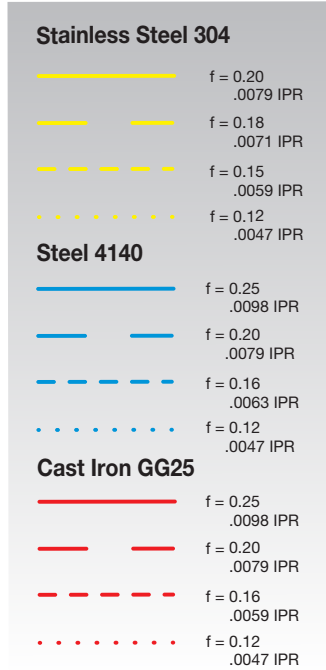
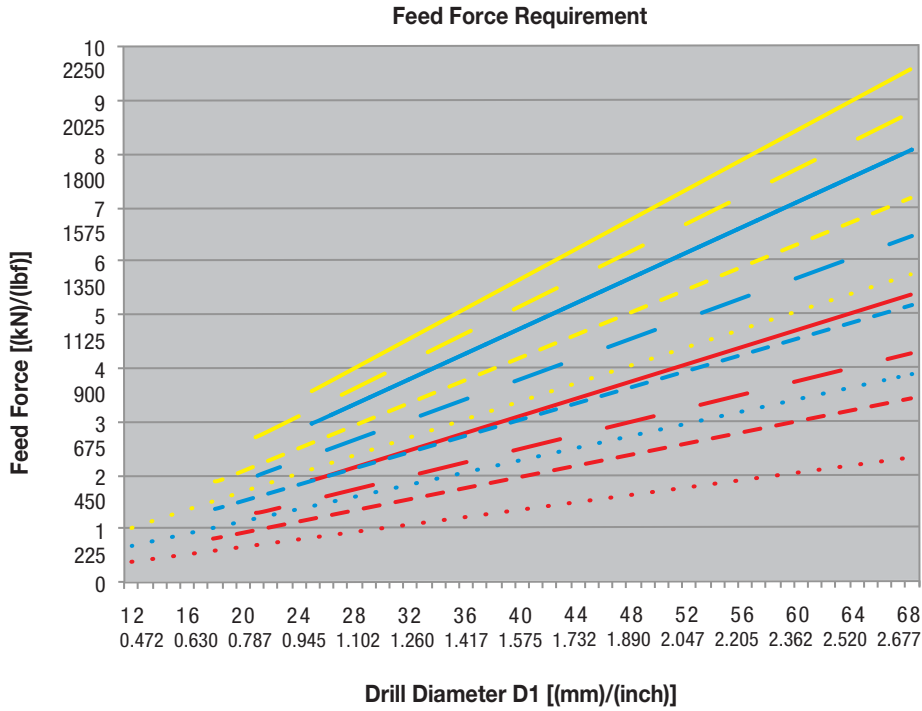

(continued)

Top Cut 4™

New Generation Indexable Drilling System

(continued)

Power Requirement – Steel

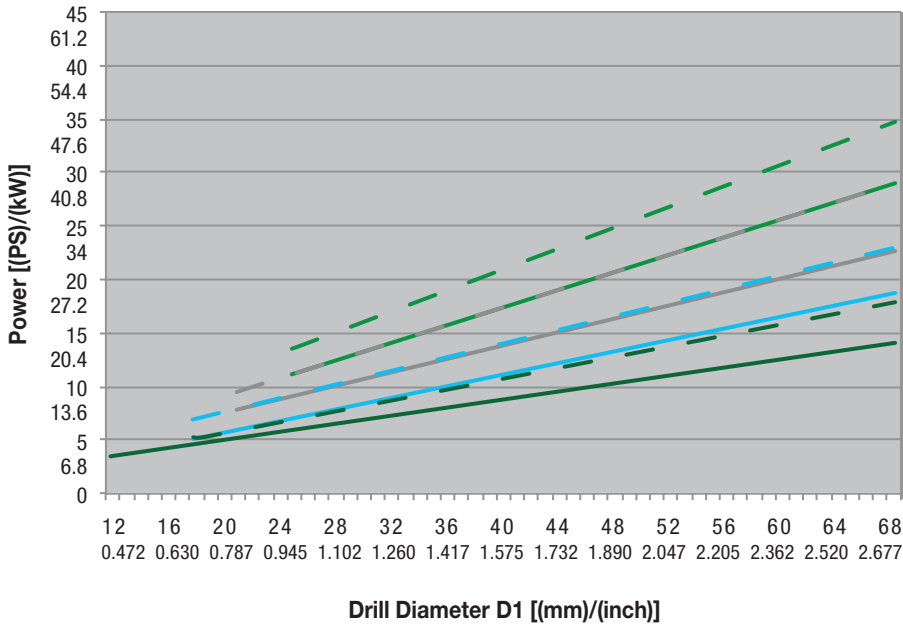

Steel 4140

- f = 0.25 (160 m/min) f = .0098 IPR (525 SFM)
- - f = 0.25 (200 m/min) f = .0098 IPR (656 SFM)
- f = 0.16 (160 m/min) f = .0063 IPR (525 SFM)
- - f = 0.16 (200 m/min) f = .0063 IPR (656 SFM)
- f = 0.12 (160 m/min) f = .0047 IPR (525 SFM)
- - f = 0.12 (200 m/min) f = .0047 IPR (656 SFM)
- f = 0.20 (160 m/min) f = .0079 IPR (525 SFM)
- - f = 0.20 (200 m/min) f = .0079 IPR (656 SFM)

Power Requirement – Stainless Steel

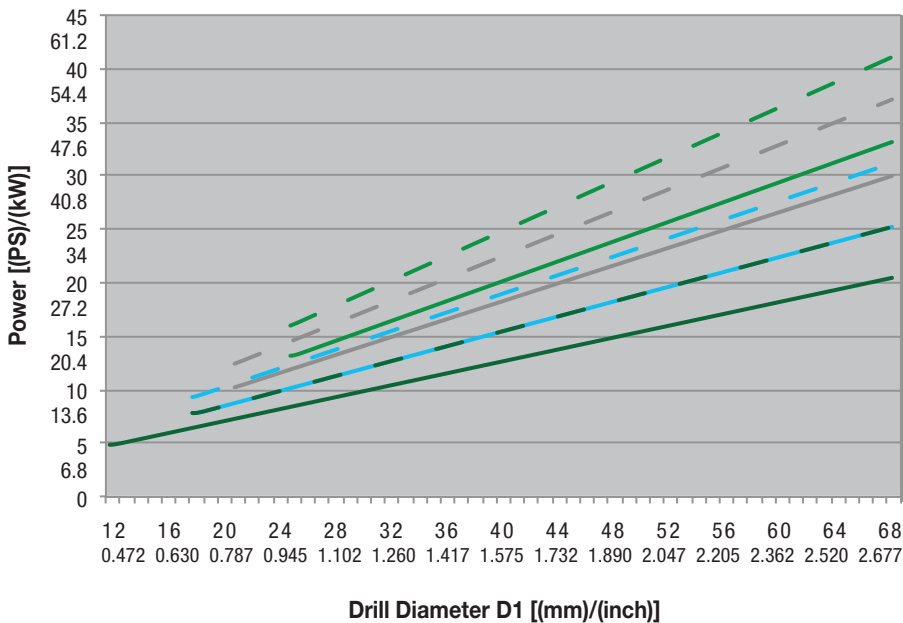

Stainless Steel 304

- f = 0.20 (160 m/min) f = .0079 IPR (525 SFM)
- - f = 0.20 (200 m/min) f = .0079 IPR (656 SFM)
- f = 0.15 (160 m/min) f = .0059 IPR (525 SFM)
- - f = 0.15 (200 m/min) f = .0059 IPR (656 SFM)
- f = 0.12 (160 m/min) f = .0047 IPR (525 SFM)
- - f = 0.12 (200 m/min) f = .0047 IPR (656 SFM)
- f = 0.18 (160 m/min) f = .0071 IPR (525 SFM)
- - f = 0.18 (200 m/min) f = .0071 IPR (656 SFM)

(continued)

New Generation Indexable Drilling System

(continued)

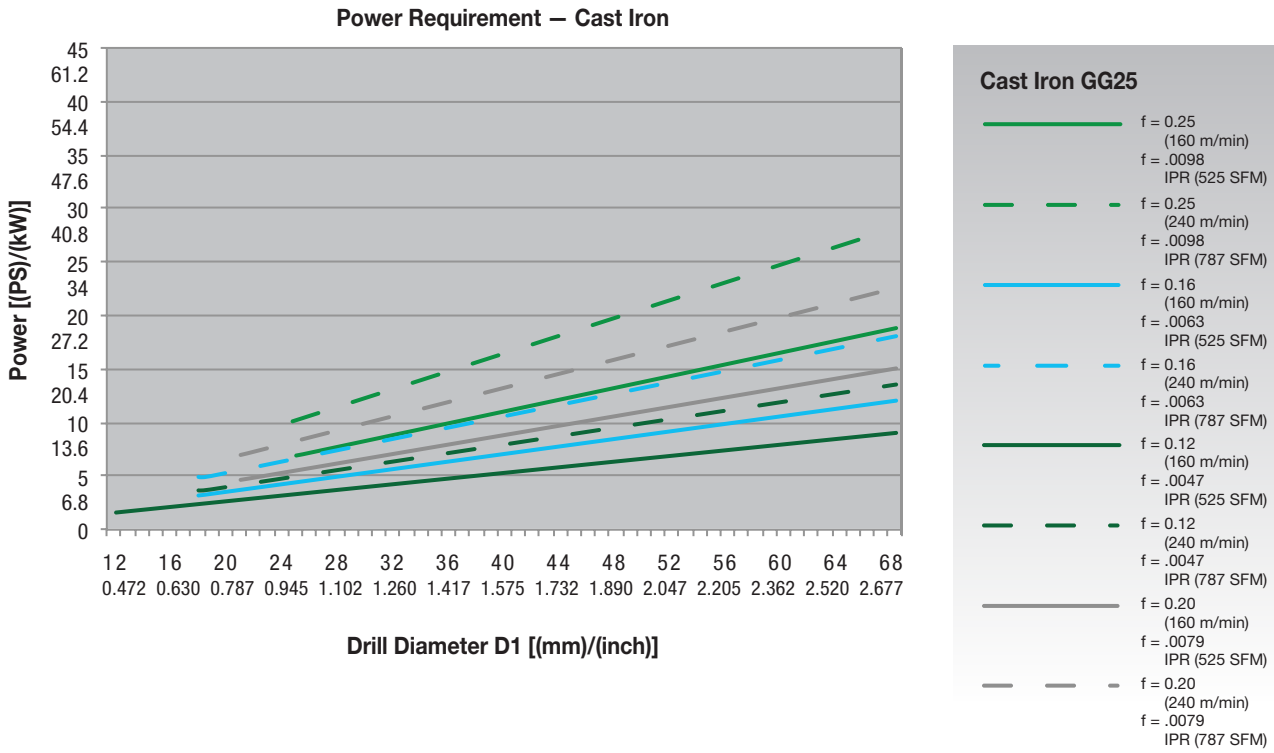

VT-AFT

VT-AFT AERO FASTENER TAPS



HIGH-PERFORMANCE TAPS FOR AEROSPACE FASTENERS

Proprietary TiN CrC/C Coating

For the reduction of galling and prevents built-up edge.

High-Vanadium HSS-E

For greater wear resistance in high-temp alloys.

Proprietary Spiral-Point Geometry

Low cutting force while pushing the chip forward.

Precision-Ground Spiral Geometry

Designed to allow tapping of solution-treated A286, 300 series stainless steel, and titanium.

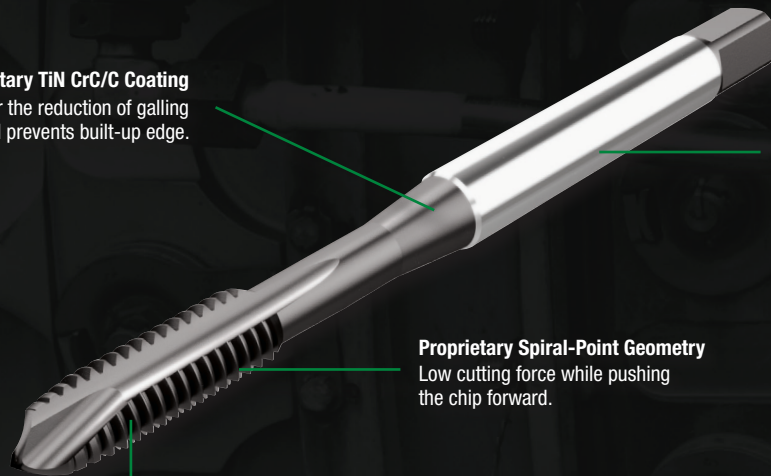

HSS-E Aerospace Fastener Taps



- High vanadium for higher wear resistance.
- Patented geometry for low cutting forces.
- Optimized geometry for a specific application.
- Increased chamfer length to reduce chip load.
- Improved tool life.
- Increased process security.
- Improved productivity.
- Application support.

+76% Increased Number of Holes

Field Test

Application Details	
Tool	VT-AFT
Material	A286
Component	Collar
Operation	Through Hole
Machine	CNC Rigid
Tap Size	10-32 UNF 2B
Toolholder	Rigid
Pre-Hole Diameter	.164"
RPM-WIDIA	900
SFM (Vc m/min)	47 (14)
RPM-Competitor	900
SFM (Vc m/min)	47 (14)
Coolant	External Cutting Oil

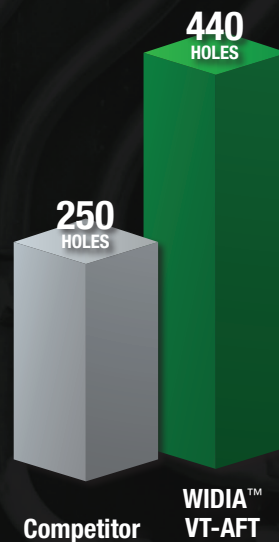

Results: Cost Saving
\$14,682.00 per year
Increased number of
holes by 76%

WIDIA 

widia.com

VT-AFT Aero Fastener Taps

High-Vanadium Spiral-Point HSS-E Taps

WIDIA GTD



▼ VT-AFT • Inch

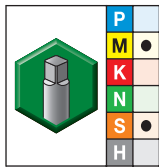

grade WN44EG
TiN+CrC/C

- first choice
- alternate choice

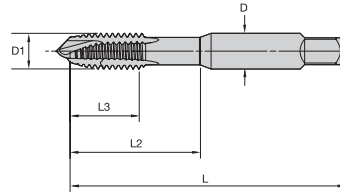

order #	catalog #	D1 size	L	L3	L2	D	number of flutes	pitch diameter limit
6474960	VTAFT5040	4 - 40	1.88	.51	.69	.141	3	H3
6474971	VTAFT5041	4 - 40	1.88	.51	.69	.141	3	H4
6474972	VTAFT5042	4 - 40	1.88	.51	.69	.141	3	H5
6474973	VTAFT5043	4 - 40	1.88	.51	.69	.141	3	H6
6474974	VTAFT5044	4 - 40	1.88	.51	.69	.141	3	H7
6474975	VTAFT5050	4 - 48	1.88	.51	.69	.141	3	H3
6474976	VTAFT5051	4 - 48	1.88	.51	.69	.141	3	H4
6474977	VTAFT5052	4 - 48	1.88	.51	.69	.141	3	H5
6474978	VTAFT5053	4 - 48	1.88	.51	.69	.141	3	H6
6474979	VTAFT5054	4 - 48	1.88	.51	.69	.141	3	H7
6474980	VTAFT5060	6 - 32	2.03	.38	.71	.141	3	H3
6474981	VTAFT5061	6 - 32	2.03	.38	.71	.141	3	H4
6474982	VTAFT5062	6 - 32	2.03	.38	.71	.141	3	H5
6474983	VTAFT5063	6 - 32	2.03	.38	.71	.141	3	H6
6474984	VTAFT5064	6 - 32	2.03	.38	.71	.141	3	H7
6474985	VTAFT5065	6 - 32	2.03	.38	.71	.141	3	H8
6474986	VTAFT5072	6 - 40	2.02	.38	.71	.141	3	H5
6474987	VTAFT5073	6 - 40	2.02	.38	.71	.141	3	H6
6474988	VTAFT5074	6 - 40	2.02	.38	.71	.141	3	H7
6474989	VTAFT5080	8 - 32	2.16	.38	.76	.168	3	H3
6274214	VTAFT5081	8 - 32	2.12	.38	.76	.168	3	H4
6274215	VTAFT5082	8 - 32	2.12	.38	.76	.168	3	H5
6274216	VTAFT5083	8 - 32	2.12	.38	.76	.168	3	H6
6474990	VTAFT5084	8 - 32	2.16	.38	.76	.168	3	H7
6474991	VTAFT5085	8 - 32	2.16	.38	.76	.168	3	H8
6474992	VTAFT5092	8 - 36	2.16	.38	.76	.168	3	H5
6474993	VTAFT5093	8 - 36	2.16	.38	.76	.168	3	H6
6474994	VTAFT5094	8 - 36	2.16	.38	.76	.168	3	H7
6496033	VTAFT5100	10 - 24	2.42	.50	.91	.194	3	H3
6496034	VTAFT5101	10 - 24	2.42	.50	.91	.194	3	H4
6496035	VTAFT5102	10 - 24	2.42	.50	.91	.194	3	H5
6496036	VTAFT5103	10 - 24	2.42	.50	.91	.194	3	H6
6496037	VTAFT5104	10 - 24	2.42	.50	.91	.194	3	H7
6496038	VTAFT5109	10 - 32	2.41	.50	.91	.194	3	H3
6087704	VTAFT5110	10 - 32	2.36	.50	.91	.194	3	H5
6087705	VTAFT5111	10 - 32	2.36	.50	.91	.194	3	H5
6496039	VTAFT5112	10 - 32	2.41	.50	.91	.194	3	H6
6496040	VTAFT5113	10 - 32	2.41	.50	.91	.194	3	H7
6496081	VTAFT5114	10 - 32	2.41	.50	.91	.194	3	H8
6496082	VTAFT5130	1/4 - 20	2.50	.63	1.00	.255	3	H3

(continued)

High-Vanadium Spiral-Point HSS-E Taps

(VT-AFT • Inch — continued)

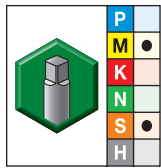

grade WN44EG
TiN+CrC/C

- first choice
- alternate choice

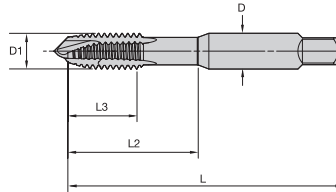

order #	catalog #	D1 size	L	L3	L2	D	number of flutes	pitch diameter limit
6496083	VTAFT5131	1/4 - 20	2.50	.63	1.00	.255	3	H4
6496084	VTAFT5132	1/4 - 20	2.50	.63	1.00	.255	3	H5
6496086	VTAFT5133	1/4 - 20	2.50	.63	1.00	.255	3	H6
6496087	VTAFT5134	1/4 - 20	2.50	.63	1.00	.255	3	H7
6496088	VTAFT5135	1/4 - 20	2.50	.63	1.00	.255	3	H8
6496089	VTAFT5140	1/4 - 28	2.49	.62	1.00	.255	3	H3
6496090	VTAFT5141	1/4 - 28	2.49	.62	1.00	.255	3	H4
6496091	VTAFT5142	1/4 - 28	2.49	.62	1.00	.255	3	H5
6496092	VTAFT5143	1/4 - 28	2.49	.62	1.00	.255	3	H6
6496093	VTAFT5144	1/4 - 28	2.49	.62	1.00	.255	3	H7
6496095	VTAFT5145	1/4 - 28	2.49	.62	1.00	.255	3	H8
6496096	VTAFT5146	1/4 - 28	2.49	.62	1.00	.255	3	H9
6496097	VTAFT5160	5/16 - 24	2.71	.69	1.12	.318	3	H3
6496098	VTAFT5161	5/16 - 24	2.71	.69	1.12	.318	3	H4
6496099	VTAFT5162	5/16 - 24	2.71	.69	1.12	.318	3	H5
6496100	VTAFT5163	5/16 - 24	2.71	.69	1.12	.318	3	H6
6496111	VTAFT5164	5/16 - 24	2.71	.69	1.12	.318	3	H7
6496112	VTAFT5165	5/16 - 24	2.71	.69	1.12	.318	3	H8
6496113	VTAFT5166	5/16 - 24	2.71	.69	1.12	.318	3	H9
6496114	VTAFT5180	3/8 - 24	2.92	.75	1.25	.381	3	H3
6496115	VTAFT5181	3/8 - 24	2.92	.75	1.25	.381	3	H4
6445486	VTAFT5182	3/8 - 24	2.94	.75	1.27	.381	3	H5
6496116	VTAFT5183	3/8 - 24	2.92	.75	1.25	.381	3	H6
6445487	VTAFT5184	3/8 - 24	2.94	.75	1.27	.381	3	H7
6496117	VTAFT5185	3/8 - 24	2.92	.75	1.25	.381	3	H8
6496118	VTAFT5186	3/8 - 24	2.92	.75	1.25	.381	3	H9
6496119	VTAFT5222	1/2 - 20	3.38	.94	1.74	.367	3	H5
6496120	VTAFT5223	1/2 - 20	3.38	.94	1.74	.367	3	H6
6439284	VTAFT5224	1/2 - 20	3.38	.94	1.74	.367	3	H7
6439283	VTAFT5225	1/2 - 20	3.38	.94	1.74	.367	3	H8
6496121	VTAFT5226	1/2 - 20	3.38	.94	1.74	.367	3	H9

Shank Tolerance

D inch	tolerance
0.141-0.635	+0, -.0015
>0.635-1.51	+0, -.0020
>1.51-2.01	+0, -.0030

VT-AFT Aero Fastener Taps

Application Data

WIDIA GTD 

▼ VT-AFT • Inch



Aerospace Fastener Taps VT-AFT

Cutting Speed – Vc
SFM

Range

Material Group		Range		
		min	Starting Value	max
M	1	30	40	50
	2	13	16	23
S	1	20	26	40
	4	13	16	20

Metalworking's Oldest and Most Trusted Brand

WIDIA 

Tap into the Power of the Original

WIDIA-GTD™ represents the powerful combination of speed and precision matched with high performance, consistent quality, and relentless innovation.

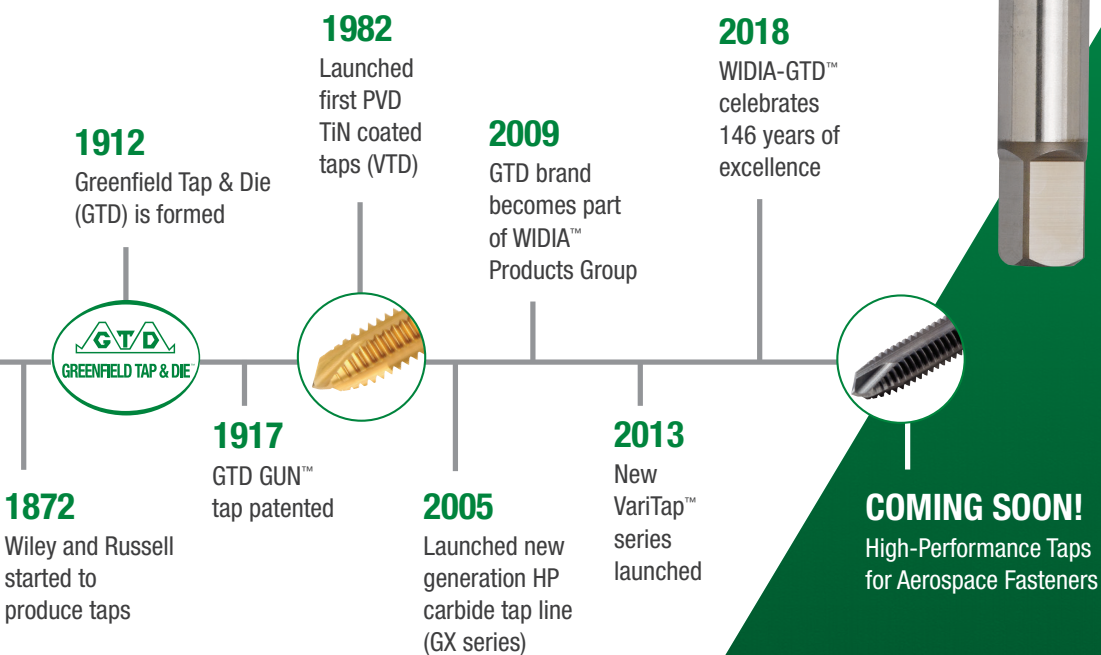

WGC

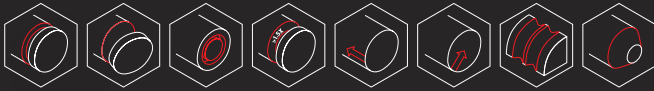

THE MOST VERSATILE TOOL ON THE MARKET IN GROOVING, PROFILING, AND CUT-OFF OPERATIONS

4 BENEFITS IN 1

VERSATILE

GROOVING, PROFILING,
AND CUT-OFF OPERATIONS

SIMPLE

EASY TO SELECT
AND APPLY

STABLE

TRIPLE-V SEATING FOR
SECURE CLAMPING

PRODUCTIVE

LOW CUTTING FORCES IN
THROUGH COOLANT FOR
BETTER CHIP EVACUATION



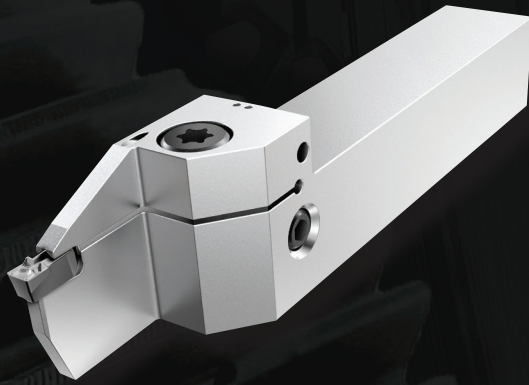

Grooving

First choice for external grooving applications in most workpiece materials.

Through coolant capability and efficient coolant delivery for enhanced productivity.

Available in integral and modular style toolholders.

Groove width: 0.0787–0.394".

Cut-Off

Specially engineered chipbreakers for effective parting/cut-off and deep grooving.

Positive geometry for lower forces.

Secure seating offers greatest stability.

Groove width: 0.055–0.315".

Profiling

Full radius chipbreaker for multi-directional turning and generating complex profiles.

Rigid design ensures smooth surface finish.

Groove width: 0.118–0.315".

WIDIA 

widia.com

WGC

Grooving, Cut-Off, and Profiling

Coolant channel on rake and pocket
Efficient coolant delivery for longer tool life and higher metal removal rates.

Single-ended design
Deeper grooving capability than typical double-ended systems.

Proprietary negative chip geometry
Added chip control in steel, cast, stainless, and hardened materials.

Protective horns
Eliminates chip jamming and protects steel for reduced downtime and wear.

Proprietary V-back seating design
Provides high side-load stability comparable to longer double-ended inserts.

Wide range of insert offering
.055-.394" (1,4-10mm). PVD grades.

Positive back stop
Enables easy indexing.

Strong V-style clamping
High stability for grooving, cut-off, side turning, deep grooving, face grooving, and profiling applications.

Angle between top and bottom V
Creates a pull-in effect, securing the insert tighter in the pocket.

Enhanced body edge design
Improved seating stability.

Industry-leading grade technologies
Proven performance in all materials.

Grooving Precision Molded



P M N S

PT-Positive Rake

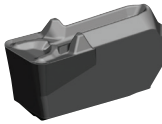

P M K H

PN-Negative Rake

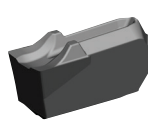

P M N S

F-Fine

Cut-Off Precision Molded

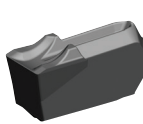

P K

M-Medium

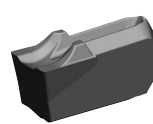

P M

R-Rough

Profiling Precision Molded



P M N S

PR-Full Radius

NOTE: Use the NOVO™ software to select appropriate toolholder and insert.

Our Solution to CPC Reduction

K Cast Iron

Holder: WGC-WG0612M06U08PN WU25PT
Grade: WU10PT
Diameter (ØT): 28mm
No. of Edges: 1 (2 for competition)

Specifications	Competitor	WIDIA WGC
Cutting Diameter	28	28
Cutting Edges	2	1
Grade	P10	WU25PT
Cutting Speed (Vc)	125	125
Spindle Speed (n)	1421	1421
Feed (mm/rev)	0.1	0.1
Cutting Depth (ap)	4	4
Turning Length (l)	17	17
Total Time/Piece	0.12	0.12
Pieces/Edge	100	125
Life/Edge (min)	11.96	14.95
MRR (cm³/min/in³/min)	50	50



WGC Integral Toolholders

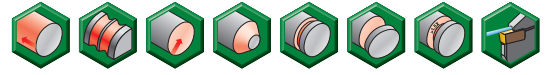

▼ Integral Straight • Inch

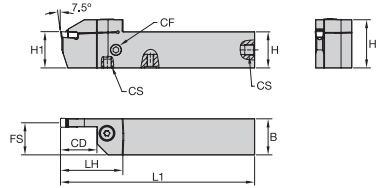

order number	catalog number	SSC	CD	H1	H	B	H2	L1	FS	LH	CF	CS	Torx clamp screw	Torx
right hand														
6461884	WGCSMR120216	2	.63	.750	.750	.750	1.03	4.50	.71	1.22	—	—	MS1160	T20
6461885	WGCSMR160216	2	.63	1.000	1.000	1.000	1.28	6.00	.96	1.22	—	—	MS1160	T20
6461886	WGCSMR120222	2	.87	.750	.750	.750	1.10	4.50	.71	1.50	—	—	MS2091	25 IP
6461887	WGCSMR160226	2	1.02	1.000	1.000	1.000	1.35	6.00	.96	1.65	—	—	MS2091	25 IP
6461922	WGCSMR120316C	3	.63	.750	.750	.750	—	4.50	.69	1.46	M8X1	M8X1	MS1595	T30
6461923	WGCSMR160316C	3	.63	1.000	1.000	1.000	1.35	6.00	.94	1.46	G1/8-28	G1/8-28	MS1595	T30
6461924	WGCSMR120322C	3	.87	.750	.750	.750	1.12	4.50	.69	1.69	M8X1	M8X1	MS1595	T30
6461925	WGCSMR160326C	3	1.02	1.000	1.000	1.000	1.39	6.00	.94	1.85	G1/8-28	G1/8-28	MS1595	T30
6461926	WGCSMR120416C	4	.63	.750	.750	.750	1.10	4.50	.68	1.46	M8X1	M8X1	MS1595	T30
6461927	WGCSMR160416C	4	.63	1.000	1.000	1.000	1.34	6.00	.93	1.46	G1/8-28	G1/8-28	MS1595	T30
6461928	WGCSMR120422C	4	.87	.750	.750	.750	1.10	4.50	.68	1.69	M8X1	M8X1	MS1595	T30
6461929	WGCSMR160426C	4	1.02	1.000	1.000	1.000	1.38	6.00	.93	1.85	G1/8-28	G1/8-28	MS1595	T30
6461930	WGCSMR200426C	4	1.02	1.250	1.250	1.250	1.60	6.00	1.18	1.85	G1/8-28	G1/8-28	MS1970	T30
6461941	WGCSMR200432C	4	1.26	1.250	1.250	1.250	1.70	6.00	1.18	2.09	G1/8-28	G1/8-28	MS1970	T30
6461942	WGCSMR160516C	5	.63	1.000	1.000	1.000	1.40	6.00	.91	1.46	G1/8-28	G1/8-28	MS1970	T30
6461943	WGCSMR160526C	5	1.02	1.000	1.000	1.000	1.40	6.00	.91	1.85	G1/8-28	G1/8-28	MS1970	T30
6461944	WGCSMR200526C	5	1.02	1.250	1.250	1.250	1.60	6.00	1.16	1.85	G1/8-28	G1/8-28	MS1970	T30
6461945	WGCSMR200532C	5	1.26	1.250	1.250	1.250	1.70	6.00	1.16	2.09	G1/8-28	G1/8-28	MS1970	T30
6461947	WGCSMR160616C	6	.63	1.000	1.000	1.000	1.40	6.00	.89	1.46	G1/8-28	G1/8-28	MS1970	T30
6461949	WGCSMR160626C	6	1.02	1.000	1.000	1.000	1.40	6.00	.89	1.85	G1/8-28	G1/8-28	MS1970	T30
6461951	WGCSMR200626C	6	1.02	1.250	1.250	1.250	1.60	6.00	1.14	1.85	G1/8-28	G1/8-28	MS1970	T30
6461953	WGCSMR200632C	6	1.26	1.250	1.250	1.250	1.70	6.00	1.14	2.17	G1/8-28	G1/8-28	MS1490	T45
6461955	WGCSMR240640C	6	1.58	1.500	1.500	1.500	2.00	7.00	1.39	2.48	G1/8-28	G1/8-28	MS1490	T45
6461957	WGCSMR160826C	8	1.02	1.000	1.000	1.000	1.40	6.00	.86	1.93	G1/8-28	G1/8-28	MS1490	T45
6461959	WGCSMR200826C	8	1.02	1.250	1.250	1.250	1.70	6.00	1.11	1.93	G1/8-28	G1/8-28	MS1490	T45
6461961	WGCSMR200832C	8	1.26	1.250	1.250	1.250	1.70	6.00	1.11	2.17	G1/8-28	G1/8-28	MS1490	T45
6461962	WGCSMR240840C	8	1.58	1.500	1.500	1.500	2.00	7.00	1.36	2.48	G1/8-28	G1/8-28	MS1490	T45
6461963	WGCSMR201032C	10	1.26	1.250	1.250	1.250	1.70	6.00	1.08	2.17	G1/8-28	G1/8-28	MS1490	T45
6461964	WGCSMR241040C	10	1.58	1.500	1.500	1.500	2.00	7.00	1.33	2.48	G1/8-28	G1/8-28	MS1490	T45
left hand														
6461888	WGCSML120216	2	.63	.750	.750	.750	—	4.50	.71	1.22	—	—	MS1160	T20
6461889	WGCSML160216	2	.63	1.000	1.000	1.000	1.28	6.00	.96	1.22	—	—	MS1160	T20
6461890	WGCSML120222	2	.87	.750	.750	.750	1.10	4.50	.71	1.50	—	—	MS2091	25 IP
6461921	WGCSML160226	2	1.02	1.000	1.000	1.000	1.35	6.00	.96	1.65	—	—	MS2091	25 IP
6461965	WGCSML120316C	3	.63	.750	.750	.750	1.10	4.50	.69	1.46	M8X1	M8X1	MS1595	T30
6461966	WGCSML160316C	3	.63	1.000	1.000	1.000	1.35	6.00	.94	1.46	G1/8-28	G1/8-28	MS1595	T30
6461967	WGCSML120322C	3	.87	.750	.750	.750	1.12	4.50	.69	1.69	M8X1	M8X1	MS1595	T30
6461968	WGCSML160326C	3	1.02	1.000	1.000	1.000	1.39	6.00	.94	1.85	G1/8-28	G1/8-28	MS1595	T30
6461969	WGCSML120416C	4	.63	.750	.750	.750	1.10	4.50	.68	1.46	M8X1	M8X1	MS1595	T30

(continued)

(Integral Straight • Inch — continued)

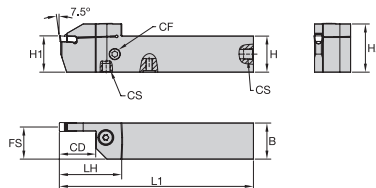
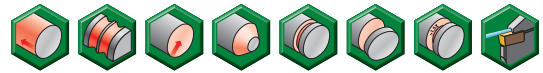

order number	catalog number	SSC	CD	H1	H	B	H2	L1	FS	LH	CF	CS	Torx clamp screw	Torx
6461970	WGCSML160416C	4	.63	1.000	1.000	1.000	1.34	6.00	.93	1.46	G1/8-28	G1/8-28	MS1595	T30
6461971	WGCSML120422C	4	.87	.750	.750	.750	1.10	4.50	.68	1.69	M8X1	M8X1	MS1595	T30
6461972	WGCSML160426C	4	1.02	1.000	1.000	1.000	1.38	6.00	.93	1.85	G1/8-28	G1/8-28	MS1595	T30
6461973	WGCSML200426C	4	1.02	1.250	1.250	1.250	1.60	6.00	1.18	1.85	G1/8-28	G1/8-28	MS1970	T30
6461974	WGCSML200432C	4	1.26	1.250	1.250	1.250	1.70	6.00	1.18	2.09	G1/8-28	G1/8-28	MS1970	T30
6461975	WGCSML160516C	5	.63	1.000	1.000	1.000	1.40	6.00	.91	1.46	G1/8-28	G1/8-28	MS1970	T30
6461976	WGCSML160526C	5	1.02	1.000	1.000	1.000	1.10	6.00	.91	1.85	G1/8-28	G1/8-28	MS1970	T30
6461977	WGCSML200526C	5	1.02	1.250	1.250	1.250	1.60	6.00	1.16	1.85	G1/8-28	G1/8-28	MS1970	T30
6461978	WGCSML200532C	5	1.26	1.250	1.250	1.250	1.70	6.00	1.16	2.09	G1/8-28	G1/8-28	MS1970	T30
6461979	WGCSML160616C	6	.63	1.000	1.000	1.000	1.40	6.00	.89	1.46	G1/8-28	G1/8-28	MS1970	T30
6461980	WGCSML160626C	6	1.02	1.000	1.000	1.000	1.40	6.00	.89	1.85	G1/8-28	G1/8-28	MS1970	T30
6461991	WGCSML200626C	6	1.02	1.250	1.250	1.250	1.60	6.00	1.14	1.85	G1/8-28	G1/8-28	MS1970	T30
6461992	WGCSML200632C	6	1.26	1.250	1.250	1.250	1.70	6.00	1.14	2.17	G1/8-28	G1/8-28	MS1490	T45
6461993	WGCSML240640C	6	1.58	1.500	1.500	1.500	2.00	7.00	1.39	2.48	G1/8-28	G1/8-28	MS1490	T45
6461994	WGCSML160826C	8	1.02	1.000	1.000	1.000	1.40	6.00	.86	1.93	G1/8-28	G1/8-28	MS1490	T45
6461995	WGCSML200826C	8	1.02	1.250	1.250	1.250	1.70	6.00	1.11	1.93	G1/8-28	G1/8-28	MS1490	T45
6461996	WGCSML200832C	8	1.26	1.250	1.250	1.250	1.70	6.00	1.11	2.17	G1/8-28	G1/8-28	MS1490	T45
6461997	WGCSML240840C	8	1.58	1.500	1.500	1.500	2.00	7.00	1.36	2.48	G1/8-28	G1/8-28	MS1490	T45
6461998	WGCSML201032C	10	1.26	1.250	1.250	1.250	1.70	6.00	1.08	2.17	G1/8-28	G1/8-28	MS1490	T45
6461999	WGCSML241040C	10	1.58	1.500	1.500	1.500	2.00	7.00	1.33	2.48	G1/8-28	G1/8-28	MS1490	T45

NOTE: SSC = Pocket Seat Reference. To correspond with the SSC on the insert.

WGC Modular Toolholders

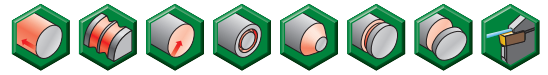

▼ WGCMS-C • Inch

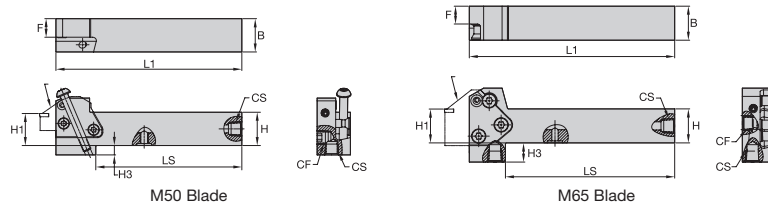

order number	catalog number	H	H1	B	L1	LS	F	CS	CF	H3	blade size	blade screw	Torx	clamp screw	Torx
right hand															
6499230	WGCMSR1650C	1.00	1.00	1.00	5.5	4.33	.56	G 1/8-28	G 1/8-28	.25	50	—	T25	—	T25
6499271	WGCMSR1665C	1.00	1.00	1.00	6.0	4.90	.53	G 1/8-28	G 1/8-28	—	65	MS1163	T30	—	—
6499272	WGCMSR2050C	1.25	1.25	1.25	5.5	4.52	.81	G 1/8-28	G 1/8-28	—	50	MS1162	T25	MS2002	T25
6499273	WGCMSR2065C	1.25	1.25	1.25	6.0	4.90	.78	G 1/8-28	G 1/8-28	—	65	MS1163	T30	—	—
6499274	WGCMSR2450C	1.50	1.50	1.50	5.5	4.52	1.06	G 1/8-28	G 1/8-28	—	50	MS1162	T25	MS2002	T25
6499275	WGCMSR2465C	1.50	1.50	1.50	7.0	5.90	1.03	G 1/8-28	G 1/8-28	—	65	MS1163	T30	—	—
left hand															
6499276	WGCMSL1650C	1.00	1.00	1.00	5.5	4.33	.56	G 1/8-28	G 1/8-28	.25	50	—	T25	—	T25
6499277	WGCMSL1665C	1.00	1.00	1.00	6.0	4.90	.53	G 1/8-28	G 1/8-28	—	65	MS1163	T30	—	—
6499278	WGCMSL2050C	1.25	1.25	1.25	5.5	4.52	.81	G 1/8-28	G 1/8-28	—	50	MS1162	T25	MS2002	T25
6499279	WGCMSL2065C	1.25	1.25	1.25	6.0	4.90	.78	G 1/8-28	G 1/8-28	—	65	MS1163	T30	—	—
6499280	WGCMSL2450C	1.50	1.50	1.50	5.5	4.52	1.06	G 1/8-28	G 1/8-28	—	50	MS1162	T25	MS2002	T25
6499281	WGCMSL2465C	1.50	1.50	1.50	7.0	5.90	1.03	G 1/8-28	G 1/8-28	—	65	MS1163	T30	—	—

NOTE: WGCMS.: Right-hand holder uses right-hand blades.
 WGCME.: Right-hand holder uses left-hand blades.
 M50 blade and clamp screw torque equals 71–88 in. lbs. (8–10 Nm).
 M65 blade and clamp screw torque equals 159–177 in. lbs. (18–20 Nm).

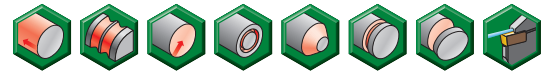

▼ WGCME-C • Inch

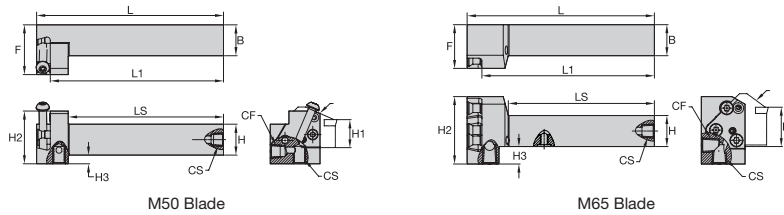

order number	catalog number	B	H	H1	L	L1	LS	F	CS	CF	H2	H3	blade size	blade screw	Torx	clamp screw	Torx
right hand																	
6498941	WGCMER1650C	1.00	1.00	1.00	6.0	5.5	4.96	1.57	G 1/8-28	G 1/8-28	1.67	.25	50	—	T25	—	T25
6498942	WGCMER1665C	1.00	1.00	1.00	6.0	5.5	4.70	1.38	G 1/8-28	G 1/8-28	2.09	.50	65	MS1163	T30	—	—
6498943	WGCMER2050C	1.25	1.25	1.25	6.0	5.5	4.96	1.57	G 1/8-28	G 1/8-28	1.67	—	50	—	T25	—	T25
6498944	WGCMER2065C	1.25	1.25	1.25	6.0	5.5	4.70	1.38	G 1/8-28	G 1/8-28	2.09	.25	65	MS1163	T30	—	—
6498945	WGCMER2450C	1.50	1.50	1.50	6.0	5.5	4.96	1.57	G 1/8-28	G 1/8-28	1.92	—	50	MS1162	T25	MS2002	T25
6498946	WGCMER2465C	1.50	1.50	1.50	7.0	6.5	5.70	1.49	G 1/8-28	G 1/8-28	2.09	—	65	MS1163	T30	—	—
left hand																	
6498947	WGCME1650C	1.00	1.00	1.00	6.0	5.5	4.96	1.57	G 1/8-28	G 1/8-28	1.67	.25	50	—	T25	—	T25
6498948	WGCME1665C	1.00	1.00	1.00	6.0	5.5	4.70	1.38	G 1/8-28	G 1/8-28	2.09	.50	65	MS1163	T30	—	—
6498949	WGCME12050C	1.25	1.25	1.25	6.0	5.5	4.96	1.57	G 1/8-28	G 1/8-28	1.67	—	50	—	T25	—	T25
6498950	WGCME12065C	1.25	1.25	1.25	6.0	5.5	4.70	1.38	G 1/8-28	G 1/8-28	2.09	.25	65	MS1163	T30	—	—
6498951	WGCME12450C	1.50	1.50	1.50	6.0	5.5	4.96	1.57	G 1/8-28	G 1/8-28	1.92	—	50	MS1162	T25	MS2002	T25
6498952	WGCME12465C	1.50	1.50	1.50	7.0	6.5	5.70	1.49	G 1/8-28	G 1/8-28	2.09	—	65	MS1163	T30	—	—

NOTE: WGCMS.: Right-hand holder uses right-hand blades.
 WGCME.: Right-hand holder uses left-hand blades.
 M50 blade and clamp screw torque equals 71–88 in. lbs. (8–10 Nm).
 M65 blade and clamp screw torque equals 159–177 in. lbs. (18–20 Nm).

WGC Modular Blades

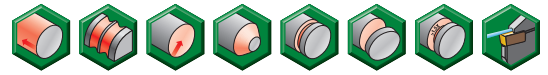

▼ Modular Straight Blade with Coolant

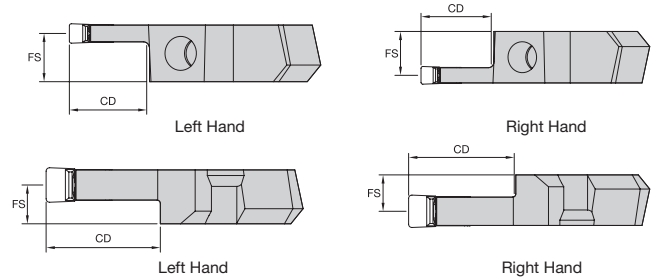

order number	catalog number	SSC	CD	FS	blade size
right hand					
6498457	WGCM50R1F12M	1F	12,0	11,00	50
6498458	WGCM50R0212M	2	12,0	10,88	50
6498459	WGCM50R0216M	2	16,0	10,88	50
6498460	WGCM50R0312MC	3	12,0	10,43	50
6498861	WGCM50R0322MC	3	22,0	10,43	50
6498862	WGCM50R0412MC	4	12,0	9,93	50
6498863	WGCM50R0422MC	4	22,0	9,93	50
6498864	WGCM50R0432MC	4	32,0	9,93	50
6498865	WGCM50R0512MC	5	12,0	9,43	50
6498866	WGCM50R0516MC	5	16,0	9,43	50
6498867	WGCM50R0526MC	5	26,0	9,43	50
6498868	WGCM50R0532MC	5	32,0	9,43	50
6498869	WGCM65R0616MC	6	16,0	9,88	65
6498870	WGCM65R0626MC	6	26,0	9,88	65
6498881	WGCM65R0632MC	6	32,0	9,88	65
6498882	WGCM65R0816MC	8	16,0	9,00	65
6498883	WGCM65R0826MC	8	26,0	9,00	65
left hand					
6498884	WGCM50L1F12M	1F	12,0	11,00	50
6498885	WGCM50L0212M	2	12,0	10,88	50
6498886	WGCM50L0216M	2	16,0	10,88	50
6498887	WGCM50L0312MC	3	12,0	10,43	50
6498888	WGCM50L0322MC	3	22,0	10,43	50
6498889	WGCM50L0412MC	4	12,0	9,93	50
6498890	WGCM50L0422MC	4	22,0	9,93	50
6498891	WGCM50L0432MC	4	32,0	9,93	50
6498892	WGCM50L0512MC	5	12,0	9,43	50
6498893	WGCM50L0516MC	5	16,0	9,43	50
6498894	WGCM50L0526MC	5	26,0	9,43	50
6498895	WGCM50L0532MC	5	32,0	9,43	50
6498896	WGCM65L0616MC	6	16,0	9,88	65
6498897	WGCM65L0626MC	6	26,0	9,88	65
6498898	WGCM65L0632MC	6	32,0	9,88	65
6498899	WGCM65L0816MC	8	16,0	9,00	65
6498900	WGCM65L0826MC	8	26,0	9,00	65

NOTE: SSC = Pocket Seat Reference. To correspond with the SSC on the insert.
Through the pocket coolant available in seat sizes 3 and higher.

▼ Blade Holders • Inch

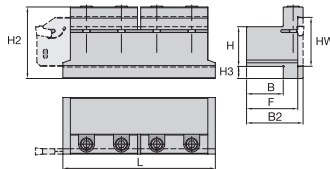

order number	catalog number	HW	H	B	F	H2	B2	H3	L	cap screw	wrench
2968845	32251221200	1.024	.750	.750	1.161	1.57	1.34	.32	3.39	125.625	12148041300
2968846	32251221600	1.260	1.000	1.000	1.417	1.89	1.63	.30	4.33	125.630	12148041300
2968847	32251222000	1.260	1.250	1.250	1.673	1.97	1.89	.13	4.33	125.630	12148041300

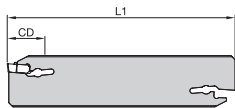

Straight

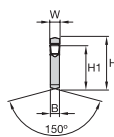

Reinforced

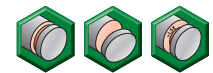
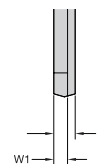
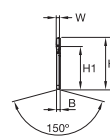
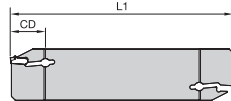

▼ Double-Ended Cut-Off Blade

order number	catalog number	SSC	H	W	W1	H1	L1	B	CD	assembly wrench
neutral hand										
6498987	WGCBSN19G1B14	1B	19	1,4	1,15	15,5	90	1,80	14	SCW5E
6498988	WGCBSN26J1B15	1B	26	1,4	1,15	21,5	110	1,80	15	SCW5E
6498989	WGCBSN19G1F16	1F	19	1,6	1,30	15,5	90	1,80	16	SCW5E
6498990	WGCBSN26J1F17	1F	26	1,6	1,30	21,5	110	1,80	17	SCW5E
6499211	WGCBSN19G0220	2	19	2,0	—	15,5	90	1,65	—	SCW5E
6499212	WGCBSN26J0230	2	26	2,0	—	21,5	110	1,65	—	SCW5E
6499213	WGCBSN32M0250	2	32	2,0	—	25,1	150	1,65	—	SCW5E
6499215	WGCBSN32M0350	3	32	3,0	—	25,1	150	2,40	—	SCW5E
6499214	WGCBSN26J0340	3	36	3,0	—	21,5	110	2,40	—	SCW5E
6499216	WGCBSN26J0440	4	26	4,0	—	21,5	110	3,40	—	SCW5E
6499217	WGCBSN32M0450	4	32	4,0	—	25,1	150	3,40	—	SCW5E
6499218	WGCBSN32M0560	5	32	5,0	—	25,1	150	4,40	—	SCW5E
6499219	WGCBSN32M0660	6	32	6,0	—	25,1	150	5,40	—	SCW8E
6499220	WGCBSN32M0860	8	32	8,0	—	25,1	150	7,00	—	SCW8E
6499221	WGCBSN52X08120	8	53	8,0	—	45,3	260	7,00	—	SCW8E

NOTE: SSC = Pocket Seat Reference. To correspond with the SSC on the insert.

▼ Spare Parts

screw catalog number	screw order number	torque		thread	socket	wrench catalog number	wrench order number
		Nm	in. lbs.				
MS1160	1099645	7	62	M5	T20	KT20	1022703
MS1162	1127019	9	80	M6	T25	KT25	1022725
MS1163	1124104	18	159	M8	T30	KT30L	1099676
MS1273	1020977	4	35.4	M4	T15	KT15	1022701
MS1490	2263299	17	151	M8	T45	KT45	1018227
MS1595	1094300	12	106	M6	T30	KT30	1099676
MS1970	1106668	12	106	M6	T30	KT30	1099676
MS2002	1621087	9	80	M6	T25	KT25	1022725
MS2091	1931147	9	80	M5	25IP	K25IP	2050113

WGC Cut-Off Inserts

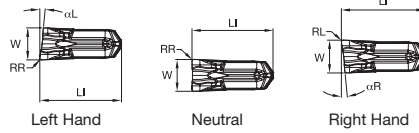

P	Blue	●
M	Yellow	●
K	Red	○
N	Green	○
S	Orange	●
H	Grey	

● first choice
○ alternate choice

▼ F Precision Molded • Metric

catalog number	SSC	W		W tol ±		LI		αR	αL	RR		RL		WU25PT
		mm	in	mm	in	mm	in			mm	in	mm	in	
WC014M1BL06F01	1B	1,40	.055	0,050	.002	9,00	.355	—	6	0,15	.006	—	—	6470544
WC014M1BN00F01	1B	1,40	.055	0,050	.002	9,00	.355	—	—	0,15	.006	0,15	.006	6470545
WC014M1BR06F01	1B	1,40	.055	0,050	.002	9,02	.355	6	—	—	—	0,15	.006	6470546
WC020M02L06F02	2	2,00	.079	0,050	.002	9,00	.353	—	6	0,20	.008	—	—	6470547
WC020M02N00F02	2	2,00	.079	0,050	.002	9,00	.353	—	—	0,20	.008	0,20	.008	6470548
WC020M02R06F02	2	2,00	.079	0,050	.002	9,00	.353	6	—	—	—	0,20	.008	6470549
WC030M03L06F02	3	3,00	.118	0,075	.003	9,60	.378	—	6	0,20	.008	—	—	6470550
WC030M03N00F02	3	3,00	.118	0,075	.003	9,60	.378	—	—	0,20	.008	0,20	.008	6470561
WC030M03R06F02	3	3,00	.118	0,075	.003	9,60	.378	6	—	—	—	—	—	6470562
WC040M04L06F02	4	4,00	.157	0,075	.003	10,19	.401	—	6	0,20	.008	—	—	6470563
WC040M04N00F02	4	4,00	.157	0,075	.003	10,19	.401	—	—	0,20	.008	0,20	.008	6470564
WC040M04R06F02	4	4,00	.157	0,075	.003	10,19	.401	6	—	—	—	0,20	.008	6470565
WC050M05N00F03	5	5,00	.197	0,075	.003	12,24	.482	—	—	0,30	.012	0,30	.012	6470566

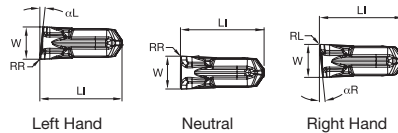

▼ M Precision Molded • Metric

catalog number	SSC	W		W tol ±		LI		αR	αL	RR		RL		WU25PT
		mm	in	mm	in	mm	in			mm	in	mm	in	
WC014M1BL06M02	1B	1,40	.055	0,050	.002	9,02	.355	—	6	—	—	0,20	.008	6461828
WC014M1BN00M01	1B	1,40	.055	0,050	.002	9,01	.355	—	—	0,15	.006	0,15	.006	6461829
WC014M1BR06M02	1B	1,40	.055	0,050	.002	9,02	.355	6	—	—	—	0,20	.008	6461830
WC020M02L06M02	2	2,00	.079	0,050	.002	8,97	.353	—	6	—	—	0,20	.008	6461861
WC020M02N00M02	2	2,00	.079	0,050	.002	8,98	.353	—	—	0,20	.008	0,20	.008	6461862
WC020M02R06M02	2	2,00	.079	0,050	.002	9,00	.353	6	—	—	—	0,20	.009	6461863
WC030M03L06M02	3	3,00	.118	0,075	.003	9,61	.378	—	6	—	—	0,20	.008	6461864
WC030M03N00M02	3	3,00	.118	0,075	.003	9,60	.378	—	—	0,20	.008	0,20	.008	6461865
WC030M03R06M02	3	3,00	.118	0,075	.003	9,61	.378	6	—	—	—	0,20	.008	6461866
WC040M04L06M02	4	4,00	.157	0,075	.003	10,19	.401	—	6	0,20	.008	—	—	6461867
WC040M04N00M02	4	4,00	.157	0,075	.003	10,20	.402	—	—	0,20	.008	0,20	.008	6461868
WC040M04R06M02	4	4,00	.158	0,050	.002	10,20	.401	6	—	—	—	0,20	.008	6461869
WC050M05N00M03	5	5,00	.197	0,075	.003	12,25	.482	—	—	0,30	.012	0,30	.012	6461870
WC060M06N00M03	6	6,00	.236	0,075	.003	14,59	.574	—	—	0,30	.012	0,30	.012	6461881
WC080M08N00M04	8	8,00	.315	0,075	.003	17,46	.688	—	—	0,40	.016	0,40	.016	6461882

NOTE: SSC = Pocket Seat Reference. To correspond with the SSC on the toolholder.

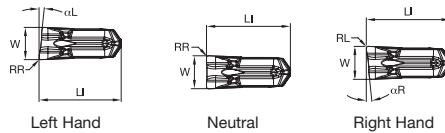

● first choice
○ alternate choice

P	●
M	●
K	○
N	○
S	●
H	

▼ R Precision Molded • Metric

catalog number	SSC	W		W tol ±		LI		RR		RL		WU25PT		
		mm	in	mm	in	mm	in	mm	in	mm	in			
WC020M02L06R02	2	2,00	.079	0,050	.002	8,97	.353	—	6	0,20	.008	—	6470426	
WC020M02N00R02	2	2,00	.079	0,050	.002	8,98	.353	—	—	0,20	.008	0,20	.008	6470427
WC020M02R06R02	2	2,00	.079	0,050	.002	8,97	.353	6	—	—	—	0,20	.008	6470428
WC030M03L06R02	3	3,00	.118	0,075	.003	9,61	.378	—	6	0,20	.008	—	—	6470429
WC030M03N00R02	3	3,00	.118	0,075	.003	9,60	.378	—	—	0,20	.008	0,20	.008	6470430
WC030M03R06R02	3	3,00	.118	0,075	.003	9,61	.378	6	—	—	—	0,20	.008	6470461
WC040M04N00R02	4	4,00	.158	0,075	.003	10,20	.402	—	—	0,20	.008	0,20	.008	6470462
WC050M05N00R03	5	5,00	.197	0,075	.003	12,25	.482	—	—	0,30	.012	0,30	.012	6470463
WC060M06N00R03	6	6,00	.236	0,075	.003	14,59	.574	—	—	0,30	.012	0,30	.012	6470464
WC080M08N00R04	8	8,00	.315	0,075	.003	17,46	.687	—	—	0,40	.016	0,40	.016	6470465

NOTE: SSC = Pocket Seat Reference. To correspond with the SSC on the toolholder.

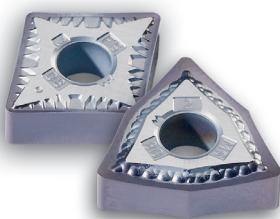

P M K N S

WU25PT™

Advanced Universal Grade with Hard PVD AlTiN Coating and Fine-Grain Substrate

This new and improved coating improves edge stability with wide range speed and feed capabilities.

The WU25PT grade is ideal for general machining of most steels, stainless steels, high-temp alloys, titanium, irons, and non-ferrous materials in a wide range of speeds and feeds with improved edge toughness for interrupted cuts and high feed rates.

For more information, visit widia.com.

WGC Grooving Inserts

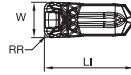

● first choice
○ alternate choice

P	●
M	●
K	○
N	○
S	●
H	

▼ PT Precision Molded • Metric

catalog number	SSC	W		W tol ±		RR		LI		WU25PT
		mm	in	mm	in	mm	in	mm	in	
WG0212M02U02PT	2	2,13	.084	0,050	.002	0,20	.008	8,97	.353	6461734
WG0251M02U02PT	2	2,51	.099	0,050	.002	0,20	.008	8,97	.353	6461735
WG0312M03U02PT	3	3,13	.123	0,075	.003	0,20	.008	9,60	.378	6461736
WG0312M03U04PT	3	3,13	.123	0,075	.003	0,40	.016	9,60	.378	6461737
WG0412M04U04PT	4	4,13	.162	0,075	.003	0,40	.016	10,19	.401	6461738
WG0412M04U08PT	4	4,13	.162	0,075	.003	0,80	.031	10,19	.401	6461739
WG0512M05U04PT	5	5,13	.202	0,075	.003	0,40	.016	12,25	.482	6461740
WG0512M05U08PT	5	5,13	.202	0,075	.003	0,80	.032	12,25	.482	6461821
WG0612M06U04PT	6	6,13	.241	0,075	.003	0,40	.016	14,59	.575	6461822
WG0612M06U08PT	6	6,13	.241	0,075	.003	0,80	.032	14,59	.574	6461823
WG0712M06U08PT	6	7,13	.281	0,075	.003	0,80	.032	14,59	.574	6461824
WG0812M08U08PT	8	8,13	.320	0,075	.003	0,80	.032	17,45	.687	6461825
WG0812M08U12PT	8	8,13	.320	0,075	.003	1,20	.046	17,45	.687	6461826
WG1012M10U12PT	10	10,13	.399	0,075	.003	1,20	.047	20,75	.817	6461827

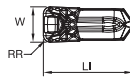

▼ PT Precision Molded • Inch

catalog number	SSC	W		W tol ±		RR		LI		WU25PT
		mm	in	mm	in	mm	in	mm	in	
WG130I03U1PT	3	3,30	.130	0,075	.003	0,40	.016	9,60	.378	6470487
WG130I03U05PT	3	3,30	.130	0,075	.003	0,20	.008	9,60	.378	6470486
WG192I04U1PT	4	4,88	.192	0,075	.003	0,40	.016	10,19	.401	6470488
WG192I04U2PT	4	4,88	.192	0,075	.003	0,78	.031	10,19	.401	6470489
WG255I06U1PT	6	6,48	.255	0,075	.003	0,40	.016	14,58	.574	6470490
WG255I06U2PT	6	6,48	.255	0,075	.003	0,80	.031	14,58	.574	6470541
WG317I08U3PT	8	8,05	.317	0,075	.003	1,19	.047	17,46	.687	6470542
WG380I10U3PT	10	9,65	.380	0,075	.003	1,19	.047	20,75	.817	6470543

NOTE: SSC = Pocket Seat Reference. To correspond with the SSC on the toolholder.

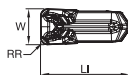

● first choice
○ alternate choice

P	●
M	●
K	○
N	○
S	●
H	

▼ PN Precision Molded • Metric

catalog number	SSC	W		W tol ±		RR		LI		WU25PT
		mm	in	mm	in	mm	in	mm	in	
WG0212M02U02PN	2	2,13	.084	0,050	.002	0,20	.008	8,97	.353	6470850
WG0251M02U02PN	2	2,51	.099	0,050	.002	0,20	.008	8,97	.353	6471041
WG0312M03U02PN	3	3,13	.123	0,075	.003	0,20	.008	9,60	.378	6471042
WG0312M03U04PN	3	3,13	.123	0,075	.003	0,40	.016	9,60	.378	6471043
WG0412M04U04PN	4	4,13	.162	0,075	.003	0,40	.016	10,20	.401	6471044
WG0412M04U08PN	4	4,13	.162	0,075	.003	0,80	.031	10,20	.401	6471045
WG0512M05U04PN	5	5,13	.202	0,075	.003	0,40	.016	12,24	.482	6471046
WG0512M05U08PN	5	5,13	.202	0,075	.003	0,80	.031	12,24	.482	6471047
WG0612M06U04PN	6	6,13	.241	0,075	.003	0,40	.016	14,59	.575	6471048
WG0612M06U08PN	6	6,13	.241	0,075	.003	0,80	.031	14,59	.574	6471049
WG0812M08U08PN	8	8,13	.320	0,075	.003	0,80	.031	17,46	.687	6471050
WG0812M08U12PN	8	8,13	.320	0,075	.003	1,20	.047	17,46	.687	6471062
WG1012M10U12PN	10	10,13	.399	0,075	.003	1,20	.047	20,75	.817	6471064

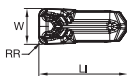

▼ PN Precision Molded • Inch

catalog number	SSC	W		W tol ±		RR		LI		WU25PT
		mm	in	mm	in	mm	in	mm	in	
WG125I03U1PN	3	3,18	.125	0,075	.003	0,40	.016	9,60	.378	6470834
WG125I03U05PN	3	3,18	.125	0,075	.003	0,20	.008	9,60	.378	6470833
WG130I03U1PN	3	3,30	.130	0,075	.003	0,40	.016	9,60	.378	6470836
WG130I03U05PN	3	3,30	.130	0,075	.003	0,20	.008	9,60	.378	6470835
WG187I04U1PN	4	4,75	.187	0,075	.003	0,40	.016	10,19	.401	6470837
WG187I04U2PN	4	4,75	.187	0,075	.003	0,80	.032	10,20	.401	6470838
WG192I04U1PN	4	4,88	.192	0,075	.003	0,40	.016	10,20	.401	6470839
WG192I04U2PN	4	4,88	.192	0,075	.003	0,80	.031	10,20	.401	6470840
WG250I06U1PN	6	6,35	.250	0,075	.003	0,40	.016	14,58	.574	6470841
WG250I06U2PN	6	6,35	.250	0,075	.003	0,80	.032	14,58	.574	6470842
WG255I06U1PN	6	6,48	.255	0,075	.003	0,40	.016	14,58	.574	6470843
WG255I06U2PN	6	6,48	.255	0,075	.003	0,80	.031	14,58	.574	6470844
WG312I08U3PN	8	7,93	.312	0,075	.003	1,20	.047	17,46	.687	6470845
WG317I08U3PN	8	8,05	.317	0,075	.003	1,19	.047	17,46	.687	6470846
WG375I10U3PN	10	9,53	.375	0,075	.003	1,20	.047	20,75	.817	6470847
WG380I10U3PN	10	9,65	.380	0,075	.003	1,20	.047	20,70	.815	6470848

NOTE: SSC = Pocket Seat Reference. To correspond with the SSC on the toolholder.

WGC Grooving Inserts

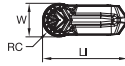

● first choice
○ alternate choice

P	●
M	●
K	○
N	○
S	●
H	

▼ PR Full Radius Precision Ground • Metric

catalog number	SSC	W		W tol ±		RC		LI		WU25PT
		mm	in	mm	in	mm	in	mm	in	
WR0200M02P00PC	2	2,00	.079	0,025	.001	1,00	.039	8,91	.351	6470467
WR0300M03P00PC	3	3,00	.118	0,025	.001	1,50	.059	9,54	.376	6470468
WR0400M04P00PC	4	4,00	.158	0,025	.001	2,00	.079	10,13	.399	6470469
WR0500M05P00PC	5	5,00	.197	0,025	.001	2,50	.098	12,18	.480	6470470
WR0600M06P00PC	6	6,00	.236	0,025	.001	3,00	.118	14,52	.572	6470481
WR0800M08P00PC	8	8,00	.315	0,025	.001	4,00	.158	17,41	.685	6470482

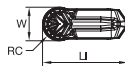

▼ PR Full Radius Precision Ground • Inch

catalog number	SSC	W		W tol ±		RC		LI		WU25PT
		mm	in	mm	in	mm	in	mm	in	
WR125I03P00PC	3	3,18	.125	0,025	.001	1,59	.062	9,54	.376	6470263
WR187I04P00PC	4	4,76	.188	0,025	.001	2,38	.094	10,13	.399	6470264
WR250I06P00PC	6	6,35	.250	0,025	.001	3,18	.125	14,54	.572	6470265
WR312I08P00PC	8	7,92	.312	0,025	.001	3,96	.156	17,40	.685	6470266

NOTE: SSC = Pocket Seat Reference. To correspond with the SSC on the toolholder.

▼ Plunge feed rates

- first choice
- alternate choice

P Steel	K Cast Iron	S High-Temp Alloys
M Stainless Steel	N Non-Ferrous	H Hardened Materials

Chip Control	Description	Insert Geometry	Seat Size (SSC)	Corner Radius	Starting Conditions	Plunge Feed Rates inch/rev (mm/rev)							
				in (mm)	in (mm)	.0020 (0,05)	.0040 (0,10)	.0060 (0,15)	.0080 (0,20)	.0100 (0,25)	.0120 (0,30)	.0140 (0,35)	
-PT	Positive rake angle for lower cutting forces.		1F	.008 (0,2)	.0024 (0,06)	●	○						
			2	.008 (0,2)	.0031 (0,08)	●	○						
			3	.008 (0,2)	.0035 (0,09)	●	○						
			4	.016 (0,4)	.0043 (0,11)	●	○						
			4	.016 (0,4)	.0047 (0,12)	●	○						
			5	.031 (0,8)	.0059 (0,15)	●	○						
			5	.016 (0,4)	.0059 (0,15)	●	○						
			6	.031 (0,8)	.0059 (0,16)	●	○						
			6	.016 (0,4)	.0059 (0,15)	●	○						
			8	.031 (0,8)	.0071 (0,18)	●	○						
8	.047 (1,2)	.0079 (0,20)	●	○									
10	.031 (0,8)	.0079 (0,20)	●	○									
10	.047 (1,2)	.0087 (0,22)	●	○									
10	.047 (1,2)	.0094 (0,24)	●	○									
-PN	Stable negative cutting edge allowing for more aggressive applications.		1F	.008 (0,2)	.0024 (0,06)	○	●						
			2	.008 (0,2)	.0031 (0,08)	○	●						
			3	.008 (0,2)	.0035 (0,09)	○	●						
			4	.016 (0,4)	.0043 (0,11)	○	●						
			4	.016 (0,4)	.0047 (0,12)	○	●						
			5	.031 (0,8)	.0059 (0,15)	○	●						
			5	.016 (0,4)	.0059 (0,15)	○	●						
			6	.031 (0,8)	.0059 (0,16)	○	●						
			6	.016 (0,4)	.0059 (0,15)	○	●						
			8	.031 (0,8)	.0071 (0,18)	○	●						
8	.047 (1,2)	.0079 (0,20)	○	●									
10	.031 (0,8)	.0079 (0,20)	○	●									
10	.047 (1,2)	.0087 (0,22)	○	●									
10	.047 (1,2)	.0094 (0,24)	○	●									

▼ Cut-Off Feed Rates

Geometry	Description	Insert Geometry	Seat Size (SSC)	Starting Conditions	Cut-Off Feed Rates inch/rev (mm/rev)							
				in (mm)	.0020 (0,05)	.0040 (0,10)	.0060 (0,15)	.0080 (0,20)	.0100 (0,25)	.0120 (0,30)	.0140 (0,35)	.0160 (0,40)
-F	Positive geometry for reduced cutting forces.		1B	.0024 (0,06)	○	●						
			2	.0028 (0,07)	○	●						
			3	.0035 (0,09)	○	●						
			4	.0043 (0,11)	○	●						
			5	.0051 (0,13)	○	●						
-M	Stable cutting edge for aggressive feed rates. Primarily in cast iron.		1B	.0024 (0,06)	○	●						
			2	.0028 (0,07)	○	●						
			3	.0035 (0,09)	○	●						
			4	.0043 (0,11)	○	●						
			5	.0055 (0,14)	○	●						
6	.0063 (0,16)	○	●									
8	.0067 (0,17)	○	●									
-R	Most stable cutting edge for steel.		2	.0039 (0,10)	○	●						
			3	.0055 (0,14)	○	●						
			4	.0063 (0,16)	○	●						
			5	.0075 (0,19)	○	●						
			6	.0083 (0,21)	○	●						
8	.0090 (0,23)	○	●									

NOTE: For cut-off inserts with a lead angle, maximum feed rate should be reduced by up to 40%.

Maximum Feed Rate Values

Data above is for P and K material groups. Maximum feed rates should be adjusted by multiplying max feed rate values by following factors for shown material groups.	Material Group	Feed Factor
	M	0.8
	N	1.2
	S	0.8
	H	0.5

I.D. and Face Grooving
For I.D. and face grooving applications, reduce feed rate by 20%.

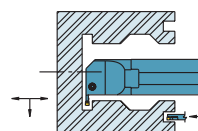

▼ Turn and profile feed rates

Seat Size 1F

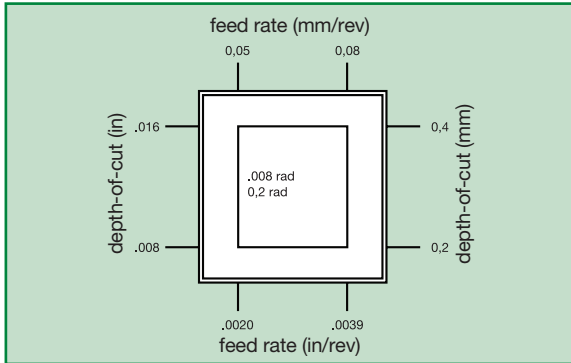

Seat Size 2

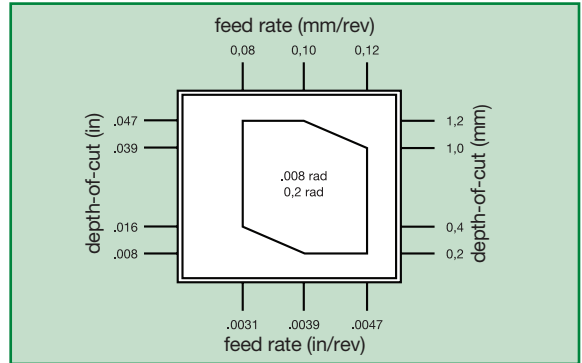

Seat Size 3

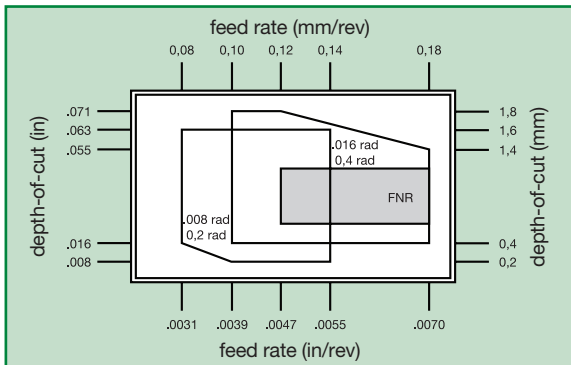

Seat Size 4

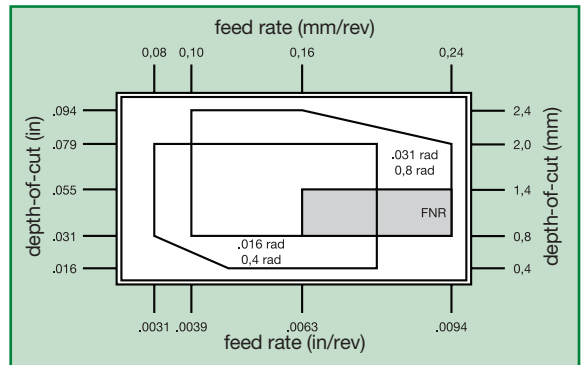

Seat Size 5

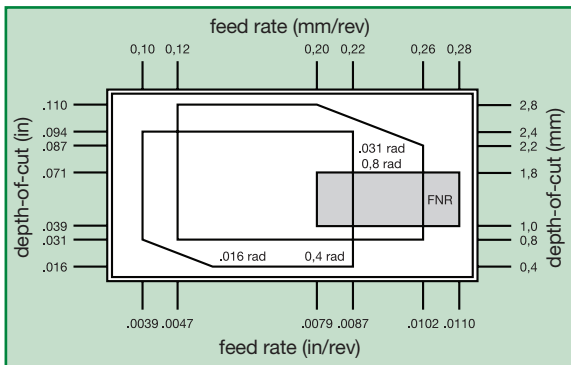

Seat Size 6

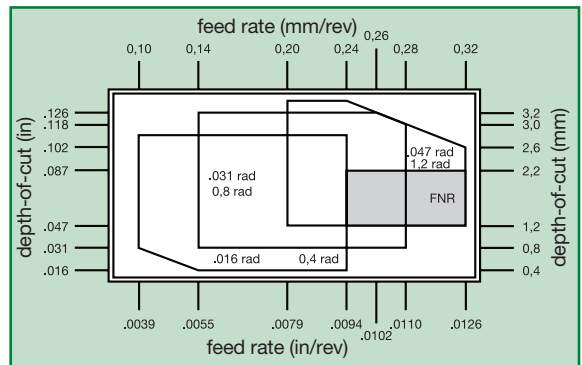

Seat Size 8

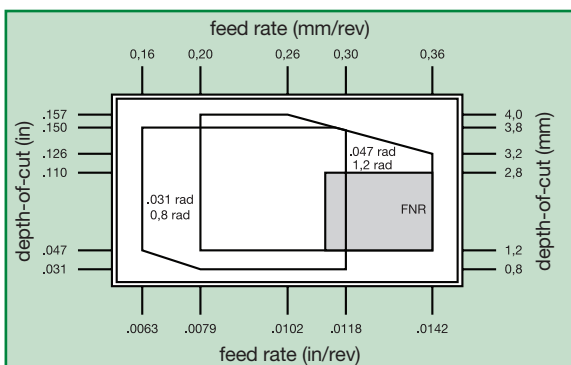

Seat Size 10

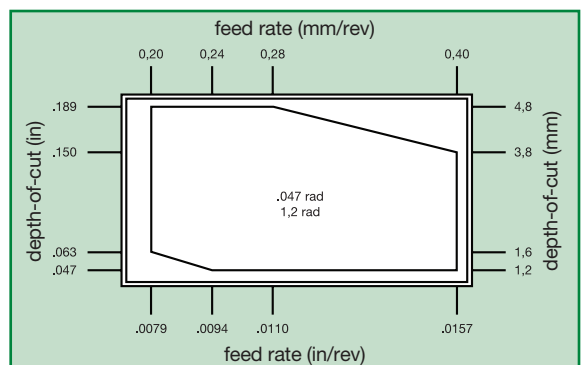

* FNR = Full Nose Radius

Maximum Feed Rate Values

Data above is for P and K material groups. Maximum feed rates should be adjusted by multiplying max feed rate values by following factors for shown material groups.	Material Group	Feed Factor
	M	0.8
	N	1.2
	S	0.8
	H	0.5

Recommended Starting Speeds • Inch and Metric

Material Group		WU25PT					
		Inch			Metric		
P	0-1	360	740	880	110	225	270
	2	360	520	880	110	160	260
	3	360	410	800	110	125	235
	4	200	290	540	60	90	160
	5	320	530	680	100	160	210
	6	280	400	600	85	120	185
M	1	300	550	800	90	170	245
	2	300	500	800	90	150	245
	3	300	450	700	90	140	210
K	1	320	480	760	100	145	225
	2	240	400	560	70	120	170
	3	160	280	400	50	85	120
N	1-2	400	1440	2560	120	440	780
	3	—	—	—	—	—	—
	4	320	960	1600	100	290	490
	5	240	440	640	70	135	195
	6	320	560	800	100	170	245
S	1	25	125	200	8	40	60
	2	25	100	250	8	30	75
	3	50	125	250	15	40	75
	4	25	175	350	8	50	110

NOTE: FIRST choice starting speeds are in **bold** type.
As the average chip thickness increases, the speed should be decreased.



Internal Coolant Delivery

Geometry placement is a key factor to coolant delivery!

Engineers positioned WGC geometry in the perfect position to spread the coolant across the cutting edge for maximum performance.

Coolant parameters

WGC is capable of both low and high pressure coolant up to 350 bar (5076 psi) with no lower limit.

Tech Tip — If performance is not being achieved due to the machine pump's inability to provide pressure, even if volume is acceptable, flood coolant should also be applied.

Performance

Internal tests have shown up to 30% increased tool life.

Tech Tip — Regular maintenance of coolant filtration system required to achieve maximum performance.

Coolant entry

WGC offers multiple coolant ports for convenience.

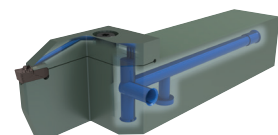

▼ Coolant Kit

Component Description														
1/16 NPTF MALE TO JIC MALE	1/8 NPTF MALE TO JIC MALE	M8 X 1.25 MALE TO JIC MALE	M8 X 1.0 MALE TO JIC MALE	G1/8 MALE TO JIC MALE	M10 MALE TO JIC MALE	MALE JIC TO FEMALE JIC ELBOW	HEAVY DUTY 200MM COOLANT HOSE	HEAVY DUTY 300MM COOLANT HOSE	UNIV 200MM FLEX COOLANT HOSE	UNIV 300MM FLEX COOLANT HOSE	M8X1.0 BANJO 200MM FLEX HOSE	G1/8 BANJO 200MM FLEX HOSE	M8X1.0 BANJO 300MM FLEX HOSE	G1/8 BANJO 300MM FLEX HOSE
Component Order Number														
6145374	6145375	6145378	6475041	6145376	6145377	6145379	6145380	6145381	6432549	6432550	6475043	6475045	6475047	6475049

Kit Description	Order Number	Shank Size	Coolant Pressure	6145374	6145375	6145378	6475041	6145376	6145377	6145379	6145380	6145381	6432549	6432550	6475043	6475045	6475047	6475049
Universal 200mm flex hose coolant kit	6475019	12-40mm 1/2-1-1/2"	200 Bar 2,901 psi		•	•	•	•	•	•			•					
Universal 300mm flex hose coolant kit	6475021	12-40mm 1/2-1-1/2"	200 Bar 2,901 psi	•	•	•	•	•	•	•				•				
M8x1.0 banjo 200mm flex hose coolant kit	6475023	12-20mm 1/2-3/4"	200 Bar 2,901 psi					•	•	•					•			
M8x1.0 banjo 300mm flex hose coolant kit	6475025	12-20mm 1/2-3/4"	200 Bar 2,901 psi					•	•	•							•	
G 1/8 banjo 200mm flex hose coolant kit	6475027	25-40mm 1-1-1/2"	200 Bar 2,901 psi					•	•	•						•		
G 1/8 banjo 300mm flex hose coolant kit	6475029	25-40mm 1-1-1/2"	200 Bar 2,901 psi					•	•	•								•
Universal 200mm heavy-duty coolant kit	6145372	25-40mm 1-1-1/2"	350 Bar* 5,076 psi*	•	•			•	•	•	•							
Universal 300mm heavy-duty coolant kit	6145373	25-40mm 1-1-1/2"	350 Bar* 5,076 psi*	•	•			•	•	•		•						

* Max pressure for seat size 02 holders is 200 bar/2901 psi.



▼ Individual Kit Component List

order number	catalog number	description
6145374	1-16NPTF-JIC	Straight fitting, 1/16 NPTF male thread to JIC male thread
6145375	1-8NPTF-JIC	Straight fitting, 1/8 NPTF male thread to JIC male thread
6145378	M8X1.25-JIC	Straight fitting, M8 x 1.25 male thread to JIC male thread
6475041	M8X1-JIC	Straight fitting, M8 x 1.0 male thread to JIC male thread
6145376	G18-JIC	Straight fitting, G 1/8 male thread to JIC male thread
6145377	M10X1.5-JIC	Straight fitting, M10 x 1.5 male thread to JIC male thread
6145379	JICM-JICF-ELB	Elbow fitting, male JIC thread to female JIC thread
6145380	COOL-HOSE-200-HD	Heavy Duty 200mm Coolant hose with JIC female fitting both ends
6145381	COOL-HOSE-300-HD	Heavy Duty 300mm Coolant hose with JIC female fitting both ends
6432549	COOL-HOSE-200-FLEX	Flexible braided 200mm Coolant hose with JIC female fitting both ends
6432550	COOL-HOSE-300-FLEX	Flexible braided 300mm Coolant hose with JIC female fitting both ends
6475043	M8X1-BAN-JIC-HOSE-200	Flexible braided 200mm Coolant hose, M8 x 1.0 male thread to JIC female thread. Contains (1) M8x1.0 banjo bolt and (2) M8 bonded washers
6475045	G18-BAN-JIC-HOSE-200	Flexible braided 200mm Coolant hose, G 1/8 male thread to JIC female thread. Contains (1) G 1/8 banjo bolt and (2) G 1/8 bonded washers
6475047	M8X1-BAN-JIC-HOSE-300	Flexible braided 300mm Coolant hose, M8 x 1.0 male thread to JIC female thread. Contains (1) M8x1.0 banjo bolt and (2) M8 bonded washers
6475049	G18-BAN-JIC-HOSE-300	Flexible braided 300mm Coolant hose, G 1/8 male thread to JIC female thread. Contains (1) G 1/8 banjo bolt and (2) G 1/8 bonded washers



▼ Coolant Accessories

The items shown below are not part of any coolant kits shown on previous pages.

order number	catalog number	description
6145382	M6X1-JIC	Straight fitting, M6 x 1.0 male thread to JIC male thread
6145383	JICM-JICM-STR	Straight fitting, JIC male thread to JIC male thread
6145386	G14-G18-RED	Straight fitting, G 1/4 male thread to G 1/8th male thread
6475058	R18-JIC	Straight fitting, 1/8 BSPT male thread to JIC male thread
6475059	R14-JIC	Straight fitting, 1/4 BSPT male thread to JIC male thread

▼ Coolant Spare Parts

Included in kits; part of components.

order number	catalog number	description
6475051	M8X1-BAN-BOLT	Banjo bolt, M8 x 1.0 male thread
6475053	G18-BAN-BOLT	Banjo bolt, G1/8 male thread
6475060	M6-BON-WASHER	M6 bonded washer
6475055	M8-BON-WASHER	M8 bonded washer
6475061	M10-BON-WASHER	M10 bonded washer
6475056	G18-BON-WASHER	G 1/8 bonded washer

WGC Application Guidelines

Internal Coolant Delivery Guidelines

1. WGC system capable of 5076 psi (350 bar).
2. Toolholder delivered with four entry holes.
3. A quality filtration system is necessary to prevent blockages in the toolholder that will affect coolant flow and performance.
4. Machines without a proper filtering system may require modification or an inline filter.
 - For pressure >1015 psi [70 bar], use 10–20 µm filter.
 - For pressure <1015 psi [70 bar], 50–100 µm.
 - Using fine filters in low-pressure applications may affect flow rate.

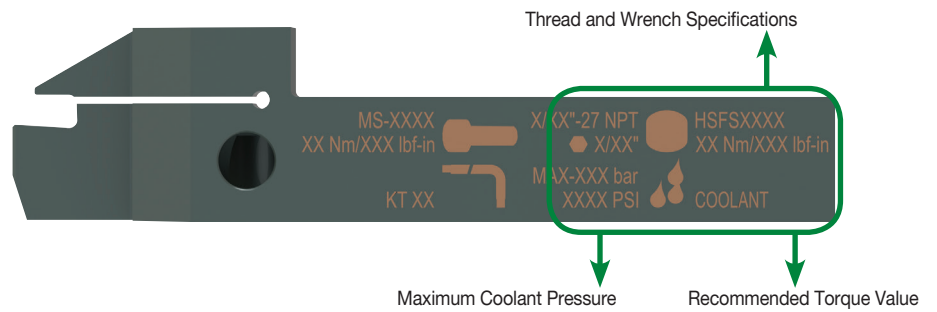
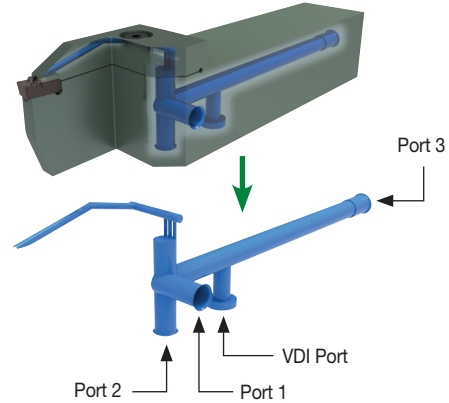

General Safety Guidelines

1. All safety doors and mechanisms must be in place before trying out the internal coolant to avoid any danger to the operator in the event of a failure.
2. Use the correct pipe fittings to connect the holders to the system. Ensure the maximum pressure recommended for the fittings are not exceeded.
3. While implementing pressure >1160 psi [80 bar], increase the pressure in steps to ensure proper functioning of insert clamping and leak-free joints.
4. While indexing inserts, ensure the pocket is free from chips and/or dirt. Also, inspect the insert and make sure there are no blockages in the coolant canal.
5. Periodically check all hoses and fittings for damage and wear for proper functioning of the system. This check should also include filters.

Internal Coolant Delivery Performance

Internal coolant offers a clear advantage in tool life and chip forming/evacuation vs. external coolant in difficult conditions and in high-pressure coolant.

Example: Chipbreaking in plunging of steel.

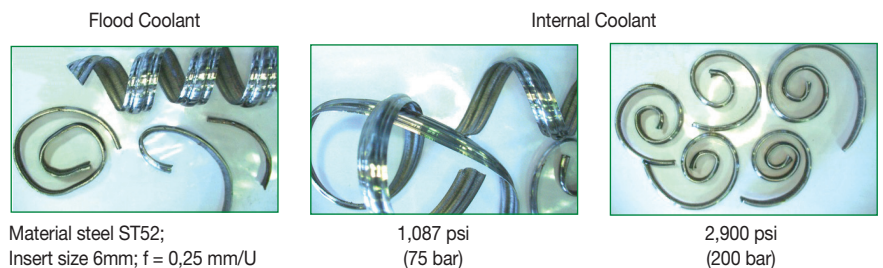

Low Pressure — If performance is at risk due to low coolant pressure, apply internal coolant in combination with external coolant to increase volume.













Recommendation to improve tool life and/or productivity: Apply high pressure coolant: 80–350 bar recommended.

VDI Assemblies

















The WGC internal coolant delivery can be leveraged with VDI holding systems with both traditional or Quick-Change coolant connections.

Informational Icons Guide



















Indexable Milling Icons

 Counterboring	 Spiral Circular	 Face Milling	 Helical Milling	 Plunge Milling
 Ramping	 Slotting: Square End	 Side Milling/ Shoulder Milling: Square End	 3D Profiling: Inclined Square End Mill	 Pocketing
 Weldon® Shank	 Shell Mill	 Through Coolant		

Solid End Milling Icons









 Ramping: Blank	 Slotting: Square End	 Slotting: Square End with AP Dimension	 Side Milling/ Shoulder Milling: Square End	 Side Milling/ Shoulder Milling: Square End with AE/AP Dimension
 3D Profiling	 3D Profiling: 3D Profiling with AE/AP Dimensions	 Corner Style: Corner Radius	 Corner Style: Square End	 Corner Style: Torus
 Cylindrical/Plain Shank	 Helix Angle: 20°	 Helix Angle: 45°	 Tool Dimensions: Flute Configuration: X (Variable)	 Tool Dimensions: Flute Configuration: 2
 ZU=6 Tool Dimensions: Flute Configuration: 6				

Holemaking Icons









 Drilling	 Drilling: Inclined Entry	 Drilling: Inclined Exit	 Drilling: X-Offset	 Drilling: Stacked Plates
 Drilling: Convex	 Drilling: Blind	 Chain Drilling	 Drilling: Cross Hole	 Drilling: Half Cylinder
 Drilling: Corner Drilling 45°	 Drilling Depth: 3x	 Drilling Depth: 5x	 Drilling Depth: 8x	 Flat Shank
 SSF Shank	 Through Coolant: Radial: Drilling	 Through Coolant: Radial: Indexable Drilling	 Tool Dimensions: 2-Flute/2-Margin/ Coolant	

Informational Icons Guide

Turning Icons

 Turning	 Profiling	 Facing	 Face Grooving	 Chamfering
 Grooving	 Cut-off	 Deep Grooving	 Through Coolant: Grooving	

Tapping Icons

 Threading: Through Hole	 HSS-E: High-Speed Steel with Cobalt Alloy for Materials with Higher Hardness	 Chamfer Form B (3.5–5.5)	 Multipurpose Taps: Spiral Point	 Unified Fine Thread
 Unified Course Thread	 ANSI	 Flood Coolant: Tapping		

DIN — German Institute for Standardization
ISO — International Standardization Organization

Customer Application Support (CAS)

Get fast and reliable answers to your toughest metalcutting problems.

Our Customer Application Support (CAS) Team is the metalworking industry's leading help desk resource for tooling application solutions and problem resolution.

- Easy access to proven metalworking expertise.
- Service level excellence.
- Best-in-class application support tools and technology.

Easy access to proven metalworking expertise!

WIDIA™ Customer Application Engineers assist customers and engineering groups throughout the world with expert tool selection and application recommendations for the entire range of WIDIA tooling.

Service Level Excellence:

- Fast telephone response.
- Quick technical solutions.
- Efficient case management.

Services Provided:

- Tooling selection.
- Operating parameters.
- Troubleshooting.
- Process optimization.
- Hardware support.

Best-in-Class Support Tools and Technology:

- Tooling performance experts.
- Materials database.
- Application calculators.

ORIGINATING COUNTRY	LANGUAGE	TEL	FAX	EMAIL
Australia	English	001-724-539-6921 *	001-724-539-6830 *	ap.techsupport@widia.com
Austria	German	0800 291630	0049-911-9735-429 *	eu.techsupport@widia.com
Belgium	English/French	0800 80410	0049-911-9735-429 *	eu.techsupport@widia.com
China	Chinese	400-889-2237	+86-21-58999985 *	w-cn.techsupport@widia.com
Denmark	English	808 89295	001-724-539-6830 *	na.techsupport@widia.com
Finland	English	0800 919413	001-724-539-6830 *	na.techsupport@widia.com
France	French	080 5540 379	0049-911-9735-429 *	eu.techsupport@widia.com
Germany	German	0800 1015774	0911-9735-429*	eu.techsupport@widia.com
India	English	1 800 103 5227	—	in.techsupport@widia.com
Israel	English	1809 449907	001-724-539-6830 *	na.techsupport@widia.com
Italy	Italian	800 916568	02 89512146 *	eu.techsupport@widia.com
Japan	English	001-724539-6921 *	001-724-539-6830 *	ap.techsupport@widia.com
Korea (South)	English	001-724539-6921 *	001-724-539-6830 *	ap.techsupport@widia.com
Malaysia	English	001-724539-6921 *	001-724-539-6830 *	ap.techsupport@widia.com
Netherlands	English	0800 0201131	001-724-539-6830 *	na.techsupport@widia.com
New Zealand	English	001-724539-6921 *	001-724-539-6830 *	ap.techsupport@widia.com
Norway	English	800 10081	001-724-539-6830 *	na.techsupport@widia.com
Poland	Polish	00800 4411943	06166 56504 *	eu.techsupport@widia.com
Russia (landline)	Russian	8800 5556395	0048 6166 56504 *	eu.techsupport@widia.com
Russia (cell phone)	Russian	+7 8005556395	0048 6166 56504 *	eu.techsupport@widia.com
Singapore	English	001-724539-6921 *	001-724-539-6830 *	ap.techsupport@widia.com
South Africa	English	0800 981644	001-724-539-6830 *	na.techsupport@widia.com
Sweden	English	020798794	001-724-539-6830 *	na.techsupport@widia.com
Taiwan	English	001-724539-6921 *	001-724-539-6830 *	ap.techsupport@widia.com
Thailand	English	001-724539-6921 *	001-724-539-6830 *	ap.techsupport@widia.com
United Kingdom	English	0800 028 2996	001-724-539-6830 *	na.techsupport@widia.com
Ukraine	Russian	800502665	0048 6166 56504 *	eu.techsupport@widia.com
USA	English	888 539 5145	001-724-539-6830 *	na.techsupport@widia.com

*Noted phone and fax numbers are not toll free.

Material Overview • ANSI

ANSI

P Steel	K Cast Iron	S High-Temp Alloys
M Stainless Steel	N Non-Ferrous	H Hardened Materials

material group	description	content	tensile strength RM (MPa)*	hardness (HB)	hardness (HRC)	material number
P0	Low-Carbon Steels, Long Chipping	C <0,25%	<530	<125	–	A36, 1008, 1010, 1018 through 1029; 1108, 1117
P1	Low-Carbon Steels, Short Chipping, Free Machining	C <0,25%	<530	<125	–	10L18, 1200 Series, 1213, 12L14
P2	Medium- and High-Carbon Steels	C >0,25%	>530	<220	<25	1035, 1045, 10L45, 1050, 10L50, 1080, 1137, 1144, 11L44, 1525, 1545, 1572
P3	Alloy Steels and Tool Steels	C >0,25%	600–850	<330	<35	1300, 2000, 3000, 4000, 5000, 8000, P20, SAE: A, D, H, O, S, M, T
P4	Alloy Steels and Tool Steels	C >0,25%	850–1400	340–450	35–48	1300, 2000, 3000, 4000, 5000, 8000, P20, SAE: A, D, H, O, S, M, T
P5	Ferritic, Martensitic, and PH Stainless Steels	–	600–900	<330	<35	15–5 PH, 13–8 PH, 17–4 PH, 400 and 500 Series
P6	High-Strength Ferritic, Martensitic, and PH Stainless Steels	–	900–1350	350–450	35–48	15–5 PH, 13–8 PH, 17–4 PH, 400 and 500 Series
M1	Austenitic Stainless Steel	–	<600	130–200	–	200 Series, 301, 302, 304, 304L, 309
M2	High-Strength Austenitic Stainless and Cast Stainless Steels	–	600–800	150–230	<25	310, 316, 316L, 321, 347, 384 ASTM Cast XM-1, XM-5, XM-7, XM-21
M3	Duplex Stainless Steel	–	<800	135–275	<30	323, 329, F55, 2205, S329000
K1	Gray Cast Iron	–	125–500	120–290	<32	class 20, 25, 30, 35, 40, 45, 50, 55, 60, G1800, G3000, G3500, G4000
K2	Low- and Medium-Strength Ductile Irons (Nodular Irons) and Compacted Graphite Irons (CGI)	–	<600	130–260	<28	60-40-18, 65-45-12, 80-55-06, SAE J434:D4018, D4512, D5506, ASTM A47: Grade 32510, 35018, SAE J158: Grade M3210, M4504, M5003, M5503, M7002, ASTMA842: Grade 250, 300, 350, 400, 450
K3	High-Strength Ductile Irons and Austempered Ductile Iron (ADI)	–	>600	180–350	<43	ASTM A536:100-70-03, 120-90-02, SAE J434: D7003, SAE J158: Grade M8501AST A897: 125-80-10, 150-100-7, 175-125-4, 200-150-1, 230-185
N1	Wrought Aluminum	–	–	–	–	2025, 5050, 7050, 1000, 2017
N2	Low-Silicon Aluminum Alloys and Magnesium Alloys	Si <12,2%	–	–	–	2024, 6061, 7075
N3	High-Silicon Aluminum Alloys and Magnesium Alloys	Si >12,2%	–	–	–	–
N4	Copper-, Brass-, Zinc-Based on Machinability Index Range of 70–100	–	–	–	–	C81500
N5	Nylon, Plastics, Rubbers, Phenolics, Resins, Fiberglass	–	–	–	–	–
N6	Carbon, Graphite Composites, CFRP	–	–	–	–	Graphite, CFK, CFRP
N7	Metal Matrix Composites (MMC)	–	–	–	–	C63000
S1	Iron-Based, Heat-Resistant Alloys	–	500–1200	160–260	25–48	A-286, INCOLOY® 800 Series, A608, A567, Discaloy™, INVAR®, N-155, 16-25-6, 19-9 DL; Cast: ASTM A-297, A-351, A-567, A-608
S2	Cobalt-Based, Heat-Resistant Alloys	–	1000–1450	250–450	25–48	Haynes® 25 (L605), Haynes 188, J-1570, Stellite®, AlResist 213; Cast: AlResist 13, Haynes 21, MAR-M302, MAR-M509, NASA Co-W-Re, WI-52
S3	Nickel-Based, Heat-Resistant Alloys	–	600–1700	160–450	<48	Astrolloy™, Hastelloy® B/C/ C-276 /X, INCONEL® 600 and 700 Series, IN102, INCOLOY 900 Series, Rene 41, Waspalloy®, Monel®, K-500, MAR-M20, NIMONIC®, UDIMET®
S4	Titanium and Titanium Alloys	–	900–1600	300–400	33–48	Pure: Ti 98.8, Ti 98.9, Ti 99.9; Alloyed: Ti 5Al-2.5Sn, Ti6Al-4V, Ti6Al-2Sn-4Zr-2Mo, Ti-3Al-8V-6Cr-4Mo-4Zr, Ti-10V-2Fe-3Al, Ti-13V-11Cr-3Al
H1	Hardened Materials	–	–	–	44–48	Tool Steel H10, H11, H13, D2, D3, 4340, P20
H2	Hardened Materials	–	–	–	48–55	Tool Steel H10, H11, H13, D2, D3, 4340, P20
H3	Hardened Materials	–	–	–	56–60	Tool Steel H10, H11, H13, D2, D3, 4340, P20
H4	Hardened Materials	–	–	–	>60	Tool Steel H10, H11, H13, D2, D3, 4340, P20

Material Overview • DIN

DIN

P Steel
M Stainless Steel

K Cast Iron
N Non-Ferrous

S High-Temp Alloys
H Hardened Materials

material group	description	content	tensile strength RM (MPa)*	hardness (HB)	hardness (HRC)	material number
P0	Low-Carbon Steels, Long Chipping	C <0,25%	<530	<125	–	–
P1	Low-Carbon Steels, Short Chipping, Free Machining	C <0,25%	<530	<125	–	C15, Ck22, ST37-2, S235JR, 9SMnPb28, GS38
P2	Medium- and High-Carbon Steels	C >0,25%	>530	<220	<25	ST52, S355JR, C35, GS60, Cf53
P3	Alloy Steels and Tool Steels	C >0,25%	600–850	<330	<35	16MnCr5, Ck45, 21CrMoV5-7, 38SMn28
P4	Alloy Steels and Tool Steels	C >0,25%	850–1400	340–450	35–48	100Cr6, 30CrNiMo8, 42CrMo4, C70W2, S6525, X120Mn12
P5	Ferritic, Martensitic, and PH Stainless Steels	–	600–900	<330	<35	100Cr6, 30CrNiMo8, 42CrMo4, C70W2, S6525, X120Mn12
P6	High-Strength Ferritic, Martensitic, and PH Stainless Steels	–	900–1350	350–450	35–48	X102CrMo17, G-X120Cr29
M1	Austenitic Stainless Steel	–	<600	130–200	–	X5CrNi 18 10, X2CrNiMo 17 13 2, G-X25CrNiSi18 9, X15CrNiSi 20 12
M2	High-Strength Austenitic Stainless and Cast Stainless Steels	–	600–800	150–230	<25	X2CrNiMo 13 4, X5NiCr 32 21, X5CrNiNb 18 10, G-X15CrNi 25-20
M3	Duplex Stainless Steel	–	<800	135–275	<30	X8CrNiMo27 5, X2CrNiMoN22 5 3, X20CrNiSi25 4, G-X40CrNiSi27 4
K1	Gray Cast Iron	–	125–500	120–290	<32	GG15, GG25, GG30, GG40, GTW40
K2	Low- and Medium-Strength Ductile Irons (Nodular Irons) and Compacted Graphite Irons (CGI)	–	<600	130–260	<28	GGG40, GTS35
K3	High-Strength Ductile Irons and Austempered Ductile Iron (ADI)	–	>600	180–350	<43	GGG60, GTW55, GTS65
N1	Wrought Aluminum	–	–	–	–	AlMg1, Al99.5, AlCuMg1, AlCuBiPb, AlMgSi1, ALMgSiPb
N2	Low-Silicon Aluminum Alloys and Magnesium Alloys	Si <12,2%	–	–	–	GAISiCu4, GDAISi10Mg
N3	High-Silicon Aluminum Alloys and Magnesium Alloys	Si >12,2%	–	–	–	G-ALSi12, G-ALSi17Cu4, G-ALSi21CuNiMg
N4	Copper-, Brass-, Zinc-Based on Machinability Index Range of 70–100	–	–	–	–	CuZn40, Ms60, G-CuSn5ZnPb, CuZn37, CuSi3Mn
N5	Nylon, Plastics, Rubbers, Phenolics, Resins, Fiberglass	–	–	–	–	Lexan®, Hostalen™, Polystyrol, Makralon®
N6	Carbon, Graphite Composites, CFRP	–	–	–	–	CFK, GFK
N7	Metal Matrix Composites (MMC)	–	–	–	–	–
S1	Iron-Based, Heat-Resistant Alloys	–	500–1200	160–260	25–48	X1NiCrMoCu32 28 7, X12NiCrSi36 16, X5NiCrAlTi31 20, X40CoCrNi20 20
S2	Cobalt-Based, Heat-Resistant Alloys	–	1000–1450	250–450	25–48	Haynes® 188, Stellite® 6,21,31
S3	Nickel-Based, Heat-Resistant Alloys	–	600–1700	160–450	<48	INCONEL® 690, INCONEL 625, Hastelloy®, Nimonic® 75
S4	Titanium and Titanium Alloys	–	900–1600	300–400	33–48	Ti1, TiAl5Sn2, TiAl6V4, TiAl4Mo4Sn2
H1	Hardened Materials	–	–	–	44–48	GX260NiCr42, GX330NiCr42, GX300CrNiSi952, GX300CrMo153, Hardox® 400
H2	Hardened Materials	–	–	–	48–55	–
H3	Hardened Materials	–	–	–	56–60	–
H4	Hardened Materials	–	–	–	>60	–

Notes



The NOVO™ Application Provides the Digital Power

To Get Information Quicker Than Ever Before.

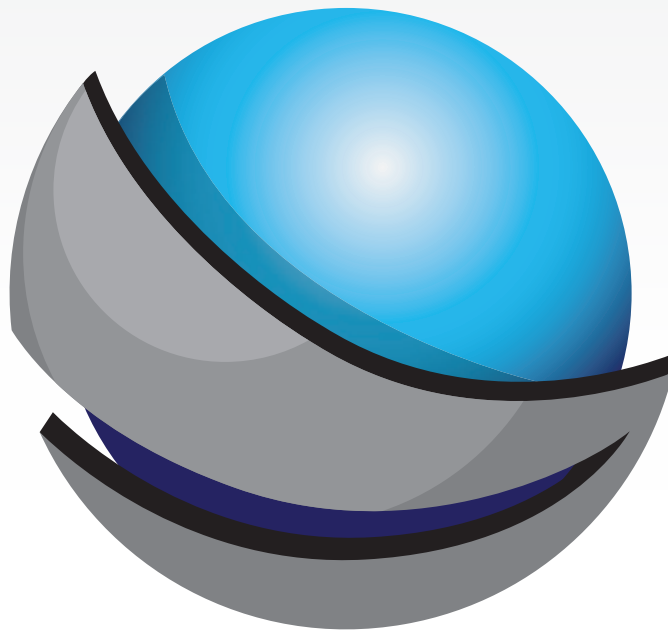

New for 2018 — Export Compatibility to Mastercam®

- Select tools, save into “job lists”.
- Interactive feed & speed calculators.
- Find inventory availability.
- Download 2-D and 3-D models.
- Easy interface with many CAM and tool management data systems.

Find your Local WIDIA Authorized Distributor

WIDIA™ brand cutting tools are available exclusively through a specialized network of Authorized Distributor partners whom you can count on to deliver much more than products. Our distributors know us, and more importantly, they know you. They know better than anyone in the industry how to put the global power of WIDIA to work for you — in your industry, in your region, and for your business.

WIDIA distributor partners provide technical expertise that you can count on. They will show you how to:

- Significantly reduce cycle time.
- Improve machine tool utilization.
- Achieve measurable productivity improvements.
- Take advantage of proven supply chain solutions.
- Access local inventory and best-in-class technical support.
- Request onsite demonstrations of the latest tooling technology.

And with thousands of turning, milling, holemaking, tapping, and tooling systems products available from WIDIA, you'll find everything you need from one single source.

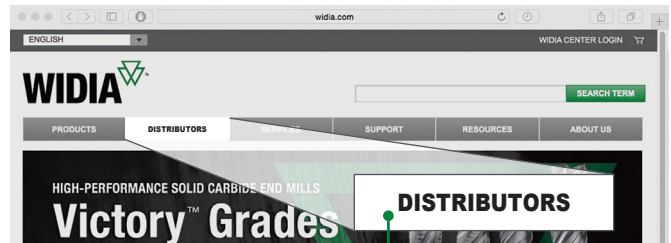

Find your Local WIDIA Authorized Distributor by accessing our distributor finder at widia.com.

IMPORTANT SAFETY INSTRUCTIONS: READ BEFORE USING THE TOOLS IN THIS CATALOG

METALCUTTING SAFETY

Projectile and Fragmentation Hazards

Modern metalcutting operations involve high spindle and cutter speeds and high temperatures and cutting forces. Hot metal chips may fly off the workpiece during metalcutting. Although cutting tools are designed and manufactured to withstand high cutting forces and temperatures, they can sometimes fragment, particularly if they are subjected to over-stress, severe impact, or other abuse.

To avoid injury:

- Always wear appropriate personal protective equipment, including safety goggles, when operating metalcutting machines or working nearby.
- Always make sure all machine guards are in place.

For more information, read the applicable Material Safety Data Sheet provided by WIDIA and consult General Industry Safety and Health Regulations, Part 1910, Title 29 of the Code of Federal Regulations.

These safety instructions are general guidelines. Many variables affect machining operations. It is impossible to cover every specific situation. The technical information included in this catalog and recommendations on machining practices may not apply to your particular operation.

For more information, consult the WIDIA Metalcutting Safety booklet, available free from WIDIA at +1 724 539 5747 or fax +1 724 539 5439. For specific product safety and environmental questions, contact our Corporate Environmental Health and Safety Office at +1 724 539 5066 or fax +1 724 539 5372.

Breathing and Skin Contact Hazards

Grinding carbide or other advanced cutting tool materials produces dust or mist containing metallic particles. Breathing this dust or mist — especially over an extended period — can cause temporary or permanent lung disease or make existing medical conditions worse. Contact with this dust or mist can irritate eyes, skin, and mucous membranes and may make existing skin conditions worse.

To avoid injury:

- Always wear breathing protection and safety goggles when grinding.
- Provide ventilation control and collect and properly dispose of dust, mist, or sludge from grinding.
- Avoid skin contact with dust or mist.

AluSurf, GTD Gun, NOVO, ProGroove, Top Cut 4, TOP DRILL, VariMill, VariMill I, VariMill II, VariMill III, VariTap, Victory, Vision Plus, VSM890-12, VXF, VXF-12, WIDIA, WIDIA-GTD, WIDIA-Hanita, and X-Feed are trademarks of Kennametal, Inc. and are used as such herein. The absence of a product, service name, or logo from this list does not constitute a waiver of the Kennametal trademark or other intellectual property rights concerning that name or logo.

Weldon® is a registered trademark of Weldon Tool Company.

©Copyright 2018 by Kennametal Inc., Latrobe, PA 15650. All rights reserved.

WIDIA 

ADVANCES

2019 INCH

WORLD HEADQUARTERS

WIDIA Products Group

Kennametal Inc.

1600 Technology Way
Latrobe, PA 15650 USA

Tel: 1 800 979 4342

w-na.service@widia.com

EUROPEAN HEADQUARTERS

WIDIA Products Group

Kennametal Europe GmbH

Rheingoldstrasse 50

CH 8212 Neuhausen am Rheinfall

Switzerland

Tel: +41 52 6750 100

w-ch.service@widia.com

ASIA-PACIFIC HEADQUARTERS

WIDIA Products Group

Kennametal (Singapore) Pte. Ltd.

3A International Business Park

Unit #01-02/03/05, ICON@IBP

Singapore 609935

Tel: +65 6265 9222

w-sg.service@widia.com

INDIA HEADQUARTERS

WIDIA Products Group

Kennametal India Limited

CIN: L27109KA1964PLC001546

8/9th Mile, Tumkur Road

Bangalore - 560 073

Tel: +91 80 2839 4321

w-in.service@widia.com



widia.com