

VALVE402

3/4" Volume Control
Rough-in Valve

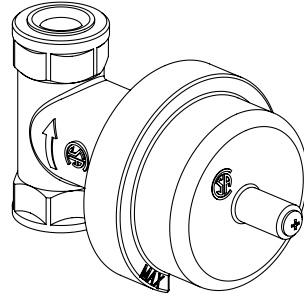

STANDARDS

- Compliant with ASME A112.18.1 B125.1 when sold with external trim
- Certified by or IAPMO R&T Lab when sold with external

FEATURES

- 1/4 turn ceramic disc valve
- 3/4" NPT connections
- Flows 15.0 GPM @ 60 PSI
- Step-By-Step Installation Instructions
- Limited Lifetime Warranty

DIMENSIONS

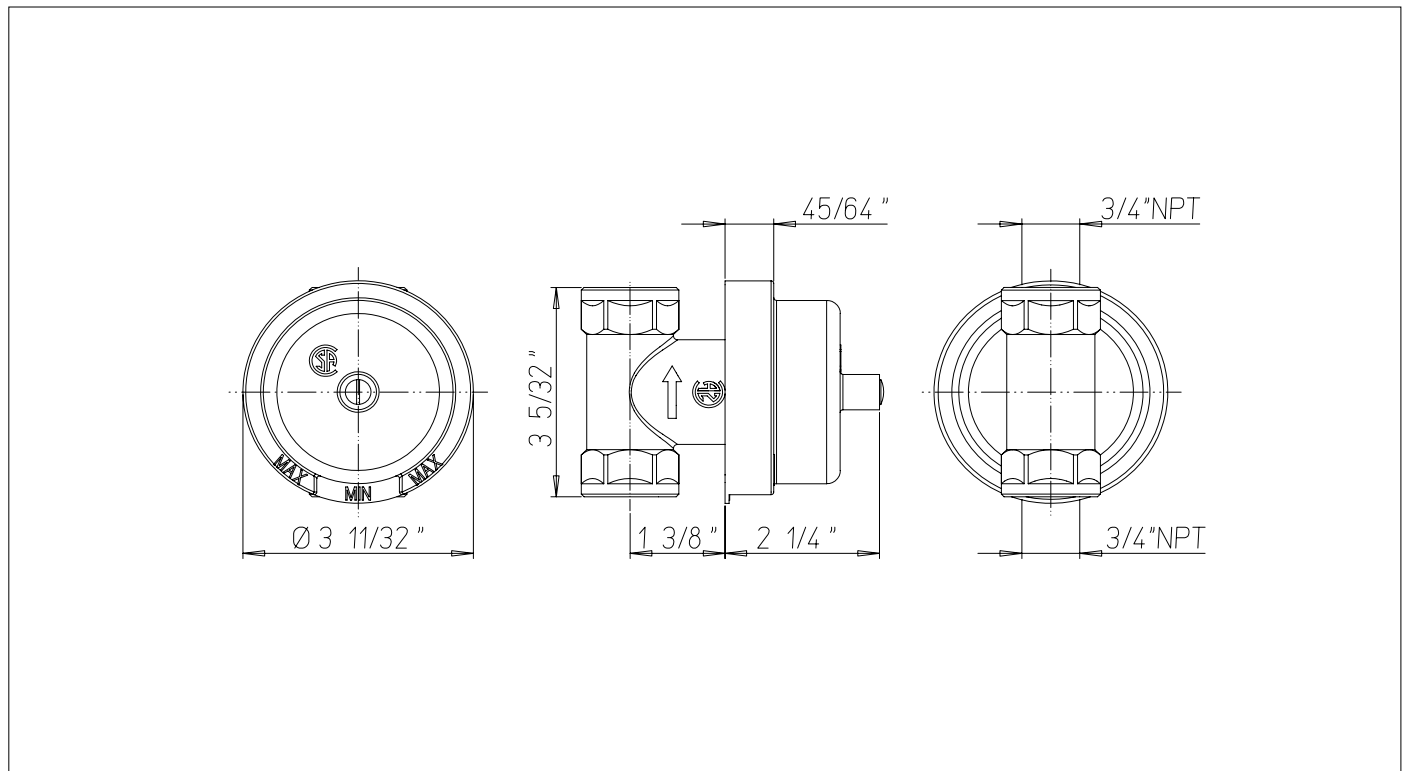

Project _____
Contractor _____