

9474406

8" Ceiling Mount
Shower Arm

FINISHES

- 9474408PC Polished Chrome
- 9474408BN Brushed Nickel
- 9474408BG Brushed Gold
- 9474408BB Brushed Black

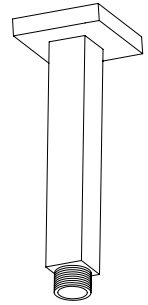

STANDARDS

- Compliant with ASME A112.18.1 - CSA B125.1

FEATURES

- Solid Brass Construction
- 1/2" male NPT connection
- Round Flange to support arm
- Step-By-Step Installation Instructions

DIMENSIONS

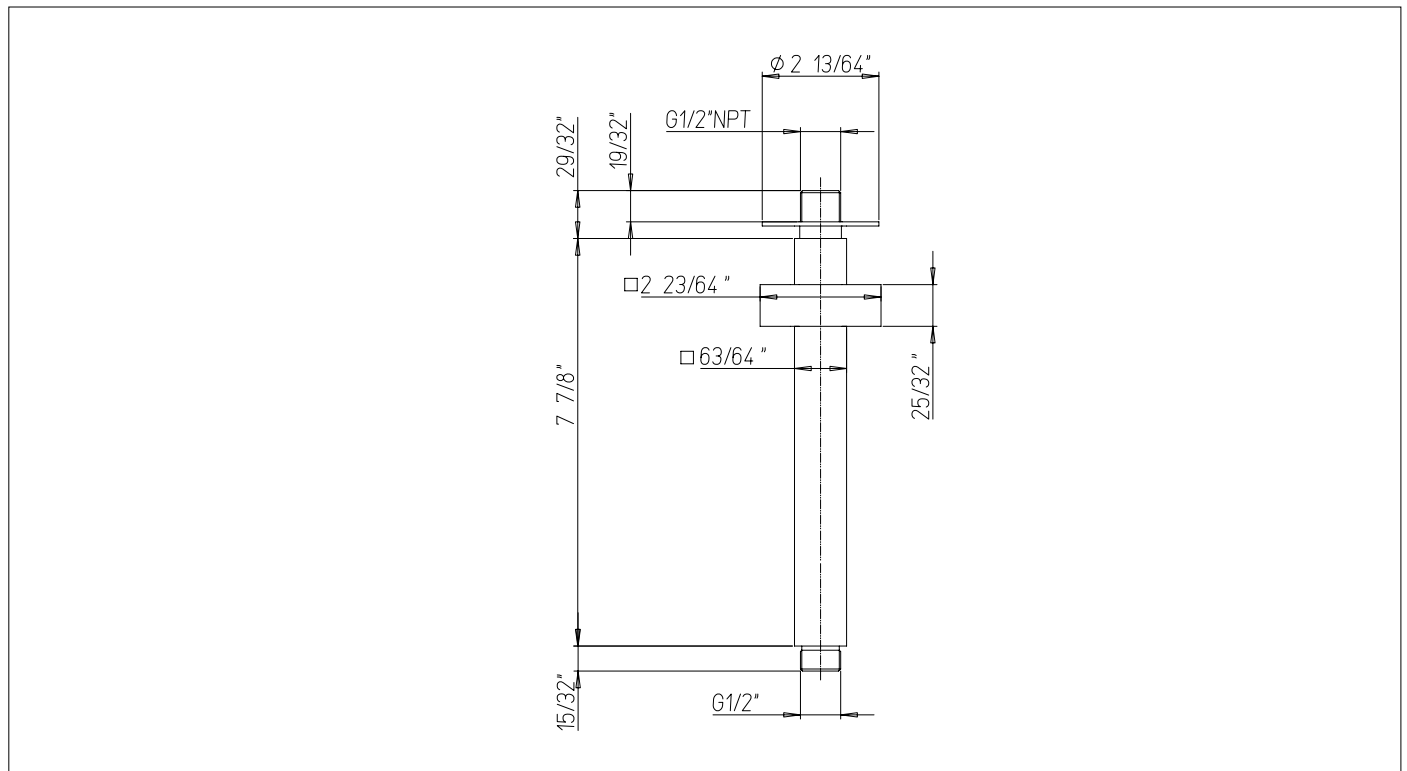

Project _____
Contractor _____