

5074406
6" Ceiling Mount
Shower Arm

FINISHES

- 5074406PC Polished Chrome
- 5074406BN Brushed Nickel
- 5074406BG Brushed Gold
- 5074406BB Brushed Black

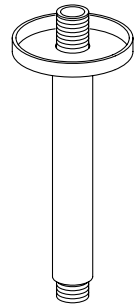

STANDARDS

- Compliant with ASME A112.18.1 - CSA B125.1

FEATURES

- Solid Brass Construction
- 1/2" male NPT connection
- Round Flange to support arm
- Step-By-Step Installation Instructions

DIMENSIONS

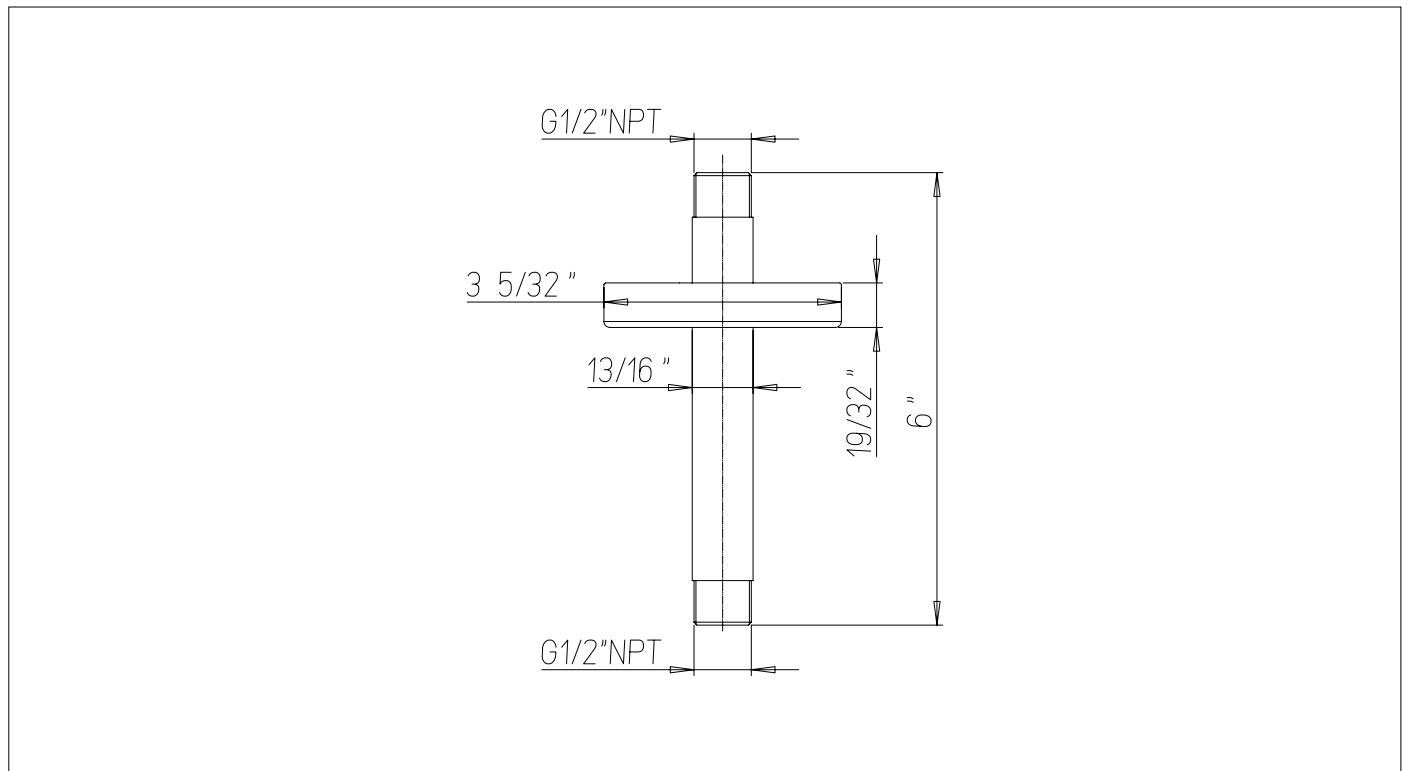

Project _____
 Contractor _____