



# 340

## Hydraulic Excavator

# Technical Specifications

Configurations and features may vary by region. Please consult your Cat® dealer for availability in your area.

### Table of Contents

<b>Specifications</b> .....	<b>2</b>
Engine .....	2
Swing Mechanism .....	2
Weights .....	2
Track .....	2
Drive .....	2
Hydraulic System .....	2
Service Refill Capacities .....	2
Standards .....	2
Sound Performance .....	2
Air Conditioning System .....	2
Operating Weights and Ground Pressures .....	3
Major Component Weights .....	5
Dimensions .....	6
Working Ranges and Forces .....	8
Lift Capacities, Long Wide Undercarriage .....	10
Reach Boom Lift Capacities .....	10
Mass Boom Lift Capacities .....	14
Heavy Duty (HD) Reach Boom Lift Capacities .....	16
Lift Capacities, Long Undercarriage .....	22
Reach Boom Lift Capacities .....	22
Mass Boom Lift Capacities .....	30
HD Reach Boom Lift Capacities .....	32
Bucket Specifications and Compatibility .....	40
Attachments Offering Guide .....	42
<b>Standard and Optional Equipment</b> .....	<b>45</b>
<b>Dealer Installed Kits and Attachments</b> .....	<b>47</b>
<b>Cab Option</b> .....	<b>47</b>
<b>340 Environmental Declaration</b> .....	<b>48</b>

# 340 Hydraulic Excavator Specifications

## Engine

Engine Model	Cat® C9.3B	
Net Power		
ISO 9249	258.3 kW	346 hp
ISO 9249 (DIN)	351 hp (metric)	
Engine Power		
ISO 14396	259.0 kW	347 hp
ISO 14396 (DIN)	352 hp (metric)	
Bore	115 mm	5 in
Stroke	149 mm	6 in
Displacement	9.3 L	568 in <sup>3</sup>

- Emits equivalent to U.S. EPA Tier 3, EU Stage IIIA, and China Nonroad Stage III.
- Recommended for use up to 4500 m (14,760 ft) altitude with engine power derate above 3000 m (9,840 ft).
- Advertised power is tested per the specified standard in effect at the time of manufacture.
- Net power is the power available at the flywheel when the engine is equipped with fan, air intake system, exhaust system, and alternator with engine speed at 1,900 rpm.
- Cat engines are compatible with diesel fuel blended with the following lower-carbon intensity fuels\*\* up to:
  - ✓ 100% biodiesel FAME (fatty acid methyl ester)\*
  - ✓ 100% renewable diesel, HVO (hydrotreated vegetable oil) and GTL (gas-to-liquid) fuels

Refer to guidelines for successful application. Please consult your Cat dealer or “Caterpillar Machine Fluids Recommendations” (SEBU6250) for details.

\*For use of blends higher than 20% biodiesel, consult your Cat dealer.

\*\*Tailpipe greenhouse gas emissions from lower-carbon intensity fuels are essentially the same as traditional fuels.

## Swing Mechanism

Swing Speed*	8.84 rpm	
Maximum Swing Torque	143 kN·m	105,214 lbf·ft

\* For CE-marked machine default value may be set lower.

## Weights

Operating Weight	36 600 kg	80,700 lb
------------------	-----------	-----------

- Long Wide Undercarriage, Reach Boom, R3.2DB (10'6") Stick, Heavy Duty (HD) 2.36 m<sup>3</sup> (3.4 yd<sup>3</sup>) Bucket, 600 mm (24") Triple Grouser Shoes, 7.56 mt (16,700 lb) Counterweight.

## Track

Optional Track Shoes Width	600 mm	24 in
Optional Track Shoes Width	700 mm	28 in
Optional Track Shoes Width	800 mm	31 in
Optional Track Shoes Width	850 mm	33 in
Number of Shoes (each side)	49	
Number of Track Rollers (each side)	8	
Number of Carrier Rollers (each side)	2	

## Drive

Maximum Gradeability	35°/70%	
Maximum Travel Speed	4.7 km/h	2.9 mph
Maximum Drawbar Pull	301.5 kN	67,780 lbf

## Hydraulic System

Main System – Maximum Flow – Implement	560 L/min (280 × 2 pumps)	148 gal/min (74 × 2 pumps)
Maximum Pressure – Equipment – Implement	35 000 kPa	5,076 psi
Maximum Pressure – Equipment – Lift Mode	38 000 kPa	5,511 psi
Maximum Pressure – Travel	35 000 kPa	5,076 psi
Maximum Pressure – Swing	29 400 kPa	4,264 psi
Boom Cylinder – Bore	150 mm	6 in
Boom Cylinder – Stroke	1440 mm	57 in
Stick Cylinder – Bore	170 mm	7 in
Stick Cylinder – Stroke	1738 mm	68 in
DB Bucket Cylinder – Bore	150 mm	6 in
DB Bucket Cylinder – Stroke	1151 mm	45 in
TB Bucket Cylinder – Bore	160 mm	6 in
TB Bucket Cylinder – Stroke	1356 mm	53 in

## Service Refill Capacities

Fuel Tank Capacity	600 L	158.5 gal
Cooling System	40 L	10.5 gal
Engine Oil (with filter)	32 L	8.5 gal
Swing Drive	18 L	4.8 gal
Final Drive (each)	8 L	2.1 gal
Hydraulic System (including tank)	373 L	98.5 gal
Hydraulic Tank (including suction pipe)	161 L	42.5 gal

## Standards

Brakes	ISO 10265:2008
Cab/Operator Protective Guards (OPG) (optional)	ISO 10262:1998 Level II
Cab/Rollover Protective Structure (ROPS)	ISO 12117-2:2008

## Sound Performance

ISO 6395:2008 (external)	106 dB(A)
ISO 6396:2008 (inside cab)	73 dB(A)

- Hearing protection may be needed when operating with an open operator station and cab (when not properly maintained or doors/windows open) for extended periods or in a noisy environment.

## Air Conditioning System

The air conditioning system on this machine contains the fluorinated greenhouse gas refrigerant R134a (Global Warming Potential = 1430). The system contains 1.00 kg of refrigerant which has a CO<sub>2</sub> equivalent of 1.430 metric tonne.

# 340 Hydraulic Excavator Specifications

## Operating Weights and Ground Pressures

	600 mm (24")		600 mm (24")		700 mm (28")	
	Triple Grouser Shoes		Double Grouser Shoes		Triple Grouser Shoes	
	Weight	Ground Pressure	Weight	Ground Pressure	Weight	Ground Pressure
	kg (lb)	kPa (psi)	kg (lb)	kPa (psi)	kg (lb)	kPa (psi)
<b>Base Machine Configurations</b>						
<b>Base Frame with HD Track Rollers and Carrier Rollers for Long Wide Undercarriage</b>						
<b>7.56 mt (16,700 lb) Counterweight + Long Wide Undercarriage Base Machine + Reach Boom</b>						
R3.9 m (12'10") DB Stick, 2.36 m <sup>3</sup> (3.08 yd <sup>3</sup> ) HD Bucket	36 800 (81,100)	68.5 (9.9)	37 600 (82,800)	69.9 (10.1)	37 100 (81,900)	59.3 (8.6)
R3.2 m (10'6") DB Stick, 2.36 m <sup>3</sup> (3.08 yd <sup>3</sup> ) HD Bucket	36 600 (80,700)	68.2 (9.9)	37 400 (82,400)	69.6 (10.1)	37 000 (81,500)	59.0 (8.6)
R2.8 m (9'2") DB Stick, 2.36 m <sup>3</sup> (3.08 yd <sup>3</sup> ) HD Bucket	36 500 (80,500)	68.0 (9.9)	37 300 (82,200)	69.4 (10.1)	36 900 (81,300)	58.9 (8.5)
<b>7.56 mt (16,700 lb) Counterweight + Long Wide Undercarriage Base Machine + Mass Boom</b>						
M2.55 m (8'4") TB Stick, 2.6 m <sup>3</sup> (3.4 yd <sup>3</sup> ) Severe Duty V-Edge (SDV) Bucket	37 800 (83,300)	70.4 (10.2)	38 500 (85,000)	71.8 (10.4)	38 100 (84,100)	60.9 (8.8)
<b>7.56 mt (16,700 lb) Counterweight + Long Wide Undercarriage Base Machine + HD Reach Boom</b>						
HD R3.9 m (12'10") DB Stick, 2.36 m <sup>3</sup> (3.08 yd <sup>3</sup> ) HD Bucket	37 000 (81,700)	69.0 (10.0)	37 800 (83,300)	70.4 (10.2)	37 400 (82,400)	59.7 (8.7)
HD R3.2 m (10'6") DB Stick, 2.36 m <sup>3</sup> (3.08 yd <sup>3</sup> ) HD Bucket	36 900 (81,300)	68.7 (10.0)	37 600 (83,000)	70.1 (10.2)	37 200 (82,100)	59.4 (8.6)
HD R2.8 m (9'2") DB Stick, 2.36 m <sup>3</sup> (3.08 yd <sup>3</sup> ) HD Bucket	36 800 (81,000)	68.5 (9.9)	37 500 (82,700)	69.9 (10.1)	37 100 (81,800)	59.3 (8.6)
<b>Base Frame with HD Track Rollers and Carrier Rollers for Long Undercarriage</b>						
<b>7.56 mt (16,700 lb) Counterweight + Long Undercarriage Base Machine + Reach Boom</b>						
R3.9 m (12'10") DB Stick, 2.36 m <sup>3</sup> (3.08 yd <sup>3</sup> ) HD Bucket	36 600 (80,700)	68.2 (9.9)	37 400 (82,400)	69.6 (10.1)	37 000 (81,500)	59.0 (8.6)
R3.2 m (10'6") DB Stick, 2.36 m <sup>3</sup> (3.08 yd <sup>3</sup> ) HD Bucket	36 400 (80,300)	67.9 (9.8)	37 200 (82,000)	69.3 (10.0)	36 800 (81,100)	58.7 (8.5)
R2.8 m (9'2") DB Stick, 2.36 m <sup>3</sup> (3.08 yd <sup>3</sup> ) HD Bucket	36 300 (80,100)	67.7 (9.8)	37 100 (81,800)	69.1 (10.0)	36 700 (80,900)	58.6 (8.5)
<b>7.56 mt (16,700 lb) Counterweight + Long Undercarriage Base Machine + Mass Boom</b>						
M2.55 m (8'4") TB Stick, 2.6 m <sup>3</sup> (3.4 yd <sup>3</sup> ) SDV Bucket	37 600 (82,900)	70.0 (10.2)	38 400 (84,500)	71.4 (10.4)	37 900 (83,700)	60.6 (8.8)
<b>7.56 mt (16,700 lb) Counterweight + Long Undercarriage Base Machine + HD Reach Boom</b>						
HD R3.9 m (12'10") DB Stick, 2.36 m <sup>3</sup> (3.08 yd <sup>3</sup> ) HD Bucket	36 900 (81,200)	68.6 (10.0)	37 600 (82,900)	70.1 (10.2)	37 200 (82,000)	59.4 (8.6)
HD R3.2 m (10'6") DB Stick, 2.36 m <sup>3</sup> (3.08 yd <sup>3</sup> ) HD Bucket	36 700 (80,900)	68.3 (9.9)	37 400 (82,500)	69.7 (10.1)	37 000 (81,600)	59.1 (8.6)
HD R2.8 m (9'2") DB Stick, 2.36 m <sup>3</sup> (3.08 yd <sup>3</sup> ) HD Bucket	36 600 (80,600)	68.1 (9.9)	37 300 (82,300)	69.5 (10.1)	36 900 (81,400)	59.0 (8.6)

All operating weights include a 90% fuel tank with 75 kg (165 lb) operator.

(continued on next page)

# 340 Hydraulic Excavator Specifications

## Operating Weights and Ground Pressures *(continued)*

Base Machine Configurations	800 mm (31") Triple Grouser Shoes		850 mm (33") Triple Grouser Shoes	
	Weight kg (lb)	Ground Pressure kPa (psi)	Weight kg (lb)	Ground Pressure kPa (psi)
<b>Base Frame with HD Track Rollers and Carrier Rollers for Long Undercarriage</b>				
<b>7.56 mt (16,700 lb) Counterweight + Long Undercarriage Base Machine + Reach Boom</b>				
R3.9 m (12'10") DB Stick, 2.36 m <sup>3</sup> (3.08 yd <sup>3</sup> ) HD Bucket	37 600 (82,900)	52.5 (7.6)	37 800 (83,400)	49.7 (7.2)
R3.2 m (10'6") DB Stick, 2.36 m <sup>3</sup> (3.08 yd <sup>3</sup> ) HD Bucket	37 400 (82,500)	52.3 (7.6)	37 600 (83,000)	49.5 (7.2)
R2.8 m (9'2") DB Stick, 2.36 m <sup>3</sup> (3.08 yd <sup>3</sup> ) HD Bucket	37 300 (82,300)	52.1 (7.6)	37 500 (82,800)	49.4 (7.2)
<b>7.56 mt (16,700 lb) Counterweight + Long Undercarriage Base Machine + Mass Boom</b>				
M2.55 m (8'4") TB Stick, 2.6 m <sup>3</sup> (3.4 yd <sup>3</sup> ) SDV Bucket	38 600 (85,100)	53.9 (7.8)	38 800 (85,500)	51.0 (7.4)
<b>7.56 mt (16,700 lb) Counterweight + Long Undercarriage Base Machine + HD Reach Boom</b>				
HD R3.9 m (12'10") DB Stick, 2.36 m <sup>3</sup> (3.08 yd <sup>3</sup> ) HD Bucket	37 900 (83,500)	52.9 (7.7)	38 100 (83,900)	50.1 (7.3)
HD R3.2 m (10'6") DB Stick, 2.36 m <sup>3</sup> (3.08 yd <sup>3</sup> ) HD Bucket	37 700 (83,100)	52.6 (7.6)	37 900 (83,500)	49.8 (7.2)
HD R2.8 m (9'2") DB Stick, 2.36 m <sup>3</sup> (3.08 yd <sup>3</sup> ) HD Bucket	37 600 (82,800)	52.5 (7.6)	37 800 (83,300)	49.7 (7.2)

All operating weights include a 90% fuel tank with 75 kg (165 lb) operator.

# 340 Hydraulic Excavator Specifications

## Major Component Weights

	kg	lb
Base Machine with 7.56 mt (16,700 lb) Counterweight, HD Swing Frame, Base Frame with HD Track Rollers and Carrier Rollers for Long Wide Undercarriage	24 970	55,050
Base Machine with 7.56 mt (16,700 lb) Counterweight, HD Swing Frame, Base Frame with HD Track Rollers and Carrier Rollers for Long Undercarriage	24 780	54,640
Track Shoes:		
600 mm (24") Width, 11 mm (0.43") Thick, Triple Grouser Track Shoes	4090	9,020
600 mm (24") Width, 15.5 mm (0.61") Thick, Double Grouser Track Shoes	4850	10,700
700 mm (28") Width, 11 mm (0.43") Thick, Triple Grouser Track Shoes	4450	9,800
800 mm (31") Width, 13 mm (0.51") Thick, Triple Grouser Track Shoes	5100	11,230
850 mm (33") Width, 13 mm (0.51") Thick, Triple Grouser Track Shoes	5300	11,690
Two Boom Cylinders	670	1,470
Weight of 90% Fuel Tank and 75 kg (165 lb) Operator	550	1,210
Counterweight:		
7.56 mt (16,700 lb) Counterweight	7560	16,670
Swing Frame:		
HD Swing Frame	3260	7,180
Undercarriage:		
Base Frame with HD Track Rollers and Carrier Rollers for Long Wide Undercarriage	8480	18,700
Base Frame with HD Track Rollers and Carrier Rollers for Long Undercarriage	8290	18,280
Booms (including lines, pins, stick cylinder):		
Reach Boom 6.5 m (21'4")	3280	7,230
Mass Boom 6.18 m (20'3")	3500	7,710
HD Reach Boom 6.5 m (21'4")	3480	7,670
Sticks (including lines, pins, bucket cylinder, bucket linkage):		
Reach Stick R2.8DB (9'2")	1760	3,870
Reach Stick R3.2DB (10'6")	1860	4,100
Reach Stick R3.9DB (12'10")	2040	4,490
Mass Stick M2.55TB (8'4")	2120	4,680
HD Reach Stick R2.8DB (9'2")	1810	4,000
HD Reach Stick R3.2DB (10'6")	1920	4,220
HD Reach Stick R3.9DB (12'10")	2090	4,610
Buckets (without linkage):		
2.36 m <sup>3</sup> (3.08 yd <sup>3</sup> ) HD	1860	4,110
2.6 m <sup>3</sup> (3.4 yd <sup>3</sup> ) SDV	2550	5,620
Quick Coupler (QC):		
Pin Grabber QC	700	1,550

# 340 Hydraulic Excavator Specifications

## Dimensions

All dimensions are approximate and may vary depending on bucket selection.

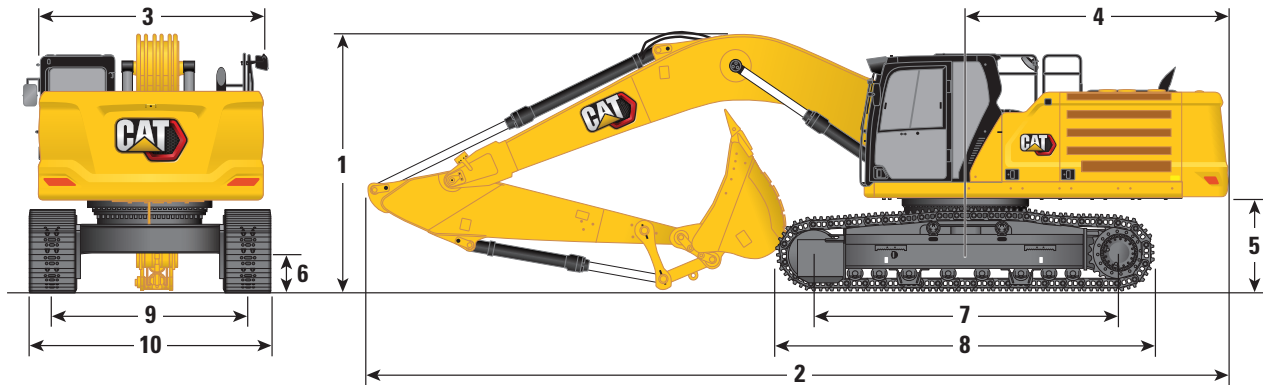

### Undercarriage Options

### Long Wide Undercarriage

### Boom Options

### Reach Boom 6.5 m (21'4")

### Mass Boom 6.18 m (20'3")

### Stick Options

### Reach Stick

### Mass Stick

### R3.9DB (12'10")

### R3.2DB (10'6")

### R2.8DB (9'2")

### M2.55TB (8'4")

### 1 Machine Height:

Cab Height	3180 mm	10'5"	3180 mm	10'5"	3180 mm	10'5"	3180 mm	10'5"
OPG Height	3330 mm	10'11"	3330 mm	10'11"	3330 mm	10'11"	3330 mm	10'11"
Guardrails/Handrails Height	3180 mm	10'5"	3180 mm	10'5"	3180 mm	10'5"	3180 mm	10'5"
With Boom/Stick/Bucket Installed	3660 mm	12'0"	3480 mm	11'5"	3670 mm	12'0"	3610 mm	11'10"
With Boom/Stick Installed	3560 mm	11'8"	3330 mm	10'11"	3450 mm	11'4"	3410 mm	11'2"
With Boom Installed	2880 mm	9'5"	2880 mm	9'5"	2880 mm	9'5"	2830 mm	9'3"
With Boom/Stick/Bucket Installed (with auxiliary lines)	3710 mm	12'2"	3530 mm	11'7"	3680 mm	12'1"	3610 mm	11'10"
With Boom/Stick Installed (with auxiliary lines)	3620 mm	11'11"	3410 mm	11'2"	3500 mm	11'6"	3420 mm	11'3"
With Boom Installed (with auxiliary lines)	2970 mm	9'9"	2970 mm	9'9"	2970 mm	9'9"	2900 mm	9'6"

### 2 Machine Length:

With Boom/Stick/Bucket Installed	11 180 mm	36'8"	11 160 mm	36'7"	11 200 mm	36'9"	10 870 mm	35'8"
With Boom/Stick Installed	11 170 mm	36'8"	11 120 mm	36'6"	11 170 mm	36'8"	10 830 mm	35'6"
With Boom Installed	9960 mm	32'8"	9960 mm	32'8"	9960 mm	32'8"	9640 mm	31'8"
With Boom/Stick/Bucket Installed (with auxiliary lines)	11 180 mm	36'8"	11 160 mm	36'7"	11 200 mm	36'9"	10 870 mm	35'8"
With Boom/Stick Installed (with auxiliary lines)	11 170 mm	36'8"	11 120 mm	36'6"	11 170 mm	36'8"	10 830 mm	35'6"
With Boom Installed (with auxiliary lines)	10 010 mm	32'10"	10 010 mm	32'10"	10 010 mm	32'10"	9 640 mm	31'8"

### 3 Upperframe Width without Walkways

2970 mm	9'9"	2970 mm	9'9"	2970 mm	9'9"	2970 mm	9'9"
---------	------	---------	------	---------	------	---------	------

### 4 Tail Swing Radius

3530 mm	11'7"	3530 mm	11'7"	3530 mm	11'7"	3530 mm	11'7"
---------	-------	---------	-------	---------	-------	---------	-------

### 5 Counterweight Clearance

1260 mm	4'2"	1260 mm	4'2"	1260 mm	4'2"	1260 mm	4'2"
---------	------	---------	------	---------	------	---------	------

### 6 Ground Clearance

510 mm	1'8"	510 mm	1'8"	510 mm	1'8"	510 mm	1'8"
--------	------	--------	------	--------	------	--------	------

### 7 Track Length – Length to Center of Rollers

4040 mm	13'3"	4040 mm	13'3"	4040 mm	13'3"	4040 mm	13'3"
---------	-------	---------	-------	---------	-------	---------	-------

### 8 Track Length

5030 mm	16'6"	5030 mm	16'6"	5030 mm	16'6"	5030 mm	16'6"
---------	-------	---------	-------	---------	-------	---------	-------

### 9 Track Gauge – Extended

2740 mm	9'0"	2740 mm	9'0"	2740 mm	9'0"	2740 mm	9'0"
---------	------	---------	------	---------	------	---------	------

### 10 Track Width/Undercarriage Width (with steps):

600 mm (24") Shoes	3340 mm	10'11"	3340 mm	10'11"	3340 mm	10'11"	3340 mm	10'11"
700 mm (28") Shoes	3440 mm	11'3"	3440 mm	11'3"	3440 mm	11'3"	3440 mm	11'3"
800 mm (31") Shoes	3540 mm	11'7"	3540 mm	11'7"	3540 mm	11'7"	3540 mm	11'7"
850 mm (33") Shoes	3590 mm	11'9"	3590 mm	11'9"	3590 mm	11'9"	3590 mm	11'9"

### Bucket Type

### HD

### HD

### HD

### SDV

Bucket Capacity	2.36 m <sup>3</sup>	3.08 yd <sup>3</sup>	2.36 m <sup>3</sup>	3.08 yd <sup>3</sup>	2.36 m <sup>3</sup>	3.08 yd <sup>3</sup>	2.60 m <sup>3</sup>	3.40 yd <sup>3</sup>
-----------------	---------------------	----------------------	---------------------	----------------------	---------------------	----------------------	---------------------	----------------------

Bucket Tip Radius	1800 mm	5.9 ft	1800 mm	5.9 ft	1800 mm	5.9 ft	1910 mm	6.3 ft
-------------------	---------	--------	---------	--------	---------	--------	---------	--------

(continued on next page)

# 340 Hydraulic Excavator Specifications

## Dimensions (continued)

All dimensions are approximate and may vary depending on bucket selection.

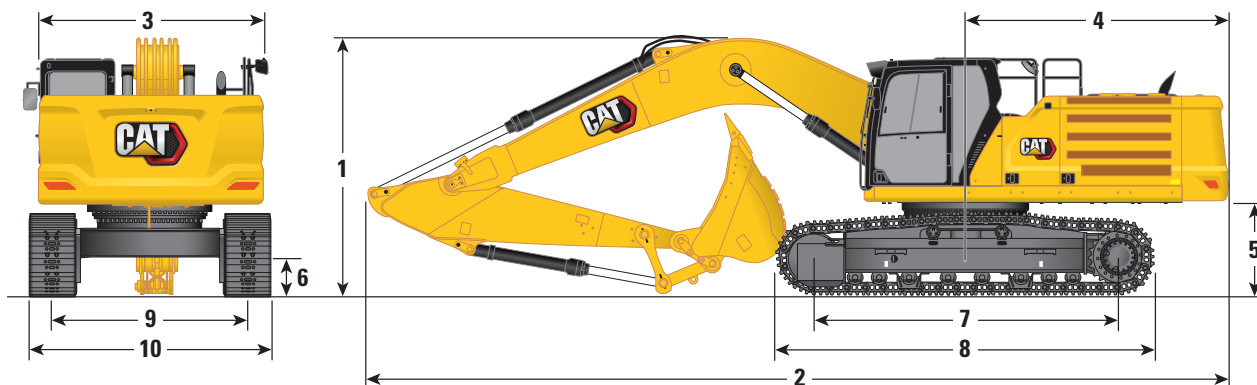

### Undercarriage Options

### Long Narrow Undercarriage

#### Boom Options

Reach Boom  
6.5 m (21'4")

Mass Boom  
6.18 m (20'3")

#### Stick Options

Reach Stick

Mass Stick

R3.9DB (12'10")

R3.2DB (10'6")

R2.8DB (9'2")

M2.55TB (8'4")

#### 1 Machine Height:

Cab Height	3170 mm	10'5"	3170 mm	10'5"	3170 mm	10'5"	3170 mm	10'5"
OPG Height	3310 mm	10'10"	3310 mm	10'10"	3310 mm	10'10"	3310 mm	10'10"
Guardrails/Handrails Height	3160 mm	10'4"	3160 mm	10'4"	3160 mm	10'4"	3160 mm	10'4"
With Boom/Stick/Bucket Installed	3670 mm	12'0"	3480 mm	11'5"	3660 mm	12'0"	3600 mm	11'10"
With Boom/Stick Installed	3560 mm	11'8"	3330 mm	10'11"	3450 mm	11'4"	3400 mm	11'2"
With Boom Installed	2880 mm	9'5"	2880 mm	9'5"	2880 mm	9'5"	2830 mm	9'3"
With Boom/Stick/Bucket Installed (with auxiliary lines)	3710 mm	12'2"	3530 mm	11'7"	3680 mm	12'1"	3600 mm	11'10"
With Boom/Stick Installed (with auxiliary lines)	3620 mm	11'11"	3400 mm	11'2"	3500 mm	11'6"	3420 mm	11'3"
With Boom Installed (with auxiliary lines)	2970 mm	9'9"	2970 mm	9'9"	2970 mm	9'9"	2900 mm	9'6"

#### 2 Machine Length:

With Boom/Stick/Bucket Installed	11 180 mm	36'8"	11 160 mm	36'7"	11 200 mm	36'9"	10 880 mm	35'8"
With Boom/Stick Installed	11 170 mm	36'8"	11 120 mm	36'6"	11 170 mm	36'8"	10 830 mm	35'6"
With Boom Installed	9960 mm	32'8"	9960 mm	32'8"	9960 mm	32'8"	9640 mm	31'8"
With Boom/Stick/Bucket Installed (with auxiliary lines)	11 180 mm	36'8"	11 160 mm	36'7"	11 200 mm	36'9"	10 880 mm	35'8"
With Boom/Stick Installed (with auxiliary lines)	11 170 mm	36'8"	11 120 mm	36'6"	11 170 mm	36'8"	10 830 mm	35'6"
With Boom Installed (with auxiliary lines)	10 010 mm	32'10"	10 010 mm	32'10"	10 010 mm	32'10"	9640 mm	31'8"

#### 3 Upperframe Width without Walkways

2970 mm	9'9"	2970 mm	9'9"	2970 mm	9'9"	2970 mm	9'9"
---------	------	---------	------	---------	------	---------	------

#### 4 Tail Swing Radius

3530 mm	11'7"	3530 mm	11'7"	3530 mm	11'7"	3530 mm	11'7"
---------	-------	---------	-------	---------	-------	---------	-------

#### 5 Counterweight Clearance

1250 mm	4'1"	1250 mm	4'1"	1250 mm	4'1"	1250 mm	4'1"
---------	------	---------	------	---------	------	---------	------

#### 6 Ground Clearance

510 mm	1'8"	510 mm	1'8"	510 mm	1'8"	510 mm	1'8"
--------	------	--------	------	--------	------	--------	------

#### 7 Track Length – Length to Center of Rollers

4040 mm	13'3"	4040 mm	13'3"	4040 mm	13'3"	4040 mm	13'3"
---------	-------	---------	-------	---------	-------	---------	-------

#### 8 Track Length

5030 mm	16'6"	5030 mm	16'6"	5030 mm	16'6"	5030 mm	16'6"
---------	-------	---------	-------	---------	-------	---------	-------

#### 9 Track Gauge – Extended

2590 mm	8'6"	2590 mm	8'6"	2590 mm	8'6"	2590 mm	8'6"
---------	------	---------	------	---------	------	---------	------

#### 10 Track Width/Undercarriage Width (with steps):

600 mm (24") Shoes	3190 mm	10'6"	3190 mm	10'6"	3190 mm	10'6"	3190 mm	10'6"
700 mm (28") Shoes	3290 mm	10'10"	3290 mm	10'10"	3290 mm	10'10"	3290 mm	10'10"
800 mm (31") Shoes	3390 mm	11'1"	3390 mm	11'1"	3390 mm	11'1"	3390 mm	11'1"
850 mm (33") Shoes	3440 mm	11'3"	3440 mm	11'3"	3440 mm	11'3"	3440 mm	11'3"

#### Bucket Type

HD

HD

HD

SDV

#### Bucket Capacity

2.36 m <sup>3</sup>	3.08 yd <sup>3</sup>	2.36 m <sup>3</sup>	3.08 yd <sup>3</sup>	2.36 m <sup>3</sup>	3.08 yd <sup>3</sup>	2.60 m <sup>3</sup>	3.40 yd <sup>3</sup>
---------------------	----------------------	---------------------	----------------------	---------------------	----------------------	---------------------	----------------------

#### Bucket Tip Radius

1800 mm	5.9 ft	1800 mm	5.9 ft	1800 mm	5.9 ft	1910 mm	6.3 ft
---------	--------	---------	--------	---------	--------	---------	--------



# 340 Hydraulic Excavator Specifications

## Working Ranges and Forces

All dimensions are approximate and may vary depending on bucket selection.

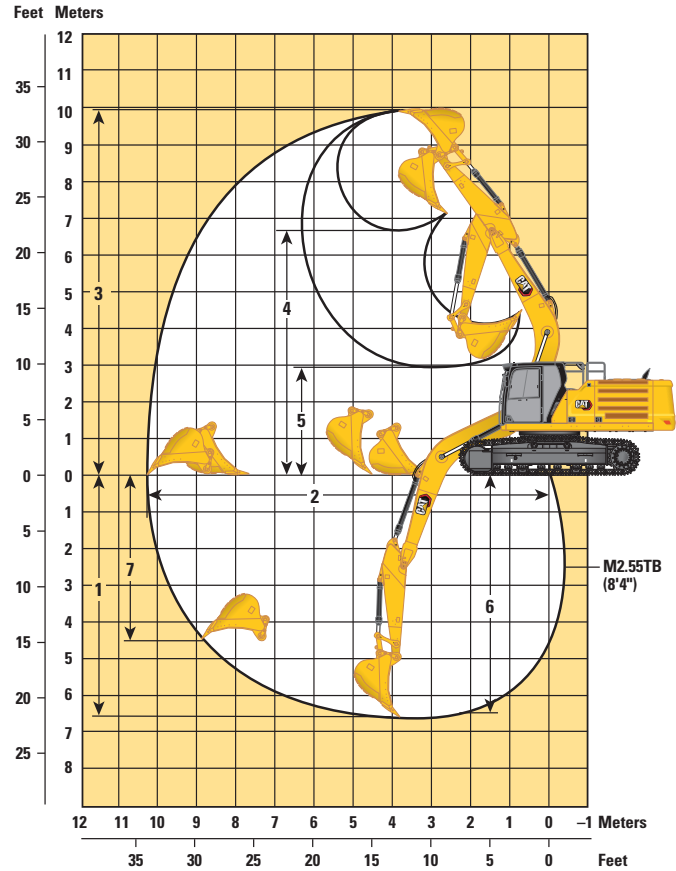
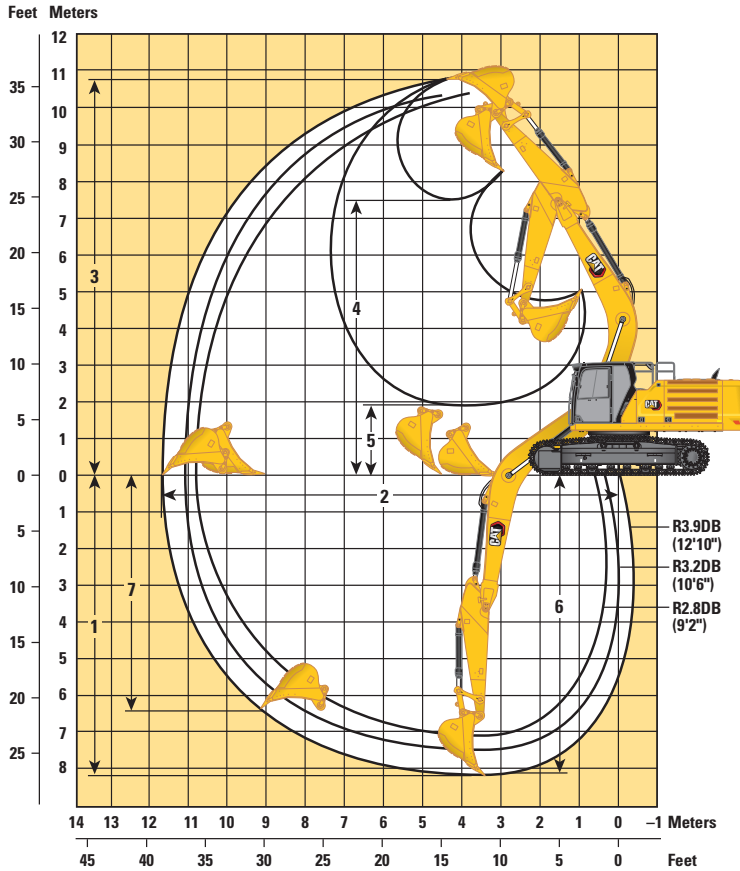

### Undercarriage Options

#### Boom Options

#### Stick Options

### Long Wide Undercarriage

#### Reach Boom 6.5 m (21'4")

#### Mass Boom 6.18 m (20'3")

#### Reach Stick

#### Mass Stick

	R3.9DB (12'10")		R3.2DB (10'6")		R2.8DB (9'2")		M2.55TB (8'4")	
	mm	ft/in	mm	ft/in	mm	ft/in	mm	ft/in
1 Maximum Digging Depth	8210	26'11"	7510	24'8"	7110	23'4"	6650	21'10"
2 Maximum Reach at Ground Line	11 760	38'7"	11 060	36'3"	10 760	35'4"	10 280	33'9"
3 Maximum Cutting Height	10 740	35'3"	10 320	33'10"	10 380	34'1"	9990	32'9"
4 Maximum Loading Height	7470	24'6"	7080	23'3"	7080	23'3"	6620	21'9"
5 Minimum Loading Height	1890	6'2"	2590	8'6"	2990	9'10"	2920	9'7"
6 Maximum Depth Cut for 2440 mm (8'0") Level Bottom	8080	26'6"	7360	24'2"	6950	22'10"	6480	21'3"
7 Maximum Vertical Wall Digging Depth	6420	21'1"	5620	18'5"	5580	18'4"	4480	14'8"
Bucket Digging Force (ISO)	210 kN	47,190 lbf	210 kN	47,190 lbf	210 kN	47,190 lbf	265 kN	59,570 lbf
Stick Digging Force (ISO)	145 kN	32,480 lbf	166 kN	37,340 lbf	185 kN	41,540 lbf	191 kN	42,880 lbf
Bucket Digging Force (ISO) – Cat Dig Boost	228 kN	51,230 lbf	228 kN	51,230 lbf	228 kN	51,230 lbf	288 kN	64,670 lbf
Stick Digging Force (ISO) – Cat Dig Boost	157 kN	35,270 lbf	180 kN	40,540 lbf	201 kN	45,110 lbf	207 kN	46,560 lbf
Bucket Type	HD		HD		HD		SDV	
Bucket Capacity	2.36 m <sup>3</sup>	3.08 yd <sup>3</sup>	2.36 m <sup>3</sup>	3.08 yd <sup>3</sup>	2.36 m <sup>3</sup>	3.08 yd <sup>3</sup>	2.60 m <sup>3</sup>	3.40 yd <sup>3</sup>
Bucket Tip Radius	1800 mm	5.9 ft	1800 mm	5.9 ft	1800 mm	5.9 ft	1910 mm	6.3 ft

(continued on next page)



# 340 Hydraulic Excavator Specifications

## Working Ranges and Forces (continued)

All dimensions are approximate and may vary depending on bucket selection.

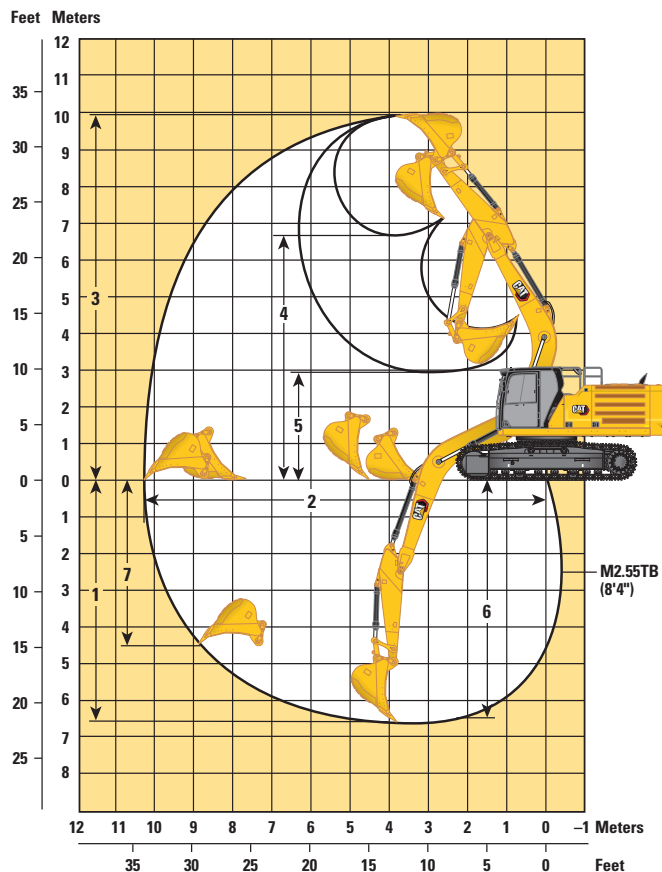
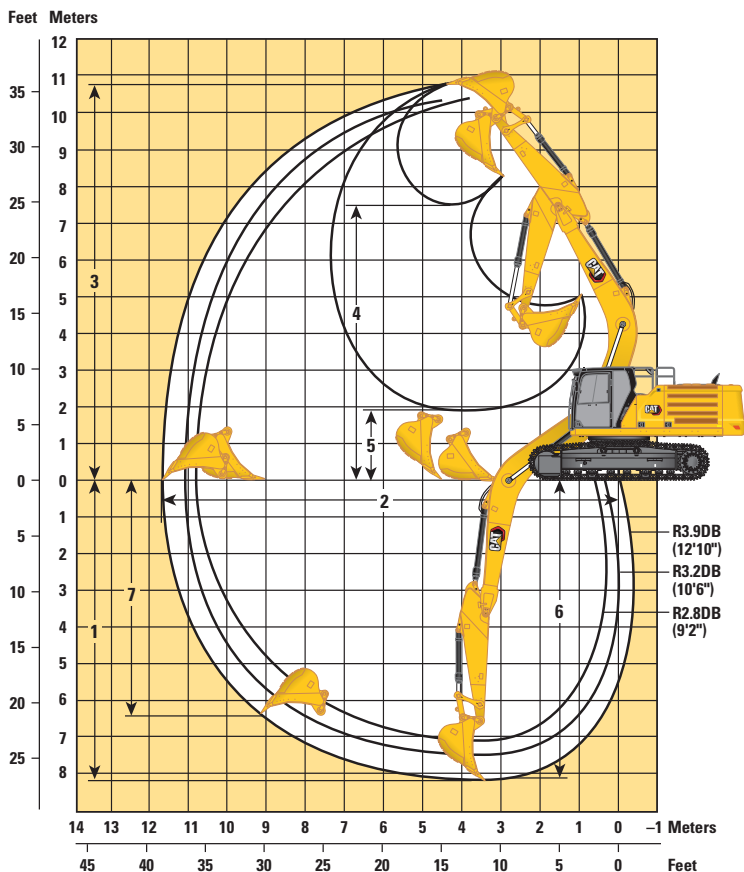

### Undercarriage Options

#### Boom Options

#### Stick Options

### Long Narrow Undercarriage

#### Reach Boom 6.5 m (21'4")

#### Mass Boom 6.18 m (20'3")

#### Reach Stick

#### Mass Stick

	R3.9DB (12'10")		R3.2DB (10'6")		R2.8DB (9'2")		M2.55TB (8'4")	
	mm	ft/in	mm	ft/in	mm	ft/in	mm	ft/in
1 Maximum Digging Depth	8230	27'0"	7530	24'8"	7130	23'5"	6670	21'11"
2 Maximum Reach at Ground Line	11 760	38'7"	11 060	36'3"	10 760	35'4"	10 280	33'9"
3 Maximum Cutting Height	10 720	35'2"	10 300	33'10"	10 370	34'0"	9970	32'9"
4 Maximum Loading Height	7460	24'6"	7070	23'2"	7070	23'2"	6600	21'8"
5 Minimum Loading Height	1870	6'2"	2570	8'5"	2970	9'9"	2910	9'7"
6 Maximum Depth Cut for 2440 mm (8'0") Level Bottom	8100	26'7"	7370	24'2"	6960	22'10"	6490	21'4"
7 Maximum Vertical Wall Digging Depth	6440	21'2"	5630	18'6"	5600	18'4"	4490	14'9"
Bucket Digging Force (ISO)	210 kN	47,190 lbf	210 kN	47,190 lbf	210 kN	47,190 lbf	265 kN	59,570 lbf
Stick Digging Force (ISO)	145 kN	32,480 lbf	166 kN	37,340 lbf	185 kN	41,540 lbf	191 kN	42,880 lbf
Bucket Digging Force (ISO) – Cat Dig Boost	228 kN	51,230 lbf	228 kN	51,230 lbf	228 kN	51,230 lbf	288 kN	64,670 lbf
Stick Digging Force (ISO) – Cat Dig Boost	157 kN	35,270 lbf	180 kN	40,540 lbf	201 kN	45,110 lbf	207 kN	46,560 lbf
Bucket Type	HD		HD		HD		SDV	
Bucket Capacity	2.36 m <sup>3</sup>	3.08 yd <sup>3</sup>	2.36 m <sup>3</sup>	3.08 yd <sup>3</sup>	2.36 m <sup>3</sup>	3.08 yd <sup>3</sup>	2.60 m <sup>3</sup>	3.40 yd <sup>3</sup>
Bucket Tip Radius	1800 mm	5.9 ft	1800 mm	5.9 ft	1800 mm	5.9 ft	1910 mm	6.3 ft

# 340 Hydraulic Excavator Specifications

## Reach Boom Lift Capacities – Counterweight: 7.56 mt (16,700 lb) – without Bucket, Heavy Lift: On

Long Wide Undercarriage

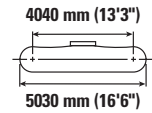
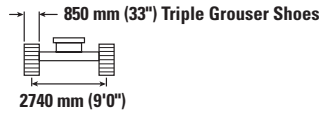

		3000 mm/10'0"		4500 mm/15'0"		6000 mm/20'0"		7500 mm/25'0"		9000 mm/30'0"		mm ft/in		
7500 mm 25'0"	kg lb							*8750 *16,350	8650 *16,350			*7350 *16,300	*7350 *16,300	7720 25'0"
6000 mm 20'0"	kg lb							*8900 *19,450	8600 18,450			*7150 *15,800	6850 15,250	8590 28'0"
4500 mm 15'0"	kg lb			*13 550 *29,100	*13 550 *29,100	*10 900 *23,600	*10 900 *23,600	*9550 *20,800	8350 18,000	*8500	6300	*7200 *15,900	6150 13,550	9140 29'10"
3000 mm 10'0"	kg lb			*17 150 *36,850	16 900 36,450	*12 600 *27,250	11 100 24,000	*10 450 *22,650	8050 17,350	8900	6150	*7500 *16,500	5750 12,650	9410 30'10"
1500 mm 5'0"	kg lb			*19 750 *42,600	15 950 34,400	*14 100 *30,550	10 600 22,900	*11 300 *24,450	7800 16,750	8750	6000	*8050 *17,650	5600 12,350	9440 30'11"
0 mm 0'0"	kg lb			*20 600 *44,600	15 550 33,500	*15 000 *32,450	10 300 22,200	11 200 24,150	7600 16,350	8650	5900	8350 18,400	5750 12,600	9220 30'2"
-1500 mm -5'0"	kg lb	*14 150 *32,000	*14 150 *32,000	*20 200 *43,750	15 500 33,300	*15 100 *32,650	10 150 21,900	11 100 23,950	7500 16,150			9000 19,800	6150 13,500	8740 28'7"
-3000 mm -10'0"	kg lb	*22 250 *50,400	*22 250 *50,400	*18 700 *40,550	15 600 33,550	*14 250 *30,800	10 200 21,950	*11 050 *23,700	7550 16,250			*10 100 *22,300	7000 15,500	7950 25'11"
-4500 mm -15'0"	kg lb	*21 050 *45,350	*21 050 *45,350	*15 850 *34,050	15 500 33,050	*12 000 *25,550	10 400 22,500					*10 200 *22,400	8950 20,000	6740 21'10"

## Reach Boom Lift Capacities – Counterweight: 7.56 mt (16,700 lb) – without Bucket, Heavy Lift: On

Long Wide Undercarriage

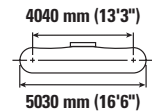
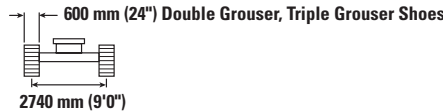

		3000 mm/10'0"		4500 mm/15'0"		6000 mm/20'0"		7500 mm/25'0"		9000 mm/30'0"		mm ft/in		
7500 mm 25'0"	kg lb							*8750 *16,350	8450 *16,350			*7350 *16,300	*7350 *16,300	7720 25'0"
6000 mm 20'0"	kg lb							*8900 *19,450	8350 17,950			*7150 *15,800	6700 14,850	8590 28'0"
4500 mm 15'0"	kg lb			*13 550 *29,100	*13 550 *29,100	*10 900 *23,600	*10 900 *23,600	*9550 *20,800	8150 17,500	*8500	6100	*7200 *15,900	5950 13,150	9140 29'10"
3000 mm 10'0"	kg lb			*17 150 *36,850	16 450 35,500	*12 600 *27,250	10 850 23,350	*10 450 *22,650	7850 16,900	8650	6000	*7500 *16,500	5600 12,300	9410 30'10"
1500 mm 5'0"	kg lb			*19 750 *42,600	15 550 33,450	*14 100 *30,550	10 350 22,250	11 100 23,900	7550 16,300	8500	5850	7900 17,450	5450 12,000	9440 30'11"
0 mm 0'0"	kg lb			*20 600 *44,600	15 150 32,550	*15 000 *32,450	10 000 21,550	10 900 23,450	7350 15,850	8400	5750	8100 17,850	5550 12,250	9220 30'2"
-1500 mm -5'0"	kg lb	*14 150 *32,000	*14 150 *32,000	*20 200 *43,750	15 050 32,350	15 050 32,350	9850 21,250	10 800 23,200	7250 15,650			8700 19,200	5950 13,100	8740 28'7"
-3000 mm -10'0"	kg lb	*22 250 *50,400	*22 250 *50,400	*18 700 *40,550	15 150 32,600	*14 250 *30,800	9900 21,300	10 850 23,350	7300 15,800			10 000 22,150	6800 15,050	7950 25'11"
-4500 mm -15'0"	kg lb	*21 050 *45,350	*21 050 *45,350	*15 850 *34,050	15 500 33,300	*12 000 *25,550	10 100 21,850					*10 200 *22,400	8700 19,450	6740 21'10"



ISO 10567:2007



\* Indicates that the load is limited by hydraulic lifting capacity rather than tipping load. The above loads are in compliance with hydraulic excavator lift capacity standard ISO 10567:2007. They do not exceed 87% of hydraulic lifting capacity or 75% of tipping load. Weight of all lifting accessories must be deducted from the above lifting capacities. Lifting capacities are based on the machine standing on a firm, uniform supporting surface. The use of a work tool attachment point to handle/lift objects, could affect the machine lift performance.

Lift capacity stays with ±5% for all available track shoes.

Always refer to the appropriate Operation and Maintenance Manual for specific product information.

# 340 Hydraulic Excavator Specifications

## Reach Boom Lift Capacities – Counterweight: 7.56 mt (16,700 lb) – without Bucket, Heavy Lift: On

Long Wide Undercarriage

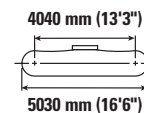
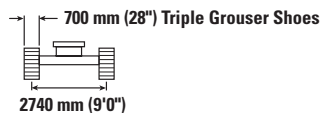

		3000 mm/10'0"		4500 mm/15'0"		6000 mm/20'0"		7500 mm/25'0"		9000 mm/30'0"		mm ft/in		
7500 mm 25'0"	kg lb							*8750 *16,350	8500 *16,350			*7350 *16,300	*7350 *16,300	7720 25'0"
6000 mm 20'0"	kg lb							*8900 *19,450	8450 18,100			*7150 *15,800	6750 14,950	8590 28'0"
4500 mm 15'0"	kg lb			*13 550 *29,100	*13 550 *29,100	*10 900 *23,600	*10 900 *23,600	*9550 *20,800	8200 17,650	*8500	6150	*7200 *15,900	6000 13,300	9140 29'10"
3000 mm 10'0"	kg lb			*17 150 *36,850	16 600 35,800	*12 600 *27,250	10 900 23,550	*10 450 *22,650	7900 17,050	8700	6050	*7500 *16,500	5650 12,400	9410 30'10"
1500 mm 5'0"	kg lb			*19 750 *42,600	15 650 33,700	*14 100 *30,550	10 400 22,450	11 200 24,100	7650 16,450	8550	5900	8000 17,600	5500 12,100	9440 30'11"
0 mm 0'0"	kg lb			*20 600 *44,600	15 250 32,800	*15 000 *32,450	10 100 21,750	11 000 23,650	7450 16,000	8450	5800	8200 18,000	5600 12,350	9220 30'2"
-1500 mm -5'0"	kg lb	*14 150 *32,000	*14 150 *32,000	*20 200 *43,750	15 150 32,600	*15 100 32,650	9950 21,450	10 900 23,400	7350 15,800			8800 19,400	6000 13,250	8740 28'7"
-3000 mm -10'0"	kg lb	*22 250 *50,400	*22 250 *50,400	*18 700 *40,550	15 300 32,850	*14 250 *30,800	10 000 21,500	10 950 23,550	7400 15,900			10 100 *22,300	6850 15,200	7950 25'11"
-4500 mm -15'0"	kg lb	*21 050 *45,350	*21 050 *45,350	*15 850 *34,050	15 600 33,600	*12 000 *25,550	10 200 22,050					*10 200 *22,400	8750 19,600	6740 21'10"

## Reach Boom Lift Capacities – Counterweight: 7.56 mt (16,700 lb) – without Bucket, Heavy Lift: On

Long Wide Undercarriage

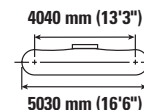
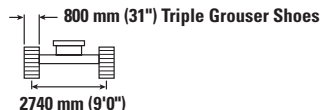
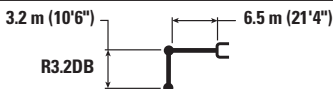

		3000 mm/10'0"		4500 mm/15'0"		6000 mm/20'0"		7500 mm/25'0"		9000 mm/30'0"		mm ft/in		
7500 mm 25'0"	kg lb							*8750 *16,350	8600 *16,350			*7350 *16,300	*7350 *16,300	7720 25'0"
6000 mm 20'0"	kg lb							*8900 *19,450	8550 18,350			*7150 *15,800	6850 15,200	8590 28'0"
4500 mm 15'0"	kg lb			*13 550 *29,100	*13 550 *29,100	*10 900 *23,600	*10 900 *23,600	*9550 *20,800	8300 17,900	*8500	6250	*7200 *15,900	6100 13,500	9140 29'10"
3000 mm 10'0"	kg lb			*17 150 *36,850	16 850 36,300	*12 600 *27,250	11 050 23,850	*10 450 *22,650	8050 17,300	8850	6150	*7500 *16,500	5700 12,600	9410 30'10"
1500 mm 5'0"	kg lb			*19 750 *42,600	15 900 34,250	*14 100 *30,550	10 550 22,800	*11 300 *24,450	7750 16,700	8700	6000	*8050 *17,650	5600 12,300	9440 30'11"
0 mm 0'0"	kg lb			*20 600 *44,600	15 500 33,300	*15 000 *32,450	10 250 22,050	11 150 24,050	7550 16,250	8600	5900	8300 18,300	5700 12,550	9220 30'2"
-1500 mm -5'0"	kg lb	*14 150 *32,000	*14 150 *32,000	*20 200 *43,750	15 400 33,100	*15 100 *32,650	10 100 21,750	11 050 23,800	7450 16,050			8950 19,700	6100 13,450	8740 28'7"
-3000 mm -10'0"	kg lb	*22 250 *50,400	*22 250 *50,400	*18 700 *40,550	15 550 33,400	*14 250 *30,800	10 150 21,850	*11 050 *23,700	7500 16,200			*10 100 *22,300	6950 15,450	7950 25'11"
-4500 mm -15'0"	kg lb	*21 050 *45,350	*21 050 *45,350	*15 850 *34,050	15 850 *34,050	*12 000 *25,550	10 350 22,400					*10 200 *22,400	8900 19,900	6740 21'10"



ISO 10567:2007



\* Indicates that the load is limited by hydraulic lifting capacity rather than tipping load. The above loads are in compliance with hydraulic excavator lift capacity standard ISO 10567:2007. They do not exceed 87% of hydraulic lifting capacity or 75% of tipping load. Weight of all lifting accessories must be deducted from the above lifting capacities. Lifting capacities are based on the machine standing on a firm, uniform supporting surface. The use of a work tool attachment point to handle/lift objects, could affect the machine lift performance.

Lift capacity stays with ±5% for all available track shoes.

Always refer to the appropriate Operation and Maintenance Manual for specific product information.

# 340 Hydraulic Excavator Specifications

## Reach Boom Lift Capacities – Counterweight: 7.56 mt (16,700 lb) – without Bucket, Heavy Lift: On

Long Wide Undercarriage

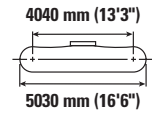
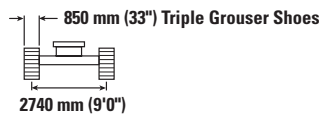
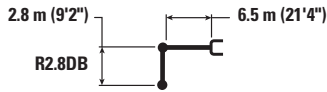

		3000 mm/10'0"		4500 mm/15'0"		6000 mm/20'0"		7500 mm/25'0"		9000 mm/30'0"		mm ft/in		
7500 mm 25'0"	kg lb											*9300 *20,650	8850 19,900	7350 23'9"
6000 mm 20'0"	kg lb					*10 100 *22,000	*10 100 *22,000	*9400 *20,650	8500 18,300			*8950 *19,750	7250 16,150	8260 26'11"
4500 mm 15'0"	kg lb			*14 600 *31,350	*14 600 *31,350	*11 500 *24,900	*11 500 *24,900	*10 000 *21,750	8300 17,900			*9000 *19,750	6450 14,250	8830 28'10"
3000 mm 10'0"	kg lb			*18 200 *39,050	16 650 35,950	*13 150 *28,450	11 050 23,850	*10 800 *23,500	8050 17,350	8900	6150	8750 19,250	6050 13,300	9110 29'10"
1500 mm 5'0"	kg lb			*16 850 *41,000	15 850 34,200	*14 500 *31,400	10 600 22,850	11 450 24,650	7800 16,800	8750	6050	8600 18,900	5900 13,000	9140 29'11"
0 mm 0'0"	kg lb			*19 900 *44,800	15 600 33,550	*15 200 *32,900	10 300 22,250	11 250 24,250	7600 16,450			8800 19,400	6050 13,300	8920 29'2"
-1500 mm -5'0"	kg lb	*13 250 *30,100	*13 250 *30,100	*19 900 *43,200	15 600 33,550	*15 050 *32,600	10 250 22,050	11 200 24,100	7550 16,300			9550 21,050	6550 14,400	8420 27'6"
-3000 mm -10'0"	kg lb	*23 750 *51,800	*23 750 *51,800	*18 100 *39,250	15 750 33,900	*13 950 *30,050	10 300 22,200	*10 550 23,350	7650			*10 350 *22,750	7550 16,750	7590 24'9"
-4500 mm -15'0"	kg lb	*19 050 *40,900	*19 050 *40,900	*14 750 *31,650	*14 750 *31,650	*11 000 *23,050	10 600 22,950					*10 100 *22,150	9950 *22,150	6310 20'5"

## Reach Boom Lift Capacities – Counterweight: 7.56 mt (16,700 lb) – without Bucket, Heavy Lift: On

Long Wide Undercarriage

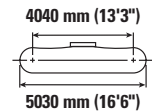
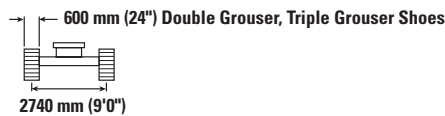
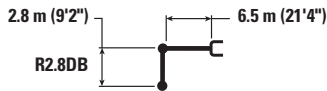

		3000 mm/10'0"		4500 mm/15'0"		6000 mm/20'0"		7500 mm/25'0"		9000 mm/30'0"		mm ft/in		
7500 mm 25'0"	kg lb											*9300 *20,650	8600 19,350	7350 23'9"
6000 mm 20'0"	kg lb					*10 100 *22,000	*10 100 *22,000	*9400 *20,650	8300 17,850			*8950 *19,750	7100 15,750	8260 26'11"
4500 mm 15'0"	kg lb			*14 600 *31,350	*14 600 *31,350	*11 500 *24,900	11 300 24,350	*10 000 *21,750	8100 17,400			*9000 *19,750	6250 13,850	8830 28'10"
3000 mm 10'0"	kg lb			*18 200 *39,050	16 250 35,000	*13 150 *28,450	10 750 23,200	*10 800 *23,500	7800 16,850	8650	6000	8450 18,650	5850 12,950	9110 29'10"
1500 mm 5'0"	kg lb			*16 850 *41,000	15 450 33,250	*14 500 *31,400	10 300 22,200	11 100 23,900	7550 16,300	8500	5850	8300 18,300	5750 12,650	9140 29'11"
0 mm 0'0"	kg lb			*19 900 *44,800	15 150 32,600	*15 200 *32,750	10 050 21,600	10 900 23,500	7400 15,950			8550 18,850	5900 12,950	8920 29'2"
-1500 mm -5'0"	kg lb	*13 250 *30,100	*13 250 *30,100	*19 900 *43,200	15 150 32,600	*15 050 *32,550	9950 21,400	10 850 23,350	7350 15,850			9250 20,400	6350 13,950	8420 27'6"
-3000 mm -10'0"	kg lb	*23 750 *51,800	*23 750 *51,800	*18 100 *39,250	15 350 32,950	*13 950 *30,050	10 000 21,600	*10 550 23,350	7450			*10 350 *22,750	7350 16,250	7590 24'9"
-4500 mm -15'0"	kg lb	*19 050 *40,900	*19 050 *40,900	*14 750 *31,650	*14 750 *31,650	*11 000 *23,050	10 300 22,300					*10 100 *22,150	9650 21,700	6310 20'5"



ISO 10567:2007



\* Indicates that the load is limited by hydraulic lifting capacity rather than tipping load. The above loads are in compliance with hydraulic excavator lift capacity standard ISO 10567:2007. They do not exceed 87% of hydraulic lifting capacity or 75% of tipping load. Weight of all lifting accessories must be deducted from the above lifting capacities. Lifting capacities are based on the machine standing on a firm, uniform supporting surface. The use of a work tool attachment point to handle/lift objects, could affect the machine lift performance.

Lift capacity stays with ±5% for all available track shoes.

Always refer to the appropriate Operation and Maintenance Manual for specific product information.

# 340 Hydraulic Excavator Specifications

## Reach Boom Lift Capacities – Counterweight: 7.56 mt (16,700 lb) – without Bucket, Heavy Lift: On

Long Wide Undercarriage

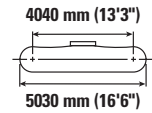
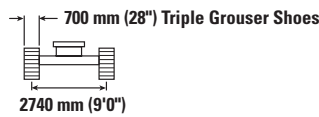
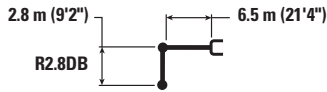

		3000 mm/10'0"		4500 mm/15'0"		6000 mm/20'0"		7500 mm/25'0"		9000 mm/30'0"		mm ft/in		
7500 mm 25'0"	kg lb											*9300 *20,650	8700 19,500	7350 23'9"
6000 mm 20'0"	kg lb					*10 100 *22,000	*10 100 *22,000	*9400 *20,650	8350 17,950			*8950 *19,750	7150 15,850	8260 26'11"
4500 mm 15'0"	kg lb			*14 600 *31,350	*14 600 *31,350	*11 500 *24,900	11 400 24,550	*10 000 *21,750	8150 17,550			*9000 *19,750	6350 14,000	8830 28'10"
3000 mm 10'0"	kg lb			*18 200 *39,050	16 350 35,300	*13 150 *28,450	10 850 23,400	*10 800 *23,500	7900 17,000	8700	6050	8550 18,850	5900 13,050	9110 29'10"
1500 mm 5'0"	kg lb			*16 850 *41,900	15 550 33,500	*14 500 *31,400	10 400 22,400	11 200 24,100	7650 16,450	8600	5900	8400 18,500	5800 12,750	9140 29'11"
0 mm 0'0"	kg lb			*19 900 *44,800	15 300 32,900	*15 200 *32,900	10 100 21,800	11 000 23,700	7450 16,100			8650 19,000	5950 13,050	8920 29'2"
-1500 mm -5'0"	kg lb	*13 250 *30,100	*13 250 *30,100	*19 900 *43,200	15 300 32,850	*15 050 *32,600	10 050 21,600	10 950 23,600	7400 15,950			9350 20,600	6400 14,100	8420 27'6"
-3000 mm -10'0"	kg lb	*23 750 *51,800	*23 750 *51,800	*18 100 *39,250	15 450 33,250	*13 950 *30,050	10 100 21,750	*10 550 23,100	7500			*10 350 *22,750	7400 16,400	7590 24'9"
-4500 mm -15'0"	kg lb	*19 050 *40,900	*19 050 *40,900	*14 750 *31,650	*14 750 *31,650	*11 000 *23,050	10 400 22,500					*10 100 *22,150	9750 21,900	6310 20'5"

## Reach Boom Lift Capacities – Counterweight: 7.56 mt (16,700 lb) – without Bucket, Heavy Lift: On

Long Wide Undercarriage

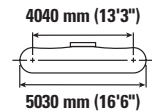
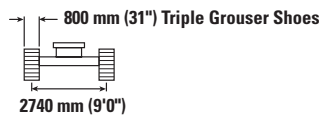
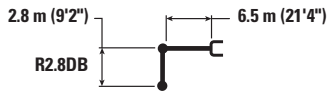

		3000 mm/10'0"		4500 mm/15'0"		6000 mm/20'0"		7500 mm/25'0"		9000 mm/30'0"		mm ft/in		
7500 mm 25'0"	kg lb											*9300 *20,650	8800 19,800	7350 23'9"
6000 mm 20'0"	kg lb					*10 100 *22,000	*10 100 *22,000	*9400 *20,650	8500 18,200			*8950 *19,750	7250 16,100	8260 26'11"
4500 mm 15'0"	kg lb			*14 600 *31,350	*14 600 *31,350	*11 500 *24,900	*11 500 *24,900	*10 000 *21,750	8300 17,800			*9000 *19,750	6450 14,200	8830 28'10"
3000 mm 10'0"	kg lb			*18 200 *39,050	16 600 35,800	*13 150 *28,450	11 000 23,700	*10 800 *23,500	8000 17,250	8850	6150	8700 19,150	6000 13,250	9110 29'10"
1500 mm 5'0"	kg lb			*16 850 *41,900	15 800 34,050	*14 500 *31,400	10 550 22,750	11 400 24,500	7750 16,700	8750	6000	8550 18,800	5900 12,950	9140 29'11"
0 mm 0'0"	kg lb			*19 900 *44,800	15 550 33,400	*15 200 *32,900	10 250 22,150	11 200 24,100	7600 16,350			8750 19,300	6050 13,250	8920 29'2"
-1500 mm -5'0"	kg lb	*13 250 *30,100	*13 250 *30,100	*19 900 *43,200	15 550 33,400	*15 050 *32,600	10 200 21,950	11 150 23,950	7550 16,200			9500 20,950	6500 14,300	8420 27'6"
-3000 mm -10'0"	kg lb	*23 750 *51,800	*23 750 *51,800	*18 100 *39,250	15 700 33,750	*13 950 *30,050	10 250 22,100	*10 550 23,100	7650			*10 350 *22,750	7500 16,650	7590 24'9"
-4500 mm -15'0"	kg lb	*19 050 *40,900	*19 050 *40,900	*14 750 *31,650	*14 750 *31,650	*11 000 *23,050	10 550 22,850					*10 100 *22,150	9900 *22,150	6310 20'5"



ISO 10567:2007



\* Indicates that the load is limited by hydraulic lifting capacity rather than tipping load. The above loads are in compliance with hydraulic excavator lift capacity standard ISO 10567:2007. They do not exceed 87% of hydraulic lifting capacity or 75% of tipping load. Weight of all lifting accessories must be deducted from the above lifting capacities. Lifting capacities are based on the machine standing on a firm, uniform supporting surface. The use of a work tool attachment point to handle/lift objects, could affect the machine lift performance.

Lift capacity stays with ±5% for all available track shoes.

Always refer to the appropriate Operation and Maintenance Manual for specific product information.

# 340 Hydraulic Excavator Specifications

## Mass Boom Lift Capacities – Counterweight: 7.56 mt (16,700 lb) – without Bucket, Heavy Lift: On

Long Wide Undercarriage

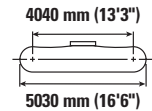
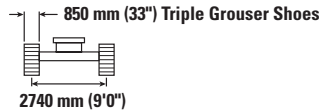
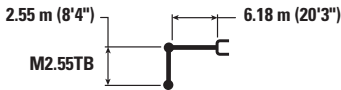

Boom Length	Unit	3000 mm/10'0"		4500 mm/15'0"		6000 mm/20'0"		7500 mm/25'0"		Undercarriage		mm ft/in
		Diagram	Diagram	Diagram	Diagram	Diagram	Diagram	Diagram	Diagram	Diagram	Diagram	
7500 mm 25'0"	kg lb					*10 150 *22,350	*10 150 *22,350			*8950 *19,900	*8950 *19,900	6600 21'3"
6000 mm 20'0"	kg lb					*10 500 *22,850	*10 500 *22,850	*9900	8200	*8550 *18,850	8000 17,800	7600 24'9"
4500 mm 15'0"	kg lb			*14 700 *31,600	*14 700 *31,600	*11 700 *25,300	11 350 24,400	*10 250 *22,300	8050 17,250	*8550 *18,850	6950 15,350	8220 26'10"
3000 mm 10'0"	kg lb			*18 000 *38,700	16 400 35,350	*13 150 *28,450	10 750 23,200	*10 900 *23,650	7750 16,750	*8900 *19,550	6400 14,100	8520 27'11"
1500 mm 5'0"	kg lb			*20 000 *43,200	15 550 33,450	*14 400 *31,100	10 300 22,200	11 200 24,100	7550 16,200	9200 20,300	6250 13,750	8550 28'0"
0 mm 0'0"	kg lb			*20 200 *43,800	15 250 32,800	*14 900 *32,250	10 050 21,600	11 000 23,700	7350 15,850	9500 20,950	6400 14,150	8310 27'3"
-1500 mm -5'0"	kg lb	*17 900 *40,650	*17 900 *40,650	*19 200 *41,600	15 250 32,800	*14 500 *31,400	9950 21,450	11 000 23,700	7350 15,850	10 500 23,100	7050 15,500	7770 25'5"
-3000 mm -10'0"	kg lb	*21 950 *47,700	*21 950 *47,700	*16 900 *36,550	15 500 33,300	*12 850 *27,600	10 100 21,800			*10 600 *23,350	8450 18,750	6870 22'4"
-4500 mm -15'0"	kg lb			*12 400 *26,150	*12 400 *26,150					*9850 *21,450	*9850 *21,450	5410 17'5"

## Mass Boom Lift Capacities – Counterweight: 7.56 mt (16,700 lb) – without Bucket, Heavy Lift: On

Long Wide Undercarriage

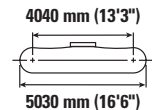
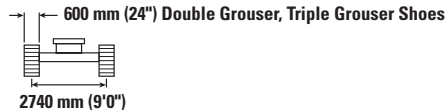
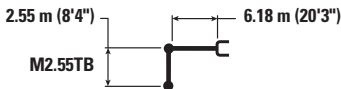

Boom Length	Unit	3000 mm/10'0"		4500 mm/15'0"		6000 mm/20'0"		7500 mm/25'0"		Undercarriage		mm ft/in
		Diagram	Diagram	Diagram	Diagram	Diagram	Diagram	Diagram	Diagram	Diagram	Diagram	
7500 mm 25'0"	kg lb					*10 150 *22,350	*10 150 *22,350			*8950 *19,900	*8950 *19,900	6600 21'3"
6000 mm 20'0"	kg lb					*10 500 *22,850	*10 500 *22,850	*9900	7950	*8550 *18,850	7800 17,350	7600 24'9"
4500 mm 15'0"	kg lb			*14 700 *31,600	*14 700 *31,600	*11 700 *25,300	11 050 23,800	*10 250 *22,300	7800 16,800	*8550 *18,850	6750 14,900	8220 26'10"
3000 mm 10'0"	kg lb			*18 000 *38,700	15 950 34,400	*13 150 *28,450	10 500 22,600	*10 900 *23,650	7550 16,250	*8900 *19,550	6200 13,700	8520 27'11"
1500 mm 5'0"	kg lb			*20 000 *43,200	15 100 32,500	*14 400 *31,100	10 000 21,550	10 850 23,350	7300 15,750	8950 19,650	6050 13,350	8550 28'0"
0 mm 0'0"	kg lb			*20 200 *43,800	14 800 31,850	*14 900 *32,150	9750 20,950	10 700 23,000	7150 15,400	9250 20,300	6250 13,700	8310 27'3"
-1500 mm -5'0"	kg lb	*17 900 *40,650	*17 900 *40,650	*19 200 *41,600	14 850 31,850	*14 500 *31,400	9650 20,800	10 650 23,000	7150 15,400	10 150 22,400	6800 15,050	7770 25'5"
-3000 mm -10'0"	kg lb	*21 950 *47,700	*21 950 *47,700	*16 900 *36,550	15 050 32,350	*12 850 *27,600	9800 21,150			*10 600 *23,350	8200 18,200	6870 22'4"
-4500 mm -15'0"	kg lb			*12 400 *26,150	*12 400 *26,150					*9850 *21,450	*9850 *21,450	5410 17'5"



ISO 10567:2007



\* Indicates that the load is limited by hydraulic lifting capacity rather than tipping load. The above loads are in compliance with hydraulic excavator lift capacity standard ISO 10567:2007. They do not exceed 87% of hydraulic lifting capacity or 75% of tipping load. Weight of all lifting accessories must be deducted from the above lifting capacities. Lifting capacities are based on the machine standing on a firm, uniform supporting surface. The use of a work tool attachment point to handle/lift objects, could affect the machine lift performance.

Lift capacity stays with ±5% for all available track shoes.

Always refer to the appropriate Operation and Maintenance Manual for specific product information.

# 340 Hydraulic Excavator Specifications

## Mass Boom Lift Capacities – Counterweight: 7.56 mt (16,700 lb) – without Bucket, Heavy Lift: On

Long Wide Undercarriage

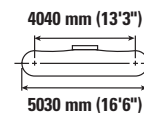
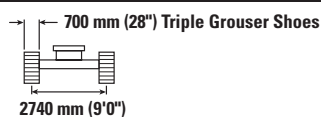
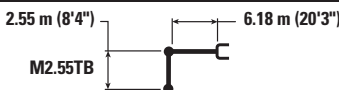

Boom Length mm ft/in	Weight kg lb	3000 mm/10'0"		4500 mm/15'0"		6000 mm/20'0"		7500 mm/25'0"		mm ft/in		
7500 mm 25'0"	kg lb					*10 150 *22,350	*10 150 *22,350			*8950 *19,900	*8950 *19,900	6600 21'3"
6000 mm 20'0"	kg lb					*10 500 *22,850	*10 500 *22,850	*9900 8050		*8550 *18,850	7850 17,500	7600 24'9"
4500 mm 15'0"	kg lb			*14 700 *31,600	*14 700 *31,600	*11 700 *25,300	11 150 23,950	*10 250 *22,300	7900 16,900	*8550 *18,850	6800 15,000	8220 26'10"
3000 mm 10'0"	kg lb			*18 000 *38,700	16 050 34,650	*13 150 *28,450	10 550 22,750	*10 900 *23,650	7600 16,400	*8900 *19,550	6250 13,800	8520 27'11"
1500 mm 5'0"	kg lb			*20 000 *43,200	15 250 32,800	*14 400 *31,100	10 100 21,750	10 950 23,550	7350 15,850	9000 19,850	6100 13,450	8550 28'0"
0 mm 0'0"	kg lb			*20 200 *43,800	14 950 32,150	*14 900 *32,250	9800 21,150	10 800 23,200	7200 15,550	9300 20,500	6300 13,800	8310 27'3"
-1500 mm -5'0"	kg lb	*17 900 *40,650	*17 900 *40,650	*19 200 *41,600	14 950 32,150	*14 500 *31,400	9750 21,000	10 750 23,200	7200 15,500	10 250 22,600	6900 15,200	7770 25'5"
-3000 mm -10'0"	kg lb	*21 950 *47,700	*21 950 *47,700	*16 900 *36,550	15 200 32,650	*12 850 *27,600	9900 21,350			*10 600 *23,350	8250 18,350	6870 22'4"
-4500 mm -15'0"	kg lb			*12 400 *26,150	*12 400 *26,150					*9850 *21,450	*9850 *21,450	5410 17'5"

## Mass Boom Lift Capacities – Counterweight: 7.56 mt (16,700 lb) – without Bucket, Heavy Lift: On

Long Wide Undercarriage

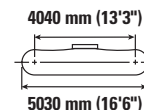
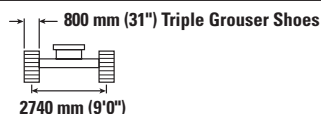
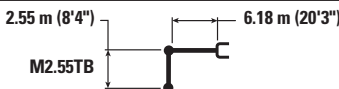

Boom Length mm ft/in	Weight kg lb	3000 mm/10'0"		4500 mm/15'0"		6000 mm/20'0"		7500 mm/25'0"		mm ft/in		
7500 mm 25'0"	kg lb					*10 150 *22,350	*10 150 *22,350			*8950 *19,900	*8950 *19,900	6600 21'3"
6000 mm 20'0"	kg lb					*10 500 *22,850	*10 500 *22,850	*9900 8150		*8550 *18,850	7950 17,750	7600 24'9"
4500 mm 15'0"	kg lb			*14 700 *31,600	*14 700 *31,600	*11 700 *25,300	11 300 24,300	*10 250 *22,300	8000 17,200	*8550 *18,850	6900 15,250	8220 26'10"
3000 mm 10'0"	kg lb			*18 000 *38,700	16 300 35,150	*13 150 *28,450	10 700 23,100	*10 900 *23,650	7750 16,650	*8900 *19,550	6350 14,050	8520 27'11"
1500 mm 5'0"	kg lb			*20 000 *43,200	15 450 33,300	*14 400 *31,100	10 250 22,100	11 150 23,950	7500 16,100	9150 20,200	6200 13,650	8550 28'0"
0 mm 0'0"	kg lb			*20 200 *43,800	15 200 32,650	*14 900 *32,250	10 000 21,500	10 950 23,600	7350 15,800	9450 20,850	6400 14,050	8310 27'3"
-1500 mm -5'0"	kg lb	*17 900 *40,650	*17 900 *40,650	*19 200 *41,600	15 200 32,650	*14 500 *31,400	9900 21,350	10 950 23,600	7300 15,800	10 400 23,000	7000 15,450	7770 25'5"
-3000 mm -10'0"	kg lb	*21 950 *47,700	*21 950 *47,700	*16 900 *36,550	15 400 33,150	*12 850 *27,600	10 050 21,650			*10 600 *23,350	8400 18,650	6870 22'4"
-4500 mm -15'0"	kg lb			*12 400 *26,150	*12 400 *26,150					*9850 *21,450	*9850 *21,450	5410 17'5"



ISO 10567:2007



\* Indicates that the load is limited by hydraulic lifting capacity rather than tipping load. The above loads are in compliance with hydraulic excavator lift capacity standard ISO 10567:2007. They do not exceed 87% of hydraulic lifting capacity or 75% of tipping load. Weight of all lifting accessories must be deducted from the above lifting capacities. Lifting capacities are based on the machine standing on a firm, uniform supporting surface. The use of a work tool attachment point to handle/lift objects, could affect the machine lift performance.

Lift capacity stays with ±5% for all available track shoes.

Always refer to the appropriate Operation and Maintenance Manual for specific product information.



# 340 Hydraulic Excavator Specifications

## HD Reach Boom Lift Capacities – Counterweight: 7.56 mt (16,700 lb) – without Bucket, Heavy Lift: On

Long Wide Undercarriage

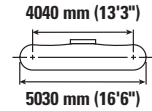
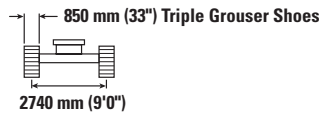
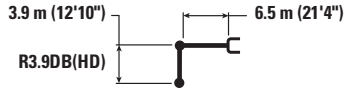

Reach	Unit	1500 mm/5'0"		3000 mm/10'0"		4500 mm/15'0"		6000 mm/20'0"		7500 mm/25'0"		9000 mm/30'0"		mm ft/in			
		kg	lb	kg	lb	kg	lb	kg	lb	kg	lb	kg	lb	kg	lb	mm	ft/in
9000 mm 30'0"	kg														*6150	*6150	7360
	lb														*13,650	*13,650	23'8"
7500 mm 25'0"	kg									*7600	*7600				*5700	*5700	8550
	lb									*16,800	*16,800				*12,600	*12,600	27'9"
6000 mm 20'0"	kg									*7900	*7900	*7450	6400		*5550	*5550	9340
	lb									*17,300	*17,300	*14,400	13,650		*12,250	*12,250	30'6"
4500 mm 15'0"	kg							*9700	*9700	*8650	8400	*8100	6300		*5550	5400	9850
	lb							*21,000	*21,000	*18,850	18,050	*17,700	13,450		*12,250	11,900	32'2"
3000 mm 10'0"	kg					*15 250	*15 250	*11 500	11 250	*9650	8050	*8600	6100		*5750	5050	10 100
	lb					*32,700	*32,700	*24,850	24,200	*20,900	17,350	*18,700	13,100		*12,650	11,150	33'1"
1500 mm 5'0"	kg					*18 350	16 100	*13 200	10 650	*10 600	7750	8650	5900		*6100	4950	10 130
	lb					*39,550	34,700	*28,550	22,900	*23,000	16,650	18,650	12,750		*13,400	10,900	33'2"
0 mm 0'0"	kg			*8200	*8200	*19 950	15 450	*14 400	10 200	11 100	7450	8500	5750		*6650	5000	9930
	lb			*18,700	*18,700	*43,150	33,200	*31,150	21,950	23,900	16,050	18,300	12,400		*14,650	11,050	32'6"
-1500 mm -5'0"	kg	*8600	*8600	*12 900	*12 900	*20 200	15 200	*14 850	9950	10 950	7300	8450	5700		*7550	5300	9480
	lb	*19,200	*19,200	*29,100	*29,100	*43,750	32,650	*32,150	21,450	23,550	15,750	18,150	12,250		*16,700	11,700	31'0"
-3000 mm -10'0"	kg	*13 650	*13 650	*18 800	*18 800	*19 300	15 200	*14 500	9900	10 900	7250				8800	5950	8760
	lb	*30,550	*30,550	*42,550	*42,550	*41,800	32,700	*31,300	21,350	23,500	15,650				19,450	13,150	28'7"
-4500 mm -15'0"	kg	*19 600	*19 600	*23 850	*23 850	*17 200	15 450	*13 000	10 050		7400				*9350	7200	7680
	lb	*44,050	*44,050	*51,400	*51,400	*37,050	33,200	*27,950	21,650						*20,550	16,050	24'11"
-6000 mm -20'0"	kg					*13 050	*13 050	*9200	*9200						*9100	*9100	6040
	lb					*27,500	*27,500								*19,900	*19,900	19'4"



ISO 10567:2007



\* Indicates that the load is limited by hydraulic lifting capacity rather than tipping load. The above loads are in compliance with hydraulic excavator lift capacity standard ISO 10567:2007. They do not exceed 87% of hydraulic lifting capacity or 75% of tipping load. Weight of all lifting accessories must be deducted from the above lifting capacities. Lifting capacities are based on the machine standing on a firm, uniform supporting surface. The use of a work tool attachment point to handle/lift objects, could affect the machine lift performance.

Lift capacity stays with ±5% for all available track shoes.

Always refer to the appropriate Operation and Maintenance Manual for specific product information.

# 340 Hydraulic Excavator Specifications

## HD Reach Boom Lift Capacities – Counterweight: 7.56 mt (16,700 lb) – without Bucket, Heavy Lift: On

Long Wide Undercarriage

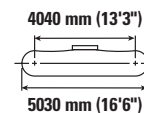
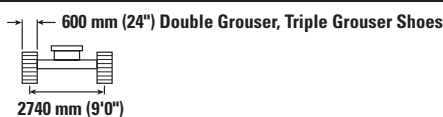

		1500 mm/5'0"		3000 mm/10'0"		4500 mm/15'0"		6000 mm/20'0"		7500 mm/25'0"		9000 mm/30'0"		mm ft/in		
9000 mm 30'0"	kg lb													*6150 *13,650	*6150 *13,650	7360 23'8"
7500 mm 25'0"	kg lb									*7600 *16,800	*7600 *16,800			*5700 *12,600	*5700 *12,600	8550 27'9"
6000 mm 20'0"	kg lb									*7900 *17,300	*7900 *17,300	*7450 *14,400	6200 13,300	*5550 *12,250	*5550 *12,250	9340 30'6"
4500 mm 15'0"	kg lb							*9700 *21,000	*9700 *21,000	*8650 *18,850	8200 17,600	*8100 *17,700	6100 13,100	*5550 *12,250	5250 11,550	9850 32'2"
3000 mm 10'0"	kg lb					*15 250 *32,700	*15 250 *32,700	*11 500 *24,850	10 950 23,550	*9650 *20,900	7850 16,850	*8600 *18,500	5950 12,750	*5750 *12,650	4900 10,800	10 100 33'1"
1500 mm 5'0"	kg lb					*18 350 *39,550	15 650 33,750	*13 200 *28,550	10 350 22,250	*10 600 *23,000	7500 16,150	8400 18,100	5750 12,350	*6100 *13,400	4800 10,550	10 130 33'2"
0 mm 0'0"	kg lb			*8200 *18,700	*8200 *18,700	*19 950 *43,150	15 000 32,250	*14 400 *31,150	9900 21,300	10 800 23,200	7250 15,600	8250 17,750	5600 12,050	*6650 *14,650	4850 10,700	9930 32'6"
-1500 mm -5'0"	kg lb	*8600 *19,200	*8600 *19,200	*12 900 *29,100	*12 900 *29,100	*20 200 *43,750	14 750 31,700	*14 850 *31,950	9650 20,800	10 600 22,850	7100 15,250	8150 17,550	5500 11,900	*7550 *16,700	5150 11,350	9480 31'0"
-3000 mm -10'0"	kg lb	*13 650 *30,550	*13 650 *30,550	*18 800 *42,550	*18 800 *42,550	*19 300 *41,800	14 750 31,750	*14 500 *31,300	9600 20,700	10 600 22,750	7050 15,200			8500 18,850	5750 12,700	8760 28'7"
-4500 mm -15'0"	kg lb	*19 600 *44,050	*19 600 *44,050	*23 850 *51,400	*23 850 *51,400	*17 200 *37,050	15 000 32,250	*13 000 *27,950	9750 21,000	*9750 *21,000	7200			*9350 *20,550	7000 15,600	7680 24'11"
-6000 mm -20'0"	kg lb					*13 050 *27,500	*13 050 *27,500	*9200 *20,000	*9200 *20,000					*9100 *19,900	*9100 *19,900	6040 19'4"



ISO 10567:2007



\* Indicates that the load is limited by hydraulic lifting capacity rather than tipping load. The above loads are in compliance with hydraulic excavator lift capacity standard ISO 10567:2007. They do not exceed 87% of hydraulic lifting capacity or 75% of tipping load. Weight of all lifting accessories must be deducted from the above lifting capacities. Lifting capacities are based on the machine standing on a firm, uniform supporting surface. The use of a work tool attachment point to handle/lift objects, could affect the machine lift performance.

Lift capacity stays with ±5% for all available track shoes.

Always refer to the appropriate Operation and Maintenance Manual for specific product information.

# 340 Hydraulic Excavator Specifications

## HD Reach Boom Lift Capacities – Counterweight: 7.56 mt (16,700 lb) – without Bucket, Heavy Lift: On

Long Wide Undercarriage

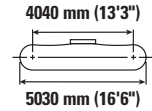
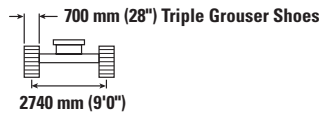
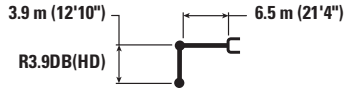

Reach	Unit	1500 mm/5'0"		3000 mm/10'0"		4500 mm/15'0"		6000 mm/20'0"		7500 mm/25'0"		9000 mm/30'0"		mm ft/in		
		kg lb	kg lb	kg lb	kg lb	kg lb	kg lb	kg lb	kg lb	kg lb	kg lb	kg lb	kg lb	kg lb	mm ft/in	
9000 mm 30'0"	kg lb													*6150 *13,650	*6150 *13,650	7360 23'8"
7500 mm 25'0"	kg lb									*7600 *16,800	*7600 *16,800			*5700 *12,600	*5700 *12,600	8550 27'9"
6000 mm 20'0"	kg lb									*7900 *17,300	*7900 *17,300	*7450 *14,400	6250 13,400	*5550 *12,250	*5550 *12,250	9340 30'6"
4500 mm 15'0"	kg lb							*9700 *21,000	*9700 *21,000	*8650 *18,850	8250 17,700	*8100 *17,700	6150 13,200	*5550 *12,250	5250 11,650	9850 32'2"
3000 mm 10'0"	kg lb					*15 250 *32,700	*15 250 *32,700	*11 500 *24,850	11 000 23,750	*9650 *20,900	7900 17,000	*8600 *18,650	6000 12,850	*5750 *12,650	4950 10,900	10 100 33'1"
1500 mm 5'0"	kg lb					*18 350 *39,550	15 800 34,050	*13 200 *28,550	10 400 22,450	*10 600 *23,000	7550 16,300	8500 18,250	5800 12,450	*6100 *13,400	4850 10,650	10 130 33'2"
0 mm 0'0"	kg lb			*8200 *18,700	*8200 *18,700	*19 950 *43,150	15 150 32,550	*14 400 *31,150	10 000 21,500	10 900 23,400	7300 15,750	8300 17,900	5650 12,150	*6650 *14,650	4900 10,800	9930 32'6"
-1500 mm -5'0"	kg lb	*8600 *19,200	*8600 *19,200	*12 900 *29,100	*12 900 *29,100	*20 200 *43,750	14 900 32,000	*14 850 *32,150	9750 21,000	10 700 23,050	7150 15,400	8250 17,750	5550 12,000	*7550 *16,700	5200 11,450	9480 31'0"
-3000 mm -10'0"	kg lb	*13 650 *30,550	*13 650 *30,550	*18 800 *42,550	*18 800 *42,550	*19 300 *41,800	14 900 32,000	*14 500 *31,300	9700 20,900	10 650 23,000	7100 15,350			8600 19,000	5800 12,850	8760 28'7"
-4500 mm -15'0"	kg lb	*19 600 *44,050	*19 600 *44,050	*23 850 *51,400	*23 850 *51,400	*17 200 *37,050	15 100 32,500	*13 000 *27,950	9850 21,200	*9750 21,200	7250			*9350 *20,550	7050 15,750	7680 24'11"
-6000 mm -20'0"	kg lb					*13 050 *27,500	*13 050 *27,500	*9200 *20,000	*9200 *20,000					*9100 *19,900	*9100 *19,900	6040 19'4"



ISO 10567:2007



\* Indicates that the load is limited by hydraulic lifting capacity rather than tipping load. The above loads are in compliance with hydraulic excavator lift capacity standard ISO 10567:2007. They do not exceed 87% of hydraulic lifting capacity or 75% of tipping load. Weight of all lifting accessories must be deducted from the above lifting capacities. Lifting capacities are based on the machine standing on a firm, uniform supporting surface. The use of a work tool attachment point to handle/lift objects, could affect the machine lift performance.

Lift capacity stays with ±5% for all available track shoes.

Always refer to the appropriate Operation and Maintenance Manual for specific product information.

# 340 Hydraulic Excavator Specifications

## HD Reach Boom Lift Capacities – Counterweight: 7.56 mt (16,700 lb) – without Bucket, Heavy Lift: On

Long Wide Undercarriage

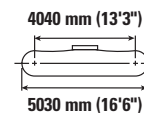
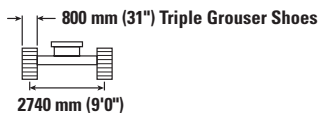

Boom Length	Unit	1500 mm/5'0"		3000 mm/10'0"		4500 mm/15'0"		6000 mm/20'0"		7500 mm/25'0"		9000 mm/30'0"		mm ft/in		
		kg	lb	kg	lb	kg	lb	kg	lb	kg	lb	kg	lb	kg	lb	mm
9000 mm 30'0"	kg lb													*6150 *13,650	*6150 *13,650	7360 23'8"
7500 mm 25'0"	kg lb									*7600 *16,800	*7600 *16,800			*5700 *12,600	*5700 *12,600	8550 27'9"
6000 mm 20'0"	kg lb									*7900 *17,300	*7900 *17,300	*7450 *14,400	6350 13,600	*5550 *12,250	*5550 *12,250	9340 30'6"
4500 mm 15'0"	kg lb							*9700 *21,000	*9700 *21,000	*8650 *18,850	8350 18,000	*8100 *17,700	6250 13,400	*5550 *12,250	5350 11,850	9850 32'2"
3000 mm 10'0"	kg lb					*15 250 *32,700	*15 250 *32,700	*11 500 *24,850	11 200 24,100	*9650 *20,900	8000 17,250	*8600 *18,700	6050 13,050	*5750 *12,650	5050 11,100	10 100 33'1"
1500 mm 5'0"	kg lb					*18 350 *39,550	16 050 34,550	*13 200 *28,550	10 600 22,800	*10 600 *23,000	7700 16,550	8650 18,550	5900 12,650	*6100 *13,400	4950 10,850	10 130 33'2"
0 mm 0'0"	kg lb			*8200 *18,700	*8200 *18,700	*19 950 *43,150	15 350 33,050	*14 400 *31,150	10 150 21,850	11 050 23,800	7450 16,000	8450 18,200	5750 12,350	*6650 *14,650	5000 11,000	9930 32'6"
-1500 mm -5'0"	kg lb	*8600 *19,200	*8600 *19,200	*12 900 *29,100	*12 900 *29,100	*20 200 *43,750	15 100 32,500	*14 850 *32,150	9900 21,350	10 900 23,400	7250 15,650	8400 18,050	5650 12,200	*7550 *16,700	5300 11,650	9480 31'0"
-3000 mm -10'0"	kg lb	*13 650 *30,550	*13 650 *30,550	*18 800 *42,550	*18 800 *42,550	*19 300 *41,800	15 150 32,500	*14 500 *31,300	9850 21,200	10 850 23,350	7250 15,600			8750 19,350	5900 13,050	8760 28'7"
-4500 mm -15'0"	kg lb	*19 600 *44,050	*19 600 *44,050	*23 850 *51,400	*23 850 *51,400	*17 200 *37,050	15 350 33,050	*13 000 *27,950	10 000 21,550	*9750 21,550	7400			*9350 *20,550	7200 16,000	7680 24'11"
-6000 mm -20'0"	kg lb					*13 050 *27,500	*13 050 *27,500	*9200 *20,000	*9200 *20,000					*9100 *19,900	*9100 *19,900	6040 19'4"



ISO 10567:2007



\* Indicates that the load is limited by hydraulic lifting capacity rather than tipping load. The above loads are in compliance with hydraulic excavator lift capacity standard ISO 10567:2007. They do not exceed 87% of hydraulic lifting capacity or 75% of tipping load. Weight of all lifting accessories must be deducted from the above lifting capacities. Lifting capacities are based on the machine standing on a firm, uniform supporting surface. The use of a work tool attachment point to handle/lift objects, could affect the machine lift performance.

Lift capacity stays with ±5% for all available track shoes.

Always refer to the appropriate Operation and Maintenance Manual for specific product information.

# 340 Hydraulic Excavator Specifications

## HD Reach Boom Lift Capacities – Counterweight: 7.56 mt (16,700 lb) – without Bucket, Heavy Lift: On

Long Wide Undercarriage

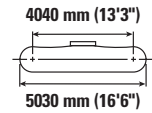
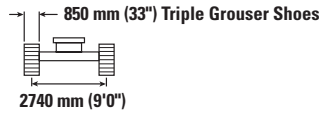

		3000 mm/10'0"		4500 mm/15'0"		6000 mm/20'0"		7500 mm/25'0"		9000 mm/30'0"		mm ft/in		
7500 mm 25'0"	kg lb							*8700 *16,300	8600 *16,300			*7350 *16,200	*7350 *16,200	7720 25'0"
6000 mm 20'0"	kg lb							*8800 *19,300	8550 18,350			*7150 *15,700	6800 15,150	8590 28'0"
4500 mm 15'0"	kg lb			*13 450 *28,900	*13 450 *28,900	*10 800 *23,400	*10 800 *23,400	*9450 *20,600	8300 17,850	*8450	6200	*7200 *15,800	6050 13,400	9140 29'10"
3000 mm 10'0"	kg lb			*17 050 *36,600	16 850 36,300	*12 500 *27,050	11 050 23,850	*10 350 *22,450	8000 17,250	8850	6100	*7450 *16,400	5700 12,500	9410 30'10"
1500 mm 5'0"	kg lb			*19 600 *42,250	15 850 34,150	*14 000 *30,250	10 550 22,700	*11 200 *24,250	7700 16,600	8700	5950	*8000 *17,600	5550 12,200	9440 30'11"
0 mm 0'0"	kg lb			*20 400 *44,200	15 450 33,200	*14 850 *32,150	10 200 21,950	11 150 24,000	7500 16,150	8600	5850	8300 18,250	5650 12,450	9220 30'2"
-1500 mm -5'0"	kg lb	*14 100 *31,900	*14 100 *31,900	*20 000 *43,350	15 350 33,000	*14 950 *32,350	10 050 21,650	11 050 23,750	7400 15,950			8900 19,650	6050 13,350	8740 28'7"
-3000 mm -10'0"	kg lb	*22 250 *50,350	*22 250 *50,350	*18 550 *40,150	15 450 33,250	*14 100 *30,500	10 100 21,750	*10 950 *23,400	7450 16,100			*10 000 *22,050	6950 15,350	7950 25'11"
-4500 mm -15'0"	kg lb	*20 800 *44,850	*20 800 *44,850	*15 700 *33,700	*15 700 *33,700	*11 900 *25,250	10 300 22,250					*10 050 *22,100	8850 19,800	6740 21'10"

## HD Reach Boom Lift Capacities – Counterweight: 7.56 mt (16,700 lb) – without Bucket, Heavy Lift: On

Long Wide Undercarriage

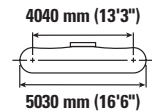
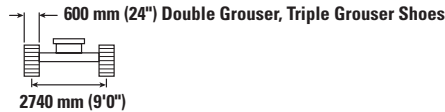

		3000 mm/10'0"		4500 mm/15'0"		6000 mm/20'0"		7500 mm/25'0"		9000 mm/30'0"		mm ft/in		
7500 mm 25'0"	kg lb							*8700 *16,300	8400 *16,300			*7350 *16,200	*7350 *16,200	7720 25'0"
6000 mm 20'0"	kg lb							*8800 *19,300	8300 17,850			*7150 *15,700	6650 14,750	8590 28'0"
4500 mm 15'0"	kg lb			*13 450 *28,900	*13 450 *28,900	*10 800 *23,400	*10 800 *23,400	*9450 *20,600	8100 17,400	*8450	6050	*7200 *15,800	5900 13,050	9140 29'10"
3000 mm 10'0"	kg lb			*17 050 *36,600	16 400 35,350	*12 500 *27,050	10 750 23,200	*10 350 *22,450	7800 16,750	8600	5900	*7450 *16,400	5500 12,150	9410 30'10"
1500 mm 5'0"	kg lb			*19 600 *42,250	15 400 33,200	*14 000 *30,250	10 250 22,050	11 050 23,750	7500 16,150	8450	5750	7850 17,300	5400 11,850	9440 30'11"
0 mm 0'0"	kg lb			*20 400 *44,200	15 000 32,250	*14 850 *32,150	9900 21,350	10 800 23,300	7300 15,700	8300	5650	8050 17,700	5500 12,050	9220 30'2"
-1500 mm -5'0"	kg lb	*14 100 *31,900	*14 100 *31,900	*20 000 *43,350	14 900 32,050	*14 950 *32,150	9750 21,000	10 700 23,050	7200 15,500			8650 19,050	5850 12,950	8740 28'7"
-3000 mm -10'0"	kg lb	*22 250 *50,350	*22 250 *50,350	*18 550 *40,150	15 050 32,300	*14 100 *30,500	9800 21,100	10 750 23,200	7250 15,600			9950 22,000	6700 14,850	7950 25'11"
-4500 mm -15'0"	kg lb	*20 800 *44,850	*20 800 *44,850	*15 700 *33,700	15 350 33,050	*11 900 *25,250	10 050 21,650					*10 050 *22,100	8600 19,250	6740 21'10"



ISO 10567:2007



\* Indicates that the load is limited by hydraulic lifting capacity rather than tipping load. The above loads are in compliance with hydraulic excavator lift capacity standard ISO 10567:2007. They do not exceed 87% of hydraulic lifting capacity or 75% of tipping load. Weight of all lifting accessories must be deducted from the above lifting capacities. Lifting capacities are based on the machine standing on a firm, uniform supporting surface. The use of a work tool attachment point to handle/lift objects, could affect the machine lift performance.

Lift capacity stays with ±5% for all available track shoes.

Always refer to the appropriate Operation and Maintenance Manual for specific product information.

# 340 Hydraulic Excavator Specifications

## HD Reach Boom Lift Capacities – Counterweight: 7.56 mt (16,700 lb) – without Bucket, Heavy Lift: On

Long Wide Undercarriage

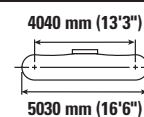
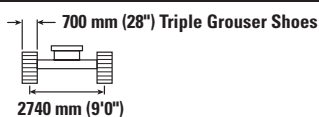

		3000 mm/10'0"		4500 mm/15'0"		6000 mm/20'0"		7500 mm/25'0"		9000 mm/30'0"		mm ft/in		
7500 mm 25'0"	kg lb							*8700 *16,300	8450 *16,300			*7350 *16,200	*7350 *16,200	7720 25'0"
6000 mm 20'0"	kg lb							*8800 *19,300	8400 18,000			*7150 *15,700	6700 14,850	8590 28'0"
4500 mm 15'0"	kg lb			*13 450 *28,900	*13 450 *28,900	*10 800 *23,400	*10 800 *23,400	*9450 *20,600	8150 17,550	*8450 6100		*7200 *15,800	5950 13,150	9140 29'10"
3000 mm 10'0"	kg lb			*17 050 *36,600	16 550 35,650	*12 500 *27,050	10 850 23,400	*10 350 *22,450	7850 16,900	8650 18,600	5950 12,800	*7450 *16,400	5550 12,250	9410 30'10"
1500 mm 5'0"	kg lb			*19 600 *42,250	15 550 33,450	*14 000 *30,250	10 350 22,250	11 150 24,000	7550 16,300	8500 18,300	5800 12,500	7950 17,450	5450 11,950	9440 30'11"
0 mm 0'0"	kg lb			*20 400 *44,200	15 100 32,500	*14 850 *32,150	10 000 21,500	10 900 23,500	7350 15,850	8400 18,050	5700 12,300	8100 17,850	5550 12,200	9220 30'2"
-1500 mm -5'0"	kg lb	*14 100 *31,900	*14 100 *31,900	*20 000 *43,350	15 050 32,300	*14 950 *32,350	9850 21,200	10 800 23,250	7250 15,600			8700 19,250	5950 13,050	8740 28'7"
-3000 mm -10'0"	kg lb	*22 250 *50,350	*22 250 *50,350	*18 550 *40,150	15 150 32,550	*14 100 *30,500	9900 21,300	10 850 23,400	7300 15,750			*10 000 *22,050	6800 15,000	7950 25'11"
-4500 mm -15'0"	kg lb	*20 800 *44,850	*20 800 *44,850	*15 700 *33,700	15 500 33,300	*11 900 *25,250	10 100 21,800					*10 050 *22,100	8650 19,400	6740 21'10"

## HD Reach Boom Lift Capacities – Counterweight: 7.56 mt (16,700 lb) – without Bucket, Heavy Lift: On

Long Wide Undercarriage

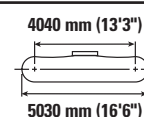
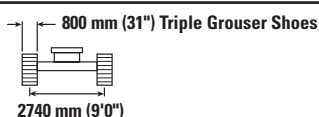
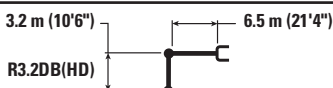

		3000 mm/10'0"		4500 mm/15'0"		6000 mm/20'0"		7500 mm/25'0"		9000 mm/30'0"		mm ft/in		
7500 mm 25'0"	kg lb							*8700 *16,300	8600 *16,300			*7350 *16,200	*7350 *16,200	7720 25'0"
6000 mm 20'0"	kg lb							*8800 *19,300	8500 18,250			*7150 *15,700	6800 15,050	8590 28'0"
4500 mm 15'0"	kg lb			*13 450 *28,900	*13 450 *28,900	*10 800 *23,400	*10 800 *23,400	*9450 *20,600	8250 17,800	*8450 6200		*7200 *15,800	6050 13,350	9140 29'10"
3000 mm 10'0"	kg lb			*17 050 *36,600	16 750 36,150	*12 500 *27,050	11 000 23,750	*10 350 *22,450	7950 17,150	8800 18,900	6050 13,000	*7450 *16,400	5650 12,450	9410 30'10"
1500 mm 5'0"	kg lb			*19 600 *42,250	15 800 34,000	*14 000 *30,250	10 500 22,600	*11 200 *24,250	7700 16,550	8650 18,600	5900 12,700	*8000 *17,600	5500 12,150	9440 30'11"
0 mm 0'0"	kg lb			*20 400 *44,200	15 350 33,050	*14 850 *32,150	10 150 21,850	11 100 23,900	7450 16,100	8550 18,350	5800 12,500	8250 18,150	5650 12,400	9220 30'2"
-1500 mm -5'0"	kg lb	*14 100 *31,900	*14 100 *31,900	*20 000 *43,350	15 250 32,800	*14 950 *32,350	10 000 21,550	11 000 23,650	7350 15,850			8850 19,550	6050 13,300	8740 28'7"
-3000 mm -10'0"	kg lb	*22 250 *50,350	*22 250 *50,350	*18 550 *40,150	15 400 33,100	*14 100 *30,500	10 050 21,600	*10 950 *23,400	7400 16,000			*10 000 *22,050	6900 15,250	7950 25'11"
-4500 mm -15'0"	kg lb	*20 800 *44,850	*20 800 *44,850	*15 700 *33,700	15 700 *33,700	*11 900 *25,250	10 250 22,150					*10 050 *22,100	8800 19,700	6740 21'10"



ISO 10567:2007



\* Indicates that the load is limited by hydraulic lifting capacity rather than tipping load. The above loads are in compliance with hydraulic excavator lift capacity standard ISO 10567:2007. They do not exceed 87% of hydraulic lifting capacity or 75% of tipping load. Weight of all lifting accessories must be deducted from the above lifting capacities. Lifting capacities are based on the machine standing on a firm, uniform supporting surface. The use of a work tool attachment point to handle/lift objects, could affect the machine lift performance.

Lift capacity stays with ±5% for all available track shoes.

Always refer to the appropriate Operation and Maintenance Manual for specific product information.

# 340 Hydraulic Excavator Specifications

## Reach Boom Lift Capacities – Counterweight: 7.56 mt (16,700 lb) – without Bucket, Heavy Lift: On

Long Undercarriage

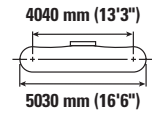
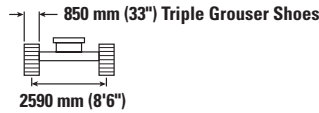
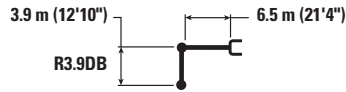

Reach	Unit	1500 mm/5'0"		3000 mm/10'0"		4500 mm/15'0"		6000 mm/20'0"		7500 mm/25'0"		9000 mm/30'0"		mm		mm ft/in	
		kg	lb	kg	lb	kg	lb	kg	lb	kg	lb	kg	lb	kg	lb		
9000 mm	kg														*6200	7350	
30'0"	lb														*13,800	13,800	23'7"
7500 mm	kg									*7700	*7700				*5750	8540	
25'0"	lb									*16,950	*16,950				*12,750	12,750	27'8"
6000 mm	kg									*8000	*8000	*7450	6100		*5600	9340	
20'0"	lb									*17,450	*17,450	*14,400	13,000		*12,350	12,350	30'5"
4500 mm	kg							*9750	*9750	*8750	7950	*8150	6000		*5600	5150	9840
15'0"	lb							*21,150	*21,150	*19,000	17,150	*17,850	12,800		*12,350	11,350	32'2"
3000 mm	kg					*15 300	*15 300	*11 600	10 600	*9750	7650	*8650	5800		*5800	4850	10 100
10'0"	lb					*32,850	*32,850	*25,050	22,900	*21,100	16,450	*18,900	12,500		*12,700	10,650	33'1"
1500 mm	kg					*18 450	15 100	*13 300	10 050	*10 700	7350	8700	5650		*6150	4700	10 130
5'0"	lb					*39,800	32,550	*28,750	21,650	*23,200	15,800	18,700	12,100		*13,450	10,400	33'2"
0 mm	kg			*8250	*8250	*20 100	14 450	*14 500	9650	11 150	7100	8550	5500		*6700	4800	9930
0'0"	lb			*18,700	*18,700	*43,500	31,150	*31,400	20,750	23,950	15,250	18,350	11,800		*14,700	10,500	32'6"
-1500 mm	kg	*8600	*8600	*12 900	*12 900	*20 350	14 250	*15 000	9400	10 950	6950	8450	5400		*7600	5050	9490
-5'0"	lb	*19,200	*19,200	*29,100	*29,100	*44,100	30,600	*32,450	20,250	23,600	14,900	18,200	11,650		*16,750	11,150	31'1"
-3000 mm	kg	*13 650	*13 650	*18 800	*18 800	*19 500	14 250	*14 650	9350	10 950	6900				8800	5650	8770
-10'0"	lb	*30,550	*30,550	*42,500	*42,500	*42,200	30,650	*31,600	20,150	23,550	14,850				19,450	12,450	28'7"
-4500 mm	kg	*19 600	*19 600	*24 100	*24 100	*17 400	14 450	*13 200	9500	*9900	7050				*9450	6850	7690
-15'0"	lb	*44,000	*44,000	*52,000	*52,000	*37,450	31,100	*28,300	20,450	*20,850	15,250				*20,800	15,200	25'0"
-6000 mm	kg					*13 250	*13 250	*9400	*9400						*9250	*9250	6060
-20'0"	lb					*27,950	*27,950								*20,200	*20,200	19'5"



ISO 10567:2007



\* Indicates that the load is limited by hydraulic lifting capacity rather than tipping load. The above loads are in compliance with hydraulic excavator lift capacity standard ISO 10567:2007. They do not exceed 87% of hydraulic lifting capacity or 75% of tipping load. Weight of all lifting accessories must be deducted from the above lifting capacities. Lifting capacities are based on the machine standing on a firm, uniform supporting surface. The use of a work tool attachment point to handle/lift objects, could affect the machine lift performance.

Lift capacity stays with ±5% for all available track shoes.

Always refer to the appropriate Operation and Maintenance Manual for specific product information.



# 340 Hydraulic Excavator Specifications

## Reach Boom Lift Capacities – Counterweight: 7.56 mt (16,700 lb) – without Bucket, Heavy Lift: On

Long Undercarriage

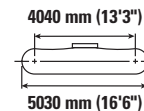
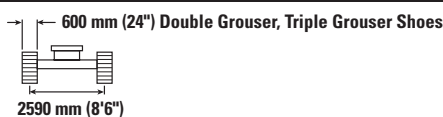

		1500 mm/5'0"		3000 mm/10'0"		4500 mm/15'0"		6000 mm/20'0"		7500 mm/25'0"		9000 mm/30'0"		mm ft/in		
9000 mm 30'0"	kg lb													*6200 *13,800	*6200 *13,800	7350 23'7"
7500 mm 25'0"	kg lb									*7700 *16,950	*7700 *16,950			*5750 *12,750	*5750 *12,750	8540 27'8"
6000 mm 20'0"	kg lb											*7450 *14,400	5900 12,650	*5600 *12,350	5550 12,300	9340 30'5"
4500 mm 15'0"	kg lb							*9750 *21,150	*9750 *21,150	*8750 *19,000	7750 16,700	*8150 *17,850	5800 12,450	*5600 *12,350	5000 11,000	9840 32'2"
3000 mm 10'0"	kg lb				*15 300 *32,850	*15 300 *32,850	*11 600 *25,050	10 350 22,300	*9750 *21,100	7450 16,000	8600 18,500	5650 12,100	*5800 *12,700	4700 10,300	10 100 33'1"	
1500 mm 5'0"	kg lb				*18 450 *39,800	14 700 31,650	*13 300 *28,750	9750 21,050	*10 700 *23,200	7150 15,350	8450 18,100	5450 11,750	*6150 *13,450	4600 10,050	10 130 33'2"	
0 mm 0'0"	kg lb			*8250 *18,700	*8250 *18,700	*20 100 *43,500	14 050 30,250	*14 500 *31,400	9350 20,150	10 800 23,250	6850 14,800	8250 17,800	5350 11,450	*6700 *14,700	4650 10,200	9930 32'6"
-1500 mm -5'0"	kg lb	*8600 *19,200	*8600 *19,200	*12 900 *29,100	*12 900 *29,100	*20 350 *44,100	13 800 29,700	14 900 32,000	9150 19,650	10 650 22,850	6700 14,450	8200 17,650	5250 11,300	*7600 *16,750	4900 10,800	9490 31'1"
-3000 mm -10'0"	kg lb	*13 650 *30,550	*13 650 *30,550	*18 800 *42,500	*18 800 *42,500	*19 500 *42,200	13 850 29,750	*14 650 *31,600	9100 19,550	10 600 22,800	6700 14,400			8550 18,850	5450 12,100	8770 28'7"
-4500 mm -15'0"	kg lb	*19 600 *44,000	*19 600 *44,000	*24 100 *52,000	*24 100 *52,000	*17 400 *37,450	14 050 30,250	*13 200 *28,300	9200 19,850	*9900 *20,850	6850 14,800			*9450 *20,800	6650 14,750	7690 25'0"
-6000 mm -20'0"	kg lb					*13 250 *27,950	*13 250 *27,950	*9400 *9400						*9250 *20,200	*9250 *20,200	6060 19'5"



ISO 10567:2007



\* Indicates that the load is limited by hydraulic lifting capacity rather than tipping load. The above loads are in compliance with hydraulic excavator lift capacity standard ISO 10567:2007. They do not exceed 87% of hydraulic lifting capacity or 75% of tipping load. Weight of all lifting accessories must be deducted from the above lifting capacities. Lifting capacities are based on the machine standing on a firm, uniform supporting surface. The use of a work tool attachment point to handle/lift objects, could affect the machine lift performance.

Lift capacity stays with ±5% for all available track shoes.

Always refer to the appropriate Operation and Maintenance Manual for specific product information.

# 340 Hydraulic Excavator Specifications

## Reach Boom Lift Capacities – Counterweight: 7.56 mt (16,700 lb) – without Bucket, Heavy Lift: On

Long Undercarriage

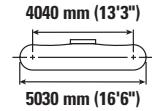
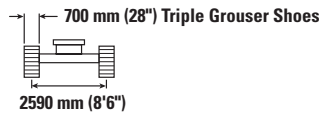
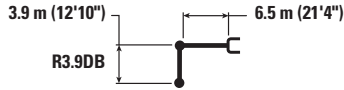

Reach Boom	Unit	1500 mm/5'0"		3000 mm/10'0"		4500 mm/15'0"		6000 mm/20'0"		7500 mm/25'0"		9000 mm/30'0"		mm ft/in		
		kg lb	kg lb	kg lb	kg lb	kg lb	kg lb	kg lb	kg lb	kg lb	kg lb	kg lb	kg lb	mm ft/in		
9000 mm 30'0"	kg lb													*6200 *13,800	*6200 *13,800	7350 23'7"
7500 mm 25'0"	kg lb									*7700 *16,950	*7700 *16,950			*5750 *12,750	*5750 *12,750	8540 27'8"
6000 mm 20'0"	kg lb									*8000 *17,450	*8000 17,350	*7450 *14,400	5950 12,750	*5600 *12,350	*5600 *12,350	5600 30'5"
4500 mm 15'0"	kg lb							*9750 *21,150	*9750 *21,150	*8750 *19,000	7850 16,850	*8150 *17,850	5850 12,550	*5600 *12,350	5050 11,100	9840 32'2"
3000 mm 10'0"	kg lb					*15 300 *32,850	*15 300 *32,850	*11 600 *25,050	10 400 22,450	*9750 *21,100	7500 16,150	*8650 18,700	5700 12,250	*5800 *12,700	4750 10,400	10 100 33'1"
1500 mm 5'0"	kg lb					*18 450 *39,800	14 800 31,900	*13 300 *28,750	9850 21,200	*10 700 *23,200	7200 15,450	8500 18,300	5500 11,850	*6150 *13,450	4600 10,150	10 130 33'2"
0 mm 0'0"	kg lb			*8250 *18,700	*8250 *18,700	*20 100 *43,500	14 200 30,500	*14 500 *31,400	9450 20,300	10 900 23,450	6950 14,950	8350 17,950	5400 11,550	*6700 *14,700	4700 10,300	9930 32'6"
-1500 mm -5'0"	kg lb	*8600 *19,200	*8600 *19,200	*12 900 *29,100	*12 900 *29,100	*20 350 *44,100	13 950 30,000	*15 000 *32,300	9200 19,850	10 750 23,100	6800 14,600	8250 17,800	5300 11,400	*7600 *16,750	4950 10,900	9490 31'1"
-3000 mm -10'0"	kg lb	*13 650 *30,550	*13 650 *30,550	*18 800 *42,500	*18 800 *42,500	*19 500 *42,200	13 950 30,000	*14 650 *31,600	9150 19,750	10 700 23,050	6750 14,550			8600 19,050	5500 12,200	8770 28'7"
-4500 mm -15'0"	kg lb	*19 600 *44,000	*19 600 *44,000	*24 100 *52,000	*24 100 *52,000	*17 400 *37,450	14 150 30,500	*13 200 *28,300	9300 20,050	*9900 *20,850	6900 14,900			*9450 *20,800	6700 14,900	7690 25'0"
-6000 mm -20'0"	kg lb					*13 250 *27,950	*13 250 *27,950	*9400 *9400						*9250 *20,200	*9250 *20,200	6060 19'5"



ISO 10567:2007



\* Indicates that the load is limited by hydraulic lifting capacity rather than tipping load. The above loads are in compliance with hydraulic excavator lift capacity standard ISO 10567:2007. They do not exceed 87% of hydraulic lifting capacity or 75% of tipping load. Weight of all lifting accessories must be deducted from the above lifting capacities. Lifting capacities are based on the machine standing on a firm, uniform supporting surface. The use of a work tool attachment point to handle/lift objects, could affect the machine lift performance.

Lift capacity stays with ±5% for all available track shoes.

Always refer to the appropriate Operation and Maintenance Manual for specific product information.

# 340 Hydraulic Excavator Specifications

## Reach Boom Lift Capacities – Counterweight: 7.56 mt (16,700 lb) – without Bucket, Heavy Lift: On

Long Undercarriage

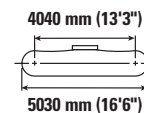
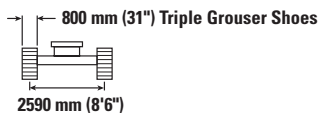

Reach Boom	Unit	1500 mm/5'0"		3000 mm/10'0"		4500 mm/15'0"		6000 mm/20'0"		7500 mm/25'0"		9000 mm/30'0"		mm ft/in			
		kg	lb	kg	lb	kg	lb	kg	lb	kg	lb	kg	lb	kg	lb	mm	ft/in
9000 mm 30'0"	kg														*6200	*6200	7350
	lb														*13,800	*13,800	23'7"
7500 mm 25'0"	kg									*7700	*7700				*5750	*5750	8540
	lb									*16,950	*16,950				*12,750	*12,750	27'8"
6000 mm 20'0"	kg									*8000	*8000	*7450	6050		*5600	*5600	9340
	lb									*17,450	*17,450	*14,400	12,950		*12,350	*12,350	30'5"
4500 mm 15'0"	kg							*9750	*9750	*8750	7950	*8150	5950		*5600	5100	9840
	lb							*21,150	*21,150	*19,000	17,050	*17,850	12,750		*11,300	11,300	32'2"
3000 mm 10'0"	kg					*15 300	*15 300	*11 600	10 550	*9750	7600	*8650	5800		*5800	4800	10 100
	lb					*32,850	*32,850	*25,050	22,750	*21,100	16,400	*18,900	12,400		*12,700	10,600	33'1"
1500 mm 5'0"	kg					*18 450	15 050	*13 300	10 000	*10 700	7300	8650	5600		*6150	4700	10 130
	lb					*39,800	32,400	*28,750	21,550	*23,200	15,700	18,600	12,050		*13,450	10,300	33'2"
0 mm 0'0"	kg			*8250	*8250	*20 100	14 400	*14 500	9600	11 100	7050	8500	5450		*6700	4750	9930
	lb			*18,700	*18,700	*43,500	31,000	*31,400	20,650	23,850	15,150	18,250	11,750		*14,700	10,450	32'6"
-1500 mm -5'0"	kg	*8600	*8600	*12 900	*12 900	*20 350	14 150	*15 000	9350	10 900	6900	8400	5400		*7600	5050	9490
	lb	*19,200	*19,200	*29,100	*29,100	*44,100	30,450	*32,450	20,150	23,450	14,850	18,100	11,600		*16,750	11,100	31'1"
-3000 mm -10'0"	kg	*13 650	*13 650	*18 800	*18 800	*19 500	14 150	*14 650	9300	10 900	6850				8750	5600	8770
	lb	*30,550	*30,550	*42,500	*42,500	*42,200	30,500	*31,600	20,050	23,400	14,800				19,350	12,400	28'7"
-4500 mm -15'0"	kg	*19 600	*19 600	*24 100	*24 100	*17 400	14 400	*13 200	9450	*9900	7000				*9450	6800	7690
	lb	*44,000	*44,000	*52,000	*52,000	*37,450	30,950	*28,300	20,350	*20,850	15,150				*20,800	15,150	25'0"
-6000 mm -20'0"	kg					*13 250	*13 250	*9400	*9400						*9250	*9250	6060
	lb					*27,950	*27,950	*9400	*9400						*20,200	*20,200	19'5"



ISO 10567:2007



\* Indicates that the load is limited by hydraulic lifting capacity rather than tipping load. The above loads are in compliance with hydraulic excavator lift capacity standard ISO 10567:2007. They do not exceed 87% of hydraulic lifting capacity or 75% of tipping load. Weight of all lifting accessories must be deducted from the above lifting capacities. Lifting capacities are based on the machine standing on a firm, uniform supporting surface. The use of a work tool attachment point to handle/lift objects, could affect the machine lift performance.

Lift capacity stays with ±5% for all available track shoes.

Always refer to the appropriate Operation and Maintenance Manual for specific product information.

# 340 Hydraulic Excavator Specifications

## Reach Boom Lift Capacities – Counterweight: 7.56 mt (16,700 lb) – without Bucket, Heavy Lift: On

Long Undercarriage

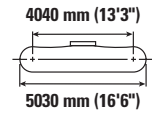
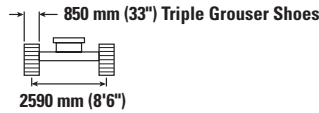
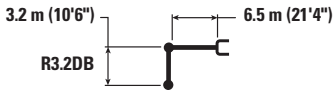

Reach	Unit	3000 mm/10'0"		4500 mm/15'0"		6000 mm/20'0"		7500 mm/25'0"		9000 mm/30'0"		mm ft/in		
		kg lb	kg lb	kg lb	kg lb	kg lb	kg lb	kg lb	kg lb	kg lb	kg lb	kg lb	kg lb	
7500 mm 25'0"	kg lb							*8750 8200				*7350 *16,300	*7350 *16,300	7700 24'11"
6000 mm 20'0"	kg lb							*8900 *19,450	8100 17,450			*7150 *15,800	6500 14,450	8580 27'11"
4500 mm 15'0"	kg lb			*13 500 *36,800	*13 500 34,100	*10 900 *23,550	*10 900 *23,550	*9550 *20,800	7900 16,950	*8450	5950	*7200 *15,850	5800 12,800	9130 29'10"
3000 mm 10'0"	kg lb			*17 150 *36,800	15 800 34,100	*12 600 *27,250	10 450 22,550	*10 450 *22,650	7600 16,350	8850 19,050	5800 12,450	*7500 *16,500	5400 11,950	9410 30'10"
1500 mm 5'0"	kg lb			*19 750 *42,550	14 850 32,050	*14 100 *30,500	9950 21,500	*11 300 *24,450	7350 15,800	8700 18,750	5650 12,200	*8050 *17,650	5300 11,650	9440 30'11"
0 mm 0'0"	kg lb			*20 600 *44,600	14 450 31,150	*15 000 *32,450	9650 20,800	11 150 24,050	7150 15,350	8600 18,500	5550 12,000	8300 18,300	5400 11,850	9220 30'2"
-1500 mm -5'0"	kg lb	*14 050 *31,800	*14 050 *31,800	*20 200 *43,800	14 400 30,950	*15 100 *32,700	9500 20,500	11 050 23,800	7050 15,150			8950 19,700	5750 12,700	8750 28'7"
-3000 mm -10'0"	kg lb	*22 200 *50,200	*22 200 *50,200	*18 750 *40,600	14 500 31,200	*14 300 *30,850	9550 20,550	*11 050 *23,700	7100 15,250			*10 100 *22,300	6550 14,550	7960 25'11"
-4500 mm -15'0"	kg lb	*21 100 *45,450	*21 100 *45,450	*15 900 *34,150	14 800 31,900	*12 050 *25,650	9750 21,050					*10 200 *22,400	8350 18,700	6750 21'10"

## Reach Boom Lift Capacities – Counterweight: 7.56 mt (16,700 lb) – without Bucket, Heavy Lift: On

Long Undercarriage

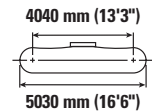
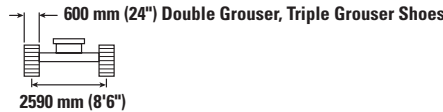
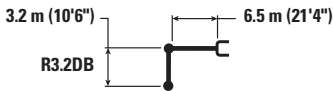

Reach	Unit	3000 mm/10'0"		4500 mm/15'0"		6000 mm/20'0"		7500 mm/25'0"		9000 mm/30'0"		mm ft/in		
		kg lb	kg lb	kg lb	kg lb	kg lb	kg lb	kg lb	kg lb	kg lb	kg lb	kg lb	kg lb	
7500 mm 25'0"	kg lb							*8750 7950				*7350 *16,300	*7350 *16,300	7700 24'11"
6000 mm 20'0"	kg lb							*8900 *19,450	7900 17,000			*7150 *15,800	6300 14,050	8580 27'11"
4500 mm 15'0"	kg lb			*13 500 *36,800	*13 500 34,100	*10 900 *23,550	10 750 23,150	*9550 *20,800	7700 16,550	*8450	5750	*7200 *15,850	5650 12,450	9130 29'10"
3000 mm 10'0"	kg lb			*17 150 *36,800	15 400 33,200	*12 600 *27,250	10 200 21,950	*10 450 *22,650	7400 15,900	8600 18,450	5650 12,100	*7500 *16,500	5250 11,600	9410 30'10"
1500 mm 5'0"	kg lb			*19 750 *42,550	14 450 31,150	*14 100 *30,500	9700 20,900	11 050 23,800	7100 15,350	8450 18,150	5500 11,800	7900 17,350	5150 11,300	9440 30'11"
0 mm 0'0"	kg lb			*20 600 *44,600	14 050 30,250	*15 000 *32,450	9350 20,200	10 850 23,300	6900 14,900	8350 17,950	5400 11,600	8050 17,750	5250 11,500	9220 30'2"
-1500 mm -5'0"	kg lb	*14 050 *31,800	*14 050 *31,800	*20 200 *43,800	14 000 30,050	15 000 32,200	9250 19,900	10 750 23,100	6850 14,700			8650 19,100	5600 12,300	8750 28'7"
-3000 mm -10'0"	kg lb	*22 200 *50,200	*22 200 *50,200	*18 750 *40,600	14 100 30,300	*14 300 *30,850	9250 19,950	10 800 23,200	6850 14,800			9950 22,000	6400 14,100	7960 25'11"
-4500 mm -15'0"	kg lb	*21 100 *45,450	*21 100 *45,450	*15 900 *34,150	14 400 31,000	*12 050 *25,650	9500 20,450					*10 200 *22,400	8150 18,200	6750 21'10"



ISO 10567:2007



\* Indicates that the load is limited by hydraulic lifting capacity rather than tipping load. The above loads are in compliance with hydraulic excavator lift capacity standard ISO 10567:2007. They do not exceed 87% of hydraulic lifting capacity or 75% of tipping load. Weight of all lifting accessories must be deducted from the above lifting capacities. Lifting capacities are based on the machine standing on a firm, uniform supporting surface. The use of a work tool attachment point to handle/lift objects, could affect the machine lift performance.

Lift capacity stays with ±5% for all available track shoes.

Always refer to the appropriate Operation and Maintenance Manual for specific product information.

# 340 Hydraulic Excavator Specifications

## Reach Boom Lift Capacities – Counterweight: 7.56 mt (16,700 lb) – without Bucket, Heavy Lift: On

Long Undercarriage

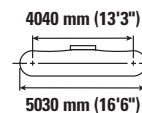
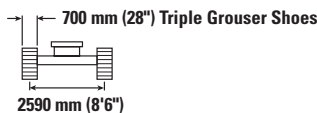

Reach	Unit	3000 mm/10'0"		4500 mm/15'0"		6000 mm/20'0"		7500 mm/25'0"		9000 mm/30'0"		mm ft/in		
		kg lb	kg lb	kg lb	kg lb	kg lb	kg lb	kg lb	kg lb	kg lb	kg lb	kg lb	kg lb	
7500 mm 25'0"	kg lb							*8750 8050				*7350 *16,300	*7350 *16,300	7700 24'11"
6000 mm 20'0"	kg lb							*8900 *19,450	7950 17,100			*7150 *15,800	6350 14,150	8580 27'11"
4500 mm 15'0"	kg lb			*13 500 13 500	*13 500 13 500	*10 900 *23,550	10 850 23,350	*9550 *20,800	7750 16,650	*8450 5800		*7200 *15,850	5650 12,550	9130 29'10"
3000 mm 10'0"	kg lb			*17 150 *36,800	15 500 33,450	*12 600 *27,250	10 250 22,150	*10 450 *22,650	7450 16,050	8650 18,650	5700 12,200	*7500 *16,500	5300 11,700	9410 30'10"
1500 mm 5'0"	kg lb			*19 750 *42,550	14 600 31,400	*14 100 *30,500	9750 21,050	11 150 24,000	7200 15,450	8500 18,350	5550 11,950	7950 17,500	5200 11,400	9440 30'11"
0 mm 0'0"	kg lb			*20 600 *44,600	14 200 30,500	*15 000 *32,450	9450 20,350	10 950 23,550	7000 15,050	8400 18,100	5450 11,750	8150 17,900	5250 11,600	9220 30'2"
-1500 mm -5'0"	kg lb	*14 050 *31,800	*14 050 *31,800	*20 200 *43,800	14 100 30,300	*15 100 *32,500	9300 20,050	10 850 23,300	6900 14,850			8750 19,250	5650 12,400	8750 28'7"
-3000 mm -10'0"	kg lb	*22 200 *50,200	*22 200 *50,200	*18 750 *40,600	14 200 30,550	*14 300 *30,850	9350 20,150	10 900 23,450	6950 14,950			10 050 22,200	6450 14,250	7960 25'11"
-4500 mm -15'0"	kg lb	*21 100 *45,450	*21 100 *45,450	*15 900 *34,150	14 500 31,250	*12 050 *25,650	9550 20,650					*10 200 *22,400	8200 18,350	6750 21'10"

## Reach Boom Lift Capacities – Counterweight: 7.56 mt (16,700 lb) – without Bucket, Heavy Lift: On

Long Undercarriage

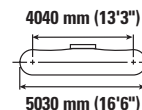
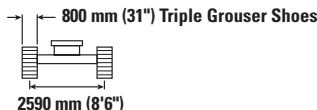
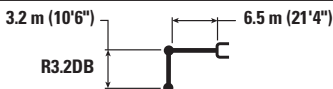

Reach	Unit	3000 mm/10'0"		4500 mm/15'0"		6000 mm/20'0"		7500 mm/25'0"		9000 mm/30'0"		mm ft/in		
		kg lb	kg lb	kg lb	kg lb	kg lb	kg lb	kg lb	kg lb	kg lb	kg lb	kg lb	kg lb	
7500 mm 25'0"	kg lb							*8750 8150				*7350 *16,300	*7350 *16,300	7700 24'11"
6000 mm 20'0"	kg lb							*8900 *19,450	8100 17,350			*7150 *15,800	6450 14,350	8580 27'11"
4500 mm 15'0"	kg lb			*13 500 13 500	*13 500 13 500	*10 900 *23,550	*10 900 *23,550	*9550 *20,800	7850 16,900	*8450 5900		*7200 *15,850	5750 12,750	9130 29'10"
3000 mm 10'0"	kg lb			*17 150 *36,800	15 700 33,950	*12 600 *27,250	10 400 22,450	*10 450 *22,650	7550 16,300	8800 18,950	5750 12,400	*7500 *16,500	5400 11,850	9410 30'10"
1500 mm 5'0"	kg lb			*19 750 *42,550	14 800 31,900	*14 100 *30,500	9900 21,400	*11 300 24,400	7300 15,700	8650 18,650	5650 12,100	*8050 *17,650	5250 11,600	9440 30'11"
0 mm 0'0"	kg lb			*20 600 *44,600	14 400 31,000	*15 000 *32,450	9600 20,700	11 100 23,900	7100 15,300	8550 18,400	5550 11,900	8250 18,200	5350 11,800	9220 30'2"
-1500 mm -5'0"	kg lb	*14 050 *31,800	*14 050 *31,800	*20 200 *43,800	14 300 30,800	*15 100 *32,700	9450 20,400	11 000 23,700	7000 15,100			8900 19,600	5750 12,650	8750 28'7"
-3000 mm -10'0"	kg lb	*22 200 *50,200	*22 200 *50,200	*18 750 *40,600	14 450 31,050	*14 300 *30,850	9500 20,450	11 050 *23,700	7050 15,200			*10 100 *22,300	6550 14,450	7960 25'11"
-4500 mm -15'0"	kg lb	*21 100 *45,450	*21 100 *45,450	*15 900 *34,150	14 750 31,750	*12 050 *25,650	9700 20,950					*10 200 *22,400	8350 18,600	6750 21'10"



ISO 10567:2007



\* Indicates that the load is limited by hydraulic lifting capacity rather than tipping load. The above loads are in compliance with hydraulic excavator lift capacity standard ISO 10567:2007. They do not exceed 87% of hydraulic lifting capacity or 75% of tipping load. Weight of all lifting accessories must be deducted from the above lifting capacities. Lifting capacities are based on the machine standing on a firm, uniform supporting surface. The use of a work tool attachment point to handle/lift objects, could affect the machine lift performance.

Lift capacity stays with ±5% for all available track shoes.

Always refer to the appropriate Operation and Maintenance Manual for specific product information.

# 340 Hydraulic Excavator Specifications

## Reach Boom Lift Capacities – Counterweight: 7.56 mt (16,700 lb) – without Bucket, Heavy Lift: On

Long Undercarriage

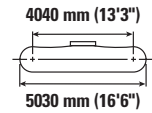
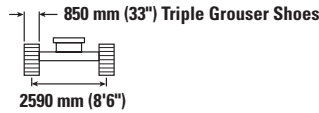
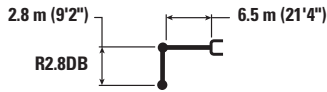

Reach mm ft/in	kg lb	3000 mm/10'0"		4500 mm/15'0"		6000 mm/20'0"		7500 mm/25'0"		9000 mm/30'0"		mm ft/in		
7500 mm 25'0"	kg lb											*9350 *20,650	8400 18,850	7340 23'9"
6000 mm 20'0"	kg lb					*10 100 *21,950	*10 100 *21,950	*9400 *20,600	8050 17,300			*8950 *19,800	6900 15,300	8250 26'10"
4500 mm 15'0"	kg lb			*14 550 *31,250	*14 550 *31,250	*11 500 *24,850	10 950 23,550	*10 000 *21,750	7850 16,900			*9000 *19,750	6100 13,450	8820 28'10"
3000 mm 10'0"	kg lb			*18 150 *38,950	15 550 33,600	*13 150 *28,400	10 400 22,400	*10 800 *23,450	7600 16,350	8850	5800	8700 19,150	5700 12,550	9110 29'10"
1500 mm 5'0"	kg lb			*16 850 *41,100	14 800 31,850	*14 500 *31,400	9950 21,450	11 400 24,500	7350 15,800	8750	5700	8550 18,800	5550 12,250	9140 29'11"
0 mm 0'0"	kg lb			*19 850 *44,800	14 500 31,250	*15 200 *32,900	9650 20,850	11 200 24,100	7150 15,450			8750 19,300	5700 12,550	8920 29'2"
-1500 mm -5'0"	kg lb	*13 150 *29,900	*13 150 *29,900	*19 900 *43,200	14 500 31,200	*15 050 *32,600	9600 20,650	11 150 24,000	7100 15,300			9500 20,950	6150 13,500	8420 27'7"
-3000 mm -10'0"	kg lb	*23 600 *51,850	*23 600 *51,850	*18 150 *39,300	14 650 31,550	*13 950 *30,100	9650 20,800	*10 600 23,800	7200			*10 350 *22,750	7100 15,700	7600 24'9"
-4500 mm -15'0"	kg lb	*19 100 *41,050	*19 100 *41,050	*14 800 *31,750	*14 800 *31,750	*11 050 *23,150	9950 21,500					*10 100 *22,150	9300 20,850	6330 20'5"

## Reach Boom Lift Capacities – Counterweight: 7.56 mt (16,700 lb) – without Bucket, Heavy Lift: On

Long Undercarriage

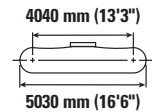
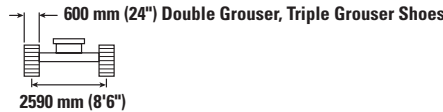
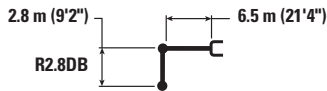

Reach mm ft/in	kg lb	3000 mm/10'0"		4500 mm/15'0"		6000 mm/20'0"		7500 mm/25'0"		9000 mm/30'0"		mm ft/in		
7500 mm 25'0"	kg lb											*9350 *20,650	8150 18,350	7340 23'9"
6000 mm 20'0"	kg lb					*10 100 *21,950	*10 100 *21,950	*9400 *20,600	7850 16,850			*8950 *19,800	6700 14,900	8250 26'10"
4500 mm 15'0"	kg lb			*14 550 *31,250	*14 550 *31,250	*11 500 *24,850	10 650 22,950	*10 000 *21,750	7650 16,450			*9000 *19,750	5900 13,100	8820 28'10"
3000 mm 10'0"	kg lb			*18 150 *38,950	15 150 32,700	*13 150 *28,400	10 100 21,800	*10 800 *23,450	7400 15,900	8600	5650	8450 18,600	5550 12,200	9110 29'10"
1500 mm 5'0"	kg lb			*16 850 *41,100	14 350 30,950	*14 500 *31,400	9650 20,850	11 050 23,800	7150 15,350	8450	5500	8300 18,250	5400 11,900	9140 29'11"
0 mm 0'0"	kg lb			*19 850 *44,800	14 100 30,350	15 150 32,600	9400 20,250	10 850 23,400	6950 15,000			8500 18,700	5550 12,150	8920 29'2"
-1500 mm -5'0"	kg lb	*13 150 *29,900	*13 150 *29,900	*19 900 *43,200	14 100 30,300	15 050 32,350	9300 20,050	10 800 23,250	6900 14,850			9200 20,300	5950 13,100	8420 27'7"
-3000 mm -10'0"	kg lb	*23 600 *51,850	*23 600 *51,850	*18 150 *39,300	14 250 30,650	*13 950 *30,100	9400 20,200	*10 600 23,800	7000			*10 350 *22,750	6900 15,250	7600 24'9"
-4500 mm -15'0"	kg lb	*19 100 *41,050	*19 100 *41,050	*14 800 *31,750	14 600 31,500	*11 050 *23,150	9650 20,900					*10 100 *22,150	9050 20,300	6330 20'5"



ISO 10567:2007



\* Indicates that the load is limited by hydraulic lifting capacity rather than tipping load. The above loads are in compliance with hydraulic excavator lift capacity standard ISO 10567:2007. They do not exceed 87% of hydraulic lifting capacity or 75% of tipping load. Weight of all lifting accessories must be deducted from the above lifting capacities. Lifting capacities are based on the machine standing on a firm, uniform supporting surface. The use of a work tool attachment point to handle/lift objects, could affect the machine lift performance.

Lift capacity stays with ±5% for all available track shoes.

Always refer to the appropriate Operation and Maintenance Manual for specific product information.

# 340 Hydraulic Excavator Specifications

## Reach Boom Lift Capacities – Counterweight: 7.56 mt (16,700 lb) – without Bucket, Heavy Lift: On

Long Undercarriage

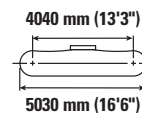
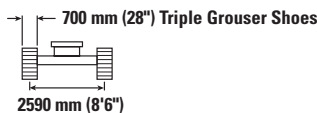

		3000 mm/10'0"		4500 mm/15'0"		6000 mm/20'0"		7500 mm/25'0"		9000 mm/30'0"		mm ft/in		
7500 mm 25'0"	kg lb											*9350 *20,650	8250 18,500	7340 23'9"
6000 mm 20'0"	kg lb					*10 100 *21,950	*10 100 *21,950	*9400 *20,600	7900 17,000			*8950 *19,800	6750 15,000	8250 26'10"
4500 mm 15'0"	kg lb			*14 550 *31,250	*14 550 *31,250	*11 500 *24,850	10 750 23,150	*10 000 *21,750	7700 16,550			*9000 *19,750	6000 13,200	8820 28'10"
3000 mm 10'0"	kg lb			*18 150 *38,950	15 250 32,950	*13 150 *28,400	10 200 22,000	*10 800 *23,450	7450 16,000	8650	5700	8500 18,750	5600 12,300	9110 29'10"
1500 mm 5'0"	kg lb			*16 850 *41,100	14 500 31,200	*14 500 *31,400	9750 21,000	11 150 24,000	7200 15,500	8550	5550	8350 18,400	5450 12,000	9140 29'11"
0 mm 0'0"	kg lb			*19 850 *44,800	14 250 30,600	*15 200 *32,900	9500 20,400	10 950 23,600	7000 15,100			8600 18,900	5600 12,250	8920 29'2"
-1500 mm -5'0"	kg lb	*13 150 *29,900	*13 150 *29,900	*19 900 *43,200	14 200 30,600	*15 050 *32,600	9400 20,200	10 900 23,450	6950 15,000			9300 20,500	6000 13,250	8420 27'7"
-3000 mm -10'0"	kg lb	*23 600 *51,850	*23 600 *51,850	*18 150 *39,300	14 400 30,900	*13 950 *30,100	9450 20,400	*10 600	7050			*10 350 *22,750	6950 15,400	7600 24'9"
-4500 mm -15'0"	kg lb	*19 100 *41,050	*19 100 *41,050	*14 800 *31,750	14 750 31,750	*11 050 *23,150	9750 21,100					*10 100 *22,150	9100 20,450	6330 20'5"

## Reach Boom Lift Capacities – Counterweight: 7.56 mt (16,700 lb) – without Bucket, Heavy Lift: On

Long Undercarriage

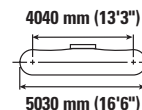
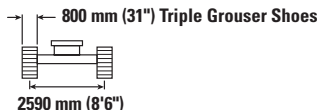
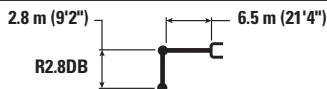

		3000 mm/10'0"		4500 mm/15'0"		6000 mm/20'0"		7500 mm/25'0"		9000 mm/30'0"		mm ft/in		
7500 mm 25'0"	kg lb											*9350 *20,650	8350 18,750	7340 23'9"
6000 mm 20'0"	kg lb					*10 100 *21,950	*10 100 *21,950	*9400 *20,600	8000 17,200			*8950 *19,800	6850 15,200	8250 26'10"
4500 mm 15'0"	kg lb			*14 550 *31,250	*14 550 *31,250	*11 500 *24,850	10 900 23,450	*10 000 *21,750	7800 16,800			*9000 *19,750	6050 13,400	8820 28'10"
3000 mm 10'0"	kg lb			*18 150 *38,950	15 500 33,450	*13 150 *28,400	10 350 22,300	*10 800 *23,450	7550 16,250	8800	5750	8650 19,050	5650 12,500	9110 29'10"
1500 mm 5'0"	kg lb			*16 850 *41,100	14 700 31,700	*14 500 *31,400	9900 21,350	11 350 24,400	7300 15,750	8700	5650	8500 18,700	5550 12,200	9140 29'11"
0 mm 0'0"	kg lb			*19 850 *44,800	14 450 31,100	*15 200 *32,900	9600 20,750	11 150 24,000	7150 15,350			8750 19,200	5650 12,450	8920 29'2"
-1500 mm -5'0"	kg lb	*13 150 *29,900	*13 150 *29,900	*19 900 *43,200	14 450 31,050	*15 050 *32,600	9550 20,550	11 100 23,850	7050 15,250			9450 20,800	6100 13,450	8420 27'7"
-3000 mm -10'0"	kg lb	*23 600 *51,850	*23 600 *51,850	*18 150 *39,300	14 600 31,400	*13 950 *30,100	9600 20,700	*10 600	7150			*10 350 *22,750	7050 15,650	7600 24'9"
-4500 mm -15'0"	kg lb	*19 100 *41,050	*19 100 *41,050	*14 800 *31,750	*14 800 *31,750	*11 050 *23,150	9900 21,400					*10 100 *22,150	9250 20,750	6330 20'5"



ISO 10567:2007



\* Indicates that the load is limited by hydraulic lifting capacity rather than tipping load. The above loads are in compliance with hydraulic excavator lift capacity standard ISO 10567:2007. They do not exceed 87% of hydraulic lifting capacity or 75% of tipping load. Weight of all lifting accessories must be deducted from the above lifting capacities. Lifting capacities are based on the machine standing on a firm, uniform supporting surface. The use of a work tool attachment point to handle/lift objects, could affect the machine lift performance.

Lift capacity stays with ±5% for all available track shoes.

Always refer to the appropriate Operation and Maintenance Manual for specific product information.



# 340 Hydraulic Excavator Specifications

## Mass Boom Lift Capacities – Counterweight: 7.56 mt (16,700 lb) – without Bucket, Heavy Lift: On

Long Undercarriage

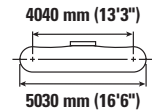
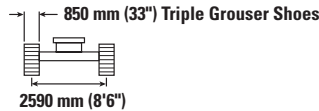

Boom Length mm ft/in	Weight kg lb	3000 mm/10'0"		4500 mm/15'0"		6000 mm/20'0"		7500 mm/25'0"		mm ft/in		
7500 mm 25'0"	kg lb					*10 150 *22,400	*10 150 *22,400			*9000 *19,900	*9000 *19,900	6580 21'3"
6000 mm 20'0"	kg lb					*10 500 *22,850	*10 500 *22,850	*9800	7700	*8550 *18,850	7550 16,850	7600 24'8"
4500 mm 15'0"	kg lb			*14 700 *31,550	*14 700 *31,550	*11 650 *25,300	10 650 23,000	*10 250 *22,300	7550 16,250	*8550 *18,850	6550 14,450	8210 26'10"
3000 mm 10'0"	kg lb			*18 000 *38,650	15 250 32,950	*13 150 *28,450	10 100 21,800	*10 900 *23,650	7300 15,750	*8900 *19,550	6000 13,250	8520 27'11"
1500 mm 5'0"	kg lb			*20 000 *43,200	14 450 31,100	*14 350 *31,100	9650 20,800	11 150 23,950	7050 15,200	9150 20,200	5850 12,900	8550 28'0"
0 mm 0'0"	kg lb			*20 200 *43,800	14 150 30,450	*14 900 *32,250	9400 20,200	10 950 23,600	6900 14,900	9450 20,850	6000 13,250	8310 27'3"
-1500 mm -5'0"	kg lb	*17 800 *40,400	*17 800 *40,400	*19 200 *41,650	14 150 30,450	*14 500 *31,400	9300 20,050	10 950 23,600	6900 14,850	10 400 23,000	6600 14,500	7780 25'5"
-3000 mm -10'0"	kg lb	*22 000 *47,800	*22 000 *47,800	*16 950 *36,600	14 400 30,950	*12 900 *27,650	9450 20,350			*10 600 *23,350	7900 17,500	6880 22'5"
-4500 mm -15'0"	kg lb			*12 450 *26,300	*12 450 *26,300					*9850 *21,500	*9850 *21,500	5430 17'6"

## Mass Boom Lift Capacities – Counterweight: 7.56 mt (16,700 lb) – without Bucket, Heavy Lift: On

Long Undercarriage

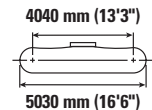
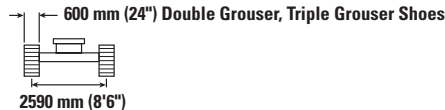
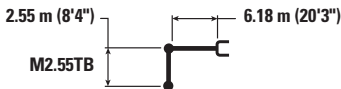

Boom Length mm ft/in	Weight kg lb	3000 mm/10'0"		4500 mm/15'0"		6000 mm/20'0"		7500 mm/25'0"		mm ft/in		
7500 mm 25'0"	kg lb					*10 150 *22,400	*10 150 *22,400			*9000 *19,900	*9000 *19,900	6580 21'3"
6000 mm 20'0"	kg lb					*10 500 *22,850	*10 500 *22,850	*9800	7500	*8550 *18,850	7350 16,350	7600 24'8"
4500 mm 15'0"	kg lb			*14 700 *31,550	*14 700 *31,550	*11 650 *25,300	10 400 22,400	*10 250 *22,300	7350 15,800	*8550 *18,850	6350 14,050	8210 26'10"
3000 mm 10'0"	kg lb			*18 000 *38,650	14 850 32,050	*13 150 *28,450	9850 21,200	*10 900 *23,650	7100 15,300	*8900 *19,550	5850 12,900	8520 27'11"
1500 mm 5'0"	kg lb			*20 000 *43,200	14 050 30,250	*14 350 *31,100	9350 20,200	10 800 23,250	6850 14,750	8900 19,550	5700 12,500	8550 28'0"
0 mm 0'0"	kg lb			*20 200 *43,800	13 750 29,600	14 900 32,000	9100 19,600	10 650 22,900	6700 14,450	9200 20,200	5850 12,850	8310 27'3"
-1500 mm -5'0"	kg lb	*17 800 *40,400	*17 800 *40,400	*19 200 *41,650	13 750 29,600	*14 500 *31,400	9050 19,450	10 600 22,850	6700 14,400	10 100 22,250	6400 14,100	7780 25'5"
-3000 mm -10'0"	kg lb	*22 000 *47,800	*22 000 *47,800	*16 950 *36,600	14 000 30,050	*12 900 *27,650	9150 19,750			*10 600 *23,350	7650 17,000	6880 22'5"
-4500 mm -15'0"	kg lb			*12 450 *26,300	*12 450 *26,300					*9850 *21,500	*9850 *21,500	5430 17'6"



ISO 10567:2007



\* Indicates that the load is limited by hydraulic lifting capacity rather than tipping load. The above loads are in compliance with hydraulic excavator lift capacity standard ISO 10567:2007. They do not exceed 87% of hydraulic lifting capacity or 75% of tipping load. Weight of all lifting accessories must be deducted from the above lifting capacities. Lifting capacities are based on the machine standing on a firm, uniform supporting surface. The use of a work tool attachment point to handle/lift objects, could affect the machine lift performance.

Lift capacity stays with ±5% for all available track shoes.

Always refer to the appropriate Operation and Maintenance Manual for specific product information.

# 340 Hydraulic Excavator Specifications

## Mass Boom Lift Capacities – Counterweight: 7.56 mt (16,700 lb) – without Bucket, Heavy Lift: On

Long Undercarriage

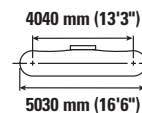
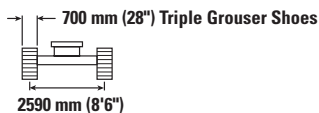

Boom Length	Unit	3000 mm/10'0"		4500 mm/15'0"		6000 mm/20'0"		7500 mm/25'0"		mm ft/in		
		Diagram	Diagram	Diagram	Diagram	Diagram	Diagram	Diagram	Diagram	Diagram	Diagram	
7500 mm 25'0"	kg lb					*10 150 *22,400	*10 150 *22,400			*9000 *19,900	*9000 *19,900	6580 21'3"
6000 mm 20'0"	kg lb					*10 500 *22,850	*10 500 *22,850	*9800	7550	*8550 *18,850	7400 16,500	7600 24'8"
4500 mm 15'0"	kg lb			*14 700 *31,550	*14 700 *31,550	*11 650 *25,300	10 450 22,550	*10 250 *22,300	7400 15,950	*8550 *18,850	6400 14,150	8210 26'10"
3000 mm 10'0"	kg lb			*18 000 *38,650	15 000 32,350	*13 150 *28,450	9900 21,350	*10 900 *23,650	7150 15,400	*8900 *19,550	5900 13,000	8520 27'11"
1500 mm 5'0"	kg lb			*20 000 *43,200	14 150 30,500	*14 350 *31,100	9450 20,350	10 900 23,450	6900 14,900	8950 19,750	5750 12,600	8550 28'0"
0 mm 0'0"	kg lb			*20 200 *43,800	13 850 29,850	*14 900 *32,250	9200 19,750	10 750 23,100	6750 14,550	9250 20,400	5900 12,950	8310 27'3"
-1500 mm -5'0"	kg lb	*17 800 *40,400	*17 800 *40,400	*19 200 *41,650	13 900 29,850	*14 500 *31,400	9100 19,600	10 700 23,050	6750 14,550	10 200 22,500	6450 14,200	7780 25'5"
-3000 mm -10'0"	kg lb	*22 000 *47,800	*22 000 *47,800	*16 950 *36,600	14 100 30,300	*12 900 *27,650	9250 19,950			*10 600 *23,350	7750 17,150	6880 22'5"
-4500 mm -15'0"	kg lb			*12 450 *26,300	*12 450 *26,300					*9850 *21,500	*9850 *21,500	5430 17'6"

## Mass Boom Lift Capacities – Counterweight: 7.56 mt (16,700 lb) – without Bucket, Heavy Lift: On

Long Undercarriage

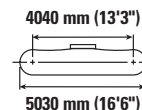
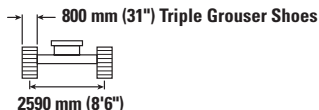
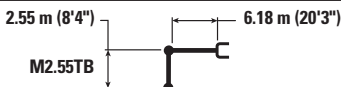

Boom Length	Unit	3000 mm/10'0"		4500 mm/15'0"		6000 mm/20'0"		7500 mm/25'0"		mm ft/in		
		Diagram	Diagram	Diagram	Diagram	Diagram	Diagram	Diagram	Diagram	Diagram	Diagram	
7500 mm 25'0"	kg lb					*10 150 *22,400	*10 150 *22,400			*9000 *19,900	*9000 *19,900	6580 21'3"
6000 mm 20'0"	kg lb					*10 500 *22,850	*10 500 *22,850	*9800	7700	*8550 *18,850	7500 16,750	7600 24'8"
4500 mm 15'0"	kg lb			*14 700 *31,550	*14 700 *31,550	*11 650 *25,300	10 600 22,900	*10 250 *22,300	7550 16,200	*8550 *18,850	6500 14,350	8210 26'10"
3000 mm 10'0"	kg lb			*18 000 *38,650	15 200 32,800	*13 150 *28,450	10 050 21,700	*10 900 *23,650	7250 15,650	*8900 *19,550	6000 13,200	8520 27'11"
1500 mm 5'0"	kg lb			*20 000 *43,200	14 350 30,950	*14 350 *31,100	9600 20,700	11 100 23,850	7050 15,150	9100 20,100	5850 12,850	8550 28'0"
0 mm 0'0"	kg lb			*20 200 *43,800	14 100 30,300	*14 900 *32,250	9350 20,100	10 900 23,500	6850 14,800	9400 20,750	6000 13,200	8310 27'3"
-1500 mm -5'0"	kg lb	*17 800 *40,400	*17 800 *40,400	*19 200 *41,650	14 100 30,300	*14 500 *31,400	9250 19,950	10 900 23,450	6850 14,800	10 350 22,850	6550 14,450	7780 25'5"
-3000 mm -10'0"	kg lb	*22 000 *47,800	*22 000 *47,800	*16 950 *36,600	14 300 30,800	*12 900 *27,650	9400 20,250			*10 600 *23,350	7850 17,450	6880 22'5"
-4500 mm -15'0"	kg lb			*12 450 *26,300	*12 450 *26,300					*9850 *21,500	*9850 *21,500	5430 17'6"



ISO 10567:2007



\* Indicates that the load is limited by hydraulic lifting capacity rather than tipping load. The above loads are in compliance with hydraulic excavator lift capacity standard ISO 10567:2007. They do not exceed 87% of hydraulic lifting capacity or 75% of tipping load. Weight of all lifting accessories must be deducted from the above lifting capacities. Lifting capacities are based on the machine standing on a firm, uniform supporting surface. The use of a work tool attachment point to handle/lift objects, could affect the machine lift performance.

Lift capacity stays with ±5% for all available track shoes.

Always refer to the appropriate Operation and Maintenance Manual for specific product information.

# 340 Hydraulic Excavator Specifications

## HD Reach Boom Lift Capacities – Counterweight: 7.56 mt (16,700 lb) – without Bucket, Heavy Lift: On

Long Undercarriage

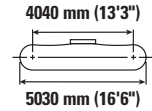
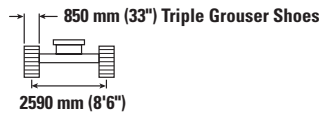
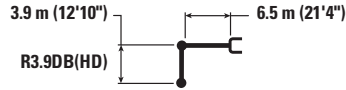

Reach (mm/ft/in)	kg/lb	1500 mm/5'0"		3000 mm/10'0"		4500 mm/15'0"		6000 mm/20'0"		7500 mm/25'0"		9000 mm/30'0"		mm/ft/in				
		kg	lb	kg	lb	kg	lb	kg	lb	kg	lb	kg	lb	kg	lb	mm	ft/in	
9000 mm 30'0"															*6150	*6150	7350	23'7"
7500 mm 25'0"										*7600	*7600				*5700	*5700	8540	27'8"
6000 mm 20'0"										*7900	*7900	*7400	6050	*5550	*5550	9340		
4500 mm 15'0"								*9700	*9700	*8650	7950	*8100	5900	*5550	5050	9840		
3000 mm 10'0"						*15 200	*15 200	*11 500	10 550	*9650	7600	*8600	5750	*5750	4750	10 100		
1500 mm 5'0"						*18 300	15 000	*13 200	9950	*10 600	7250	8650	5550	*6100	4650	10 130		
0 mm 0'0"				*8200	*8200	*19 950	14 350	*14 400	9550	11 050	7000	8450	5400	*6650	4700	9930		
-1500 mm -5'0"		*8550	*8550	*12 850	*12 850	*20 200	14 100	*14 850	9300	10 900	6850	8400	5350	*7550	5000	9490		
-3000 mm -10'0"		*13 600	*13 600	*18 750	*18 750	*19 300	14 100	*14 500	9250	10 850	6800			8750	5550	8770		
-4500 mm -15'0"		*19 550	*19 550	*23 900	*23 900	*17 200	14 350	*13 050	9400	*9800	6950			*9350	6750	7690		
-6000 mm -20'0"		*43,900	*43,900	*51,500	*51,500	*37,100	30,850	*28,000	20,250	*20,600	15,050			*20,550	15,050	25'0"		
						*13 100	*13 100	*9300	*9300					*9100	*9100	6060		
						*27,600	*27,600							*19,950	*19,950	19'5"		



ISO 10567:2007



\* Indicates that the load is limited by hydraulic lifting capacity rather than tipping load. The above loads are in compliance with hydraulic excavator lift capacity standard ISO 10567:2007. They do not exceed 87% of hydraulic lifting capacity or 75% of tipping load. Weight of all lifting accessories must be deducted from the above lifting capacities. Lifting capacities are based on the machine standing on a firm, uniform supporting surface. The use of a work tool attachment point to handle/lift objects, could affect the machine lift performance.

Lift capacity stays with ±5% for all available track shoes.

Always refer to the appropriate Operation and Maintenance Manual for specific product information.

# 340 Hydraulic Excavator Specifications

## HD Reach Boom Lift Capacities – Counterweight: 7.56 mt (16,700 lb) – without Bucket, Heavy Lift: On

Long Undercarriage

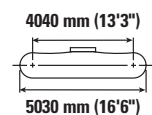
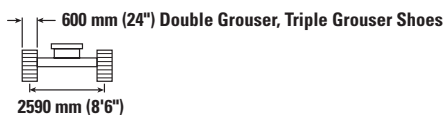
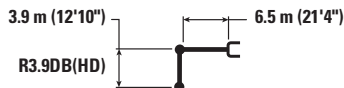

Boom Length	Unit	1500 mm/5'0"		3000 mm/10'0"		4500 mm/15'0"		6000 mm/20'0"		7500 mm/25'0"		9000 mm/30'0"		mm ft/in			
		kg	lb	kg	lb	kg	lb	kg	lb	kg	lb	kg	lb	kg	lb	mm	ft/in
9000 mm	kg														*6150	7350	
30'0"	lb														*13,700	13,700	23'7"
7500 mm	kg									*7600	*7600				*5700	8540	
25'0"	lb									*16,800	*16,800				*12,650	12,650	27'8"
6000 mm	kg									*7900	*7900	*7400	5850	*5550	5500	9340	
20'0"	lb									*17,300	17,150	*14,300	12,500	*12,250	12,150	30'5"	
4500 mm	kg							*9700	*9700	*8650	7700	*8100	5750	*5550	4900	9840	
15'0"	lb							*20,950	*20,950	*18,850	16,600	*17,700	12,350	*12,250	10,850	32'2"	
3000 mm	kg					*15 200	*15 200	*11 500	10 300	*9650	7400	8550	5600	*5750	4600	10 100	
10'0"	lb					*32,650	*32,650	*24,800	22,150	*20,900	15,900	18,400	12,000	*12,600	10,150	33'1"	
1500 mm	kg					*18 300	14 600	*13 200	9700	*10 600	7050	8350	5400	*6100	4500	10 130	
5'0"	lb					*39,500	31,450	*28,500	20,900	*23,000	15,200	18,000	11,600	*13,350	9,900	33'2"	
0 mm	kg			*8200	*8200	*19 950	13 950	*14 400	9250	10 750	6800	8200	5250	*6650	4550	9930	
0'0"	lb			*18,600	*18,600	*43,150	30,000	*31,100	19,950	23,100	14,600	17,650	11,300	*14,600	10,050	32'6"	
-1500 mm	kg	*8550	*8550	*12 850	*12 850	*20 200	13 700	14 800	9050	10 550	6650	8100	5150	7550	4850	9490	
-5'0"	lb	*19,100	*19,100	*29,000	*29,000	*43,750	29,450	31,800	19,450	22,700	14,300	17,500	11,150	16,650	10,600	31'1"	
-3000 mm	kg	*13 600	*13 600	*18 750	*18 750	*19 300	13 700	*14 500	9000	10 500	6600			8450	5400	8770	
-10'0"	lb	*30,450	*30,450	*42,400	*42,400	*41,850	29,450	*31,300	19,350	22,650	14,250			18,700	11,900	28'7"	
-4500 mm	kg	*19 550	*19 550	*23 900	*23 900	*17 200	13 900	*13 050	9100	*9800	6750			*9350	6550	7690	
-15'0"	lb	*43,900	*43,900	*51,500	*51,500	*37,100	29,950	*28,000	19,650	*20,600	14,600			*20,550	14,600	25'0"	
-6000 mm	kg					*13 100	*13 100	*9300	*9300					*9100	*9100	6060	
-20'0"	lb					*27,600	*27,600	*9300	*9300					*19,950	*19,950	19'5"	



ISO 10567:2007



\* Indicates that the load is limited by hydraulic lifting capacity rather than tipping load. The above loads are in compliance with hydraulic excavator lift capacity standard ISO 10567:2007. They do not exceed 87% of hydraulic lifting capacity or 75% of tipping load. Weight of all lifting accessories must be deducted from the above lifting capacities. Lifting capacities are based on the machine standing on a firm, uniform supporting surface. The use of a work tool attachment point to handle/lift objects, could affect the machine lift performance.

Lift capacity stays with ±5% for all available track shoes.

Always refer to the appropriate Operation and Maintenance Manual for specific product information.

# 340 Hydraulic Excavator Specifications

## HD Reach Boom Lift Capacities – Counterweight: 7.56 mt (16,700 lb) – without Bucket, Heavy Lift: On

Long Undercarriage

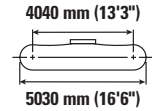
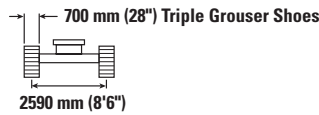
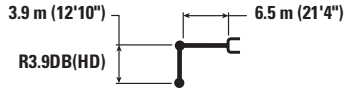

Reach	Unit	1500 mm/5'0"		3000 mm/10'0"		4500 mm/15'0"		6000 mm/20'0"		7500 mm/25'0"		9000 mm/30'0"		mm ft/in		
		kg lb	kg lb	kg lb	kg lb	kg lb	kg lb	kg lb	kg lb	kg lb	kg lb	kg lb	kg lb	kg lb	mm ft/in	
9000 mm 30'0"	kg lb													*6150 *13,700	*6150 *13,700	7350 23'7"
7500 mm 25'0"	kg lb									*7600 *16,800	*7600 *16,800			*5700 *12,650	*5700 *12,650	8540 27'8"
6000 mm 20'0"	kg lb									*7900 *17,300	*7900 *17,250	*7400 *14,300	5900 12,650	*5550 *12,250	5500 *12,250	9340 30'5"
4500 mm 15'0"	kg lb							*9700 *20,950	*9700 *20,950	*8650 *18,850	7800 16,750	*8100 *17,700	5800 12,450	*5550 *12,250	4950 10,950	9840 32'2"
3000 mm 10'0"	kg lb					*15 200 *32,650	*15 200 *32,650	*11 500 *24,800	10 350 22,350	*9650 *20,900	7450 16,050	*8600 18,550	5650 12,100	*5750 *12,600	4650 10,250	10 100 33'1"
1500 mm 5'0"	kg lb					*18 300 *39,500	14 700 31,700	*13 200 *28,500	9750 21,050	*10 600 *23,000	7100 15,300	8450 18,150	5450 11,700	*6100 *13,350	4550 10,000	10 130 33'2"
0 mm 0'0"	kg lb			*8200 *18,600	*8200 *18,600	*19 950 *43,150	14 050 30,250	*14 400 *31,100	9350 20,100	10 850 23,300	6850 14,750	8300 17,800	5300 11,400	*6650 *14,600	4600 10,150	9930 32'6"
-1500 mm -5'0"	kg lb	*8550 *19,100	*8550 *19,100	*12 850 *29,000	*12 850 *29,000	*20 200 *43,750	13 800 29,700	*14 850 32,100	9100 19,600	10 650 22,900	6700 14,400	8200 17,650	5200 11,250	*7550 *16,650	4850 10,750	9490 31'1"
-3000 mm -10'0"	kg lb	*13 600 *30,450	*13 600 *30,450	*18 750 *42,400	*18 750 *42,400	*19 300 *41,850	13 800 29,700	*14 500 *31,300	9050 19,500	10 600 22,850	6650 14,350			8550 18,900	5450 12,050	8770 28'7"
-4500 mm -15'0"	kg lb	*19 550 *43,900	*19 550 *43,900	*23 900 *51,500	*23 900 *51,500	*17 200 *37,100	14 050 30,200	*13 050 *28,000	9200 19,800	*9800 *20,600	6800 14,750			*9350 *20,550	6600 14,700	7690 25'0"
-6000 mm -20'0"	kg lb					*13 100 *27,600	*13 100 *27,600	*9300 *9300	*9300 *9300					*9100 *19,950	*9100 *19,950	6060 19'5"



ISO 10567:2007



\* Indicates that the load is limited by hydraulic lifting capacity rather than tipping load. The above loads are in compliance with hydraulic excavator lift capacity standard ISO 10567:2007. They do not exceed 87% of hydraulic lifting capacity or 75% of tipping load. Weight of all lifting accessories must be deducted from the above lifting capacities. Lifting capacities are based on the machine standing on a firm, uniform supporting surface. The use of a work tool attachment point to handle/lift objects, could affect the machine lift performance.

Lift capacity stays with ±5% for all available track shoes.

Always refer to the appropriate Operation and Maintenance Manual for specific product information.

# 340 Hydraulic Excavator Specifications

## HD Reach Boom Lift Capacities – Counterweight: 7.56 mt (16,700 lb) – without Bucket, Heavy Lift: On

Long Undercarriage

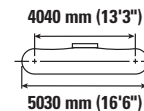
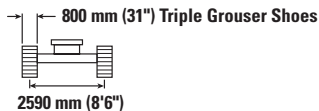

		1500 mm/5'0"		3000 mm/10'0"		4500 mm/15'0"		6000 mm/20'0"		7500 mm/25'0"		9000 mm/30'0"		mm ft/in		
9000 mm 30'0"	kg lb													*6150 *13,700	*6150 *13,700	7350 23'7"
7500 mm 25'0"	kg lb									*7600 *16,800	*7600 *16,800			*5700 *12,650	*5700 *12,650	8540 27'8"
6000 mm 20'0"	kg lb									*7900 *17,300	*7900 *17,300	*7400 *14,300	6000 12,800	*5550 *12,250	*5550 *12,250	9340 30'5"
4500 mm 15'0"	kg lb							*9700 *20,950	*9700 *20,950	*8650 *18,850	7900 16,950	*8100 *17,700	5900 12,650	*5550 *12,250	5050 11,150	9840 32'2"
3000 mm 10'0"	kg lb					*15 200 *32,650	*15 200 *32,650	*11 500 *24,800	10 500 22,650	*9650 *20,900	7550 16,250	*8600 *18,700	5700 12,300	*5750 *12,600	4750 10,450	10 100 33'1"
1500 mm 5'0"	kg lb					*18 300 *39,500	14 950 32,200	*13 200 *28,500	9900 21,350	*10 600 *23,000	7250 15,550	8600 18,450	5550 11,900	*6100 *13,350	4650 10,150	10 130 33'2"
0 mm 0'0"	kg lb			*8200 *18,600	*8200 *18,600	*19 950 *43,150	14 300 30,700	*14 400 *31,100	9500 20,450	11 000 23,700	6950 15,000	8450 18,100	5400 11,600	*6650 *14,600	4700 10,300	9930 32'6"
-1500 mm -5'0"	kg lb	*8550 *19,100	*8550 *19,100	*12 850 *29,000	*12 850 *29,000	*20 200 *43,750	14 050 30,150	*14 850 *32,150	9250 19,950	10 850 23,300	6800 14,650	8350 17,950	5300 11,450	*7550 *16,650	4950 10,900	9490 31'1"
-3000 mm -10'0"	kg lb	*13 600 *30,450	*13 600 *30,450	*18 750 *42,400	*18 750 *42,400	*19 300 *41,850	14 050 30,200	*14 500 *31,300	9200 19,850	10 800 23,250	6800 14,600			8700 19,200	5550 12,250	8770 28'7"
-4500 mm -15'0"	kg lb	*19 550 *43,900	*19 550 *43,900	*23 900 *51,500	*23 900 *51,500	*17 200 *37,100	14 250 30,700	*13 050 *28,000	9350 20,150	*9800 *20,600	6900 14,950			*9350 *20,550	6700 14,950	7690 25'0"
-6000 mm -20'0"	kg lb					*13 100 *27,600	*13 100 *27,600	*9300 *9300						*9100 *19,950	*9100 *19,950	6060 19'5"



ISO 10567:2007



\* Indicates that the load is limited by hydraulic lifting capacity rather than tipping load. The above loads are in compliance with hydraulic excavator lift capacity standard ISO 10567:2007. They do not exceed 87% of hydraulic lifting capacity or 75% of tipping load. Weight of all lifting accessories must be deducted from the above lifting capacities. Lifting capacities are based on the machine standing on a firm, uniform supporting surface. The use of a work tool attachment point to handle/lift objects, could affect the machine lift performance.

Lift capacity stays with ±5% for all available track shoes.

Always refer to the appropriate Operation and Maintenance Manual for specific product information.

# 340 Hydraulic Excavator Specifications

## HD Reach Boom Lift Capacities – Counterweight: 7.56 mt (16,700 lb) – without Bucket, Heavy Lift: On

Long Undercarriage

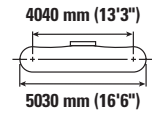
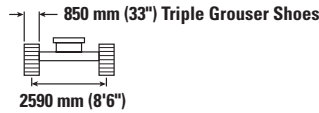

		3000 mm/10'0"		4500 mm/15'0"		6000 mm/20'0"		7500 mm/25'0"		9000 mm/30'0"		mm ft/in		
7500 mm 25'0"	kg lb							*8700 8150			*7350 *16,200	*7350 *16,200	7700 24'11"	
6000 mm 20'0"	kg lb							*8800 *19,250	8050 17,350		*7150 *15,700	6450 14,300	8580 27'11"	
4500 mm 15'0"	kg lb			*13 400	*13 400	*10 800 *23,350	*10 800 *23,350	*9450 *20,600	7850 16,850	*8450	5850	*7200 *15,800	5750 12,650	9130 29'10"
3000 mm 10'0"	kg lb			*17 000 *36,500	15 700 33,900	*12 500 *27,000	10 400 22,400	*10 350 *22,450	7550 16,250	8800	5750	*7450 *16,400	5350 11,800	9410 30'10"
1500 mm 5'0"	kg lb			*19 600 *42,250	14 750 31,800	*14 000 *30,250	9900 21,300	*11 150 *24,200	7250 15,600	8650	5600	*8000 *17,550	5200 11,500	9440 30'11"
0 mm 0'0"	kg lb			*20 400 *44,200	14 350 30,850	*14 850 *32,150	9550 20,550	11 100 23,900	7050 15,150	8550	5500	8250 18,150	5300 11,700	9220 30'2"
-1500 mm -5'0"	kg lb	*14 050 *31,750	*14 050 *31,750	*20 000 *43,400	14 250 30,650	*14 950 *32,350	9400 20,250	11 000 23,650	6950 14,950			8850 19,550	5700 12,500	8750 28'7"
-3000 mm -10'0"	kg lb	*22 150 *50,150	*22 150 *50,150	*18 550 *40,200	14 350 30,900	*14 150 *30,550	9450 20,300	*10 950 *23,450	7000 15,100			*10 000 *22,050	6500 14,350	7960 25'11"
-4500 mm -15'0"	kg lb	*20 900 *44,950	*20 900 *44,950	*15 750 *33,800	14 700 31,600	*11 900 *25,350	9650 20,850					*10 050 *22,100	8300 18,500	6750 21'10"

## HD Reach Boom Lift Capacities – Counterweight: 7.56 mt (16,700 lb) – without Bucket, Heavy Lift: On

Long Undercarriage

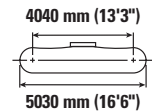
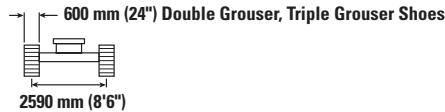

		3000 mm/10'0"		4500 mm/15'0"		6000 mm/20'0"		7500 mm/25'0"		9000 mm/30'0"		mm ft/in		
7500 mm 25'0"	kg lb							*8700 7950			*7350 *16,200	*7350 *16,200	7700 24'11"	
6000 mm 20'0"	kg lb							*8800 *19,250	7850 16,900		*7150 *15,700	6250 13,900	8580 27'11"	
4500 mm 15'0"	kg lb			*13 400	*13 400	*10 800 *23,350	10 700 23,100	*9450 *20,600	7650 16,400	*8450	5700	*7200 *15,800	5550 12,300	9130 29'10"
3000 mm 10'0"	kg lb			*17 000 *36,500	15 300 33,050	*12 500 *27,000	10 100 21,800	*10 350 *22,450	7350 15,800	8550	5550	*7450 *16,400	5200 11,450	9410 30'10"
1500 mm 5'0"	kg lb			*19 600 *42,250	14 350 30,900	*14 000 *30,250	9600 20,700	*11 000 *23,650	7050 15,150	8400	5450	7800 17,200	5050 11,150	9440 30'11"
0 mm 0'0"	kg lb			*20 400 *44,200	13 950 29,950	*14 850 *32,150	9250 19,950	10 750 23,150	6850 14,700	8250	5300	8000 17,600	5150 11,350	9220 30'2"
-1500 mm -5'0"	kg lb	*14 050 *31,750	*14 050 *31,750	*20 000 *43,400	13 850 29,750	14 900 32,000	9150 19,650	10 650 22,950	6750 14,500			8600 18,950	5500 12,150	8750 28'7"
-3000 mm -10'0"	kg lb	*22 150 *50,150	*22 150 *50,150	*18 550 *40,200	13 950 30,000	*14 150 *30,550	9150 19,750	10 700 23,050	6800 14,650			9850 21,850	6300 13,950	7960 25'11"
-4500 mm -15'0"	kg lb	*20 900 *44,950	*20 900 *44,950	*15 750 *33,800	14 250 30,700	*11 900 *25,350	9400 20,250					*10 050 *22,100	8050 18,000	6750 21'10"



ISO 10567:2007



\* Indicates that the load is limited by hydraulic lifting capacity rather than tipping load. The above loads are in compliance with hydraulic excavator lift capacity standard ISO 10567:2007. They do not exceed 87% of hydraulic lifting capacity or 75% of tipping load. Weight of all lifting accessories must be deducted from the above lifting capacities. Lifting capacities are based on the machine standing on a firm, uniform supporting surface. The use of a work tool attachment point to handle/lift objects, could affect the machine lift performance.

Lift capacity stays with ±5% for all available track shoes.

Always refer to the appropriate Operation and Maintenance Manual for specific product information.

# 340 Hydraulic Excavator Specifications

## HD Reach Boom Lift Capacities – Counterweight: 7.56 mt (16,700 lb) – without Bucket, Heavy Lift: On

Long Undercarriage

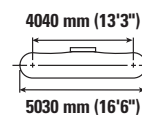
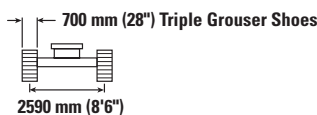

		3000 mm/10'0"		4500 mm/15'0"		6000 mm/20'0"		7500 mm/25'0"		9000 mm/30'0"		mm ft/in		
7500 mm 25'0"	kg lb							*8700 8000				*7350 *16,200	*7350 *16,200	7700 24'11"
6000 mm 20'0"	kg lb							*8800 *19,250	7900 17,000			*7150 *15,700	6300 14,050	8580 27'11"
4500 mm 15'0"	kg lb			*13 400	*13 400	*10 800 *23,350	10 800 23,250	*9450 *20,600	7700 16,550	*8450	5750	*7200 *15,800	5600 12,400	9130 29'10"
3000 mm 10'0"	kg lb			*17 000 *36,500	15 450 33,300	*12 500 *27,000	10 200 22,000	*10 350 *22,450	7400 15,900	8600 18,500	5600 12,050	*7450 *16,400	5250 11,550	9410 30'10"
1500 mm 5'0"	kg lb			*19 600 *42,250	14 450 31,150	*14 000 *30,250	9700 20,900	11 100 23,850	7100 15,300	8450 18,200	5500 11,750	7900 17,350	5100 11,250	9440 30'11"
0 mm 0'0"	kg lb			*20 400 *44,200	14 050 30,200	*14 850 *32,150	9350 20,150	10 850 23,400	6900 14,850	8350 17,950	5350 11,550	8050 17,750	5200 11,450	9220 30'2"
-1500 mm -5'0"	kg lb	*14 050 *31,750	*14 050 *31,750	*20 000 *43,400	13 950 30,000	*14 950 *32,300	9200 19,850	10 750 23,150	6800 14,650			8650 19,100	5550 12,250	8750 28'7"
-3000 mm -10'0"	kg lb	*22 150 *50,150	*22 150 *50,150	*18 550 *40,200	14 100 30,250	*14 150 *30,550	9250 19,900	10 800 23,250	6850 14,750			9950 *22,050	6350 14,050	7960 25'11"
-4500 mm -15'0"	kg lb	*20 900 *44,950	*20 900 *44,950	*15 750 *33,800	14 400 31,000	*11 900 *25,350	9450 20,450					*10 050 *22,100	8100 18,150	6750 21'10"

## HD Reach Boom Lift Capacities – Counterweight: 7.56 mt (16,700 lb) – without Bucket, Heavy Lift: On

Long Undercarriage

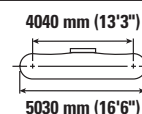
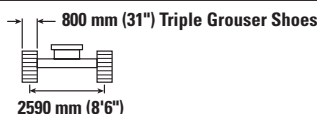
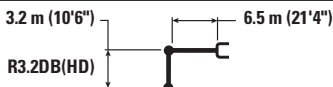

		3000 mm/10'0"		4500 mm/15'0"		6000 mm/20'0"		7500 mm/25'0"		9000 mm/30'0"		mm ft/in		
7500 mm 25'0"	kg lb							*8700 8100				*7350 *16,200	*7350 *16,200	7700 24'11"
6000 mm 20'0"	kg lb							*8800 *19,250	8050 17,250			*7150 *15,700	6400 14,250	8580 27'11"
4500 mm 15'0"	kg lb			*13 400	*13 400	*10 800 *23,350	*10 800 *23,350	*9450 *20,600	7800 16,800	*8450	5850	*7200 *15,800	5700 12,600	9130 29'10"
3000 mm 10'0"	kg lb			*17 000 *36,500	15 650 33,750	*12 500 *27,000	10 350 22,300	*10 350 *22,450	7500 16,150	8750 18,800	5700 12,250	*7450 *16,400	5300 11,750	9410 30'10"
1500 mm 5'0"	kg lb			*19 600 *42,250	14 700 31,650	*14 000 *30,250	9850 21,200	*11 150 *24,200	7200 15,550	8600 18,500	5550 11,950	*8000 *17,550	5200 11,400	9440 30'11"
0 mm 0'0"	kg lb			*20 400 *44,200	14 250 30,700	*14 850 *32,150	9500 20,450	11 050 23,750	7000 15,100	8500 18,300	5450 11,750	8200 18,050	5300 11,650	9220 30'2"
-1500 mm -5'0"	kg lb	*14 050 *31,750	*14 050 *31,750	*20 000 *43,400	14 200 30,500	*14 950 *32,350	9350 20,150	10 950 23,550	6900 14,900			8800 19,450	5650 12,450	8750 28'7"
-3000 mm -10'0"	kg lb	*22 150 *50,150	*22 150 *50,150	*18 550 *40,200	14 300 30,750	*14 150 *30,550	9400 20,200	*10 950 *23,450	6950 15,000			*10 000 *22,050	6450 14,300	7960 25'11"
-4500 mm -15'0"	kg lb	*20 900 *44,950	*20 900 *44,950	*15 750 *33,800	14 600 31,450	*11 900 *25,350	9600 20,750					*10 050 *22,100	8250 18,450	6750 21'10"



ISO 10567:2007



\* Indicates that the load is limited by hydraulic lifting capacity rather than tipping load. The above loads are in compliance with hydraulic excavator lift capacity standard ISO 10567:2007. They do not exceed 87% of hydraulic lifting capacity or 75% of tipping load. Weight of all lifting accessories must be deducted from the above lifting capacities. Lifting capacities are based on the machine standing on a firm, uniform supporting surface. The use of a work tool attachment point to handle/lift objects, could affect the machine lift performance.

Lift capacity stays with ±5% for all available track shoes.

Always refer to the appropriate Operation and Maintenance Manual for specific product information.



# 340 Hydraulic Excavator Specifications

## HD Reach Boom Lift Capacities – Counterweight: 7.56 mt (16,700 lb) – without Bucket, Heavy Lift: On

Long Undercarriage

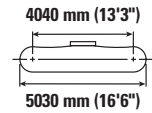
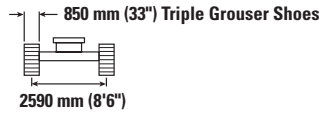
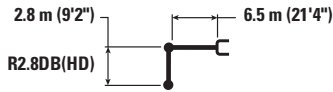

		3000 mm/10'0"		4500 mm/15'0"		6000 mm/20'0"		7500 mm/25'0"		9000 mm/30'0"		mm ft/in		
7500 mm 25'0"	kg lb											*9300 *20,600	8350 18,750	7340 23'9"
6000 mm 20'0"	kg lb					*10 050 *21,800	*10 050 *21,800	*9350 *20,450	8000 17,200			*8950 *19,700	6800 15,150	8250 26'10"
4500 mm 15'0"	kg lb			*14 500 *31,050	*14 500 *31,050	*11 400 *24,650	10 900 23,450	*9900 *21,550	7800 16,800			*8950 *19,700	6050 13,350	8820 28'10"
3000 mm 10'0"	kg lb			*18 000 *38,650	15 450 33,400	*13 050 *28,150	10 300 22,250	*10 700 *23,250	7500 16,200	8800	5750	8650 19,050	5650 12,400	9110 29'10"
1500 mm 5'0"	kg lb			*16 850 *41,000	14 650 31,550	*14 400 *31,100	9850 21,250	11 350 24,400	7250 15,650	8650	5600	8500 18,650	5500 12,100	9140 29'11"
0 mm 0'0"	kg lb			*19 800 *44,400	14 350 30,900	*15 050 *32,600	9550 20,600	11 150 23,950	7100 15,250			8700 19,150	5600 12,350	8920 29'2"
-1500 mm -5'0"	kg lb	*13 100 *29,850	*13 100 *29,850	*19 750 *42,800	14 350 30,900	*14 900 *32,300	9500 20,400	11 050 23,800	7000 15,150			9400 20,800	6050 13,350	8420 27'7"
-3000 mm -10'0"	kg lb	*23 600 *51,350	*23 600 *51,350	*17 950 *38,900	14 550 31,250	*13 800 *29,800	9550 20,600	*10 450	7100			*10 200 *22,500	7000 15,500	7600 24'9"
-4500 mm -15'0"	kg lb	*18 850 *40,550	*18 850 *40,550	*14 650 *31,350	14 650 31,350	*10 900 *22,900	9850 21,300					*9950 *21,850	9200 20,650	6330 20'5"

## HD Reach Boom Lift Capacities – Counterweight: 7.56 mt (16,700 lb) – without Bucket, Heavy Lift: On

Long Undercarriage

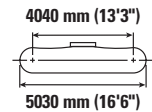
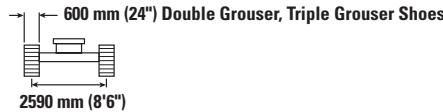
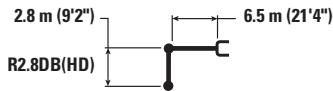

		3000 mm/10'0"		4500 mm/15'0"		6000 mm/20'0"		7500 mm/25'0"		9000 mm/30'0"		mm ft/in		
7500 mm 25'0"	kg lb											*9300 *20,600	8100 18,250	7340 23'9"
6000 mm 20'0"	kg lb					*10 050 *21,800	*10 050 *21,800	*9350 *20,450	7800 16,750			*8950 *19,700	6650 14,750	8250 26'10"
4500 mm 15'0"	kg lb			*14 500 *31,050	*14 500 *31,050	*11 400 *24,650	10 600 22,850	*9900 *21,550	7600 16,350			8950 *19,700	5850 12,950	8820 28'10"
3000 mm 10'0"	kg lb			*18 000 *38,650	15 050 32,500	*13 050 *28,150	10 050 21,650	*10 700 *23,250	7300 15,750	8550	5550	8400 18,450	5450 12,050	9110 29'10"
1500 mm 5'0"	kg lb			*16 850 *41,000	14 250 30,700	*14 400 *31,100	9600 20,650	11 000 23,650	7050 15,200	8400	5450	8200 18,100	5350 11,750	9140 29'11"
0 mm 0'0"	kg lb			*19 800 *44,400	13 950 30,050	*15 050 *32,400	9300 20,000	10 800 23,250	6900 14,800			8450 18,600	5450 12,000	8920 29'2"
-1500 mm -5'0"	kg lb	*13 100 *29,850	*13 100 *29,850	*19 750 *42,800	13 950 30,000	*14 900 *32,150	9200 19,800	10 750 23,100	6800 14,700			9150 20,150	5850 12,950	8420 27'7"
-3000 mm -10'0"	kg lb	*23 600 *51,350	*23 600 *51,350	*17 950 *38,900	14 100 30,350	*13 800 *29,800	9250 20,000	*10 450	6900			*10 200 *22,500	6800 15,050	7600 24'9"
-4500 mm -15'0"	kg lb	*18 850 *40,550	*18 850 *40,550	*14 650 *31,350	14 500 31,200	*10 900 *22,900	9600 20,700					*9950 *21,850	8950 20,100	6330 20'5"



ISO 10567:2007



\* Indicates that the load is limited by hydraulic lifting capacity rather than tipping load. The above loads are in compliance with hydraulic excavator lift capacity standard ISO 10567:2007. They do not exceed 87% of hydraulic lifting capacity or 75% of tipping load. Weight of all lifting accessories must be deducted from the above lifting capacities. Lifting capacities are based on the machine standing on a firm, uniform supporting surface. The use of a work tool attachment point to handle/lift objects, could affect the machine lift performance.

Lift capacity stays with ±5% for all available track shoes.

Always refer to the appropriate Operation and Maintenance Manual for specific product information.

# 340 Hydraulic Excavator Specifications

## HD Reach Boom Lift Capacities – Counterweight: 7.56 mt (16,700 lb) – without Bucket, Heavy Lift: On

Long Undercarriage

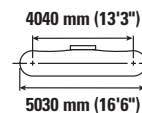
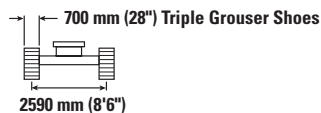

		3000 mm/10'0"		4500 mm/15'0"		6000 mm/20'0"		7500 mm/25'0"		9000 mm/30'0"		mm ft/in		
7500 mm 25'0"	kg lb											*9300 *20,600	8200 18,400	7340 23'9"
6000 mm 20'0"	kg lb					*10 050 *21,800	*10 050 *21,800	*9350 *20,450	7850 16,900			*8950 *19,700	6700 14,900	8250 26'10"
4500 mm 15'0"	kg lb			*14 500 *31,050	*14 500 *31,050	*11 400 *24,650	10 700 23,050	*9900 *21,550	7650 16,450			*8950 *19,700	5900 13,050	8820 28'10"
3000 mm 10'0"	kg lb			*18 000 *38,650	15 200 32,750	*13 050 *28,150	10 150 21,850	*10 700 *23,250	7350 15,900	8600	5600	8450 18,650	5500 12,150	9110 29'10"
1500 mm 5'0"	kg lb			*16 850 *41,000	14 350 30,950	*14 400 *31,100	9650 20,800	11 100 23,900	7100 15,300	8500	5500	8300 18,250	5400 11,850	9140 29'11"
0 mm 0'0"	kg lb			*19 800 *44,400	14 100 30,300	*15 050 *32,600	9400 20,200	10 900 23,450	6950 14,950			8500 18,750	5500 12,100	8920 29'2"
-1500 mm -5'0"	kg lb	*13 100 *29,850	*13 100 *29,850	*19 750 *42,800	14 050 30,250	*14 900 *32,300	9300 20,000	10 850 23,300	6850 14,800			9200 20,350	5950 13,050	8420 27'7"
-3000 mm -10'0"	kg lb	*23 600 *51,350	*23 600 *51,350	*17 950 *38,900	14 250 30,600	*13 800 *29,800	9350 20,150	*10 450	6950			*10 200 *22,500	6850 15,200	7600 24'9"
-4500 mm -15'0"	kg lb	*18 850 *40,550	*18 850 *40,550	*14 650 *31,350	14 600 *31,350	*10 900 *22,900	9650 20,900					*9950 *21,850	9050 20,250	6330 20'5"

## HD Reach Boom Lift Capacities – Counterweight: 7.56 mt (16,700 lb) – without Bucket, Heavy Lift: On

Long Undercarriage

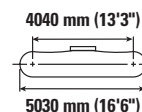
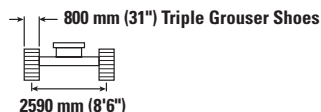
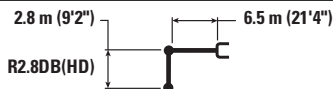

		3000 mm/10'0"		4500 mm/15'0"		6000 mm/20'0"		7500 mm/25'0"		9000 mm/30'0"		mm ft/in		
7500 mm 25'0"	kg lb											*9300 *20,600	8300 18,650	7340 23'9"
6000 mm 20'0"	kg lb					*10 050 *21,800	*10 050 *21,800	*9350 *20,450	7950 17,100			*8950 *19,700	6800 15,100	8250 26'10"
4500 mm 15'0"	kg lb			*14 500 *31,050	*14 500 *31,050	*11 400 *24,650	10 850 23,350	*9900 *21,550	7750 16,700			*8950 *19,700	6000 13,250	8820 28'10"
3000 mm 10'0"	kg lb			*18 000 *38,650	15 400 33,250	*13 050 *28,150	10 250 22,150	*10 700 *23,250	7500 16,100	8750	5700	8600 18,950	5600 12,350	9110 29'10"
1500 mm 5'0"	kg lb			*16 850 *41,000	14 550 31,400	*14 400 *31,100	9800 21,150	11 300 24,250	7250 15,550	8650	5600	8450 18,550	5450 12,050	9140 29'11"
0 mm 0'0"	kg lb			*19 800 *44,400	14 300 30,750	*15 050 *32,600	9500 20,500	11 100 23,850	7050 15,200			8650 19,050	5600 12,300	8920 29'2"
-1500 mm -5'0"	kg lb	*13 100 *29,850	*13 100 *29,850	*19 750 *42,800	14 300 30,750	*14 900 *32,300	9450 20,300	11 000 23,700	7000 15,050			9350 20,650	6000 13,250	8420 27'7"
-3000 mm -10'0"	kg lb	*23 600 *51,350	*23 600 *51,350	*17 950 *38,900	14 450 31,100	*13 800 *29,800	9500 20,500	*10 450	7100			*10 200 *22,500	7000 15,450	7600 24'9"
-4500 mm -15'0"	kg lb	*18 850 *40,550	*18 850 *40,550	*14 650 *31,350	*14 650 *31,350	*10 900 *22,900	9800 21,200					*9950 *21,850	9150 20,550	6330 20'5"



ISO 10567:2007



\* Indicates that the load is limited by hydraulic lifting capacity rather than tipping load. The above loads are in compliance with hydraulic excavator lift capacity standard ISO 10567:2007. They do not exceed 87% of hydraulic lifting capacity or 75% of tipping load. Weight of all lifting accessories must be deducted from the above lifting capacities. Lifting capacities are based on the machine standing on a firm, uniform supporting surface. The use of a work tool attachment point to handle/lift objects, could affect the machine lift performance.

Lift capacity stays with ±5% for all available track shoes.

Always refer to the appropriate Operation and Maintenance Manual for specific product information.

# 340 Hydraulic Excavator Specifications

## Bucket Specifications and Compatibility

	Linkage	Width		Capacity		Weight		Fill	Long Undercarriage							
		7.56 mt (16,700 lb) Counterweight		Reach HD			Reach			Mass						
		mm	in	m <sup>3</sup>	yd <sup>3</sup>	kg	lb		%		R2.8 (9'2") HD	R3.2 (10'6") HD	R3.9 (12'10") HD	R2.8 (9'2")	R3.2 (10'6")	R3.9 (12'10")
<b>Pin-On (No Quick Coupler)</b>																
Heavy Duty	DB	1350	54	1.64	2.14	1473	3,247	100	●	●	⊙	●	●	●		
	DB	1500	60	1.88	2.46	1605	3,538	100	●	●	⊖	●	●	⊖		
	DB	1650	66	2.12	2.77	1737	3,829	100	⊙	⊙	○	⊙	⊙	⊖		
	DB	1800	71	2.30	3.01	1949	4,292	100	⊖	⊖	○	⊖	⊖	○		
	DB	1850	72	2.36	3.09	1834	4,043	100	⊖	⊖	○	⊖	⊖	○		
	DB	1750	69	2.50	3.27	2066	4,550	100	⊖	○	◇	⊖	○	◇		
Heavy Duty	TB	1650	66	2.41	3.15	2490	5,483	100							⊖	
Maximum load with pin-on (payload + bucket)									kg	5720	5400	4700	5800	5500	4810	6270
									lb	12,610	11,905	10,362	12,787	12,125	10,604	13,823
<b>With Cat Pin Grabber Coupler</b>																
Heavy Duty	DB	1350	54	1.64	2.14	1473	3,247	100	●	⊙	⊖	●	●	⊖		
	DB	1500	60	1.88	2.46	1605	3,538	100	⊙	⊖	○	⊙	⊖	○		
	DB	1650	66	2.12	2.77	1737	3,829	100	⊖	○	◇	⊖	⊖	◇		
	DB	1800	71	2.30	3.01	1949	4,292	100	○	○	◇	○	○	◇		
	DB	1850	72	2.36	3.09	1834	4,043	100	○	○	◇	○	○	◇		
	DB	1750	69	2.50	3.27	2066	4,550	100	○	◇	X	○	◇	X		
Heavy Duty	TB	1650	66	2.41	3.15	2490	5,483	100							◇	
Maximum load with coupler (payload + bucket)									kg	5022	4702	4002	5102	4802	4112	5217
									lb	11,072	10,367	8,824	11,249	10,587	9,066	11,501

### Maximum Material Density:

- 2100 kg/m<sup>3</sup> (3,500 lb/yd<sup>3</sup>)
- ⊙ 1800 kg/m<sup>3</sup> (3,000 lb/yd<sup>3</sup>)
- ⊖ 1500 kg/m<sup>3</sup> (2,500 lb/yd<sup>3</sup>)
- 1200 kg/m<sup>3</sup> (2,000 lb/yd<sup>3</sup>)
- ◇ 900 kg/m<sup>3</sup> (1,500 lb/yd<sup>3</sup>)
- X Not Recommended

The above loads are in compliance with hydraulic excavator standard EN474-5:2006 + A3:2013, they do not exceed 87% of hydraulic lifting capacity or 75% of tipping capacity with front linkage fully extended at ground line with bucket curled.

Capacity based on ISO 7451:2007.

Bucket weight with General Duty tips.

Caterpillar recommends using appropriate work tools to maximize the value customers receive from our products. Use of work tools, including buckets, which are outside of Caterpillar's recommendations or specifications for weight, dimensions, flows, pressures, etc. may result in less-than-optimal performance, including but not limited to reductions in production, stability, reliability, and component durability. Improper use of a work tool resulting in sweeping, prying, twisting and/or catching of heavy loads will reduce the life of the boom and stick.

(continued on next page)

# 340 Hydraulic Excavator Specifications

## Bucket Specifications and Compatibility (continued)

	Linkage	Width		Capacity		Weight		Fill	Long Wide Undercarriage						
									7.56 mt (16,700 lb) Counterweight			Reach		Mass	
		mm	in	m <sup>3</sup>	yd <sup>3</sup>	kg	lb		Reach HD			Reach			
							R2.8 (9'2") HD	R3.2 (10'6") HD	R3.9 (12'10") HD	R2.8 (9'2")	R3.2 (10'6")	R3.9 (12'10")	M2.55 (8'4")		
<b>Pin-On (No Quick Coupler)</b>															
Heavy Duty	DB	1350	54	1.64	2.14	1473	3,247	100	●	●	●	●	●	●	
	DB	1500	60	1.88	2.46	1605	3,538	100	●	●	⊙	●	●	⊙	
	DB	1650	66	2.12	2.77	1737	3,829	100	●	⊙	⊖	●	⊙	⊖	
	DB	1800	71	2.30	3.01	1949	4,292	100	⊙	⊖	○	⊙	⊖	○	
	DB	1850	72	2.36	3.09	1834	4,043	100	⊙	⊖	○	⊙	⊙	○	
Heavy Duty	TB	1650	66	2.41	3.15	2490	5,483	100							⊙
Maximum load with pin-on (payload + bucket)								kg	6120	5780	5040	6200	5880	5150	6730
								lb	13,492	12,743	11,111	13,669	12,963	11,354	14,837
<b>With Cat Pin Grabber Coupler</b>															
Heavy Duty	DB	1350	54	1.64	2.14	1473	3,247	100	●	●	⊙	●	●	⊙	
	DB	1500	60	1.88	2.46	1605	3,538	100	●	⊙	⊖	●	⊙	⊖	
	DB	1650	66	2.12	2.77	1737	3,829	100	⊙	⊖	○	⊙	⊖	○	
	DB	1800	71	2.30	3.01	1949	4,292	100	⊖	○	◇	⊖	○	◇	
	DB	1850	72	2.36	3.09	1834	4,043	100	⊖	○	◇	⊖	○	◇	
Heavy Duty	TB	1650	66	2.41	3.15	2490	5,483	100							○
Maximum load with coupler (payload + bucket)								kg	5422	5082	4342	5502	5182	4452	5677
								lb	11,954	11,205	9,573	12,130	11,425	9,816	12,515

The above loads are in compliance with hydraulic excavator standard EN474-5:2006 + A3:2013, they do not exceed 87% of hydraulic lifting capacity or 75% of tipping capacity with front linkage fully extended at ground line with bucket curled.

Capacity based on ISO 7451:2007.

Bucket weight with General Duty tips.

### Maximum Material Density:

- 2100 kg/m<sup>3</sup> (3,500 lb/yd<sup>3</sup>)
- ⊙ 1800 kg/m<sup>3</sup> (3,000 lb/yd<sup>3</sup>)
- ⊖ 1500 kg/m<sup>3</sup> (2,500 lb/yd<sup>3</sup>)
- 1200 kg/m<sup>3</sup> (2,000 lb/yd<sup>3</sup>)
- ◇ 900 kg/m<sup>3</sup> (1,500 lb/yd<sup>3</sup>)

Caterpillar recommends using appropriate work tools to maximize the value customers receive from our products. Use of work tools, including buckets, which are outside of Caterpillar's recommendations or specifications for weight, dimensions, flows, pressures, etc. may result in less-than-optimal performance, including but not limited to reductions in production, stability, reliability, and component durability. Improper use of a work tool resulting in sweeping, prying, twisting and/or catching of heavy loads will reduce the life of the boom and stick.

# 340 Hydraulic Excavator Specifications

## Attachments Offering Guide

Not all Attachments are available in all regions. Consult your Cat dealer for configurations available in your region.

Match

\* Working range front only

No Match

### PIN-ON ATTACHMENTS

Undercarriage		Long						
Counterweight		7.56 mt (16,700 lb)						
Boom Type		Reach			Reach HD			ME
Stick Length		2.8 m (9'2")	3.2 m (10'6")	3.9 m (12'10")	2.8 m (9'2") HD	3.2 m (10'6") HD	3.9 m (12'10") HD	2.55 m (8'4")
Hydraulic Hammers	H140 GC	✓	✓	✓	✓	✓	✓	✓
	H140 GC S	✓	✓	✓	✓	✓	✓	✓
	H140 S	✓	✓	✓	✓	✓	✓	✓
	H160 GC	✓	✓	✓	✓	✓	✓	✓
	H160 GC S	✓	✓	✓	✓	✓	✓	✓
	H160 S	✓	✓	✓	✓	✓	✓	✓
	H180 GC	✓	✓		✓	✓		✓
	H180 GC S	✓	✓	✓	✓	✓	✓*	✓
	H180 S	✓	✓	✓*	✓	✓	✓*	✓
Demolition and Sorting Grapples	G332	✓	✓	✓	✓	✓	✓	
	G345	✓	✓	✓	✓	✓	✓	
	G345 Flat Top	✓	✓	✓	✓	✓	✓	
Mobile Scrap and Demolition Shears	S3035-Flat Top	✓	✓	✓	✓	✓	✓	
Pulverizers	P232	✓	✓	✓	✓	✓	✓	✓
Compactors (Vibratory Plate)	CVP110	✓	✓	✓	✓	✓	✓	✓
Rotary Cutters	RC30	✓	✓	✓	✓	✓	✓	
	RC50							✓

### PIN-ON ATTACHMENTS (continued)

Undercarriage		Long Wide						
Counterweight		7.56 mt (16,700 lb)						
Boom Type		Reach			Reach HD			ME
Stick Length		2.8 m (9'2")	3.2 m (10'6")	3.9 m (12'10")	2.8 m (9'2") HD	3.2 m (10'6") HD	3.9 m (12'10") HD	2.55 m (8'4")
Hydraulic Hammers	H140 GC	✓	✓	✓	✓	✓	✓	✓
	H140 GC S	✓	✓	✓	✓	✓	✓	✓
	H140 S	✓	✓	✓	✓	✓	✓	✓
	H160 GC	✓	✓	✓	✓	✓	✓	✓
	H160 GC S	✓	✓	✓	✓	✓	✓	✓
	H160 S	✓	✓	✓	✓	✓	✓	✓
	H180 GC	✓	✓		✓	✓		✓
	H180 GC S	✓	✓	✓	✓	✓	✓	✓
	H180 S	✓	✓	✓	✓	✓	✓	✓
Demolition and Sorting Grapples	G332	✓	✓	✓	✓	✓	✓	
	G345	✓	✓	✓	✓	✓	✓	
	G345 Flat Top	✓	✓	✓	✓	✓	✓	
Mobile Scrap and Demolition Shears	S3035-Flat Top	✓	✓	✓	✓	✓	✓	
Pulverizers	P232	✓	✓	✓	✓	✓	✓	✓
Compactors (Vibratory Plate)	CVP110	✓	✓	✓	✓	✓	✓	✓
Rotary Cutters	RC30	✓	✓	✓	✓	✓	✓	
	RC50							✓

(continued on next page)

# 340 Hydraulic Excavator Specifications

## Attachments Offering Guide (continued)

Not all Attachments are available in all regions. Consult your Cat dealer for configurations available in your region.

Match

\* Working range front only

No Match

### CAT PIN GRABBER COUPLER ATTACHMENTS

Undercarriage		Long						
Counterweight		7.56 mt (16,700 lb)						
Boom Type		Reach			Reach HD			ME
Stick Length		2.8 m (9'2")	3.2 m (10'6")	3.9 m (12'10")	2.8 m (9'2") HD	3.2 m (10'6") HD	3.9 m (12'10") HD	2.55 m (8'4")
Hydraulic Hammers	H140 GC	✓	✓	✓	✓	✓	✓	✓
	H140 GC S	✓	✓	✓	✓	✓	✓	✓
	H140 S	✓	✓	✓	✓	✓	✓	✓
	H160 GC	✓	✓	✓	✓	✓	✓	✓
	H160 GC S	✓	✓	✓	✓	✓	✓	✓
	H160 S	✓	✓	✓	✓	✓	✓	✓
	H180 GC							✓*
	H180 GC S	✓	✓*		✓	✓*		✓*
	H180 S	✓	✓*		✓*			✓*
Demolition and Sorting Grapples	G332	✓	✓	✓	✓	✓	✓	
	G345	✓	✓	✓*	✓	✓		
	G345 Flat Top	✓	✓*		✓	✓*		
Mobile Scrap and Demolition Shears	S3035-Flat Top	✓	✓	✓*	✓	✓	✓*	
Pulverizers	P232	✓	✓		✓	✓*		✓*
Compactors (Vibratory Plate)	CVP110	✓	✓	✓	✓	✓	✓	✓
Rotary Cutters	RC30	✓	✓	✓	✓	✓	✓	
	RC50							✓

### CAT PIN GRABBER COUPLER ATTACHMENTS (continued)

Undercarriage		Long Wide						
Counterweight		7.56 mt (16,700 lb)						
Boom Type		Reach			Reach HD			ME
Stick Length		2.8 m (9'2")	3.2 m (10'6")	3.9 m (12'10")	2.8 m (9'2") HD	3.2 m (10'6") HD	3.9 m (12'10") HD	2.55 m (8'4")
Hydraulic Hammers	H140 GC	✓	✓	✓	✓	✓	✓	✓
	H140 GC S	✓	✓	✓	✓	✓	✓	✓
	H140 S	✓	✓	✓	✓	✓	✓	✓
	H160 GC	✓	✓	✓	✓	✓	✓	✓
	H160 GC S	✓	✓	✓	✓	✓	✓	✓
	H160 S	✓	✓	✓	✓	✓	✓	✓
	H180 GC	✓*	✓*		✓*			✓*
	H180 GC S	✓	✓		✓	✓		✓
	H180 S	✓	✓		✓	✓*		✓
Demolition and Sorting Grapples	G332	✓	✓	✓	✓	✓	✓	
	G345	✓	✓	✓	✓	✓	✓	
	G345 Flat Top	✓	✓		✓	✓		
Mobile Scrap and Demolition Shears	S3035-Flat Top	✓	✓	✓	✓	✓	✓	
Pulverizers	P232	✓	✓		✓	✓		✓
Compactors (Vibratory Plate)	CVP110	✓	✓	✓	✓	✓	✓	✓
Rotary Cutters	RC30	✓	✓	✓	✓	✓	✓	
	RC50							

(continued on next page)

# 340 Hydraulic Excavator Specifications

## Attachments Offering Guide *(continued)*

Not all Attachments are available in all regions. Consult your Cat dealer for configurations available in your region.

Match

### BOOM-MOUNT

Undercarriage		Long		Long Wide	
		7.56 mt (16,700 lb)		7.56 mt (16,700 lb)	
Counterweight		Reach	Reach HD	Reach	Reach HD
Mobile Scrap and Demolition Shears	S3070-Flat Top	✓	✓	✓	✓

## Standard and Optional Equipment

Standard and optional equipment may vary. Consult your Cat dealer for details.

	Standard	Optional		Standard	Optional
<b>BOOMS, STICKS AND LINKAGES</b>			<b>ELECTRICAL SYSTEM</b>		
6.18 m (20'3") Mass boom		✓	Maintenance-free 1,000 CCA batteries (×2)	✓	
6.5 m (21'4") Reach boom		✓	Centralized electrical disconnect switch	✓	
6.5 m (21'4") HD Reach boom		✓	LED exterior chassis and boom lights	✓	
2.55 m (8'4") Mass stick		✓	Premium surround working lights		✓
2.8 m (9'2") Reach stick		✓	<b>ENGINE</b>		
2.8 m (9'2") HD Reach stick		✓	115 Amp alternator	✓	
3.2 m (10'6") Reach stick		✓	Cold start block heaters		✓
3.2 m (10'6") HD Reach stick		✓	Three selectable modes: Power, Smart, Eco	✓	
3.9 m (12'10") Reach stick		✓	Auto engine speed control	✓	
3.9 m (12'10") HD Reach stick		✓	52° C (126° F) high-ambient cooling	✓	
DB family bucket linkage with lifting eye		✓	Hydraulic reverse fan	✓	
TB family bucket linkage with lifting eye		✓	-18° C (0° F) cold start capability	✓	
<b>CAT TECHNOLOGY</b>			-32° C (-25° F) cold start capability		✓
Cat Equipment Management:			Double element air filter with integrated pre-cleaner	✓	
- VisionLink®	✓ <sup>1</sup>		Dual stage four micron main filter	✓	
- VisionLink Productivity		✓ <sup>2</sup>	10 micron primary filter with water separator	✓	
- Remote Flash	✓		Electric fuel priming pump	✓	
- Remote Troubleshoot	✓		Secure start with PIN code	✓	
- Work tool recognition and tracking (PL161)	✓ <sup>3</sup>		Remote disable	✓	
- Operator Coaching		✓ <sup>4</sup>	<b>HYDRAULIC SYSTEM</b>		
Cat Grade:			Boom and stick regeneration circuit	✓	
- Cat Grade with 2D	✓		Electronic main control valve	✓	
- Cat Grade with 2D with Attachment Ready Option (ARO)		✓	Auto dig boost	✓	
- Laser catcher		✓	Auto heavy lift	✓	
- Cat Grade with 3D (single or dual Global Navigation Satellite System [GNSS])		✓	Auto hydraulic oil warmup	✓	
- Compatible with 3D grade systems from Trimble, Topcon, and Leica	✓		Bio hydraulic oil capability	✓	
- Cat Grade 3D Ready		✓	Fine swing	✓	
Cat Assist:			Reverse swing damping valve	✓	
- Grade Assist	✓		Auto swing parking brake	✓	
- Boom Assist	✓		High performance hydraulic return filter	✓	
- Bucket Assist	✓		Two speed travel	✓	
- Swing Assist	✓		Combined two-way auxiliary circuit		✓
- Lift Assist	✓		Medium-pressure auxiliary circuit		✓
Cat Payload:			Quick coupler circuit for Cat Pin Grabber		✓
- On-the-go weighing	✓		Hydraulic Efficiency Monitoring		✓
- Semiautomatic calibration	✓		<sup>1</sup> Provides core telematics data to manage health, maintenance insights, and condition monitoring. Other plans available for more comprehensive data reporting. Consult your Cat dealer for details.		
- Payload/cycle information	✓		<sup>2</sup> VisionLink subscription required. Consult your Cat dealer for details.		
- VisionLink Productivity back office reporting		✓ <sup>2</sup>	<sup>3</sup> Requires PL161 attachment locator on work tool and Bluetooth® receiver on machine.		
Cat Advanced Payload:			<sup>4</sup> VisionLink subscription required for back office reporting. Consult your Cat dealer for details.		
- Daily totals		✓			
- Custom lists		✓			
- Smart weight target		✓			
- E-ticket Integration		✓ <sup>2</sup>			
Other:					
Cat Tiltrotator (TRS) integration		✓			

(continued on next page)



# 340 Standard and Optional Equipment

## Standard and Optional Equipment *(continued)*

Standard and optional equipment may vary. Consult your Cat dealer for details.

	Standard	Optional		Standard	Optional
<b>SAFETY AND SECURITY</b>			<b>UNDERCARRIAGE AND STRUCTURES</b>		
Caterpillar One Key security system	✓		Long undercarriage		✓
2D E-Fence:	✓		Long wide undercarriage		✓
– E-ceiling			Towing eye on base frame	✓	
– E-floor			Full-length track guiding guards		✓
– E-swing			Segmented two-piece track guiding guards		✓
– E-wall			Swivel guard	✓	
– E-cab avoidance			HD bottom guard	✓	
Auto hammer stop	✓		HD travel motor guards	✓	
Lockable external tool/storage box	✓		Grease lubricated track	✓	
Lockable door, fuel, and hydraulic tank locks	✓		HD swing frame		✓
Lockable fuel drain compartment	✓		HD swing bearing		✓
Service platform with anti-skid plate and recessed bolts	✓		7.56 mt (16,700 lb) counterweight		✓
Lockable disconnect switch	✓		600 mm (24") double grouser track shoes		✓
Right Hand (RH) handrail and handhold	✓		600 mm (24") triple grouser track shoes		✓
Signaling/warning horn	✓		700 mm (28") triple grouser track shoes		✓
Travel alarm	✓		800 mm (31") triple grouser track shoes		✓
Swing alarm		✓	850 mm (33") triple grouser track shoes		✓
Ground-level secondary engine shutoff switch	✓				
Boom lowering check valve	✓				
Stick lowering check valve	✓				
Rear and right-hand-sideview cameras	✓				
360° visibility		✓			
Operator Protective Guards		✓			
Inspection lighting		✓			
<b>SERVICE AND MAINTENANCE</b>					
Integrated vehicle health management system	✓				
Grouped engine oil and fuel filters	✓				
Scheduled Oil Sampling (S·O·S <sup>SM</sup> ) ports	✓				
QuickEvac <sup>TM</sup> maintenance ready		✓			

## Dealer Installed Kits and Attachments

Attachments may vary. Consult your Cat dealer for details.

CAB	ELECTRICAL	SAFETY AND SECURITY
<ul style="list-style-type: none"> <li>• Radial lower wiper</li> <li>• Left Hand (LH)/RH electrical pedal for tool control</li> <li>• 75 mm (3") retractable seat belt</li> </ul>	<ul style="list-style-type: none"> <li>• Premium surround working lights</li> </ul> <p><b>GUARDS</b></p> <ul style="list-style-type: none"> <li>• Side rubber bumper guard</li> <li>• Mesh guard full front</li> <li>• Full protecting vandalism guard</li> </ul>	<ul style="list-style-type: none"> <li>• Bluetooth® receiver kit</li> <li>• Bluetooth key fob</li> <li>• Operator Protective Guards</li> <li>• Cat Detect – People Detection</li> <li>• Cat Command – Remote control kit</li> </ul>

## 340 Cab Option

	Deluxe
ROPS	●
Operator Protective Guards (OPG)	○
High-resolution 203 mm (8") LCD touchscreen monitor	●
High-resolution 254 mm (10") LCD touchscreen monitor	○
Auto bi-level air conditioner	●
Jog dial and shortcut keys for monitor control	●
Keyless push-to-start engine control	●
Height-adjustable console	●
Tilt-up left-side console	●
Heated air-suspension seat	●
51 mm (2") seat belt	●
Monitor integrated Bluetooth radio with USB/Auxiliary ports	●
12V DC outlets	●
Document storage	●
Overhead storage and rear storage with nets	●
Beverage holder	●
Cup holder	●
Openable two-piece front window	●
Rear window emergency exit	●
Radial wiper with washer	●
Openable polycarbonate skylight hatch	●
LED dome light	●
Floor welcome light	●
Roof sunscreen	●
Roller front sunscreen	●
Roller rear sunscreen	○
Washable floor mat	●
Beacon ready	●
Cat Stick Steer	○
Auxiliary relay	○

- Standard
- Optional
- X Not available

# 340 Environmental Declaration

The following information applies to the machine at the time of final manufacture as configured for sale in the regions covered in this document. The content of this declaration is valid as of the date issued; however, content related to machine features and specifications are subject to change without notice. For additional information, please see the machine's Operation and Maintenance Manual.

For more information on sustainability in action and our progress, please visit <https://www.caterpillar.com/en/company/sustainability>.

## Engine

- The Cat® C9.3B engine meets U.S. EPA Tier 3, EU Stage IIIA equivalent, and China Nonroad Stage III emission standards.
- Cat engines are compatible with diesel fuel blended with the following lower-carbon intensity fuels\*\* up to:
  - ✓ 100% biodiesel FAME (fatty acid methyl ester)\*
  - ✓ 100% renewable diesel, HVO (hydrotreated vegetable oil) and GTL (gas-to-liquid) fuels

Refer to guidelines for successful application. Please consult your Cat dealer or "Caterpillar Machine Fluids Recommendations" (SEBU6250) for details.

*\*For use of blends higher than 20% biodiesel, consult your Cat dealer.*

*\*\*Tailpipe greenhouse gas emissions from lower-carbon intensity fuels are essentially the same as traditional fuels.*

## Air Conditioning System

- The air conditioning system on this machine contains the fluorinated greenhouse gas refrigerant R134a (Global Warming Potential = 1430). The system contains 1.0 kg (2.2 lb) of refrigerant which has a CO<sub>2</sub> equivalent of 1.430 metric tonnes (1.576 tons).

## Paint

- Based on best available knowledge, the maximum allowable concentration, measured in parts per million (PPM), of the following heavy metals in paint are:
  - Barium < 0.01%
  - Cadmium < 0.01%
  - Chromium < 0.01%
  - Lead < 0.01%

## Sound Performance

ISO 6395:2008 (external) – 106 dB(A)

ISO 6396:2008 (inside cab) – 73 dB(A)

- Hearing protection may be needed when operating with an open operator station and cab (when not properly maintained or doors/windows open) for extended periods or in a noisy environment.

## Oils and Fluids

- Caterpillar factory fills with ethylene glycol coolants. Cat Diesel Engine Antifreeze/Coolant (DEAC) and Cat Extended Life Coolant (ELC) can be recycled. Consult your Cat dealer for more information.
- Cat Bio HYDO™ Advanced is an EU Ecolabel approved biodegradable hydraulic oil.
- Additional fluids are likely to be present, please consult the Operations and Maintenance Manual or the Application and Installation guide for complete fluid recommendations and maintenance intervals.

## Features and Technology

- The following features and technology may contribute to fuel savings and/or carbon reduction. Features may vary. Consult your Cat dealer for details.
  - Smart mode matches machine power to digging requirements automatically
  - Eco mode supports reduced fuel consumption for light applications
  - One-touch low idle with automatic engine speed control
  - Available Cat technologies help improve operator efficiency
  - Extended service intervals help decrease maintenance costs

For more complete information on Cat products, dealer services, and industry solutions, visit us on the web at [www.cat.com](http://www.cat.com)

AEXQ4066-00 (11-2024)  
Build Number: 08D  
(Aus-NZ)

© 2024 Caterpillar  
All rights reserved

Materials and specifications are subject to change without notice. Featured machines in photos may include additional equipment. See your Cat dealer for available options.

CAT, CATERPILLAR, LET'S DO THE WORK, their respective logos, "Caterpillar Corporate Yellow," the "Power Edge" and Cat "Modern Hex" trade dress as well as corporate and product identity used herein, are trademarks of Caterpillar and may not be used without permission. VisionLink is a trademark of Caterpillar Inc., registered in the United States and in other countries.

