



395

Hydraulic Excavator

Technical Specifications

Configurations and features may vary by region. Please consult your Cat® dealer for availability in your area.

Table of Contents

Specifications	2
Engine	2
Swing Mechanism	2
Weights	2
Track	2
Drive	2
Hydraulic System	2
Service Refill Capacities	2
Standards	3
Sound Performance	3
Air Conditioning System	3
Operating Weights and Ground Pressures	4
Major Component Weights	5
Dimensions	6
Working Ranges	12
Reach Boom Lift Capacities	15
GP Boom Lift Capacities	24
Mass Boom Lift Capacities	39
Bucket Specifications and Compatibility:	
Australia and New Zealand	45
Europe	46
North America	48
South Korea	50
Turkey*	51
Chile	52
Attachments Offering Guide:	
Australia and New Zealand	53
Europe	54
North America	57
Turkey	60
Chile	63
Truck Pass Match – Global	65
Standard and Optional Equipment	66
Dealer Installed Kits and Attachments	68
Cab Options	69
395 Environmental Declaration	70

395 Hydraulic Excavator Specifications

Engine

Engine Model	Cat® C18	
Net Power – ISO 9249	404 kW	542 hp
Engine Power – ISO 14396	405 kW	543 hp
Bore	145 mm	6 in
Stroke	183 mm	7 in

- Displacement 18.1 L 1,105 in³
- Meets U.S. EPA Tier 4 Final, EU Stage V, Japan 2014 and Korea Stage V Final emission standards.
- Recommended for use up to 4500 m (14,760 ft) altitude with engine power derate above 3000 m (9,840 ft).
- Advertised power is tested per the specified standard in effect at the time of manufacture.
- Net power advertised is the power available at the flywheel when the engine is equipped with fan, air intake system, exhaust system and alternator.
- Engine speed at 1,900 rpm.
- Cat diesel engines are required to use ULSD (ultra-low sulfur diesel fuel with 15 ppm of sulfur or less) or ULSD blended with the following lower-carbon intensity fuels** up to:
 - ✓ 20% biodiesel FAME (fatty acid methyl ester)*
 - ✓ 100% renewable diesel, HVO (hydrotreated vegetable oil) and GTL (gas-to-liquid) fuels

Refer to guidelines for successful application. Please consult your Cat dealer or “Caterpillar Machine Fluids Recommendations” (SEBU6250) for details.

*Engines with no aftertreatment devices can use higher blends, up to 100% biodiesel (for use of blends higher than 20% biodiesel, consult your Cat dealer).

** Tailpipe greenhouse gas emissions from lower-carbon intensity fuels are essentially the same as traditional fuels.

Swing Mechanism

Swing Speed	6.26 rpm	
Maximum Swing Torque	362 kN·m	267,333 lbf·ft

Weights

Operating Weight	94 400 kg	208,100 lb
• Long Variable Gauge undercarriage, Mass boom, M2.92JC (9'7") stick, SDV 6.5 m ³ (8.5 yd ³) bucket, 650 mm (26") double grouser shoes and standard counterweight.		
Operating Weight	94 100 kg	207,400 lb
• Long Variable Gauge undercarriage, GP boom, R4.4HB2 (14'5") stick, SD 5.2 m ³ (6.8 yd ³) bucket, 900 mm (35") double grouser shoes and counterweight with removal device.		

Track

Optional Track Shoes Width	650 mm	26 in
Optional Track Shoes Width	750 mm	30 in
Optional Track Shoes Width	900 mm	35 in
Number of Shoes (each side)	51	
Number of Track Rollers (each side)	9	
Number of Carrier Rollers (each side)	3	

Drive

Maximum Gradeability	35°/70%	
Maximum Travel Speed	4.6 km/h	2.8 mph
Maximum Drawbar Pull	581 kN	130,614 lbf

Hydraulic System

Main System – Maximum Flow – Implement*	1064 L/min (532 × 2 pumps)	281 gal/min (141 × 2 pumps)
Swing System – Maximum Flow**	295 L/min	78 gal/min
Maximum Pressure – Equipment – Implement	37 000 kPa	5,366 psi
Maximum Pressure – Travel	35 000 kPa	5,076 psi
Maximum Pressure – Swing	31 000 kPa	4,496 psi
Boom Cylinder – Bore	210 mm	8 in
Boom Cylinder – Stroke	1967 mm	77 in
Stick Cylinder – Bore	225 mm	9 in
Stick Cylinder – Stroke	2262 mm	89 in
HB2 Bucket Cylinder – Bore	200 mm	8 in
HB2 Bucket Cylinder – Stroke	1451 mm	57 in
JC Bucket Cylinder – Bore	220 mm	9 in
JC Bucket Cylinder – Stroke	1586 mm	62 in

*1008 L/min (504 × 2 pumps) 266 gal/min (133 × 2 pumps) for 395 models sold in Europe and Turkey.

**279 L/min (74 gal/min) for 395 models sold in Europe.

Service Refill Capacities

Fuel Tank Capacity	1220 L	322 gal
Cooling System	71 L	19 gal
Engine Oil (with filter)	67 L	18 gal
Swing Drive (each)	24 L	6 gal
Final Drive (each)	20 L	5 gal
Hydraulic System (including tank)	740 L	195 gal
Hydraulic Tank (including suction pipe)	372 L	98 gal
Diesel Exhaust Fluid (DEF) Tank	80 L	21 gal

395 Hydraulic Excavator Specifications

Standards

Brakes	ISO 10265:2008
Cab/Operator Protective Guards (OPG) (optional)	ISO 10262:1998 Level II

Sound Performance

ISO 6395:2008 (external)	109 dB(A)
ISO 6396:2008 (inside cab)	73 dB(A)

- Hearing protection may be needed when operating with an open operator station and cab (when not properly maintained or doors/windows open) for extended periods or in a noisy environment.

Air Conditioning System

The air conditioning system on this machine contains the fluorinated greenhouse gas refrigerant R134a (Global Warming Potential = 1430). The system contains 1.0 kg of refrigerant, which has a CO₂ equivalent of 1.430 metric tonnes.

395 Hydraulic Excavator Specifications

Operating Weights and Ground Pressures

	650 mm (26")		750 mm (30")		900 mm (35")	
	Double Grouser Shoes		Double Grouser Shoes		Double Grouser Shoes	
	Weight	Ground Pressure	Weight	Ground Pressure	Weight	Ground Pressure
	kg (lb)	kPa (psi)	kg (lb)	kPa (psi)	kg (lb)	kPa (psi)
Base Machine Configurations						
Base Frame with Track Rollers and Carrier Rollers						
Standard Counterweight + Long Variable Gauge Undercarriage Base Machine						
Reach Boom + R4.4HB2 (14'5") Stick + 4.2 m ³ (5.5 yd ³) SD bucket	93 000 (205,000)	126.3 (18.3)	93 800 (206,900)	110.5 (16.0)	94 900 (209,200)	93.1 (13.5)
Reach Boom + R5.5HB2 (18'1") Stick + 4.2 m ³ (5.5 yd ³) SD bucket	93 400 (206,000)	126.9 (18.4)	94 300 (207,900)	111.0 (16.1)	95 400 (210,300)	93.5 (13.6)
GP Boom + GP2.92JC (9'7") Stick + 6.5 m ³ (8.5 yd ³) SDV bucket	94 600 (208,600)	128.5 (18.6)	95 500 (210,600)	112.4 (16.3)	96 600 (212,900)	94.7 (13.7)
GP Boom + GP3.4JC (11'2") Stick + 6.5 m ³ (8.5 yd ³) SDV bucket	94 900 (209,300)	128.9 (18.7)	95 800 (211,200)	112.8 (16.4)	96 900 (213,600)	95.0 (13.8)
GP Boom + R4.4HB2 (14'5") Stick + 5.2 m ³ (6.8 yd ³) SD bucket	92 100 (203,000)	125.1 (18.1)	93 000 (204,900)	109.4 (15.9)	94 000 (207,300)	92.2 (13.4)
GP Boom + R5.5HB2 (18'1") Stick + 5.2 m ³ (6.8 yd ³) SD bucket	92 600 (204,000)	125.7 (18.2)	93 400 (206,000)	110.0 (15.9)	94 500 (208,300)	92.7 (13.4)
Mass Boom + M2.92JC (9'7") Stick + 6.5 m ³ (8.5 yd ³) SDV bucket	94 400 (208,100)	128.2 (18.6)	95 300 (210,100)	112.1 (16.3)	96 300 (212,400)	94.5 (13.7)
Mass Boom + M3.4JC (11'2") Stick + 6.5 m ³ (8.5 yd ³) SDV bucket	94 500 (208,200)	128.3 (18.6)	95 300 (210,200)	112.2 (16.3)	96 400 (212,500)	94.5 (13.7)
Base Frame with Track Rollers and Carrier Rollers						
Removal Type Counterweight + Long Variable Gauge Undercarriage Base Machine						
Reach Boom + R4.4HB2 (14'5") Stick + 4.2 m ³ (5.5 yd ³) SD bucket	93 000 (205,100)	126.3 (18.3)	93 900 (207,000)	110.5 (16.0)	95 000 (209,400)	93.1 (13.5)
Reach Boom + R5.5HB2 (18'1") Stick + 4.2 m ³ (5.5 yd ³) SD bucket	93 500 (206,100)	127.0 (18.4)	94 400 (208,100)	111.1 (16.1)	95 400 (210,400)	93.6 (13.6)
GP Boom + GP2.92JC (9'7") Stick + 6.5 m ³ (8.5 yd ³) SDV bucket	94 700 (208,800)	128.6 (18.7)	95 600 (210,700)	112.5 (16.3)	96 600 (213,000)	94.8 (13.7)
GP Boom + GP3.4JC (11'2") Stick + 6.5 m ³ (8.5 yd ³) SDV bucket	95 000 (209,400)	129.0 (18.7)	95 900 (211,400)	112.8 (16.4)	96 900 (213,700)	95.1 (13.8)
GP Boom + R4.4HB2 (14'5") Stick + 5.2 m ³ (6.8 yd ³) SD bucket	92 100 (203,100)	125.1 (18.1)	93 000 (205,100)	109.5 (15.9)	94 100 (207,400)	92.3 (13.4)
GP Boom + R5.5HB2 (18'1") Stick + 5.2 m ³ (6.8 yd ³) SD bucket	92 600 (204,200)	125.8 (18.2)	93 500 (206,100)	110.0 (16.0)	94 500 (208,400)	92.7 (13.4)
Mass Boom + M2.92JC (9'7") Stick + 6.5 m ³ (8.5 yd ³) SDV bucket	94 500 (208,100)	128.3 (18.6)	95 300 (210,100)	112.2 (16.3)	96 400 (212,400)	94.6 (13.7)
Mass Boom + M3.4JC (11'2") Stick + 6.5 m ³ (8.5 yd ³) SDV bucket	94 500 (208,400)	128.3 (18.6)	95 400 (210,300)	112.3 (16.3)	96 400 (212,600)	94.6 (13.7)

All operating weights include a 90% fuel tank with 75 kg (165 lb) operator.

395 Hydraulic Excavator Specifications

Major Component Weights

	kg	lb
Base Machine Weight: including L upperframe, undercarriage, counterweight, boom cylinders, without boom, stick, bucket, stick cylinder, bucket cylinder, tracks, fuel tank, operator		
With Standard Counterweight, Swing Frame, Base Frame with Track Rollers and Carrier Rollers	62 260	137,250
With Removal Type Counterweight, Swing Frame, Base Frame with Track Rollers and Carrier Rollers	62 310	137,380
Track Shoes:		
650 mm (26") Width, 20.5 mm (0.8") Thick, Double Grouser Track Shoes	9290	20,470
750 mm (30") Width, 20.5 mm (0.8") Thick, Double Grouser Track Shoes	10 160	22,400
900 mm (35") Width, 20.5 mm (0.8") Thick, Double Grouser Track Shoes	11 220	24,740
Two Boom Cylinders	1820	4,010
Weight of 90% Fuel Tank and 75 kg (165 lb) Operator	1010	2,230
Counterweights:		
Standard Counterweight	15 450	34,060
Counterweight with Removal Device	15 510	34,190
Swing Frame	9100	20,060
Long Variable Gauge Undercarriage:		
Base Frame with Track Rollers and Carrier Rollers	24 170	53,290
Booms (including lines, pins, stick cylinder):		
Mass Boom 7.25 m (23'9")	8560	18,880
Reach Boom 10.0 m (32'10")	10 810	23,830
Sticks (including lines, pins, bucket cylinder, bucket linkage):		
Mass Stick M2.92JC (9'7")	5510	12,150
GP Stick GP2.92JC (9'7")	4990	10,990
Mass Stick M3.4JC (11'2")	5550	12,240
GP Stick GP3.4JC (11'2")	5290	11,660
Reach Stick R4.4HB2 (14'5")	5030	11,100
Reach Stick R5.5HB2 (18'1")	5510	12,140
Buckets (without linkage):		
4.2 m ³ (5.5 yd ³) SD	4580	10,100
5.2 m ³ (6.8 yd ³) SD	5190	11,440
6.5 m ³ (8.5 yd ³) SDV	7790	17,170
Quick Couplers:		
CW Dedicated Quick Coupler	1130	2,490
Pin Grabber Quick Coupler	1730	3,820

395 Hydraulic Excavator Specifications

Dimensions

All dimensions are approximate and may vary depending on bucket selection.

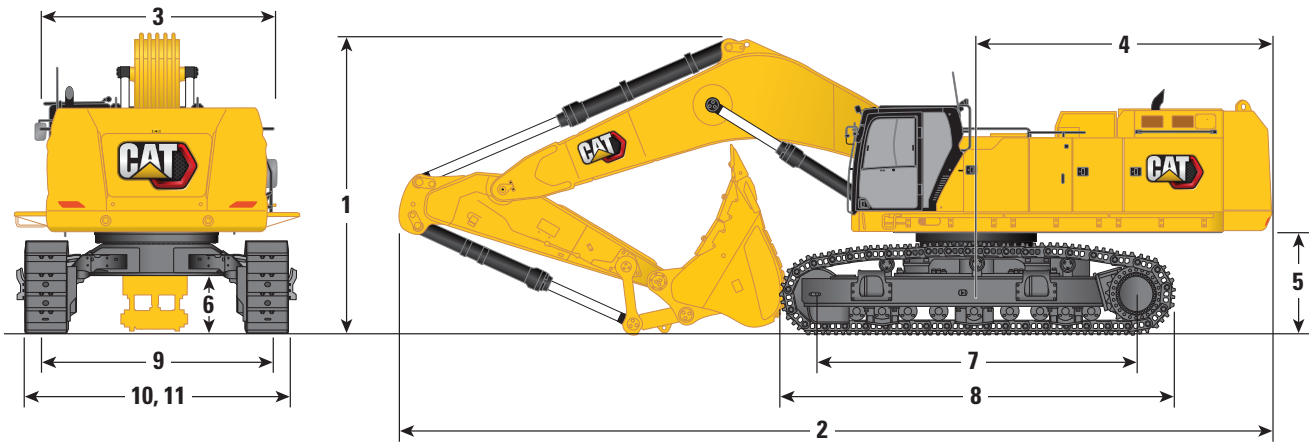

Boom Option

**Reach Boom
10.0 m (32'10")**

Stick Options

**Reach Stick
R4.4HB2 (14'5") R5.5HB2 (18'1")**

	R4.4HB2 (14'5")		R5.5HB2 (18'1")	
1 Machine Height:				
Cab Height	3670 mm	12'0"	3670 mm	12'0"
OPG Height	3810 mm	12'6"	3810 mm	12'6"
Handrails Height	3750 mm	12'4"	3750 mm	12'4"
With Boom/Stick/Bucket Installed	5180 mm	17'0"	5500 mm	18'1"
With Boom/Stick Installed	5000 mm	16'5"	5170 mm	17'0"
With Boom Installed	4300 mm	14'1"	4300 mm	14'1"
With Boom/Stick/Bucket Installed (with auxiliary lines)	5180 mm	17'0"	5520 mm	18'1"
With Boom/Stick Installed (with auxiliary lines)	5000 mm	16'5"	5210 mm	17'1"
With Boom Installed (with auxiliary lines)	4360 mm	14'4"	4360 mm	14'4"
2 Machine Length:				
With Boom/Stick/Bucket Installed	16 700 mm	54'9"	16 650 mm	54'8"
With Boom/Stick Installed	16 680 mm	54'9"	16 680 mm	54'9"
With Boom Installed	14 820 mm	48'7"	14 820 mm	48'7"
With Boom/Stick/Bucket Installed (with auxiliary lines)	16 700 mm	54'9"	16 650 mm	54'8"
With Boom/Stick Installed (with auxiliary lines)	16 680 mm	54'9"	16 680 mm	54'9"
With Boom Installed (with auxiliary lines)	14 820 mm	48'7"	14 820 mm	48'7"
3 Upperframe Width:				
Without Walkways	3490 mm	11'5"	3490 mm	11'5"
With Walkways	4510 mm	14'10"	4510 mm	14'10"
Walkways Width	500 mm	1'8"	500 mm	1'8"
4 Tail Swing Radius	4840 mm	15'11"	4840 mm	15'11"
5 Counterweight Clearance	1640 mm	5'5"	1640 mm	5'5"
6 Ground Clearance	830 mm	2'9"	830 mm	2'9"

(continued on next page)

395 Hydraulic Excavator Specifications

Dimensions

All dimensions are approximate and may vary depending on bucket selection.

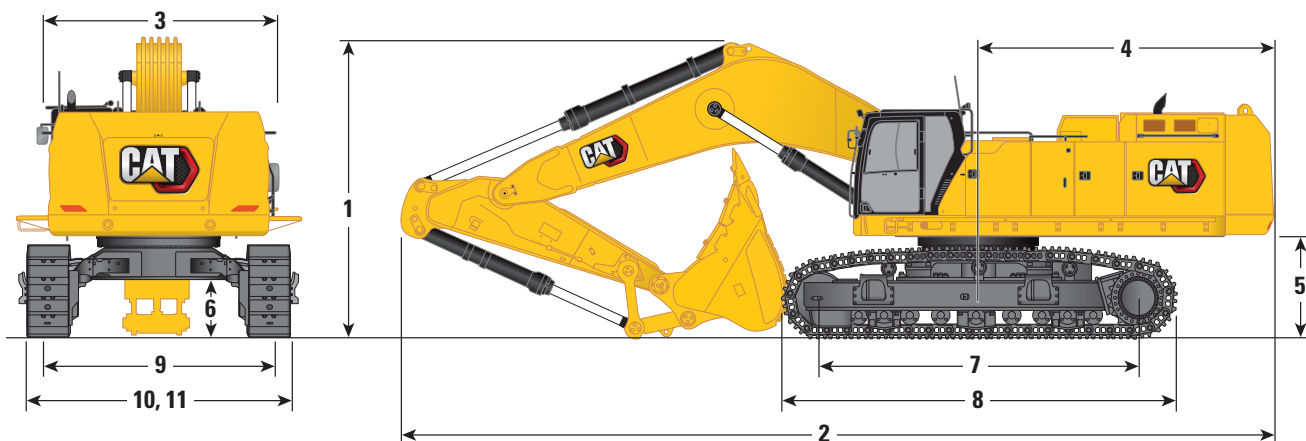

Boom Option	Reach Boom 10.0 m (32'10")			
	Reach Stick R4.4HB2 (14'5")		R5.5HB2 (18'1")	
7 Track Length – Length to Center of Rollers	5120 mm	16'10"	5120 mm	16'10"
8 Track Length	6350 mm	20'10"	6350 mm	20'10"
9 Track Gauge:				
Retracted	2750 mm	9'0"	2750 mm	9'0"
Extended	3510 mm	11'6"	3510 mm	11'6"
10 Track Width – Retracted:				
650 mm (26") Shoes	3400 mm	11'2"	3400 mm	11'2"
750 mm (30") Shoes	3500 mm	11'6"	3500 mm	11'6"
900 mm (35") Shoes	3840 mm	12'7"	3840 mm	12'7"
Track Width – Extended:				
650 mm (26") Shoes	4160 mm	13'8"	4160 mm	13'8"
750 mm (30") Shoes	4260 mm	14'0"	4260 mm	14'0"
900 mm (35") Shoes	4410 mm	14'6"	4410 mm	14'6"
11 Undercarriage Width – Retracted (with steps):				
650 mm (26") Shoes	3690 mm	12'1"	3690 mm	12'1"
750 mm (30") Shoes	3690 mm	12'1"	3690 mm	12'1"
900 mm (35") Shoes	3880 mm	12'9"	3880 mm	12'9"
Undercarriage Width – Extended (with steps):				
650 mm (26") Shoes	4450 mm	14'7"	4450 mm	14'7"
750 mm (30") Shoes	4450 mm	14'7"	4450 mm	14'7"
900 mm (35") Shoes	4450 mm	14'7"	4450 mm	14'7"
Bucket Type	SD		SD	
Bucket Capacity	4.20 m ³	5.50 yd ³	4.20 m ³	5.50 yd ³
Bucket Tip Radius	2430 mm	8'0"	2430 mm	8'0"

395 Hydraulic Excavator Specifications

Dimensions

All dimensions are approximate and may vary depending on bucket selection.

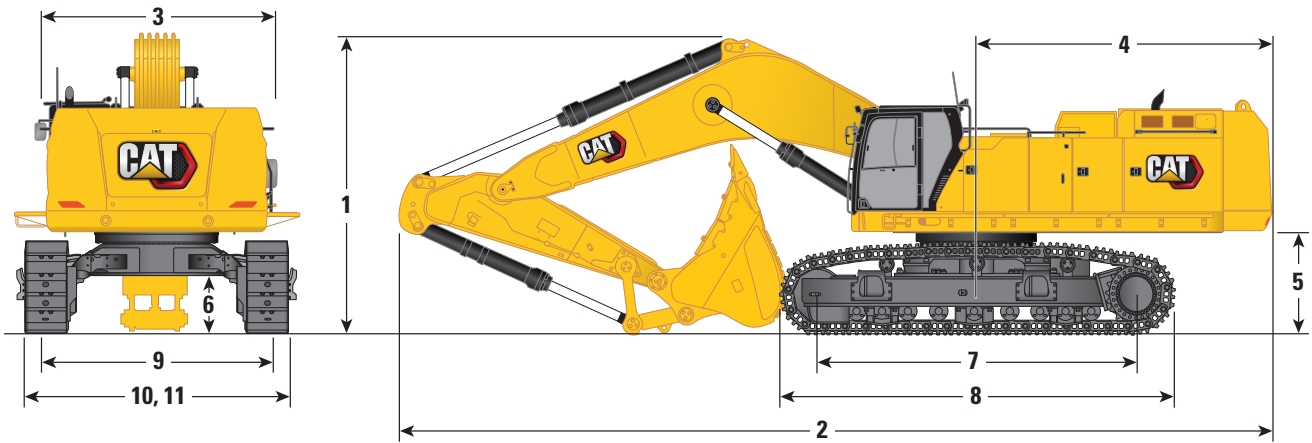

Boom Option

GP Boom
8.4 m (27'7")

Stick Options

GP Stick

Reach Stick

GP2.92JC (9'7")

GP3.4JC (11'2")

R4.4HB2 (14'5")

R5.5HB2 (18'1")

1 Machine Height:

Cab Height	3670 mm	12'0"	3670 mm	12'0"	3670 mm	12'0"	3670 mm	12'0"
OPG Height	3810 mm	12'6"	3810 mm	12'6"	3810 mm	12'6"	3810 mm	12'6"
Handrails Height	3750 mm	12'4"	3750 mm	12'4"	3750 mm	12'4"	3750 mm	12'4"
With Boom/Stick/Bucket Installed	5100 mm	16'9"	5250 mm	17'3"	5380 mm	17'8"	5900 mm	19'4"
With Boom/Stick Installed	4770 mm	15'8"	4900 mm	16'1"	5090 mm	16'8"	5510 mm	18'1"
With Boom Installed	4070 mm	13'4"	4070 mm	13'4"	4070 mm	13'4"	4070 mm	13'4"
With Boom/Stick/Bucket Installed (with auxiliary lines)	5110 mm	16'9"	5270 mm	17'3"	5390 mm	17'8"	5930 mm	19'5"
With Boom/Stick Installed (with auxiliary lines)	4770 mm	15'8"	4900 mm	16'1"	5090 mm	16'8"	5530 mm	18'2"
With Boom Installed (with auxiliary lines)	4140 mm	13'7"	4140 mm	13'7"	4140 mm	13'7"	4140 mm	13'7"

2 Machine Length:

With Boom/Stick/Bucket Installed	15 090 mm	49'6"	15 090 mm	49'6"	15 090 mm	49'6"	14 870 mm	48'9"
With Boom/Stick Installed	15 030 mm	49'4"	15 070 mm	49'5"	15 100 mm	49'6"	15 040 mm	49'4"
With Boom Installed	13 160 mm	43'2"	13 160 mm	43'2"	13 160 mm	43'2"	13 160 mm	43'2"
With Boom/Stick/Bucket Installed (with auxiliary lines)	15 090 mm	49'6"	15 090 mm	49'6"	15 090 mm	49'6"	14 870 mm	48'9"
With Boom/Stick Installed (with auxiliary lines)	15 030 mm	49'4"	15 070 mm	49'5"	15 100 mm	49'6"	15 040 mm	49'4"
With Boom Installed (with auxiliary lines)	13 150 mm	43'2"	13 150 mm	43'2"	13 150 mm	43'2"	13 150 mm	43'2"

3 Upperframe Width:

Without Walkways	3490 mm	11'5"	3490 mm	11'5"	3490 mm	11'5"	3490 mm	11'5"
With Walkways	4510 mm	14'10"	4510 mm	14'10"	4510 mm	14'10"	4510 mm	14'10"
Walkways Width	500 mm	1'8"	500 mm	1'8"	500 mm	1'8"	500 mm	1'8"

4 Tail Swing Radius

	4840 mm	15'11"	4840 mm	15'11"	4840 mm	15'11"	4840 mm	15'11"
--	---------	--------	---------	--------	---------	--------	---------	--------

5 Counterweight Clearance

	1640 mm	5'5"	1640 mm	5'5"	1640 mm	5'5"	1640 mm	5'5"
--	---------	------	---------	------	---------	------	---------	------

6 Ground Clearance

	830 mm	2'9"	830 mm	2'9"	830 mm	2'9"	830 mm	2'9"
--	--------	------	--------	------	--------	------	--------	------

(continued on next page)

395 Hydraulic Excavator Specifications

Dimensions

All dimensions are approximate and may vary depending on bucket selection.

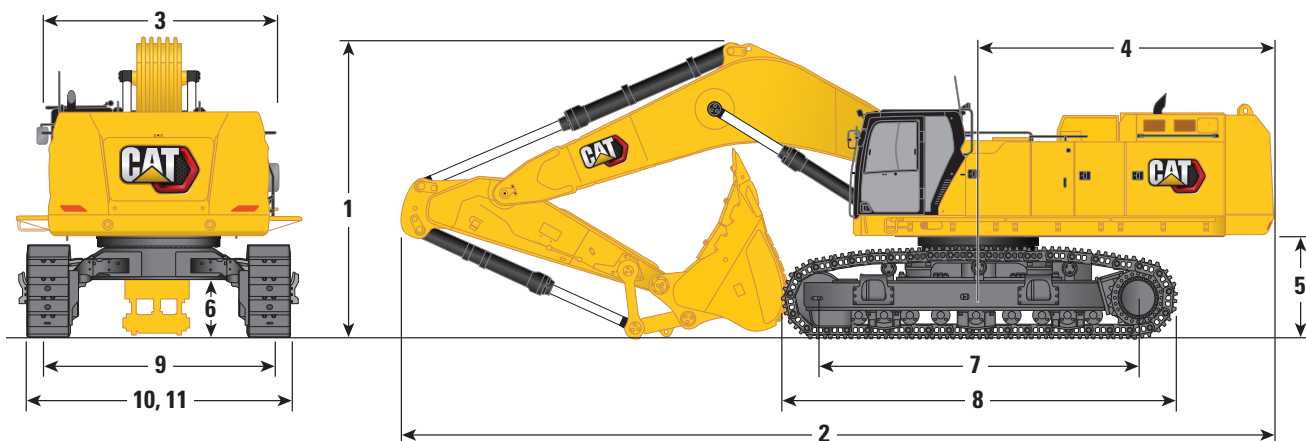

Boom Option

GP Boom
8.4 m (27'7")

Stick Options

GP Stick

Reach Stick

	GP2.92JC (9'7")		GP3.4JC (11'2")		R4.4HB2 (14'5")		R5.5HB2 (18'1")	
7 Track Length – Length to Center of Rollers	5120 mm	16'10"	5120 mm	16'10"	5120 mm	16'10"	5120 mm	16'10"
8 Track Length	6350 mm	20'10"	6350 mm	20'10"	6350 mm	20'10"	6350 mm	20'10"
9 Track Gauge:								
Retracted	2750 mm	9'0"	2750 mm	9'0"	2750 mm	9'0"	2750 mm	9'0"
Extended	3510 mm	11'6"	3510 mm	11'6"	3510 mm	11'6"	3510 mm	11'6"
10 Track Width – Retracted:								
650 mm (26") Shoes	3400 mm	11'2"	3400 mm	11'2"	3400 mm	11'2"	3400 mm	11'2"
750 mm (30") Shoes	3500 mm	11'6"	3500 mm	11'6"	3500 mm	11'6"	3500 mm	11'6"
900 mm (35") Shoes	3840 mm	12'7"	3840 mm	12'7"	3840 mm	12'7"	3840 mm	12'7"
Track Width – Extended:								
650 mm (26") Shoes	4160 mm	13'8"	4160 mm	13'8"	4160 mm	13'8"	4160 mm	13'8"
750 mm (30") Shoes	4260 mm	14'0"	4260 mm	14'0"	4260 mm	14'0"	4260 mm	14'0"
900 mm (35") Shoes	4410 mm	14'6"	4410 mm	14'6"	4410 mm	14'6"	4410 mm	14'6"
11 Undercarriage Width – Retracted (with steps):								
650 mm (26") Shoes	3690 mm	12'1"	3690 mm	12'1"	3690 mm	12'1"	3690 mm	12'1"
750 mm (30") Shoes	3690 mm	12'1"	3690 mm	12'1"	3690 mm	12'1"	3690 mm	12'1"
900 mm (35") Shoes	3880 mm	12'9"	3880 mm	12'9"	3880 mm	12'9"	3880 mm	12'9"
Undercarriage Width – Extended (with steps):								
650 mm (26") Shoes	4450 mm	14'7"	4450 mm	14'7"	4450 mm	14'7"	4450 mm	14'7"
750 mm (30") Shoes	4450 mm	14'7"	4450 mm	14'7"	4450 mm	14'7"	4450 mm	14'7"
900 mm (35") Shoes	4450 mm	14'7"	4450 mm	14'7"	4450 mm	14'7"	4450 mm	14'7"
Bucket Type	SDV		SDV		SD		SD	
Bucket Capacity	6.50 m ³	8.50 yd ³	6.50 m ³	8.50 yd ³	5.20 m ³	6.80 yd ³	5.20 m ³	6.80 yd ³
Bucket Tip Radius	2530 mm	8'4"	2530 mm	8'4"	2440 mm	8'0"	2440 mm	8'0"

395 Hydraulic Excavator Specifications

Dimensions

All dimensions are approximate and may vary depending on bucket selection.

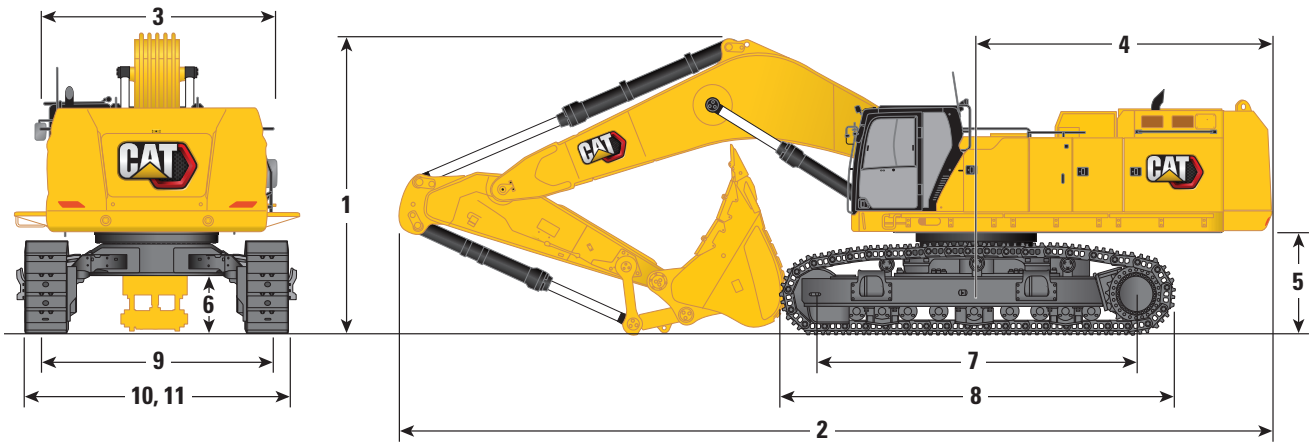

Boom Option

Mass Boom
7.25 m (23'9")

Stick Options

Mass Stick
M2.92JC (9'7") **M3.4JC (11'2")**

	M2.92JC (9'7")		M3.4JC (11'2")	
1 Machine Height:				
Cab Height	3670 mm	12'0"	3670 mm	12'0"
OPG Height	3810 mm	12'6"	3810 mm	12'6"
Handrails Height	3750 mm	12'4"	3750 mm	12'4"
With Boom/Stick/Bucket Installed	5330 mm	17'6"	5330 mm	17'6"
With Boom/Stick Installed	4560 mm	15'0"	4660 mm	15'3"
With Boom Installed	3940 mm	12'11"	3940 mm	12'11"
With Boom/Stick/Bucket Installed (with auxiliary lines)	5350 mm	17'7"	5350 mm	17'7"
With Boom/Stick Installed (with auxiliary lines)	4630 mm	15'2"	4730 mm	15'6"
With Boom Installed (with auxiliary lines)	4010 mm	13'2"	4010 mm	13'2"
2 Machine Length:				
With Boom/Stick/Bucket Installed	13 980 mm	45'10"	13 890 mm	45'7"
With Boom/Stick Installed	13 800 mm	45'3"	13 850 mm	45'5"
With Boom Installed	11 980 mm	39'4"	11 980 mm	39'4"
With Boom/Stick/Bucket Installed (with auxiliary lines)	13 980 mm	45'10"	13 890 mm	45'7"
With Boom/Stick Installed (with auxiliary lines)	13 800 mm	45'3"	13 850 mm	45'5"
With Boom Installed (with auxiliary lines)	11 990 mm	39'4"	11 990 mm	39'4"
3 Upperframe Width:				
Without Walkways	3490 mm	11'5"	3490 mm	11'5"
With Walkways	4510 mm	14'10"	4510 mm	14'10"
Walkways Width	500 mm	1'8"	500 mm	1'8"
4 Tail Swing Radius	4840 mm	15'11"	4840 mm	15'11"
5 Counterweight Clearance	1640 mm	5'5"	1640 mm	5'5"
6 Ground Clearance	830 mm	2'9"	830 mm	2'9"

(continued on next page)

395 Hydraulic Excavator Specifications

Dimensions

All dimensions are approximate and may vary depending on bucket selection.

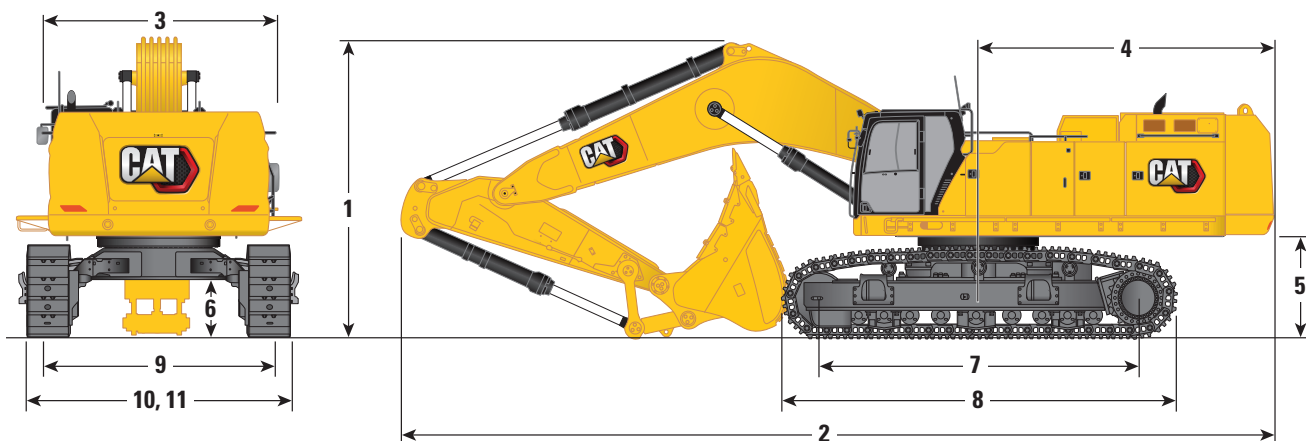

Boom Option	Mass Boom 7.25 m (23'9")			
	Stick Options			
Stick Options	M2.92JC (9'7")		M3.4JC (11'2")	
	7 Track Length – Length to Center of Rollers	5120 mm	16'10"	5120 mm
8 Track Length	6350 mm	20'10"	6350 mm	20'10"
9 Track Gauge:				
Retracted	2750 mm	9'0"	2750 mm	9'0"
Extended	3510 mm	11'6"	3510 mm	11'6"
10 Track Width – Retracted:				
650 mm (26") Shoes	3400 mm	11'2"	3400 mm	11'2"
750 mm (30") Shoes	3500 mm	11'6"	3500 mm	11'6"
900 mm (35") Shoes	3840 mm	12'7"	3840 mm	12'7"
Track Width – Extended:				
650 mm (26") Shoes	4160 mm	13'8"	4160 mm	13'8"
750 mm (30") Shoes	4260 mm	14'0"	4260 mm	14'0"
900 mm (35") Shoes	4410 mm	14'6"	4410 mm	14'6"
11 Undercarriage Width – Retracted (with steps):				
650 mm (26") Shoes	3690 mm	12'1"	3690 mm	12'1"
750 mm (30") Shoes	3690 mm	12'1"	3690 mm	12'1"
900 mm (35") Shoes	3880 mm	12'9"	3880 mm	12'9"
Undercarriage Width – Extended (with steps):				
650 mm (26") Shoes	4450 mm	14'7"	4450 mm	14'7"
750 mm (30") Shoes	4450 mm	14'7"	4450 mm	14'7"
900 mm (35") Shoes	4450 mm	14'7"	4450 mm	14'7"
Bucket Type	SDV		SDV	
Bucket Capacity	6.50 m ³	8.50 yd ³	6.50 m ³	8.50 yd ³
Bucket Tip Radius	2530 mm	8'4"	2530 mm	8'4"

395 Hydraulic Excavator Specifications

Working Ranges

All dimensions are approximate and may vary depending on bucket selection.

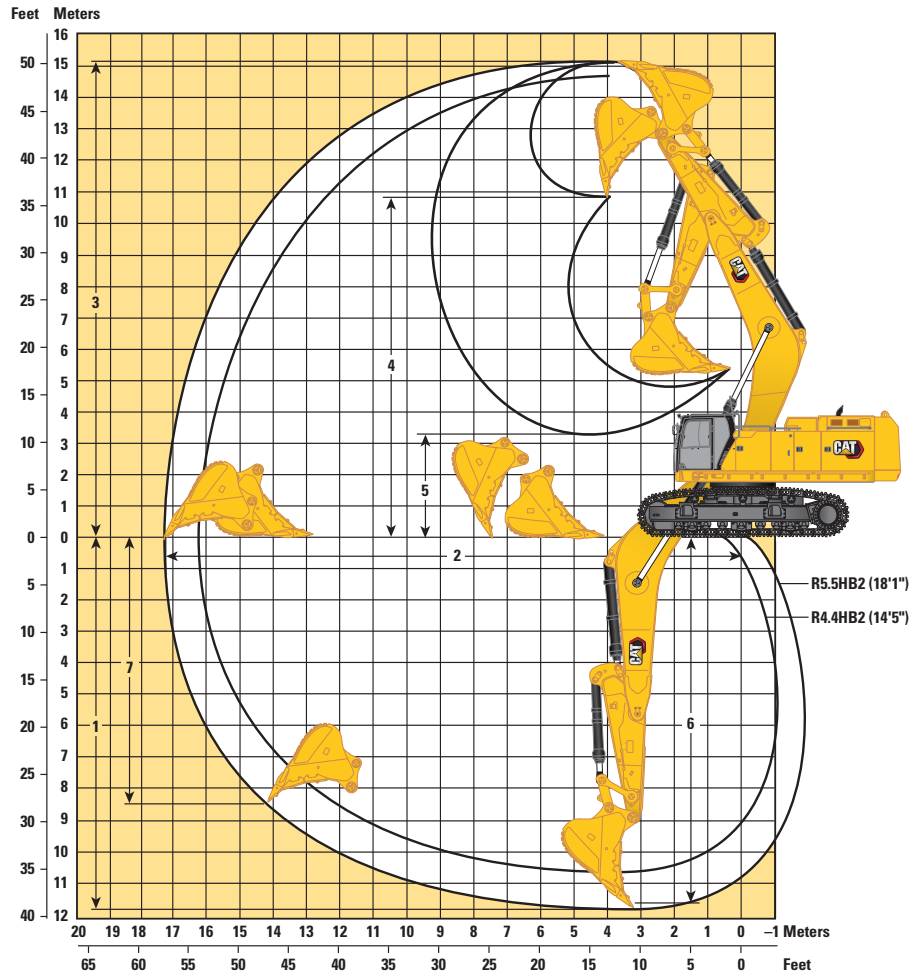

Boom Option	Reach Boom 10.0 m (32'10")			
	Reach Stick		Reach Boom	
Stick Options	R4.4HB2 (14'5")		R5.5HB2 (18'1")	
1 Maximum Digging Depth	10 720 mm	35'2"	11 820 mm	38'9"
2 Maximum Reach at Ground Line	16 250 mm	53'4"	17 270 mm	56'8"
3 Maximum Cutting Height	14 750 mm	48'5"	15 190 mm	49'10"
4 Maximum Loading Height	10 510 mm	34'6"	10 940 mm	35'11"
5 Minimum Loading Height	4400 mm	14'5"	3300 mm	10'10"
6 Maximum Depth Cut for 2440 mm (8'0") Level Bottom	10 600 mm	34'9"	11 720 mm	38'5"
7 Maximum Vertical Wall Digging Depth	7320 mm	24'0"	8330 mm	27'4"
Bucket Digging Force (ISO)	384 kN	86,290 lbf	386 kN	86,660 lbf
Stick Digging Force (ISO)	305 kN	68,600 lbf	261 kN	58,630 lbf
Bucket Type	SD		SD	
Bucket Capacity	4.20 m ³	5.50 yd ³	4.20 m ³	5.50 yd ³
Bucket Tip Radius	2430 mm	8'0"	2430 mm	8'0"

395 Hydraulic Excavator Specifications

Working Ranges

All dimensions are approximate and may vary depending on bucket selection.

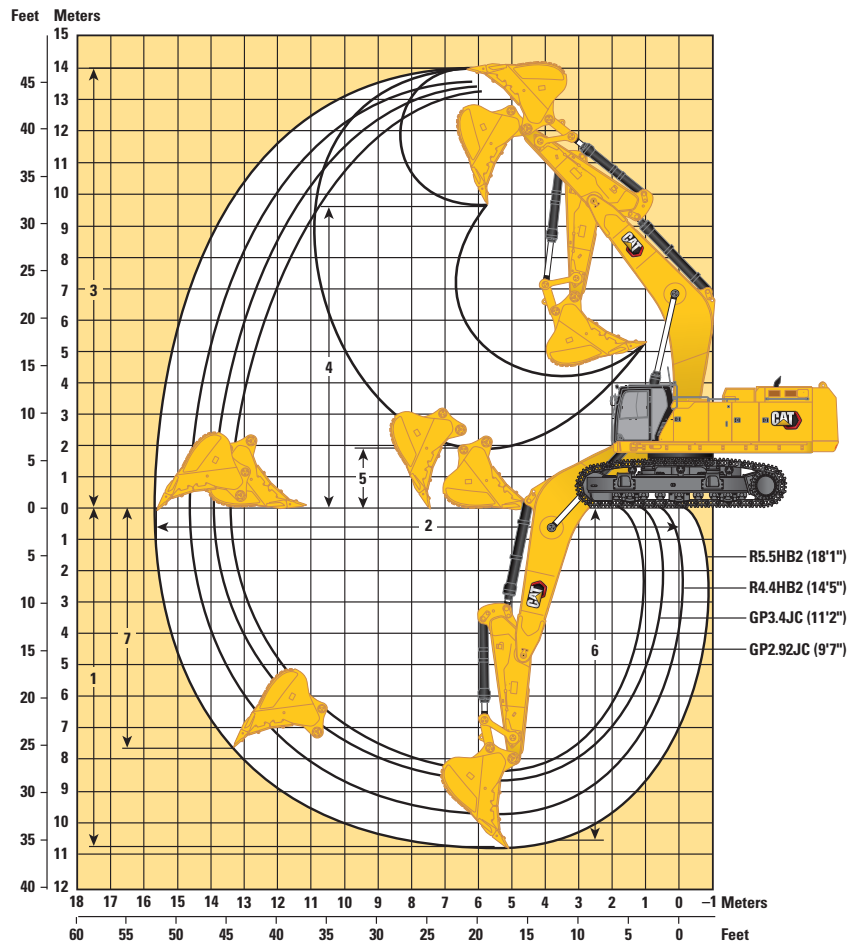

Boom Option

GP Boom
8.4 m (27'7")

Stick Options

GP Stick

Reach Stick

	GP2.92JC (9'7")		GP3.4JC (11'2")		R4.4HB2 (14'5")		R5.5HB2 (18'1")	
1 Maximum Digging Depth	8280 mm	27'2"	8750 mm	28'8"	9670 mm	31'9"	10 770 mm	35'4"
2 Maximum Reach at Ground Line	13 520 mm	44'4"	13 980 mm	45'10"	14 710 mm	48'3"	15 750 mm	51'8"
3 Maximum Cutting Height	13 240 mm	43'5"	13 470 mm	44'2"	13 540 mm	44'5"	14 000 mm	45'11"
4 Maximum Loading Height	8790 mm	28'10"	9030 mm	29'8"	9250 mm	30'4"	9710 mm	31'10"
5 Minimum Loading Height	4430 mm	14'6"	3960 mm	13'0"	3030 mm	9'11"	1930 mm	6'4"
6 Maximum Depth Cut for 2440 mm (8'0") Level Bottom	8140 mm	26'8"	8620 mm	28'3"	9560 mm	31'4"	10 680 mm	35'0"
7 Maximum Vertical Wall Digging Depth	5710 mm	18'9"	6100 mm	20'0"	6770 mm	22'3"	7770 mm	25'6"
Bucket Digging Force (ISO)	497 kN	111,830 lbf	498 kN	111,950 lbf	383 kN	86,100 lbf	385 kN	86,480 lbf
Stick Digging Force (ISO)	394 kN	88,580 lbf	360 kN	80,920 lbf	305 kN	68,540 lbf	261 kN	58,590 lbf
Bucket Type	SDV		SDV		SD		SD	
Bucket Capacity	6.50 m ³	8.50 yd ³	6.50 m ³	8.50 yd ³	5.20 m ³	6.80 yd ³	5.20 m ³	6.80 yd ³
Bucket Tip Radius	2530 mm	8'4"	2530 mm"	8'4"	2440 mm	8'0"	2440 mm	8'0"

395 Hydraulic Excavator Specifications

Working Ranges

All dimensions are approximate and may vary depending on bucket selection.

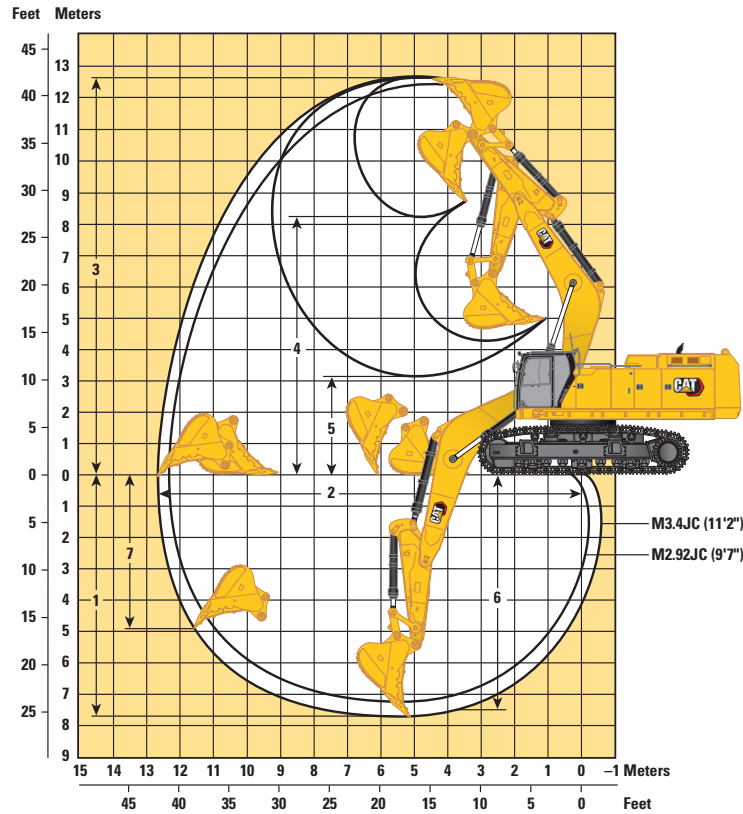

Boom Option	Mass Boom 7.25 m (23'9")			
	Stick Options		Mass Stick	
	M2.92JC (9'7")		M3.4JC (11'2")	
1 Maximum Digging Depth	7190 mm	23'7"	7660 mm	25'2"
2 Maximum Reach at Ground Line	12 260 mm	40'3"	12 700 mm	41'8"
3 Maximum Cutting Height	12 370 mm	40'7"	12 590 mm	41'4"
4 Maximum Loading Height	7960 mm	26'1"	8190 mm	26'10"
5 Minimum Loading Height	3660 mm	12'0"	3190 mm	10'6"
6 Maximum Depth Cut for 2440 mm (8'0") Level Bottom	7050 mm	23'2"	7530 mm	24'8"
7 Maximum Vertical Wall Digging Depth	4580 mm	15'0"	4970 mm	16'4"
Bucket Digging Force (ISO)	497 kN	111,820 lbf	498 kN	111,950 lbf
Stick Digging Force (ISO)	394 kN	88,570 lbf	360 kN	80,920 lbf
Bucket Type	SDV		SDV	
Bucket Capacity	6.50 m ³	8.50 yd ³	6.50 m ³	8.50 yd ³
Bucket Tip Radius	2530 mm	8'4"	2530 mm	8'4"

395 Hydraulic Excavator Specifications

Reach Boom Lift Capacities – Standard Counterweight** – without Bucket

Long Variable Gauge Undercarriage

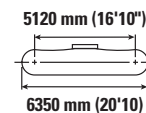
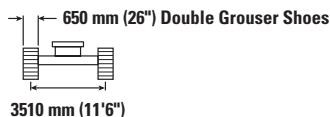
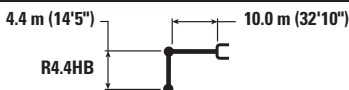

Reach (mm/ft)	Unit	4500 mm/15'0"		6000 mm/20'0"		7500 mm/25'0"		9000 mm/30'0"		10 500 mm/35'0"		12 000 mm/40'0"		13 500 mm/45'0"		mm/ft/in					
		kg	lb	kg	lb	kg	lb	kg	lb	kg	lb	kg	lb	kg	lb	kg	lb				
12 000 mm 40'0"	kg lb									*13 200	*13 200					*13 150	*13 150	10 510 *29,150	*29,150	33'10"	
10 500 mm 35'0"	kg lb									*15 400	*15 400					*12 650	*12 650	11 680	*27,900	*27,900	37'11"
9000 mm 30'0"	kg lb									*15 700	*15 700	*14 750	13 250			*12 400	12 150	12 560	*34,200	*34,200	40'11"
7500 mm 25'0"	kg lb							*18 250	*18 250	*16 350	16 300	*15 000	13 000			*12 400	10 900	13 210	*39,550	*39,550	43'2"
6000 mm 20'0"	kg lb			*29 950	*29 950	*23 400	*23 400	*19 600	*19 600	*17 150	15 650	*15 450	12 650	*14 100	10 250	*12 600	10 050	13 660	*64,150	*64,150	44'8"
4500 mm 15'0"	kg lb					*25 650	24 250	*20 950	18 800	*18 000	15 000	*15 900	12 200	*14 400	10 000	*13 000	9450	13 940			45'8"
3000 mm 10'0"	kg lb					*27 350	22 750	*22 100	17 800	*18 750	14 300	*16 350	11 750	*14 600	9750	*13 600	9150	14 040			46'0"
1500 mm 5'0"	kg lb					*28 150	21 700	*22 850	17 000	*19 250	13 750	*16 650	11 350	14 350	9550	13 600	9000	13 980			45'10"
0 mm 0'0"	kg lb			*14 750	*14 750	*28 050	21 150	*23 050	16 500	*19 400	13 350	*16 700	11 100	14 200	9350	13 800	9100	13 760			45'1"
-1500 mm -5'0"	kg lb			*22 350	*22 350	*27 250	20 950	*22 650	16 200	*19 150	13 100	*16 350	10 900			*14 000	9450	13 370			43'9"
-3000 mm -10'0"	kg lb	*20 000	*20 000	*30 450	29 600	*25 750	20 950	*21 650	16 150	*18 300	13 050	*15 450	10 900			*13 900	10 050	12 780	*45,600	*45,600	41'10"
-4500 mm -15'0"	kg lb	*29 800	*29 800	*27 450	*27 450	*23 500	21 200	*19 900	16 250	*16 750	13 150					*13 600	11 100	11 970	*67,350	*67,350	39'1"
-6000 mm -20'0"	kg lb	*26 000	*26 000	*23 400	*23 400	*20 300	*20 300	*17 200	16 600	*13 950	13 500					*12 950	12 900	10 900	*56,250	*56,250	35'5"
-7500 mm -25'0"	kg lb			*17 850	*17 850	*15 600	*15 600	*12 600	*12 600							*11 450	*11 450	9460			30'7"



ISO 10567:2007



*Indicates that the load is limited by hydraulic lifting capacity rather than tipping load. The above loads are in compliance with hydraulic excavator lift capacity standard ISO 10567:2007. They do not exceed 87% of hydraulic lifting capacity or 75% of tipping load. Weight of all lifting accessories must be deducted from the above lifting capacities. Lifting capacities are based on the machine standing on a firm, uniform supporting surface. The use of a work tool attachment point to handle/lift objects, could affect the machine lift performance.

**Lift capacities apply to both standard counterweight and counterweight with removal device.

Lift capacity stays with ±5% for all available track shoes.

Always refer to the appropriate Operation and Maintenance Manual for specific product information.

395 Hydraulic Excavator Specifications

Reach Boom Lift Capacities – Standard Counterweight** – without Bucket

Long Variable Gauge Undercarriage

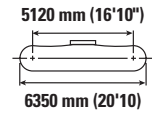
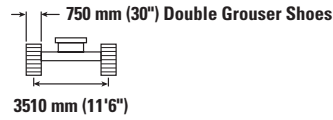
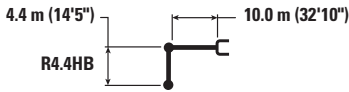

Reach Boom Length	Unit	4500 mm/15'0"		6000 mm/20'0"		7500 mm/25'0"		9000 mm/30'0"		10 500 mm/35'0"		12 000 mm/40'0"		13 500 mm/45'0"		mm ft/in		
		kg	lb	kg	lb	kg	lb	kg	lb	kg	lb	kg	lb	kg	lb	kg	lb	
12 000 mm 40'0"	kg lb									*13 200 *13 200					*13 150 *29,150	*13 150 *29,150	10 510 33'10"	
10 500 mm 35'0"	kg lb									*15 400 *33,750	*15 400 *33,750				*12 650 *27,900	*12 650 *27,900	11 680 37'11"	
9000 mm 30'0"	kg lb									*15 700 *34,200	*15 700 *34,200	*14 750 *31,700	13 400 28,650		*12 400 *27,350	*12 400 27,300	12 560 40'11"	
7500 mm 25'0"	kg lb							*18 250 *39,550	*18 250 *39,550	*16 350 *35,450	*16 350 *35,450	*15 000 *32,650	13 150 28,150		*12 400 *27,300	11 000 24,400	13 210 43'2"	
6000 mm 20'0"	kg lb			*29 950 *64,150	*29 950 *64,150	*23 400 *50,400	*23 400 *50,400	*19 600 *42,400	*19 600 *42,400	*17 150 *37,150	15 800 34,050	*15 450 *33,500	12 750 27,400	*14 100 10 350	*12 600 *27,750	10 150 22,400	13 660 44'8"	
4500 mm 15'0"	kg lb					*25 650 *55,250	24 500 52,950	*20 950 *45,300	18 950 40,950	*18 000 *38,950	15 100 32,600	*15 900 *34,550	12 300 26,450	*14 400 *31,300	10 150 21,700	*13 000 *28,550	9550 21,100	13 940 45'8"
3000 mm 10'0"	kg lb					*27 350 *59,050	22 950 49,600	*22 100 *47,850	17 950 38,800	*18 750 *40,550	14 450 31,200	*16 350 *35,450	11 900 25,550	*14 600 *31,650	9850 21,200	*13 600 *29,850	9250 20,350	14 040 46'0"
1500 mm 5'0"	kg lb					*28 150 *60,900	21 950 47,350	*22 850 *49,450	17 200 37,100	*19 250 *41,650	13 900 30,000	*16 650 *36,050	11 500 24,750	14 500 31,200	9650 20,700	13 750 30,300	9100 20,100	13 980 45'10"
0 mm 0'0"	kg lb			*14 750 *35,000	*14 750 *35,000	*28 050 *60,850	21 400 46,100	*23 050 *49,900	16 650 35,950	*19 400 *42,000	13 500 29,100	*16 700 *36,100	11 200 24,150	14 350 30,850	9450 20,350	13 950 30,750	9200 20,300	13 760 45'1"
-1500 mm -5'0"	kg lb			*22 350 *51,700	*22 350 *51,700	*27 250 *59,100	21 150 45,600	*22 650 *49,050	16 400 35,300	*19 150 *41,400	13 250 28,600	*16 350 *35,250	11 050 23,800		*14 000 *30,900	9550 21,000	13 370 43'9"	
-3000 mm -10'0"	kg lb	*20 000 *45,600	*20 000 *45,600	*30 450 *66,200	29 900 64,250	*25 750 *55,800	21 200 45,600	*21 650 *46,850	16 300 35,150	*18 300 *39,500	13 200 28,400	*15 450 *33,100	11 000 23,750		*13 900 *30,600	10 150 22,450	12 780 41'10"	
-4500 mm -15'0"	kg lb	*29 800 *67,350	*29 800 *67,350	*27 450 *59,550	*27 450 *59,550	*23 500 *50,850	21 400 46,100	*19 900 *42,950	16 450 35,450	*16 750 *35,950	13 300 28,700				*13 600 *29,950	11 250 24,900	11 970 39'1"	
-6000 mm -20'0"	kg lb	*26 000 *56,250	*26 000 *56,250	*23 400 *50,500	*23 400 *50,500	*20 300 *43,600	*20 300 *43,600	*17 200 *36,700	16 800 36,200	*13 950 *29,250	13 650 29,250				*12 950 *28,350	*12 950 *28,350	10 900 35'5"	
-7500 mm -25'0"	kg lb			*17 850 *37,850	*17 850 *37,850	*15 600 *32,800	*15 600 *32,800	*12 600 *25,850	*12 600 *25,850						*11 450 *24,800	*11 450 *24,800	9460 30'7"	



ISO 10567:2007



*Indicates that the load is limited by hydraulic lifting capacity rather than tipping load. The above loads are in compliance with hydraulic excavator lift capacity standard ISO 10567:2007.

They do not exceed 87% of hydraulic lifting capacity or 75% of tipping load. Weight of all lifting accessories must be deducted from the above lifting capacities. Lifting capacities are based on the machine standing on a firm, uniform supporting surface. The use of a work tool attachment point to handle/lift objects, could affect the machine lift performance.

**Lift capacities apply to both standard counterweight and counterweight with removal device.

Lift capacity stays with ±5% for all available track shoes.

Always refer to the appropriate Operation and Maintenance Manual for specific product information.

395 Hydraulic Excavator Specifications

Reach Boom Lift Capacities – Standard Counterweight** – without Bucket

Long Variable Gauge Undercarriage

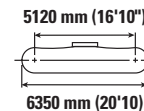
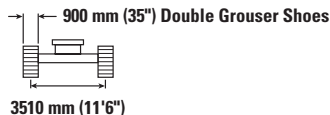
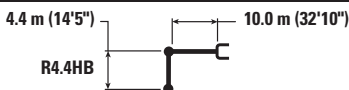

Reach Boom Length	Unit	4500 mm/15'0"		6000 mm/20'0"		7500 mm/25'0"		9000 mm/30'0"		10 500 mm/35'0"		12 000 mm/40'0"		13 500 mm/45'0"		mm ft/in		
		kg	lb	kg	lb	kg	lb	kg	lb	kg	lb	kg	lb	kg	lb	kg	lb	
12 000 mm 40'0"	kg lb									*13 200	*13 200					*13 150 *29,150	*13 150 *29,150	10 510 33'10"
10 500 mm 35'0"	kg lb									*15 400 *33,750	*15 400 *33,750					*12 650 *27,900	*12 650 *27,900	11 680 37'11"
9000 mm 30'0"	kg lb									*15 700 *34,200	*15 700 *34,200	*14 750 *31,700	13 550 28,950			*12 400 *27,350	*12 400 *27,350	12 400 40'11"
7500 mm 25'0"	kg lb							*18 250 *39,550	*18 250 *39,550	*16 350 *35,450	*16 350 *35,450	*15 000 *32,650	13 300 28,500			*12 400 *27,300	11 100 24,700	13 210 43'2"
6000 mm 20'0"	kg lb			*29 950 *64,150	*29 950 *64,150	*23 400 *50,400	*23 400 *50,400	*19 600 *42,400	*19 600 *42,400	*17 150 *37,150	16 000 34,450	*15 450 *33,500	12 900 27,700	*14 100 31,000	10 500 22,000	*12 600 *27,750	10 250 22,700	13 660 44'8"
4500 mm 15'0"	kg lb					*25 650 *55,250	24 750 53,550	*20 950 *45,300	19 150 41,400	*18 000 *38,950	15 300 33,000	*15 900 *34,550	12 450 26,800	*14 400 *31,300	10 250 22,000	*13 000 *28,550	9700 21,400	13 940 45'8"
3000 mm 10'0"	kg lb					*27 350 *59,050	23 250 50,200	*22 100 *47,850	18 200 39,250	*18 750 *40,550	14 650 31,550	*16 350 *35,450	12 000 25,850	*14 600 *31,650	10 000 21,450	*13 600 *29,850	9350 20,650	14 040 46'0"
1500 mm 5'0"	kg lb					*28 150 *60,900	22 200 47,950	*22 850 *49,450	17 400 37,550	*19 250 *41,650	14 100 30,350	*16 650 *36,050	11 650 25,050	*14 650 *31,600	9750 21,000	13 950 30,700	9250 20,350	13 980 45'10"
0 mm 0'0"	kg lb			*14 750 *35,000	*14 750 *35,000	*28 050 *60,850	21 650 46,700	*23 050 *49,900	16 900 36,400	*19 400 *42,000	13 700 29,500	*16 700 *36,100	11 350 24,450	*14 450 *31,100	9600 20,650	*14 050 *30,950	9350 20,550	13 760 45'1"
-1500 mm -5'0"	kg lb			*22 350 *51,700	*22 350 *51,700	*27 250 *59,100	21 450 46,150	*22 650 *49,050	16 600 35,800	*19 150 *41,400	13 450 28,950	*16 350 *35,250	11 200 24,100			*14 000 *30,900	9650 21,300	13 370 43'9"
-3000 mm -10'0"	kg lb	*20 000 *45,600	*20 000 *45,600	*30 450 *66,200	30 250 65,000	*25 750 *55,800	21 450 46,200	*21 650 *46,850	16 550 35,600	*18 300 *39,500	13 350 28,800	*15 450 *33,100	11 150 24,100			*13 900 *30,600	10 300 22,750	12 780 41'10"
-4500 mm -15'0"	kg lb	*29 800 *67,350	*29 800 *67,350	*27 450 *59,550	*27 450 *59,550	*23 500 *50,850	21 700 46,700	*19 900 *42,950	16 650 35,900	*16 750 *35,950	13 450 29,050					*13 600 *29,950	11 400 25,200	11 970 39'1"
-6000 mm -20'0"	kg lb	*26 000 *56,250	*26 000 *56,250	*23 400 *50,500	*23 400 *50,500	*20 300 *43,600	*20 300 *43,600	*17 200 *36,700	17 000 36,700	*13 950 *29,250	13 800 29,250					*12 950 *28,350	*12 950 *28,350	10 900 35'5"
-7500 mm -25'0"	kg lb			*17 850 *37,850	*17 850 *37,850	*15 600 *32,800	*15 600 *32,800	*12 600 *25,850	*12 600 *25,850							*11 450 *24,800	*11 450 *24,800	9460 30'7"



ISO 10567:2007



*Indicates that the load is limited by hydraulic lifting capacity rather than tipping load. The above loads are in compliance with hydraulic excavator lift capacity standard ISO 10567:2007. They do not exceed 87% of hydraulic lifting capacity or 75% of tipping load. Weight of all lifting accessories must be deducted from the above lifting capacities. Lifting capacities are based on the machine standing on a firm, uniform supporting surface. The use of a work tool attachment point to handle/lift objects, could affect the machine lift performance.

**Lift capacities apply to both standard counterweight and counterweight with removal device.

Lift capacity stays with ±5% for all available track shoes.

Always refer to the appropriate Operation and Maintenance Manual for specific product information.

395 Hydraulic Excavator Specifications

Reach Boom Lift Capacities – Standard Counterweight** – without Bucket

Long Variable Gauge Undercarriage

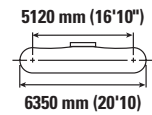
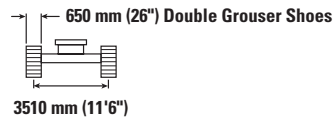
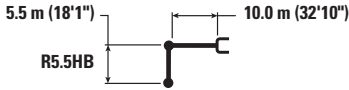

Reach Boom Length	Unit	3000 mm/10'0"		4500 mm/15'0"		6000 mm/20'0"		7500 mm/25'0"		9000 mm/30'0"		mm ft/in		
		kg lb	kg lb	kg lb	kg lb	kg lb	kg lb	kg lb	kg lb	kg lb	kg lb	mm ft/in		
12 000 mm 40'0"	kg lb											*9700 *21,550	*9700 *21,550	11 830 38'3"
10 500 mm 35'0"	kg lb											*9400 *20,700	*9400 *20,700	12 880 41'10"
9000 mm 30'0"	kg lb											*9250 *20,350	*9250 *20,350	13 680 44'7"
7500 mm 25'0"	kg lb											*9250 *20,300	*9250 *20,300	14 280 46'8"
6000 mm 20'0"	kg lb							*21 100 *45,500	*21 100 *45,500	*17 950 *38,850	*17 950 *38,850	*9350 *20,550	8800 19,400	14 690 48'1"
4500 mm 15'0"	kg lb					*30 500 *65,500	*30 500 *65,500	*23 550 *50,750	*23 550 *50,750	*19 450 *42,050	19 250 41,500	*9600 *21,150	8300 18,300	14 950 49'0"
3000 mm 10'0"	kg lb					*22 150 *54,650	*22 150 *54,650	*25 650 *55,350	23 400 50,550	*20 850 *45,050	18 100 39,050	*10 000 *22,000	8000 17,650	15 050 49'4"
1500 mm 5'0"	kg lb					*17 350 *41,200	*17 350 *41,200	*27 050 *58,500	22 000 47,500	*21 900 *47,350	17 150 36,950	*10 550 *23,250	7900 17,350	14 990 49'2"
0 mm 0'0"	kg lb					*18 750 *43,700	*18 750 *43,700	*27 650 *59,850	21 150 45,550	*22 450 *48,600	16 450 35,400	*11 350 *24,950	7950 17,450	14 790 48'5"
-1500 mm -5'0"	kg lb			*12 550 *28,600	*12 550 *28,600	*22 900 *52,750	*22 900 *52,750	*27 450 *59,450	20 650 44,450	*22 500 *48,700	15 950 34,400	*12 400 *27,350	8150 17,950	14 420 47'3"
-3000 mm -10'0"	kg lb	*13 600 *30,550	*13 600 *30,550	*18 550 *42,100	*18 550 *42,100	*28 900 *66,250	28 700 61,700	*26 550 *57,500	20 450 44,000	*21 950 *47,550	15 750 33,900	*12 650 *27,900	8600 18,950	13 880 45'5"
-4500 mm -15'0"	kg lb	*19 750 *44,500	*19 750 *44,500	*25 400 *57,550	*25 400 *57,550	*30 100 *65,250	28 950 62,250	*24 900 *53,850	20 500 44,150	*20 800 *44,900	15 700 33,850	*12 550 *27,650	9350 20,650	13 140 42'11"
-6000 mm -20'0"	kg lb	*26 650 *60,100	*26 650 *60,100	*32 000 *69,100	*32 000 *69,100	*26 750 *57,750	*26 750 *57,750	*22 450 *48,350	20 800 44,750	*18 850 *40,450	15 900 34,300	*12 250 *26,950	10 550 23,500	12 170 39'8"
-7500 mm -25'0"	kg lb			*25 850 *55,300	*25 850 *55,300	*22 200 *47,500	*22 200 *47,500	*18 850 *40,200	*18 850 *40,200	*15 750 *33,300	*15 750 *33,300	*11 550 *25,250	*11 550 *25,250	10 910 35'4"
-9000 mm -30'0"	kg lb					*15 850	*15 850	*13 450	*13 450	*10 450	*10 450	*9850	*9850	9230 29'7"



ISO 10567:2007



*Indicates that the load is limited by hydraulic lifting capacity rather than tipping load. The above loads are in compliance with hydraulic excavator lift capacity standard ISO 10567:2007. They do not exceed 87% of hydraulic lifting capacity or 75% of tipping load. Weight of all lifting accessories must be deducted from the above lifting capacities. Lifting capacities are based on the machine standing on a firm, uniform supporting surface. The use of a work tool attachment point to handle/lift objects, could affect the machine lift performance.

**Lift capacities apply to both standard counterweight and counterweight with removal device.

Lift capacity stays with ±5% for all available track shoes.

Always refer to the appropriate Operation and Maintenance Manual for specific product information.

(continued on next page)

395 Hydraulic Excavator Specifications

Reach Boom Lift Capacities – Standard Counterweight^{**} – without Bucket (continued)

Long Variable Gauge Undercarriage

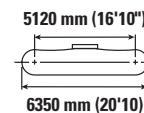
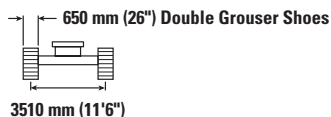

Reach Boom Length mm ft/in	Unit	10 500 mm/35'0"		12 000 mm/40'0"		13 500 mm/45'0"		15 000 mm/50'0"		mm ft/in		
12 000 mm 40'0"	kg lb									*9700 *21,550	*9700 *21,550	11 830 38'3"
10 500 mm 35'0"	kg lb			*12 250 *25,400	*12 250 *25,400					*9400 *20,700	*9400 *20,700	12 880 41'10"
9000 mm 30'0"	kg lb	*14 200 *30,950	*14 200 *30,950	*13 350 *29,150	*13 350 *29,100	*10 150	*10 150			*9250 *20,350	*9250 *20,350	13 680 44'7"
7500 mm 25'0"	kg lb	*14 950 *32,400	*14 950 *32,400	*13 750 *29,950	13 250 28,400	*12 600 *25,750	10 650 22,700			*9250 *20,300	*9250 *20,300	14 280 46'8"
6000 mm 20'0"	kg lb	*15 850 *34,300	*15 850 *34,300	*14 300 *31,050	12 800 27,450	*13 200 *28,700	10 350 22,200			*9350 *20,550	8800 19,400	14 690 48'1"
4500 mm 15'0"	kg lb	*16 800 *36,350	15 200 32,750	*14 900 *32,350	12 300 26,400	*13 550 *29,400	10 050 21,550			*9600 *21,150	8300 18,300	14 950 49'0"
3000 mm 10'0"	kg lb	*17 700 *38,300	14 450 31,100	*15 500 *33,600	11 750 25,300	*13 850 *30,100	9700 20,850	*10 350	8050	*10 000 *22,000	8000 17,650	15 050 49'4"
1500 mm 5'0"	kg lb	*18 450 *39,900	13 800 29,650	*15 950 *34,600	11 300 24,300	*14 100 *30,550	9400 20,150			*10 550 *23,250	7900 17,350	14 990 49'2"
0 mm 0'0"	kg lb	*18 850 *40,800	13 250 28,500	*16 250 *35,150	10 900 23,500	13 950 30,050	9150 19,650			*11 350 *24,950	7950 17,450	14 790 48'5"
-1500 mm -5'0"	kg lb	*18 900 *40,900	12 900 27,700	*16 200 *35,000	10 650 22,900	13 800 29,700	8950 19,300			*12 400 *27,350	8150 17,950	14 420 47'3"
-3000 mm -10'0"	kg lb	*18 500 *39,950	12 700 27,300	*15 750 *33,950	10 500 22,600	*13 300 *28,450	8900 19,200			*12 650 *27,900	8600 18,950	13 880 45'5"
-4500 mm -15'0"	kg lb	*17 500 *37,700	12 650 27,250	*14 700 *31,500	10 500 22,700					*12 550 *27,650	9350 20,650	13 140 42'11"
-6000 mm -20'0"	kg lb	*15 750 *33,600	12 800 27,650	*12 650	10 750					*12 250 *26,950	10 550 23,500	12 170 39'8"
-7500 mm -25'0"	kg lb	*12 550 *25,950	*12 550 *25,950							*11 550 *25,250	*11 550 *25,250	10 910 35'4"
-9000 mm -30'0"	kg lb									*9850 *21,150	*9850 *21,150	9230 29'7"



ISO 10567:2007



*Indicates that the load is limited by hydraulic lifting capacity rather than tipping load. The above loads are in compliance with hydraulic excavator lift capacity standard ISO 10567:2007. They do not exceed 87% of hydraulic lifting capacity or 75% of tipping load. Weight of all lifting accessories must be deducted from the above lifting capacities. Lifting capacities are based on the machine standing on a firm, uniform supporting surface. The use of a work tool attachment point to handle/lift objects, could affect the machine lift performance.

**Lift capacities apply to both standard counterweight and counterweight with removal device.

Lift capacity stays with ±5% for all available track shoes.

Always refer to the appropriate Operation and Maintenance Manual for specific product information.

395 Hydraulic Excavator Specifications

Reach Boom Lift Capacities – Standard Counterweight** – without Bucket

Long Variable Gauge Undercarriage

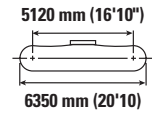
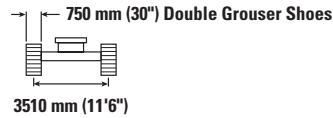
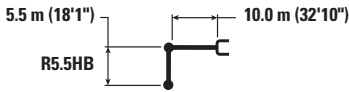

Reach Boom Length	Unit	3000 mm/10'0"		4500 mm/15'0"		6000 mm/20'0"		7500 mm/25'0"		9000 mm/30'0"		mm ft/in		
		kg	lb	kg	lb	kg	lb	kg	lb	kg	lb	kg	lb	mm
12 000 mm 40'0"	kg lb											*9700 *21,550	*9700 *21,550	11 830 38'3"
10 500 mm 35'0"	kg lb											*9400 *20,700	*9400 *20,700	12 880 41'10"
9000 mm 30'0"	kg lb											*9250 *20,350	*9250 *20,350	13 680 44'7"
7500 mm 25'0"	kg lb											*9250 *20,300	*9250 *20,300	14 280 46'8"
6000 mm 20'0"	kg lb							*21 100 *45,500	*21 100 *45,500	*17 950 *38,850	*17 950 *38,850	*9350 *20,550	8900 19,650	14 690 48'1"
4500 mm 15'0"	kg lb					*30 500 *65,500	*30 500 *65,500	*23 550 *50,750	*23 550 *50,750	*19 450 *42,050	19 400 41,900	*9600 *21,150	8400 18,550	14 950 49'0"
3000 mm 10'0"	kg lb					*22 150 *54,650	*22 150 *54,650	*25 650 *55,350	23 600 51,000	*20 850 *45,050	18 300 39,450	*10 000 *22,000	8100 17,850	15 050 49'4"
1500 mm 5'0"	kg lb					*17 350 *41,200	*17 350 *41,200	*27 050 *58,500	22 250 48,000	*21 900 *47,350	17 300 37,350	*10 550 *23,250	8000 17,550	14 990 49'2"
0 mm 0'0"	kg lb					*18 750 *43,700	*18 750 *43,700	*27 650 *59,850	21 350 46,000	*22 450 *48,600	16 600 35,800	*11 350 *24,950	8000 17,650	14 790 48'5"
-1500 mm -5'0"	kg lb			*12 550 *28,600	*12 550 *28,600	*22 900 *52,750	*22 900 *52,750	*27 450 *59,450	20 850 44,900	*22 500 *48,700	16 150 34,800	*12 400 *27,350	8250 18,150	14 420 47'3"
-3000 mm -10'0"	kg lb	*13 600 *30,550	*13 600 *30,550	*18 550 *42,100	*18 550 *42,100	*28 900 *66,250	*28 900 *62,350	*26 550 *57,500	20 650 44,500	*21 950 *47,550	15 900 34,300	*12 650 *27,900	8700 19,200	13 880 45'5"
-4500 mm -15'0"	kg lb	*19 750 *44,500	*19 750 *44,500	*25 400 *57,550	*25 400 *57,550	*30 100 *65,250	29 250 62,900	*24 900 *53,850	20 750 44,600	*20 800 *44,900	15 900 34,250	*12 550 *27,650	9450 20,900	13 140 42'11"
-6000 mm -20'0"	kg lb	*26 650 *60,100	*26 650 *60,100	*32 000 *69,100	*32 000 *69,100	*26 750 *57,750	*26 750 *57,750	*22 450 *48,350	21 000 45,250	*18 850 *40,450	16 100 34,650	*12 250 *26,950	10 700 23,750	12 170 39'8"
-7500 mm -25'0"	kg lb			*25 850 *55,300	*25 850 *55,300	*22 200 *47,500	*22 200 *47,500	*18 850 *40,200	*18 850 *40,200	*15 750 *33,300	*15 750 *33,300	*11 550 *25,250	*11 550 *25,250	10 910 35'4"
-9000 mm -30'0"	kg lb					*15 850	*15 850	*13 450	*13 450	*10 450	*10 450	*9850	*9850	9230
								*27,700	*27,700			*21,150	*21,150	29'7"



ISO 10567:2007



*Indicates that the load is limited by hydraulic lifting capacity rather than tipping load. The above loads are in compliance with hydraulic excavator lift capacity standard ISO 10567:2007. They do not exceed 87% of hydraulic lifting capacity or 75% of tipping load. Weight of all lifting accessories must be deducted from the above lifting capacities. Lifting capacities are based on the machine standing on a firm, uniform supporting surface. The use of a work tool attachment point to handle/lift objects, could affect the machine lift performance.

**Lift capacities apply to both standard counterweight and counterweight with removal device.

Lift capacity stays with ±5% for all available track shoes.

Always refer to the appropriate Operation and Maintenance Manual for specific product information.









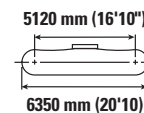
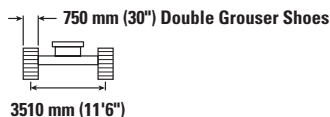
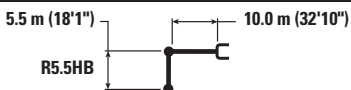

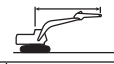
(continued on next page)

395 Hydraulic Excavator Specifications

Reach Boom Lift Capacities – Standard Counterweight** – without Bucket (continued)

Long Variable Gauge Undercarriage



		10 500 mm/35'0"		12 000 mm/40'0"		13 500 mm/45'0"		15 000 mm/50'0"				mm ft/in
												
12 000 mm 40'0"	kg lb									*9700 *21,550	*9700 *21,550	11 830 38'3"
10 500 mm 35'0"	kg lb			*12 250 *25,400	*12 250 *25,400					*9400 *20,700	*9400 *20,700	12 880 41'10"
9000 mm 30'0"	kg lb	*14 200 *30,950	*14 200 *30,950	*13 350 *29,150	*13 350 *29,150	*10 150	*10 150			*9250 *20,350	*9250 *20,350	13 680 44'7"
7500 mm 25'0"	kg lb	*14 950 *32,400	*14 950 *32,400	*13 750 *29,950	13 350 28,650	*12 600 *25,750	10 750 22,950			*9250 *20,300	*9250 *20,300	14 280 46'8"
6000 mm 20'0"	kg lb	*15 850 *34,300	*15 850 *34,300	*14 300 *31,050	12 900 27,750	*13 200 *28,700	10 500 22,450			*9350 *20,550	8900 19,650	14 690 48'1"
4500 mm 15'0"	kg lb	*16 800 *36,350	15 350 33,050	*14 900 *32,350	12 400 26,650	*13 550 *29,400	10 150 21,750			*9600 *21,150	8400 18,550	14 950 49'0"
3000 mm 10'0"	kg lb	*17 700 *38,300	14 600 31,450	*15 500 *33,600	11 900 25,550	*13 850 *30,100	9800 21,050	*10 350	8150	*10 000 *22,000	8100 17,850	15 050 49'4"
1500 mm 5'0"	kg lb	*18 450 *39,900	13 900 30,000	*15 950 *34,600	11 400 24,550	*14 100 *30,550	9500 20,400			*10 550 *23,250	8000 17,550	14 990 49'2"
0 mm 0'0"	kg lb	*18 850 *40,800	13 400 28,850	*16 250 *35,150	11 050 23,750	14 150 30,400	9250 19,850			*11 350 *24,950	8000 17,650	14 790 48'5"
-1500 mm -5'0"	kg lb	*18 900 *40,900	13 000 28,050	*16 200 *35,000	10 750 23,150	13 950 30,000	9050 19,500			*12 400 *27,350	8250 18,150	14 420 47'3"
-3000 mm -10'0"	kg lb	*18 500 *39,950	12 800 27,600	*15 750 *33,950	10 650 22,900	*13 300 *28,450	9000 19,450			*12 650 *27,900	8700 19,200	13 880 45'5"
-4500 mm -15'0"	kg lb	*17 500 *37,700	12 800 27,550	*14 700 *31,500	10 650 22,950					*12 550 *27,650	9450 20,900	13 140 42'11"
-6000 mm -20'0"	kg lb	*15 750 *33,600	12 950 27,950	*12 650	10 850					*12 250 *26,950	10 700 23,750	12 170 39'8"
-7500 mm -25'0"	kg lb	*12 550 *25,950	*12 550 *25,950							*11 550 *25,250	*11 550 *25,250	10 910 35'4"
-9000 mm -30'0"	kg lb									*9850 *21,150	*9850 *21,150	9230 29'7"



ISO 10567:2007



*Indicates that the load is limited by hydraulic lifting capacity rather than tipping load. The above loads are in compliance with hydraulic excavator lift capacity standard ISO 10567:2007. They do not exceed 87% of hydraulic lifting capacity or 75% of tipping load. Weight of all lifting accessories must be deducted from the above lifting capacities. Lifting capacities are based on the machine standing on a firm, uniform supporting surface. The use of a work tool attachment point to handle/lift objects, could affect the machine lift performance.

**Lift capacities apply to both standard counterweight and counterweight with removal device.

Lift capacity stays with ±5% for all available track shoes.

Always refer to the appropriate Operation and Maintenance Manual for specific product information.

395 Hydraulic Excavator Specifications

Reach Boom Lift Capacities – Standard Counterweight** – without Bucket

Long Variable Gauge Undercarriage

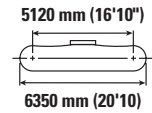
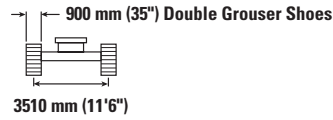
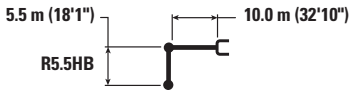

Reach Boom Length	Unit	3000 mm/10'0"		4500 mm/15'0"		6000 mm/20'0"		7500 mm/25'0"		9000 mm/30'0"		mm ft/in		
		kg	lb	kg	lb	kg	lb	kg	lb	kg	lb	kg	lb	
12 000 mm 40'0"	kg lb											*9700 *21,550	*9700 *21,550	11 830 38'10"
10 500 mm 35'0"	kg lb											*9400 *20,700	*9400 *20,700	12 880 41'10"
9000 mm 30'0"	kg lb											*9250 *20,350	*9250 *20,350	13 680 44'7"
7500 mm 25'0"	kg lb											*9250 *20,300	*9250 *20,300	14 280 46'8"
6000 mm 20'0"	kg lb							*21 100 *45,500	*21 100 *45,500	*17 950 *38,850	*17 950 *38,850	*9350 *20,550	9000 19,900	14 690 48'1"
4500 mm 15'0"	kg lb					*30 500 *65,500	*30 500 *65,500	*23 550 *50,750	*23 550 *50,750	*19 450 *42,050	*19 450 *42,050	*9600 *21,150	8500 18,800	14 950 49'0"
3000 mm 10'0"	kg lb					*22 150 *54,650	*22 150 *54,650	*25 650 *55,350	23 900 51,600	*20 850 *45,050	18 500 39,900	*10 000 *22,000	8200 18,100	15 050 49'4"
1500 mm 5'0"	kg lb					*17 350 *41,200	*17 350 *41,200	*27 050 *58,500	22 500 48,600	*21 900 *47,350	17 550 37,800	*10 550 *23,250	8100 17,850	14 990 49'2"
0 mm 0'0"	kg lb					*18 750 *43,700	*18 750 *43,700	*27 650 *59,850	21 600 46,600	*22 450 *48,600	16 800 36,250	*11 350 *24,950	8150 17,900	14 790 48'5"
-1500 mm -5'0"	kg lb			*12 550 *28,600	*12 550 *28,600	*22 900 *52,750	*22 900 *52,750	*27 450 *59,450	21 150 45,500	*22 500 *48,700	16 350 35,250	*12 400 *27,350	8350 18,450	14 420 47'3"
-3000 mm -10'0"	kg lb	*13 600 *30,550	*13 600 *30,550	*18 550 *42,100	*18 550 *42,100	*28 900 *66,250	*28 900 *63,150	*26 550 *57,500	20 950 45,100	*21 950 *47,550	16 150 34,750	*12 650 *27,900	8800 19,450	13 880 45'5"
-4500 mm -15'0"	kg lb	*19 750 *44,500	*19 750 *44,500	*25 400 *57,550	*25 400 *57,550	*30 100 *65,250	29 650 63,700	*24 900 *53,850	21 000 45,200	*20 800 *44,900	16 100 34,700	*12 550 *27,650	9600 21,200	13 140 42'11"
-6000 mm -20'0"	kg lb	*26 650 *60,100	*26 650 *60,100	*32 000 *69,100	*32 000 *69,100	*26 750 *57,750	*26 750 *57,750	*22 450 *48,350	21 300 45,850	*18 850 *40,450	16 300 35,150	*12 250 *26,950	10 850 24,100	12 170 39'8"
-7500 mm -25'0"	kg lb			*25 850 *55,300	*25 850 *55,300	*22 200 *47,500	*22 200 *47,500	*18 850 *40,200	*18 850 *40,200	*15 750 *33,300	*15 750 *33,300	*11 550 *25,250	*11 550 *25,250	10 910 35'4"
-9000 mm -30'0"	kg lb					*15 850	*15 850	*13 450	*13 450	*10 450	*10 450	*9850 *21,150	*9850 *21,150	9230 29'7"



ISO 10567:2007



*Indicates that the load is limited by hydraulic lifting capacity rather than tipping load. The above loads are in compliance with hydraulic excavator lift capacity standard ISO 10567:2007. They do not exceed 87% of hydraulic lifting capacity or 75% of tipping load. Weight of all lifting accessories must be deducted from the above lifting capacities. Lifting capacities are based on the machine standing on a firm, uniform supporting surface. The use of a work tool attachment point to handle/lift objects, could affect the machine lift performance.

**Lift capacities apply to both standard counterweight and counterweight with removal device.

Lift capacity stays with ±5% for all available track shoes.

Always refer to the appropriate Operation and Maintenance Manual for specific product information.









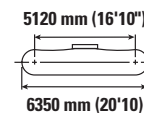
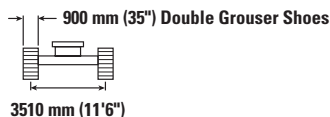

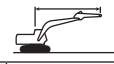
(continued on next page)

395 Hydraulic Excavator Specifications

Reach Boom Lift Capacities – Standard Counterweight^{**} – without Bucket (continued)

Long Variable Gauge Undercarriage



		10 500 mm/35'0"		12 000 mm/40'0"		13 500 mm/45'0"		15 000 mm/50'0"				mm ft/in
												
12 000 mm 40'0"	kg lb									*9700 *21,550	*9700 *21,550	11 830 38'10"
10 500 mm 35'0"	kg lb			*12 250 *25,400	*12 250 *25,400					*9400 *20,700	*9400 *20,700	12 880 41'10"
9000 mm 30'0"	kg lb	*14 200 *30,950	*14 200 *30,950	*13 350 *29,150	*13 350 *29,150	*10 150	*10 150			*9250 *20,350	*9250 *20,350	13 680 44'7"
7500 mm 25'0"	kg lb	*14 950 *32,400	*14 950 *32,400	*13 750 *29,950	13 500 29,000	*12 600 *25,750	10 850 23,200			*9250 *20,300	*9250 *20,300	14 280 46'8"
6000 mm 20'0"	kg lb	*15 850 *34,300	*15 850 *34,300	*14 300 *31,050	13 050 28,050	*13 200 *28,700	10 600 22,700			*9350 *20,550	9000 19,900	14 690 48'1"
4500 mm 15'0"	kg lb	*16 800 *36,350	15 500 33,450	*14 900 *32,350	12 550 27,000	*13 550 *29,400	10 300 22,050			*9600 *21,150	8500 18,800	14 950 49'0"
3000 mm 10'0"	kg lb	*17 700 *38,300	14 750 31,800	*15 500 *33,600	12 050 25,900	*13 850 *30,100	9950 21,350	*10 350	8250	*10 000 *22,000	8200 18,100	15 050 49'4"
1500 mm 5'0"	kg lb	*18 450 *39,900	14 100 30,350	*15 950 *34,600	11 550 24,900	*14 100 *30,550	9650 20,700			*10 550 *23,250	8100 17,850	14 990 49'2"
0 mm 0'0"	kg lb	*18 850 *40,800	13 550 29,200	*16 250 *35,150	11 200 24,050	*14 200 *30,650	9400 20,150			*11 350 *24,950	8150 17,900	14 790 48'5"
-1500 mm -5'0"	kg lb	*18 900 *40,900	13 200 28,400	*16 200 *35,000	10 900 23,500	*14 000 *30,100	9200 19,800			*12 400 *27,350	8350 18,450	14 420 47'3"
-3000 mm -10'0"	kg lb	*18 500 *39,950	13 000 28,000	*15 750 *33,950	10 800 23,200	*13 300 *28,450	9150 19,700			*12 650 *27,900	8800 19,450	13 880 45'5"
-4500 mm -15'0"	kg lb	*17 500 *37,700	12 950 27,950	*14 700 *31,500	10 800 23,250					*12 550 *27,650	9600 21,200	13 140 42'11"
-6000 mm -20'0"	kg lb	*15 750 *33,600	13 150 28,350	*12 650	11 000					*12 250 *26,950	10 850 24,100	12 170 39'8"
-7500 mm -25'0"	kg lb	*12 550 *25,950	*12 550 *25,950							*11 550 *25,250	*11 550 *25,250	10 910 35'4"
-9000 mm -30'0"	kg lb									*9850 *21,150	*9850 *21,150	9230 29'7"



ISO 10567:2007



*Indicates that the load is limited by hydraulic lifting capacity rather than tipping load. The above loads are in compliance with hydraulic excavator lift capacity standard ISO 10567:2007. They do not exceed 87% of hydraulic lifting capacity or 75% of tipping load. Weight of all lifting accessories must be deducted from the above lifting capacities. Lifting capacities are based on the machine standing on a firm, uniform supporting surface. The use of a work tool attachment point to handle/lift objects, could affect the machine lift performance.

**Lift capacities apply to both standard counterweight and counterweight with removal device.

Lift capacity stays with ±5% for all available track shoes.

Always refer to the appropriate Operation and Maintenance Manual for specific product information.

395 Hydraulic Excavator Specifications

GP Boom Lift Capacities – Standard Counterweight** – without Bucket

Long Variable Gauge Undercarriage

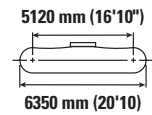
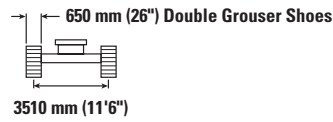
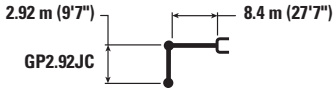

Boom Length	Unit	4500 mm/15'0"		6000 mm/20'0"		7500 mm/25'0"		9000 mm/30'0"		10 500 mm/35'0"		mm ft/in		
		kg lb	kg lb	kg lb	kg lb	kg lb	kg lb	kg lb	kg lb	kg lb	kg lb	kg lb	mm ft/in	
10 500 mm 35'0"	kg lb					*22 400 *49,500	*22 400 *49,500					*18 900 *42,150	*18 900 *42,150	8130 26'1"
9000 mm 30'0"	kg lb					*22 450 *48,950	*22 450 *48,950	*20 900 *43,550	*20 900 *43,550			*17 650 *39,100	*17 650 *39,100	9360 30'4"
7500 mm 25'0"	kg lb					*23 700 *51,350	*23 700 *51,350	*21 150 *46,100	20 650 44,350			*17 150 *37,800	16 600 36,900	10 220 33'3"
6000 mm 20'0"	kg lb			*31 900 *68,550	*31 900 *68,550	*25 650 *55,400	*25 650 *55,400	*22 050 *47,900	20 000 43,050	*19 900 *42,750	15 600 33,450	*17 050 *37,600	14 850 32,900	10 800 35'3"
4500 mm 15'0"	kg lb					*27 700 *59,900	25 150 54,250	*23 150 *50,200	19 250 41,500	*20 300 *44,100	15 250 32,750	*17 400 *38,250	13 850 30,550	11 140 36'6"
3000 mm 10'0"	kg lb					*29 350 *63,450	24 000 51,800	*24 100 *52,200	18 550 40,050	*20 650 *44,850	14 850 31,950	*18 050 *39,750	13 350 29,400	11 280 36'11"
1500 mm 5'0"	kg lb					*30 000 *64,950	23 250 50,100	*24 550 *53,200	18 050 38,850	*20 750 *44,900	14 500 31,300	*19 150 *42,250	13 250 29,200	11 200 36'9"
0 mm 0'0"	kg lb			*34 250 *79,150	31 800 68,400	*29 600 *64,100	22 850 49,250	*24 300 *52,600	17 700 38,200	*20 200 *43,500	14 350 30,950	*19 000 *41,900	13 600 30,000	10 920 35'9"
-1500 mm -5'0"	kg lb			*33 850 *73,650	31 900 68,600	*28 050 *60,800	22 750 49,050	*23 100 *49,900	17 650 38,000			*18 700 *41,150	14 550 32,100	10 420 34'1"
-3000 mm -10'0"	kg lb	*33 700 *73,750	*33 700 *73,750	*30 100 *65,350	*30 100 *65,350	*25 250 *54,500	22 950 49,500	*20 400 *43,600	17 850 38,500			*17 950 *39,450	16 350 36,200	9650 31'6"
-4500 mm -15'0"	kg lb	*27 350 *59,200	*27 350 *59,200	*24 550 *52,850	*24 550 *52,850	*20 350 *43,250	*20 350 *43,250					*16 300 *35,650	*16 300 *35,650	8550 27'9"



ISO 10567:2007



*Indicates that the load is limited by hydraulic lifting capacity rather than tipping load. The above loads are in compliance with hydraulic excavator lift capacity standard ISO 10567:2007. They do not exceed 87% of hydraulic lifting capacity or 75% of tipping load. Weight of all lifting accessories must be deducted from the above lifting capacities. Lifting capacities are based on the machine standing on a firm, uniform supporting surface. The use of a work tool attachment point to handle/lift objects, could affect the machine lift performance.

**Lift capacities apply to both standard counterweight and counterweight with removal device.

Lift capacity stays with ±5% for all available track shoes.









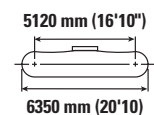
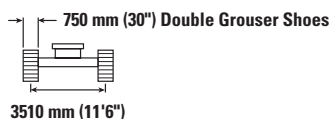
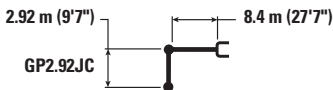



Always refer to the appropriate Operation and Maintenance Manual for specific product information.

395 Hydraulic Excavator Specifications

GP Boom Lift Capacities – Standard Counterweight** – without Bucket

Long Variable Gauge Undercarriage



		4500 mm/15'0"		6000 mm/20'0"		7500 mm/25'0"		9000 mm/30'0"		10 500 mm/35'0"				mm ft/in
														
10 500 mm 35'0"	kg lb					*22 400 *49,500	*22 400 *49,500					*18 900 *42,150	*18 900 *42,150	8130 26'1"
9000 mm 30'0"	kg lb					*22 450 *48,950	*22 450 *48,950	*20 900 *43,550	*20 900 *43,550			*17 650 *39,100	*17 650 *39,100	9360 30'4"
7500 mm 25'0"	kg lb					*23 700 *51,350	*23 700 *51,350	*21 150 *46,100	20 800 44,750			*17 150 *37,800	16 750 37,250	10 220 33'3"
6000 mm 20'0"	kg lb			*31 900 *68,550	*31 900 *68,550	*25 650 *55,400	*25 650 *55,400	*22 050 *47,900	20 150 43,450	*19 900 *42,750	15 750 33,750	*17 050 *37,600	15 000 33,200	10 800 35'3"
4500 mm 15'0"	kg lb					*27 700 *59,900	25 350 54,750	*23 150 *50,200	19 450 41,900	*20 300 *44,100	15 400 33,050	*17 400 *38,250	14 000 30,850	11 140 36'6"
3000 mm 10'0"	kg lb					*29 350 *63,450	24 200 52,250	*24 100 *52,200	18 750 40,400	*20 650 *44,850	15 000 32,250	*18 050 *39,750	13 450 29,650	11 280 36'11"
1500 mm 5'0"	kg lb					*30 000 *64,950	23 450 50,550	*24 550 *53,200	18 200 39,250	*20 750 *44,900	14 650 31,600	*19 150 *42,250	13 400 29,500	11 200 36'9"
0 mm 0'0"	kg lb			*34 250 *79,150	32 100 69,050	*29 600 *64,100	23 050 49,700	*24 300 *52,600	17 900 38,550	*20 200 *43,500	14 500 31,250	*19 000 *41,900	13 750 30,300	10 920 35'9"
-1500 mm -5'0"	kg lb			*33 850 *73,650	32 200 69,250	*28 050 *60,800	23 000 49,500	*23 100 *49,900	17 800 38,400			*18 700 *41,150	14 700 32,450	10 420 34'1"
-3000 mm -10'0"	kg lb	*33 700 *73,750	*33 700 *73,750	*30 100 *65,350	*30 100 *65,350	*25 250 *54,500	23 200 49,950	*20 400 *43,600	18 000 38,900			*17 950 *39,450	16 500 36,550	9650 31'6"
-4500 mm -15'0"	kg lb	*27 350 *59,200	*27 350 *59,200	*24 550 *52,850	*24 550 *52,850	*20 350 *43,250	*20 350 *43,250					*16 300 *35,650	*16 300 *35,650	8550 27'9"



ISO 10567:2007



*Indicates that the load is limited by hydraulic lifting capacity rather than tipping load. The above loads are in compliance with hydraulic excavator lift capacity standard ISO 10567:2007. They do not exceed 87% of hydraulic lifting capacity or 75% of tipping load. Weight of all lifting accessories must be deducted from the above lifting capacities. Lifting capacities are based on the machine standing on a firm, uniform supporting surface. The use of a work tool attachment point to handle/lift objects, could affect the machine lift performance.

**Lift capacities apply to both standard counterweight and counterweight with removal device.

Lift capacity stays with ±5% for all available track shoes.

Always refer to the appropriate Operation and Maintenance Manual for specific product information.

395 Hydraulic Excavator Specifications

GP Boom Lift Capacities – Standard Counterweight** – without Bucket

Long Variable Gauge Undercarriage

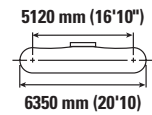
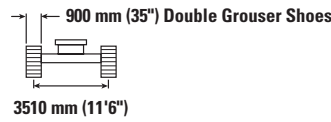
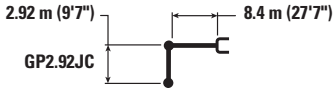

Boom Length	Unit	4500 mm/15'0"		6000 mm/20'0"		7500 mm/25'0"		9000 mm/30'0"		10 500 mm/35'0"		mm ft/in		
		kg	lb	kg	lb	kg	lb	kg	lb	kg	lb	mm	ft/in	
10 500 mm 35'0"	kg lb					*22 400 *49,500	*22 400 *49,500					*18 900 *42,150	*18 900 *42,150	8130 26'1"
9000 mm 30'0"	kg lb					*22 450 *48,950	*22 450 *48,950	*20 900 *43,550	*20 900 *43,550			*17 650 *39,100	*17 650 *39,100	9360 30'4"
7500 mm 25'0"	kg lb					*23 700 *51,350	*23 700 *51,350	*21 150 *46,100	21 000 45,200			*17 150 *37,800	16 900 37,650	10 220 33'3"
6000 mm 20'0"	kg lb			*31 900 *68,550	*31 900 *68,550	*25 650 *55,400	*25 650 *55,400	*22 050 *47,900	20 400 43,900	*19 900 *42,750	15 900 34,150	*17 050 *37,600	15 150 33,600	10 800 35'3"
4500 mm 15'0"	kg lb					*27 700 *59,900	25 600 55,300	*23 150 *50,200	19 650 42,350	*20 300 *44,100	15 550 33,450	*17 400 *38,250	14 150 31,200	11 140 36'6"
3000 mm 10'0"	kg lb					*29 350 *63,450	24 500 52,850	*24 100 *52,200	18 950 40,850	*20 650 *44,850	15 150 32,650	*18 050 *39,750	13 600 30,050	11 280 36'11"
1500 mm 5'0"	kg lb					*30 000 *64,950	23 750 51,150	*24 550 *53,200	18 400 39,700	*20 750 *44,900	14 850 32,000	*19 150 *42,250	13 550 29,850	11 200 36'9"
0 mm 0'0"	kg lb			*34 250 *79,150	32 500 69,850	*29 600 *64,100	23 350 50,300	*24 300 *52,600	18 100 39,000	*20 200 *43,500	14 650 31,650	*19 000 *41,900	13 950 30,700	10 920 35'9"
-1500 mm -5'0"	kg lb			*33 850 *73,650	32 600 70,050	*28 050 *60,800	23 250 50,100	*23 100 *49,900	18 000 38,850			*18 700 *41,150	14 900 32,800	10 420 34'1"
-3000 mm -10'0"	kg lb	*33 700 *73,750	*33 700 *73,750	*30 100 *65,350	*30 100 *65,350	*25 250 *54,500	23 450 50,550	*20 400 *43,600	18 200 39,350			*17 950 *39,450	16 700 36,950	9650 31'6"
-4500 mm -15'0"	kg lb	*27 350 *59,200	*27 350 *59,200	*24 550 *52,850	*24 550 *52,850	*20 350 *43,250	*20 350 *43,250					*16 300 *35,650	*16 300 *35,650	8550 27'9"



ISO 10567:2007



*Indicates that the load is limited by hydraulic lifting capacity rather than tipping load. The above loads are in compliance with hydraulic excavator lift capacity standard ISO 10567:2007. They do not exceed 87% of hydraulic lifting capacity or 75% of tipping load. Weight of all lifting accessories must be deducted from the above lifting capacities. Lifting capacities are based on the machine standing on a firm, uniform supporting surface. The use of a work tool attachment point to handle/lift objects, could affect the machine lift performance.

**Lift capacities apply to both standard counterweight and counterweight with removal device.

Lift capacity stays with ±5% for all available track shoes.









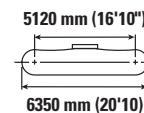
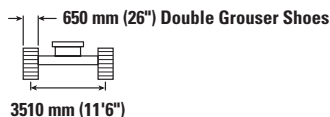
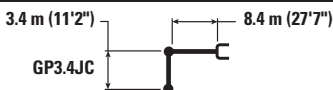

Always refer to the appropriate Operation and Maintenance Manual for specific product information.

395 Hydraulic Excavator Specifications

GP Boom Lift Capacities – Standard Counterweight** – without Bucket

Long Variable Gauge Undercarriage



		4500 mm/15'0"		6000 mm/20'0"		7500 mm/25'0"		9000 mm/30'0"		10 500 mm/35'0"				mm ft/in
														
10 500 mm 35'0"	kg lb											*15 600 *34,700	*15 600 *34,700	8740 28'1"
9000 mm 30'0"	kg lb							*19 750 *43,300	*19 750 *43,300			*14 650 *32,400	*14 650 *32,400	9 890 32'1"
7500 mm 25'0"	kg lb					*22 600 *48,950	*22 600 *48,950	*20 200 *44,050	*20 200 *44,050	*17 300	15 900	*14 200 *31,350	*14 200 *31,350	10 710 34'11"
6000 mm 20'0"	kg lb			*30 250 *65,050	*30 250 *65,050	*24 600 *53,150	*24 600 *53,150	*21 250 *46,100	20 100 43,250	*19 150 *41,700	15 650 33,600	*14 200 *31,200	13 850 30,650	11 260 36'10"
4500 mm 15'0"	kg lb			*34 500 *74,150	*34 500 *74,150	*26 800 *57,900	25 300 54,650	*22 450 *48,700	19 300 41,600	*19 700 *42,800	15 200 32,700	*14 400 *31,700	12 950 28,550	11 590 37'11"
3000 mm 10'0"	kg lb					*28 650 *61,950	24 100 52,000	*23 550 *51,000	18 550 40,000	*20 250 *43,900	14 800 31,800	*14 950 *32,850	12 450 27,450	11 720 38'5"
1500 mm 5'0"	kg lb			*71,800 158,850	68,850 151,850	*29 650 *64,150	23 200 50,050	*24 200 *52,450	17 950 38,700	*20 500 *44,400	14 400 31,000	*15 850 *34,850	12 400 27,250	11 650 38'2"
0 mm 0'0"	kg lb			*36 750 *80,500	31 600 67,900	*29 600 *64,100	22 700 48,950	*24 200 *52,450	17 550 37,850	*20 250 *43,750	14 150 30,500	*17 200 *37,900	12 700 27,900	11 380 37'3"
-1500 mm -5'0"	kg lb	*23 750 *54,700	*23 750 *54,700	*34 900 *75,850	31 550 67,850	*28 450 *61,600	22 550 48,550	*23 350 *50,450	17 400 37,500	*19 100 *40,900	14 100 30,450	*17 850 *39,300	13 450 29,700	10 900 35'8"
-3000 mm -10'0"	kg lb	*37 050 *80,750	*37 050 *80,750	*31 550 *68,450	*31 550 68,450	*26 050 *56,350	22 650 48,800	*21 250 *45,650	17 500 37,750			*17 300 *38,100	14 950 33,050	10 170 33'2"
-4500 mm -15'0"	kg lb	*30 750 *66,550	*30 750 *66,550	*26 550 *57,250	*26 550 *57,250	*21 950 *46,950	*21 950 *46,950	*16 700	*16 700			*16 150 *35,350	*16 150 *35,350	9130 29'8"
-6000 mm -20'0"	kg lb			*18 750 *39,300	*18 750 *39,300	*14 000	*14 000					*13 500 *31,400	*13 500 *31,400	7610 23'9"



ISO 10567:2007



*Indicates that the load is limited by hydraulic lifting capacity rather than tipping load. The above loads are in compliance with hydraulic excavator lift capacity standard ISO 10567:2007. They do not exceed 87% of hydraulic lifting capacity or 75% of tipping load. Weight of all lifting accessories must be deducted from the above lifting capacities. Lifting capacities are based on the machine standing on a firm, uniform supporting surface. The use of a work tool attachment point to handle/lift objects, could affect the machine lift performance.

**Lift capacities apply to both standard counterweight and counterweight with removal device.

Lift capacity stays with ±5% for all available track shoes.

Always refer to the appropriate Operation and Maintenance Manual for specific product information.

395 Hydraulic Excavator Specifications

GP Boom Lift Capacities – Standard Counterweight** – without Bucket

Long Variable Gauge Undercarriage

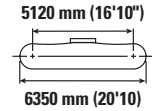
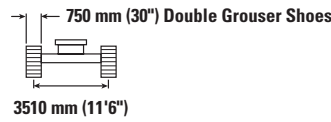
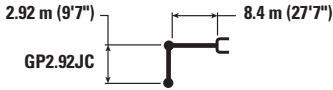

		4500 mm/15'0"		6000 mm/20'0"		7500 mm/25'0"		9000 mm/30'0"		10 500 mm/35'0"		mm ft/in		
10 500 mm 35'0"	kg lb											*15 600 *34,700	*15 600 *34,700	8740 28'1"
9000 mm 30'0"	kg lb							*19 750 *43,300	*19 750 *43,300			*14 650 *32,400	*14 650 *32,400	9890 32'1"
7500 mm 25'0"	kg lb					*22 600 *48,950	*22 600 *48,950	*20 200 *44,050	*20 200 *44,050	*17 300	16 050	*14 200 *31,350	*14 200 *31,350	10 710 34'11"
6000 mm 20'0"	kg lb			*30 250 *65,050	*30 250 *65,050	*24 600 *53,150	*24 600 *53,150	*21 250 *46,100	20 250 43,650	*19 150 *41,700	15 800 33,900	*14 150 *31,200	13 950 30,950	11 260 36'10"
4500 mm 15'0"	kg lb			*34 500 *74,150	*34 500 *74,150	*26 800 *57,900	25 550 55,150	*22 450 *48,700	19 500 42,000	*19 700 *42,800	15 350 33,050	*14 400 *31,700	13 050 28,850	11 590 37'11"
3000 mm 10'0"	kg lb					*28 650 *61,950	24 300 52,450	*23 550 *51,000	18 750 40,400	*20 250 *43,900	14 900 32,100	*14 950 *32,850	12 600 27,750	11 720 38'5"
1500 mm 5'0"	kg lb			*71,800 157,100	69,500 152,500	*29 650 *64,150	23 450 50,550	*24 200 *52,450	18 150 39,100	*20 500 *44,400	14 550 31,300	*15 850 *34,850	12 500 27,550	11 650 38'2"
0 mm 0'0"	kg lb			*36 750 *80,500	31 900 68,550	*29 600 *64,100	22 950 49,400	*24 200 *52,450	17 750 38,250	*20 250 *43,750	14 300 30,800	*17 200 *37,900	12 800 28,200	11 380 37'3"
-1500 mm -5'0"	kg lb	*23 750 *54,700	*23 750 *54,700	*34 900 *75,850	31 900 68,500	*28 450 *61,600	22 750 49,000	*23 350 *50,450	17 600 37,900	*19 100 *40,900	14 250 30,750	*17 850 *39,300	13 600 30,000	10 900 35'8"
-3000 mm -10'0"	kg lb	*37 050 *80,750	*37 050 *80,750	*31 550 *68,450	*31 550 *68,450	*26 050 *56,350	22 850 49,250	*21 250 *45,650	17 650 38,100			*17 300 *38,100	15 100 33,400	10 170 33'2"
-4500 mm -15'0"	kg lb	*30 750 *66,550	*30 750 *66,550	*26 550 *57,250	*26 550 *57,250	*21 950 *46,950	*21 950 *46,950	*16 700	*16 700			*16 150 *35,350	*16 150 *35,350	9130 29'8"
-6000 mm -20'0"	kg lb			*18 750 *39,300	*18 750 *39,300	*14 000	*14 000					*13 500 *31,400	*13 500 *31,400	7610 23'9"



ISO 10567:2007



*Indicates that the load is limited by hydraulic lifting capacity rather than tipping load. The above loads are in compliance with hydraulic excavator lift capacity standard ISO 10567:2007.

They do not exceed 87% of hydraulic lifting capacity or 75% of tipping load. Weight of all lifting accessories must be deducted from the above lifting capacities. Lifting capacities are based on the machine standing on a firm, uniform supporting surface. The use of a work tool attachment point to handle/lift objects, could affect the machine lift performance.

**Lift capacities apply to both standard counterweight and counterweight with removal device.

Lift capacity stays with ±5% for all available track shoes.

Always refer to the appropriate Operation and Maintenance Manual for specific product information.

395 Hydraulic Excavator Specifications

GP Boom Lift Capacities – Standard Counterweight** – without Bucket

Long Variable Gauge Undercarriage

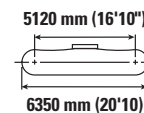
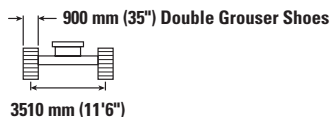

		4500 mm/15'0"		6000 mm/20'0"		7500 mm/25'0"		9000 mm/30'0"		10 500 mm/35'0"		mm ft/in		
		kg lb	kg lb	kg lb	kg lb	kg lb	kg lb	kg lb	kg lb	kg lb	kg lb	kg lb	kg lb	mm ft/in
10 500 mm 35'0"	kg lb											*15 600 *34,700	*15 600 *34,700	8740 28'1"
9000 mm 30'0"	kg lb							*19 750 *43,300	*19 750 *43,300			*14 650 *32,400	*14 650 *32,400	9890 32'1"
7500 mm 25'0"	kg lb					*22 600 *48,950	*22 600 *48,950	*20 200 *44,050	*20 200 *44,050	*17 300	16 250	*14 200 *31,350	*14 200 *31,350	10 710 34'11"
6000 mm 20'0"	kg lb			*30 250 *65,050	*30 250 *65,050	*24 600 *53,150	*24 600 *53,150	*21 250 *46,100	20 450 44,100	*19 150 *41,700	15 950 34,250	*14 150 *31,200	*14 150 *31,200	11 260 36'10"
4500 mm 15'0"	kg lb			*34 500 *74,150	*34 500 *74,150	*26 800 *57,900	25 800 55,700	*22 450 *48,700	19 700 42,450	*19 700 *42,800	15 550 33,400	*14 400 *31,700	13 200 29,200	11 590 37'11"
3000 mm 10'0"	kg lb					*28 650 *61,950	24 600 53,050	*23 550 *51,000	18 950 40,850	*20 250 *43,900	15 100 32,500	*14 950 *32,850	12 750 28,100	11 720 38'5"
1500 mm 5'0"	kg lb			*71,800 70,250		*29 650 *64,150	23 700 51,100	*24 200 *52,450	18 350 39,550	*20 500 *44,400	14 700 31,700	*15 850 *34,850	12 650 27,850	11 650 38'2"
0 mm 0'0"	kg lb			*36 750 *80,500	32 250 69,350	*29 600 *64,100	23 200 50,000	*24 200 *52,450	17 950 38,700	*20 250 *43,750	14 500 31,200	*17 200 *37,900	12 950 28,550	11 380 37'3"
-1500 mm -5'0"	kg lb	*23 750 *54,700	*23 750 *54,700	*34 900 *75,850	32 250 69,300	*28 450 *61,600	23 050 49,600	*23 350 *50,450	17 800 38,350	*19 100 *40,900	14 450 31,150	*17 850 *39,300	13 750 30,350	10 900 35'8"
-3000 mm -10'0"	kg lb	*37 050 *80,750	*37 050 *80,750	*31 550 *68,450	*31 550 *68,450	*26 050 *56,350	23 150 49,850	*21 250 *45,650	17 900 38,600			*17 300 *38,100	15 300 33,800	10 170 33'2"
-4500 mm -15'0"	kg lb	*30 750 *66,550	*30 750 *66,550	*26 550 *57,250	*26 550 *57,250	*21 950 *46,950	*21 950 *46,950	*16 700	*16 700			*16 150 *35,350	*16 150 *35,350	9130 29'8"
-6000 mm -20'0"	kg lb			*18 750 *39,300	*18 750 *39,300	*14 000	*14 000					*13 500 *31,400	*13 500 *31,400	7610 23'9"



ISO 10567:2007



*Indicates that the load is limited by hydraulic lifting capacity rather than tipping load. The above loads are in compliance with hydraulic excavator lift capacity standard ISO 10567:2007. They do not exceed 87% of hydraulic lifting capacity or 75% of tipping load. Weight of all lifting accessories must be deducted from the above lifting capacities. Lifting capacities are based on the machine standing on a firm, uniform supporting surface. The use of a work tool attachment point to handle/lift objects, could affect the machine lift performance.

**Lift capacities apply to both standard counterweight and counterweight with removal device.

Lift capacity stays with ±5% for all available track shoes.

Always refer to the appropriate Operation and Maintenance Manual for specific product information.

395 Hydraulic Excavator Specifications

GP Boom Lift Capacities – Standard Counterweight** – without Bucket

Long Variable Gauge Undercarriage

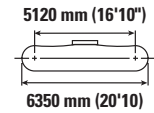
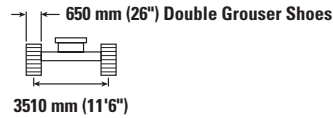
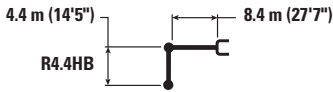

Boom Length	Unit	3000 mm/10'0"		4500 mm/15'0"		6000 mm/20'0"		7500 mm/25'0"		9000 mm/30'0"		10 500 mm/35'0"		12 000 mm/40'0"		mm ft/in		
		kg	lb	kg	lb	kg	lb	kg	lb	kg	lb	kg	lb	kg	lb	kg	lb	
10 500 mm 35'0"	kg lb									*15 650 *32,250	*15 650 *32,250					*11 500 *25,550	*11 500 *25,550	9800 31'8"
9000 mm 30'0"	kg lb									*18 050 *38,850	*18 050 *38,850	*13 550 *29,900	*13 550 *29,900			*11 050 *24,350	*11 050 *24,350	10 830 35'2"
7500 mm 25'0"	kg lb									*19 150 *41,750	*19 150 *41,750	*17 350 *36,250	16 900 *36,250			*10 850 *23,950	*10 850 *23,950	11 580 37'9"
6000 mm 20'0"	kg lb							*23 250 *50,250	*23 250 *50,250	*20 400 *44,300	*20 400 *44,300	*18 550 *40,350	16 550 35,550	*11 950 *11 950		*10 900 *24,050	*10 900 *24,050	12 090 39'6"
4500 mm 15'0"	kg lb					*32 300 *69,500	*32 300 *69,500	*25 750 *55,650	*25 750 *55,650	*21 850 *47,400	20 350 43,800	*19 350 *42,050	16 050 34,550	*15 400 *29,650	12 950 27,800	*11 200 *24,600	*11 200 *24,600	12 400 40'7"
3000 mm 10'0"	kg lb					*36 200 *78,050	35 050 75,550	*28 050 *60,650	25 400 54,750	*23 300 *50,450	19 500 42,050	*20 150 *43,750	15 550 33,450	*17 650 *34,550	12 650 27,200	*11 650 *25,650	*11 650 *25,650	12 520 41'0"
1500 mm 5'0"	kg lb					*38 400 *83,000	33 400 71,950	*29 700 *64,250	24 300 52,400	*24 350 *52,750	18 800 40,550	*20 750 *45,000	15 100 32,500	*18 100 *35,800	12 400 26,650	*12 400 *27,250	11 700 25,800	12 460 40'10"
0 mm 0'0"	kg lb					*38 750 *83,900	32 550 70,050	*30 350 *65,750	23 600 50,800	*24 850 *53,800	18 300 39,400	*21 000 *45,400	14 750 31,750	*17 000 *30,150	12 200 26,300	*13 500 *29,700	11 900 26,250	12 210 40'0"
-1500 mm -5'0"	kg lb			*26 650 *60,650	*26 650 *60,650	*37 600 *81,550	32 200 69,300	*30 000 *64,950	23 200 49,950	*24 600 *53,250	17 950 38,750	*20 550 *44,400	14 550 31,350			*15 100 *33,350	12 500 27,550	11 760 38'6"
-3000 mm -10'0"	kg lb	*26 050 *58,600	*26 050 *58,600	*37 050 *84,250	*37 050 *84,250	*35 150 *76,200	32 250 69,350	*28 450 *61,600	23 100 49,750	*23 400 *50,450	17 900 38,550	*19 150 *40,950	14 550 31,350			*17 400 *38,350	13 550 29,950	11 080 36'3"
-4500 mm -15'0"	kg lb	*36 700 *82,800	*36 700 *82,800	*38 300 *82,900	*38 300 *82,900	*31 250 *67,500	*31 250 *67,500	*25 600 *55,050	23 300 50,200	*20 750 *44,350	18 050 38,950					*17 000 *37,350	15 450 34,350	10 140 33'1"
-6000 mm -20'0"	kg lb			*30 350 *64,950	*30 350 *64,950	*25 300 *54,050	*25 300 *54,050	*20 550 *43,450	*20 550 *43,450							*15 800 *34,600	*15 800 *34,600	8840 28'8"



ISO 10567:2007



*Indicates that the load is limited by hydraulic lifting capacity rather than tipping load. The above loads are in compliance with hydraulic excavator lift capacity standard ISO 10567:2007.

They do not exceed 87% of hydraulic lifting capacity or 75% of tipping load. Weight of all lifting accessories must be deducted from the above lifting capacities. Lifting capacities are based on the machine standing on a firm, uniform supporting surface. The use of a work tool attachment point to handle/lift objects, could affect the machine lift performance.

**Lift capacities apply to both standard counterweight and counterweight with removal device.

Lift capacity stays with ±5% for all available track shoes.

Always refer to the appropriate Operation and Maintenance Manual for specific product information.

395 Hydraulic Excavator Specifications

GP Boom Lift Capacities – Standard Counterweight** – without Bucket

Long Variable Gauge Undercarriage

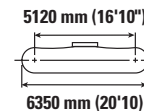
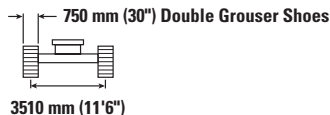

Boom Length	Unit	3000 mm/10'0"		4500 mm/15'0"		6000 mm/20'0"		7500 mm/25'0"		9000 mm/30'0"		10 500 mm/35'0"		12 000 mm/40'0"		mm ft/in		
		kg	lb	kg	lb	kg	lb	kg	lb	kg	lb	kg	lb	kg	lb	kg	lb	
10 500 mm 35'0"	kg lb									*15 650 *32,250	*15 650 *32,250					*11 500 *25,550	*11 500 *25,550	9800 31'8"
9000 mm 30'0"	kg lb									*18 050 *38,850	*18 050 *38,850	*13 550 *29,900	*13 550 *29,900			*11 050 *24,350	*11 050 *24,350	10 830 35'2"
7500 mm 25'0"	kg lb									*19 150 *41,750	*19 150 *41,750	*17 350 *36,250	17 050 *36,250			*10 850 *23,950	*10 850 *23,950	11 580 37'9"
6000 mm 20'0"	kg lb							*23 250 *50,250	*23 250 *50,250	*20 400 *44,300	*20 400 *44,300	*18 550 *40,350	16 700 35,850	*11 950 *26,550	*11 950 *26,550	*10 900 *24,050	*10 900 *24,050	12 090 39'6"
4500 mm 15'0"	kg lb					*32 300 *69,500	*32 300 *69,500	*25 750 *55,650	*25 750 *55,650	*21 850 *47,400	20 500 44,200	*19 350 *42,050	16 200 34,850	*15 400 *29,650	13 050 28,050	*11 200 *24,600	*11 200 *24,600	12 400 40'7"
3000 mm 10'0"	kg lb					*36 200 *78,050	35 350 76,200	*28 050 *60,650	25 600 55,250	*23 300 *50,450	19 700 42,450	*20 150 *43,750	15 700 33,800	*17 650 *34,550	12 800 27,500	*11 650 *25,650	*11 650 *25,650	12 520 41'0"
1500 mm 5'0"	kg lb					*38 400 *83,000	33 700 72,600	*29 700 *64,250	24 550 52,900	*24 350 *52,750	19 000 40,900	*20 750 *45,000	15 250 32,800	*18 100 *35,800	12 500 26,950	*12 400 *27,250	*11 850 *26,050	12 460 40'10"
0 mm 0'0"	kg lb					*38 750 *83,900	32 850 70,700	*30 350 *65,750	23 800 51,300	*24 850 *53,800	18 450 39,800	*21 000 *45,400	14 900 32,050	*17 000 *30,150	12 350 26,550	*13 500 *29,700	*12 050 *26,500	12 210 40'0"
-1500 mm -5'0"	kg lb			*26 650 *60,650	*26 650 *60,650	*37 600 *81,550	32 500 69,950	*30 000 *64,950	23 400 50,450	*24 600 *53,250	18 150 39,100	*20 550 *44,400	14 700 31,650			*15 100 *33,350	12 600 27,800	11 760 38'6"
-3000 mm -10'0"	kg lb	*26 050 *58,600	*26 050 *58,600	*37 050 *84,250	*37 050 *84,250	*35 150 *76,200	32 550 70,000	*28 450 *61,600	23 350 50,250	*23 400 *50,450	18 050 38,950	*19 150 *40,950	14 650 31,650			*17 400 *38,350	13 700 30,250	11 080 36'3"
-4500 mm -15'0"	kg lb	*36 700 *82,800	*36 700 *82,800	*38 300 *82,900	*38 300 *82,900	*31 250 *67,500	*31 250 *67,500	*25 600 *55,050	23 500 50,700	*20 750 *44,350	18 250 39,350					*17 000 *37,350	15 600 34,700	10 140 33'1"
-6000 mm -20'0"	kg lb			*30 350 *64,950	*30 350 *64,950	*25 300 *54,050	*25 300 *54,050	*20 550 *43,450	*20 550 *43,450							*15 800 *34,600	*15 800 *34,600	8840 28'8"



ISO 10567:2007



*Indicates that the load is limited by hydraulic lifting capacity rather than tipping load. The above loads are in compliance with hydraulic excavator lift capacity standard ISO 10567:2007. They do not exceed 87% of hydraulic lifting capacity or 75% of tipping load. Weight of all lifting accessories must be deducted from the above lifting capacities. Lifting capacities are based on the machine standing on a firm, uniform supporting surface. The use of a work tool attachment point to handle/lift objects, could affect the machine lift performance.

**Lift capacities apply to both standard counterweight and counterweight with removal device.

Lift capacity stays with ±5% for all available track shoes.

Always refer to the appropriate Operation and Maintenance Manual for specific product information.

395 Hydraulic Excavator Specifications

GP Boom Lift Capacities – Standard Counterweight** – without Bucket

Long Variable Gauge Undercarriage

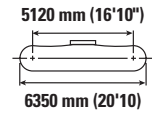
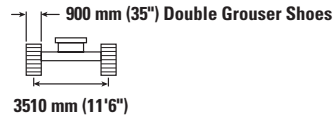
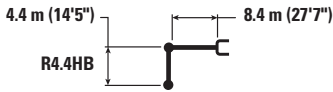

Boom Length	Unit	3000 mm/10'0"		4500 mm/15'0"		6000 mm/20'0"		7500 mm/25'0"		9000 mm/30'0"		10 500 mm/35'0"		12 000 mm/40'0"		mm ft/in		
		kg	lb	kg	lb	kg	lb	kg	lb	kg	lb	kg	lb	kg	lb	kg	lb	
10 500 mm 35'0"	kg lb									*15 650 *32,250	*15 650 *32,250					*11 500 *25,550	*11 500 *25,550	9800 31'8"
9000 mm 30'0"	kg lb									*18 050 *38,850	*18 050 *38,850	*13 550 *29,900	*13 550 *29,900			*11 050 *24,350	*11 050 *24,350	10 830 35'2"
7500 mm 25'0"	kg lb									*19 150 *41,750	*19 150 *41,750	*17 350 *36,250	17 250 *36,250			*10 850 *23,950	*10 850 *23,950	11 580 37'9"
6000 mm 20'0"	kg lb							*23 250 *50,250	*23 250 *50,250	*20 400 *44,300	*20 400 *44,300	*18 550 *40,350	16 850 36,250	*11 950 *11 950		*10 900 *24,050	*10 900 *24,050	12 090 39'6"
4500 mm 15'0"	kg lb					*32 300 *69,500	*32 300 *69,500	*25 750 *55,650	*25 750 *55,650	*21 850 *47,400	20 700 44,650	*19 350 *42,050	16 350 35,250	*15 400 *29,650	13 200 28,350	*11 200 *24,600	*11 200 *24,600	12 400 40'7"
3000 mm 10'0"	kg lb					*36 200 *78,050	35 700 77,000	*28 050 *60,650	25 900 55,800	*23 300 *50,450	19 900 42,900	*20 150 *43,750	15 850 34,150	*17 650 *34,550	12 950 27,800	*11 650 *25,650	*11 650 *25,650	12 520 41'0"
1500 mm 5'0"	kg lb					*38 400 *83,000	34 050 73,400	*29 700 *64,250	24 800 53,450	*24 350 *52,750	19 200 41,350	*20 750 *45,000	15 400 33,200	*18 100 *35,800	12 650 27,250	*12 400 *27,250	12 000 26,400	12 460 40'10"
0 mm 0'0"	kg lb					*38 750 *83,900	33 200 71,500	*30 350 *65,750	24 050 51,900	*24 850 *53,800	18 650 40,250	*21 000 *45,400	15 050 32,450	*17 000 *30,150	12 500 26,900	*13 500 *29,700	12 200 26,850	12 210 40'0"
-1500 mm -5'0"	kg lb			*26 650 *60,650	*26 650 *60,650	*37 600 *81,550	32 900 70,750	*30 000 *64,950	23 700 51,050	*24 600 *53,250	18 350 39,550	*20 550 *44,400	14 850 32,000			*15 100 *33,350	12 750 28,150	11 760 38'6"
-3000 mm -10'0"	kg lb	*26 050 *58,600	*26 050 *58,600	*37 050 *84,250	*37 050 *84,250	*35 150 *76,200	32 900 70,800	*28 450 *61,600	23 600 50,850	*23 400 *50,450	18 250 39,400	*19 150 *40,950	14 850 32,050			*17 400 *38,350	13 850 30,650	11 080 36'3"
-4500 mm -15'0"	kg lb	*36 700 *82,800	*36 700 *82,800	*38 300 *82,900	*38 300 *82,900	*31 250 *67,500	*31 250 *67,500	*25 600 *55,050	23 800 51,250	*20 750 *44,350	18 450 39,800					*17 000 *37,350	15 800 35,100	10 140 33'1"
-6000 mm -20'0"	kg lb			*30 350 *64,950	*30 350 *64,950	*25 300 *54,050	*25 300 *54,050	*20 550 *43,450	*20 550 *43,450							*15 800 *34,600	*15 800 *34,600	8840 28'8"



ISO 10567:2007



*Indicates that the load is limited by hydraulic lifting capacity rather than tipping load. The above loads are in compliance with hydraulic excavator lift capacity standard ISO 10567:2007.

They do not exceed 87% of hydraulic lifting capacity or 75% of tipping load. Weight of all lifting accessories must be deducted from the above lifting capacities. Lifting capacities are based on the machine standing on a firm, uniform supporting surface. The use of a work tool attachment point to handle/lift objects, could affect the machine lift performance.

**Lift capacities apply to both standard counterweight and counterweight with removal device.

Lift capacity stays with ±5% for all available track shoes.



Always refer to the appropriate Operation and Maintenance Manual for specific product information.

395 Hydraulic Excavator Specifications

GP Boom Lift Capacities – Standard Counterweight** – without Bucket

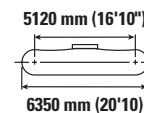
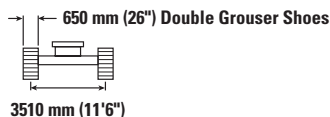
Long Variable Gauge Undercarriage



	1500 mm/5'0"		3000 mm/10'0"		4500 mm/15'0"		6000 mm/20'0"		7500 mm/25'0"						
	kg	lb	kg	lb	kg	lb	kg	lb	kg	lb	kg	lb	mm	ft/in	
12 000 mm 40'0"													*9000	*9000	9840
													*20,100	*20,100	31'7"
10 500 mm 35'0"													*8400	*8400	11 080
													*18,650	*18,650	35'11"
9000 mm 30'0"													*8100	*8100	12 010
													*17,900	*17,900	39'1"
7500 mm 25'0"													*8000	*8000	12 680
													*17,600	*17,600	41'5"
6000 mm 20'0"													*8000	*8000	13 150
													*17,650	*17,650	43'0"
4500 mm 15'0"								*28 400	*28 400	*23 200	*23 200		*8200	*8200	13 440
								*61,150	*61,150	*50,200	*50,200		*18,000	*18,000	44'0"
3000 mm 10'0"								*32 950	*32 950	*25 900	*25 900		*8500	*8500	13 550
								*71,050	*71,050	*56,000	*56,000		*18,700	*18,700	44'5"
1500 mm 5'0"								*36 350	34 100	*28 100	24 650		*9000	*9000	13 490
								*78,500	73,500	*60,800	53,150		*19,800	*19,800	44'2"
0 mm 0'0"					*20 950	*20 950	*38 000	32 700	*29 500	23 650			*9700	*9700	13 260
					*47,950	*47,950	*82,250	70,400	*63,800	50,950			*21,350	*21,350	43'5"
-1500 mm -5'0"				*15 700	*15 700	*25 650	*25 650	*38 100	31 950	*29 900	23 000		*10 700	*10 700	12 840
				*35,300	*35,300	*58,300	*58,300	*82,500	68,700	*64,700	49,550		*23,600	*23,600	42'1"
-3000 mm -10'0"	kg	*18 100	*18 100	*22 300	*22 300	*32 500	*32 500	*36 750	31 700	*29 200	22 700		*12 200	11 500	12 230
	lb	*40,350	*40,350	*50,100	*50,100	*73,800	*73,800	*79,650	68,100	*63,250	48,900		*26,950	25,350	40'0"
-4500 mm -15'0"	kg	*24 550	*24 550	*29 900	*29 900	*41 750	*41 750	*34 050	31 750	*27 400	22 700		*14 550	12 750	11 390
	lb	*55,000	*55,000	*67,350	*67,350	*94,350	*94,350	*73,600	68,350	*59,100	48,850		*32,350	28,250	37'2"
-6000 mm -20'0"	kg			*39 350	*39 350	*37 200	*37 200	*29 700	*29 700	*24 000	22 950		*15 300	14 950	10 250
	lb			*88,950	*88,950	*80,000	*80,000	*63,750	*63,750	*51,400	49,500		*33,600	33,400	33'4"
-7500 mm -25'0"	kg					*28 050	*28 050	*22 850	*22 850	*18 150	*18 150		*14 000	*14 000	8710
	lb					*59,250	*59,250	*48,150	*48,150	*37,700	*37,700		*30,400	*30,400	28'0"



ISO 10567:2007



*Indicates that the load is limited by hydraulic lifting capacity rather than tipping load. The above loads are in compliance with hydraulic excavator lift capacity standard ISO 10567:2007. They do not exceed 87% of hydraulic lifting capacity or 75% of tipping load. Weight of all lifting accessories must be deducted from the above lifting capacities. Lifting capacities are based on the machine standing on a firm, uniform supporting surface. The use of a work tool attachment point to handle/lift objects, could affect the machine lift performance.

**Lift capacities apply to both standard counterweight and counterweight with removal device.

Lift capacity stays with ±5% for all available track shoes.

Always refer to the appropriate Operation and Maintenance Manual for specific product information.









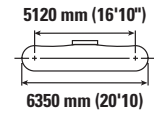
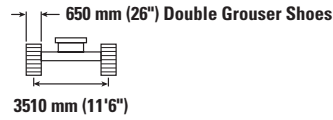
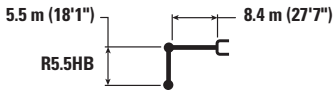

(continued on next page)

395 Hydraulic Excavator Specifications

GP Boom Lift Capacities – Standard Counterweight** – without Bucket (continued)

Long Variable Gauge Undercarriage



Boom Length	Unit	9000 mm/30'0"		10 500 mm/35'0"		12 000 mm/40'0"		13 500 mm/45'0"				mm ft/in
												
12 000 mm 40'0"	kg lb									*9000 *20,100	*9000 *20,100	9840 31'7"
10 500 mm 35'0"	kg lb			*11 000 *21,900	*11 000 *21,900					*8400 *18,650	*8400 *18,650	11 080 35'11"
9000 mm 30'0"	kg lb			*13 050 *27,850	*13 050 *27,850	*8100	*8100			*8100 *17,900	*8100 *17,900	12 010 39'1"
7500 mm 25'0"	kg lb			*14 500 *31,300	*14 500 *31,300	*11 500 *23,250	*11 500 *23,250			*8000 *17,600	*8000 *17,600	12 680 41'5"
6000 mm 20'0"	kg lb	*17 700 *38,300	*17 700 *38,300	*16 400 *35,300	*16 400 *35,300	*13 550 *28,300	13 400 *28,300			*8000 *17,650	*8000 *17,650	13 150 43'0"
4500 mm 15'0"	kg lb	*20 000 *43,400	*20 000 *43,400	*17 850 *38,850	16 250 *34,950	*15 500 *32,550	13 050 28,000			*8200 *18,000	*8200 *18,000	13 440 44'0"
3000 mm 10'0"	kg lb	*21 700 *47,000	19 800 42,650	*18 900 *41,050	15 650 33,700	*16 950 *36,800	12 700 27,250	*8950	*8950	*8500 *18,700	*8500 *18,700	13 550 44'5"
1500 mm 5'0"	kg lb	*23 100 *50,050	18 950 40,800	*19 800 *42,950	15 100 32,500	*17 400 *37,800	12 300 26,500			*9000 *19,800	*9000 *19,800	13 490 44'2"
0 mm 0'0"	kg lb	*24 100 *52,150	18 250 39,300	*20 400 *44,150	14 650 31,500	*17 650 *38,200	12 000 25,850			*9700 *21,350	*9700 *21,350	13 260 43'5"
-1500 mm -5'0"	kg lb	*24 400 *52,800	17 800 38,300	*20 500 *44,350	14 300 30,800	*17 450 *37,600	11 800 25,450			*10 700 *23,600	*10 700 *23,600	12 840 42'1"
-3000 mm -10'0"	kg lb	*23 900 *51,700	17 500 37,750	*19 900 *42,950	14 150 30,450	*15 550 *27,400	11 750 25,400			*12 200 *26,950	11 500 25,350	12 230 40'0"
-4500 mm -15'0"	kg lb	*22 400 *48,200	17 500 37,700	*18 250 *39,000	14 150 30,550					*14 550 *32,350	12 750 28,250	11 390 37'2"
-6000 mm -20'0"	kg lb	*19 300 *40,950	17 750 38,300							*15 300 *33,600	14 950 33,400	10 250 33'4"
-7500 mm -25'0"	kg lb									*14 000 *30,400	*14 000 *30,400	8710 28'0"



ISO 10567:2007



*Indicates that the load is limited by hydraulic lifting capacity rather than tipping load. The above loads are in compliance with hydraulic excavator lift capacity standard ISO 10567:2007. They do not exceed 87% of hydraulic lifting capacity or 75% of tipping load. Weight of all lifting accessories must be deducted from the above lifting capacities. Lifting capacities are based on the machine standing on a firm, uniform supporting surface. The use of a work tool attachment point to handle/lift objects, could affect the machine lift performance.

**Lift capacities apply to both standard counterweight and counterweight with removal device.

Lift capacity stays with ±5% for all available track shoes.



Always refer to the appropriate Operation and Maintenance Manual for specific product information.

395 Hydraulic Excavator Specifications

GP Boom Lift Capacities – Standard Counterweight** – without Bucket

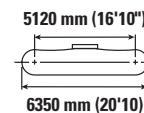
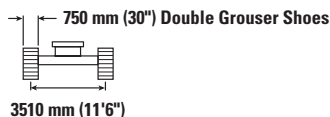
Long Variable Gauge Undercarriage



	1500 mm/5'0"		3000 mm/10'0"		4500 mm/15'0"		6000 mm/20'0"		7500 mm/25'0"				mm ft/in	
	kg lb	kg lb	kg lb	kg lb	kg lb	kg lb	kg lb	kg lb	kg lb	kg lb	kg lb	kg lb		
12 000 mm 40'0"	kg lb											*9000 *20,100	*9000 *20,100	9840 31'7"
10 500 mm 35'0"	kg lb											*8400 *18,650	*8400 *18,650	11 080 35'11"
9000 mm 30'0"	kg lb											*8100 *17,900	*8100 *17,900	12 010 39'1"
7500 mm 25'0"	kg lb											*8000 *17,600	*8000 *17,600	12 680 41'5"
6000 mm 20'0"	kg lb											*8000 *17,650	*8000 *17,650	13 150 43'0"
4500 mm 15'0"	kg lb						*28 400 *61,150	*28 400 *61,150	*23 200 *50,200	*23 200 *50,200		*8200 *18,000	*8200 *18,000	13 440 44'0"
3000 mm 10'0"	kg lb						*32 950 *71,050	*32 950 *71,050	*25 900 *56,000	*25 900 *56,000		*8500 *18,700	*8500 *18,700	13 550 44'5"
1500 mm 5'0"	kg lb						*36 350 *78,500	34 400 74,150	*28 100 *60,800	24 850 53,600		*9000 *19,800	*9000 *19,800	13 490 44'2"
0 mm 0'0"	kg lb					*20 950 *47,950	*20 950 *47,950	*38 000 *82,250	33 000 71,050	*29 500 *63,800	23 850 51,450	*9700 *21,350	*9700 *21,350	13 260 43'5"
-1500 mm -5'0"	kg lb			*15 700 *35,300	*15 700 *35,300	*25 650 *58,300	*25 650 *58,300	*38 100 *82,500	32 250 69,350	*29 900 *64,700	23 250 50,050	*10 700 *23,600	*10 700 *23,600	12 840 42'1"
-3000 mm -10'0"	kg lb	*18 100 *40,350	*18 100 *40,350	*22 300 *50,100	*22 300 *50,100	*32 500 *73,800	*32 500 *73,800	*36 750 *79,650	32 000 68,750	*29 200 *63,250	22 950 49,350	*12 200 *26,950	11 600 25,600	12 230 40'0"
-4500 mm -15'0"	kg lb	*24 550 *55,000	*24 550 *55,000	*29 900 *67,350	*29 900 *67,350	*41 750 *94,350	*41 750 *94,350	*34 050 *73,600	32 050 69,000	*27 400 *59,100	22 900 49,350	*14 550 *32,350	12 900 28,550	11 390 37'2"
-6000 mm -20'0"	kg lb			*39 350 *88,950	*39 350 *88,950	*37 200 *80,000	*37 200 *80,000	*29 700 *63,750	*29 700 *63,750	*24 000 *51,400	23 200 50,000	*15 300 *33,600	15 100 *33,600	10 250 33'4"
-7500 mm -25'0"	kg lb					*28 050 *59,250	*28 050 *59,250	*22 850 *48,150	*22 850 *48,150	*18 150 *37,700	*18 150 *37,700	*14 000 *30,400	*14 000 *30,400	8710 28'0"



ISO 10567:2007



*Indicates that the load is limited by hydraulic lifting capacity rather than tipping load. The above loads are in compliance with hydraulic excavator lift capacity standard ISO 10567:2007. They do not exceed 87% of hydraulic lifting capacity or 75% of tipping load. Weight of all lifting accessories must be deducted from the above lifting capacities. Lifting capacities are based on the machine standing on a firm, uniform supporting surface. The use of a work tool attachment point to handle/lift objects, could affect the machine lift performance.

**Lift capacities apply to both standard counterweight and counterweight with removal device.

Lift capacity stays with ±5% for all available track shoes.

Always refer to the appropriate Operation and Maintenance Manual for specific product information.

(continued on next page)

395 Hydraulic Excavator Specifications

GP Boom Lift Capacities – Standard Counterweight** – without Bucket (continued)

Long Variable Gauge Undercarriage

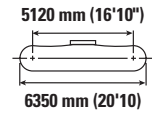
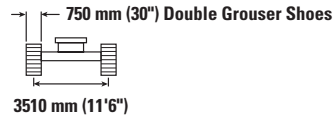
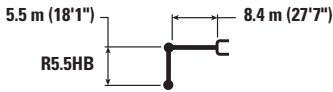

Boom Length	Unit	9000 mm/30'0"		10 500 mm/35'0"		12 000 mm/40'0"		13 500 mm/45'0"		mm ft/in		
		kg lb	kg lb	kg lb	kg lb	kg lb	kg lb	kg lb	kg lb	mm ft/in	mm ft/in	
12 000 mm 40'0"	kg lb									*9000 *20,100	*9000 *20,100	9840 31'7"
10 500 mm 35'0"	kg lb			*11 000 *21,900	*11 000 *21,900					*8400 *18,650	*8400 *18,650	11 080 35'11"
9000 mm 30'0"	kg lb			*13 050 *27,850	*13 050 *27,850	*8100	*8100			*8100 *17,900	*8100 *17,900	12 010 39'1"
7500 mm 25'0"	kg lb			*14 500 *31,300	*14 500 *31,300	*11 500 *23,250	*11 500 *23,250			*8000 *17,600	*8000 *17,600	12 680 41'5"
6000 mm 20'0"	kg lb	*17 700 *38,300	*17 700 *38,300	*16 400 *35,300	*16 400 *35,300	*13 550 *28,300	13 500 *28,300			*8000 *17,650	*8000 *17,650	13 150 43'0"
4500 mm 15'0"	kg lb	*20 000 *43,400	*20 000 *43,400	*17 850 *38,850	16 400 *35,300	*15 500 *32,550	13 200 *28,300			*8200 *18,000	*8200 *18,000	13 440 44'0"
3000 mm 10'0"	kg lb	*21 700 *47,000	19 950 43,050	*18 900 *41,050	15 800 34,000	*16 950 *36,800	12 800 27,500	*8950	*8950	*8500 *18,700	*8500 *18,700	13 550 44'5"
1500 mm 5'0"	kg lb	*23 100 *50,050	19 100 41,200	*19 800 *42,950	15 250 32,800	*17 400 *37,800	12 450 26,750			*9000 *19,800	*9000 *19,800	13 490 44'2"
0 mm 0'0"	kg lb	*24 100 *52,150	18 450 39,700	*20 400 *44,150	14 750 31,800	*17 650 *38,200	12 150 26,100			*9700 *21,350	*9700 *21,350	13 260 43'5"
-1500 mm -5'0"	kg lb	*24 400 *52,800	17 950 38,650	*20 500 *44,350	14 450 31,100	*17 450 *37,600	11 950 25,700			*10 700 *23,600	*10 700 *23,600	12 840 42'1"
-3000 mm -10'0"	kg lb	*23 900 *51,700	17 700 38,100	*19 900 *42,950	14 250 30,750	*15 550 *27,400	11 900 25,650			*12 200 *26,950	11 600 25,600	12 230 40'0"
-4500 mm -15'0"	kg lb	*22 400 *48,200	17 650 38,100	*18 250 *39,000	14 300 30,900					*14 550 *32,350	12 900 28,550	11 390 37'2"
-6000 mm -20'0"	kg lb	*19 300 *40,950	17 900 38,700							*15 300 *33,600	15 100 *33,600	10 250 33'4"
-7500 mm -25'0"	kg lb									*14 000 *30,400	*14 000 *30,400	8710 28'0"



ISO 10567:2007



*Indicates that the load is limited by hydraulic lifting capacity rather than tipping load. The above loads are in compliance with hydraulic excavator lift capacity standard ISO 10567:2007. They do not exceed 87% of hydraulic lifting capacity or 75% of tipping load. Weight of all lifting accessories must be deducted from the above lifting capacities. Lifting capacities are based on the machine standing on a firm, uniform supporting surface. The use of a work tool attachment point to handle/lift objects, could affect the machine lift performance.

**Lift capacities apply to both standard counterweight and counterweight with removal device.

Lift capacity stays with ±5% for all available track shoes.



Always refer to the appropriate Operation and Maintenance Manual for specific product information.

395 Hydraulic Excavator Specifications

GP Boom Lift Capacities – Standard Counterweight** – without Bucket

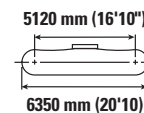
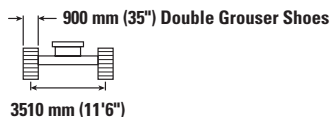
Long Variable Gauge Undercarriage



	1500 mm/5'0"		3000 mm/10'0"		4500 mm/15'0"		6000 mm/20'0"		7500 mm/25'0"				mm ft/in	
	kg lb	kg lb	kg lb	kg lb	kg lb	kg lb	kg lb	kg lb	kg lb	kg lb	kg lb	kg lb		
12 000 mm 40'0"	kg lb											*9000 *20,100	*9000 *20,100	9840 31'7"
10 500 mm 35'0"	kg lb											*8400 *18,650	*8400 *18,650	11 080 35'11"
9000 mm 30'0"	kg lb											*8100 *17,900	*8100 *17,900	12 010 39'1"
7500 mm 25'0"	kg lb											*8000 *17,600	*8000 *17,600	12 680 41'5"
6000 mm 20'0"	kg lb											*8000 *17,650	*8000 *17,650	13 150 43'0"
4500 mm 15'0"	kg lb							*28 400 *61,150	*28 400 *61,150	*23 200 *50,200	*23 200 *50,200	*8200 *18,000	*8200 *18,000	13 440 44'0"
3000 mm 10'0"	kg lb							*32 950 *71,050	*32 950 *71,050	*25 900 *56,000	*25 900 *56,000	*8500 *18,700	*8500 *18,700	13 550 44'5"
1500 mm 5'0"	kg lb							*36 350 *78,500	34 800 74,950	*28 100 *60,800	25 150 54,200	*9000 *19,800	*9000 *19,800	13 490 44'2"
0 mm 0'0"	kg lb					*20 950 *47,950	*20 950 *47,950	*38 000 *82,250	33 350 71,850	*29 500 *63,800	24 150 52,000	*9700 *21,350	*9700 *21,350	13 260 43'5"
-1500 mm -5'0"	kg lb			*15 700 *35,300	*15 700 *35,300	*25 650 *58,300	*25 650 *58,300	*38 100 *82,500	32 600 70,150	*29 900 *64,700	23 500 50,600	*10 700 *23,600	*10 700 *23,600	12 840 42'1"
-3000 mm -10'0"	kg lb	*18 100 *40,350	*18 100 *40,350	*22 300 *50,100	*22 300 *50,100	*32 500 *73,800	*32 500 *73,800	*36 750 *79,650	32 350 69,550	*29 200 *63,250	23 200 49,950	*12 200 *26,950	11 750 25,950	12 230 40'0"
-4500 mm -15'0"	kg lb	*24 550 *55,000	*24 550 *55,000	*29 900 *67,350	*29 900 *67,350	*41 750 *94,350	*41 750 *94,350	*34 050 *73,600	32 450 69,750	*27 400 *59,100	23 200 49,950	*14 550 *32,350	13 050 28,900	11 390 37'2"
-6000 mm -20'0"	kg lb			*39 350 *88,950	*39 350 *88,950	*37 200 *80,000	*37 200 *80,000	*29 700 *63,750	*29 700 *63,750	*24 000 *51,400	23 450 50,600	*15 300 *33,600	15 300 *33,600	10 250 33'4"
-7500 mm -25'0"	kg lb					*28 050 *59,250	*28 050 *59,250	*22 850 *48,150	*22 850 *48,150	*18 150 *37,700	*18 150 *37,700	*14 000 *30,400	*14 000 *30,400	8710 28'0"



ISO 10567:2007



*Indicates that the load is limited by hydraulic lifting capacity rather than tipping load. The above loads are in compliance with hydraulic excavator lift capacity standard ISO 10567:2007. They do not exceed 87% of hydraulic lifting capacity or 75% of tipping load. Weight of all lifting accessories must be deducted from the above lifting capacities. Lifting capacities are based on the machine standing on a firm, uniform supporting surface. The use of a work tool attachment point to handle/lift objects, could affect the machine lift performance.

**Lift capacities apply to both standard counterweight and counterweight with removal device.

Lift capacity stays with ±5% for all available track shoes.

Always refer to the appropriate Operation and Maintenance Manual for specific product information.

(continued on next page)

395 Hydraulic Excavator Specifications

GP Boom Lift Capacities – Standard Counterweight** – without Bucket (continued)

Long Variable Gauge Undercarriage

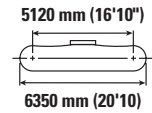
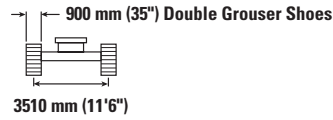
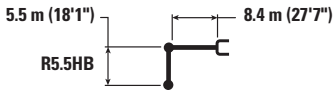

Boom Length	Unit	9000 mm/30'0"		10 500 mm/35'0"		12 000 mm/40'0"		13 500 mm/45'0"		mm ft/in		
		kg lb	kg lb	kg lb	kg lb	kg lb	kg lb	kg lb	kg lb	mm ft/in	mm ft/in	
12 000 mm 40'0"	kg lb									*9000 *20,100	*9000 *20,100	9840 31'7"
10 500 mm 35'0"	kg lb			*11 000 *21,900	*11 000 *21,900					*8400 *18,650	*8400 *18,650	11 080 35'11"
9000 mm 30'0"	kg lb			*13 050 *27,850	*13 050 *27,850	*8100	*8100			*8100 *17,900	*8100 *17,900	12 010 39'1"
7500 mm 25'0"	kg lb			*14 500 *31,300	*14 500 *31,300	*11 500 *23,250	*11 500 *23,250			*8000 *17,600	*8000 *17,600	12 680 41'5"
6000 mm 20'0"	kg lb	*17 700 *38,300	*17 700 *38,300	*16 400 *35,300	*16 400 *35,300	*13 550 *28,300	*13 550 *28,300			*8000 *17,650	*8000 *17,650	13 150 43'0"
4500 mm 15'0"	kg lb	*20 000 *43,400	*20 000 *43,400	*17 850 *38,850	16 600 35,650	*15 500 *32,550	13 350 28,600			*8200 *18,000	*8200 *18,000	13 440 44'0"
3000 mm 10'0"	kg lb	*21 700 *47,000	20 200 43,500	*18 900 *41,050	16 000 34,400	*16 950 *36,800	12 950 27,850	*8950	*8950	*8500 *18,700	*8500 *18,700	13 550 44'5"
1500 mm 5'0"	kg lb	*23 100 *50,050	19 350 41,650	*19 800 *42,950	15 400 33,200	*17 400 *37,800	12 600 27,050			*9000 *19,800	*9000 *19,800	13 490 44'2"
0 mm 0'0"	kg lb	*24 100 *52,150	18 650 40,150	*20 400 *44,150	14 950 32,200	*17 650 *38,200	12 300 26,450			*9700 *21,350	*9700 *21,350	13 260 43'5"
-1500 mm -5'0"	kg lb	*24 400 *52,800	18 150 39,100	*20 500 *44,350	14 600 31,450	*17 450 *37,600	12 100 26,050			*10 700 *23,600	*10 700 *23,600	12 840 42'1"
-3000 mm -10'0"	kg lb	*23 900 *51,700	17 900 38,550	*19 900 *42,950	14 450 31,150	*15 550 *27,400	12 050 26,000			*12 200 *26,950	11 750 25,950	12 230 40'0"
-4500 mm -15'0"	kg lb	*22 400 *48,200	17 900 38,550	*18 250 *39,000	14 500 31,250					*14 550 *32,350	13 050 28,900	11 390 37'2"
-6000 mm -20'0"	kg lb	*19 300 *40,950	18 150 39,150							*15 300 *33,600	15 300 *33,600	10 250 33'4"
-7500 mm -25'0"	kg lb									*14 000 *30,400	*14 000 *30,400	8710 28'0"



ISO 10567:2007



*Indicates that the load is limited by hydraulic lifting capacity rather than tipping load. The above loads are in compliance with hydraulic excavator lift capacity standard ISO 10567:2007. They do not exceed 87% of hydraulic lifting capacity or 75% of tipping load. Weight of all lifting accessories must be deducted from the above lifting capacities. Lifting capacities are based on the machine standing on a firm, uniform supporting surface. The use of a work tool attachment point to handle/lift objects, could affect the machine lift performance.

**Lift capacities apply to both standard counterweight and counterweight with removal device.

Lift capacity stays with ±5% for all available track shoes.

Always refer to the appropriate Operation and Maintenance Manual for specific product information.

395 Hydraulic Excavator Specifications

Mass Boom Lift Capacities – Standard Counterweight** – without Bucket

Long Variable Gauge Undercarriage

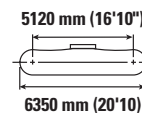
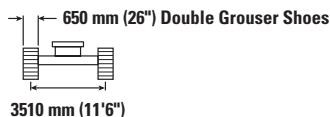
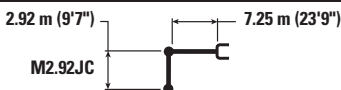

Boom Length	Unit	3000 mm/10'0"		4500 mm/15'0"		6000 mm/20'0"		7500 mm/25'0"		9000 mm/30'0"		mm ft/in		
		kg	lb	kg	lb	kg	lb	kg	lb	kg	lb	kg	lb	
10 500 mm 35'0"	kg lb											*21 300	*21 300	6290
9000 mm 30'0"	kg lb							*23 050 *45,100	*23 050 *45,100			*19 250 *42,700	*19 250 *42,700	7820 25'2"
7500 mm 25'0"	kg lb							*25 750 *56,150	*25 750 *56,150			*18 450 *40,750	*18 450 *40,750	8830 28'8"
6000 mm 20'0"	kg lb			*42 050 *90,050	*42 050 *90,050	*32 250 *69,650	*32 250 *69,650	*27 100 *58,800	*27 100 *58,600	*24 000 *52,350	20 300 43,600	*18 400 *40,450	*18 400 *40,450	9500 31'0"
4500 mm 15'0"	kg lb					*35 950 *77,550	*35 950 *77,550	*28 850 *62,500	26 150 56,350	*24 700 *53,650	19 750 42,550	*18 850 *41,400	17 000 37,600	9890 32'4"
3000 mm 10'0"	kg lb					*38 750 *83,750	34 800 75,050	*30 400 *65,800	25 100 54,100	*25 300 *54,900	19 200 41,350	*19 800 *43,550	16 300 35,950	10 040 32'11"
1500 mm 5'0"	kg lb					*39 550 *85,750	33 600 72,400	*31 050 *67,200	24 300 52,350	*25 400 *55,050	18 750 40,350	*21 450 *47,200	16 250 35,750	9960 32'8"
0 mm 0'0"	kg lb			*28 950 *67,450	*28 950 *67,450	*38 250 *83,000	33 100 71,250	*30 400 *65,800	23 850 51,400	*24 550 *52,900	18 500 39,850	*22 100 *48,700	16 850 37,100	9640 31'7"
-1500 mm -5'0"	kg lb	*60,950	*60,950	*42 500 *92,700	*42 500 *92,700	*35 000 *75,900	33 100 71,150	*28 050 *60,600	23 750 51,200	*21 700	18 550	*21 400 *47,100	18 400 40,550	9060 29'8"
-3000 mm -10'0"	kg lb			*35 000 *76,000	*35 000 *76,000	*29 400 *63,400	*29 400 *63,400	*23 150 *49,350	*23 150 *49,350			*19 850 *43,550	*19 850 *43,550	8170 26'7"
-4500 mm -15'0"	kg lb					*19 800 *41,400	*19 800 *41,400					*16 500 *38,450	*16 500 *38,450	6740 21'0"



ISO 10567:2007



*Indicates that the load is limited by hydraulic lifting capacity rather than tipping load. The above loads are in compliance with hydraulic excavator lift capacity standard ISO 10567:2007. They do not exceed 87% of hydraulic lifting capacity or 75% of tipping load. Weight of all lifting accessories must be deducted from the above lifting capacities. Lifting capacities are based on the machine standing on a firm, uniform supporting surface. The use of a work tool attachment point to handle/lift objects, could affect the machine lift performance.

**Lift capacities apply to both standard counterweight and counterweight with removal device.

Lift capacity stays with ±5% for all available track shoes.

Always refer to the appropriate Operation and Maintenance Manual for specific product information.

395 Hydraulic Excavator Specifications

Mass Boom Lift Capacities – Standard Counterweight** – without Bucket

Long Variable Gauge Undercarriage

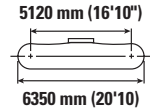
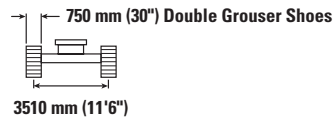
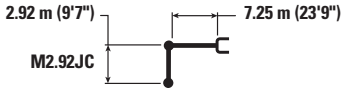

		3000 mm/10'0"		4500 mm/15'0"		6000 mm/20'0"		7500 mm/25'0"		9000 mm/30'0"		mm ft/in		
10 500 mm 35'0"	kg lb											*21 300	*21 300	6290
9000 mm 30'0"	kg lb							*23 050 *45,100	*23 050 *45,100			*19 250 *42,700	*19 250 *42,700	7820 25'2"
7500 mm 25'0"	kg lb							*25 750 *56,150	*25 750 *56,150			*18 450 *40,750	*18 450 *40,750	8830 28'8"
6000 mm 20'0"	kg lb			*42 050 *90,050	*42 050 *90,050	*32 250 *69,650	*32 250 *69,650	*27 100 *58,800	*27 100 *58,800	*24 000 *52,350	20 450 43,950	*18 400 *40,450	*18 400 *40,450	9500 31'0"
4500 mm 15'0"	kg lb					*35 950 *77,550	*35 950 *77,550	*28 850 *62,500	26 350 56,800	*24 700 *53,650	19 950 42,900	*18 850 *41,400	17 150 37,950	9890 32'4"
3000 mm 10'0"	kg lb					*38 750 *83,750	35 100 75,700	*30 400 *65,800	25 300 54,550	*25 300 *54,900	19 400 41,750	*19 800 *43,550	16 450 36,250	10 040 32'11"
1500 mm 5'0"	kg lb					*39 550 *85,750	33 900 73,050	*31 050 *67,200	24 500 52,850	*25 400 *55,050	18 900 40,750	*21 450 *47,200	16 400 36,100	9960 32'8"
0 mm 0'0"	kg lb			*28 950 *67,450	*28 950 *67,450	*38 250 *83,000	33 400 71,900	*30 400 *65,800	24 100 51,850	*24 550 *52,900	18 650 40,200	*22 100 *48,700	17 000 37,450	9640 31'7"
-1500 mm -5'0"	kg lb	*60,950	*60,950	*42 500 *92,700	*42 500 *92,700	*35 000 *75,900	33 400 71,800	*28 050 *60,600	24 000 51,700	*21 700	18 700	*21 400 *47,100	18 550 40,950	9060 29'8"
-3000 mm -10'0"	kg lb			*35 000 *76,000	*35 000 *76,000	*29 400 *63,400	*29 400 *63,400	*23 150 *49,350	*23 150 *49,350			*19 850 *43,550	*19 850 *43,550	8170 26'7"
-4500 mm -15'0"	kg lb					*19 800 *41,400	*19 800 *41,400					*16 500 *38,450	*16 500 *38,450	6740 21'0"



ISO 10567:2007



*Indicates that the load is limited by hydraulic lifting capacity rather than tipping load. The above loads are in compliance with hydraulic excavator lift capacity standard ISO 10567:2007. They do not exceed 87% of hydraulic lifting capacity or 75% of tipping load. Weight of all lifting accessories must be deducted from the above lifting capacities. Lifting capacities are based on the machine standing on a firm, uniform supporting surface. The use of a work tool attachment point to handle/lift objects, could affect the machine lift performance.

**Lift capacities apply to both standard counterweight and counterweight with removal device.

Lift capacity stays with ±5% for all available track shoes.

Always refer to the appropriate Operation and Maintenance Manual for specific product information.

395 Hydraulic Excavator Specifications

Mass Boom Lift Capacities – Standard Counterweight** – without Bucket

Long Variable Gauge Undercarriage

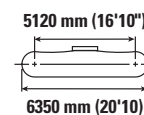
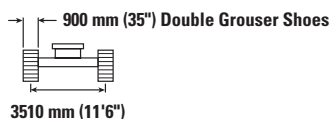
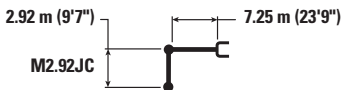

Boom Length mm ft/in	Unit	3000 mm/10'0"		4500 mm/15'0"		6000 mm/20'0"		7500 mm/25'0"		9000 mm/30'0"		mm ft/in	
		kg lb	kg lb	kg lb	kg lb	kg lb	kg lb	kg lb	kg lb	kg lb	kg lb	kg lb	kg lb
10 500 mm 35'0"	kg lb											*21 300 *21 300	6290
9000 mm 30'0"	kg lb							*23 050 *45,100	*23 050 *45,100			*19 250 *42,700	*19 250 *42,700 7820 25'2"
7500 mm 25'0"	kg lb							*25 750 *56,150	*25 750 *56,150			*18 450 *40,750	*18 450 *40,750 8830 28'8"
6000 mm 20'0"	kg lb			*42 050 *90,050	*42 050 *90,050	*32 250 *69,650	*32 250 *69,650	*27 100 *58,800	*27 100 *58,800	*24 000 *52,350	20 700 44,400	*18 400 *40,450	*18 400 *40,450 9500 31'0"
4500 mm 15'0"	kg lb					*35 950 *77,550	*35 950 *77,550	*28 850 *62,500	26 650 57,400	*24 700 *53,650	20 150 43,400	*18 850 *41,400	17 350 38,350 9890 32'4"
3000 mm 10'0"	kg lb					*38 750 *83,750	35 500 76,500	*30 400 *65,800	25 600 55,150	*25 300 *54,900	19 600 42,200	*19 800 *43,550	16 650 36,650 10 040 32'11"
1500 mm 5'0"	kg lb					*39 550 *85,750	34 300 73,850	*31 050 *67,200	24 800 53,450	*25 400 *55,050	19 150 41,200	*21 450 *47,200	16 550 36,500 9960 32'8"
0 mm 0'0"	kg lb			*28 950 *67,450	*28 950 *67,450	*38 250 *83,000	33 800 72,650	*30 400 *65,800	24 350 52,450	*24 550 *52,900	18 850 40,650	*22 100 *48,700	17 200 37,900 9640 31'7"
-1500 mm -5'0"	kg lb	*60,950	*60,950	*42 500 *92,700	*42 500 *92,700	*35 000 *75,900	33 750 72,600	*28 050 *60,600	24 250 52,250	*21 700	18 900	*21 400 *47,100	18 750 41,400 9060 29'8"
-3000 mm -10'0"	kg lb			*35 000 *76,000	*35 000 *76,000	*29 400 *63,400	*29 400 *63,400	*23 150 *49,350	*23 150 *49,350			*19 850 *43,550	*19 850 *43,550 8170 26'7"
-4500 mm -15'0"	kg lb					*19 800 *41,400	*19 800 *41,400					*16 500 *38,450	*16 500 *38,450 6740 21'0"



ISO 10567:2007



*Indicates that the load is limited by hydraulic lifting capacity rather than tipping load. The above loads are in compliance with hydraulic excavator lift capacity standard ISO 10567:2007. They do not exceed 87% of hydraulic lifting capacity or 75% of tipping load. Weight of all lifting accessories must be deducted from the above lifting capacities. Lifting capacities are based on the machine standing on a firm, uniform supporting surface. The use of a work tool attachment point to handle/lift objects, could affect the machine lift performance.

**Lift capacities apply to both standard counterweight and counterweight with removal device.

Lift capacity stays with ±5% for all available track shoes.

Always refer to the appropriate Operation and Maintenance Manual for specific product information.

395 Hydraulic Excavator Specifications

Mass Boom Lift Capacities – Standard Counterweight** – without Bucket

Long Variable Gauge Undercarriage

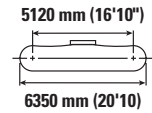
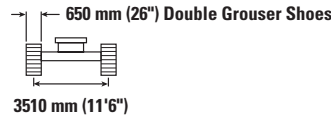
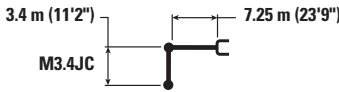

		3000 mm/10'0"		4500 mm/15'0"		6000 mm/20'0"		7500 mm/25'0"		9000 mm/30'0"		mm ft/in		
10 500 mm 35'0"	kg lb											*17 450 *39,000	*17 450 *39,000	6970 22'2"
9000 mm 30'0"	kg lb							*21 850 *46,150	*21 850 *46,150			*15 950 *35,350	*15 950 *35,350	8370 27'1"
7500 mm 25'0"	kg lb							*24 500 *53,350	*24 500 *53,350	*19 100 *37,350	*19 100 *37,350	*15 350 *33,900	*15 350 *33,900	9330 30'4"
6000 mm 20'0"	kg lb					*30 650 *66,200	*30 650 *66,200	*25 950 *56,350	*25 950 *56,350	*23 100 *50,300	*20 400 43,850	*15 300 *33,650	*15 300 *33,650	9960 32'6"
4500 mm 15'0"	kg lb			*47 700 *102,250	*47 700 *102,250	*34 500 *74,450	*34 500 *74,450	*27 900 *60,450	26 300 56,700	*23 950 *52,050	19 800 42,650	*15 600 *34,350	*15 600 *34,350	10 330 33'10"
3000 mm 10'0"	kg lb					*37 800 *81,650	35 150 75,750	*29 700 *64,300	25 200 54,300	*24 800 *53,800	19 200 41,300	*16 400 *36,000	15 200 33,500	10 480 34'4"
1500 mm 5'0"	kg lb					*39 300 *85,050	33 700 72,600	*30 700 *66,500	24 300 52,350	*25 200 *54,550	18 650 40,200	*17 650 *38,800	15 100 33,300	10 400 34'1"
0 mm 0'0"	kg lb			*30 950 *71,500	*30 950 *71,500	*38 700 *83,900	33 000 71,000	*30 500 *66,050	23 750 51,100	*24 750 *53,450	18 300 39,450	*19 700 *43,350	15 600 34,400	10 100 33'1"
-1500 mm -5'0"	kg lb	*26 100 *58,850	*26 100 *58,850	*45 400 *98,800	*45 400 *98,800	*36 100 *78,250	32 850 70,600	*28 750 *62,150	23 550 50,700	*22 850 *48,950	18 250 39,300	*20 550 *45,250	16 850 37,250	9550 31'3"
-3000 mm -10'0"	kg lb	*42 800 *96,600	*42 800 *96,600	*38 450 *83,350	*38 450 *83,350	*31 300 *67,650	*31 300 *67,650	*24 900 *53,300	23 700 51,100			*19 450 *42,750	19 400 *42,750	8700 28'4"
-4500 mm -15'0"	kg lb			*28 150 *60,300	*28 150 *60,300	*23 250 *49,350	*23 250 *49,350					*16 800 *36,600	*16 800 *36,600	7450 24'2"



ISO 10567:2007



*Indicates that the load is limited by hydraulic lifting capacity rather than tipping load. The above loads are in compliance with hydraulic excavator lift capacity standard ISO 10567:2007. They do not exceed 87% of hydraulic lifting capacity or 75% of tipping load. Weight of all lifting accessories must be deducted from the above lifting capacities. Lifting capacities are based on the machine standing on a firm, uniform supporting surface. The use of a work tool attachment point to handle/lift objects, could affect the machine lift performance.

**Lift capacities apply to both standard counterweight and counterweight with removal device.

Lift capacity stays with ±5% for all available track shoes.

Always refer to the appropriate Operation and Maintenance Manual for specific product information.

395 Hydraulic Excavator Specifications

Mass Boom Lift Capacities – Standard Counterweight** – without Bucket

Long Variable Gauge Undercarriage

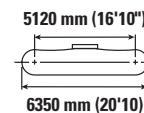
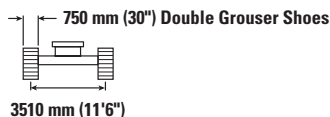

Boom Length	Unit	3000 mm/10'0"		4500 mm/15'0"		6000 mm/20'0"		7500 mm/25'0"		9000 mm/30'0"		mm ft/in		
		kg	lb	kg	lb	kg	lb	kg	lb	kg	lb	mm	ft/in	
10 500 mm 35'0"	kg lb											*17 450 *39,000	*17 450 *39,000	6970 22'2"
9000 mm 30'0"	kg lb							*21 850 *46,150	*21 850 *46,150			*15 950 *35,350	*15 950 *35,350	8370 27'1"
7500 mm 25'0"	kg lb							*24 500 *53,350	*24 500 *53,350	*19 100 *37,350	*19 100 *37,350	*15 350 *33,900	*15 350 *33,900	9330 30'4"
6000 mm 20'0"	kg lb					*30 650 *66,200	*30 650 *66,200	*25 950 *56,350	*25 950 *56,350	*23 100 *50,300	20 600 44,250	*15 300 *33,650	*15 300 *33,650	9960 32'6"
4500 mm 15'0"	kg lb			*47 700 *102,250	*47 700 *102,250	*34 500 *74,450	*34 500 *74,450	*27 900 *60,450	26 550 57,200	*23 950 *52,050	20 000 43,050	*15 600 *34,350	*15 600 *34,350	10 330 33'10"
3000 mm 10'0"	kg lb					*37 800 *81,650	35 450 76,400	*29 700 *64,300	25 400 54,750	*24 800 *53,800	19 350 41,700	*16 400 *36,000	15 350 33,850	10 480 34'4"
1500 mm 5'0"	kg lb					*39 300 *85,050	34 000 73,250	*30 700 *66,500	24 500 52,800	*25 200 *54,550	18 850 40,550	*17 650 *38,800	15 250 33,600	10 400 34'1"
0 mm 0'0"	kg lb			*30 950 *71,500	*30 950 *71,500	*38 700 *83,900	33 300 71,650	*30 500 *66,050	23 950 51,600	*24 750 *53,450	18 500 39,850	*19 700 *43,350	15 750 34,750	10 100 33'1"
-1500 mm -5'0"	kg lb	*26 100 *58,850	*26 100 *58,850	*45 400 *98,800	*45 400 *98,800	*36 100 *78,250	33 150 71,250	*28 750 *62,150	23 750 51,150	*22 850 *48,950	18 400 39,700	*20 550 *45,250	17 050 37,600	9550 31'3"
-3000 mm -10'0"	kg lb	*42 800 *96,600	*42 800 *96,600	*38 450 *83,350	*38 450 *83,350	*31 300 *67,650	*31 300 *67,650	*24 900 *53,300	23 950 51,600			*19 450 *42,750	*19 450 *42,750	8700 28'4"
-4500 mm -15'0"	kg lb			*28 150 *60,300	*28 150 *60,300	*23 250 *49,350	*23 250 *49,350					*16 800 *36,600	*16 800 *36,600	7450 24'2"



ISO 10567:2007



*Indicates that the load is limited by hydraulic lifting capacity rather than tipping load. The above loads are in compliance with hydraulic excavator lift capacity standard ISO 10567:2007. They do not exceed 87% of hydraulic lifting capacity or 75% of tipping load. Weight of all lifting accessories must be deducted from the above lifting capacities. Lifting capacities are based on the machine standing on a firm, uniform supporting surface. The use of a work tool attachment point to handle/lift objects, could affect the machine lift performance.

**Lift capacities apply to both standard counterweight and counterweight with removal device.

Lift capacity stays with ±5% for all available track shoes.

Always refer to the appropriate Operation and Maintenance Manual for specific product information.

395 Hydraulic Excavator Specifications

Mass Boom Lift Capacities – Standard Counterweight** – without Bucket

Long Variable Gauge Undercarriage

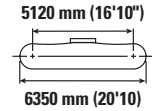
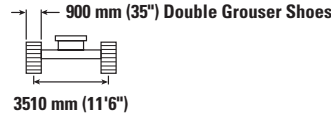
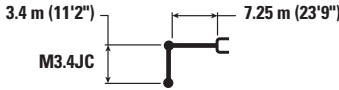

Boom Length	Unit	3000 mm/10'0"		4500 mm/15'0"		6000 mm/20'0"		7500 mm/25'0"		9000 mm/30'0"		mm ft/in		
		kg lb	kg lb	kg lb	kg lb	kg lb	kg lb	kg lb	kg lb	kg lb	kg lb	kg lb	mm ft/in	
10 500 mm 35'0"	kg lb											*17 450 *39,000	*17 450 *39,000	6970 22'2"
9000 mm 30'0"	kg lb							*21 850 *46,150	*21 850 *46,150			*15 950 *35,350	*15 950 *35,350	8370 27'1"
7500 mm 25'0"	kg lb							*24 500 *53,350	*24 500 *53,350	*19 100 *37,350	*19 100 *37,350	*15 350 *33,900	*15 350 *33,900	9330 30'4"
6000 mm 20'0"	kg lb					*30 650 *66,200	*30 650 *66,200	*25 950 *56,350	*25 950 *56,350	*23 100 *50,300	*20 800 44,700	*15 300 *33,650	*15 300 *33,650	9960 32'6"
4500 mm 15'0"	kg lb			*47 700 *102,250	*47 700 *102,250	*34 500 *74,450	*34 500 *74,450	*27 900 *60,450	26 800 57,750	*23 950 *52,050	20 200 43,500	*15 600 *34,350	*15 600 *34,350	10 330 33'10"
3000 mm 10'0"	kg lb					*37 800 *81,650	35 800 77,150	*29 700 *64,300	25 700 55,350	*24 800 *53,800	19 600 42,150	*16 400 *36,000	15 500 34,200	10 480 34'4"
1500 mm 5'0"	kg lb					*39 300 *85,050	34 400 74,050	*30 700 *66,500	24 800 53,400	*25 200 *54,550	19 050 41,000	*17 650 *38,800	15 450 34,000	10 400 34'1"
0 mm 0'0"	kg lb			*30 950 *71,500	*30 950 *71,500	*38 700 *83,900	33 650 72,450	*30 500 *66,050	24 250 52,200	*24 750 *53,450	18 700 40,300	*19 700 *43,350	15 950 35,150	10 100 33'1"
-1500 mm -5'0"	kg lb	*26 100 *58,850	*26 100 *58,850	*45 400 *98,800	*45 400 *98,800	*36 100 *78,250	33 500 72,050	*28 750 *62,150	24 050 51,750	*22 850 *48,950	18 600 40,150	*20 550 *45,250	17 250 38,050	9550 31'3"
-3000 mm -10'0"	kg lb	*42 800 *96,600	*42 800 *96,600	*38 450 *83,350	*38 450 *83,350	*31 300 *67,650	*31 300 *67,650	*24 900 *53,300	24 200 52,150			*19 450 *42,750	*19 450 *42,750	8700 28'4"
-4500 mm -15'0"	kg lb			*28 150 *60,300	*28 150 *60,300	*23 250 *49,350	*23 250 *49,350					*16 800 *36,600	*16 800 *36,600	7450 24'2"



ISO 10567:2007



*Indicates that the load is limited by hydraulic lifting capacity rather than tipping load. The above loads are in compliance with hydraulic excavator lift capacity standard ISO 10567:2007. They do not exceed 87% of hydraulic lifting capacity or 75% of tipping load. Weight of all lifting accessories must be deducted from the above lifting capacities. Lifting capacities are based on the machine standing on a firm, uniform supporting surface. The use of a work tool attachment point to handle/lift objects, could affect the machine lift performance.

**Lift capacities apply to both standard counterweight and counterweight with removal device.

Lift capacity stays with ±5% for all available track shoes.

Always refer to the appropriate Operation and Maintenance Manual for specific product information.

395 Hydraulic Excavator Specifications

Bucket Specifications and Compatibility – Australia and New Zealand

	Linkage	Width		Capacity		Weight		Fill %	GP Boom GP3.4 (11'2")	Mass Boom	
		mm	in	m ³	yd ³	kg	lb			M2.92 (9'7")	M3.4 (11'2")
Pin-On (No Quick Coupler)											
General Duty	JC	2800	110	7.00	9.15	6508	14,347	100	◇	⊖	○
Heavy Duty	JC	2650	104	6.60	8.63	6564	14,470	100	◇	⊖	○
Severe Duty	JC	2722	106	6.50	8.50	7380	16,269	90	◇	⊖	⊖
	JC	2700	106	7.10	9.29	7476	16,481	90	X	⊖	○
Severe Duty – Spade Edge	JC	2300	91	5.40	7.06	6618	14,590	90	○	●	⊙
	JC	2500	98	6.00	7.85	7113	15,681	90	◇	⊙	⊖
	JC	2650	104	6.50	8.50	7365	16,236	90	◇	⊖	⊖
Maximum load with pin-on (payload + bucket)								kg	12 581	17 340	15 964
								lb	27,735	38,229	35,195

The above loads are in compliance with hydraulic excavator standard EN474-5:2006+A3:2013, they do not exceed 87% of hydraulic lifting capacity or 75% of tipping capacity with front linkage fully extended at ground line with bucket curled.

Capacity based on ISO 7451:2007.

Maximum Material Density:

- 2100 kg/m³ (3,500 lb/yd³)
- ⊙ 1800 kg/m³ (3,000 lb/yd³)
- ⊖ 1500 kg/m³ (2,500 lb/yd³)
- 1200 kg/m³ (2,000 lb/yd³)
- ◇ 900 kg/m³ (1,500 lb/yd³)
- X Not Recommended

Caterpillar recommends using appropriate work tools to maximize the value customers receive from our products. Use of work tools, including buckets, which are outside of Caterpillar's recommendations or specifications for weight, dimensions, flows, pressures, etc. may result in less-than-optimal performance, including but not limited to reductions in production, stability, reliability, and component durability. Improper use of a work tool resulting in sweeping, prying, twisting and/or catching of heavy loads will reduce the life of the boom and stick.

395 Hydraulic Excavator Specifications

Bucket Specifications and Compatibility – Europe

	Linkage	Width		Capacity		Weight		Fill	Standard Counterweight						
		mm	in	m ³	yd ³	kg	lb		Reach Boom		GP Boom			Mass Boom	
									R4.4 (14'5")	R5.5 (18'1")	R4.4 (14'5")	R5.5 (18'1")	GP3.4 (11'2")	M2.92 (9'7")	M3.4 (11'2")
Pin-On (No Quick Coupler)															
General Duty	HB2	1150	45	2.20	2.88	2870	6,327	100	●	●	●	●			
	HB2	1450	57	2.90	3.79	3200	7,054	100	⊙	⊖	●	●			
	HB2	1750	69	3.70	4.84	3664	8,078	100	○	◇	●	⊙			
	HB2	2050	81	4.60	6.02	4046	8,920	100	◇	X	⊙	○			
Heavy Duty	HB2	2050	81	4.60	6.02	4169	9,191	100	◇	X	⊖	○			
Severe Duty	HB2	2200	87	5.20	6.80	4895	10,791	90	X	X	⊖	◇			
Heavy Duty	JC	1800	71	4.10	5.36	4922	10,851	100					⊙	●	●
	Severe Duty	JC	2722	106	6.50	8.50	7380	16,269	90					◇	⊖
Severe Duty – Spade Edge	JC	2700	106	7.10	9.29	7476	16,481	90					X	⊖	○
	JC	2400	94	5.70	7.46	6823	15,042	90					◇	●	⊙
	JC	2500	98	6.00	7.85	7113	15,681	90					◇	⊙	⊖
Severe Duty – Spade Edge	JC	2650	104	6.50	8.50	7365	16,236	90					◇	⊖	⊖
	Extreme Duty	JC	2800	110	6.30	8.25	8918	19,578	90					X	⊖
Extreme Duty – Spade Edge	JC	2200	87	5.00	6.54	7170	15,807	90					○	●	⊙
	JC	2350	93	5.40	7.06	7513	16,564	90					◇	●	⊙
	JC	2500	98	5.70	7.46	7745	17,075	90					◇	⊙	⊖
Maximum load with pin-on (payload + bucket)								kg	8789	7460	11 931	10 183	12 581	17 340	15 964
								lb	19,376	16,446	26,304	22,449	27,735	38,229	35,195
Pin Grabber Coupler															
General Duty	HB2	1150	45	2.20	2.88	2870	6,327	100	⊙	○	●	●			
	HB2	1450	57	2.90	3.79	3200	7,054	100	○	◇	●	⊙			
	HB2	1750	69	3.70	4.84	3664	8,078	100	◇	X	⊙	○			
	HB2	2050	81	4.60	6.02	4046	8,920	100	X	X	○	◇			
Heavy Duty	HB2	2050	81	4.60	6.02	4169	9,191	100	X	X	○	◇			
Severe Duty	HB2	2200	87	5.20	6.80	4895	10,791	90	X	X	◇	X			
Maximum load with coupler (payload + bucket)								kg	7063	5734	10 205	8457	10 855	15 614	14 239
								lb	15,571	12,641	22,499	18,644	23,931	34,424	31,391
CW 70 Coupler															
General Duty	HB2	2050	81	4.60	6.02	4092	9,021	100	X	X	y	◇			
Severe Duty	HB2	1850	73	4.22	5.52	4335	9,557	90	X	X	y	○			
Severe Duty – Spade Edge	JC	2150	85	5.00	6.54	6081	13,407	90					○	●	⊙
	JC	2300	91	5.40	7.06	6373	14,050	90					◇	●	⊙
	JC	2400	94	5.70	7.46	6577	14,500	90					◇	⊙	⊖
Extreme Duty	JC	2350	93	5.40	7.06	7730	17,042	90					X	⊙	⊖
Maximum load with coupler (payload + bucket)								kg	7572	6243	10 714	8966	11 364	16 123	14 747
								lb	16,693	13,763	23,621	19,766	25,052	35,546	32,512

The above loads are in compliance with hydraulic excavator standard EN474-5:2006+A3:2013, they do not exceed 87% of hydraulic lifting capacity or 75% of tipping capacity with front linkage fully extended at ground line with bucket curled.

Capacity based on ISO 7451:2007.

Maximum Material Density:

- 2100 kg/m³ (3,500 lb/yd³)
- ⊙ 1800 kg/m³ (3,000 lb/yd³)
- ⊖ 1500 kg/m³ (2,500 lb/yd³)
- 1200 kg/m³ (2,000 lb/yd³)
- ◇ 900 kg/m³ (1,500 lb/yd³)
- X Not Recommended

Caterpillar recommends using appropriate work tools to maximize the value customers receive from our products. Use of work tools, including buckets, which are outside of Caterpillar's recommendations or specifications for weight, dimensions, flows, pressures, etc. may result in less-than-optimal performance, including but not limited to reductions in production, stability, reliability, and component durability. Improper use of a work tool resulting in sweeping, prying, twisting and/or catching of heavy loads will reduce the life of the boom and stick.

395 Hydraulic Excavator Specifications

Bucket Specifications and Compatibility – Europe (continued)

	Linkage	Width		Capacity		Weight		Fill	Removeable Counterweight						
		mm	in	m ³	yd ³	kg	lb		Reach Boom		GP Boom			Mass Boom	
									R4.4 (14'5")	R5.5 (18'1")	R4.4 (14'5")	R5.5 (18'1")	GP3.4 (11'2")	M2.92 (9'7")	M3.4 (11'2")
Pin-On (No Quick Coupler)															
General Duty	HB2	1150	45	2.20	2.88	2870	6,327	100	●	●	●	●			
	HB2	1450	57	2.90	3.79	3200	7,054	100	⊙	⊖	●	●			
	HB2	1750	69	3.70	4.84	3664	8,078	100	○	◇	●	⊙			
	HB2	2050	81	4.60	6.02	4046	8,920	100	◇	X	⊙	○			
Heavy Duty	HB2	2050	81	4.60	6.02	4169	9,191	100	◇	X	⊖	○			
Severe Duty	HB2	2200	87	5.20	6.80	4895	10,791	90	X	X	⊖	◇			
Heavy Duty	JC	1800	71	4.10	5.36	4922	10,851	100					⊙	●	●
	Severe Duty	JC	2722	106	6.50	8.50	7380	16,269	90					◇	⊖
Severe Duty – Spade Edge	JC	2700	106	7.10	9.29	7476	16,481	90					X	⊖	○
	JC	2400	94	5.70	7.46	6823	15,042	90					◇	●	⊙
	JC	2500	98	6.00	7.85	7113	15,681	90					◇	⊙	⊖
Severe Duty – Spade Edge	JC	2650	104	6.50	8.50	7365	16,236	90					◇	⊖	⊖
	Extreme Duty	JC	2800	110	6.30	8.25	8918	19,578	90					X	⊖
Extreme Duty – Spade Edge	JC	2200	87	5.00	6.54	7170	15,807	90					○	●	⊙
	JC	2350	93	5.40	7.06	7513	16,564	90					◇	●	⊙
	JC	2500	98	5.70	7.46	7745	17,075	90					◇	⊙	⊖
Maximum load with pin-on (payload + bucket)								kg	8793	7463	11936	10 187	12 585	17 346	15 970
								lb	19,385	16,454	26,313	22,457	27,746	38,242	35,208
Pin Grabber Coupler															
General Duty	HB2	1150	45	2.20	2.88	2870	6,327	100	⊙	○	●	●			
	HB2	1450	57	2.90	3.79	3200	7,054	100	○	◇	●	⊙			
	HB2	1750	69	3.70	4.84	3664	8,078	100	◇	X	⊙	○			
	HB2	2050	81	4.60	6.02	4046	8,920	100	X	X	○	◇			
Heavy Duty	HB2	2050	81	4.60	6.02	4169	9,191	100	X	X	○	◇			
Severe Duty	HB2	2200	87	5.20	6.80	4895	10,791	90	X	X	◇	X			
Maximum load with coupler (payload + bucket)								kg	7067	5737	10 210	8461	10 860	15 620	14 244
								lb	15,580	12,649	22,509	18,653	23,941	34,437	31,403
CW 70 Coupler															
General Duty	HB2	2050	81	4.60	6.02	4092	9,021	100	X	X	⊖	◇			
Severe Duty	HB2	1850	73	4.22	5.52	4335	9,557	90	X	X	⊖	○			
Severe Duty – Spade Edge	JC	2150	85	5.00	6.54	6081	13,407	90					○	●	⊙
	JC	2300	91	5.40	7.06	6373	14,050	90					◇	●	⊙
	JC	2400	94	5.70	7.46	6577	14,500	90					◇	⊙	⊖
Extreme Duty	JC	2350	93	5.40	7.06	7730	17,042	90					X	⊙	⊖
Maximum load with coupler (payload + bucket)								kg	7576	6246	10 719	8970	11 368	16 129	14 753
								lb	16,702	13,771	23,630	19,774	25,063	35,559	32,525

The above loads are in compliance with hydraulic excavator standard EN474-5:2006+A3:2013, they do not exceed 87% of hydraulic lifting capacity or 75% of tipping capacity with front linkage fully extended at ground line with bucket curled.

Capacity based on ISO 7451:2007.

Maximum Material Density:

- 2100 kg/m³ (3,500 lb/yd³)
- ⊙ 1800 kg/m³ (3,000 lb/yd³)
- ⊖ 1500 kg/m³ (2,500 lb/yd³)
- 1200 kg/m³ (2,000 lb/yd³)
- ◇ 900 kg/m³ (1,500 lb/yd³)
- X Not Recommended

Caterpillar recommends using appropriate work tools to maximize the value customers receive from our products. Use of work tools, including buckets, which are outside of Caterpillar's recommendations or specifications for weight, dimensions, flows, pressures, etc. may result in less-than-optimal performance, including but not limited to reductions in production, stability, reliability, and component durability. Improper use of a work tool resulting in sweeping, prying, twisting and/or catching of heavy loads will reduce the life of the boom and stick.

395 Hydraulic Excavator Specifications

Bucket Specifications and Compatibility – North America

	Linkage	Width		Capacity		Weight		Fill	Standard Counterweight								
		mm	in	m ³	yd ³	kg	lb		Reach Boom		GP Boom				Mass Boom		
									R4.4 (14'5")	R5.5 (18'1")	R4.4 (14'5")	R5.5 (18'1")	GP2.92 (9'7")	GP3.4 (11'2")	M2.92 (9'7")	M3.4 (11'2")	
Pin-On (No Quick Coupler)																	
General Duty	HB2	1750	69	3.90	5.10	3812	8,404	100	○	◇	●	⊖					
	HB2	2000	79	4.60	6.02	4175	9,205	100	◇	X	⊖	○					
General Duty – Extra Large	HB2	2050	81	5.30	6.93	4420	9,745	100	X	X	○	◇					
Severe Duty	HB2	1150	45	2.30	3.00	3279	7,228	90	●	●	●	●					
	HB2	1450	57	3.00	3.92	3729	8,221	90	⊙	○	●	●					
	HB2	1750	69	3.90	5.10	4150	9,149	90	○	◇	●	⊙					
	HB2	1850	73	4.20	5.50	4371	9,637	90	○	X	●	⊖					
	HB2	2000	79	4.60	6.02	4537	10,003	90	◇	X	⊙	○					
	HB2	2150	85	5.00	6.50	4826	10,639	90	◇	X	⊖	○					
	HB2	2200	87	5.20	6.80	4895	10,791	90	X	X	⊖	◇					
General Duty	JC	2350	93	5.70	7.45	5824	12,839	100					○	○	●	⊙	
	JC	2450	96	6.00	7.84	6006	13,240	100					○	◇	⊙	⊖	
	JC	2600	102	6.50	8.50	6237	13,749	100					◇	◇	⊖	⊖	
Heavy Duty	JC	1800	71	4.10	5.36	4922	10,851	100					●	⊙	●	●	
	JC	2450	96	6.00	7.85	6123	13,498	100					○	◇	⊙	⊖	
Severe Duty	JC	2722	106	6.50	8.50	7380	16,269	90					◇	◇	⊖	⊖	
	JC	2700	106	7.10	9.29	7476	16,481	90					◇	X	⊖	○	
Severe Duty – Spade Edge	JC	2300	91	5.40	7.06	6618	14,590	90					⊖	○	●	⊙	
	JC	2500	98	6.00	7.85	7113	15,681	90					○	◇	⊙	⊖	
	JC	2650	104	6.50	8.50	7365	16,236	90					◇	◇	⊖	⊖	
Extreme Duty – Spade Edge	JC	2350	93	5.40	7.06	7513	16,564	90					○	◇	●	⊙	
	JC	2200	87	5.00	6.54	7650	16,866	90					○	◇	●	⊙	
Maximum load with pin-on (payload + bucket)								kg	8789	7460	11 931	10 183	13 634	12 581	17 340	15 964	
								lb	19,376	16,446	26,304	22,449	30,059	27,735	38,229	35,195	
Pin Grabber Coupler																	
General Duty	HB2	1750	69	3.90	5.10	3812	8,404	100	X	X	⊖	○					
	HB2	2000	79	4.60	6.02	4175	9,205	100	X	X	○	◇					
Severe Duty	HB2	1150	45	2.30	3.00	3279	7,228	90	⊙	○	●	●					
	HB2	1450	57	3.00	3.92	3729	8,221	90	○	X	●	⊙					
	HB2	1750	69	3.90	5.10	4150	9,149	90	X	X	⊙	○					
	HB2	1850	73	4.20	5.50	4371	9,637	90	X	X	⊖	◇					
	HB2	2000	79	4.60	6.02	4537	10,003	90	X	X	○	◇					
	HB2	2150	85	5.00	6.50	4826	10,639	90	X	X	○	X					
	HB2	2200	87	5.20	6.80	4895	10,791	90	X	X	◇	X					
	Maximum load with coupler (payload + bucket)								kg	7063	5734	10 205	8457	11 909	10 855	15 614	14 239
								lb	15,571	12,641	22,499	18,644	26,254	23,931	34,424	31,391	

The above loads are in compliance with hydraulic excavator standard EN474-5:2006+A3:2013, they do not exceed 87% of hydraulic lifting capacity or 75% of tipping capacity with front linkage fully extended at ground line with bucket curled.

Capacity based on ISO 7451:2007.

Maximum Material Density:

- 2100 kg/m³ (3,500 lb/yd³)
- ⊙ 1800 kg/m³ (3,000 lb/yd³)
- ⊖ 1500 kg/m³ (2,500 lb/yd³)
- 1200 kg/m³ (2,000 lb/yd³)
- ◇ 900 kg/m³ (1,500 lb/yd³)
- X Not Recommended

Caterpillar recommends using appropriate work tools to maximize the value customers receive from our products. Use of work tools, including buckets, which are outside of Caterpillar's recommendations or specifications for weight, dimensions, flows, pressures, etc. may result in less-than-optimal performance, including but not limited to reductions in production, stability, reliability, and component durability. Improper use of a work tool resulting in sweeping, prying, twisting and/or catching of heavy loads will reduce the life of the boom and stick.

395 Hydraulic Excavator Specifications

Bucket Specifications and Compatibility – North America (continued)

	Linkage	Width		Capacity		Weight		Fill	Removeable Counterweight								
		mm	in	m ³	yd ³	kg	lb		%	Reach Boom		GP Boom				Mass Boom	
										R4.4 (14'5")	R5.5 (18'1")	GP2.92 (9'7")	GP3.4 (11'2")	R4.4 (14'5")	R5.5 (18'1")	M2.92 (9'7")	M3.4 (11'2")
Pin-On (No Quick Coupler)																	
General Duty	HB2	1750	69	3.90	5.10	3812	8,404	100	○	◇	●	⊖					
	HB2	2000	79	4.60	6.02	4175	9,205	100	◇	X	⊖	○					
General Duty – Extra Large	HB2	2050	81	5.30	6.93	4420	9,745	100	X	X	○	◇					
Severe Duty	HB2	1150	45	2.30	3.00	3279	7,228	90	●	●	●	●					
	HB2	1450	57	3.00	3.92	3729	8,221	90	⊙	○	●	●					
	HB2	1750	69	3.90	5.10	4150	9,149	90	○	◇	●	⊙					
	HB2	1850	73	4.20	5.50	4371	9,637	90	○	X	●	⊖					
	HB2	2000	79	4.60	6.02	4537	10,003	90	◇	X	⊙	○					
	HB2	2150	85	5.00	6.50	4826	10,639	90	◇	X	⊖	○					
	HB2	2200	87	5.20	6.80	4895	10,791	90	X	X	⊖	◇					
General Duty	JC	2350	93	5.70	7.45	5824	12,839	100					○	○	●	⊙	
	JC	2450	96	6.00	7.84	6006	13,240	100					○	◇	⊙	⊖	
	JC	2600	102	6.50	8.50	6237	13,749	100					◇	◇	⊖	⊖	
Heavy Duty	JC	1800	71	4.10	5.36	4922	10,851	100					●	⊙	●	●	
	JC	2450	96	6.00	7.85	6123	13,498	100					○	◇	⊙	⊖	
Severe Duty	JC	2722	106	6.50	8.50	7380	16,269	90					◇	◇	⊖	⊖	
	JC	2700	106	7.10	9.29	7476	16,481	90					◇	X	⊖	○	
Severe Duty – Spade Edge	JC	2300	91	5.40	7.06	6618	14,590	90					⊖	○	●	⊙	
	JC	2500	98	6.00	7.85	7113	15,681	90					○	◇	⊙	⊖	
	JC	2650	104	6.50	8.50	7365	16,236	90					◇	◇	⊖	⊖	
Extreme Duty – Spade Edge	JC	2350	93	5.40	7.06	7513	16,564	90					○	◇	●	⊙	
	JC	2200	87	5.00	6.54	7650	16,866	90					○	◇	●	⊙	
Maximum load with pin-on (payload + bucket)								kg	8793	7463	11 936	10 187	13 640	12 585	17 346	15 970	
								lb	19,385	16,454	26,313	22,457	30,070	27,746	38,242	35,208	
Pin Grabber Coupler																	
General Duty	HB2	1750	69	3.90	5.10	3812	8,404	100	X	X	⊖	○					
	HB2	2000	79	4.60	6.02	4175	9,205	100	X	X	○	◇					
Severe Duty	HB2	1150	45	2.30	3.00	3279	7,228	90	⊙	○	●	●					
	HB2	1450	57	3.00	3.92	3729	8,221	90	○	X	●	⊙					
	HB2	1750	69	3.90	5.10	4150	9,149	90	X	X	⊙	○					
	HB2	1850	73	4.20	5.50	4371	9,637	90	X	X	⊖	◇					
	HB2	2000	79	4.60	6.02	4537	10,003	90	X	X	○	◇					
	HB2	2150	85	5.00	6.50	4826	10,639	90	X	X	○	X					
	HB2	2200	87	5.20	6.80	4895	10,791	90	X	X	◇	X					
	Maximum load with coupler (payload + bucket)								kg	7067	5737	10 210	8461	11 914	10 860	15 620	14 244
								lb	15,580	12,649	22,509	18,653	26,265	23,941	34,437	31,403	

The above loads are in compliance with hydraulic excavator standard EN474-5:2006+A3:2013, they do not exceed 87% of hydraulic lifting capacity or 75% of tipping capacity with front linkage fully extended at ground line with bucket curled.

Capacity based on ISO 7451:2007.

Maximum Material Density:

- 2100 kg/m³ (3,500 lb/yd³)
- ⊙ 1800 kg/m³ (3,000 lb/yd³)
- ⊖ 1500 kg/m³ (2,500 lb/yd³)
- 1200 kg/m³ (2,000 lb/yd³)
- ◇ 900 kg/m³ (1,500 lb/yd³)
- X Not Recommended

Caterpillar recommends using appropriate work tools to maximize the value customers receive from our products. Use of work tools, including buckets, which are outside of Caterpillar's recommendations or specifications for weight, dimensions, flows, pressures, etc. may result in less-than-optimal performance, including but not limited to reductions in production, stability, reliability, and component durability. Improper use of a work tool resulting in sweeping, prying, twisting and/or catching of heavy loads will reduce the life of the boom and stick.

395 Hydraulic Excavator Specifications

Bucket Specifications and Compatibility – South Korea

	Linkage	Width		Capacity		Weight		Fill	Mass Boom
		mm	in	m ³	yd ³	kg	lb	%	M2.92 (9'7")
Pin-On (No Quick Coupler)									
General Duty	JC	2550	100	6.00	7.65	6042	13,320	100	⊙
	JC	2600	102	6.50	8.50	6237	13,749	100	⊖
	JC	2800	110	7.00	9.15	6508	14,347	100	⊖
Heavy Duty	JC	2450	96	6.00	7.85	6123	13,498	100	⊙
	JC	2650	104	6.60	8.63	6564	14,470	100	⊖
Severe Duty	JC	2722	106	6.50	8.50	7380	16,269	90	⊖
Extreme Duty	JC	2800	110	6.30	8.25	8918	19,578	90	⊖
Extreme Duty – Spade Edge	JC	2550	100	6.00	7.85	8523	18,791	90	⊖
Maximum load with pin-on (payload + bucket)								kg	17 340
								lb	38,229

The above loads are in compliance with hydraulic excavator standard EN474-5:2006+A3:2013, they do not exceed 87% of hydraulic lifting capacity or 75% of tipping capacity with front linkage fully extended at ground line with bucket curled.

Capacity based on ISO 7451:2007.

Maximum Material Density:

- 2100 kg/m³ (3,500 lb/yd³)
- ⊙ 1800 kg/m³ (3,000 lb/yd³)
- ⊖ 1500 kg/m³ (2,500 lb/yd³)

Caterpillar recommends using appropriate work tools to maximize the value customers receive from our products. Use of work tools, including buckets, which are outside of Caterpillar's recommendations or specifications for weight, dimensions, flows, pressures, etc. may result in less-than-optimal performance, including but not limited to reductions in production, stability, reliability, and component durability. Improper use of a work tool resulting in sweeping, prying, twisting and/or catching of heavy loads will reduce the life of the boom and stick.

395 Hydraulic Excavator Specifications

Bucket Specifications and Compatibility – Turkey

	Linkage	Width		Capacity		Weight		Fill %	Mass Boom M2.92 (9'7")	Mass Boom M2.92 (9'7")
		mm	in	m ³	yd ³	kg	lb			
Pin-On (No Quick Coupler)										
General Duty	JC	2800	110	7.00	9.15	6508	14,347	100	⊖	⊖
Heavy Duty	JC	1800	71	4.10	5.36	4922	10,851	100	●	●
	JC	2650	104	6.60	8.63	6564	14,470	100	⊖	⊖
Severe Duty	JC	2700	106	7.10	9.29	7476	16,481	90	⊖	⊖
Severe Duty – Spade Edge	JC	2400	94	5.70	7.46	6823	15,042	90	●	●
	JC	2500	98	6.00	7.85	7113	15,681	90	⊙	⊙
	JC	2650	104	6.50	8.50	7365	16,236	90	⊖	⊖
	JC	2550	100	6.00	7.85	6123	13,499	90	●	●
Extreme Duty	JC	2800	110	6.30	8.25	8918	19,578	90	⊖	⊖
Extreme Duty – Spade Edge	JC	2200	87	5.00	6.54	7170	15,807	90	●	●
	JC	2350	93	5.40	7.06	7513	16,564	90	⊙	⊙
	JC	2500	98	5.70	7.46	7745	17,075	90	⊙	⊙
	JC	2550	100	6.00	7.85	8523	18,791	90	⊖	⊖
Maximum load with pin-on (payload + bucket)								kg	17 112	17 346
								lb	37,726	38,241

The above loads are in compliance with hydraulic excavator standard EN474-5:2006+A3:2013, they do not exceed 87% of hydraulic lifting capacity or 75% of tipping capacity with front linkage fully extended at ground line with bucket curled.

Capacity based on ISO 7451:2007.

Maximum Material Density:

- 2100 kg/m³ (3,500 lb/yd³)
- ⊙ 1800 kg/m³ (3,000 lb/yd³)
- ⊖ 1500 kg/m³ (2,500 lb/yd³)

Caterpillar recommends using appropriate work tools to maximize the value customers receive from our products. Use of work tools, including buckets, which are outside of Caterpillar's recommendations or specifications for weight, dimensions, flows, pressures, etc. may result in less-than-optimal performance, including but not limited to reductions in production, stability, reliability, and component durability. Improper use of a work tool resulting in sweeping, prying, twisting and/or catching of heavy loads will reduce the life of the boom and stick.

395 Hydraulic Excavator Specifications

Bucket Specifications and Compatibility – Chile

	Linkage	Width		Capacity		Weight		Fill %	Mass Boom M2.92 (9'7")
		mm	in	m ³	yd ³	kg	lb		
Pin-On (No Quick Coupler)									
General Duty	JC	2350	93	5.70	7.45	5824	12,839	100	⊙
	JC	2450	96	6.00	7.84	6006	13,240	100	⊙
	JC	2600	102	6.50	8.50	6237	13,749	100	⊖
Heavy Duty	JC	1800	71	4.10	5.36	4922	10,851	100	●
	JC	2450	96	6.00	7.85	6123	13,498	100	⊙
Severe Duty	JC	2700	106	7.10	9.29	7476	16,481	90	⊖
Severe Duty – Spade Edge	JC	2300	91	5.40	7.06	6618	14,590	90	●
	JC	2500	98	6.00	7.85	7113	15,681	90	⊙
	JC	2650	104	6.50	8.50	7365	16,236	90	⊖
Extreme Duty – Spade Edge	JC	2350	93	5.40	7.06	7513	16,564	90	⊙
	JC	2200	87	5.00	6.54	7650	16,866	90	●
	JC	2550	100	6.00	7.85	8523	18,791	90	⊖
Maximum load with pin-on (payload + bucket)								kg	17 112
								lb	37,726
Pin Grabber Coupler									
General Duty	HB2	1750	69	3.90	5.10	3812	8,404	100	
	HB2	2000	79	4.60	6.02	4175	9,205	100	
General Duty – Extra Large	HB2	2050	81	5.30	6.93	4420	9,745	100	
Severe Duty	HB2	1150	45	2.30	3.00	3279	7,228	90	
	HB2	1450	57	3.00	3.92	3729	8,221	90	
	HB2	1750	69	3.90	5.10	4150	9,149	90	
	HB2	2000	79	4.60	6.02	4537	10,003	90	
Maximum load with coupler (payload + bucket)								kg	15 387
								lb	33,922

*Matches apply to both standard counterweight and counterweight with removal device.

The above loads are in compliance with hydraulic excavator standard EN474-5:2006+A3:2013, they do not exceed 87% of hydraulic lifting capacity or 75% of tipping capacity with front linkage fully extended at ground line with bucket curled.

Capacity based on ISO 7451:2007.

Maximum Material Density:

- 2100 kg/m³ (3,500 lb/yd³)
- ⊙ 1800 kg/m³ (3,000 lb/yd³)
- ⊖ 1500 kg/m³ (2,500 lb/yd³)

Caterpillar recommends using appropriate work tools to maximize the value customers receive from our products. Use of work tools, including buckets, which are outside of Caterpillar's recommendations or specifications for weight, dimensions, flows, pressures, etc. may result in less-than-optimal performance, including but not limited to reductions in production, stability, reliability, and component durability. Improper use of a work tool resulting in sweeping, prying, twisting and/or catching of heavy loads will reduce the life of the boom and stick.

395 Hydraulic Excavator Specifications

Attachments Offering Guide – Australia and New Zealand

Not all attachments are available in all regions. Consult your Cat dealer for configurations available in your region.

Match

* Working range front only

No Match

PIN-ON ATTACHMENTS

Undercarriage		Long Variable Gauge					
Counterweight		Standard	Removeable	Standard	Removeable	Standard	Removeable
Boom Type		Reach	Reach	Mass	Mass	Mass	Mass
Stick Length		4.40 m HD (14'5")	4.40 m HD (14'5")	2.92 m (9'6")	2.92 m (9'6")	3.40 m (11'2")	3.40 m (11'2")
Hydraulic Hammers	H215 S	✓	✓	✓	✓	✓	✓
Mobile Scrap and Demolition Shears	S3070 Flat Top	✓*	✓*	✓	✓	✓	✓
	S3090 Flat Top			✓	✓	✓	✓

PIN-ON ATTACHMENTS (continued)

Undercarriage		Long Variable Gauge			
Counterweight		Standard	Removeable	Standard	Removeable
Boom Type		GP	GP	GP	GP
Stick Length		3.40 m HD (11'2")	3.40 m HD (11'2")	4.40 m HD (14'5")	4.40 m HD (14'5")
Hydraulic Hammers	H215 S	✓	✓	✓	✓
Mobile Scrap and Demolition Shears	S3070 Flat Top	✓	✓	✓	✓
	S3090 Flat Top				

CAT PIN GRABBER COUPLER ATTACHMENTS

Undercarriage		Long Variable Gauge	
Counterweight		Standard	Removeable
Boom Type		GP	GP
Stick Length		4.40 m HD (14'5")	4.40 m HD (14'5")
Hydraulic Hammers	H215 S	✓	✓

395 Hydraulic Excavator Specifications

Attachments Offering Guide – Europe

Not all attachments are available in all regions. Consult your Cat dealer for configurations available in your region.

Match

* Working range front only

No Match

PIN-ON ATTACHMENTS

Undercarriage		Long Variable Gauge							
		Standard		Removeable		Standard		Removeable	
Counterweight		Reach				Mass			
Boom Type		4.4 m HD (14'5")		5.5 m HD (18'1")		2.92 m (9'6")		3.4 m (11'2")	
Stick Length		4.4 m HD (14'5")		5.5 m HD (18'1")		2.92 m (9'6")		3.4 m (11'2")	
Hydraulic Hammers	H215 S	✓	✓			✓	✓	✓	✓
Multi-Processors	MP365 Concrete Cutter Jaw	✓	✓	✓	✓				
	MP365 Concrete Cutter Jaw-Flat Top		✓		✓*				
	MP365 Demolition Jaw	✓	✓	✓	✓				
	MP365 Demolition Jaw-Flat Top		✓						
	MP365 Pulverizer Jaw	✓	✓	✓	✓				
	MP365 Pulverizer Jaw-Flat Top		✓						
	MP365 Shear Jaw	✓	✓	✓	✓				
	MP365 Shear Jaw-Flat Top		✓		✓*				
Mobile Scrap and Demolition Shears	S3070 Flat Top	✓*	✓*			✓	✓	✓	✓
	S3090 Flat Top					✓	✓	✓	✓
Pulverizers	P365 Primary Pulverizer	✓	✓	✓	✓				
	P365 Primary Pulverizer-Flat Top	✓	✓						

PIN-ON ATTACHMENTS (continued)

Undercarriage		Long Variable Gauge							
		Standard		Removeable		Standard		Removeable	
Counterweight		GP				GP			
Boom Type		3.4 m HD (11'2")		4.4 m HD (14'5")		5.5 m HD (18'1")		5.5 m HD (18'1")	
Stick Length		3.4 m HD (11'2")		4.4 m HD (14'5")		5.5 m HD (18'1")		5.5 m HD (18'1")	
Hydraulic Hammers	H215 S	✓	✓	✓	✓				
Multi-Processors	MP365 Concrete Cutter Jaw			✓	✓	✓	✓		✓
	MP365 Concrete Cutter Jaw-Flat Top				✓				✓
	MP365 Demolition Jaw			✓	✓	✓	✓		✓
	MP365 Demolition Jaw-Flat Top				✓				
	MP365 Pulverizer Jaw			✓	✓	✓	✓		✓
	MP365 Pulverizer Jaw-Flat Top				✓				
	MP365 Shear Jaw			✓	✓	✓	✓		✓
	MP365 Shear Jaw-Flat Top								✓
Mobile Scrap and Demolition Shears	S3070 Flat Top	✓	✓	✓	✓				
	S3090 Flat Top								
Pulverizers	P365 Primary Pulverizer			✓	✓	✓	✓		✓
	P365 Primary Pulverizer-Flat Top			✓	✓				

(continued on next page)

395 Hydraulic Excavator Specifications

Attachments Offering Guide – Europe (continued)

Not all attachments are available in all regions. Consult your Cat dealer for configurations available in your region.

Match

* Working range front only

No Match

CAT PIN GRABBER COUPLER ATTACHMENTS

Undercarriage		Long Variable Gauge			
Counterweight		Standard	Removeable	Standard	Removeable
Boom Type		Reach		GP	
Stick Length		4.4 m HD (14'5")		4.4 m HD (14'5")	
Hydraulic Hammers	H215 S			✓	✓
Multi-Processors	MP365 Concrete Cutter Jaw	✓	✓	✓	✓
	MP365 Concrete Cutter Jaw-Flat Top				✓
	MP365 Demolition Jaw	✓*	✓*	✓	✓
	MP365 Demolition Jaw-Flat Top				✓
	MP365 Pulverizer Jaw	✓*	✓*	✓	✓
	MP365 Shear Jaw	✓*	✓*	✓	✓
	MP365 Shear Jaw-Flat Top				✓
Pulverizers	P365 Primary Pulverizer	✓*	✓*	✓	✓

CW-70 DEDICATED COUPLER ATTACHMENTS

Undercarriage		Long Variable Gauge			
Counterweight		Standard	Removeable	Standard	Removeable
Boom Type		Reach		Mass	
Stick Length		4.4 m HD (14'5")		3.4 m (11'2")	
Hydraulic Hammers	H215 S			✓	✓
Multi-Processors	MP365 Concrete Cutter Jaw	✓	✓		
	MP365 Concrete Cutter Jaw-Flat Top		✓*		
	MP365 Demolition Jaw	✓*	✓*		
	MP365 Demolition Jaw-Flat Top				
	MP365 Pulverizer Jaw	✓*	✓*		
	MP365 Pulverizer Jaw-Flat Top				
	MP365 Shear Jaw	✓	✓		
	MP365 Shear Jaw-Flat Top		✓*		
Mobile Scrap and Demolition Shears	S3070 Flat Top			✓	✓
	S3090 Flat Top			✓	✓
Pulverizers	P365 Primary Pulverizer	✓*	✓*		
	P365 Primary Pulverizer-Flat Top				

(continued on next page)

395 Hydraulic Excavator Specifications

Attachments Offering Guide – Europe *(continued)*

Not all attachments are available in all regions. Consult your Cat dealer for configurations available in your region.

Match

No Match

CW-70 DEDICATED COUPLER ATTACHMENTS *(continued)*

Undercarriage		Long Variable Gauge			
		Standard	Removeable	Standard	Removeable
Counterweight					
Boom Type		GP		GP	
Stick Length		3.4 m HD (11'2")		4.4 m HD (14'5")	
Hydraulic Hammers	H215 S	✓	✓	✓	✓
Multi-Processors	MP365 Concrete Cutter Jaw			✓	✓
	MP365 Concrete Cutter Jaw-Flat Top				✓
	MP365 Demolition Jaw			✓	✓
	MP365 Demolition Jaw-Flat Top				✓
	MP365 Pulverizer Jaw			✓	✓
	MP365 Pulverizer Jaw-Flat Top				✓
	MP365 Shear Jaw			✓	✓
	MP365 Shear Jaw-Flat Top				✓
	Mobile Scrap and Demolition Shears	S3070 Flat Top	✓	✓	
S3090 Flat Top					
Pulverizers	P365 Primary Pulverizer			✓	✓
	P365 Primary Pulverizer-Flat Top			✓	✓

395 Hydraulic Excavator Specifications

Attachments Offering Guide – North America

Not all attachments are available in all regions. Consult your Cat dealer for configurations available in your region.

Match

* Working range front only

No Match

PIN-ON ATTACHMENTS

Undercarriage		Long Variable Gauge							
Counterweight		Standard		Removeable		Standard		Removeable	
Boom Type		Reach		Reach		Mass		Mass	
Stick Length		4.4 m HD (14'5")		5.5 m HD (18'1")		2.92 m (9'6")		3.4 m (11'2")	
Hydraulic Hammers	H215 S	✓	✓			✓	✓	✓	✓
Multi-Processors	MP365 Concrete Cutter Jaw	✓	✓	✓	✓				
	MP365 Concrete Cutter Jaw-Flat Top		✓		✓*				
	MP365 Demolition Jaw	✓	✓	✓	✓				
	MP365 Demolition Jaw-Flat Top		✓						
	MP365 Pulverizer Jaw	✓	✓	✓	✓				
	MP365 Pulverizer Jaw-Flat Top		✓						
	MP365 Shear Jaw	✓	✓	✓	✓				
	MP365 Shear Jaw-Flat Top		✓		✓*				
Mobile Scrap and Demolition Shears	S3070 Flat Top	✓*	✓*			✓	✓	✓	✓
	S3090 Flat Top					✓	✓	✓	✓
Pulverizers	P365 Primary Pulverizer	✓	✓	✓	✓				
	P365 Primary Pulverizer-Flat Top	✓	✓						

PIN-ON ATTACHMENTS (continued)

Undercarriage		Long Variable Gauge							
Counterweight		Standard		Removeable		Standard		Removeable	
Boom Type		GP		GP		GP		GP	
Stick Length		2.92 m HD (9'6")		3.4 m HD (11'2")		4.4 m HD (14'5")		5.5 m HD (18'1")	
Hydraulic Hammers	H215 S	✓	✓	✓	✓	✓	✓		
Multi-Processors	MP365 Concrete Cutter Jaw					✓	✓	✓	✓
	MP365 Concrete Cutter Jaw-Flat Top						✓		✓
	MP365 Demolition Jaw					✓	✓	✓	✓
	MP365 Demolition Jaw-Flat Top						✓		
	MP365 Pulverizer Jaw					✓	✓	✓	✓
	MP365 Pulverizer Jaw-Flat Top						✓		
	MP365 Shear Jaw					✓	✓	✓	✓
	MP365 Shear Jaw-Flat Top						✓		✓
Mobile Scrap and Demolition Shears	S3070 Flat Top	✓	✓	✓	✓	✓	✓		
	S3090 Flat Top	✓	✓						
Pulverizers	P365 Primary Pulverizer					✓	✓	✓	✓
	P365 Primary Pulverizer-Flat Top					✓	✓		

(continued on next page)

395 Hydraulic Excavator Specifications

Attachments Offering Guide – North America (continued)

Not all attachments are available in all regions. Consult your Cat dealer for configurations available in your region.

Match

* Working range front only

No Match

CAT PIN GRABBER COUPLER ATTACHMENTS

Undercarriage		Long Variable Gauge			
Counterweight		Standard	Removeable	Standard	Removeable
Boom Type		Reach		GP	
Stick Length		4.4 m HD (14'5")		4.4 m HD (14'5")	
Hydraulic Hammers	H215 S			✓	✓
Multi-Processors	MP365 Concrete Cutter Jaw	✓	✓	✓	✓
	MP365 Concrete Cutter Jaw-Flat Top				✓
	MP365 Demolition Jaw	✓*	✓*	✓	✓
	MP365 Demolition Jaw-Flat Top				✓
	MP365 Pulverizer Jaw	✓*	✓*	✓	✓
	MP365 Shear Jaw	✓*	✓*	✓	✓
	MP365 Shear Jaw-Flat Top				✓
Pulverizers	P365 Primary Pulverizer	✓*	✓*	✓	✓

CW-70 DEDICATED COUPLER ATTACHMENTS

Undercarriage		Long Variable Gauge					
Counterweight		Standard	Removeable	Standard	Removeable	Standard	Removeable
Boom Type		Reach		Mass		Mass	
Stick Length		4.4 m HD (14'5")		2.92 m (9'6")		3.4 m (11'2")	
Hydraulic Hammers	H215 S			✓	✓	✓	✓
Multi-Processors	MP365 Concrete Cutter Jaw	✓	✓				
	MP365 Concrete Cutter Jaw-Flat Top		✓*				
	MP365 Demolition Jaw	✓*	✓*				
	MP365 Demolition Jaw-Flat Top						
	MP365 Pulverizer Jaw	✓*	✓*				
	MP365 Pulverizer Jaw-Flat Top						
	MP365 Shear Jaw	✓	✓				
	MP365 Shear Jaw-Flat Top		✓*				
Mobile Scrap and Demolition Shears	S3070 Flat Top			✓	✓	✓	✓
	S3090 Flat Top			✓	✓		
Pulverizers	P365 Primary Pulverizer	✓	✓				
	P365 Primary Pulverizer-Flat Top						

(continued on next page)

395 Hydraulic Excavator Specifications

Attachments Offering Guide – North America *(continued)*

Not all attachments are available in all regions. Consult your Cat dealer for configurations available in your region.

Match

* Working range front only

No Match

CW-70 DEDICATED COUPLER ATTACHMENTS *(continued)*

Undercarriage		Long Variable Gauge					
		Standard	Removeable	Standard	Removeable	Standard	Removeable
Counterweight		GP		GP		GP	
Boom Type		GP		GP		GP	
Stick Length		2.92 m HD (9'6")		3.4 m HD (11'2")		4.4 m HD (14'5")	
Hydraulic Hammers	H215 S	✓	✓	✓	✓	✓	✓
Multi-Processors	MP365 Concrete Cutter Jaw					✓	✓
	MP365 Concrete Cutter Jaw-Flat Top						✓
	MP365 Demolition Jaw					✓	✓
	MP365 Demolition Jaw-Flat Top						✓
	MP365 Pulverizer Jaw					✓	✓
	MP365 Pulverizer Jaw-Flat Top						✓
	MP365 Shear Jaw					✓	✓
	MP365 Shear Jaw-Flat Top						✓
Mobile Scrap and Demolition Shears	S3070 Flat Top	✓	✓	✓	✓		
	S3090 Flat Top	✓*	✓*				
Pulverizers	P365 Primary Pulverizer					✓	✓
	P365 Primary Pulverizer-Flat Top					✓	✓

395 Hydraulic Excavator Specifications

Attachments Offering Guide – Turkey

Not all attachments are available in all regions. Consult your Cat dealer for configurations available in your region.

Match

* Working range front only

No Match

PIN-ON ATTACHMENTS

Undercarriage		Long Variable Gauge							
Counterweight		Standard		Removeable		Standard		Removeable	
Boom Type		Reach				Mass			
Stick Length		4.4 m HD (14'5")		5.5 m HD (18'1")		2.92 m (9'6")		3.4 m (11'2")	
Hydraulic Hammers	H215 S	✓	✓			✓	✓		
Multi-Processors	MP365 Concrete Cutter Jaw	✓	✓	✓	✓				
	MP365 Concrete Cutter Jaw-Flat Top	✓	✓	✓*	✓*				
	MP365 Demolition Jaw	✓	✓	✓	✓				
	MP365 Demolition Jaw-Flat Top	✓	✓						
	MP365 Pulverizer Jaw	✓	✓	✓	✓				
	MP365 Pulverizer Jaw-Flat Top	✓	✓						
	MP365 Shear Jaw	✓	✓	✓	✓				
	MP365 Shear Jaw-Flat Top	✓	✓	✓*	✓*				
Mobile Scrap and Demolition Shears	S3070 Flat Top	✓*	✓*			✓	✓		
	S3090 Flat Top					✓	✓		
Pulverizers	P365 Primary Pulverizer	✓	✓	✓	✓				
	P365 Primary Pulverizer-Flat Top	✓	✓						

PIN-ON ATTACHMENTS (continued)

Undercarriage		Long Variable Gauge							
Counterweight		Standard		Removeable		Standard		Removeable	
Boom Type		GP				GP			
Stick Length		2.92 m HD (9'6")		3.4 m HD (11'2")		4.4 m HD (14'5")		5.5 m HD (18'1")	
Hydraulic Hammers	H215 S	✓	✓	✓	✓	✓	✓		
Multi-Processors	MP365 Concrete Cutter Jaw					✓	✓	✓	✓
	MP365 Concrete Cutter Jaw-Flat Top					✓	✓	✓	✓
	MP365 Demolition Jaw					✓	✓	✓	✓
	MP365 Demolition Jaw-Flat Top					✓	✓		
	MP365 Pulverizer Jaw					✓	✓	✓	✓
	MP365 Pulverizer Jaw-Flat Top					✓	✓		
	MP365 Shear Jaw					✓	✓	✓	✓
	MP365 Shear Jaw-Flat Top					✓	✓	✓	✓
Mobile Scrap and Demolition Shears	S3070 Flat Top	✓	✓	✓	✓	✓	✓		
	S3090 Flat Top	✓			✓				
Pulverizers	P365 Primary Pulverizer					✓	✓	✓	✓
	P365 Primary Pulverizer-Flat Top					✓	✓	✓	

(continued on next page)

395 Hydraulic Excavator Specifications

Attachments Offering Guide – Turkey (continued)

Not all attachments are available in all regions. Consult your Cat dealer for configurations available in your region.

Match

* Working range front only

No Match

CAT PIN GRABBER COUPLER ATTACHMENTS

Undercarriage		Long Variable Gauge				
Counterweight		Standard	Standard	Removeable	Standard	Removeable
Boom Type		GP	Reach	Reach	GP	GP
Stick Length		3.70 m HD (12'1")	4.40 m HD (14'5")	4.40 m HD (14'5")	4.40 m HD (14'5")	4.40 m HD (14'5")
Hydraulic Hammers	H215 S	✓			✓	✓
Multi-Processors	MP365 Concrete Cutter Jaw	✓	✓	✓	✓	✓
	MP365 Concrete Cutter Jaw-Flat Top	✓			✓	✓
	MP365 Demolition Jaw	✓	✓*	✓*	✓	✓
	MP365 Demolition Jaw-Flat Top	✓			✓	✓
	MP365 Pulverizer Jaw	✓	✓*	✓*	✓	✓
	MP365 Pulverizer Jaw-Flat Top	✓			✓	
	MP365 Shear Jaw	✓	✓*	✓*	✓	✓
	MP365 Shear Jaw-Flat Top	✓			✓	✓
Mobile Scrap and Demolition Shears	S3070 Flat Top	✓				
Pulverizers	P365 Primary Pulverizer	✓	✓*	✓*	✓	✓
	P365 Primary Pulverizer-Flat Top	✓				

CW-70 DEDICATED COUPLER ATTACHMENTS

Undercarriage		Long Variable Gauge			
Counterweight		Standard	Removeable	Standard	Standard
Boom Type		Reach	Reach	ME	ME
Stick Length		4.40 m HD (14'5")	4.40 m HD (14'5")	2.92 m (9'6")	3.40 m (11'2")
Hydraulic Hammers	H215 S			✓	✓
Multi-Processors	MP365 Concrete Cutter Jaw	✓	✓		
	MP365 Concrete Cutter Jaw-Flat Top	✓*	✓*		
	MP365 Demolition Jaw	✓*	✓*		
	MP365 Demolition Jaw-Flat Top				
	MP365 Pulverizer Jaw	✓*	✓*		
	MP365 Pulverizer Jaw-Flat Top				
	MP365 Shear Jaw	✓	✓		
	MP365 Shear Jaw-Flat Top	✓*	✓*		
Mobile Scrap and Demolition Shears	S3070 Flat Top			✓	✓
	S3090 Flat Top			✓	
Pulverizers	P365 Primary Pulverizer	✓*	✓*		
	P365 Primary Pulverizer-Flat Top				

(continued on next page)

395 Hydraulic Excavator Specifications

Attachments Offering Guide – Turkey (continued)

Not all attachments are available in all regions. Consult your Cat dealer for configurations available in your region.

Match

* Working range front only

No Match

CW-70 DEDICATED COUPLER ATTACHMENTS (continued)

Undercarriage		Long Variable Gauge					
Counterweight		Standard	Standard	Removeable	Standard	Standard	Removeable
Boom Type		GP	GP	GP	GP	GP	GP
Stick Length		2.92 m HD (9'6")	3.40 m HD (11'2")	3.40 m HD (11'2")	3.70 m HD (12'1")	4.40 m HD (14'5")	4.40 m HD (14'5")
Hydraulic Hammers	H215 S	✓	✓	✓	✓	✓	✓
Multi-Processors	MP365 Concrete Cutter Jaw				✓	✓	✓
	MP365 Concrete Cutter Jaw-Flat Top				✓	✓	✓
	MP365 Demolition Jaw				✓	✓	✓
	MP365 Demolition Jaw-Flat Top				✓	✓	✓
	MP365 Pulverizer Jaw				✓	✓	✓
	MP365 Pulverizer Jaw-Flat Top				✓	✓	✓
	MP365 Shear Jaw				✓	✓	✓
	MP365 Shear Jaw-Flat Top				✓	✓	✓
Mobile Scrap and Demolition Shears	S3070 Flat Top	✓	✓	✓	✓		
	S3090 Flat Top	✓*					
Pulverizers	P365 Primary Pulverizer				✓	✓	✓
	P365 Primary Pulverizer-Flat Top				✓	✓	✓

395 Hydraulic Excavator Specifications

Attachments Offering Guide – Chile

Not all attachments are available in all regions. Consult your Cat dealer for configurations available in your region.

Match

* Working range front only

No Match

PIN-ON ATTACHMENTS

Undercarriage		Long Variable Gauge				
Counterweight		Standard	Standard	Removeable	Standard	
Boom Type		GP	GP	GP	GP	
Stick Length		2.92 m (9'6")	3.40 m HD (11'2")	3.40 m HD (11'2")	3.70 m HD (12'1")	4.40 m HD (14'5")
Hydraulic Hammers	H215 S	✓	✓	✓	✓	✓
Multi-Processors	MP365 Concrete Cutter Jaw				✓	✓
	MP365 Concrete Cutter Jaw-Flat Top				✓	✓
	MP365 Demolition Jaw				✓	✓
	MP365 Demolition Jaw-Flat Top				✓	✓
	MP365 Pulverizer Jaw				✓	✓
	MP365 Pulverizer Jaw-Flat Top				✓	✓
	MP365 Shear Jaw				✓	✓
Mobile Scrap and Demolition Shears	S3070 Flat Top	✓	✓	✓	✓	✓
	S3090 Flat Top	✓			✓	
Pulverizers	P365 Primary Pulverizer				✓	✓
	P365 Primary Pulverizer-Flat Top				✓	✓

PIN-ON ATTACHMENTS (continued)

Undercarriage		Long Variable Gauge				
Counterweight		Removeable	Standard	Removeable	Removeable	
Boom Type		GP	GP	Reach	Reach	
Stick Length		4.40 m HD (14'5")	5.50 m HD (18'1")	5.50 m HD (18'1")	4.40 m HD (14'5")	5.50 m HD (18'1")
Hydraulic Hammers	H215 S	✓			✓	
Multi-Processors	MP365 Concrete Cutter Jaw	✓	✓	✓	✓	✓
	MP365 Concrete Cutter Jaw-Flat Top	✓	✓	✓	✓	✓*
	MP365 Demolition Jaw	✓	✓	✓	✓	✓
	MP365 Demolition Jaw-Flat Top	✓			✓	
	MP365 Pulverizer Jaw	✓	✓	✓	✓	✓
	MP365 Pulverizer Jaw-Flat Top	✓			✓	
	MP365 Shear Jaw	✓	✓	✓	✓	✓
Mobile Scrap and Demolition Shears	S3070 Flat Top	✓			✓*	
	S3090 Flat Top					
Pulverizers	P365 Primary Pulverizer	✓	✓	✓	✓	✓
	P365 Primary Pulverizer-Flat Top	✓			✓	

(continued on next page)

395 Hydraulic Excavator Specifications

Attachments Offering Guide – Chile (continued)

Not all attachments are available in all regions. Consult your Cat dealer for configurations available in your region.

Match

* Working range front only

No Match

CAT PIN GRABBER COUPLER ATTACHMENTS

Undercarriage		Long Variable Gauge			
Counterweight		Standard	Removeable	Removeable	Removeable
Boom Type		GP	GP	GP	Reach
Stick Length		3.70 m HD (12'1")	4.40 m HD (14'5")	4.40 m HD (14'5")	4.40 m HD (14'5")
Hydraulic Hammers	H215 S	✓	✓	✓	
Multi-Processors	MP365 Concrete Cutter Jaw	✓	✓	✓	✓
	MP365 Concrete Cutter Jaw-Flat Top	✓	✓	✓	
	MP365 Demolition Jaw	✓	✓	✓	✓*
	MP365 Demolition Jaw-Flat Top	✓	✓	✓	
	MP365 Pulverizer Jaw	✓	✓	✓	✓*
	MP365 Pulverizer Jaw-Flat Top	✓			
	MP365 Shear Jaw	✓	✓	✓	✓*
	MP365 Shear Jaw-Flat Top	✓	✓	✓	
Mobile Scrap and Demolition Shears	S3070 Flat Top	✓			
Pulverizers	P365 Primary Pulverizer	✓	✓	✓	✓*
	P365 Primary Pulverizer-Flat Top	✓			

CW-70 DEDICATED COUPLER ATTACHMENTS

Undercarriage		Long Variable Gauge						
Counterweight		Standard	Standard	Removeable	Standard	Standard	Removeable	Removeable
Boom Type		GP	GP	GP	GP	GP	GP	Reach
Stick Length		2.92 m (9'6")	3.40 m HD (11'2")	3.40 m HD (11'2")	3.70 m HD (12'1")	4.40 m HD (14'5")	4.40 m HD (14'5")	4.40 m HD (14'5")
Hydraulic Hammers	H215 S	✓	✓	✓	✓	✓	✓	
Multi-Processors	MP365 Concrete Cutter Jaw				✓	✓	✓	✓
	MP365 Concrete Cutter Jaw-Flat Top				✓	✓	✓	✓*
	MP365 Demolition Jaw				✓	✓	✓	✓*
	MP365 Demolition Jaw-Flat Top				✓	✓	✓	
	MP365 Pulverizer Jaw				✓	✓	✓	✓*
	MP365 Pulverizer Jaw-Flat Top				✓	✓	✓	
	MP365 Shear Jaw				✓	✓	✓	✓
	MP365 Shear Jaw-Flat Top				✓	✓	✓	✓*
	Mobile Scrap and Demolition Shears	S3070 Flat Top	✓	✓	✓	✓		
S3090 Flat Top		✓*						
Pulverizers	P365 Primary Pulverizer				✓	✓	✓	✓*
	P365 Primary Pulverizer-Flat Top				✓	✓	✓	

395 Hydraulic Excavator Specifications

Typical Pass Match Guide

For maximum production and efficiency, we recommend that loading and hauling machines are matched to achieve optimal performance.

Configuration*:

Long Variable Gauge undercarriage, Mass boom, M2.92JC (9'7") stick, SDV 6.5 m³ (6.5 yd³) bucket, 650 mm (26") double grouser shoes and standard counterweight.

Passes Required to Fill Trucks to Rated Capacity

Material Type	Material Density	Fill Factor	Cat Articulated Trucks				Cat Off-Highway Trucks				
			735	740 GC	740 EJ	745	770G	772G	773E	773G	775G
Earth	1600 kg/m ³ (2,700 lb/yd ³)	100%			3-4	4	3-4	4-5	5-6	5-6	6
Limestone	1540 kg/m ³ (2,600 lb/yd ³)	90%	3-4	4	4-5	4-5	4-5	5	6	6	7

*The indicated pass match reflects the machine configuration, fill factor, and typical material density shown. Changes to machine configurations, fill factors, or material density as well as jobsite-specific factors may influence exact pass match recommendations for your application. Consult your Cat dealer for more information.

Configuration*:

Long Variable Gauge undercarriage, GP boom, R4.4HB2 (14'5") stick, SD 5.2 m³ (6.8 yd³) bucket, 900 mm (35") double grouser shoes and counterweight with removal device.

Passes Required to Fill Trucks to Rated Capacity

Material Type	Material Density	Fill Factor	Cat Articulated Trucks				Cat Off-Highway Trucks				
			735	740 GC	740 EJ	745	770G	772G	773E	773G	775G
Earth	1600 kg/m ³ (2,700 lb/yd ³)	100%			3-4	4	3-4	4-5	5-6	5-6	6
Limestone	1540 kg/m ³ (2,600 lb/yd ³)	90%	3-4	4	4-5	4-5	4-5	5	6	6	7

*The indicated pass match reflects the machine configuration, fill factor, and typical material density shown. Changes to machine configurations, fill factors, or material density as well as jobsite-specific factors may influence exact pass match recommendations for your application. Consult your Cat dealer for more information.

395 Standard and Optional Equipment

Standard and Optional Equipment

Standard and optional equipment may vary. Consult your Cat dealer for details.

	Standard	Optional		Standard	Optional
BOOMS, STICKS AND LINKAGES			ELECTRICAL SYSTEM		
7.25 m (23'9") Mass boom		✓	Maintenance-free 1,400 CCA batteries (×2)	✓	
8.4 m (27'7") GP boom ¹		✓	Centralized electrical disconnect switch	✓	
10.0 m (32'10") Reach boom ²		✓	Chassis light	✓	
2.92 m (9'7") GP stick ³		✓	LED boom and cab lights		✓
2.92 m (9'7") Mass stick		✓	1,800 lumen LED premium surround lights		✓
3.4 m (11'2") Mass stick ¹		✓	ENGINE		
3.4 m (11'2") GP stick ¹		✓	Cold start block heater		✓
4.4 m (14'5") Reach stick ²		✓	Three selectable modes: Power, Smart, Eco	✓	
5.5 m (18'1") Reach stick ²		✓	Automatic engine speed control	✓	
Bucket linkage, HB2 type with lifting eye, Autolube ready ²		✓	Up to 4500 m (14,760 ft) altitude capability	✓	
Bucket linkage, HB2 type without lifting eye, Autolube ready ³		✓	52° C (126° F) high-ambient cooling capacity	✓	
Bucket linkage, JC type with lifting eye, Autolube ready ¹		✓	-18° C (-0.4° F) cold start capability	✓	
Bucket linkage, JC type without lifting eye, Autolube ready ⁴		✓	-32° C (-25° F) cold start capability		✓
CAT TECHNOLOGY			Hydraulic reverse fan	✓	
VisionLink®	✓*		Double element air filter with integrated precleaner	✓	
VisionLink Productivity		✓	Three vertical side-by-side cooling system	✓	
Remote Flash	✓		Remote disable	✓	
Remote Troubleshoot	✓		95 Amp alternator	✓	
Cat Grade Connectivity		✓	HYDRAULIC SYSTEM		
Compatibility with radios and base stations from Trimble, Topcon, and Leica	✓		SmartBoom™ ³		✓
Capability to install 3D grade systems from Trimble, Topcon, and Leica	✓		Boom and stick regeneration circuit	✓	
Cat Grade 2D	✓		Electronic main control valve	✓	
Cat Grade 2D with Attachment Ready Option (ARO)		✓	Dedicated closed loop swing circuit	✓	
Cat Grade 3D single GNSS		✓	Automatic hydraulic oil warmup	✓	
Cat Grade 3D dual GNSS		✓	Automatic swing parking brake	✓	
Laser catcher – optional		✓	Anti-reaction valve	✓	
Cat Assist:	✓		High performance hydraulic return filter	✓	
– Grade Assist			Two speed travel	✓	
– Boom Assist			Bio hydraulic oil capability	✓	
– Bucket Assist			Advanced tool control		✓
– Swing Assist			Medium-pressure auxiliary circuit		✓
– Lift Assist			Quick coupler circuit		✓
Cat Payload:	✓		Hydraulic efficiency monitoring		✓
– Static weigh			*Connect subscription only. Additional subscriptions are available. Contact your Cat dealer for availability.		
– Semiautomatic calibration			¹ All regions except South Korea		
– Payload/cycle information			² Europe and North America only		
– USB reporting capability			³ Europe only		
Work tool recognition (PL161)	✓		⁴ All regions except North America		
Work tool tracking (PL161)	✓				
Cat Tilt Rotator (TRS) Integration		✓			
Operator Coaching		✓			

(continued on next page)

Standard and Optional Equipment (continued)

Standard and optional equipment may vary. Consult your Cat dealer for details.

	Standard	Optional		Standard	Optional
SAFETY AND SECURITY			SERVICE AND MAINTENANCE		
Caterpillar One Key security system	✓		Integrated vehicle health management system	✓	
2D E-Fence:	✓		Auto lube ready	✓	
– E-ceiling			Reversing cooling fan	✓	
– E-floor			Grouped location for engine oil and fuel filters	✓	
– E-swing			Fast-fill fuel system		✓
– E-wall			Scheduled Oil Sampling (S·O·S SM) ports	✓	
– E-cab avoidance			QuickEvac TM maintenance ready		✓
Auto hammer stop	✓		Electric refueling pump with auto shutoff		✓
Auto hammer stop enhancement	✓		UNDERCARRIAGE AND STRUCTURES		
Lockable external tool/storage box	✓		Long variable gauge undercarriage	✓	
Lockable door, fuel, and hydraulic tank locks	✓		650 mm (26") double grouser track shoes		✓
Lockable fuel drain compartment	✓		750 mm (30") double grouser track shoes		✓
Lockable disconnect switch	✓		900 mm (35") double grouser track shoes ²		✓
Service platforms with anti-skid plate	✓		Grease lubricated track	✓	
Full handrail mount on platform	✓		Three-piece segmented track guiding guards		✓
Mirror package	✓		Two-piece full-length track guiding guards		✓
Signaling/warning horn	✓		Swivel guard	✓	
Travel alarm	✓		HD bottom guard	✓	
Swing alarm		✓	HD travel motor guard	✓	
Ground-level secondary engine shutoff switch	✓		Standard counterweight	✓	
Rear and right-hand-sideview cameras	✓		Counterweight with removal device ²		✓
360° visibility		✓	Towing eye on base frame	✓	
Boom lowering check valve ¹		✓			
Stick lowering check valve ¹		✓			
Walkway	✓				
Tilt-up walkway		✓			
Inspection lighting		✓			
Cat Command (remote control)		✓			

¹All regions except South Korea

²Europe and North America only

Dealer Installed Kits and Attachments

Attachments may vary. Consult your Cat dealer for details.

CAB

- Radial lower wiper (for deluxe cab only)
- Parallel wiper kit (for deluxe cab only)
- Joystick with horizontal sliders
- Left Hand (LH)/Right Hand (RH) electrical pedal for tool control
- Dual exit rear window kit
- Front windshield laminated glass (P5A glass, EU demolition regulation)

SAFETY AND SECURITY

- Bluetooth® key fob
- 76 mm (3") retractable seat belt
- Cat Detect – People Detection
- Cat Command – Remote control kit

GUARDS

- OPG (not compatible with cab light cover, rain protector)
- Mesh guard full front (not compatible with cab light cover, rain protector)
- Mesh guard lower half front
- Rain protector for front windshield plus cab light cover

OTHER ATTACHMENTS

- GNSS antennae

Cab Options

	Deluxe	Premium
Sound suppressed cab with viscous mounts	●	●
High-resolution 254 mm (10") LCD touch screen monitor	●	●
Additional high-resolution LCD touch screen monitor for Cat Grade 2D and 3D	○	○
Automatic bi-level air conditioner	●	●
Jog dial and shortcut keys for monitor control	●	●
Keyless push-to-start engine control	●	●
Height-adjustable console, infinite with no tool	●	●
Tilt-up left-side console	●	●
Cat Stick Steer	○	○
Auxiliary relay	○	○
Heated seat with air-adjustable suspension	●	X
Heated and cooled seat with automatic adjustable suspension	X	●
51 mm (2") orange seat belt	●	●
Bluetooth integrated radio (including USB, auxiliary port and microphone)	●	●
2 × 12V DC outlets	●	●
Cup holder and storage compartments	●	●
Fixed one-piece windshield	X	○
Openable two-piece front window	●	○
Upper radial wiper with washer	●	X
Parallel wiper with washer	X	●
Openable polycarbonate skylight hatch	●	○
Fixed glass laminated skylight	X	○
LED dome light	●	●
Floor welcome light	●	●
Roller front sunscreen	●	●
Roller rear sunscreen	○	●
Rear window emergency exit	●	●
Washable floor mat	●	●
Beacon ready	●	●

● Standard

○ Optional

X Not available

395 Environmental Declaration

The following information applies to the machine at the time of final manufacture as configured for sale in the regions covered in this document. The content of this declaration is valid as of the date issued; however, content related to machine features and specifications are subject to change without notice. For additional information, please see the machine's Operation and Maintenance Manual.

For more information on sustainability in action and our progress, please visit <https://www.caterpillar.com/en/company/sustainability>.

Engine

- The Cat® C18 engine meets U.S. EPA Tier 4 Final, EU Stage V, Japan 2014 and Korea Stage V emission standards.
- Cat diesel engines are required to use ULSD (ultra-low sulfur diesel fuel with 15 ppm of sulfur or less) or ULSD blended with the following lower-carbon intensity fuels** up to:
 - ✓ 20% biodiesel FAME (fatty acid methyl ester)*
 - ✓ 100% renewable diesel, HVO (hydrotreated vegetable oil) and GTL (gas-to-liquid) fuels

Refer to guidelines for successful application. Please consult your Cat dealer or “Caterpillar Machine Fluids Recommendations” (SEBU6250) for details.

**Engines with no aftertreatment devices can use higher blends, up to 100% biodiesel (for use of blends higher than 20% biodiesel, consult your Cat dealer).*

*** Tailpipe greenhouse gas emissions from lower-carbon intensity fuels are essentially the same as traditional fuels.*

Air Conditioning System

- The air conditioning system on this machine contains the fluorinated greenhouse gas refrigerant R134a (Global Warming Potential = 1430). The system contains 1.0 kg (2.2 lb) of refrigerant which has a CO₂ equivalent of 1.430 metric tonnes (1.576 tons).

Paint

- Based on best available knowledge, the maximum allowable concentration, measured in parts per million (PPM), of the following heavy metals in paint are:
 - Barium < 0.01%
 - Cadmium < 0.01%
 - Chromium < 0.01%
 - Lead < 0.01%

Sound Performance

ISO 6395:2008 (external) – 109 dB(A)

ISO 6396:2008 (inside cab) – 73 dB(A)

- Hearing protection may be needed when operating with an open operator station and cab (when not properly maintained or doors/windows open) for extended periods or in a noisy environment.

Oils and Fluids

- Caterpillar factory fills with ethylene glycol coolants. Cat Diesel Engine Antifreeze/Coolant (DEAC) and Cat Extended Life Coolant (ELC) can be recycled. Consult your Cat dealer for more information.
- Cat Bio HYDO™ Advanced is an EU Ecolabel approved biodegradable hydraulic oil.
- Additional fluids are likely to be present, please consult the Operations and Maintenance Manual or the Application and Installation guide for complete fluid recommendations and maintenance intervals.

Features and Technology

- The following features and technology may contribute to fuel savings and/or carbon reduction. Features may vary. Consult your Cat dealer for details.
 - Advanced hydraulic systems balance power and efficiency
 - Smart mode matches machine power to digging requirements automatically
 - Eco mode minimizes fuel consumption for light applications
 - One-touch low idle with automatic engine speed control
 - Extended maintenance intervals reduce fluid and filter consumption

Recycling

- The materials included in machines are categorized as below with approximate weight percentage. Because of variations of product configurations, the following values in the table may vary.

Material Type	Weight Percentage
Steel	89.46%
Iron	5.97%
Nonferrous Metal	1.26%
Mixed Metal	0.08%
Mixed-Metal and Nonmetal	0.74%
Plastic	0.11%
Rubber	0.35%
Mixed Nonmetallic	0.24%
Fluid	1.27%
Other	0.52%
Uncategorized	0.00%
Total	100%

- A machine with higher recyclability rate will ensure more efficient usage of valuable natural resources and enhance End-of-Life value of the product. According to ISO 16714:2008 (Earthmoving machinery – Recyclability and recoverability – Terminology and calculation method), recyclability rate is defined as percentage by mass (mass fraction in percent) of the new machine potentially able to be recycled, reused, or both.

All parts in the bill of material are first evaluated by component type based on a list of components defined by the ISO 16714:2008 and Japan CEMA (Construction Equipment Manufacturers Association) standards. Remaining parts are further evaluated for recyclability based on material type.

Because of variations of product configurations, the following value in the table may vary.

Recyclability – 98%

For more complete information on Cat products, dealer services, and industry solutions, visit us on the web at www.cat.com

© 2023 Caterpillar
All rights reserved

Materials and specifications are subject to change without notice. Featured machines in photos may include additional equipment. See your Cat dealer for available options.

CAT, CATERPILLAR, LET'S DO THE WORK, their respective logos, "Caterpillar Corporate Yellow," the "Power Edge" and Cat "Modern Hex" trade dress as well as corporate and product identity used herein, are trademarks of Caterpillar and may not be used without permission. VisionLink is a trademark of Caterpillar Inc., registered in the United States and in other countries.

AEXQ2912-05 (12-2023)
Replaces AEXQ2912-04
Build Number: 07D
(Eur, N Am, Aus-NZ,
S Korea, Chile, Turkey)

