



FM558 GF/ FM558 LL

Forest Machine

Technical Specifications

Configurations and features may vary by region. Please consult your Cat® dealer for availability in your area.

Table of Contents

Specifications	2
Engine	2
Swing Mechanism	2
Weights	2
Undercarriage	2
Drive	2
Hydraulic System	3
Service Refill Capacities	3
Standards	3
Sound Performance	3
Air Conditioning System	3
Dimensions:	
General Forestry	4
Log Loader (Under/Under)	5
Log Loader (Over/Under)	6
Log Loader (Power Clam)	7
Working Ranges and Forces:	
General Forestry	8
Log Loader (Under/Under)	9
Log Loader (Over/Under)	10
Log Loader (Power Clam)	11
Reach Boom Lift Capacities:	
Counterweight: 5.0 mt (11,023 lb)	12
Counterweight: 6.1 mt (13,448 lb)	14
Log Loader Boom Lift Capacities	17
Log Loader (Power Clam) Boom Lift Capacities	24
Matching Guide	28
Bucket Specifications and Compatibility:	
North America	28
Australia and New Zealand	30
Standard and Optional Equipment	31
FM558 GF/FM558 LL Environmental Declaration	33

FM558 GF/FM558 LL Forest Machine Specifications

Engine

Engine Model	Cat® C7.1 TTA	
Engine Power – ISO 9249:2007	222.5 kW	298 hp
Engine Power – ISO 14396:2002	225.1 kW	302 hp
Bore	105 mm	4.13 in
Stroke	135 mm	5.31 in
Displacement	7.1 L	433.3 in ³

- Meets U.S. EPA Tier 4 Final, EU Stage V emission standards.
- Net Power is tested per ISO 9259. Standards in effect at the time of manufacture.
- Net power advertised is the power available at the flywheel when the engine is equipped with fan, air intake system, exhaust system and alternator.
- Rated speed at 1,800 rpm.

Swing Mechanism

Swing Speed	7.4 rpm	
Maximum Swing Torque	154 kN·m	113,584 lbf·ft

Weights

Operating Weight – General Forestry	41 500 kg	91,490 lb
<ul style="list-style-type: none"> • 22" Side Entry Cab (SEC) Riser, High Wide undercarriage, 5.04 mt (11,023 lb) counterweight, Reach boom, R3.2 m (10'2") Reach stick, 700 mm (28") double grouser shoes, 1.76 m³ (2.30 yd³) HD bucket. 		
Operating Weight – Log Loader, Under/Under	44 100 kg	97,220 lb
<ul style="list-style-type: none"> • 48" Rear Entry Cab (REC) Riser, High Wide undercarriage, Log Loader boom, 4.05 m (13'3") Under/Under stick with live heel, 700 mm (28") double grouser shoes, no grapple. 		
Operating Weight – Log Loader, Under/Under	44 700 kg	98,550 lb
<ul style="list-style-type: none"> • 72" REC Riser, High Wide undercarriage, Log Loader boom, 4.05 m (13'3") Under/Under stick with live heel, 700 mm (28") double grouser shoes, no grapple. 		
Operating Weight – Log Loader, Over/Under	44 300 kg	97,660 lb
<ul style="list-style-type: none"> • 48" REC Riser, High Wide undercarriage, Log Loader boom, 4.05 m (13'3") Over/Under stick with live heel, 700 mm (28") double grouser shoes, no grapple. 		
Operating Weight – Log Loader, Power Clam	43 300 kg	95,460 lb
<ul style="list-style-type: none"> • 48" REC Riser, High Wide undercarriage, Log Loader boom, 4.35 m (14'3") Power Clam stick, 700 mm (28") double grouser shoes, no Power Clam. 		

Undercarriage

Undercarriage Pitch	216 mm	8.5 in
Track Gauge	2920 mm	115 in
Track Length	5160 mm	203 in
Ground Clearance (without grouser)	720 mm	28 in
Ground Clearance (with grouser)	770 mm	30 in
Track Shoes Width	850 mm	33 in
Track Shoes Width	710 mm	28 in
Number of Shoes (each side)	50	
Number of Track Rollers (each side)	9	
Number of Carrier Rollers (each side)	2	

Drive

Maximum Travel Speed – Rabbit	4.4 km/h	2.8 mph
Maximum Travel Speed – Turtle	3.0 km/h	1.8 mph
Maximum Drawbar Pull	350 kN	78,638 lbf

FM558 GF/FM558 LL Forest Machine Specifications

Hydraulic System

Main System – Maximum Flow – Implement	534 L/min	141.0 gal/min
Maximum Pressure – Equipment – Implement	35 000 kPa	5,076 psi
Maximum System Pressure – Heavy Lift Mode	38 000 kPa	5,511 psi
Maximum Pressure – Travel	35 000 kPa	5,076 psi
Maximum Pressure – Swing	27 200 kPa	3,945 psi

Auxiliary Pump – Heel/Grapple (FM558 LL)

Maximum Flow	54 L/min	14 gal/min
Maximum Pressure	12 500 kPa	1,813 psi

Auxiliary Pump – Power Clam (FM558 LL)/Road Builder (FM558 GF)

Maximum Flow	153 L/min	40 gal/min
Maximum Pressure	12 500 kPa	1,813 psi

FM558 GF – General Forestry Linkage

Boom Cylinder – Bore	140 mm	6 in
Boom Cylinder – Rod	100 mm	4 in
Boom Cylinder – Stroke	1407 mm	55 in
Stick Cylinder – Bore	150 mm	6 in
Stick Cylinder – Rod	105 mm	4 in
Stick Cylinder – Stroke	1646 mm	65 in
Bucket Cylinder – Bore	135 mm	5 in
Bucket Cylinder – Rod	95 mm	4 in
Bucket Cylinder – Stroke	1156 mm	46 in

FM558 LL – Log Loader Linkage

Boom Cylinder – Bore	150 mm	6 in
Boom Cylinder – Rod	105 mm	4 in
Boom Cylinder – Stroke	1400 mm	55 in
Stick Cylinder – Bore	180 mm	7 in
Stick Cylinder – Rod	130 mm	5 in
Stick Cylinder – Stroke	1651 mm	65 in
Heel (U/U) Cylinder – Bore	150 mm	6 in
Heel (U/U) Cylinder – Rod	105 mm	4 in
Heel (U/U) Cylinder – Stroke	1156 mm	46 in
Heel (O/U) Cylinder – Bore	160 mm	6 in
Heel (O/U) Cylinder – Rod	110 mm	4 in
Heel (O/U) Cylinder – Stroke	1467 mm	58 in

Service Refill Capacities

Fuel Tank Capacity	990.0 L	262 gal
Cooling System	38.0 L	10 gal
Engine Oil (with filter)	25 L	7 gal
Swing Drive (each)	13.5 L	4 gal
Final Drive (each)	9.5 L	3 gal
Hydraulic System (including tank)	348 L	92 gal
Hydraulic Tank	185 L	49 gal
Diesel Exhaust Fluid (DEF) Tank	41 L	11 gal

Standards

Brakes	ISO 10265:2008 ISO 11512:1995
Falling Object Protective Structure (FOPS)	ISO 8083:2006 11,600 J
Operator Protective Structure (OPS)	ISO 8084:2003 WCB G603-2021
Operator Protective Guards (OPG)	SAE J1356 MAR2013 ISO 10262-1998 LV 2
Rollover Protective Structure (ROPS)	ISO 8082-2:2011 OR-OSHA 437-007-0775 (14)

Sound Performance

FM558 GF – General Forestry Linkage

ISO 6395:2008 (external)	102 dB(A)
ISO 6396:2008 (inside cab)	74 dB(A)

FM558 LL – Log Loader Linkage

ISO 6395:2008 (external)	100 dB(A)
ISO 6396:2008 (inside cab)	74 dB(A)

- When properly installed and maintained, the cab offered by Caterpillar, when tested with doors and windows closed according to ANSI/SAE J1166 OCT98, meets OSHA and MSHA requirements for operator sound exposure limits in effect at time of manufacture.
- Hearing protection may be needed when operating with an open operator station and cab (when not properly maintained or doors/windows open) for extended periods or in a noisy environment.

Air Conditioning System

The air conditioning system on this machine contains the fluorinated greenhouse gas refrigerant R134a (Global Warming Potential = 1430). The system contains 2.1 (22" Riser CAB)/2.2 (48"/72" Riser CAB) kg of refrigerant, which as a CO₂ equivalent of 3.003/3.146 metric tonnes.

FM558 GF/FM558 LL Forest Machine Specifications

Dimensions – General Forestry

All dimensions are approximate.

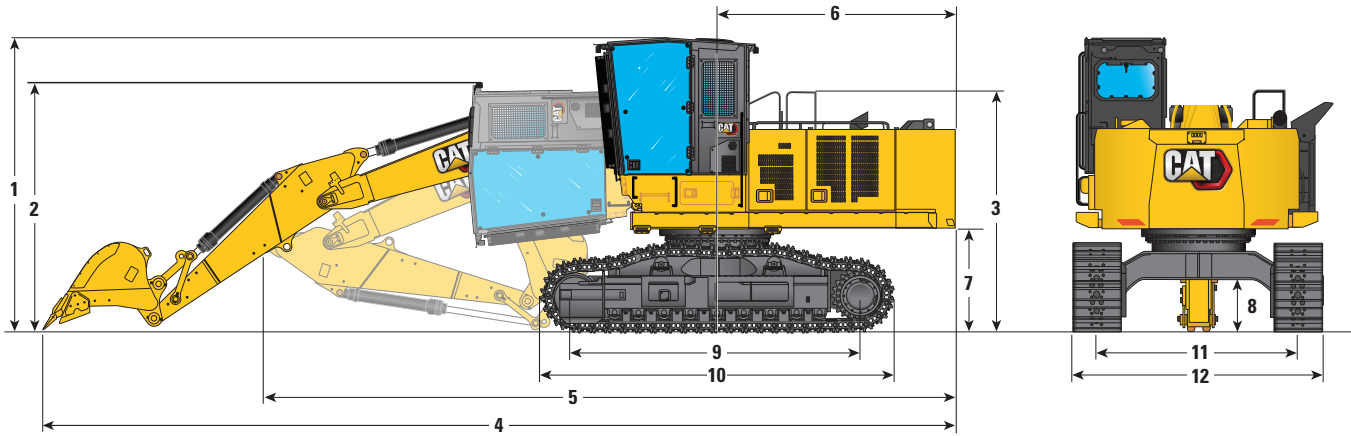

Boom Option

Reach Boom
6.15 m (20'2")

Stick Option

Reach Stick
R3.2CB2 (10'6")

1 Machine Height – Top of Cab – 558 mm (22") Riser	4275 mm	14'5"
2 Shipping Height – Cab Tilted	3760 mm	12'4"
3 Handrail Height	3510 mm	11'6"
4 Shipping Length (with boom and stick stretched out)	14 060 mm	46'2"
5 Shipping Length (with boom and stick retracted)	10 690 mm	35'1"
6 Tail Swing Radius	3530 mm	11'7"
7 Counterweight Clearance	1500 mm	4'11"
8 Ground Clearance	770 mm	2'6"
9 Distance Between Idler/Sprocket Center	4120 mm	13'6"
10 Track Length	5160 mm	16'11"
11 Track Gauge	2920 mm	9'7"
12 Transport Width – 700 mm (28") Track Shoes	3650 mm	12'0"
Bucket Type	HD	
Bucket Capacity	1.76 m ³	2.30 yd ³
Bucket Tip Radius	1660 mm	5.4 ft

FM558 GF/FM558 LL Forest Machine Specifications

Dimensions – Log Loader (Under/Under)

All dimensions are approximate.

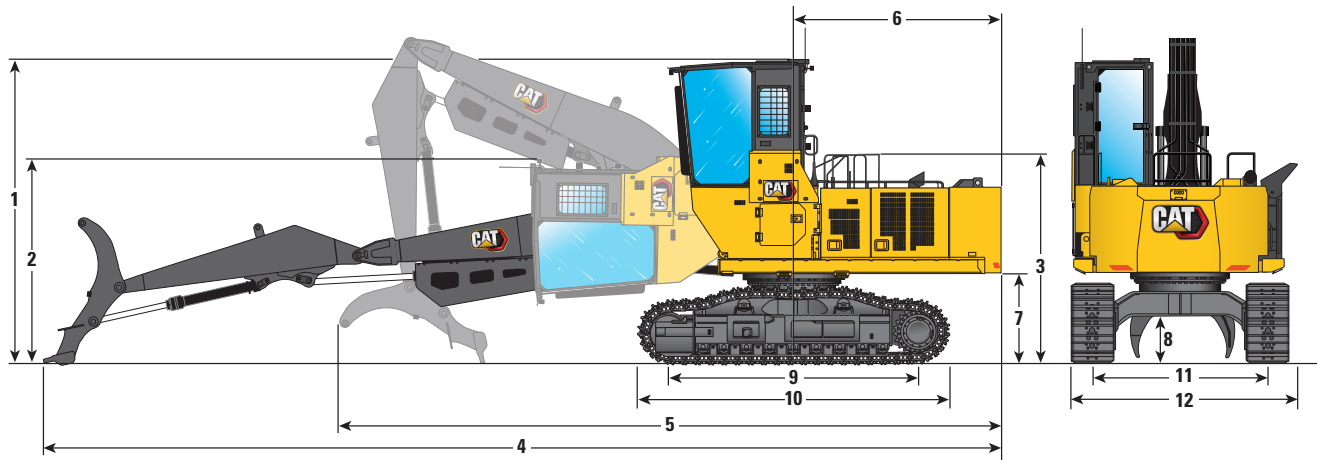

Boom Option

Log Loader Boom
6.80 m (22'4")

Stick Option

Under/Under
4.05 m (13'3")

1 Machine Height – Top of Cab – 1219 mm (48") Riser	5099 mm	16'8"
Machine Height – Top of Cab – 1829 mm (72") Riser	5556 mm	18'2"
2 Cab Height – Cab Tilted	3490 mm	11'5"
3 Handrail Height	3510 mm	11'6"
4 Shipping Length (with boom and heel stretched out)	15 730 mm	51'7"
5 Shipping Length (with boom and heel retracted)	10 230 mm	33'7"
6 Tail Swing Radius	3530 mm	11'7"
7 Counterweight Clearance	1500 mm	4'11"
8 Ground Clearance	770 mm	2'6"
9 Distance Between Idler/Sprocket Center	4120 mm	13'6"
10 Track Length	5160 mm	16'11"
11 Track Gauge	2920 mm	9'7"
12 Transport Width – 700 mm (28") Track Shoes	3650 mm	12'0"

FM558 GF/FM558 LL Forest Machine Specifications

Dimensions – Log Loader (Over/Under)

All dimensions are approximate.

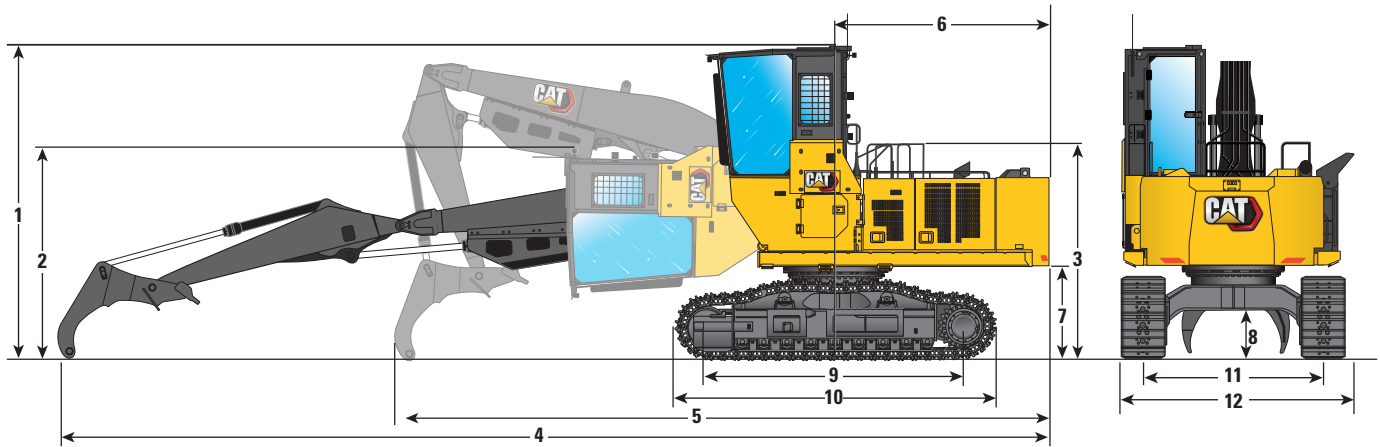

Boom Option

Log Loader Boom
6.80 m (22'4")

Stick Option

Over/Under
4.05 m (13'3")

1 Machine Height – Top of Cab – 1219 mm (48") Riser	5099 mm	16'8"
Machine Height – Top of Cab – 1829 mm (72") Riser	5556 mm	18'2"
2 Shipping Height – Cab Tilted	3520 mm	11'7"
3 Handrail Height	3510 mm	11'6"
4 Shipping Length (with boom and heel stretched out)	15 030 mm	49'4"
5 Shipping Length (with boom and heel retracted)	10 570 mm	34'8"
6 Tail Swing Radius	3530 mm	11'7"
7 Counterweight Clearance	1500 mm	4'11"
8 Ground Clearance	770 mm	2'6"
9 Distance Between Idler/Sprocket Center	4120 mm	13'6"
10 Track Length	5160 mm	16'11"
11 Track Gauge	2920 mm	9'7"
12 Transport Width – 700 mm (28") Track Shoes	3650 mm	12'0"

FM558 GF/FM558 LL Forest Machine Specifications

Dimensions – Log Loader (Power Clam)

All dimensions are approximate.

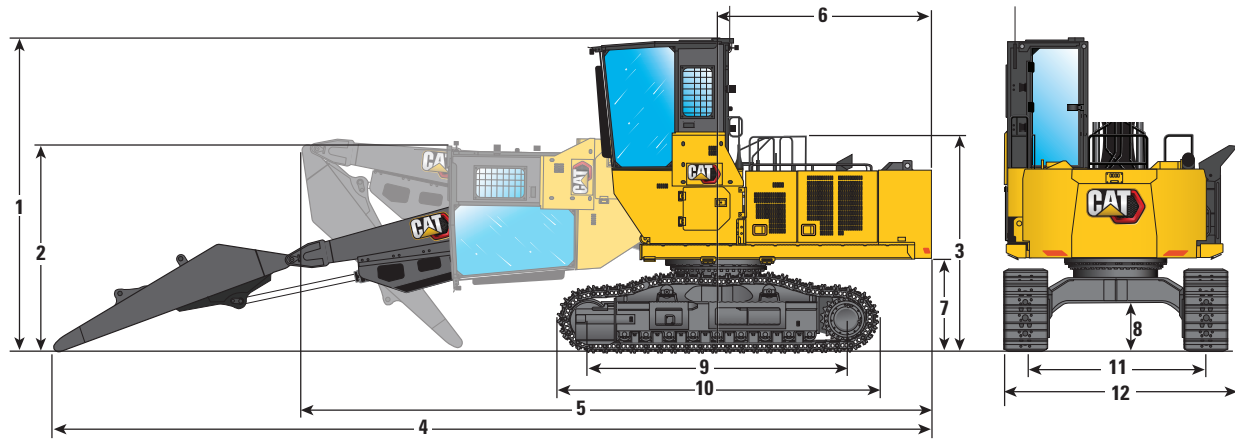

Boom Option

Log Loader Boom
6.80 m (22'4")

Stick Option

Power Clam Stick
4.35 m (14'3")

1 Machine Height – Top of Cab – 1219 mm (48") Riser	5099 mm	16'8"
Machine Height – Top of Cab – 1829 mm (72") Riser	5556 mm	18'2"
2 Shipping Height – Cab Tilted	3520 mm	11'7"
3 Handrail Height	3520 mm	11'7"
4 Shipping Length (with boom out)	14 630 mm	48'0"
5 Shipping Length (with boom stick retracted)	10 580 mm	34'9"
6 Tail Swing Radius	3530 mm	11'7"
7 Counterweight Clearance	1500 mm	4'11"
8 Ground Clearance	770 mm	2'6"
9 Distance Between Idler/Sprocket Center	4120 mm	13'6"
10 Track Length	5160 mm	16'11"
11 Track Gauge	2920 mm	9'7"
12 Width – 700 mm (28") Track Shoes	3650 mm	12'0"

FM558 GF/FM558 LL Forest Machine Specifications

Working Ranges and Forces – General Forestry

All dimensions are approximate.

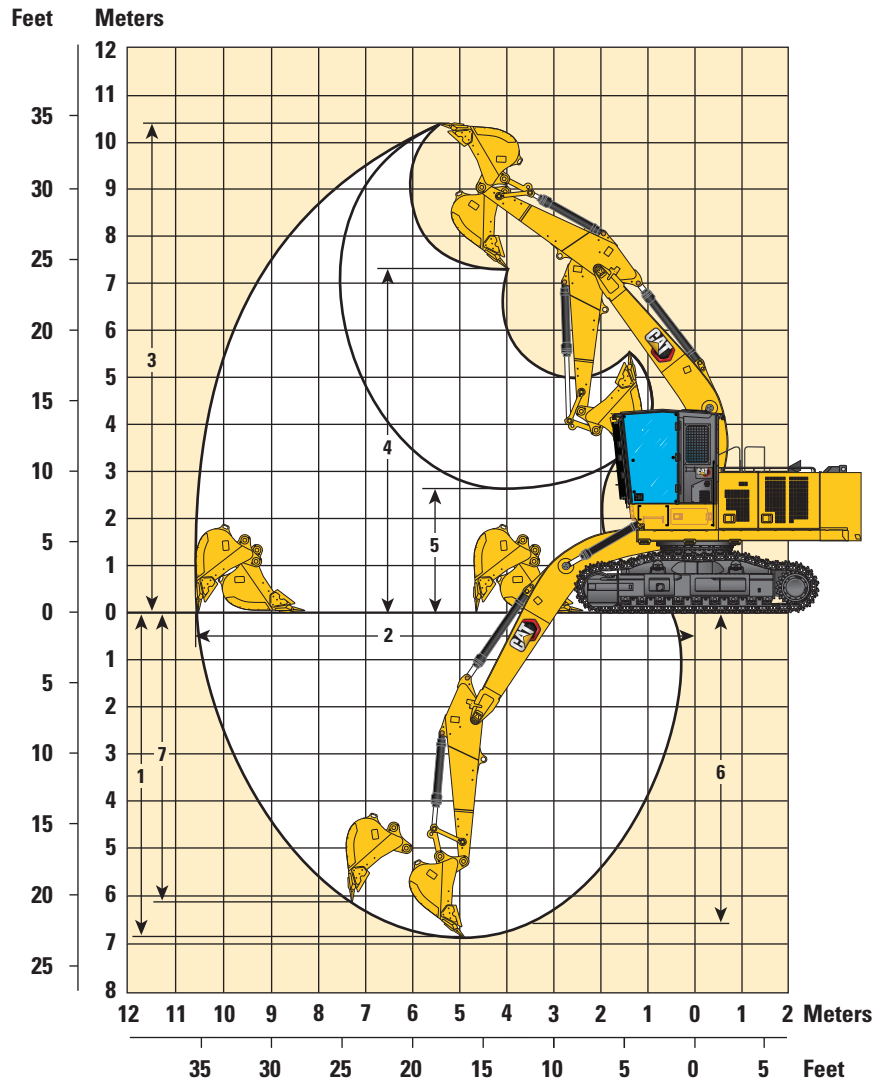

Boom Option	Reach Boom 6.15 m (20'2")	
Stick Option	Reach Stick R3.2CB2 (10'6")	
1 Maximum Digging Depth	6880 mm	22'7"
2 Maximum Reach at Ground Level	10 620 mm	34'10"
Maximum Lift at Ground Level @ 4.5 m (15') Over Side	14 250 kg	33,950 lb
3 Maximum Cutting Height	10 400 mm	34'1"
4 Maximum Loading Height	7310 mm	24'0"
5 Minimum Loading Height	2660 mm	8'9"
6 Maximum Depth Cut for 2440 mm (8'0") Level Bottom	6720 mm	22'1"
7 Maximum Vertical Wall Digging Depth	6080 mm	19'11"
Bucket Digging Force (ISO)	179.0 kN	40,240 lbf
Stick Digging Force (ISO)	126.0 kN	28,330 lbf
Bucket Type	HD	
Bucket Capacity	1.76 m ³	2.30 yd ³
Bucket Tip Radius	1661 mm	5.4 ft

FM558 GF/FM558 LL Forest Machine Specifications

Working Ranges and Forces – Log Loader (Under/Under)*

All dimensions are approximate.

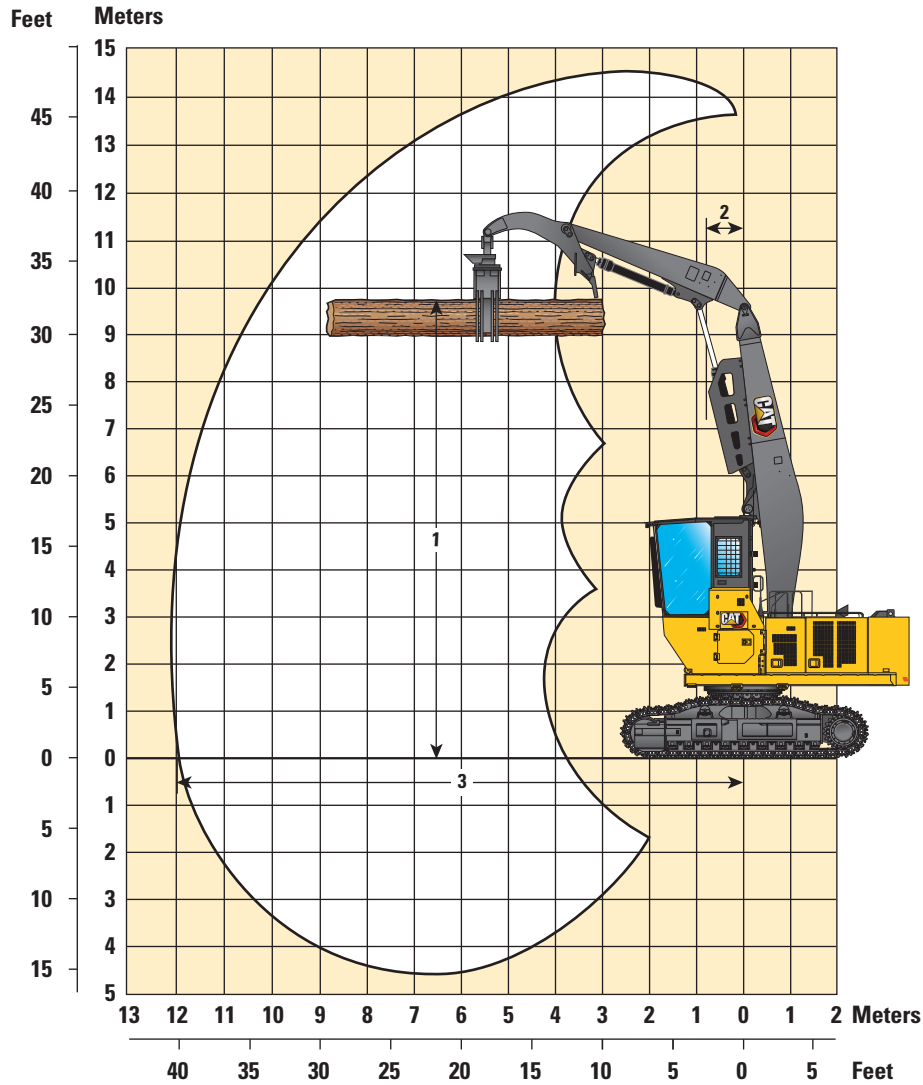

Boom Option	Log Loader Boom 6.8 m (22'4")	
Stick Option	Under/Under 4.05 m (13'3")	
1 Maximum Level Log Height	9811 mm	32'2"
2 Reach at Maximum Height	720 mm	2'4"
Maximum Lift at Ground Level @ 6.0 m (20') Over Front (with live heel)	14 500 kg	31,350 lb
Maximum Lift at Ground Level @ 6.0 m (20') Over Side (with live heel)	12 200 kg	26,250 lb
3 Maximum Reach at Stick Nose at Ground Level	11 980 mm	39'4"

*Weight of grapple is not included and must be deducted from lift values.

FM558 GF/FM558 LL Forest Machine Specifications

Working Ranges and Forces – Log Loader (Over/Under)*

All dimensions are approximate.

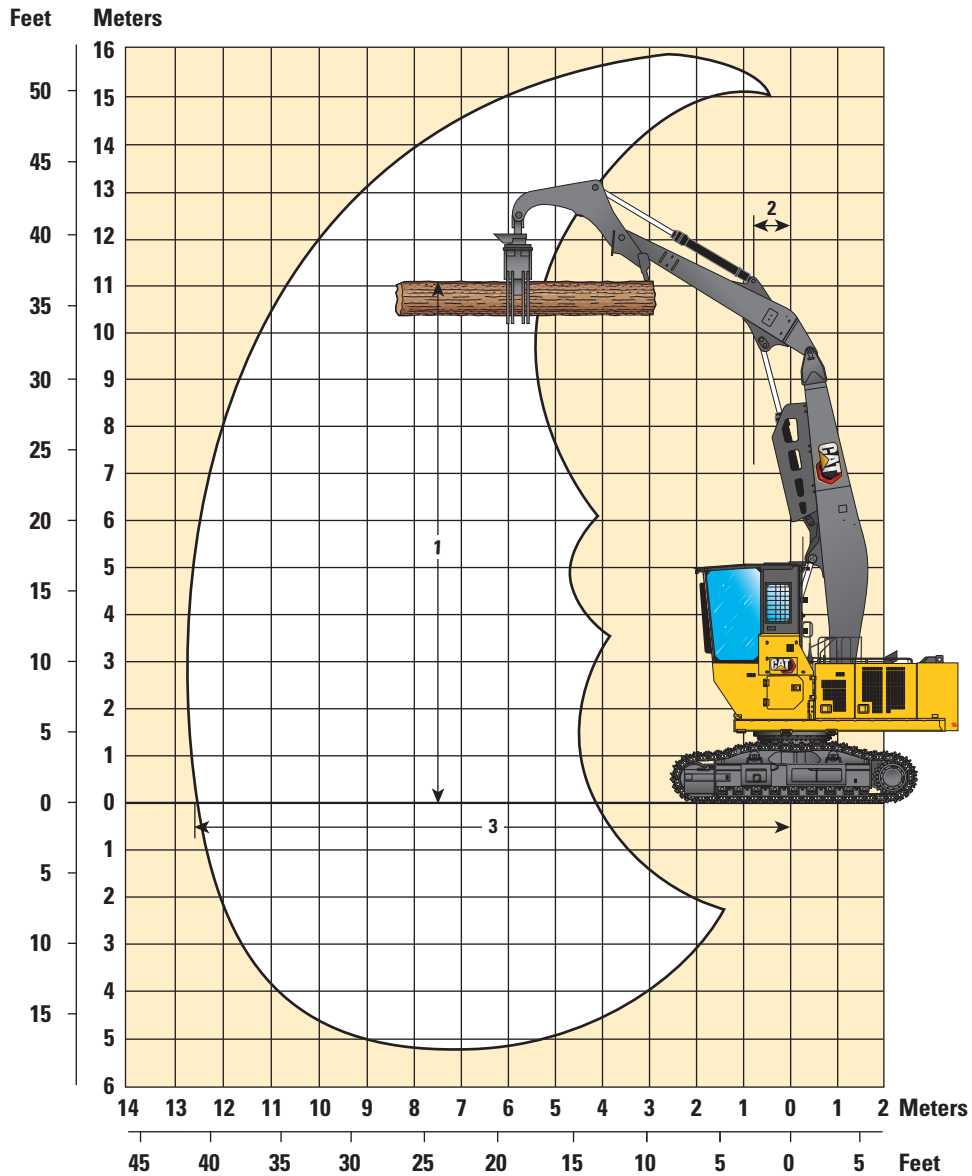

Boom Option

**Log Loader Boom
6.8 m (22'4")**

Stick Option

**Over/Under
4.05 m (13'3")**

1 Maximum Level Log Height	11 165 mm	36'8"
2 Reach at Maximum Height	720 mm	2'4"
Maximum Lift at Ground Level @ 6.0 m (20') Over Front (with live heel)	14 500 kg	31,350 lb
Maximum Lift at Ground Level @ 6.0 m (20') Over Side (with live heel)	12 050 kg	25,950 lb
3 Maximum Reach at Ground Level	12 590 mm	41'4"

*Weight of grapple is not included and must be deducted from lift values.

FM558 GF/FM558 LL Forest Machine Specifications

Working Ranges and Forces – Log Loader (Power Clam)*

All dimensions are approximate.

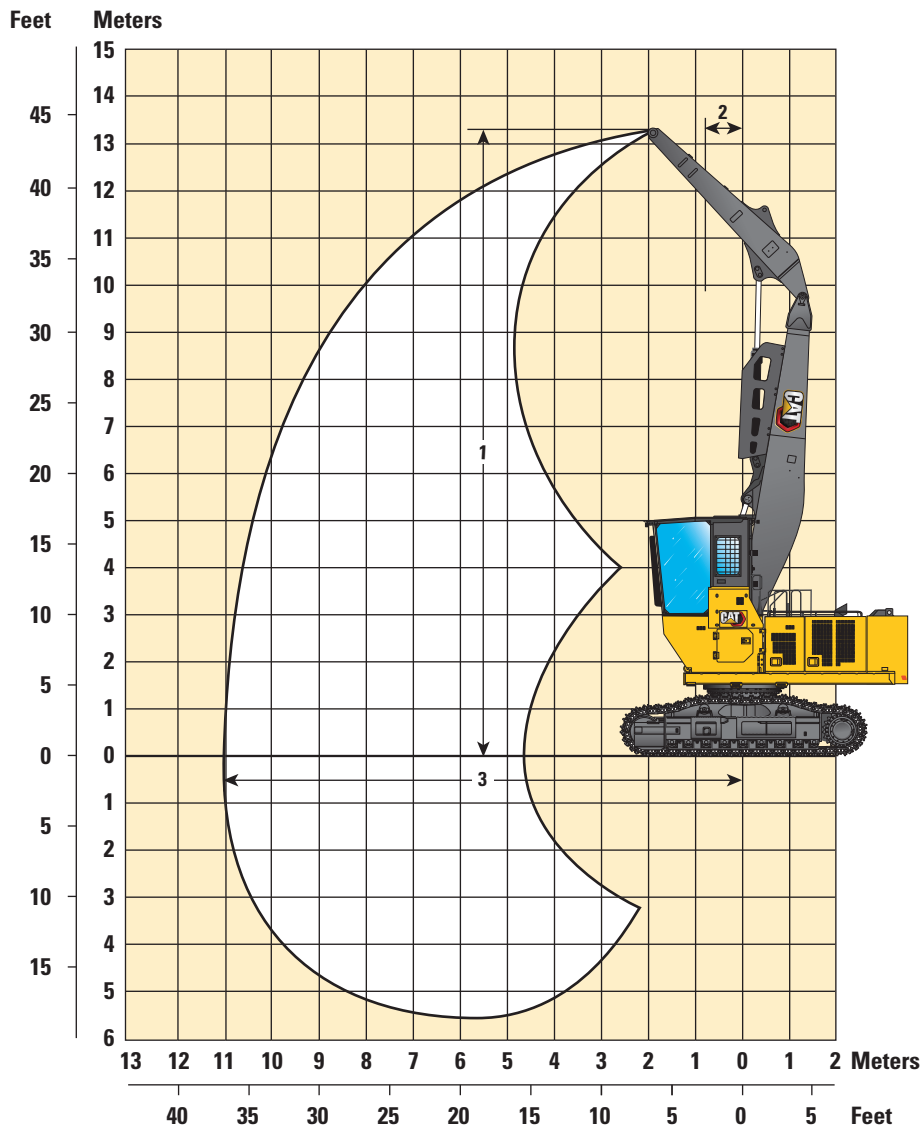

Boom Option

**Log Loader Boom
6.8 m (22'4")**

Stick Option

**Power Clam Stick
4.35 m (14'3")**

1 Maximum Stick Nose Height	13 360 mm	43'10"
2 Maximum Reach at Stick Nose Height	755 mm	2'6"
Maximum Lift at Ground Level @ 6.0 m (20') Over Front (without live heel)	14 200 kg	30,800 lb
Maximum Lift at Ground Level @ 6.0 m (20') Over Side (without live heel)	12 450 kg	26,800 lb
3 Maximum Reach at Stick Nose at Ground Level	11 030 mm	36'2"

*Weight of grapple is not included and must be deducted from lift values.

FM558 GF/FM558 LL Forest Machine Specifications

Reach Boom Lift Capacities – Counterweight: 5.0 mt (11,023 lb) – with Bucket, Heavy Lift: On

General Forestry

3.2 m (10'6") 6.15 m (20'2")

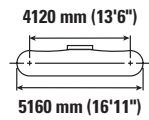
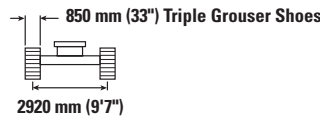

Reach	Unit	3000 mm/10'0"		4500 mm/15'0"		6000 mm/20'0"		7500 mm/25'0"		9000 mm/30'0"		mm ft/in		
		kg lb	kg lb	kg lb	kg lb	kg lb	kg lb	kg lb	kg lb	kg lb	kg lb	kg lb	mm ft/in	
9000 mm 30'0"	kg lb											*3500 *7,500	*3500 *7,500	7200 23'2"
7500 mm 25'0"	kg lb							*5350 *11,000	*5350 *11,000			*3450 *7,600	*3450 *7,600	8250 26'9"
6000 mm 20'0"	kg lb							*6150 *13,500	*6150 *13,500			*3500 *7,700	*3500 *7,700	8910 29'0"
4500 mm 15'0"	kg lb					*7900 *17,050	*7900 *17,050	*6850 *14,900	*6850 *14,900	*5500 *10,750	*5500 *10,750	*3500 *7,700	*3500 *7,700	9430 30'10"
3000 mm 10'0"	kg lb			*14 000 *29,850	*14 000 *29,850	*9650 *20,800	*9650 *20,800	*7750 *16,800	*7750 *16,800	*6750 *14,050	6150 13,150	*3650 *8,000	*3650 *8,000	9670 31'8"
1500 mm 5'0"	kg lb			*11 250 *28,250	*11 250 *28,250	*11 200 *24,100	*11 200 *24,100	*8600 *18,600	8050 17,250	*7150 *15,500	6000 12,900	*3950 *8,700	*3950 *8,700	9660 31'8"
0 mm 0'0"	kg lb			*13 850 *32,900	*13 850 *32,900	*12 000 *25,900	11 100 23,800	*9150 *19,750	7900 16,900	*7350 *14,700	5950 12,750	*4450 *9,800	*4450 *9,800	9400 30'9"
-1500 mm -5'0"	kg lb	*8600 *19,850	*8600 *19,850	*16 350 *35,400	*16 350 *35,400	*12 000 *25,950	11 000 23,650	*9200 *19,800	7800 16,800			*5300 *11,650	*5300 *11,650	8860 29'0"
-3000 mm -10'0"	kg lb	*17 950 *40,600	*17 950 *40,600	*14 800 *31,950	*14 800 *31,950	*11 150 *23,950	10 050 22,750	*8350 *17,800	7850 16,950			*6700 *14,900	*6700 *14,900	8000 26'1"
-4500 mm -15'0"	kg lb			*11 800 *25,150	*11 800 *25,150	*8750 *18,400	*8750 *18,400					*7200 *15,750	*7200 *15,750	6680 21'7"

Reach Boom Lift Capacities – Counterweight: 5.0 mt (11,023 lb) – with Bucket, Heavy Lift: On

General Forestry

3.2 m (10'6") 6.15 m (20'2")

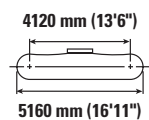
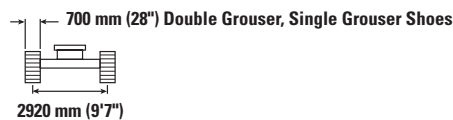

Reach	Unit	3000 mm/10'0"		4500 mm/15'0"		6000 mm/20'0"		7500 mm/25'0"		9000 mm/30'0"		mm ft/in		
		kg lb	kg lb	kg lb	kg lb	kg lb	kg lb	kg lb	kg lb	kg lb	kg lb	kg lb	kg lb	mm ft/in
9000 mm 30'0"	kg lb											*3500 *7,500	*3500 *7,500	7200 23'2"
7500 mm 25'0"	kg lb							*5350 *11,000	*5350 *11,000			*3450 *7,600	*3450 *7,600	8250 26'9"
6000 mm 20'0"	kg lb							*6150 *13,500	*6150 *13,500			*3500 *7,700	*3500 *7,700	8910 29'0"
4500 mm 15'0"	kg lb					*7900 *17,050	*7900 *17,050	*6850 *14,900	*6850 *14,900	*5500 *10,750	*5500 *10,750	*3500 *7,700	*3500 *7,700	9430 30'10"
3000 mm 10'0"	kg lb			*14 000 *29,850	*14 000 *29,850	*9650 *20,800	*9650 *20,800	*7750 *16,800	*7750 *16,800	*6750 *14,050	6000 12,850	*3650 *8,000	*3650 *8,000	9670 31'8"
1500 mm 5'0"	kg lb			*11 250 *28,250	*11 250 *28,250	*11 200 *24,100	11 100 23,850	*8600 *18,600	7850 16,900	*7150 *15,500	5900 12,600	*3950 *8,700	*3950 *8,700	9660 31'8"
0 mm 0'0"	kg lb			*13 850 *32,900	*13 850 *32,900	*12 000 *25,900	10 850 23,300	*9150 *19,750	7700 16,550	*7350 *14,700	5800 12,450	*4450 *9,800	*4450 *9,800	9400 30'9"
-1500 mm -5'0"	kg lb	*8600 *19,850	*8600 *19,850	*16 350 *35,400	*16 350 *35,400	*12 000 *25,950	10 750 23,150	*9200 *19,800	7650 16,400			*5300 *11,650	*5300 *11,650	8860 29'0"
-3000 mm -10'0"	kg lb	*17 950 *40,600	*17 950 *40,600	*14 800 *31,950	*14 800 *31,950	*11 150 *23,950	10 850 23,250	*8350 *17,800	7700 16,550			*6700 *14,900	*6700 *14,900	8000 26'1"
-4500 mm -15'0"	kg lb			*11 800 *25,150	*11 800 *25,150	*8750 *18,400	*8750 *18,400					*7200 *15,750	*7200 *15,750	6680 21'7"



ISO 10567:2007



* Indicates that the load is limited by hydraulic lifting capacity rather than tipping load. The above loads are in compliance with hydraulic excavator lift capacity standard ISO 10567:2007. They do not exceed 87% of hydraulic lifting capacity or 75% of tipping load. Weight of all lifting accessories must be deducted from the above lifting capacities. Lifting capacities are based on the machine standing on a firm, uniform supporting surface. The use of a work tool attachment point to handle/lift objects, could affect the machine lift performance.

Lift capacity stays with ±5% for all available track shoes.

Always refer to the appropriate Operation and Maintenance Manual for specific product information.

FM558 GF/FM558 LL Forest Machine Specifications

Reach Boom Lift Capacities – Counterweight: 5.0 mt (11,023 lb) – without Bucket, Heavy Lift: On

General Forestry

3.2 m (10'6") 6.15 m (20'2")

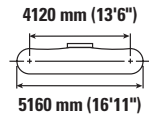
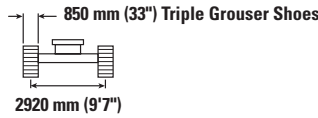

Reach	Unit	1500 mm/5'0"		3000 mm/10'0"		4500 mm/15'0"		6000 mm/20'0"		7500 mm/25'0"		9000 mm/30'0"		mm ft/in		
		kg lb	kg lb	kg lb	kg lb	kg lb	kg lb	kg lb	kg lb	kg lb	kg lb	kg lb	kg lb			
9000 mm 30'0"	kg lb												*5900 *5900	6260		
7500 mm 25'0"	kg lb									*5750 *5750			*5350 *11,850	*5350 *11,850	7570 24'6"	
6000 mm 20'0"	kg lb									*7750 *16,950	*7750 *16,950		*5200 *11,400	*5200 *11,400	8420 27'5"	
4500 mm 15'0"	kg lb					*11 500 *24,700	*11 500 *24,700	*9350 *20,250	*9350 *20,250	*8300 *18,050	*8300 *18,050		*5200 *11,400	*5200 *11,400	8940 29'2"	
3000 mm 10'0"	kg lb					*14 700 *31,600	*14 700 *31,600	*10 900 *23,550	*10 900 *23,550	*9100 *19,700	*9100 *19,600	*6750 *12,300	*6750 *12,300	*5400 *11,850	*5400 *11,850	9180 30'0"
1500 mm 5'0"	kg lb					*17 050 *36,750	*17 050 *36,750	*12 250 *26,450	12 150 26,200	*9800 *21,250	8900 19,150	*7300 *13,100	6900 *13,100	*5750 *12,700	*5750 *12,700	9160 30'0"
0 mm 0'0"	kg lb			*6550 *14,950	*6550 *14,950	*17 900 *38,750	*17 900 *38,750	*13 000 *28,150	11 900 25,650	*10 250 *22,250	8750 18,850			*6450 *14,150	*6450 *14,150	8900 29'2"
-1500 mm -5'0"	kg lb	*8050 *17,950	*8050 *17,950	*12 050 *27,250	*12 050 *27,250	*17 600 *38,100	*17 600 *38,100	*13 050 *28,250	11 850 25,450	*10 200 *22,000	8700 18,750			*7600 *16,750	7550 16,700	8350 27'4"
-3000 mm -10'0"	kg lb			*19 200 *43,550	*19 200 *43,550	*16 150 *34,950	*16 150 *34,950	*12 150 *26,200	11 900 25,600					*9100 *20,050	8850 19,650	7460 24'4"
-4500 mm -15'0"	kg lb			*17 750 *38,050	*17 750 *38,050	*13 100 *27,950	*13 100 *27,950	*9300	*9300					*9050 *19,900	*9050 *19,900	6090 19'8"

Reach Boom Lift Capacities – Counterweight: 5.0 mt (11,023 lb) – without Bucket, Heavy Lift: On

General Forestry

3.2 m (10'6") 6.15 m (20'2")

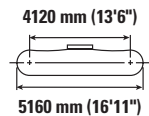
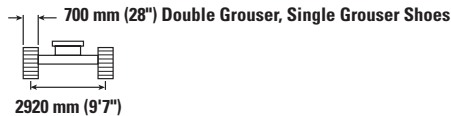

Reach	Unit	1500 mm/5'0"		3000 mm/10'0"		4500 mm/15'0"		6000 mm/20'0"		7500 mm/25'0"		9000 mm/30'0"		mm ft/in		
		kg lb	kg lb	kg lb	kg lb	kg lb	kg lb	kg lb	kg lb	kg lb	kg lb	kg lb	kg lb			
9000 mm 30'0"	kg lb												*5900 *5900	6260		
7500 mm 25'0"	kg lb									*5750 *5750			*5350 *11,850	*5350 *11,850	7570 24'6"	
6000 mm 20'0"	kg lb									*7750 *16,950	*7750 *16,950		*5200 *11,400	*5200 *11,400	8420 27'5"	
4500 mm 15'0"	kg lb					*11 500 *24,700	*11 500 *24,700	*9350 *20,250	*9350 *20,250	*8300 *18,050	*8300 *18,050		*5200 *11,400	*5200 *11,400	8940 29'2"	
3000 mm 10'0"	kg lb					*14 700 *31,600	*14 700 *31,600	*10 900 *23,550	*10 900 *23,550	*9100 *19,700	8950 19,200	*6750 *12,300	*6750 *12,300	*5400 *11,850	*5400 *11,850	9180 30'0"
1500 mm 5'0"	kg lb					*17 050 *36,750	*17 050 *36,750	*12 250 *26,450	11 950 25,700	*9800 *21,250	8700 18,800	*7300 *13,100	6750 *13,100	*5750 *12,700	*5750 *12,700	9160 30'0"
0 mm 0'0"	kg lb			*6550 *14,950	*6550 *14,950	*17 900 *38,750	17 900 38,400	*13 000 *28,150	11 700 25,150	*10 250 *22,250	8600 18,500			*6450 *14,150	*6450 *14,150	8900 29'2"
-1500 mm -5'0"	kg lb	*8050 *17,950	*8050 *17,950	*12 050 *27,250	*12 050 *27,250	*17 600 *38,100	*17 600 *38,100	*13 050 *28,250	11 600 24,950	*10 200 *22,000	8550 18,400			*7600 *16,750	7400 16,350	8350 27'4"
-3000 mm -10'0"	kg lb			*19 200 *43,550	*19 200 *43,550	*16 150 *34,950	*16 150 *34,950	*12 150 *26,200	11 650 25,100					*9100 *20,050	8700 19,250	7460 24'4"
-4500 mm -15'0"	kg lb			*17 750 *38,050	*17 750 *38,050	*13 100 *27,950	*13 100 *27,950	*9300	*9300					*9050 *19,900	*9050 *19,900	6090 19'8"



ISO 10567:2007



* Indicates that the load is limited by hydraulic lifting capacity rather than tipping load. The above loads are in compliance with hydraulic excavator lift capacity standard ISO 10567:2007. They do not exceed 87% of hydraulic lifting capacity or 75% of tipping load. Weight of all lifting accessories must be deducted from the above lifting capacities. Lifting capacities are based on the machine standing on a firm, uniform supporting surface. The use of a work tool attachment point to handle/lift objects, could affect the machine lift performance.

Lift capacity stays with ±5% for all available track shoes.

Always refer to the appropriate Operation and Maintenance Manual for specific product information.

FM558 GF/FM558 LL Forest Machine Specifications

Reach Boom Lift Capacities – Counterweight: 6.1 mt (13,448 lb) – with Bucket, Heavy Lift: On

General Forestry

3.2 m (10'6") 6.15 m (20'2")

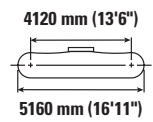
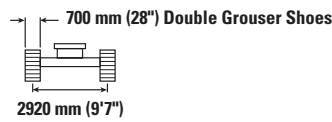

Reach	Unit	3000 mm/10'0"		4500 mm/15'0"		6000 mm/20'0"		7500 mm/25'0"		9000 mm/30'0"		mm ft/in		
		kg lb	kg lb	kg lb	kg lb	kg lb	kg lb	kg lb	kg lb	kg lb	kg lb	kg lb	mm ft/in	
9000 mm 30'0"	kg lb											*3500 *7,450	*3500 *7,450	7200 23'02"
7500 mm 25'0"	kg lb							*5350 *11,000	*5350 *11,000			*3450 *7,600	*3450 *7,600	8250 26'09"
6000 mm 20'0"	kg lb							*6150 *13,500	*6150 *13,500			*3500 *7,700	*3500 *7,700	8910 29'00"
4500 mm 15'0"	kg lb					*7900 *17,050	*7900 *17,050	*6850 *14,900	*6850 *14,900	*5500 *10,750	*5500 *10,750	*3500 *7,700	*3500 *7,700	9430 30'10"
3000 mm 10'0"	kg lb			*14 000 *29,850	*14 000 *29,850	*9650 *20,800	*9650 *20,800	*7750 *16,800	*7750 *16,800	*6750 *14,050	6550 14,000	*3650 *8,000	*3650 *8,000	9670 31'08"
1500 mm 5'0"	kg lb			*11 600 *29,200	*11 600 *29,200	*11 200 *24,100	*11 200 *24,100	*8600 *18,600	*8550 18,350	*7150 *15,500	6400 13,750	*3950 *8,700	*3950 *8,700	9660 31'08"
0 mm 0'0"	kg lb			*14 250 *33,950	*14 250 *33,950	*12 000 *25,900	11 750 25,250	*9150 *19,750	8400 18,000	*7350 *14,700	6350 13,600	*4450 *9,800	*4450 *9,800	9400 30'09"
-1500 mm -5'0"	kg lb	*8900 *20,450	*8900 *20,450	*16 350 *35,400	*16 350 *35,400	*12 000 *25,950	11 650 25,100	*9200 *19,800	8300 17,850			*5300 *11,650	*5300 *11,650	8870 29'00"
-3000 mm -10'0"	kg lb	*18 000 *40,550	*18 000 *40,550	*14 800 *31,950	*14 800 *31,950	*11 150 *24,000	*11 150 *24,000	*8350 *17,800	*8350 *17,800			*6700 *14,900	*6700 *14,900	8010 26'01"
-4500 mm -15'0"	kg lb			*11 800 *25,200	*11 800 *25,200	*8750 *18,400	*8750 *18,400					*7200 *15,750	*7200 *15,750	6690 21'07"

Reach Boom Lift Capacities – Counterweight: 6.1 mt (13,448 lb) – with Bucket, Heavy Lift: On

General Forestry

3.2 m (10'6") 6.15 m (20'2")

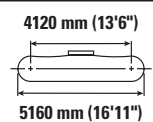
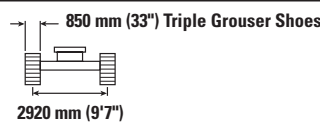

Reach	Unit	3000 mm/10'0"		4500 mm/15'0"		6000 mm/20'0"		7500 mm/25'0"		9000 mm/30'0"		mm ft/in		
		kg lb	kg lb	kg lb	kg lb	kg lb	kg lb	kg lb	kg lb	kg lb	kg lb	kg lb	mm ft/in	
9000 mm 30'0"	kg lb											*3500 *7,450	*3500 *7,450	7200 23'02"
7500 mm 25'0"	kg lb							*5350 *11,000	*5350 *11,000			*3450 *7,600	*3450 *7,600	8250 26'09"
6000 mm 20'0"	kg lb							*6150 *13,500	*6150 *13,500			*3500 *7,700	*3500 *7,700	8910 29'00"
4500 mm 15'0"	kg lb					*7900 *17,050	*7900 *17,050	*6850 *14,900	*6850 *14,900	*5500 *10,750	*5500 *10,750	*3500 *7,700	*3500 *7,700	9430 30'10"
3000 mm 10'0"	kg lb			*14 000 *29,850	*14 000 *29,850	*9650 *20,800	*9650 *20,800	*7750 *16,800	*7750 *16,800	*6750 *14,050	6650 *14,050	*3650 *8,000	*3650 *8,000	9670 31'08"
1500 mm 5'0"	kg lb			*11 600 *29,200	*11 600 *29,200	*11 200 *24,100	*11 200 *24,100	*8600 *18,600	*8600 *18,600	*7150 *15,500	6500 13,950	*3950 *8,700	*3950 *8,700	9660 31'08"
0 mm 0'0"	kg lb			*14 250 *33,950	*14 250 *33,950	*12 000 *25,900	11 900 25,600	*9150 *19,750	8500 18,250	*7350 *14,700	6450 13,800	*4450 *9,800	*4450 *9,800	9400 30'09"
-1500 mm -5'0"	kg lb	*8900 *20,450	*8900 *20,450	*16 350 *35,400	*16 350 *35,400	*12 000 *25,950	11 850 25,400	*9200 *19,800	8450 18,100			*5300 *11,650	*5300 *11,650	8870 29'00"
-3000 mm -10'0"	kg lb	*18 000 *40,550	*18 000 *40,550	*14 800 *31,950	*14 800 *31,950	*11 150 *24,000	*11 150 *24,000	*8350 *17,800	*8350 *17,800			*6700 *14,900	*6700 *14,900	8010 26'01"
-4500 mm -15'0"	kg lb			*11 800 *25,200	*11 800 *25,200	*8750 *18,400	*8750 *18,400					*7200 *15,750	*7200 *15,750	6690 21'07"



ISO 10567:2007



* Indicates that the load is limited by hydraulic lifting capacity rather than tipping load. The above loads are in compliance with hydraulic excavator lift capacity standard ISO 10567:2007. They do not exceed 87% of hydraulic lifting capacity or 75% of tipping load. Weight of all lifting accessories must be deducted from the above lifting capacities. Lifting capacities are based on the machine standing on a firm, uniform supporting surface. The use of a work tool attachment point to handle/lift objects, could affect the machine lift performance.

Lift capacity stays with ±5% for all available track shoes.

Always refer to the appropriate Operation and Maintenance Manual for specific product information.

FM558 GF/FM558 LL Forest Machine Specifications

Reach Boom Lift Capacities – Counterweight: 6.1 mt (13,448 lb) – with Bucket, Heavy Lift: On

General Forestry

3.2 m (10'6") 6.15 m (20'2")

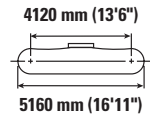
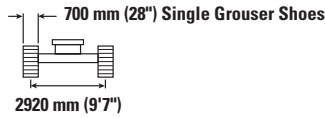

Reach	Unit	3000 mm/10'0"		4500 mm/15'0"		6000 mm/20'0"		7500 mm/25'0"		9000 mm/30'0"		mm ft/in		
		kg	lb	kg	lb	kg	lb	kg	lb	kg	lb	kg	lb	mm
9000 mm 30'0"	kg lb											*3500 *7,450	*3500 *7,450	7200 23'02"
7500 mm 25'0"	kg lb							*5350 *11,000	*5350 *11,000			*3450 *7,600	*3450 *7,600	8250 26'09"
6000 mm 20'0"	kg lb							*6150 *13,500	*6150 *13,500			*3500 *7,700	*3500 *7,700	8910 29'00"
4500 mm 15'0"	kg lb					*7900 *17,050	*7900 *17,050	*6850 *14,900	*6850 *14,900	*5500 *10,750	*5500 *10,750	*3500 *7,700	*3500 *7,700	9430 30'10"
3000 mm 10'0"	kg lb			*14 000 *29,850	*14 000 *29,850	*9650 *20,800	*9650 *20,800	*7750 *16,800	*7750 *16,800	*6750 *14,050	6500 13,900	*3650 *8,000	*3650 *8,000	9670 31'08"
1500 mm 5'0"	kg lb			*11 600 *29,200	*11 600 *29,200	*11 200 *24,100	*11 200 *24,100	*8600 *18,600	8500 18,250	*7150 *15,500	6350 13,650	*3950 *8,700	*3950 *8,700	9660 31'08"
0 mm 0'0"	kg lb			*14 250 *33,950	*14 250 *33,950	*12 000 *25,900	11 700 25,100	*9150 *19,750	8300 17,900	*7350 *14,700	6300 13,500	*4450 *9,800	*4450 *9,800	9400 30'09"
-1500 mm -5'0"	kg lb	*8900 *20,450	*8900 *20,450	*16 350 *35,400	*16 350 *35,400	*12 000 *25,950	11 600 24,900	*9200 *19,800	8250 17,750			*5300 *11,650	*5300 *11,650	8870 29'00"
-3000 mm -10'0"	kg lb	*18 000 *40,550	*18 000 *40,550	*14 800 *31,950	*14 800 *31,950	*11 150 *24,000	*11 150 *24,000	*8350 *17,800	8300 17,700			*6700 *14,900	*6700 *14,900	8010 26'01"
-4500 mm -15'0"	kg lb			*11 800 *25,200	*11 800 *25,200	*8750 *18,400	*8750 *18,400					*7200 *15,750	*7200 *15,750	6690 21'07"

Reach Boom Lift Capacities – Counterweight: 6.1 mt (13,448 lb) – without Bucket, Heavy Lift: On

General Forestry

3.2 m (10'6") 6.15 m (20'2")

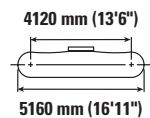
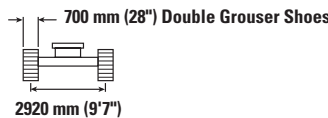

Reach	Unit	1500 mm/5'0"		3000 mm/10'0"		4500 mm/15'0"		6000 mm/20'0"		7500 mm/25'0"		9000 mm/30'0"		mm ft/in		
		kg	lb	kg	lb	kg	lb	kg	lb	kg	lb	kg	lb	kg	lb	mm
9000 mm 30'0"	kg lb													*5900 *5900	6250	
7500 mm 25'0"	kg lb									*5750 *5750				*5350 *11,850	*5350 *11,850	7570 24'06"
6000 mm 20'0"	kg lb									*7750 *16,950	*7750 *16,950			*5200 *11,400	*5200 *11,400	8420 27'05"
4500 mm 15'0"	kg lb					*11 500 *24,700	*11 500 *24,700	*9350 *20,250	*9350 *20,250	*8300 *18,050	*8300 *18,050			*5200 *11,400	*5200 *11,400	8940 29'02"
3000 mm 10'0"	kg lb					*14 700 *31,600	*14 700 *31,600	*10 900 *23,550	*10 900 *23,550	*9050 *19,700	*9050 *19,700	*6750 *12,300	*6750 *12,300	*5400 *11,800	*5400 *11,800	9180 30'00"
1500 mm 5'0"	kg lb					*17 050 *36,750	*17 050 *36,750	*12 250 *26,450	*12 250 *26,450	*9800 *21,250	9400 20,250	*7300 *13,100	*7300 *13,100	*5750 *12,700	*5750 *12,700	9160 30'00"
0 mm 0'0"	kg lb			*6750 *15,350	*6750 *15,350	*17 900 *38,750	*17 900 *38,750	*13 000 *28,150	12 600 27,100	*10 250 *22,250	9250 19,950			*6450 *14,150	*6450 *14,150	8900 29'02"
-1500 mm -5'0"	kg lb	*8250 *18,450	*8250 *18,450	*12 350 *28,000	*12 350 *28,000	*17 600 *38,100	*17 600 *38,100	*13 050 *28,250	12 500 26,900	*10 200 *22,000	9200 19,850			*7600 *16,750	*7600 *16,750	8350 27'04"
-3000 mm -10'0"	kg lb			*19 700 *44,750	*19 700 *44,750	*16 150 *34,950	*16 150 *34,950	*12 150 *26,200	*12 150 *26,200					*9100 *20,050	*9100 *20,050	7470 24'04"
-4500 mm -15'0"	kg lb			*17 750 *38,100	*17 750 *38,100	*13 100 *27,950	*13 100 *27,950	*9300 *9300	*9300 *9300					*9050 *19,900	*9050 *19,900	6090 19'08"



ISO 10567:2007



* Indicates that the load is limited by hydraulic lifting capacity rather than tipping load. The above loads are in compliance with hydraulic excavator lift capacity standard ISO 10567:2007. They do not exceed 87% of hydraulic lifting capacity or 75% of tipping load. Weight of all lifting accessories must be deducted from the above lifting capacities. Lifting capacities are based on the machine standing on a firm, uniform supporting surface. The use of a work tool attachment point to handle/lift objects, could affect the machine lift performance.

Lift capacity stays with ±5% for all available track shoes.

Always refer to the appropriate Operation and Maintenance Manual for specific product information.

FM558 GF/FM558 LL Forest Machine Specifications

Reach Boom Lift Capacities – Counterweight: 6.1 mt (13,448 lb) – without Bucket, Heavy Lift: On

General Forestry

3.2 m (10'6") 6.15 m (20'2")

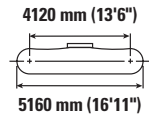
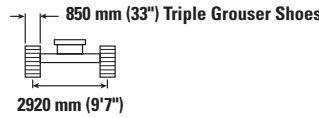

Reach	Unit	1500 mm/5'0"		3000 mm/10'0"		4500 mm/15'0"		6000 mm/20'0"		7500 mm/25'0"		9000 mm/30'0"		mm ft/in		
		kg lb	kg lb	kg lb	kg lb	kg lb	kg lb	kg lb	kg lb	kg lb	kg lb	kg lb	kg lb			
9000 mm 30'0"	kg lb												*5900 *5900	6250		
7500 mm 25'0"	kg lb									*5750 *5750	*5750 *5750		*5350 *11,850	*5350 *11,850	7570 24'06"	
6000 mm 20'0"	kg lb									*7750 *16,950	*7750 *16,950		*5200 *11,400	*5200 *11,400	8420 27'05"	
4500 mm 15'0"	kg lb					*11 500 *24,700	*11 500 *24,700	*9350 *20,250	*9350 *20,250	*8300 *18,050	*8300 *18,050		*5200 *11,400	*5200 *11,400	8940 29'02"	
3000 mm 10'0"	kg lb					*14 700 *31,600	*14 700 *31,600	*10 900 *23,550	*10 900 *23,550	*9050 *19,700	*9050 *19,700	*6750 *12,300	*6750 *12,300	*5400 *11,800	*5400 *11,800	9180 30'00"
1500 mm 5'0"	kg lb					*17 050 *36,750	*17 050 *36,750	*12 250 *26,450	*12 250 *26,450	*9800 *21,250	9500 20,500	*7300 *13,100	*7300 *13,100	*5750 *12,700	*5750 *12,700	9160 30'00"
0 mm 0'0"	kg lb			*6750 *15,350	*6750 *15,350	*17 900 *38,750	*17 900 *38,750	*13 000 *28,150	12 750 27,450	*10 250 *22,250	9350 20,200			*6450 *14,150	*6450 *14,150	8900 29'02"
-1500 mm -5'0"	kg lb	*8250 *18,450	*8250 *18,450	*12 350 *28,000	*12 350 *28,000	*17 600 *38,100	*17 600 *38,100	*13 050 *28,250	12 650 27,500	*10 200 *22,000	9350 20,100			*7600 *16,750	*7600 *16,750	8350 27'04"
-3000 mm -10'0"	kg lb			*19 700 *44,750	*19 700 *44,750	*16 150 *34,950	*16 150 *34,950	*12 150 *26,200	*12 150 *26,200					*9100 *20,050	*9100 *20,050	7470 24'04"
-4500 mm -15'0"	kg lb			*17 750 *38,100	*17 750 *38,100	*13 100 *27,950	*13 100 *27,950	*9300 *9300	*9300 *9300					*9050 *19,900	*9050 *19,900	6090 19'08"

Reach Boom Lift Capacities – Counterweight: 6.1 mt (13,448 lb) – without Bucket, Heavy Lift: On

General Forestry

3.2 m (10'6") 6.15 m (20'2")

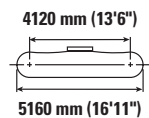
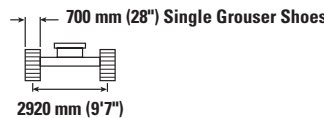

Reach	Unit	1500 mm/5'0"		3000 mm/10'0"		4500 mm/15'0"		6000 mm/20'0"		7500 mm/25'0"		9000 mm/30'0"		mm ft/in		
		kg lb	kg lb	kg lb	kg lb	kg lb	kg lb	kg lb	kg lb	kg lb	kg lb	kg lb	kg lb			
9000 mm 30'0"	kg lb												*5900 *5900	6250		
7500 mm 25'0"	kg lb									*5750 *5750	*5750 *5750		*5350 *11,850	*5350 *11,850	7570 24'06"	
6000 mm 20'0"	kg lb									*7750 *16,950	*7750 *16,950		*5200 *11,400	*5200 *11,400	8420 27'05"	
4500 mm 15'0"	kg lb					*11 500 *24,700	*11 500 *24,700	*9350 *20,250	*9350 *20,250	*8300 *18,050	*8300 *18,050		*5200 *11,400	*5200 *11,400	8940 29'02"	
3000 mm 10'0"	kg lb					*14 700 *31,600	*14 700 *31,600	*10 900 *23,550	*10 900 *23,550	*9050 *19,700	*9050 *19,700	*6750 *12,300	*6750 *12,300	*5400 *11,800	*5400 *11,800	9180 30'00"
1500 mm 5'0"	kg lb					*17 050 *36,750	*17 050 *36,750	*12 250 *26,450	*12 250 *26,450	*9800 *21,250	9350 20,150	*7300 *13,100	*7300 *13,100	*5750 *12,700	*5750 *12,700	9160 30'00"
0 mm 0'0"	kg lb			*6750 *15,350	*6750 *15,350	*17 900 *38,750	*17 900 *38,750	*13 000 *28,150	12 500 26,950	*10 250 *22,250	9200 19,800			*6450 *14,150	*6450 *14,150	8900 29'02"
-1500 mm -5'0"	kg lb	*8250 *18,450	*8250 *18,450	*12 350 *28,000	*12 350 *28,000	*17 600 *38,100	*17 600 *38,100	*13 050 *28,250	12 450 27,500	*10 200 *22,000	9150 19,750			*7600 *16,750	*7600 *16,750	8350 27'04"
-3000 mm -10'0"	kg lb			*19 700 *44,750	*19 700 *44,750	*16 150 *34,950	*16 150 *34,950	*12 150 *26,200	*12 150 *26,200					*9100 *20,050	*9100 *20,050	7470 24'04"
-4500 mm -15'0"	kg lb			*17 750 *38,100	*17 750 *38,100	*13 100 *27,950	*13 100 *27,950	*9300 *9300	*9300 *9300					*9050 *19,900	*9050 *19,900	6090 19'08"



ISO 10567:2007



* Indicates that the load is limited by hydraulic lifting capacity rather than tipping load. The above loads are in compliance with hydraulic excavator lift capacity standard ISO 10567:2007. They do not exceed 87% of hydraulic lifting capacity or 75% of tipping load. Weight of all lifting accessories must be deducted from the above lifting capacities. Lifting capacities are based on the machine standing on a firm, uniform supporting surface. The use of a work tool attachment point to handle/lift objects, could affect the machine lift performance.

Lift capacity stays with ±5% for all available track shoes.



Always refer to the appropriate Operation and Maintenance Manual for specific product information.

FM558 GF/FM558 LL Forest Machine Specifications

Log Loader Boom Lift Capacities – Counterweight: 6.1 mt (13,448 lb) – Heavy Lift: On

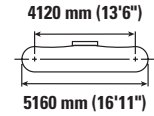
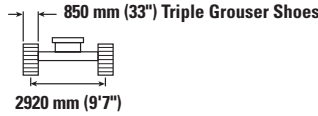
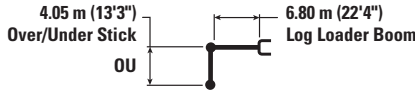
Log Loader with Live Heel (full fuel)



	3000 mm/10'0"		4500 mm/15'0"		6000 mm/20'0"		7500 mm/25'0"		9000 mm/30'0"		10 500 mm/35'0"		12 000 mm/40'0"				mm ft/in
	kg lb	kg lb	kg lb	kg lb	kg lb	kg lb	kg lb	kg lb	kg lb	kg lb	kg lb	kg lb	kg lb	kg lb	kg lb	kg lb	
13 500 mm 45'0"			*15 400 *34,050	*15 400 *34,050	*11 800	*11 800									*11 550 *27,100	*11 550 *27,100	6040 18'4"
12 000 mm 40'0"					*11 500 *25,400	*11 500 *25,400	*10 350 *22,950	*10 350 *21,950							*8650 *19,550	8550 *19,550	8280 26'4"
10 500 mm 35'0"					*10 800 *23,700	*10 800 *23,700	*9700 *21,350	*9700 *21,350	*8900 *19,500	7800 16,550					*7400 *16,500	6550 14,800	9790 31'7"
9000 mm 30'0"					*10 600 *23,150	*10 600 *23,150	*9550 *20,850	*9550 *20,850	*8650 *18,900	7900 16,950	6000 12,700				*6750 *14,850	5550 12,350	10 890 35'4"
7500 mm 25'0"					*10 850 *23,600	*10 850 *23,600	*9650 *21,050	*9650 *21,050	*8650 *18,850	7900 16,900	*7750 *16,900	6050 12,950			*6250 *13,850	4900 10,900	11 680 38'1"
6000 mm 20'0"					*11 550 *25,050	*11 550 *25,050	*10 050 *21,800	*10 050 *21,800	*8850 *19,200	7750 16,650	*7800 *16,900	6000 12,850	*6650 *13,950	4700 10,050	*6050 *13,300	4500 10,000	12 250 40'0"
4500 mm 15'0"					*12 600 *27,300	*12 600 *27,300	*10 550 *22,950	10 100 21,700	*9050 *19,700	7550 16,250	*7850 *16,950	5900 12,650	*6600 *14,050	4700 10,050	*5700 *12,600	4300 9,450	12 610 41'3"
3000 mm 10'0"					*13 750 *29,750	13 600 29,250	*11 100 *24,050	9650 20,800	*9300 *20,100	7300 15,700	*7850 *16,900	5750 12,350	*6400 *13,650	4650 9,950	*5100 *11,300	4200 9,200	12 780 41'10"
1500 mm 5'0"					*14 500 *31,400	12 800 27,600	*11 400 *24,700	9250 19,900	*9300 *20,150	7050 15,200	*7650 *16,500	5600 12,050	*6050 *12,700	4550 9,800	*4500 *9,900	4150 9,150	12 770 41'10"
0 mm 0'0"					*14 500 *31,350	12 200 26,300	*11 250 *24,350	8900 19,100	*9050 *19,450	6850 14,750	*7250 *15,450	5500 11,800	*5250 *10,800	4550 9,750	*3750 *8,250	*3750 *8,250	12 580 41'3"
-1500 mm -5'0"			*9250 *21,600	*9250 *21,600	*13 450 *29,050	11 850 25,500	*10 450 *22,600	8650 18,600	*8250 *17,700	6700 14,450	*6350 *13,400	5400 11,650	*3700 *8,150	*3700	*3150 *6,900	*3150 *6,900	12 150 39'9"
-3000 mm -10'0"		*5400 *12,350	*5400 *12,350	*11 250 *26,000	*11 250 *26,000	*11 350 *24,400	*11 350 *24,400	*8900 *19,050	8550 18,400	*6850 *14,450	6650 14,350	*4700 *9,550	*4700 *9,550		*3550 *7,800	*3550 *7,800	11 120 36'4"
-4500 mm -15'0"					*8200 *17,350	*8200 *17,350	*6400 *13,400	*6400 *13,400							*4700 *10,650	*4700 *10,650	8840 28'3"



ISO 10567:2007



* Indicates that the load is limited by hydraulic lifting capacity rather than tipping load. The above loads are in compliance with hydraulic excavator lift capacity standard ISO 10567:2007. They do not exceed 87% of hydraulic lifting capacity or 75% of tipping load. Weight of all lifting accessories must be deducted from the above lifting capacities. Lifting capacities are based on the machine standing on a firm, uniform supporting surface. The use of a work tool attachment point to handle/lift objects, could affect the machine lift performance.

Lift capacity stays with ±5% for all available track shoes.

Always refer to the appropriate Operation and Maintenance Manual for specific product information.

FM558 GF/FM558 LL Forest Machine Specifications

Log Loader Boom Lift Capacities – Counterweight: 6.1 mt (13,448 lb) – Heavy Lift: On

Log Loader with Live Heel (full fuel)

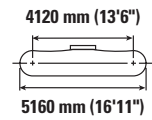
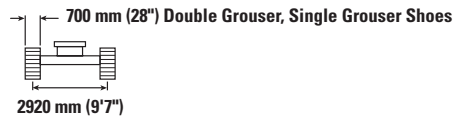
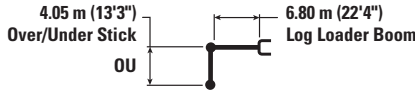

Diagram	3000 mm/10'0"		4500 mm/15'0"		6000 mm/20'0"		7500 mm/25'0"		9000 mm/30'0"		10 500 mm/35'0"		12 000 mm/40'0"		Diagram		mm ft/in
	kg	lb	kg	lb	kg	lb	kg	lb	kg	lb	kg	lb	kg	lb	kg	lb	
13 500 mm 45'0"			*15 400 *34,050	*15 400 *34,050	*11 800	*11 800									*11 550 *27,100	*11 550 *27,100	6040 18'4"
12 000 mm 40'0"					*11 500 *25,400	*11 500 *25,400	*10 350 *22,950	10 150 21,550							*8650 *19,550	8400 19,350	8280 26'4"
10 500 mm 35'0"					*10 800 *23,700	*10 800 *23,700	*9700 *21,350	*9700 *21,350	*8900 *19,500	7650 16,250					*7400 *16,500	6450 14,550	9790 31'7"
9000 mm 30'0"					*10 600 *23,150	*10 600 *23,150	*9550 *20,850	*9550 *20,850	*8650 *18,900	7750 16,650	*7850 *17,050	5850 12,450			*6700 *14,850	5400 12,100	10 890 35'4"
7500 mm 25'0"					*10 850 *23,600	*10 850 *23,600	*9650 *21,050	*9650 *21,050	*8650 *18,850	7750 16,600	*7750 *16,900	5950 12,700			*6250 *13,850	4800 10,650	11 680 38'1"
6000 mm 20'0"					*11 550 *25,050	*11 550 *25,050	*10 050 *21,800	*10 050 *21,800	*8850 *19,200	7600 16,350	*7800 *16,900	5900 12,600	6600 *13,950	4600 9,800	*6050 *13,300	4450 9,750	12 250 40'0"
4500 mm 15'0"					*12 600 *27,300	*12 600 *27,300	*10 550 *22,950	9900 21,300	*9050 *19,700	7400 15,950	*7850 *16,950	5750 12,400	*6600 *14,050	4600 9,850	*5700 *12,600	4200 9,250	12 610 41'3"
3000 mm 10'0"					*13 750 *29,750	13 350 28,750	*11 100 *24,050	9500 20,400	*9300 *20,100	7150 15,400	*7850 *16,900	5650 12,100	*6400 *13,650	4550 9,700	*5100 *11,300	4100 9,000	12 780 41'10"
1500 mm 5'0"					*14 500 *31,400	12 600 27,100	*11 400 *24,700	9050 19,500	*9300 *20,150	6900 14,900	*7650 *16,500	5500 11,800	*6050 *12,700	4450 9,600	*4500 *9,900	4100 8,950	12 770 41'10"
0 mm 0'0"					*14 500 *31,350	12 000 25,800	*11 250 *24,350	8700 18,750	*9050 *19,450	6700 14,450	*7250 *15,450	5350 11,550	*5250 *10,800	4450 9,500	*3750 *8,250	*3750 *8,250	12 580 41'3"
-1500 mm -5'0"			*9250 *21,600	*9250 *21,600	*13 450 *29,050	11 600 25,000	*10 450 *22,600	8500 18,250	*8250 *17,700	6550 14,150	*6350 *13,400	5300 11,400	*3700 *8,100	*3700 *8,100	*3150 *6,900	*3150 *6,900	12 150 39'9"
-3000 mm -10'0"	kg	lb	*5400 *12,350	*5400 *12,350	*11 250 *26,000	*11 250 *26,000	*11 350 *24,400	*11 350 *24,400	*8900 *19,050	8400 18,050	*6850 *14,450	6500 14,050	*4700 *9,550	*4700 *9,550	*3550 *7,800	*3550 *7,800	11 120 36'4"
-4500 mm -15'0"	kg	lb			*8200 *17,350	*8200 *17,350	*6400 *13,400	*6400 *13,400							*4700 *10,650	*4700 *10,650	8840 28'3"



ISO 10567:2007



* Indicates that the load is limited by hydraulic lifting capacity rather than tipping load. The above loads are in compliance with hydraulic excavator lift capacity standard ISO 10567:2007. They do not exceed 87% of hydraulic lifting capacity or 75% of tipping load. Weight of all lifting accessories must be deducted from the above lifting capacities. Lifting capacities are based on the machine standing on a firm, uniform supporting surface. The use of a work tool attachment point to handle/lift objects, could affect the machine lift performance.

Lift capacity stays with ±5% for all available track shoes.



Always refer to the appropriate Operation and Maintenance Manual for specific product information.

FM558 GF/FM558 LL Forest Machine Specifications

Log Loader Boom Lift Capacities – Counterweight: 6.1 mt (13,448 lb) – Heavy Lift: On

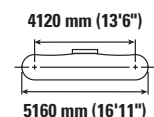
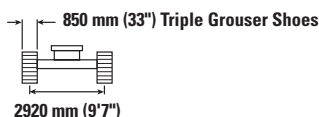
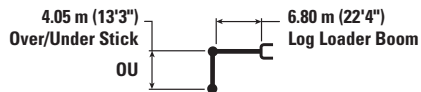
Log Loader with Live Heel (full fuel)



	3000 mm/10'0"		4500 mm/15'0"		6000 mm/20'0"		7500 mm/25'0"		9000 mm/30'0"		10 500 mm/35'0"		12 000 mm/40'0"				mm ft/in
	kg lb	kg lb	kg lb	kg lb	kg lb	kg lb	kg lb	kg lb	kg lb	kg lb	kg lb	kg lb	kg lb	kg lb	kg lb	kg lb	
13 500 mm 45'0"			*15 400 *34,050	*15 400 *34,050	*11 800	*11 800									*11 550 *27,100	*11 550 *27,100	6040 18'4"
12 000 mm 40'0"					*11 500 *25,400	*11 500 *25,400	*10 350 *22,950	*10 350 *22,950							*8650 *19,550	8550 *19,550	8280 26'4"
10 500 mm 35'0"					*10 800 *23,700	*10 800 *23,700	*9700 *21,350	*9700 *21,350	*8900 *19,500	7800 16,600					*7400 *16,500	6600 14,850	9790 31'7"
9000 mm 30'0"					*10 600 *23,150	*10 600 *23,150	*9550 *20,850	*9550 *20,850	*8650 *18,900	7900 16,950	*7850 *17,050	6000 12,700			*6750 *14,800	5550 12,350	10 890 35'4"
7500 mm 25'0"					*10 850 *23,600	*10 850 *23,600	*9650 *21,050	*9650 *21,050	*8650 *18,850	7900 16,950	*7750 *16,900	6050 12,950			*6250 *13,850	4900 10,900	11 680 38'1"
6000 mm 20'0"					*11 550 *25,050	*11 550 *25,050	*10 050 *21,800	*10 050 *21,800	*8850 *19,200	7750 16,700	*7800 *16,900	6000 12,850	*6650 *13,950	4750 10,050	*6050 *13,300	4550 10,000	12 250 40'0"
4500 mm 15'0"					*12 600 *27,300	*12 600 *27,300	*10 550 *22,950	10 100 21,700	*9050 *19,700	7550 16,250	*7850 *16,950	5900 12,650	*6600 *14,050	4700 10,050	*5700 *12,600	4300 9,450	12 610 41'3"
3000 mm 10'0"					*13 750 *29,750	13 600 29,300	*11 100 *24,050	9650 20,800	*9300 *20,100	7300 15,750	*7850 *16,900	5750 12,350	*6400 *13,650	4650 9,950	*5100 *11,300	4200 9,200	12 780 41'10"
1500 mm 5'0"					*14 500 *31,400	12 850 27,650	*11 400 *24,700	9250 19,900	*9300 *20,150	7050 15,200	*7650 *16,500	5600 12,050	*6050 *12,700	4600 9,800	*4500 *9,900	4200 9,200	12 770 41'10"
0 mm 0'0"					*14 500 *31,350	12 250 26,350	*11 250 *24,350	8900 19,150	*9050 *19,450	6850 14,750	*7250 *15,450	5500 11,800	*5250 *10,800	4550 9,750	*3750 *8,250	*3750 *8,250	12 580 41'3"
-1500 mm -5'0"			*9250 *21,600	*9250 *21,600	*13 450 *29,050	11 850 25,550	*10 450 *22,600	8650 18,650	*8250 *17,700	6700 14,450	*6350 *13,400	5450 11,650	*3700 *8,150	*3700 *8,150	*3150 *6,900	*3150 *6,900	12 150 39'9"
-3000 mm -10'0"		*5400 *12,350	*5400 *12,350	*11 250 *26,000	*11 250 *26,000	*11 350 *24,400	*11 350 *24,400	*8900 *19,050	8550 18,450	*6850 *14,450	6650 14,350	*4700 *9,550	*4700 *9,550		*3550 *7,800	*3550 *7,800	11 120 36'4"
-4500 mm -15'0"					*8200 *17,350	*8200 *17,350	*6400 *13,400	*6400 *13,400							*4700 *10,650	*4700 *10,650	8840 28'3"



ISO 10567:2007



* Indicates that the load is limited by hydraulic lifting capacity rather than tipping load. The above loads are in compliance with hydraulic excavator lift capacity standard ISO 10567:2007. They do not exceed 87% of hydraulic lifting capacity or 75% of tipping load. Weight of all lifting accessories must be deducted from the above lifting capacities. Lifting capacities are based on the machine standing on a firm, uniform supporting surface. The use of a work tool attachment point to handle/lift objects, could affect the machine lift performance.

Lift capacity stays with ±5% for all available track shoes.



Always refer to the appropriate Operation and Maintenance Manual for specific product information.

FM558 GF/FM558 LL Forest Machine Specifications

Log Loader Boom Lift Capacities – Counterweight: 6.1 mt (13,448 lb) – Heavy Lift: On

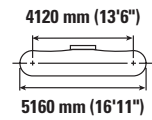
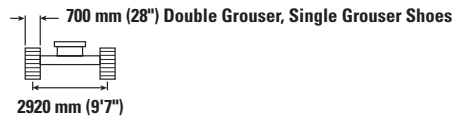
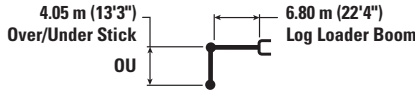
Log Loader with Live Heel (full fuel)



	3000 mm/10'0"		4500 mm/15'0"		6000 mm/20'0"		7500 mm/25'0"		9000 mm/30'0"		10 500 mm/35'0"		12 000 mm/40'0"				mm ft/in
	kg lb	kg lb	kg lb	kg lb	kg lb	kg lb	kg lb	kg lb	kg lb	kg lb	kg lb	kg lb	kg lb	kg lb	kg lb	kg lb	
13 500 mm 45'0"			*15 400 *34,050	*15 400 *34,050	*11 800	*11 800									*11 550 *27,100	*11 550 *27,100	6040 18'4"
12 000 mm 40'0"					*11 500 *25,400	*11 500 *25,400	*10 350 *22,950	10 200 21,600							*8650 *19,550	8400 19,350	8280 26'4"
10 500 mm 35'0"					*10 800 *23,700	*10 800 *23,700	*9700 *21,350	*9700 *21,350	*8900 *19,500	7650 16,300					*7400 *16,500	6450 14,550	9790 31'7"
9000 mm 30'0"					*10 600 *23,150	*10 600 *23,150	*9550 *20,850	*9550 *20,850	*8650 *18,900	7800 16,650	*7850 *17,050	5900 12,450			*6700 *14,850	5450 12,100	10 890 35'4"
7500 mm 25'0"					*10 850 *23,600	*10 850 *23,600	*9650 *21,050	*9650 *21,050	*8650 *18,850	7750 16,650	*7750 *16,900	5950 12,700			*6250 *13,850	4800 10,650	11 680 38'1"
6000 mm 20'0"					*11 550 *25,050	*11 550 *25,050	*10 050 *21,800	*10 050 *21,800	*8850 *19,200	7650 16,400	*7800 *16,900	5900 12,600	*6650 *13,950	4650 9,850	*6050 *13,300	4450 9,800	12 250 40'0"
4500 mm 15'0"					*12 600 *27,300	*12 600 *27,300	*10 550 *22,950	9900 21,350	*9050 *19,700	7450 15,950	*7850 *16,950	5800 12,400	*6600 *14,050	4600 9,850	*5700 *12,600	4200 9,250	12 610 41'3"
3000 mm 10'0"					*13 750 *29,750	13 350 28,800	*11 100 *24,050	9500 20,450	*9300 *20,100	7200 15,450	*7850 *16,900	5650 12,100	*6400 *13,650	4550 9,750	*5100 *11,300	4100 9,000	12 780 41'10"
1500 mm 5'0"					*14 500 *31,400	12 600 27,150	*11 400 *24,700	9050 19,550	*9300 *20,150	6950 14,900	*7650 *16,500	5500 11,800	*6050 *12,700	4500 9,600	*4500 *9,900	4100 8,950	12 770 41'10"
0 mm 0'0"					*14 500 *31,350	12 000 25,850	*11 250 *24,350	8700 18,750	*9050 *19,450	6700 14,450	*7250 *15,450	5400 11,550	*5250 *10,800	4450 9,550	*3750 *8,250	*3750 *8,250	12 580 41'3"
-1500 mm -5'0"			*9250 *21,600	*9250 *21,600	*13 450 *29,050	11 650 25,050	*10 450 *22,600	8500 18,250	*8250 *17,700	6600 14,150	*6350 *13,400	5300 11,400	*3700 *8,100	*3700 *8,100	*3150 *6,900	*3150 *6,900	12 150 39'9"
-3000 mm -10'0"		*5400 *12,350	*5400 *12,350	*11 250 *26,000	*11 250 *26,000	*11 350 *24,400	*11 350 *24,400	*8900 *19,050	8400 18,050	*6850 *14,450	6550 14,050	*4700 *9,550	*4700 *9,550	*3550 *7,800	*3550 *7,800	11 120 36'4"	
-4500 mm -15'0"					*8200 *17,350	*8200 *17,350	*6400 *13,400	*6400 *13,400							*4700 *10,650	*4700 *10,650	8840 28'3"



ISO 10567:2007



* Indicates that the load is limited by hydraulic lifting capacity rather than tipping load. The above loads are in compliance with hydraulic excavator lift capacity standard ISO 10567:2007. They do not exceed 87% of hydraulic lifting capacity or 75% of tipping load. Weight of all lifting accessories must be deducted from the above lifting capacities. Lifting capacities are based on the machine standing on a firm, uniform supporting surface. The use of a work tool attachment point to handle/lift objects, could affect the machine lift performance.

Lift capacity stays with ±5% for all available track shoes.



Always refer to the appropriate Operation and Maintenance Manual for specific product information.

FM558 GF/FM558 LL Forest Machine Specifications

Log Loader Boom Lift Capacities – Counterweight: 6.1 mt (13,448 lb) – Heavy Lift: On

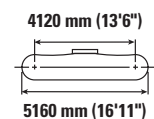
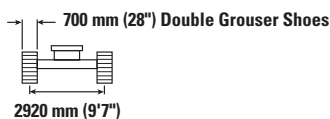
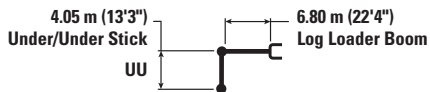
Log Loader with Live Heel (full fuel)



	3000 mm/10'0"		4500 mm/15'0"		6000 mm/20'0"		7500 mm/25'0"		9000 mm/30'0"		10 500 mm/35'0"		12 000 mm/40'0"				mm ft/in
	kg lb	kg lb	kg lb	kg lb	kg lb	kg lb	kg lb	kg lb	kg lb	kg lb	kg lb	kg lb	kg lb	kg lb	kg lb	kg lb	
13 500 mm 45'0"	*19 850 *44,400	*19 850 *44,400	*15 750	*15 750											*15 150 *37,300	*15 150 *37,300	4610 13'2"
12 000 mm 40'0"			*14 450 *31,950	*14 450 *31,950	*12 300 *27,200	*12 300 *27,200									*10 200 *23,150	*10 100 *23,150	7310 23'1"
10 500 mm 35'0"					*11 500 *25,200	*11 500 *25,200	*10 250 *22,450	*10 250 *21,850							*8450 *18,900	7350 16,600	8990 28'11"
9000 mm 30'0"					*11 300 *24,650	*11 300 *24,650	*10 000 *21,900	*10 000 *21,900	*9000 *19,650	7600 16,300					*7550 *16,800	6000 13,450	10 170 33'0"
7500 mm 25'0"					*11 550 *25,200	*11 550 *25,200	*10 150 *22,100	*10 150 *22,100	*9000 *19,550	7650 16,400	*7950 *17,150	5850 12,450			*7050 *15,600	5300 11,700	11 030 35'11"
6000 mm 20'0"			*10 900 *24,550	*10 900 *24,550	*12 300 *26,700	*12 300 *26,700	*10 500 *22,850	10 150 21,850	*9150 *19,850	7550 16,250	*7950 *17,150	5850 12,500			*6750 *14,900	4850 10,650	11 620 38'0"
4500 mm 15'0"					*13 350 *28,900	*13 350 *28,900	*11 050 *23,900	9850 21,200	*9350 *20,250	7400 15,900	*7950 *17,150	5800 12,400			*6100 *13,550	4550 10,100	12 000 39'3"
3000 mm 10'0"					*14 400 *31,100	13 300 28,650	*11 500 *24,850	9500 20,450	*9500 *20,500	7200 15,500	*7850 *16,950	5700 12,200	*6000 4550	4550	*5500 *12,150	4450 9,800	12 180 39'11"
1500 mm 5'0"					*14 900 *32,200	12 650 27,250	*11 650 *25,150	9150 19,700	*9400 *20,300	7000 15,100	*7600 *16,300	5550 11,950	*5400 4550	4550	*4800 *10,600	4450 9,800	12 170 39'10"
0 mm 0'0"					*14 500 *31,350	12 200 26,250	*11 250 *24,350	8850 19,100	*8950 *19,250	6850 14,750	*6950 *14,800	5500 11,800			*4000 *8,800	*4000 *8,800	11 970 39'3"
-1500 mm -5'0"			*8900 *20,750	*8900 *20,750	*13 050 *28,150	11 950 25,650	*10 200 *21,950	8700 18,750	*7950 *16,950	6750 14,550	*5750 *12,000	5450 11,750			*3500 *7,700	*3500 *7,700	11 480 37'7"
-3000 mm -10'0"			*11 700 *27,000	*11 700 *27,000	*10 500 *22,600	*10 500 *22,600	*8250 *17,650	*8250 *17,650	*6150 *12,900	*6150 *12,900					*4050 *9,000	*4050 *9,000	10 250 33'5"



ISO 10567:2007



* Indicates that the load is limited by hydraulic lifting capacity rather than tipping load. The above loads are in compliance with hydraulic excavator lift capacity standard ISO 10567:2007. They do not exceed 87% of hydraulic lifting capacity or 75% of tipping load. Weight of all lifting accessories must be deducted from the above lifting capacities. Lifting capacities are based on the machine standing on a firm, uniform supporting surface. The use of a work tool attachment point to handle/lift objects, could affect the machine lift performance.

Lift capacity stays with ±5% for all available track shoes.

Always refer to the appropriate Operation and Maintenance Manual for specific product information.

FM558 GF/FM558 LL Forest Machine Specifications

Log Loader Boom Lift Capacities – Counterweight: 6.1 mt (13,448 lb) – Heavy Lift: On

Log Loader with Live Heel (full fuel)

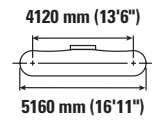
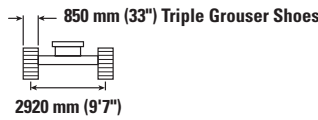
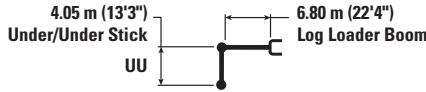

Boom Length	Unit	3000 mm/10'0"		4500 mm/15'0"		6000 mm/20'0"		7500 mm/25'0"		9000 mm/30'0"		10 500 mm/35'0"		12 000 mm/40'0"		mm		ft/in
		kg	lb	kg	lb	kg	lb	kg	lb	kg	lb	kg	lb	kg	lb	kg	lb	
13 500 mm 45'0"	kg lb	*19 850 *44,400	*19 850 *44,400	*15 750	*15 750											*15 150 *37,300	*15 150 *37,300	4610 13'2"
12 000 mm 40'0"	kg lb			*14 450 *31,950	*14 450 *31,950	*12 300 *27,200	*12 300 *27,200									*10 200 *23,150	*10 200 *23,150	7310 23'1"
10 500 mm 35'0"	kg lb					*11 500 *25,200	*11 500 *25,200	*10 250 *22,450	*10 250 *22,150							*8450 *18,900	7450 16,800	8990 28'11"
9000 mm 30'0"	kg lb					*11 300 *24,650	*11 300 *24,650	*10 000 *21,900	*10 000 *21,900	*9000 *19,650	7750 16,500					*7550 *16,800	6100 13,650	10 170 33'0"
7500 mm 25'0"	kg lb					*11 550 *25,200	*11 550 *25,200	*10 150 *22,100	*10 150 *22,100	*9000 *19,550	7750 16,600	*7950 *17,150	5900 12,600			*7050 *15,600	5350 11,900	11 030 35'11"
6000 mm 20'0"	kg lb			*10 900 *24,550	*10 900 *24,550	*12 300 *26,700	*12 300 *26,700	*10 500 *22,850	10 300 22,100	*9150 *19,850	7650 16,450	*7950 *17,150	5950 12,700			*6750 *14,900	4900 10,850	11 620 38'0"
4500 mm 15'0"	kg lb					*13 350 *28,900	*13 350 *28,900	*11 050 *23,900	10 000 21,500	*9350 *20,250	7500 16,150	*7950 *17,150	5850 12,550			*6100 *13,550	4650 10,250	12 000 39'3"
3000 mm 10'0"	kg lb					*14 400 *31,100	13 500 29,050	*11 500 *24,850	9650 20,750	*9500 *20,500	7300 15,750	*7850 *16,950	5750 12,350	*6000 4650		*5500 *12,150	4550 9,950	12 180 39'11"
1500 mm 5'0"	kg lb					*14 900 *32,200	12 850 27,650	*11 650 *25,150	9300 20,000	*9400 *20,300	7100 15,300	*7600 *16,300	5650 12,150	*5400 4600		*4800 *10,600	4550 9,950	12 170 39'10"
0 mm 0'0"	kg lb					*14 500 *31,350	12 350 26,600	*11 250 *24,350	9000 19,400	*8950 *19,250	6950 14,950	*6950 *14,800	5600 12,000			*4000 *8,800	*4000 *8,800	11 970 39'3"
-1500 mm -5'0"	kg lb			*8900 *20,750	*8900 *20,750	*13 050 *28,150	12 100 26,050	*10 200 *21,950	8850 19,000	*7950 *16,950	6850 14,750	*5750 *12,000	5550 11,950			*3500 *7,700	*3500 *7,700	11 480 37'7"
-3000 mm -10'0"	kg lb			*11 700 *27,000	*11 700 *27,000	*10 500 *22,600	*10 500 *22,600	*8250 *17,650	*8250 *17,650	*6150 *12,900	*6150 *12,900					*4050 *9,000	*4050 *9,000	10 250 33'5"



ISO 10567:2007



* Indicates that the load is limited by hydraulic lifting capacity rather than tipping load. The above loads are in compliance with hydraulic excavator lift capacity standard ISO 10567:2007. They do not exceed 87% of hydraulic lifting capacity or 75% of tipping load. Weight of all lifting accessories must be deducted from the above lifting capacities. Lifting capacities are based on the machine standing on a firm, uniform supporting surface. The use of a work tool attachment point to handle/lift objects, could affect the machine lift performance.

Lift capacity stays with ±5% for all available track shoes.

Always refer to the appropriate Operation and Maintenance Manual for specific product information.

FM558 GF/FM558 LL Forest Machine Specifications

Log Loader Boom Lift Capacities – Counterweight: 6.1 mt (13,448 lb) – Heavy Lift: On

Log Loader with Live Heel (full fuel)

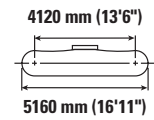
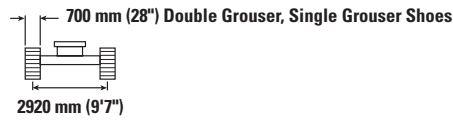
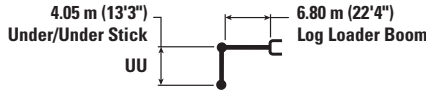

Reach	Unit	3000 mm/10'0"		4500 mm/15'0"		6000 mm/20'0"		7500 mm/25'0"		9000 mm/30'0"		10 500 mm/35'0"		12 000 mm/40'0"		mm ft/in		
		kg lb	kg lb	kg lb	kg lb	kg lb	kg lb	kg lb	kg lb	kg lb	kg lb	kg lb	kg lb	kg lb	kg lb	kg lb	kg lb	
13 500 mm 45'0"	kg lb	*19 850 *44,400	*19 850 *44,400	*15 750	*15 750											*15 150 *37,300	*15 150 *37,300	4610 13'2"
12 000 mm 40'0"	kg lb			*14 450 *31,950	*14 450 *31,950	*12 300 *27,200	*12 300 *27,200									*10 200 *23,150	10 050 *23,150	7310 23'1"
10 500 mm 35'0"	kg lb					*11 500 *25,200	*11 500 *25,200	*10 250 *22,450	10 200 21,750							*8450 *18,900	7300 16,500	8990 28'11"
9000 mm 30'0"	kg lb					*11 300 *24,650	*11 300 *24,650	*10 000 *21,900	*10 000 *21,900	*9000 *19,650	7600 16,200					*7550 *16,800	6000 13,400	10 170 33'0"
7500 mm 25'0"	kg lb					*11 550 *25,200	*11 550 *25,200	*10 150 *22,100	*10 150 *22,100	*9000 *19,550	7600 16,300	*7950 *17,150	5800 12,350			*7050 *15,600	5250 11,650	11 030 35'11"
6000 mm 20'0"	kg lb			*10 900 *24,550	*10 900 *24,550	*12 300 *26,700	*12 300 *26,700	*10 500 *22,850	10 100 21,750	*9150 *19,850	7550 16,150	*7950 *17,150	5800 12,450			*6750 *14,900	4800 10,600	11 620 38'0"
4500 mm 15'0"	kg lb					*13 350 *28,900	*13 350 *28,900	*11 050 *23,900	9800 21,100	*9350 *20,250	7400 15,850	*7950 *17,150	5750 12,300			*6100 *13,550	4550 10,000	12 000 39'3"
3000 mm 10'0"	kg lb					*14 400 *31,100	13 250 28,550	*11 500 *24,850	9450 20,350	*9500 *20,500	7200 15,450	*7850 *16,950	5650 12,100	*6000 4550		*5500 *12,150	4450 9,750	12 180 39'11"
1500 mm 5'0"	kg lb					*14 900 *32,200	12 600 27,150	*11 650 *25,150	9100 19,600	*9400 *20,300	7000 15,000	*7600 *16,300	5550 11,900	*5400 4500		*4800 *10,600	4450 9,750	12 170 39'10"
0 mm 0'0"	kg lb					*14 500 *31,350	12 150 26,100	*11 250 *24,350	8850 19,000	*8950 *19,250	6800 14,650	*6950 *14,800	5450 11,750			*4000 *8,800	*4000 *8,800	11 970 39'3"
-1500 mm -5'0"	kg lb			*8900 *20,750	*8900 *20,750	*13 050 *28,150	11 850 25,550	*10 200 *21,950	8650 18,650	*7950 *16,950	6700 14,450	*5750 *12,000	5450 11,700			*3500 *7,700	*3500 *7,700	11 480 37'7"
-3000 mm -10'0"	kg lb			*11 700 *27,000	*11 700 *27,000	*10 500 *22,600	*10 500 *22,600	*8250 *17,650	*8250 *17,650	*6150 *12,900	*6150 *12,900					*4050 *9,000	*4050 *9,000	10 250 33'5"



ISO 10567:2007



* Indicates that the load is limited by hydraulic lifting capacity rather than tipping load. The above loads are in compliance with hydraulic excavator lift capacity standard ISO 10567:2007. They do not exceed 87% of hydraulic lifting capacity or 75% of tipping load. Weight of all lifting accessories must be deducted from the above lifting capacities. Lifting capacities are based on the machine standing on a firm, uniform supporting surface. The use of a work tool attachment point to handle/lift objects, could affect the machine lift performance.

Lift capacity stays with ±5% for all available track shoes.

Always refer to the appropriate Operation and Maintenance Manual for specific product information.

FM558 GF/FM558 LL Forest Machine Specifications

Log Loader (Power Clam) Boom Lift Capacities – Counterweight: 6.1 mt (13,448 lb) – Heavy Lift: On

Log Loader (Power Clam) without Live Heel (full fuel)

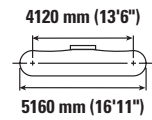
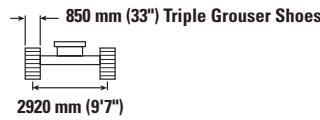
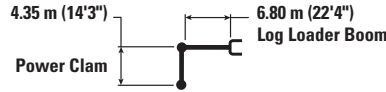

		4500 mm/15'0"		6000 mm/20'0"		7500 mm/25'0"		9000 mm/30'0"		10 500 mm/35'0"		mm ft/in		
12 000 mm 40'0"	kg lb	*16 950 *37,800	*16 950 *37,800									*15 250 *35,450	*15 250 *35,450	5620 17'3"
10 500 mm 35'0"	kg lb	*15 450 *33,950	*15 450 *33,950	*13 150 *28,900	*13 150 *28,900	*11 750 *24,600	10 350					*11 650 *26,250	9900 22,550	7680 24'6"
9000 mm 30'0"	kg lb	*15 100 *32,900	*15 100 *32,900	*12 800 *28,000	*12 800 *28,000	*11 250 *24,650	10 600 22,750	*10 050	7850			*10 050 *22,350	7750 17,400	9040 29'3"
7500 mm 25'0"	kg lb	*15 600 *33,850	*15 600 *33,850	*13 050 *28,400	*13 050 *28,400	*11 300 *24,600	10 600 22,750	*9950 *21,600	8000 17,100			*8950 *19,900	6700 14,850	9990 32'6"
6000 mm 20'0"	kg lb	*16 300 *36,350	*16 300 *36,350	*13 750 *29,800	*13 750 *29,800	*11 600 *25,200	10 400 22,450	*10 000 *21,650	7950 17,050	*8400	6250	*8150 *18,050	6100 13,450	10 650 34'9"
4500 mm 15'0"	kg lb			*14 650 *31,750	14 100 30,400	*12 000 *25,950	10 150 21,900	*10 050 *21,800	7800 16,800	*8350 *17,950	6200 13,350	*7400 *16,350	5750 12,650	11 060 36'2"
3000 mm 10'0"	kg lb			*15 400 *33,350	13 550 29,200	*12 250 *26,500	9900 21,300	*10 050 *21,700	7650 16,450	*8150 *17,400	6150 13,250	*6650 *14,650	5550 12,250	11 250 36'10"
1500 mm 5'0"	kg lb			*15 400 *33,400	13 050 28,150	*12 100 *26,200	9600 20,700	*9750 *21,000	7500 16,150	*7600 *16,100	6100 13,100	*5800 *12,800	5550 12,250	11 240 36'10"
0 mm 0'0"	kg lb			*14 400 *31,200	12 750 27,500	*11 350 *24,500	9450 20,300	*8950 *19,200	7400 15,950	*6500 *13,450	6050 13,100	*4800 *10,600	4800 *10,600	11 030 36'1"
-1500 mm -5'0"	kg lb	*9800 *22,850	*9800 *22,850	*12 250 *26,550	*12 250 *26,550	*9750 *21,000	9350 20,150	*7450 *15,800	7400 *15,800			*4600 *10,150	*4600 *10,150	10 380 33'11"
-3000 mm -10'0"	kg lb			*9050 *19,450	*9050 *19,450	*7200 *15,250	*7200 *15,250					*5800 *12,950	*5800 *12,950	8480 27'4"



ISO 10567:2007



* Indicates that the load is limited by hydraulic lifting capacity rather than tipping load. The above loads are in compliance with hydraulic excavator lift capacity standard ISO 10567:2007. They do not exceed 87% of hydraulic lifting capacity or 75% of tipping load. Weight of all lifting accessories must be deducted from the above lifting capacities. Lifting capacities are based on the machine standing on a firm, uniform supporting surface. The use of a work tool attachment point to handle/lift objects, could affect the machine lift performance.

Lift capacity stays with ±5% for all available track shoes.



Always refer to the appropriate Operation and Maintenance Manual for specific product information.

FM558 GF/FM558 LL Forest Machine Specifications

Log Loader (Power Clam) Boom Lift Capacities – Counterweight: 6.1 mt (13,448 lb) – Heavy Lift: On

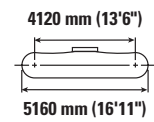
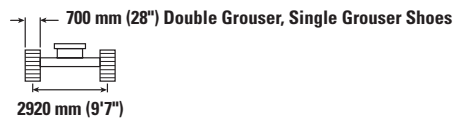
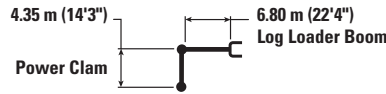
Log Loader (Power Clam) without Live Heel (full fuel)



		4500 mm/15'0"		6000 mm/20'0"		7500 mm/25'0"		9000 mm/30'0"		10 500 mm/35'0"				mm ft/in
		kg lb	kg lb	kg lb	kg lb	kg lb	kg lb	kg lb	kg lb	kg lb	kg lb	kg lb	kg lb	
12 000 mm 40'0"	kg lb	*16 950 *37,800	*16 950 *37,800									*15 250 *35,450	*15 250 *35,450	5620 17'3"
10 500 mm 35'0"	kg lb	*15 450 *33,950	*15 450 *33,950	*13 150 *28,900	*13 150 *28,900	*11 750 10 150	10 150					*11 650 *26,250	9700 22,200	7680 24'6"
9000 mm 30'0"	kg lb	*15 100 *32,900	*15 100 *32,900	*12 800 *28,000	*12 800 *28,000	*11 250 *24,650	10 450 22,350	*10 050	7700			*10 050 *22,350	7650 17,100	9040 29'3"
7500 mm 25'0"	kg lb	*15 600 *33,850	*15 600 *33,850	*13 050 *28,400	*13 050 *28,400	*11 300 *24,600	10 400 22,400	*9950 *21,600	7850 16,800			*8950 *19,900	6550 14,600	9990 32'6"
6000 mm 20'0"	kg lb	*16 300 *36,350	*16 300 *36,350	*13 750 *29,800	*13 750 *29,800	*11 600 *25,200	10 250 22,050	*10 000 *21,650	7800 16,750	*8400	6100	*8150 *18,050	5950 13,200	10 650 34'9"
4500 mm 15'0"	kg lb			*14 650 *31,750	13 900 29,900	*12 000 *25,950	10 000 21,550	*10 050 *21,800	7650 16,500	*8350 *17,950	6100 13,100	*7400 *16,350	5600 12,400	11 060 36'2"
3000 mm 10'0"	kg lb			*15 400 *33,400	13 300 28,700	*12 250 *26,500	9700 20,900	*10 050 *21,700	7500 16,150	*8150 *17,400	6050 13,000	*6650 *14,650	5450 12,050	11 250 36'10"
1500 mm 5'0"	kg lb			*15 400 *33,400	12 850 27,650	*12 100 *26,200	9450 20,350	*9750 *21,000	7350 15,850	*7600 *16,100	6000 12,850	*5800 *12,800	5450 12,000	11 240 36'10"
0 mm 0'0"	kg lb			*14 400 *31,200	12 550 27,000	*11 350 *24,500	9250 19,950	*8950 *19,200	7250 15,650	*6500 *13,450	5950 12,850	*4800 *10,600	*4800 *10,600	11 030 36'1"
-1500 mm -5'0"	kg lb	*9800 *22,850	*9800 *22,850	*12 250 *26,550	*12 250 *26,550	*9750 *21,000	9200 19,800	*7450 *15,800	7250 15,600			*4600 *10,150	*4600 *10,150	10 380 33'11"
-3000 mm -10'0"	kg lb			*9050 *19,450	*9050 *19,450	*7200 *15,250	*7200 *15,250					*5800 *12,950	*5800 *12,950	8480 27'4"



ISO 10567:2007



* Indicates that the load is limited by hydraulic lifting capacity rather than tipping load. The above loads are in compliance with hydraulic excavator lift capacity standard ISO 10567:2007. They do not exceed 87% of hydraulic lifting capacity or 75% of tipping load. Weight of all lifting accessories must be deducted from the above lifting capacities. Lifting capacities are based on the machine standing on a firm, uniform supporting surface. The use of a work tool attachment point to handle/lift objects, could affect the machine lift performance.

Lift capacity stays with ±5% for all available track shoes.



Always refer to the appropriate Operation and Maintenance Manual for specific product information.

FM558 GF/FM558 LL Forest Machine Specifications

Log Loader (Power Clam) Boom Lift Capacities – Counterweight: 6.1 mt (13,448 lb) – Heavy Lift: On

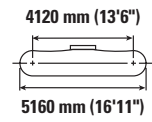
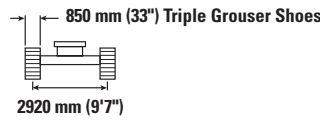
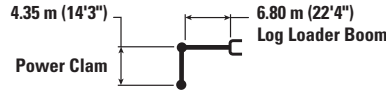
Log Loader (Power Clam) without Live Heel (full fuel)



	4500 mm/15'0"		6000 mm/20'0"		7500 mm/25'0"		9000 mm/30'0"		10 500 mm/35'0"				mm ft/in	
	kg lb	kg lb	kg lb	kg lb	kg lb	kg lb	kg lb	kg lb	kg lb	kg lb	kg lb	kg lb		
12 000 mm 40'0"	*16 950 *37,800	*16 950 *37,800										*15 250 *35,450	*15 250 *35,450	5620 17'3"
10 500 mm 35'0"	*15 450 *33,950	*15 450 *33,950	*13 150 *28,900	*13 150 *28,900	*11 750 *24,600	10 350						*11 650 *26,250	9900 22,600	7680 24'6"
9000 mm 30'0"	*15 100 *32,900	*15 100 *32,900	*12 800 *28,000	*12 800 *28,000	*11 250 *24,650	10 600 22,800	*10 050	7850				*10 050 *22,350	7800 17,450	9040 29'3"
7500 mm 25'0"	*15 600 *33,850	*15 600 *33,850	*13 050 *28,400	*13 050 *28,400	*11 300 *24,600	10 600 22,800	*9950 *21,600	8000 17,150				*8950 *19,900	6700 14,900	9990 32'6"
6000 mm 20'0"	*16 300 *36,350	*16 300 *36,350	*13 750 *29,800	*13 750 *29,800	*11 600 *25,200	10 450 22,450	*10 000 *21,650	7950 17,050	*8400	6250		*8150 *18,050	6100 13,450	10 650 34'9"
4500 mm 15'0"			*14 650 *31,750	14 150 30,450	*12 000 *25,950	10 200 21,950	*10 050 *21,800	7800 16,800	*8350 *17,950	6200 13,350		*7400 *16,350	5750 12,650	11 060 36'2"
3000 mm 10'0"			*15 400 *33,500	13 550 29,250	*12 250 *26,500	9900 21,300	*10 050 *21,700	7650 16,500	*8150 *17,400	6150 13,250		*6650 *14,650	5600 12,300	11 250 36'10"
1500 mm 5'0"			*15 400 *33,400	13 100 28,200	*12 100 *26,200	9650 20,750	*9750 *21,000	7500 16,200	*7600 *16,100	6100 13,150		*5800 *12,800	5600 12,250	11 240 36'10"
0 mm 0'0"			*14 400 *31,200	12 800 27,550	*11 350 *24,500	9450 20,350	*8950 *19,200	7400 16,000	*6500 *13,450	6050 13,100		*4800 *10,600	*4800 *10,600	11 030 36'1"
-1500 mm -5'0"	kg lb	*9800 *22,850	*9800 *22,850	*12 250 *26,550	*12 250 *26,550	*9750 *21,000	9350 20,200	*7450 *15,800	7400 *15,800			*4600 *10,150	*4600 *10,150	10 380 33'11"
-3000 mm -10'0"	kg lb			*9050 *19,450	*9050 *19,450	*7200 *15,250	*7200 *15,250					*5800 *12,950	*5800 *12,950	8480 27'4"



ISO 10567:2007



* Indicates that the load is limited by hydraulic lifting capacity rather than tipping load. The above loads are in compliance with hydraulic excavator lift capacity standard ISO 10567:2007. They do not exceed 87% of hydraulic lifting capacity or 75% of tipping load. Weight of all lifting accessories must be deducted from the above lifting capacities. Lifting capacities are based on the machine standing on a firm, uniform supporting surface. The use of a work tool attachment point to handle/lift objects, could affect the machine lift performance.

Lift capacity stays with ±5% for all available track shoes.

Always refer to the appropriate Operation and Maintenance Manual for specific product information.

FM558 GF/FM558 LL Forest Machine Specifications

Log Loader (Power Clam) Boom Lift Capacities – Counterweight: 6.1 mt (13,448 lb) – Heavy Lift: On

Log Loader (Power Clam) without Live Heel (full fuel)

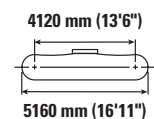
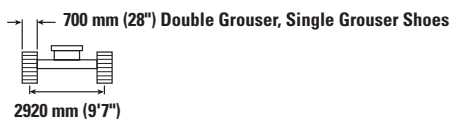
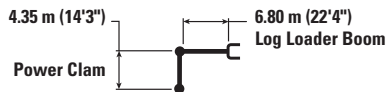

Boom Length	Unit	4500 mm/15'0"		6000 mm/20'0"		7500 mm/25'0"		9000 mm/30'0"		10 500 mm/35'0"		mm ft/in		
		kg lb	kg lb	kg lb	kg lb	kg lb	kg lb	kg lb	kg lb	kg lb	kg lb	kg lb	kg lb	
12 000 mm 40'0"	kg lb	*16 950 *37,800	*16 950 *37,800									*15 250 *35,450	*15 250 *35,450	5620 17'3"
10 500 mm 35'0"	kg lb	*15 450 *33,950	*15 450 *33,950	*13 150 *28,900	*13 150 *28,900	*11 750 *24,650	10 200					*11 650 *26,250	9750 22,200	7680 24'6"
9000 mm 30'0"	kg lb	*15 100 *32,900	*15 100 *32,900	*12 800 *28,000	*12 800 *28,000	*11 250 *24,650	10 450 22,400	*10 050	7700			*10 050 *22,350	7650 17,150	9040 29'3"
7500 mm 25'0"	kg lb	*15 600 *33,850	*15 600 *33,850	*13 050 *28,400	*13 050 *28,400	*11 300 *24,650	10 400 22,400	*9950 *21,600	7850 16,850			*8950 *19,900	6600 14,600	9990 32'6"
6000 mm 20'0"	kg lb	*16 300 *36,350	*16 300 *36,350	*13 750 *29,800	*13 750 *29,800	*11 600 *25,200	10 250 22,100	*10 000 *21,650	7800 16,750	*8400	6100	*8150 *18,050	5950 13,200	10 650 34'9"
4500 mm 15'0"	kg lb			*14 650 *31,750	13 900 29,950	*12 000 *25,950	10 000 21,550	*10 050 *21,800	7700 16,500	*8350 *17,950	6100 13,100	*7400 *16,350	5650 12,400	11 060 36'2"
3000 mm 10'0"	kg lb			*15 400 *33,500	13 350 28,750	*12 250 *26,500	9700 20,950	*10 050 *21,700	7500 16,200	*8150 *17,400	6050 13,000	*6650 *14,650	5450 12,050	11 250 36'10"
1500 mm 5'0"	kg lb			*15 400 *33,400	12 850 27,700	*12 100 *26,200	9450 20,350	*9750 *21,000	7400 15,900	*7600 *16,100	6000 12,900	*5800 *12,800	5450 12,050	11 240 36'10"
0 mm 0'0"	kg lb			*14 400 *31,200	12 550 27,050	*11 350 *24,500	9250 20,000	*8950 *19,200	7300 15,700	*6500 *13,450	5950 12,850	*4800 *10,600	*4800 *10,600	11 030 36'1"
-1500 mm -5'0"	kg lb	*9800 *22,850	*9800 *22,850	*12 250 *26,550	*12 250 *26,550	*9750 *21,000	9200 19,800	*7450 *15,800	7250 15,650			*4600 *10,150	*4600 *10,150	10 380 33'11"
-3000 mm -10'0"	kg lb			*9050 *19,450	*9050 *19,450	*7200 *15,250	*7200 *15,250					*5800 *12,950	*5800 *12,950	8480 27'4"



ISO 10567:2007



* Indicates that the load is limited by hydraulic lifting capacity rather than tipping load. The above loads are in compliance with hydraulic excavator lift capacity standard ISO 10567:2007. They do not exceed 87% of hydraulic lifting capacity or 75% of tipping load. Weight of all lifting accessories must be deducted from the above lifting capacities. Lifting capacities are based on the machine standing on a firm, uniform supporting surface. The use of a work tool attachment point to handle/lift objects, could affect the machine lift performance.

Lift capacity stays with ±5% for all available track shoes.

Always refer to the appropriate Operation and Maintenance Manual for specific product information.

FM558 GF/FM558 LL Forest Machine Specifications

Matching Guide

Optimal

Work Tool	Grapple		
	GLL52B	GLL55B	GLL60B
FM558 LL	<input type="radio"/>	<input type="radio"/>	<input type="radio"/>

Bucket Specifications and Compatibility – North America

	Linkage	Width		Capacity		Weight		Undercarriage Counterweight	High-Wide
		mm	in	m ³	yd ³	kg	lb	Fill	5.0 mt (11,023 lb)
Pin-On (No Quick Coupler)									
General Duty Capacity	CB	600	24	0.63	0.83	724	1,597	100	●
	CB	750	30	0.86	1.13	811	1,788	100	●
	CB	900	36	1.09	1.43	908	2,002	100	●
	CB	1050	42	1.34	1.75	980	2,161	100	●
	CB	1200	48	1.58	2.07	1072	2,363	100	●
	CB	1350	54	1.83	2.40	1166	2,570	100	●
General Duty Capacity – Wide Tip	CB	600	24	0.63	0.83	749	1,652	100	●
	CB	750	30	0.86	1.13	845	1,863	100	●
	CB	900	36	1.09	1.43	942	2,077	100	●
	CB	1050	42	1.34	1.75	1022	2,253	100	●
	CB	1200	48	1.58	2.07	1123	2,475	100	●
	CB	1350	54	1.83	2.40	1224	2,698	100	●
Heavy Duty	CB	600	24	0.52	0.68	733	1,616	100	●
	CB	750	30	0.71	0.93	851	1,876	100	●
	CB	900	36	0.91	1.19	945	2,084	100	●
	CB	1050	42	1.12	1.46	1041	2,295	100	●
	CB	1200	48	1.33	1.74	1112	2,452	100	●
	CB	1350	54	1.54	2.02	1212	2,672	100	●
	CB	1500	60	1.76	2.30	1306	2,879	100	●
	CB	1650	66	1.97	2.58	1383	3,048	100	●
Heavy Duty Power	CB	1050	42	1.12	1.47	1070	2,360	100	●
	CB	1200	48	1.33	1.73	1148	2,532	100	●
	CB	1350	54	1.53	2.01	1253	2,762	100	●
Severe Duty	CB	600	24	0.52	0.68	755	1,665	90	●
	CB	750	30	0.71	0.93	915	2,017	90	●
	CB	900	36	0.91	1.19	1000	2,204	90	●
	CB	1050	42	1.12	1.46	1099	2,424	90	●
	CB	1200	48	1.33	1.74	1177	2,596	90	●
Ditch Cleaning	CB	1150	45	0.60	0.78	292	644	100	●
	CB	1200	48	0.57	0.74	388	855	100	●
	CB	1500	60	0.74	0.97	455	1,003	100	●
General Duty	CB	900	36	0.53	0.69	394	869	100	●
Maximum load with pin-on (payload + bucket)								kg	7212
								lb	15,900

The above loads are in compliance with hydraulic excavator standard EN474-5:2006 + A3:2013, they do not exceed 87% of hydraulic lifting capacity or 75% of tipping capacity with front linkage fully extended at ground line with bucket curled.

Capacity based on ISO 7451:2007.

Bucket weight with General Duty tips.

Maximum Material Density:

● 2100 kg/m³ (3,500 lb/yd³)

Caterpillar recommends using appropriate work tools to maximize the value customers receive from our products. Use of work tools, including buckets, which are outside of Caterpillar's recommendations or specifications for weight, dimensions, flows, pressures, etc. may result in less-than-optimal performance, including but not limited to reductions in production, stability, reliability, and component durability. Improper use of a work tool resulting in sweeping, prying, twisting and/or catching of heavy loads will reduce the life of the boom and stick.

(continued on next page)

FM558 GF/FM558 LL Forest Machine Specifications

Bucket Specifications and Compatibility – North America (continued)

	Linkage	Undercarriage Counterweight						High-Wide		
		Width		Capacity		Weight		5.0 mt (11,023 lb)		
		mm	in	m ³	yd ³	kg	lb	Fill	Reach	
									R3.2 (10'6")	
With Pin Grabber Quick Coupler										
General Duty Capacity	CB	600	24	0.63	0.83	724	1,597	100	●	
	CB	750	30	0.86	1.13	811	1,788	100	●	
	CB	900	36	1.09	1.43	908	2,002	100	●	
	CB	1050	42	1.34	1.75	980	2,161	100	●	
	CB	1200	48	1.58	2.07	1072	2,363	100	●	
	CB	1350	54	1.83	2.40	1166	2,570	100	●	
General Duty Capacity – Wide Tip	CB	600	24	0.63	0.83	749	1,652	100	●	
	CB	750	30	0.86	1.13	845	1,863	100	●	
	CB	900	36	1.09	1.43	942	2,077	100	●	
	CB	1050	42	1.34	1.75	1022	2,253	100	●	
	CB	1200	48	1.58	2.07	1123	2,475	100	●	
	CB	1350	54	1.83	2.40	1224	2,698	100	●	
Heavy Duty	CB	600	24	0.52	0.68	733	1,616	100	●	
	CB	750	30	0.71	0.93	851	1,876	100	●	
	CB	900	36	0.91	1.19	945	2,084	100	●	
	CB	1050	42	1.12	1.46	1041	2,295	100	●	
	CB	1200	48	1.33	1.74	1112	2,452	100	●	
	CB	1350	54	1.54	2.02	1212	2,672	100	●	
	CB	1500	60	1.76	2.30	1306	2,879	100	●	
	CB	1650	66	1.97	2.58	1383	3,048	100	●	
Heavy Duty Power	CB	1050	42	1.12	1.47	1070	2,360	100	●	
	CB	1200	48	1.33	1.73	1148	2,532	100	●	
	CB	1350	54	1.53	2.01	1253	2,762	100	●	
Heavy Duty	CB	750	30	0.70	0.91	879	1,938	100	●	
	CB	1050	42	1.08	1.42	1110	2,448	100	●	
	CB	1200	48	1.28	1.68	1191	2,626	100	●	
	CB	1350	54	1.49	1.94	1299	2,864	100	●	
	CB	1500	60	1.69	2.21	1406	3,099	100	●	
Severe Duty	CB	600	24	0.52	0.68	755	1,665	90	●	
	CB	750	30	0.71	0.93	915	2,017	90	●	
	CB	900	36	0.91	1.19	1000	2,204	90	●	
	CB	1050	42	1.12	1.46	1099	2,424	90	●	
	CB	1200	48	1.33	1.74	1177	2,596	90	●	
Severe Duty	CB	600	24	0.51	0.66	832	1,835	90	●	
	CB	900	36	0.88	1.16	1062	2,341	90	●	
	CB	1050	42	1.08	1.42	1170	2,580	90	●	
	CB	1200	48	1.28	1.68	1257	2,772	90	●	
Ditch Cleaning	A	1150	45	0.60	0.78	292	644	100		
	A	1200	48	0.57	0.74	388	855	100		
	A	1500	60	0.74	0.97	455	1,003	100		
General Duty	A	900	36	0.53	0.69	394	869	100		
Maximum load with coupler (payload + bucket)								kg	6686	
								lb	14,740	

The above loads are in compliance with hydraulic excavator standard EN474-5:2006 + A3:2013, they do not exceed 87% of hydraulic lifting capacity or 75% of tipping capacity with front linkage fully extended at ground line with bucket curled.

Capacity based on ISO 7451:2007.

Bucket weight with General Duty tips.

Maximum Material Density:

● 2100 kg/m³ (3,500 lb/yd³)

Caterpillar recommends using appropriate work tools to maximize the value customers receive from our products. Use of work tools, including buckets, which are outside of Caterpillar's recommendations or specifications for weight, dimensions, flows, pressures, etc. may result in less-than-optimal performance, including but not limited to reductions in production, stability, reliability, and component durability. Improper use of a work tool resulting in sweeping, prying, twisting and/or catching of heavy loads will reduce the life of the boom and stick.

FM558 GF/FM558 LL Forest Machine Specifications

Bucket Specifications and Compatibility – Australia and New Zealand

	Linkage	Undercarriage Counterweight							High-Wide
		Width		Capacity		Weight		Fill	5.0 mt (11,023 lb)
		mm	in	m ³	yd ³	kg	lb	%	Reach R3.2 (10'6")
Pin-On (No Quick Coupler)									
General Duty	CB	600	24	0.52	0.68	659	1,454	100	●
	CB	750	30	0.71	0.93	726	1,601	100	●
	CB	1000	40	1.03	1.35	835	1,841	100	●
	CB	1350	54	1.54	2.02	1005	2,216	100	●
	CB	1500	60	1.76	2.30	1069	2,357	100	●
	CB	1600	63	1.86	2.43	1099	2,423	100	●
Heavy Duty	CB	1200	48	1.33	1.74	1096	2,417	100	●
	CB	1350	54	1.54	2.02	1196	2,637	100	●
Heavy Duty	CB	1450	57	1.60	2.09	1274	2,809	100	●
	CB	1600	63	1.80	2.36	1348	2,973	100	●
Heavy Duty	CB	1500	60	1.76	2.30	1391	3,067	100	●
Maximum load with pin-on (payload + bucket)								kg	7212
								lb	15,900

	Linkage	Undercarriage Counterweight							High-Wide
		Width		Capacity		Weight		Fill	5.0 mt (11,023 lb)
		mm	in	m ³	yd ³	kg	lb	%	Reach R3.2 (10'6")
With Pin Grabber Quick Coupler									
General Duty	CB	600	24	0.52	0.68	659	1,454	100	●
	CB	750	30	0.71	0.93	726	1,601	100	●
	CB	1000	40	1.03	1.35	835	1,841	100	●
	CB	1350	54	1.54	2.02	1005	2,216	100	●
	CB	1500	60	1.76	2.30	1069	2,357	100	●
	CB	1600	63	1.86	2.43	1099	2,423	100	●
Heavy Duty	CB	1200	48	1.33	1.74	1096	2,417	100	●
	CB	1350	54	1.54	2.02	1196	2,637	100	●
Heavy Duty	CB	1450	57	1.60	2.09	1274	2,809	100	●
	CB	1600	63	1.80	2.36	1348	2,973	100	●
Heavy Duty	CB	1500	60	1.76	2.30	1391	3,067	100	●
Maximum load with coupler (payload + bucket)								kg	6686
								lb	14,740

The above loads are in compliance with hydraulic excavator standard EN474-5:2006 + A3:2013, they do not exceed 87% of hydraulic lifting capacity or 75% of tipping capacity with front linkage fully extended at ground line with bucket curled.

Capacity based on ISO 7451:2007.

Bucket weight with General Duty tips.

Maximum Material Density:

● 2100 kg/m³ (3,500 lb/yd³)

Caterpillar recommends using appropriate work tools to maximize the value customers receive from our products. Use of work tools, including buckets, which are outside of Caterpillar's recommendations or specifications for weight, dimensions, flows, pressures, etc. may result in less-than-optimal performance, including but not limited to reductions in production, stability, reliability, and component durability. Improper use of a work tool resulting in sweeping, prying, twisting and/or catching of heavy loads will reduce the life of the boom and stick.

FM558 GF/FM558 LL Standard and Optional Equipment

Standard and Optional Equipment

Standard and optional equipment may vary. Consult your Cat dealer for details.

	Standard	Optional		Standard	Optional
BOOMS, STICKS AND LINKAGES			ELECTRICAL SYSTEM		
6.15 m (20'2") Reach boom		✓	Maintenance-free 1,000 CCA batteries (×4)	✓	
6.8 m (22'4") Log Loader boom		✓	Centralized electrical disconnect switch	✓	
3.2 m (10'6") Reach stick		✓	LED chassis and left-side boom light – 1,800 lumen	✓	
4.05 m (13'3") Under/Under stick		✓	Premium Log Loader lighting package		✓
4.05 m (13'3") Over/Under stick		✓	Premium General Forestry lighting package		✓
4.35 m (14'3") Power Clam stick		✓	115-amp alternator	✓	
CB2 family bucket linkage		✓	24-volt electric starting	✓	
CAB			Horn and travel alarm	✓	
ROPS Forestry cab with polycarbonate windows	✓		Pre-start monitoring system	✓	
4-point harness seat belt	✓		Tool control software	✓	
Side entry with 559 mm (22") tilting riser		✓	Secondary engine shutoff switch	✓	
Rear entry with 1219 mm (48") tilting riser		✓	ENGINE		
Rear entry with 1829 mm (72") tilting riser		✓	Electric fuel priming pump	✓	
Heated and cooled seat with air-adjustable suspension	✓		Cold start package with block heaters		✓
Integrated joysticks	✓		Three selectable modes: Power, Smart, Eco	✓	
Tilt-up left-side console (side-entry cab only)	✓		Automatic engine speed control	✓	
High-resolution touchscreen monitor	✓		Automatic engine idle shutdown	✓	
Bluetooth® integrated radio (including USB, auxiliary port and microphone)	✓		Up to 4600 m (15,092 ft) altitude capability	✓	
12V DC outlets	✓		52° C (126° F) high-ambient cooling capacity	✓	
Keyless push-to-start engine control	✓		–32° C (–25° F) cold start capability	✓	
Automatic bi-level air conditioner	✓		Hydraulic reverse fan	✓	
LED dome and floor lights	✓		Two-stage fuel filter system	✓	
Windshield wiper and washer	✓		Double element air filter with integrated pre-cleaner	✓	
Behind seat storage	✓				
CB radio mounts	✓				
Retractable sunshade	✓				
Cat Stick Steer		✓			
Auxiliary relay		✓			
CAT TECHNOLOGY					
VisionLink®	✓*				
Remote Services Capability:**	✓				
– Remote Troubleshoot					
– Remote Flash					

(continued on next page)

*Connect subscription only. Additional subscriptions are available. Contact your Cat dealer for availability.

**When in cellular range

FM558 GF/FM558 LL Standard and Optional Equipment

Standard and Optional Equipment *(continued)*

Standard and optional equipment may vary. Consult your Cat dealer for details.

	Standard	Optional		Standard	Optional
HYDRAULIC SYSTEM			SERVICE AND MAINTENANCE		
Boom and stick regeneration circuits	✓		Side entry to service platforms	✓	
Boom and stick drift reduction valve	✓		Grouped location for engine oil and fuel filters	✓	
Electronic main control valve	✓		Scheduled Oil Sampling (S-O-S SM) ports	✓	
Automatic hydraulic oil warmup	✓		Integrated vehicle health management system	✓	
Automatic swing parking brake	✓		UNDERCARRIAGE AND STRUCTURES		
High performance hydraulic return filter	✓		High-Wide undercarriage	✓	
Automatic two speed travel	✓		216 mm (8.5") pitch Cat grease lubricated track chain with PPR3 positive pin retention	✓	
Bio hydraulic oil capability	✓		Catwalks	✓	
High torque swing drive	✓		Tie down points	✓	
Swing cushion valve	✓		5.0 mt (11,023 lb) counterweight fuel tank*		✓
Tool control software	✓		6.1 mt (13,448 lb) counterweight fuel tank**	✓	
Medium pressure circuit		✓	850 mm (33") triple grouser shoes		✓
SAFETY AND SECURITY			700 mm (28") single grouser shoes		✓
Caterpillar One Key security system	✓		700 mm (28") double grouser shoes		✓
Lockable service doors	✓		Heavy-duty track rollers and frames	✓	
Lockable external tool/storage box	✓		Heavy-duty travel motor guards	✓	
Lockable fuel cap and hydraulic tank	✓		Heavy-duty bottom guards	✓	
Lockable disconnect switch	✓		Track guiding guards	✓	
Service platforms with anti-skid plate and countersunk bolts	✓		High drawbar final drives	✓	
Right-hand rail and hand hold	✓		Heavy-duty recoil springs	✓	
Signaling/warning horn	✓		Heavy-duty hydraulic swivel	✓	
Ground-level secondary engine shutoff switch	✓		Heavy-duty hydraulic swivel guard	✓	
Rearview camera	✓				
Right-hand-sideview camera		✓			
Inspection lighting		✓			

*Optional for GF; not available for LL

**Standard for LL; optional for GF

FM558 GF/FM558 LL Environmental Declaration

The following information applies to the machine at the time of final manufacture as configured for sale in the regions covered in this document. The content of this declaration is valid as of the date issued; however, content related to machine features and specifications are subject to change without notice. For additional information, please see the machine's Operation and Maintenance Manual.

For more information on sustainability in action and our progress, please visit <https://www.caterpillar.com/en/company/sustainability>.

Engine

- The Cat® C7.1 engine meets U.S. EPA Tier 4 Final and EU Stage V emission standards.
- Cat diesel engines are required to use ULSD (ultra-low sulfur diesel fuel with 15 ppm of sulfur or less) or ULSD blended with the following lower-carbon intensity fuels** up to:
 - ✓ 20% biodiesel FAME (fatty acid methyl ester)*
 - ✓ 100% renewable diesel, HVO (hydrotreated vegetable oil) and GTL (gas-to-liquid) fuels

Refer to guidelines for successful application. Please consult your Cat dealer or "Caterpillar Machine Fluids Recommendations" (SEBU6250) for details.

**Engines with no aftertreatment devices can use higher blends, up to 100% biodiesel (for use of blends higher than 20% biodiesel, consult your Cat dealer).*

***Tailpipe greenhouse gas emissions from lower-carbon intensity fuels are essentially the same as traditional fuels.*

Air Conditioning System

- The air conditioning system on this machine contains the fluorinated greenhouse gas refrigerant R134a (Global Warming Potential = 1430). The system contains 2.1 (22" Riser CAB)/2.2 (48"/72" Riser CAB) kg of refrigerant, which as a CO₂ equivalent of 3.003/3.146 metric tonnes.

Paint

- Based on best available knowledge, the maximum allowable concentration, measured in parts per million (PPM), of the following heavy metals in paint are:
 - Barium < 0.01%
 - Cadmium < 0.01%
 - Chromium < 0.01%
 - Lead < 0.01%

Sound Performance

With cooling fan speed at maximum value:

Operator Sound Pressure Level (ISO 6396:2008) – 74 dB(A)

Exterior Sound Power Level (ISO 6395:2008) – 102 dB(A)

- When properly installed and maintained, the cab offered by Caterpillar, when tested with doors and windows closed according to ANSI/SAE J1166 OCT98, meets OSHA and MSHA requirements for operator sound exposure limits in effect at time of manufacture.
- Hearing protection may be needed when operating with an open operator station and cab (when not properly maintained or doors/windows open) for extended periods or in a noisy environment.

Oils and Fluids

- Caterpillar factory fills with ethylene glycol coolants. Cat Diesel Engine Antifreeze/Coolant (DEAC) and Cat Extended Life Coolant (ELC) can be recycled. Consult your Cat dealer for more information.
- Cat Bio HYDO™ Advanced is an EU Ecolabel approved biodegradable hydraulic oil.
- Additional fluids are likely to be present, please consult the Operations and Maintenance Manual or the Application and Installation guide for complete fluid recommendations and maintenance intervals.

Features and Technology

- The following features and technology may contribute to fuel savings and/or carbon reduction. Features may vary. Consult your Cat dealer for details.
 - Advanced electrohydraulic system balances power and efficiency
 - Smart mode automatically matches machine power to work requirements
 - Eco mode minimizes fuel consumption for light applications
 - Product Link tracks fuel usage and other information to improve jobsite efficiency
 - Remote flash and remote troubleshoot help optimize machine performance
 - Extended maintenance intervals reduce fluid and filter consumption

For more complete information on Cat products, dealer services, and industry solutions, visit us on the web at www.cat.com

© 2023 Caterpillar
All rights reserved

Materials and specifications are subject to change without notice. Featured machines in photos may include additional equipment. See your Cat dealer for available options.

CAT, CATERPILLAR, LET'S DO THE WORK, their respective logos, "Caterpillar Corporate Yellow," the "Power Edge" and Cat "Modern Hex" trade dress as well as corporate and product identity used herein, are trademarks of Caterpillar and may not be used without permission. VisionLink is a trademark of Caterpillar Inc., registered in the United States and in other countries.

AEXQ3532-01 (10-2023)
Replaces AEXQ3532-00
Build Number: 07B
(Aus-NZ, N Am)

