



317 GC

Hydraulic Excavator

Technical Specifications

Configurations and features may vary by region. Please consult your Cat® dealer for availability in your area.

Table of Contents

Specifications	2
Engine	2
Swing Mechanism	2
Weights	2
Track	2
Drive	2
Hydraulic System	2
Service Refill Capacities	2
Standards	2
Sound Performance	2
Operating Weights and Ground Pressures	3
Major Component Weights	4
Dimensions	5
Working Ranges	7
Blade Working Ranges	8
Reach Boom Lift Capacities – Counterweight: 3.05 mt (6,720 lb):	
With Blade Up	9
Without Blade	21
Reach Boom Lift Capacities – Counterweight: 3.57 mt (7,870 lb):	
With Blade Up	15
Without Blade	27
Bucket Specifications and Compatibility	33
Attachments Offering Guide	37
Standard and Optional Equipment	39
Dealer Installed Kits and Attachments	41
317 GC Environmental Declaration	42

317 GC Hydraulic Excavator Specifications

Engine

Engine Model	Cat® C3.6	
Net Power		
ISO 9249	89 kW	119 hp
ISO 9249 (DIN)	121 hp (metric)	
Engine Power		
ISO 14396	90 kW	121 hp
ISO 14396 (DIN)	122 hp (metric)	
Bore	98 mm	4 in
Stroke	120 mm	5 in
Displacement	3.6 L	220 in ³
Biodiesel Capability	Up to B20 ⁽¹⁾	

- Meets U.S. EPA Tier 4 Final and EU Stage V emission standards.
- No engine power derate required below 3000 m (9,840 ft) altitude.
- Advertised power is tested per the standard shown in effect at the time of manufacture.
- Net power advertised is the power available at the flywheel when the engine is equipped with fan, air intake system, exhaust system and alternator.
- Engine speed at 2,400 rpm.

⁽¹⁾Cat diesel engines are required to use ULSD (ultra-low sulfur diesel fuel with 15 ppm of sulfur or less) or ULSD blended with the following lower-carbon intensity fuels** up to:

- ✓ 20% biodiesel FAME (fatty acid methyl ester)*
- ✓ 100% renewable diesel, HVO (hydrotreated vegetable oil) and GTL (gas-to-liquid) fuels

Refer to guidelines for successful application. Please consult your Cat dealer or “Caterpillar Machine Fluids Recommendations” (SEBU6250) for details.

**Engines with no aftertreatment devices can use higher blends, up to 100% biodiesel (for use of blends higher than 20% biodiesel, consult your Cat dealer).*

***Tailpipe greenhouse gas emissions from lower-carbon intensity fuels are essentially the same as traditional fuels.*

Swing Mechanism

Swing Speed	8.7 rpm	
Maximum Swing Torque	61 kN·m	44,990 lbf·ft

Weights

Operating Weight	17 200 kg	38,000 lb
------------------	-----------	-----------

- Long undercarriage, Reach boom, R3.1 (10'2") stick, GD 0.76 m³ (0.99 yd³) bucket, 600 mm (24") triple grouser shoes and 3.05 mt (6,720 lb) counterweight.

Track

Standard Track Shoes Width	600 mm	24 in
Optional Track Shoes Width	700 mm	28 in
Number of Shoes (each side)	44	
Number of Track Rollers (each side)	7	
Number of Carrier Rollers (each side)	2	

Drive

Gradeability	35°/70%	
Maximum Travel Speed	5.3 km/h	3.3 mph
Maximum Drawbar Pull – Long Undercarriage	157 kN	35,295 lbf

Hydraulic System

Main System – Maximum Flow – Implement	296 L/min	78 gal/min
Maximum Pressure – Equipment	35 000 kPa	5,075 psi
Maximum Pressure – Travel	35 000 kPa	5,075 psi
Maximum Pressure – Swing	25 800 kPa	3,741 psi
Boom Cylinder – Bore	110 mm	4.3 in
Boom Cylinder – Stroke	1193 mm	47.0 in
Stick Cylinder – Bore	120 mm	4.7 in
Stick Cylinder – Stroke	1331 mm	52.4 in
Bucket Cylinder – Bore	105 mm	4.1 in
Bucket Cylinder – Stroke	1039 mm	40.9 in

Service Refill Capacities

Fuel Tank Capacity	271 L	71.6 gal
Cooling System	22 L	5.8 gal
Engine Oil	11 L	2.9 gal
Final Drive (each)	6 L	1.6 gal
Hydraulic System (including tank)	94 L	24.8 gal
Hydraulic Tank	87 L	23.0 gal
Diesel Exhaust Fluid (DEF) Tank	22 L	5.9 gal

Standards

Brakes	ISO 10265:2008
Cab/Rollover Protective Structure (ROPS)	ISO 12117-2:2008
Cab/Operator Protective Guards (OPG) (optional)	ISO 10262:1998 (Level II)

Sound Performance

ISO 6395:2008 external	101 dB(A)
ISO 6396:2008 internal	70 dB(A)

- Hearing protection may be needed when operating with an open operator station and cab (when not properly maintained or doors/windows open) for extended periods or in a noisy environment.

317 GC Hydraulic Excavator Specifications

Operating Weights and Ground Pressures

	600 mm (24") Triple Grouser Shoes		600 mm (24") Rubber Track Shoes		700 mm (28") Triple Grouser Shoes	
	Weight	Ground Pressure	Weight	Ground Pressure	Weight	Ground Pressure
	kg (lb)	kPa (psi)	kg (lb)	kPa (psi)	kg (lb)	kPa (psi)
Base Machine Configurations						
Base machine with 3.05 mt (6,720 lb) Counterweight and Long Undercarriage						
Reach Boom + R2.6 (8'6") Stick + 0.76 m ³ (0.99 yd ³) GD Bucket	17 200 (37,800)	40.6 (5.9)	17 500 (38,600)	41.5 (6.0)	17 400 (38,300)	35.3 (5.1)
Reach Boom + R2.9 m (9'6") Stick + 0.76 m ³ (0.99 yd ³) GD Bucket	17 200 (38,000)	40.8 (5.9)	17 600 (38,800)	41.7 (6.0)	17 500 (38,500)	35.4 (5.1)
Reach Boom + R3.1 m (10'2") Stick + 0.76 m ³ (0.99 yd ³) GD Bucket	17 200 (38,000)	40.8 (5.9)	17 600 (38,800)	41.7 (6.0)	17 500 (38,500)	35.4 (5.1)
Reach Boom + R2.6 m (8'6") Stick + 0.76 m ³ (0.99 yd ³) + GD Bucket + Blade	18 000 (39,800)	42.7 (6.2)	18 400 (40,600)	43.6 (6.3)	18 300 (40,300)	37.1 (5.4)
Reach Boom + R3.1 m (10'2") Stick + 0.76 m ³ (0.99 yd ³) + GD Bucket + Blade	18 100 (39,900)	42.9 (6.2)	18 500 (40,800)	43.8 (6.4)	18 400 (40,500)	37.3 (5.4)
Base machine with 3.57 mt (7,870 lb) Counterweight and Long Undercarriage						
Reach Boom + R2.6 (8'6") Stick + 0.76 m ³ (0.99 yd ³) GD Bucket	17 700 (39,000)	41.8 (6.1)	18 000 (39,800)	42.7 (6.2)	17 900 (39,500)	36.3 (5.3)
Reach Boom + R2.9 m (9'6") Stick + 0.76 m ³ (0.99 yd ³) GD Bucket	17 700 (39,100)	42.0 (6.1)	18 100 (39,900)	42.9 (6.2)	18 000 (39,600)	36.5 (5.3)
Reach Boom + R2.9 m (9'6") Thumb Ready Stick + 0.76 m ³ (0.99 yd ³) GD Bucket	17 800 (39,300)	42.2 (6.1)	18 200 (40,200)	43.1 (6.3)	18 100 (39,900)	36.7 (5.3)
Reach Boom + R3.1 m (10'2") Stick + 0.76 m ³ (0.99 yd ³) GD Bucket	17 700 (39,100)	42.0 (6.1)	18 100 (39,900)	42.9 (6.2)	18 000 (39,700)	36.5 (5.3)
Reach Boom + R2.9 m (9'6") Thumb Ready Stick + 0.76 m ³ (0.99 yd ³) + GD Bucket + Blade	18 700 (41,300)	44.4 (6.4)	19 100 (42,100)	45.3 (6.6)	19 000 (41,900)	38.5 (5.6)
Reach Boom + R3.1 m (10'2") Stick + 0.76 m ³ (0.99 yd ³) + GD Bucket + Blade	18 600 (41,100)	44.1 (6.4)	19 000 (41,900)	45.0 (6.5)	18 900 (41,600)	38.3 (5.6)

All operating weights include a 90% fuel tank with 75 kg (165 lb) operator.

317 GC Hydraulic Excavator Specifications

Major Component Weights

	kg	lb
Base Machine (with counterweight, upper frame [including swing frame], long undercarriage – does not include boom, stick, bucket, boom cylinders, stick cylinder, bucket cylinders, tracks, 90% fuel tank and 75 kg [165 lb] operator).		
With 3.05 mt (6,720 lb) Counterweight	11 430	25,200
With 3.57 mt (7,870 lb) Counterweight	11 950	26,350
Track Shoes:		
600 mm (24") Triple Grouser Track Shoes	2340	5,160
600 mm (24") Rubber Track Shoes	2710	5,980
700 mm (28") Triple Grouser Track Shoes with Additional Steps	2580	5,680
Two Boom Cylinders	300	670
Weight of 90% Fuel Tank and 75 kg (165 lb) Operator	300	660
Counterweights:		
3.05 mt (6,720 lb) Counterweight	3050	6,720
3.57 mt (7,870 lb) Counterweight	3570	7,870
Swing Frame	1690	3,720
Undercarriage:		
Base Frame with Long Undercarriage	3900	8,600
Boom (including lines, pins, stick cylinder):		
Reach Boom 5.1 m (16'9")	1320	2,910
Sticks (including lines, pins, bucket cylinder, bucket linkage):		
Reach Stick R2.6 (8'6")	810	1,780
Reach Stick R2.9 m (9'6")	880	1,930
Thumb Ready Stick R2.9 m (9'6")	980	2,160
Reach Stick R3.1 m (10'2")	880	1,940
Buckets (without linkage):		
0.62 m ³ (0.81 yd ³) GD Bucket	740	1,630
0.76 m ³ (0.99 yd ³) GD Bucket	640	1,410
0.91 m ³ (1.19 yd ³) GD Bucket	730	1,600
0.62 m ³ (0.81 yd ³) SD Bucket	680	1,510
0.76 m ³ (0.99 yd ³) SD Bucket	740	1,630
0.91 m ³ (1.19 yd ³) SD Bucket	820	1,800
Quick Coupler:		
Pin Grabber Quick Coupler	260	580

317 GC Hydraulic Excavator Specifications

Dimensions

All dimensions are approximate and may vary depending on bucket selection.

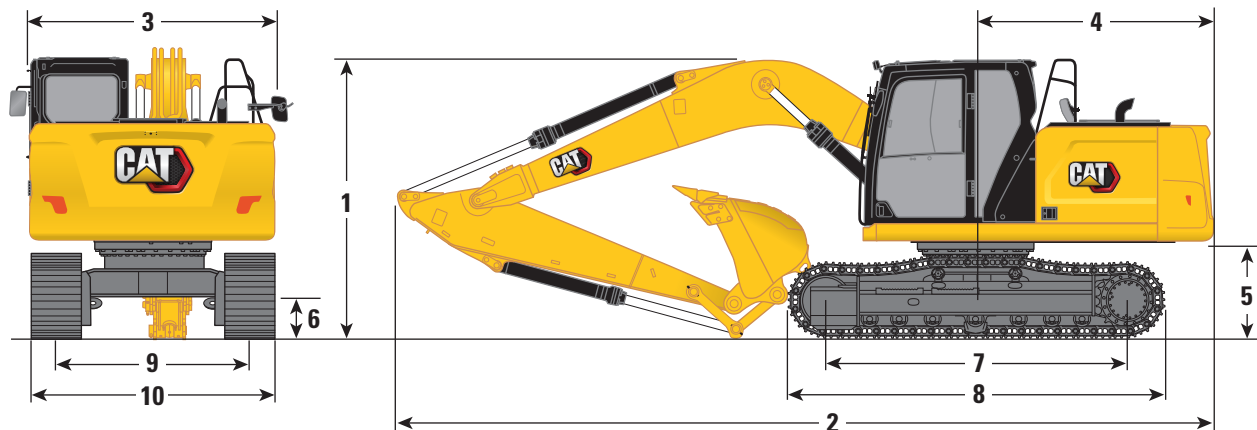

Boom Option

Reach Boom 5.1 m (16'9")

Stick Options

Reach Stick R2.6 (8'6")

Reach Stick R2.9 (9'6")

Thumb Ready Stick R2.9 (9'6")

Reach Stick R3.1 (10'2")

1 Machine Height:

Top of Cab Height	2930 mm	9'7"	2930 mm	9'7"	2930 mm	9'7"	2930 mm	9'7"
Top of OPG Height	3070 mm	10'1"	3070 mm	10'1"	3070 mm	10'1"	3070 mm	10'1"
Handrails Height	2940 mm	9'8"	2940 mm	9'8"	2940 mm	9'8"	2940 mm	9'8"
With Boom/Stick/Bucket Installed (with stick cylinder lines)	2980 mm	9'9"	3030 mm	9'11"	3030 mm	9'11"	3120 mm	10'3"
With Boom/Stick Installed (with stick cylinder lines)	2870 mm	9'5"	2910 mm	9'7"	2910 mm	9'7"	2970 mm	9'9"
With Boom Installed (with stick cylinder lines)	2460 mm	8'1"	2460 mm	8'1"	2460 mm	8'1"	2460 mm	8'1"

Machine Height

(with 600 mm [24"] Rubber Track Shoes):

Top of Cab Height	2980 mm	9'9"	2980 mm	9'9"	2980 mm	9'9"	2980 mm	9'9"
Top of OPG Height	3120 mm	10'3"	3120 mm	10'3"	3120 mm	10'3"	3120 mm	10'3"
Handrail Height	3000 mm	9'10"	3000 mm	9'10"	3000 mm	9'10"	3000 mm	9'10"
With Boom/Stick/Bucket Installed (with stick cylinder lines)	3040 mm	10'0"	3040 mm	10'0"	3040 mm	10'0"	3040 mm	10'0"
With Boom/Stick Installed (with stick cylinder lines)	2930 mm	9'7"	2970 mm	9'9"	2970 mm	9'9"	3030 mm	9'11"
With Boom Installed (with stick cylinder lines)	2520 mm	8'3"	2520 mm	8'3"	2520 mm	8'3"	2520 mm	8'3"

2 Machine Length:

With Boom/Stick/Bucket Installed (with stick cylinder lines)	8550 mm	28'1"	8570 mm	28'1"	8570 mm	28'1"	8570 mm	28'1"
With Boom/Stick Installed (with stick cylinder lines)	8520 mm	27'11"	8550 mm	28'1"	8550 mm	28'1"	8560 mm	28'1"
With Boom Installed (with stick cylinder lines)	7560 mm	24'10"	7560 mm	24'10"	7560 mm	24'10"	7560 mm	24'10"

Machine Length (with Blade, Blade Rear)

with boom/stick/bucket installed (with stick cylinder lines)	8590 mm	28'2"	8610 mm	28'3"	8610 mm	28'3"	8620 mm	28'3"
with boom/stick installed (with stick cylinder lines)	8570 mm	28'1"	8590 mm	28'2"	8590 mm	28'2"	8610 mm	28'3"
with boom installed (with stick cylinder lines)	7600 mm	24'11"	7600 mm	24'11"	7600 mm	24'11"	7600 mm	24'11"

Bucket Type

GD

GD

GD

GD

Bucket Capacity	1.00 m ³	1.31 yd ³	0.76 m ³	0.99 yd ³	0.76 m ³	0.99 yd ³	1.00 m ³	1.31 yd ³
Bucket Tip Radius	1390 mm	4'7"	1390 mm	4'7"	1390 mm	4'7"	1390 mm	4'7"

(continued on next page)

317 GC Hydraulic Excavator Specifications

Dimensions *(continued)*

All dimensions are approximate and may vary depending on bucket selection.

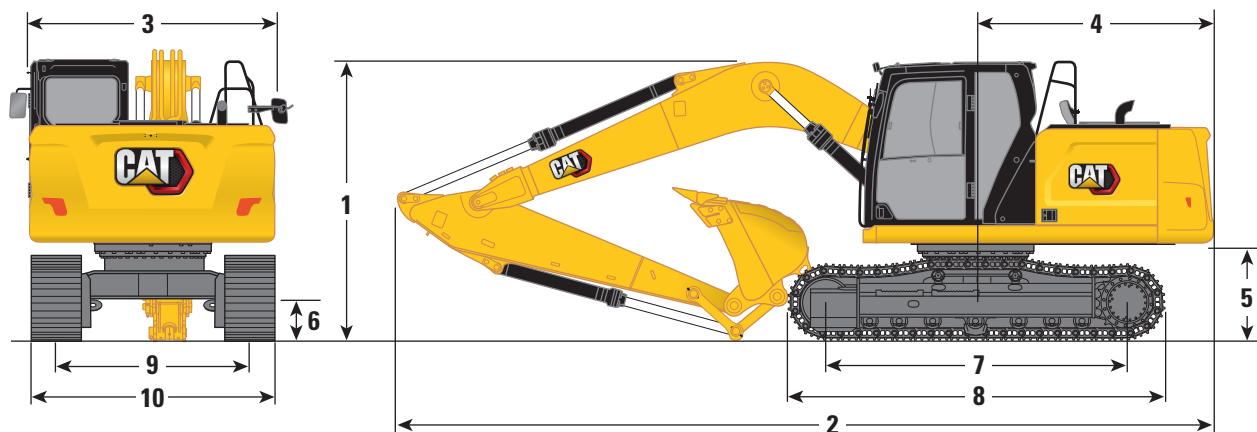

Boom Option

Reach Boom 5.1 m (16'9")

Stick Options	Reach Stick R2.6 (8'6")		Reach Stick R2.9 (9'6")		Thumb Ready Stick R2.9 (9'6")		Reach Stick R3.1 (10'2")	
3 Upperframe Width	2540 mm	8'4"	2540 mm	8'4"	2540 mm	8'4"	2540 mm	8'4"
4 Tail Swing Radius:								
3.05 mt (6,720 lb) Counterweight	2500 mm	8'2"	2500 mm	8'2"	2500 mm	8'2"	2500 mm	8'2"
3.57 mt (7,870 lb) Counterweight	2500 mm	8'2"	2500 mm	8'2"	2500 mm	8'2"	2500 mm	8'2"
5 Counterweight Clearance	1010 mm	3'4"	1010 mm	3'4"	1010 mm	3'4"	1010 mm	3'4"
6 Ground Clearance	430 mm	1'5"	430 mm	1'5"	430 mm	1'5"	430 mm	1'5"
7 Length to Center of Rollers	3170 mm	10'5"	3170 mm	10'5"	3170 mm	10'5"	3170 mm	10'5"
8 Track Length	3970 mm	13'0"	3970 mm	13'0"	3970 mm	13'0"	3970 mm	13'0"
9 Track Gauge	1990 mm	6'6"	1990 mm	6'6"	1990 mm	6'6"	1990 mm	6'6"
10 Undercarriage Width:								
600 mm (24") Shoes	2590 mm	8'6"	2590 mm	8'6"	2590 mm	8'6"	2590 mm	8'6"
700 mm (28") Shoes (with steps)	2690 mm	8'10"	2690 mm	8'10"	2690 mm	8'10"	2690 mm	8'10"
Bucket Type	GD		GD		GD		GD	
Bucket Capacity	1.00 m ³	1.31 yd ³	0.76 m ³	0.99 yd ³	0.76 m ³	0.99 yd ³	1.00 m ³	1.31 yd ³
Bucket Tip Radius	1390 mm	4'7"	1390 mm	4'7"	1390 mm	4'7"	1390 mm	4'7"

317 GC Hydraulic Excavator Specifications

Working Ranges

All dimensions are approximate and may vary depending on bucket selection.

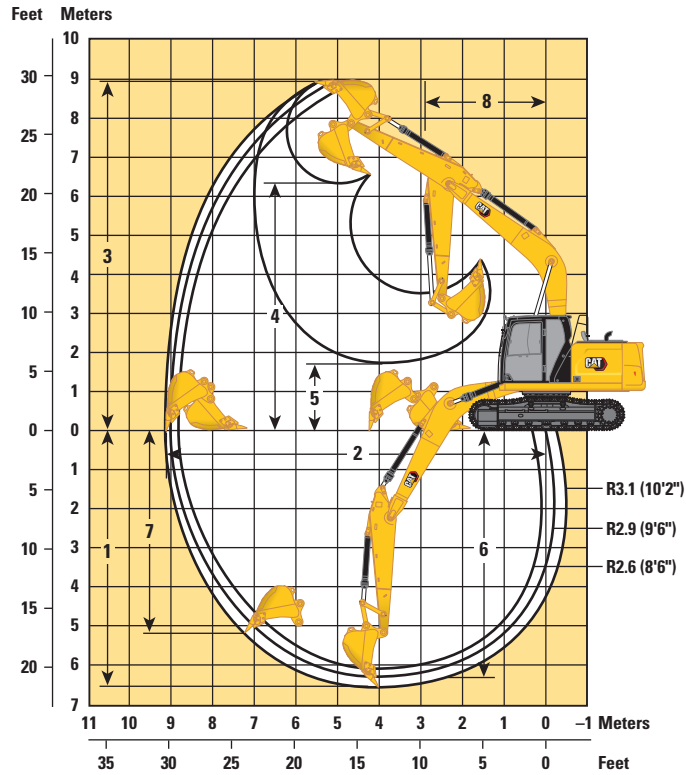

Boom Option

Reach Boom 5.1 m (16'9")

Stick Options

Reach Stick R2.6 (8'6")

Reach Stick R2.9 (9'6")

Thumb Ready Stick R2.9 (9'6")

Reach Stick R3.1 (10'2")

	Reach Stick R2.6 (8'6")		Reach Stick R2.9 (9'6")		Thumb Ready Stick R2.9 (9'6")		Reach Stick R3.1 (10'2")	
1 Maximum Digging Depth	6100 mm	20'0"	6400 mm	21'0"	6400 mm	21'0"	6600 mm	21'8"
2 Maximum Reach at Ground Line	8790 mm	28'10"	9010 mm	29'7"	9010 mm	29'7"	9200 mm	30'2"
3 Maximum Cutting Height	8940 mm	29'4"	8900 mm	29'2"	8900 mm	29'2"	8990 mm	29'6"
4 Maximum Loading Height	6270 mm	20'7"	6280 mm	20'7"	6280 mm	20'7"	6370 mm	20'11"
5 Minimum Loading Height	2290 mm	7'6"	1990 mm	6'6"	1990 mm	6'6"	1790 mm	5'10"
6 Maximum Depth Cut for 2440 mm (8'0") Level Bottom	5880 mm	19'3"	6170 mm	20'3"	6170 mm	20'3"	6380 mm	20'11"
7 Maximum Vertical Wall Digging Depth	4980 mm	16'4"	4960 mm	16'3"	4960 mm	16'3"	5150 mm	16'11"
8 Minimum Working Equipment Radius	2980 mm	9'9"	2940 mm	9'8"	2940 mm	9'8"	2930 mm	9'7"
Bucket Digging Force (ISO)	123 kN	27,650 lbf	123 kN	27,650 lbf	123 kN	27,650 lbf	123 kN	27,650 lbf
Stick Digging Force (ISO)	80 kN	17,980 lbf	75 kN	16,860 lbf	75 kN	16,860 lbf	71 kN	15,960 lbf
Bucket Type	GD		GD		GD		GD	
Bucket Capacity	1.00 m ³	1.31 yd ³	0.76 m ³	0.99 yd ³	0.76 m ³	0.99 yd ³	1.00 m ³	1.31 yd ³
Bucket Tip Radius	1390 mm	4'7"	1390 mm	4'7"	1390 mm	4'7"	1390 mm	4'7"

317 GC Hydraulic Excavator Specifications

Blade Working Ranges

All dimensions are approximate and may vary depending on bucket selection.

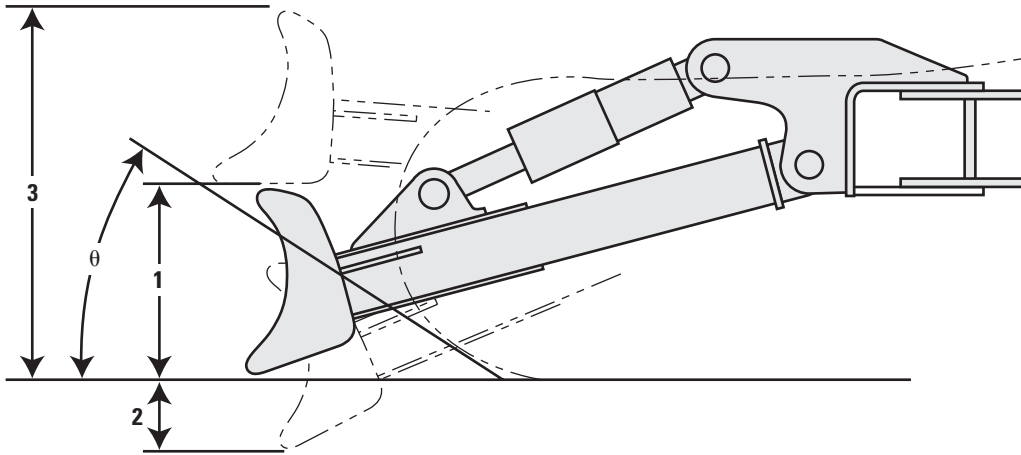

Blade Options

	2600 mm (8'6")		2700 mm (8'10")	
	1 Blade Height	614 mm	2'0"	614 mm
2 Maximum Lowering Depth from Ground	518 mm	1'8"	518 mm	1'8"
3 Maximum Raising Height above Ground	976 mm	3'2"	976 mm	3'2"
θ Approach Angle	23.5°		23.5°	

317 GC Hydraulic Excavator Specifications

Reach Boom Lift Capacities – Counterweight: 3.05 mt (6,720 lb) – without Bucket – Blade Up

2700 mm (8'10") Blade

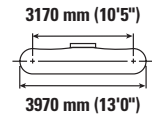
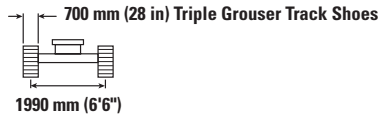
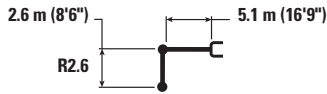

Reach Boom Lift Configuration	1500 mm/5'0"		3000 mm/10'0"		4500 mm/15'0"		6000 mm/20'0"		7500 mm/25'0"		Blade Configuration		mm ft/in
	kg lb	kg lb	kg lb	kg lb	kg lb	kg lb	kg lb	kg lb	kg lb	kg lb	kg lb	kg lb	
7500 mm 25'0"					*7,700	*7,700					*3350 *7,450	*3350 *7,450	4770 15'01"
6000 mm 20'0"							*3600 *6,650	3500 *6,650			*2950 *6,450	*2950 *6,450	6190 20'00"
4500 mm 15'0"					*4650 *10,050	*4650 *10,050	*4300 *9,450	3500 7,500			*2850 *6,200	2750 6,050	7020 22'10"
3000 mm 10'0"			*8900 *18,900	*8900 *18,900	*5900 *12,700	5100 11,000	*4850 *10,500	3350 7,250			*2900 *6,300	2450 5,350	7450 24'04"
1500 mm 5'0"					*7250 *15,600	4800 10,300	4950 10,650	3200 6,950	*3500 2350		*3050 *6,750	2300 5,100	7560 24'09"
0 mm 0'0"			*6200 *14,200	*6200 *14,200	7400 15,950	4550 9,850	4800 10,350	3100 6,700			*3450 *7,600	2350 5,200	7370 24'02"
-1500 mm -5'0"	*5650 *12,650	*5650 *12,650	*10 050 *22,950	8250 17,700	7350 15,750	4500 9,700	4750 10,250	3050 6,600			4000 8,750	2600 5,700	6850 22'04"
-3000 mm -10'0"	*9900 *22,300	*9900 *22,300	*10 750 *23,250	8350 17,950	7400 15,900	4550 9,800					4950 11,000	3200 7,100	5900 19'02"
-4500 mm -15'0"			*7750 *16,400	*7750 *16,400							*5450 *11,900	5200 11,900	4240 13'06"

Reach Boom Lift Capacities – Counterweight: 3.05 mt (6,720 lb) – without Bucket – Blade Up

2600 mm (8'6") Blade

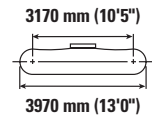
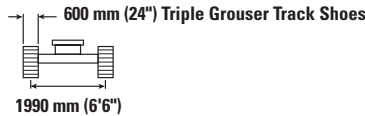
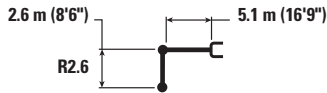

Reach Boom Lift Configuration	1500 mm/5'0"		3000 mm/10'0"		4500 mm/15'0"		6000 mm/20'0"		7500 mm/25'0"		Blade Configuration		mm ft/in
	kg lb	kg lb	kg lb	kg lb	kg lb	kg lb	kg lb	kg lb	kg lb	kg lb	kg lb	kg lb	
7500 mm 25'0"					*7,700	*7,700					*3350 *7,450	*3350 *7,450	4770 15'01"
6000 mm 20'0"							*3600 *6,650	3500 *6,650			*2950 *6,450	*2950 *6,450	6190 20'00"
4500 mm 15'0"					*4650 *10,050	*4650 *10,050	*4300 *9,450	3450 7,450			*2850 *6,200	2700 5,950	7020 22'10"
3000 mm 10'0"			*8900 *18,900	*8900 *18,900	*5900 *12,700	5050 10,900	*4850 *10,500	3350 7,150			*2900 *6,300	2400 5,250	7450 24'04"
1500 mm 5'0"					*7250 *15,600	4700 10,150	4900 10,500	3200 6,850	*3500 2300		*3050 *6,750	2300 5,000	7560 24'09"
0 mm 0'0"			*6200 *14,200	*6200 *14,200	7350 15,750	4500 9,700	4750 10,200	3050 6,600			*3450 *7,600	2350 5,100	7370 24'02"
-1500 mm -5'0"	*5650 *12,650	*5650 *12,650	*10 050 *22,950	8150 17,450	7250 15,550	4450 9,550	4700 10,100	3000 6,500			3950 8,650	2550 5,600	6850 22'04"
-3000 mm -10'0"	*9900 *22,300	*9900 *22,300	*10 750 *23,250	8250 17,750	7300 15,700	4500 9,650					4900 10,850	3150 7,000	5900 19'02"
-4500 mm -15'0"			*7750 *16,400	*7750 *16,400							*5450 *11,900	5150 11,500	4240 13'06"



ISO 10567:2007



* Indicates that the load is limited by hydraulic lifting capacity rather than tipping load. The above loads are in compliance with hydraulic excavator lift capacity standard ISO 10567:2007. They do not exceed 87% of hydraulic lifting capacity or 75% of tipping load. Weight of all lifting accessories must be deducted from the above lifting capacities. Lifting capacities are based on the machine standing on a firm, uniform supporting surface. The use of a work tool attachment point to handle/lift objects, could affect the machine lift performance.

Lift capacity stays with ±5% for all available track shoes.

Always refer to the appropriate Operation and Maintenance Manual for specific product information.

317 GC Hydraulic Excavator Specifications

Reach Boom Lift Capacities – Counterweight: 3.05 mt (6,720 lb) – without Bucket – Blade Up

2600 mm (8'6") Blade

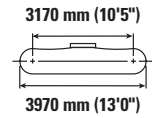
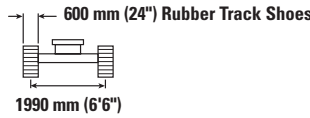
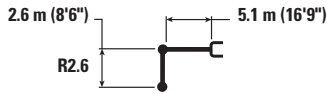

		1500 mm/5'0"		3000 mm/10'0"		4500 mm/15'0"		6000 mm/20'0"		7500 mm/25'0"		mm ft/in		
7500 mm 25'0"	kg lb					*7,700	*7,700					*3350 *7,450	*3350 *7,450	4770 15'01"
6000 mm 20'0"	kg lb							*3600 *6,650	3550 *6,650			*2950 *6,450	*2950 *6,450	6190 20'00"
4500 mm 15'0"	kg lb					*4650 *10,050	*4650 *10,050	*4300 *9,450	3500 7,550			*2850 *6,200	2750 6,050	7020 22'10"
3000 mm 10'0"	kg lb			*8900 *18,900	*8900 *18,900	*5900 *12,700	5150 11,050	*4850 *10,500	3400 7,300			*2900 *6,300	2450 5,400	7450 24'04"
1500 mm 5'0"	kg lb					*7250 *15,600	4800 10,350	5000 10,700	3250 6,950	*3500 2350		*3050 *6,750	2350 5,100	7560 24'09"
0 mm 0'0"	kg lb			*6200 *14,200	*6200 *14,200	7500 16,050	4600 9,900	4850 10,450	3150 6,750			*3450 *7,600	2400 5,200	7370 24'02"
-1500 mm -5'0"	kg lb	*5650 *12,650	*5650 *12,650	*10 050 *22,950	8300 17,800	7400 15,900	4550 9,750	4800 10,350	3100 6,650			4000 8,850	2600 5,750	6850 22'04"
-3000 mm -10'0"	kg lb	*9900 *22,300	*9900 *22,300	*10 750 *23,250	8400 18,050	7450 16,000	4600 9,850					5000 11,100	3200 7,150	5900 19'02"
-4500 mm -15'0"	kg lb			*7750 *16,400								*5450 *11,900	5200 *11,900	4240 13'06"

Reach Boom Lift Capacities – Counterweight: 3.05 mt (6,720 lb) – without Bucket – Blade Up

2700 mm (8'10") Blade

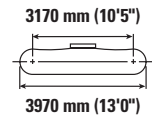
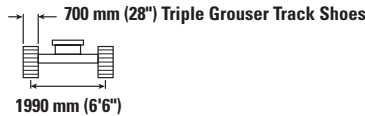
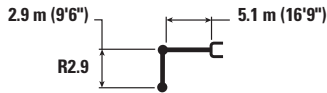

		1500 mm/5'0"		3000 mm/10'0"		4500 mm/15'0"		6000 mm/20'0"		7500 mm/25'0"		mm ft/in		
7500 mm 25'0"	kg lb											*2950 *6,600	*2950 *6,600	5100 16'02"
6000 mm 20'0"	kg lb							*3650 *7,450	3600 *7,450			*2650 *5,900	*2650 *5,900	6450 20'11"
4500 mm 15'0"	kg lb							*4050 *8,850	3500 7,550			*2600 *5,700	2600 *5,700	7240 23'07"
3000 mm 10'0"	kg lb			*8000 *17,050	*8000 *17,050	*5550 *11,950	5150 11,100	*4600 *10,000	3350 7,250	*3350 *6,200	2400 5,100	*2700 *5,850	2300 5,100	7660 25'01"
1500 mm 5'0"	kg lb			*6950 *16,650	*6950 *16,650	*6950 *14,950	4800 10,300	4950 10,600	3200 6,900	3550 7,600	2350 5,000	*2900 *6,300	2200 4,850	7780 25'05"
0 mm 0'0"	kg lb			*6950 *15,950	*6950 *15,950	7400 15,900	4550 9,800	4800 10,300	3100 6,600	3500 6,600	2250	*3250 *7,150	2250 4,900	7590 24'10"
-1500 mm -5'0"	kg lb	*5650 *12,550	*5650 *12,550	*10 000 *22,750	8150 17,450	7300 15,650	4450 9,600	4750 10,150	3000 6,500			3750 8,250	2450 5,350	7080 23'02"
-3000 mm -10'0"	kg lb	*9250 *20,750	*9250 *20,750	*11 150 *24,050	8250 17,700	7300 15,700	4500 9,650	4750 10,250	3050 6,600			4600 10,200	2950 6,550	6160 20'01"
-4500 mm -15'0"	kg lb			*8550 *18,200	8550 *18,200	*5750	4650					*5550 *12,200	4500 10,300	4610 14'09"



ISO 10567:2007



* Indicates that the load is limited by hydraulic lifting capacity rather than tipping load. The above loads are in compliance with hydraulic excavator lift capacity standard ISO 10567:2007. They do not exceed 87% of hydraulic lifting capacity or 75% of tipping load. Weight of all lifting accessories must be deducted from the above lifting capacities. Lifting capacities are based on the machine standing on a firm, uniform supporting surface. The use of a work tool attachment point to handle/lift objects, could affect the machine lift performance.

Lift capacity stays with ±5% for all available track shoes.

Always refer to the appropriate Operation and Maintenance Manual for specific product information.

317 GC Hydraulic Excavator Specifications

Reach Boom Lift Capacities – Counterweight: 3.05 mt (6,720 lb) – without Bucket – Blade Up

2600 mm (8'6") Blade

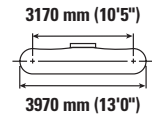
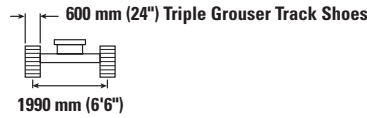
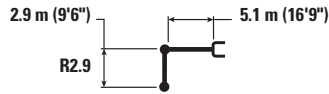

		1500 mm/5'0"		3000 mm/10'0"		4500 mm/15'0"		6000 mm/20'0"		7500 mm/25'0"		mm ft/in		
7500 mm 25'0"	kg lb											*2950 *6,600	*2950 *6,600	5100 16'02"
6000 mm 20'0"	kg lb							*3650 *7,450	3550 *7,450			*2650 *5,900	*2650 *5,900	6450 20'11"
4500 mm 15'0"	kg lb							*4050 *8,850	3450 7,450			*2600 *5,700	2550 5,650	7240 23'07"
3000 mm 10'0"	kg lb			*8000 *17,050	*8000 *17,050	*5550 *11,950	5100 10,950	*4600 *10,000	3350 7,150	*3350 *6,200	2350 5,050	*2700 *5,850	2300 5,000	7660 25'01"
1500 mm 5'0"	kg lb			*6950 *16,650	*6950 *16,650	*6950 *14,950	4750 10,200	4900 10,450	3150 6,800	3500 7,500	2300 4,900	*2900 *6,300	2200 4,750	7780 25'05"
0 mm 0'0"	kg lb			*6950 *15,950	6950 *15,950	7300 15,700	4500 9,650	4750 10,150	3050 6,550	3450	2250	*3250 *7,150	2200 4,850	7590 24'10"
-1500 mm -5'0"	kg lb	*5650 *12,550	*5650 *12,550	*10 000 *22,750	8050 17,250	7200 15,450	4400 9,450	4650 10,000	3000 6,400			3700 8,150	2400 5,300	7080 23'02"
-3000 mm -10'0"	kg lb	*9250 *20,750	*9250 *20,750	*11 150 *24,050	8150 17,450	7250 15,500	4400 9,500	4700 10,100	3000 6,500			4550 10,050	2900 6,450	6160 20'01"
-4500 mm -15'0"	kg lb			*8550 *18,200	8400 18,100	*5750	4600					*5550 *12,200	4450 10,150	4610 14'09"

Reach Boom Lift Capacities – Counterweight: 3.05 mt (6,720 lb) – without Bucket – Blade Up

2600 mm (8'6") Blade

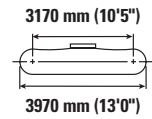
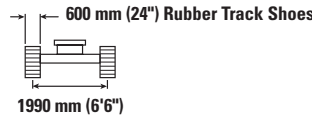
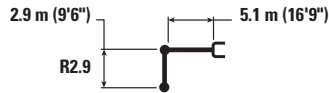

		1500 mm/5'0"		3000 mm/10'0"		4500 mm/15'0"		6000 mm/20'0"		7500 mm/25'0"		mm ft/in		
7500 mm 25'0"	kg lb											*2950 *6,600	*2950 *6,600	5100 16'02"
6000 mm 20'0"	kg lb							*3650 *7,450	3600 *7,450			*2650 *5,900	*2650 *5,900	6450 20'11"
4500 mm 15'0"	kg lb							*4050 *8,850	3550 7,600			*2600 *5,700	2600 *5,700	7240 23'07"
3000 mm 10'0"	kg lb			*8000 *17,050	*8000 *17,050	*5550 *11,950	5150 11,150	*4600 *10,000	3400 7,300	*3350 *6,200	2400 5,150	*2700 *5,850	2350 5,100	7660 25'01"
1500 mm 5'0"	kg lb			*6950 *16,650	*6950 *16,650	*6950 *14,950	4800 10,350	5000 10,700	3250 6,950	3550 7,650	2350 5,000	*2900 *6,300	2200 4,850	7780 25'05"
0 mm 0'0"	kg lb			*6950 *15,950	*6950 *15,950	7450 16,000	4600 9,850	4850 10,400	3100 6,650	3500	2300	*3250 *7,150	2250 4,950	7590 24'10"
-1500 mm -5'0"	kg lb	*5650 *12,550	*5650 *12,550	*10 000 *22,750	8200 17,550	7350 15,750	4500 9,650	4750 10,250	3050 6,550			3800 8,350	2450 5,400	7080 23'02"
-3000 mm -10'0"	kg lb	*9250 *20,750	*9250 *20,750	*11 150 *24,050	8300 17,800	7400 15,850	4500 9,700	4800 10,350	3050 6,600			4650 10,250	2950 6,600	6160 20'01"
-4500 mm -15'0"	kg lb			*8550 *18,200	*8550 *18,200	*5750	4700					*5550 *12,200	4550 10,350	4610 14'09"



ISO 10567:2007



* Indicates that the load is limited by hydraulic lifting capacity rather than tipping load. The above loads are in compliance with hydraulic excavator lift capacity standard ISO 10567:2007. They do not exceed 87% of hydraulic lifting capacity or 75% of tipping load. Weight of all lifting accessories must be deducted from the above lifting capacities. Lifting capacities are based on the machine standing on a firm, uniform supporting surface. The use of a work tool attachment point to handle/lift objects, could affect the machine lift performance.

Lift capacity stays with ±5% for all available track shoes.

Always refer to the appropriate Operation and Maintenance Manual for specific product information.

317 GC Hydraulic Excavator Specifications

Reach Boom Lift Capacities – Counterweight: 3.05 mt (6,720 lb) – without Bucket – Blade Up

2700 mm (8'10") Blade

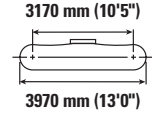
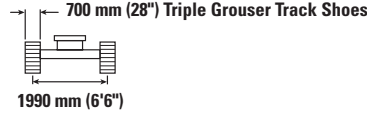
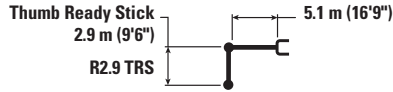

		1500 mm/5'0"		3000 mm/10'0"		4500 mm/15'0"		6000 mm/20'0"		7500 mm/25'0"		mm ft/in		
7500 mm 25'0"	kg lb											*2900 *6,500	*2900 *6,500	5100 16'02"
6000 mm 20'0"	kg lb							*3600 *7,350	3500 *7,350			*2650 *5,800	*2650 *5,800	6450 20'11"
4500 mm 15'0"	kg lb							*4000 *8,700	3450 7,400			*2550 *5,600	2550 5,600	7240 23'07"
3000 mm 10'0"	kg lb			*7900 *16,850	*7900 *16,850	*5450 *11,750	5100 10,950	*4550 *9,850	3300 7,100	*3300 *6,100	2350 5,000	*2650 *5,750	2250 4,950	7660 25'01"
1500 mm 5'0"	kg lb			*6900 *16,550	*6900 *16,550	*6850 *14,750	4700 10,150	4850 10,450	3150 6,750	3500 7,450	2250 4,850	*2850 *6,200	2150 4,700	7780 25'05"
0 mm 0'0"	kg lb			*6900 *15,850	*6900 *15,850	7300 15,700	4450 9,600	4750 10,150	3000 6,450	3400 2200		*3200 *7,050	2200 4,750	7590 24'10"
-1500 mm -5'0"	kg lb	*5600 *12,500	*5600 *12,500	*9950 *22,650	8000 17,200	7200 15,450	4350 9,400	4650 10,000	2950 6,350			3700 8,150	2350 5,200	7080 23'02"
-3000 mm -10'0"	kg lb	*9200 *20,650	*9200 *20,650	*11 000 *23,800	8150 17,450	7250 15,550	4400 9,450	4700 10,100	3000 6,450			4550 10,050	2900 6,400	6160 20'01"
-4500 mm -15'0"	kg lb			*8450 *18,000	8450 *18,000	*5650	4600					*5450 *12,000	4450 10,100	4610 14'09"

Reach Boom Lift Capacities – Counterweight: 3.05 mt (6,720 lb) – without Bucket – Blade Up

2600 mm (8'6") Blade

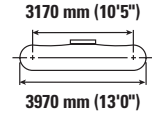
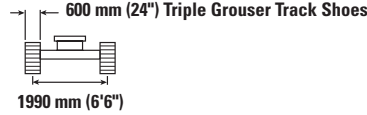
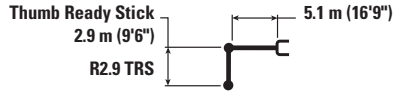

		1500 mm/5'0"		3000 mm/10'0"		4500 mm/15'0"		6000 mm/20'0"		7500 mm/25'0"		mm ft/in		
7500 mm 25'0"	kg lb											*2900 *6,500	*2900 *6,500	5100 16'02"
6000 mm 20'0"	kg lb							*3600 *7,350	3500 *7,350			*2650 *5,800	*2650 *5,800	6450 20'11"
4500 mm 15'0"	kg lb							*4000 *8,700	3400 7,350			*2550 *5,600	2500 5,500	7240 23'07"
3000 mm 10'0"	kg lb			*7900 *16,850	*7900 *16,850	*5450 *11,750	5000 10,800	*4550 *9,850	3250 7,000	*3300 *6,100	2300 4,900	*2650 *5,750	2200 4,900	7660 25'01"
1500 mm 5'0"	kg lb			*6900 *16,550	*6900 *16,550	*6850 *14,750	4650 10,000	4800 10,350	3100 6,650	3450 7,350	2250 4,800	*2850 *6,200	2100 4,650	7780 25'05"
0 mm 0'0"	kg lb			*6900 *15,850	*6900 *15,850	7200 15,500	4400 9,450	4650 10,000	2950 6,400	3350 2200		*3200 *7,050	2150 4,700	7590 24'10"
-1500 mm -5'0"	kg lb	*5600 *12,500	*5600 *12,500	*9950 *22,650	7900 16,950	7100 15,250	4300 9,250	4600 9,850	2900 6,250			3650 8,000	2350 5,150	7080 23'02"
-3000 mm -10'0"	kg lb	*9200 *20,650	*9200 *20,650	*11 000 *23,800	8050 17,250	7150 15,350	4350 9,350	4650 9,950	2950 6,350			4450 9,900	2850 6,300	6160 20'01"
-4500 mm -15'0"	kg lb			*8450 *18,000	8300 17,900	*5650	4550					*5450 *12,000	4400 10,000	4610 14'09"



ISO 10567:2007



* Indicates that the load is limited by hydraulic lifting capacity rather than tipping load. The above loads are in compliance with hydraulic excavator lift capacity standard ISO 10567:2007. They do not exceed 87% of hydraulic lifting capacity or 75% of tipping load. Weight of all lifting accessories must be deducted from the above lifting capacities. Lifting capacities are based on the machine standing on a firm, uniform supporting surface. The use of a work tool attachment point to handle/lift objects, could affect the machine lift performance.

Lift capacity stays with ±5% for all available track shoes.

Always refer to the appropriate Operation and Maintenance Manual for specific product information.

317 GC Hydraulic Excavator Specifications

Reach Boom Lift Capacities – Counterweight: 3.05 mt (6,720 lb) – without Bucket – Blade Up

2600 mm (8'6") Blade

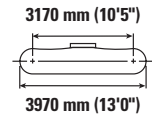
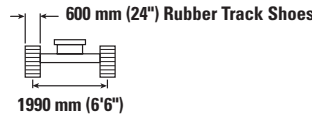
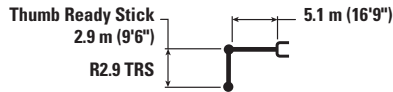

		1500 mm/5'0"		3000 mm/10'0"		4500 mm/15'0"		6000 mm/20'0"		7500 mm/25'0"		mm ft/in		
7500 mm 25'0"	kg lb											*2900 *6,500	*2900 *6,500	5100 16'02"
6000 mm 20'0"	kg lb							*3600 *7,350	3550 *7,350			*2650 *5,800	*2650 *5,800	6450 20'11"
4500 mm 15'0"	kg lb							*4000 *8,700	3500 7,450			*2550 *5,600	2550 *5,600	7240 23'07"
3000 mm 10'0"	kg lb			*7900 *16,850	*7900 *16,850	*5450 *11,750	5100 11,000	*4550 *9,850	3350 7,150	*3300 *6,100	2350 5,000	*2650 *5,750	2250 5,000	7660 25'01"
1500 mm 5'0"	kg lb			*6900 *16,550	*6900 *16,550	*6850 *14,750	4750 10,200	4900 10,550	3150 6,800	3500 7,500	2300 4,900	*2850 *6,200	2150 4,750	7780 25'05"
0 mm 0'0"	kg lb			*6900 *15,850	*6900 *15,850	7350 15,800	4500 9,650	4750 10,250	3050 6,500	3450	2200	*3200 *7,050	2200 4,800	7590 24'10"
-1500 mm -5'0"	kg lb	*5600 *12,500	*5600 *12,500	*9950 *22,650	8050 17,300	7250 15,550	4400 9,450	4700 10,100	2950 6,400			3700 8,200	2400 5,250	7080 23'02"
-3000 mm -10'0"	kg lb	*9200 *20,650	*9200 *20,650	*11,000 *23,800	8200 17,550	7300 15,650	4450 9,500	4750 10,200	3000 6,450			4550 10,100	2900 6,450	6160 20'01"
-4500 mm -15'0"	kg lb			*8450 *18,000	*8450 *18,000	*5650	4600					*5450 *12,000	4500 10,200	4610 14'09"

Reach Boom Lift Capacities – Counterweight: 3.05 mt (6,720 lb) – without Bucket – Blade Up

2700 mm (8'10") Blade

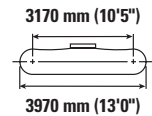
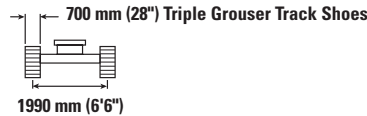
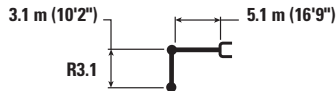

		1500 mm/5'0"		3000 mm/10'0"		4500 mm/15'0"		6000 mm/20'0"		7500 mm/25'0"		mm ft/in		
7500 mm 25'0"	kg lb											*2700 *6,050	*2700 *6,050	5380 17'02"
6000 mm 20'0"	kg lb							*3650 *7,550	3600 *7,550			*2450 *5,400	*2450 *5,400	6670 21'07"
4500 mm 15'0"	kg lb							*3900 *8,500	3550 7,600			*2400 *5,250	*2400 *5,250	7440 24'03"
3000 mm 10'0"	kg lb			*7500 *15,950	*7500 *15,950	*5300 *11,450	5200 11,200	*4500 *9,700	3400 7,300	*3600 *7,100	2400 5,150	*2450 *5,400	2250 4,900	7850 25'08"
1500 mm 5'0"	kg lb			*8250 *19,750	*8250 18,600	*6750 *14,550	4850 10,400	4950 10,650	3250 6,950	3550 7,600	2350 5,000	*2650 *5,800	2150 4,700	7960 26'01"
0 mm 0'0"	kg lb			*7150 *16,450	*7150 *16,450	7450 15,950	4550 9,850	4800 10,300	3100 6,650	3500 7,450	2250 4,850	*3000 *6,550	2150 4,750	7780 25'05"
-1500 mm -5'0"	kg lb	*5400 *12,050	*5400 *12,050	*9700 *22,100	8150 17,450	7300 15,650	4450 9,600	4700 10,150	3000 6,500			*3600 7,950	2350 5,150	7280 23'10"
-3000 mm -10'0"	kg lb	*8700 *19,450	*8700 *19,450	*11,400 *24,650	8200 17,650	7300 15,700	4450 9,600	4750 10,200	3050 6,550			4350 9,650	2800 6,200	6400 20'10"
-4500 mm -15'0"	kg lb			*9100 *19,350	8450 18,200	*6150 *12,950	4600 9,950					*5450 *12,000	4100 9,300	4920 15'09"



ISO 10567:2007



* Indicates that the load is limited by hydraulic lifting capacity rather than tipping load. The above loads are in compliance with hydraulic excavator lift capacity standard ISO 10567:2007. They do not exceed 87% of hydraulic lifting capacity or 75% of tipping load. Weight of all lifting accessories must be deducted from the above lifting capacities. Lifting capacities are based on the machine standing on a firm, uniform supporting surface. The use of a work tool attachment point to handle/lift objects, could affect the machine lift performance.

Lift capacity stays with ±5% for all available track shoes.

Always refer to the appropriate Operation and Maintenance Manual for specific product information.

317 GC Hydraulic Excavator Specifications

Reach Boom Lift Capacities – Counterweight: 3.05 mt (6,720 lb) – without Bucket – Blade Up

2600 mm (8'6") Blade

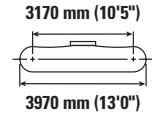
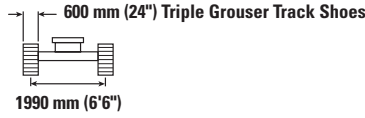
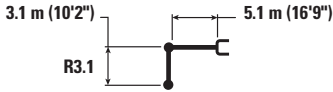

		1500 mm/5'0"		3000 mm/10'0"		4500 mm/15'0"		6000 mm/20'0"		7500 mm/25'0"		mm ft/in		
7500 mm 25'0"	kg lb											*2700 *6,050	*2700 *6,050	5380 17'02"
6000 mm 20'0"	kg lb							*3650 *7,550	3550 *7,550			*2450 *5,400	*2450 *5,400	6670 21'07"
4500 mm 15'0"	kg lb							*3900 *8,500	3500 7,500			*2400 *5,250	*2400 *5,250	7440 24'03"
3000 mm 10'0"	kg lb			*7500 *15,950	*7500 *15,950	*5300 *11,450	5150 11,050	*4500 *9,700	3350 7,200	*3600 *7,100	2400 5,100	*2450 *5,400	2200 4,850	7850 25'08"
1500 mm 5'0"	kg lb			*8250 *19,750	*8250 *18,350	*6750 *14,550	4750 10,250	4900 10,500	3200 6,850	3500 7,500	2300 4,950	*2650 *5,800	2100 4,600	7960 26'01"
0 mm 0'0"	kg lb			*7150 *16,450	*7150 *16,450	7350 15,750	4500 9,700	4750 10,200	3050 6,550	3450 7,350	2250 4,800	*3000 *6,550	2150 4,650	7780 25'05"
-1500 mm -5'0"	kg lb	*5400 *12,050	*5400 *12,050	*9700 *22,100	8050 17,250	7200 15,450	4400 9,450	4650 10,000	3000 6,400			3550 7,850	2300 5,050	7280 23'10"
-3000 mm -10'0"	kg lb	*8700 *19,450	*8700 *19,450	*11,400 *24,650	8100 17,400	7200 15,500	4400 9,500	4700 10,050	3000 6,450			4300 9,500	2750 6,100	6400 20'10"
-4500 mm -15'0"	kg lb			*9100 *19,350	8350 18,000	*6150 *12,950	4550 9,850					*5450 *12,000	4050 9,150	4920 15'09"

Reach Boom Lift Capacities – Counterweight: 3.05 mt (6,720 lb) – without Bucket – Blade Up

2600 mm (8'6") Blade

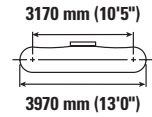
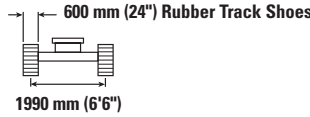
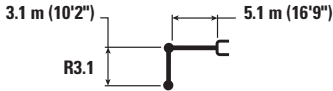

		1500 mm/5'0"		3000 mm/10'0"		4500 mm/15'0"		6000 mm/20'0"		7500 mm/25'0"		mm ft/in		
7500 mm 25'0"	kg lb											*2700 *6,050	*2700 *6,050	5380 17'02"
6000 mm 20'0"	kg lb							*3650 *7,550	*3650 *7,550			*2450 *5,400	*2450 *5,400	6670 21'07"
4500 mm 15'0"	kg lb							*3900 *8,500	3550 7,650			*2400 *5,250	*2400 *5,250	7440 24'03"
3000 mm 10'0"	kg lb			*7500 *15,950	*7500 *15,950	*5300 *11,450	5200 11,250	*4500 *9,700	3400 7,350	*3600 *7,100	2450 5,200	*2450 *5,400	2250 4,950	7850 25'08"
1500 mm 5'0"	kg lb			*8250 *19,750	*8250 *18,700	*6750 *14,550	4850 10,450	5000 10,750	3250 7,000	3600 7,650	2350 5,050	*2650 *5,800	2150 4,700	7960 26'01"
0 mm 0'0"	kg lb			*7150 *16,450	*7150 *16,450	7500 16,050	4600 9,900	4850 10,400	3100 6,700	3500 7,550	2300 4,900	*3000 *6,550	2200 4,750	7780 25'05"
-1500 mm -5'0"	kg lb	*5400 *12,050	*5400 *12,050	*9700 *22,100	8200 17,550	7350 15,750	4500 9,650	4750 10,250	3050 6,550			*3600 *7,950	2350 5,200	7280 23'10"
-3000 mm -10'0"	kg lb	*8700 *19,450	*8700 *19,450	*11,400 *24,650	8250 17,750	7350 15,800	4500 9,650	4800 10,300	3050 6,550			4400 9,700	2800 6,250	6400 20'10"
-4500 mm -15'0"	kg lb			*9100 *19,350	8500 18,300	*6150 *12,950	4650 10,000					*5450 *12,000	4150 9,350	4920 15'09"



ISO 10567:2007



* Indicates that the load is limited by hydraulic lifting capacity rather than tipping load. The above loads are in compliance with hydraulic excavator lift capacity standard ISO 10567:2007. They do not exceed 87% of hydraulic lifting capacity or 75% of tipping load. Weight of all lifting accessories must be deducted from the above lifting capacities. Lifting capacities are based on the machine standing on a firm, uniform supporting surface. The use of a work tool attachment point to handle/lift objects, could affect the machine lift performance.

Lift capacity stays with ±5% for all available track shoes.

Always refer to the appropriate Operation and Maintenance Manual for specific product information.

317 GC Hydraulic Excavator Specifications

Reach Boom Lift Capacities – Counterweight: 3.57 mt (7,870 lb) – without Bucket – Blade Up

2700 mm (8'10") Blade

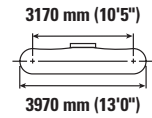
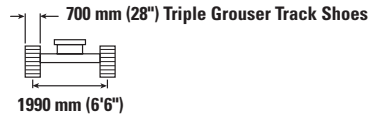
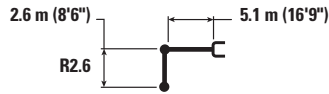

		1500 mm/5'0"		3000 mm/10'0"		4500 mm/15'0"		6000 mm/20'0"		7500 mm/25'0"		mm ft/in		
7500 mm 25'0"	kg lb					*7,700	*7,700					*3350 *7,450	*3350 *7,450	4770 15'01"
6000 mm 20'0"	kg lb							*3600 *6,650	*3600 *6,650			*2950 *6,450	*2950 *6,450	6190 20'00"
4500 mm 15'0"	kg lb					*4650 *10,050	*4650 *10,050	*4300 *9,450	3750 8,100			*2850 *6,200	*2850 *6,200	7020 22'10"
3000 mm 10'0"	kg lb			*8900 *18,900	*8900 *18,900	*5900 *12,700	5500 11,800	*4850 *10,500	3650 7,800			*2900 *6,300	2650 5,800	7450 24'04"
1500 mm 5'0"	kg lb					*7250 *15,600	5150 11,100	5300 11,350	3500 7,500	*3500 2550		*3050 *6,750	2500 5,550	7560 24'09"
0 mm 0'0"	kg lb			*6200 *14,200	*6200 *14,200	7950 17,050	4950 10,650	5150 11,100	3350 7,250			*3450 *7,600	2550 5,650	7370 24'02"
-1500 mm -5'0"	kg lb	*5650 *12,650	*5650 *12,650	*10 050 *22,950	8900 19,100	7850 16,850	4900 10,500	5100 11,000	3350 7,150			*4200 *9,300	2800 6,200	6850 22'04"
-3000 mm -10'0"	kg lb	*9900 *22,300	*9900 *22,300	*10 750 *23,250	9050 19,400	*7450 *16,050	4950 10,600					5300 11,800	3450 7,650	5900 19'02"
-4500 mm -15'0"	kg lb			*7750 *16,400	*7750 *16,400							*5450 *11,900	*5450 *11,900	4240 13'06"

Reach Boom Lift Capacities – Counterweight: 3.57 mt (7,870 lb) – without Bucket – Blade Up

2600 mm (8'6") Blade

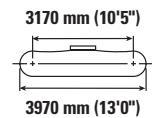
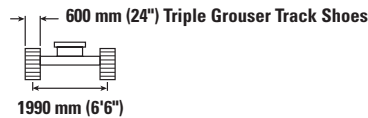

		1500 mm/5'0"		3000 mm/10'0"		4500 mm/15'0"		6000 mm/20'0"		7500 mm/25'0"		mm ft/in		
7500 mm 25'0"	kg lb					*7,700	*7,700					*3350 *7,450	*3350 *7,450	4770 15'01"
6000 mm 20'0"	kg lb							*3600 *6,650	*3600 *6,650			*2950 *6,450	*2950 *6,450	6190 20'00"
4500 mm 15'0"	kg lb					*4650 *10,050	*4650 *10,050	*4300 *9,450	3700 8,000			*2850 *6,200	*2850 *6,200	7020 22'10"
3000 mm 10'0"	kg lb			*8900 *18,900	*8900 *18,900	*5900 *12,700	5450 11,700	*4850 *10,500	3600 7,700			*2900 *6,300	2600 5,700	7450 24'04"
1500 mm 5'0"	kg lb					*7250 *15,600	5100 10,950	5200 11,200	3450 7,400	*3500 2500		*3050 *6,750	2500 5,450	7560 24'09"
0 mm 0'0"	kg lb			*6200 *14,200	*6200 *14,200	7850 16,850	4900 10,500	5100 10,950	3350 7,150			*3450 *7,600	2550 5,550	7370 24'02"
-1500 mm -5'0"	kg lb	*5650 *12,650	*5650 *12,650	*10 050 *22,950	8800 18,900	7750 16,650	4800 10,350	5050 10,850	3300 7,050			4200 9,250	2800 6,100	6850 22'04"
-3000 mm -10'0"	kg lb	*9900 *22,300	*9900 *22,300	*10 750 *23,250	8950 19,150	*7450 *16,050	4850 10,500					5250 11,650	3400 7,600	5900 19'02"
-4500 mm -15'0"	kg lb			*7750 *16,400	*7750 *16,400							*5450 *11,900	*5450 *11,900	4240 13'06"



ISO 10567:2007



* Indicates that the load is limited by hydraulic lifting capacity rather than tipping load. The above loads are in compliance with hydraulic excavator lift capacity standard ISO 10567:2007. They do not exceed 87% of hydraulic lifting capacity or 75% of tipping load. Weight of all lifting accessories must be deducted from the above lifting capacities. Lifting capacities are based on the machine standing on a firm, uniform supporting surface. The use of a work tool attachment point to handle/lift objects, could affect the machine lift performance.

Lift capacity stays with ±5% for all available track shoes.

Always refer to the appropriate Operation and Maintenance Manual for specific product information.

317 GC Hydraulic Excavator Specifications

Reach Boom Lift Capacities – Counterweight: 3.57 mt (7,870 lb) – without Bucket – Blade Up

2600 mm (8'6") Blade

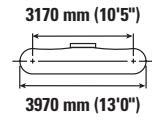
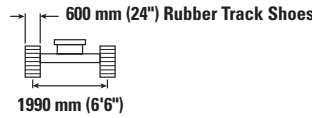
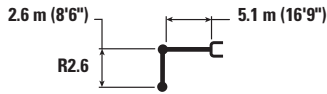

		1500 mm/5'0"		3000 mm/10'0"		4500 mm/15'0"		6000 mm/20'0"		7500 mm/25'0"		mm ft/in		
7500 mm 25'0"	kg lb					*7,700	*7,700					*3350 *7,450	*3350 *7,450	4770 15'01"
6000 mm 20'0"	kg lb							*3600 *6,650	*3600 *6,650			*2950 *6,450	*2950 *6,450	6190 20'00"
4500 mm 15'0"	kg lb					*4650 *10,050	*4650 *10,050	*4300 *9,450	3800 8,100			*2850 *6,200	*2850 *6,200	7020 22'10"
3000 mm 10'0"	kg lb			*8900 *18,900	*8900 *18,900	*5900 *12,700	5500 11,900	*4850 *10,500	3650 7,850			*2900 *6,300	2650 5,800	7450 24'04"
1500 mm 5'0"	kg lb					*7250 *15,600	5200 11,150	5300 11,450	3500 7,550	*3500 2550		*3050 *6,750	2550 5,550	7560 24'09"
0 mm 0'0"	kg lb			*6200 *14,200	*6200 *14,200	8000 17,150	5000 10,700	5200 11,150	3400 7,300			*3450 *7,600	2600 5,650	7370 24'02"
-1500 mm -5'0"	kg lb	*5650 *12,650	*5650 *12,650	*10 050 *22,950	8950 19,200	7900 16,950	4900 10,550	5150 11,050	3350 7,200			*4200 *9,300	2850 6,250	6850 22'04"
-3000 mm -10'0"	kg lb	*9900 *22,300	*9900 *22,300	*10 750 *23,250	9100 19,500	*7450 *16,050	4950 10,650					5350 *11,800	3500 7,700	5900 19'02"
-4500 mm -15'0"	kg lb			*7750 *16,400	*7750 *16,400							*5450 *11,900	*5450 *11,900	4240 13'06"

Reach Boom Lift Capacities – Counterweight: 3.57 mt (7,870 lb) – without Bucket – Blade Up

2700 mm (8'10") Blade

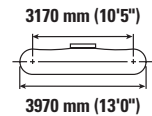
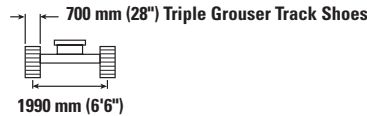
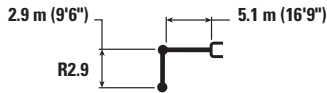

		1500 mm/5'0"		3000 mm/10'0"		4500 mm/15'0"		6000 mm/20'0"		7500 mm/25'0"		mm ft/in		
7500 mm 25'0"	kg lb											*2950 *6,600	*2950 *6,600	5100 16'02"
6000 mm 20'0"	kg lb							*3650 *7,450	*3650 *7,450			*2650 *5,900	*2650 *5,900	6450 20'11"
4500 mm 15'0"	kg lb							*4050 *8,850	3800 8,100			*2600 *5,700	*2600 *5,700	7240 23'07"
3000 mm 10'0"	kg lb			*8000 *17,050	*8000 *17,050	*5550 *11,950	5500 11,900	*4600 *10,000	3650 7,800	*3350 *6,200	2600 5,550	*2700 *5,850	2500 5,500	7660 25'01"
1500 mm 5'0"	kg lb			*6950 *16,650	*6950 *16,650	*6950 *14,950	5150 11,100	*5250 11,350	3450 7,450	3800 *7,950	2550 5,400	*2900 *6,300	2400 5,250	7780 25'05"
0 mm 0'0"	kg lb			*6950 *15,950	*6950 *15,950	*7850 17,000	4900 10,600	5150 11,050	3350 7,200	3750 2450		*3250 *7,150	2450 5,350	7590 24'10"
-1500 mm -5'0"	kg lb	*5650 *12,550	*5650 *12,550	*10 000 *22,750	8800 18,900	7800 16,750	4850 10,400	5050 10,900	3300 7,050			*4000 *8,800	2650 5,850	7080 23'02"
-3000 mm -10'0"	kg lb	*9250 *20,750	*9250 *20,750	*11 150 *24,050	8900 19,150	*7600 *16,450	4850 10,450	5100 10,950	3300 7,150			4900 10,900	3200 7,100	6160 20'01"
-4500 mm -15'0"	kg lb			*8550 *18,200	*8550 *18,200	*5750	5050					*5550 *12,200	4900 11,100	4610 14'09"



ISO 10567:2007



* Indicates that the load is limited by hydraulic lifting capacity rather than tipping load. The above loads are in compliance with hydraulic excavator lift capacity standard ISO 10567:2007. They do not exceed 87% of hydraulic lifting capacity or 75% of tipping load. Weight of all lifting accessories must be deducted from the above lifting capacities. Lifting capacities are based on the machine standing on a firm, uniform supporting surface. The use of a work tool attachment point to handle/lift objects, could affect the machine lift performance.

Lift capacity stays with ±5% for all available track shoes.

Always refer to the appropriate Operation and Maintenance Manual for specific product information.

317 GC Hydraulic Excavator Specifications

Reach Boom Lift Capacities – Counterweight: 3.57 mt (7,870 lb) – without Bucket – Blade Up

2600 mm (8'6") Blade

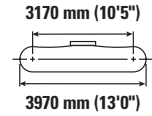
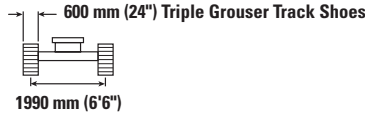
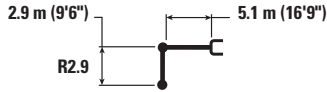

		1500 mm/5'0"		3000 mm/10'0"		4500 mm/15'0"		6000 mm/20'0"		7500 mm/25'0"		mm ft/in		
7500 mm 25'0"	kg lb											*2950 *6,600	*2950 *6,600	5100 16'02"
6000 mm 20'0"	kg lb							*3650 *7,450	*3650 *7,450			*2650 *5,900	*2650 *5,900	6450 20'11"
4500 mm 15'0"	kg lb							*4050 *8,850	3750 8,000			*2600 *5,700	*2600 *5,700	7240 23'07"
3000 mm 10'0"	kg lb			*8000 *17,050	*8000 *17,050	*5550 *11,950	5450 11,750	*4600 *10,000	3600 7,700	*3350 *6,200	2550 5,500	*2700 *5,850	2500 5,450	7660 25'01"
1500 mm 5'0"	kg lb			*6950 *16,650	*6950 *16,650	*6950 *14,950	5100 11,000	5200 11,200	3450 7,350	3750 *7,950	2500 5,350	*2900 *6,300	2350 5,200	7780 25'05"
0 mm 0'0"	kg lb			*6950 *15,950	*6950 *15,950	7800 16,800	4850 10,450	5050 10,900	3300 7,100	3700	2450	*3250 *7,150	2400 5,250	7590 24'10"
-1500 mm -5'0"	kg lb	*5650 *12,550	*5650 *12,550	*10 000 *22,750	8700 18,650	7700 16,550	4750 10,250	5000 10,750	3250 6,950			3950 8,750	2600 5,750	7080 23'02"
-3000 mm -10'0"	kg lb	*9250 *20,750	*9250 *20,750	*11 150 *24,050	8800 18,900	*7600 *16,450	4800 10,300	5050 10,850	3250 7,050			4850 10,750	3150 7,000	6160 20'01"
-4500 mm -15'0"	kg lb			*8550 *18,200	*8550 *18,200	*5750	5000					*5550 *12,200	4850 10,950	4610 14'09"

Reach Boom Lift Capacities – Counterweight: 3.57 mt (7,870 lb) – without Bucket – Blade Up

2600 mm (8'6") Blade

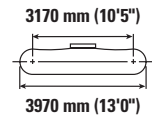
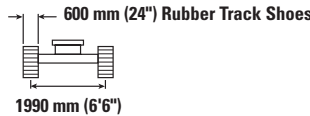

		1500 mm/5'0"		3000 mm/10'0"		4500 mm/15'0"		6000 mm/20'0"		7500 mm/25'0"		mm ft/in		
7500 mm 25'0"	kg lb											*2950 *6,600	*2950 *6,600	5100 16'02"
6000 mm 20'0"	kg lb							*3650 *7,450	*3650 *7,450			*2650 *5,900	*2650 *5,900	6450 20'11"
4500 mm 15'0"	kg lb							*4050 *8,850	3800 8,150			*2600 *5,700	*2600 *5,700	7240 23'07"
3000 mm 10'0"	kg lb			*8000 *17,050	*8000 *17,050	*5550 *11,950	*5550 *11,950	*4600 *10,000	3650 7,850	*3350 *6,200	2600 5,600	*2700 *5,850	2500 5,550	7660 25'01"
1500 mm 5'0"	kg lb			*6950 *16,650	*6950 *16,650	*6950 *14,950	5200 11,200	*5250 11,400	3500 7,500	3800 *7,950	2550 5,450	*2900 *6,300	2400 5,300	7780 25'05"
0 mm 0'0"	kg lb			*6950 *15,950	*6950 *15,950	*7850 *17,000	4950 10,650	5150 11,100	3350 7,250	3750	2500	*3250 *7,150	2450 5,350	7590 24'10"
-1500 mm -5'0"	kg lb	*5650 *12,550	*5650 *12,550	*10 000 *22,750	8850 19,000	7850 16,850	4850 10,450	5100 10,950	3300 7,100			*4000 *8,800	2650 5,850	7080 23'02"
-3000 mm -10'0"	kg lb	*9250 *20,750	*9250 *20,750	*11 150 *24,050	8950 19,250	*7600 *16,450	4900 10,500	5150 11,050	3350 7,200			4950 11,000	3200 7,150	6160 20'01"
-4500 mm -15'0"	kg lb			*8550 *18,200	*8550 *18,200	*5750	5050					*5550 *12,200	4900 11,150	4610 14'09"



ISO 10567:2007



* Indicates that the load is limited by hydraulic lifting capacity rather than tipping load. The above loads are in compliance with hydraulic excavator lift capacity standard ISO 10567:2007. They do not exceed 87% of hydraulic lifting capacity or 75% of tipping load. Weight of all lifting accessories must be deducted from the above lifting capacities. Lifting capacities are based on the machine standing on a firm, uniform supporting surface. The use of a work tool attachment point to handle/lift objects, could affect the machine lift performance.

Lift capacity stays with ±5% for all available track shoes.

Always refer to the appropriate Operation and Maintenance Manual for specific product information.

317 GC Hydraulic Excavator Specifications

Reach Boom Lift Capacities – Counterweight: 3.57 mt (7,870 lb) – without Bucket – Blade Up

2700 mm (8'10") Blade

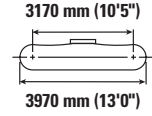
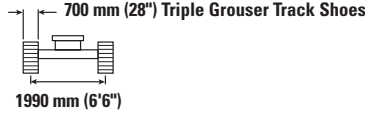
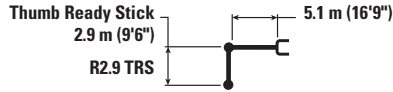

		1500 mm/5'0"		3000 mm/10'0"		4500 mm/15'0"		6000 mm/20'0"		7500 mm/25'0"		mm ft/in		
7500 mm 25'0"	kg lb											*2900 *6,500	*2900 *6,500	5100 16'02"
6000 mm 20'0"	kg lb							*3600 *7,350	*3600 *7,350			*2650 *5,800	*2650 *5,800	6450 20'11"
4500 mm 15'0"	kg lb							*4000 *8,700	3700 8,000			*2550 *5,600	*2550 *5,600	7240 23'07"
3000 mm 10'0"	kg lb			*7900 *16,850	*7900 *16,850	*5450 *11,750	5450 11,750	*4550 *9,850	3550 7,650	*3300 *6,100	2550 5,400	*2650 *5,750	2450 5,400	7660 25'01"
1500 mm 5'0"	kg lb			*6900 *16,550	*6900 *16,550	*6850 *14,750	5100 10,950	*5200 *11,200	3400 7,300	3750 *7,850	2450 5,300	*2850 *6,200	2350 5,150	7780 25'05"
0 mm 0'0"	kg lb			*6900 *15,850	*6900 *15,850	*7750 *16,800	4850 10,400	5050 10,850	3250 7,050	3650 2400		*3200 *7,050	2350 5,200	7590 24'10"
-1500 mm -5'0"	kg lb	*5600 *12,500	*5600 *12,500	*9950 *22,650	8700 18,650	7700 16,550	4750 10,200	5000 10,750	3200 6,900			*3950 *8,700	2600 5,700	7080 23'02"
-3000 mm -10'0"	kg lb	*9200 *20,650	*9200 *20,650	*11 000 *23,800	8800 18,900	*7550 *16,250	4750 10,250	5050 10,850	3250 7,000			4850 10,750	3150 6,950	6160 20'01"
-4500 mm -15'0"	kg lb			*8450 *18,000	*8450 *18,000	*5650 *12,450	4950 10,900					*5450 *12,000	4800 10,950	4610 14'09"

Reach Boom Lift Capacities – Counterweight: 3.57 mt (7,870 lb) – without Bucket – Blade Up

2600 mm (8'6") Blade

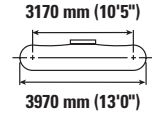
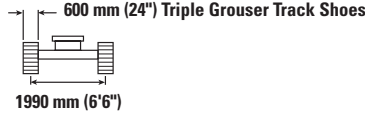
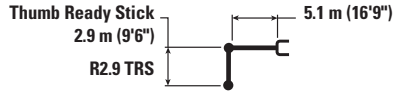

		1500 mm/5'0"		3000 mm/10'0"		4500 mm/15'0"		6000 mm/20'0"		7500 mm/25'0"		mm ft/in		
7500 mm 25'0"	kg lb											*2900 *6,500	*2900 *6,500	5100 16'02"
6000 mm 20'0"	kg lb							*3600 *7,350	*3600 *7,350			*2650 *5,800	*2650 *5,800	6450 20'11"
4500 mm 15'0"	kg lb							*4000 *8,700	3700 7,900			*2550 *5,600	*2550 *5,600	7240 23'07"
3000 mm 10'0"	kg lb			*7900 *16,850	*7900 *16,850	*5450 *11,750	5400 11,600	*4550 *9,850	3550 7,600	*3300 *6,100	2500 5,350	*2650 *5,750	2400 5,300	7660 25'01"
1500 mm 5'0"	kg lb			*6900 *16,550	*6900 *16,550	*6850 *14,750	5050 10,800	5150 11,050	3350 7,250	3700 *7,850	2450 5,200	*2850 *6,200	2300 5,050	7780 25'05"
0 mm 0'0"	kg lb			*6900 *15,850	*6900 *15,850	7750 16,600	4800 10,300	5000 10,750	3250 6,950	3600 2400		*3200 *7,050	2350 5,150	7590 24'10"
-1500 mm -5'0"	kg lb	*5600 *12,500	*5600 *12,500	*9950 *22,650	8600 18,400	7600 16,350	4700 10,050	4950 10,600	3150 6,800			3900 8,600	2550 5,600	7080 23'02"
-3000 mm -10'0"	kg lb	*9200 *20,650	*9200 *20,650	*11 000 *23,800	8700 18,650	*7550 *16,250	4700 10,150	4950 10,700	3200 6,900			4800 10,650	3100 6,850	6160 20'01"
-4500 mm -15'0"	kg lb			*8450 *18,000	*8450 *18,000	*5650 *12,450	4900 10,800					*5450 *12,000	4750 10,800	4610 14'09"



ISO 10567:2007



* Indicates that the load is limited by hydraulic lifting capacity rather than tipping load. The above loads are in compliance with hydraulic excavator lift capacity standard ISO 10567:2007. They do not exceed 87% of hydraulic lifting capacity or 75% of tipping load. Weight of all lifting accessories must be deducted from the above lifting capacities. Lifting capacities are based on the machine standing on a firm, uniform supporting surface. The use of a work tool attachment point to handle/lift objects, could affect the machine lift performance.

Lift capacity stays with ±5% for all available track shoes.

Always refer to the appropriate Operation and Maintenance Manual for specific product information.

317 GC Hydraulic Excavator Specifications

Reach Boom Lift Capacities – Counterweight: 3.57 mt (7,870 lb) – without Bucket – Blade Up

2600 mm (8'6") Blade

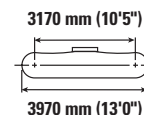
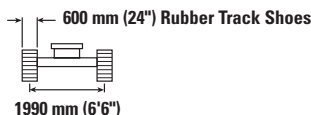

		1500 mm/5'0"		3000 mm/10'0"		4500 mm/15'0"		6000 mm/20'0"		7500 mm/25'0"		mm ft/in		
7500 mm 25'0"	kg lb											*2900 *6,500	*2900 *6,500	5100 16'02"
6000 mm 20'0"	kg lb							*3600 *7,350	*3600 *7,350			*2650 *5,800	*2650 *5,800	6450 20'11"
4500 mm 15'0"	kg lb							*4000 *8,700	3750 8,000			*2550 *5,600	*2550 *5,600	7240 23'07"
3000 mm 10'0"	kg lb			*7900 *16,850	*7900 *16,850	*5450 *11,750	*5450 *11,750	*4550 *9,850	3600 7,700	*3300 *6,100	2550 5,450	*2650 *5,750	2450 5,400	7660 25'01"
1500 mm 5'0"	kg lb			*6900 *16,550	*6900 *16,550	6850 *14,750	5100 11,000	*5200 *11,250	3400 7,350	3750 *7,850	2500 5,300	*2850 *6,200	2350 5,150	7780 25'05"
0 mm 0'0"	kg lb			*6900 *15,850	*6900 *15,850	*7750 *16,800	4850 10,450	5100 10,950	3300 7,050	3700	2400	*3200 *7,050	2400 5,250	7590 24'10"
-1500 mm -5'0"	kg lb	*5600 *12,500	*5600 *12,500	*9950 *22,650	8750 18,750	7750 16,650	4750 10,250	5050 10,800	3250 6,950			*3950 *8,700	2600 5,700	7080 23'02"
-3000 mm -10'0"	kg lb	*9200 *20,650	*9200 *20,650	*11,000 *23,800	8850 19,000	*7550 *16,250	4800 10,350	5050 10,900	3250 7,050			4900 10,850	3150 7,000	6160 20'01"
-4500 mm -15'0"	kg lb			*8450 *18,000	*8450 *18,000	*5650	5000					*5450 *12,000	4850 11,000	4610 14'09"

Reach Boom Lift Capacities – Counterweight: 3.57 mt (7,870 lb) – without Bucket – Blade Up

2700 mm (8'10") Blade

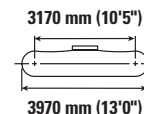
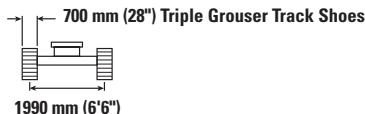
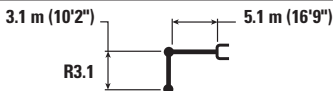

		1500 mm/5'0"		3000 mm/10'0"		4500 mm/15'0"		6000 mm/20'0"		7500 mm/25'0"		mm ft/in		
7500 mm 25'0"	kg lb											*2700 *6,050	*2700 *6,050	5380 17'02"
6000 mm 20'0"	kg lb							*3650 *7,550	*3650 *7,550			*2450 *5,400	*2450 *5,400	6670 21'07"
4500 mm 15'0"	kg lb							*3900 *8,500	3800 8,150			*2400 *5,250	*2400 *5,250	7440 24'03"
3000 mm 10'0"	kg lb			*7500 *15,950	*7500 *15,950	*5300 *11,450	*5300 *11,450	*4500 *9,700	3650 7,850	*3600 *7,100	2600 5,600	*2450 *5,400	2450 5,350	7850 25'08"
1500 mm 5'0"	kg lb			*8250 *19,750	*8250 *19,750	*6750 *14,550	5200 11,200	*5150 *11,200	3500 7,500	3800 8,150	2550 5,450	*2650 *5,800	2300 5,100	7960 26'01"
0 mm 0'0"	kg lb			*7150 *16,450	*7150 *16,450	*7750 *16,800	4950 10,650	5150 11,050	3350 7,200	3750 8,000	2450 5,300	*3000 *6,550	2350 5,150	7780 25'05"
-1500 mm -5'0"	kg lb	*5400 *12,050	*5400 *12,050	*9700 *22,100	8800 18,900	7800 16,750	4850 10,400	5050 10,900	3300 7,050			*3600 *7,950	2550 5,600	7280 23'10"
-3000 mm -10'0"	kg lb	*8700 *19,450	*8700 *19,450	*11,400 *24,650	8900 19,100	*7750 *16,700	4850 10,400	5100 10,900	3300 7,100			4650 10,300	3050 6,750	6400 20'10"
-4500 mm -15'0"	kg lb			*9100 *19,350	*9100 *19,350	*6150 *12,950	5000 10,750					*5450 *12,000	4450 10,050	4920 15'09"



ISO 10567:2007



* Indicates that the load is limited by hydraulic lifting capacity rather than tipping load. The above loads are in compliance with hydraulic excavator lift capacity standard ISO 10567:2007. They do not exceed 87% of hydraulic lifting capacity or 75% of tipping load. Weight of all lifting accessories must be deducted from the above lifting capacities. Lifting capacities are based on the machine standing on a firm, uniform supporting surface. The use of a work tool attachment point to handle/lift objects, could affect the machine lift performance.

Lift capacity stays with ±5% for all available track shoes.

Always refer to the appropriate Operation and Maintenance Manual for specific product information.

317 GC Hydraulic Excavator Specifications

Reach Boom Lift Capacities – Counterweight: 3.57 mt (7,870 lb) – without Bucket – Blade Up

2600 mm (8'6") Blade

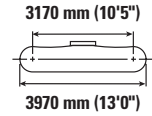
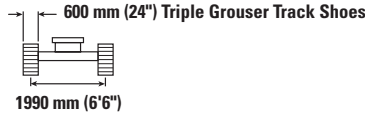
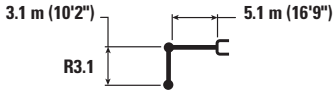

		1500 mm/5'0"		3000 mm/10'0"		4500 mm/15'0"		6000 mm/20'0"		7500 mm/25'0"		mm ft/in		
7500 mm 25'0"	kg lb											*2700 *6,050	*2700 *6,050	5380 17'02"
6000 mm 20'0"	kg lb							*3650 *7,550	*3650 *7,550			*2450 *5,400	*2450 *5,400	6670 21'07"
4500 mm 15'0"	kg lb							*3900 *8,500	3750 8,050			*2400 *5,250	*2400 *5,250	7440 24'03"
3000 mm 10'0"	kg lb			*7500 *15,950	*7500 *15,950	*5300 *11,450	*5300 *11,450	*4500 *9,700	3600 7,750	*3600 *7,100	2600 5,500	*2450 *5,400	2400 5,250	7850 25'08"
1500 mm 5'0"	kg lb			*8250 *19,750	*8250 *19,750	*6750 *14,550	5150 11,050	*5150 *11,200	3450 7,400	3750 8,050	2500 5,350	*2650 *5,800	2300 5,050	7960 26'01"
0 mm 0'0"	kg lb			*7150 *16,450	*7150 *16,450	*7750 *16,800	4900 10,500	5100 10,900	3300 7,100	3700 7,900	2450 5,250	*3000 *6,550	2300 5,100	7780 25'05"
-1500 mm -5'0"	kg lb	*5400 *12,050	*5400 *12,050	*9700 *22,100	8700 18,650	7700 16,550	4750 10,250	5000 10,750	3250 6,950			*3600 *7,950	2500 5,550	7280 23'10"
-3000 mm -10'0"	kg lb	*8700 *19,450	*8700 *19,450	*11,400 *24,650	8800 18,850	7700 16,550	4800 10,300	5000 10,800	3250 7,000			4600 10,200	3000 6,650	6400 20'10"
-4500 mm -15'0"	kg lb			*9100 *19,350	9050 *19,350	*6150 12,950	4950 10,650					*5450 *12,000	4400 9,900	4920 15'09"

Reach Boom Lift Capacities – Counterweight: 3.57 mt (7,870 lb) – without Bucket – Blade Up

2600 mm (8'6") Blade

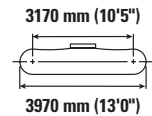
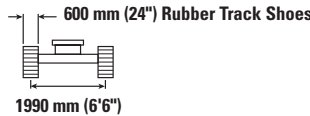

		1500 mm/5'0"		3000 mm/10'0"		4500 mm/15'0"		6000 mm/20'0"		7500 mm/25'0"		mm ft/in		
7500 mm 25'0"	kg lb											*2700 *6,050	*2700 *6,050	5380 17'02"
6000 mm 20'0"	kg lb							*3650 *7,550	*3650 *7,550			*2450 *5,400	*2450 *5,400	6670 21'07"
4500 mm 15'0"	kg lb							*3900 *8,500	3800 8,200			*2400 *5,250	*2400 *5,250	7440 24'03"
3000 mm 10'0"	kg lb			*7500 *15,950	*7500 *15,950	*5300 *11,450	*5300 *11,450	*4500 *9,700	3650 7,900	*3600 *7,100	2650 5,600	*2450 *5,400	2450 5,350	7850 25'08"
1500 mm 5'0"	kg lb			*8250 *19,750	*8250 *19,750	*6750 *14,550	5250 11,250	*5150 *11,200	3500 7,550	3850 8,200	2550 5,450	*2650 *5,800	2350 5,100	7960 26'01"
0 mm 0'0"	kg lb			*7150 *16,450	*7150 *16,450	*7750 *16,800	4950 10,700	5200 11,150	3350 7,250	3750 8,050	2500 5,350	*3000 *6,550	2350 5,200	7780 25'05"
-1500 mm -5'0"	kg lb	*5400 *12,050	*5400 *12,050	*9700 *22,100	8850 19,000	7850 16,850	4850 10,450	5100 10,950	3300 7,100			*3600 *7,950	2550 5,650	7280 23'10"
-3000 mm -10'0"	kg lb	*8700 *19,450	*8700 *19,450	*11,400 *24,650	8950 19,200	*7750 *16,700	4850 10,500	5100 11,000	3300 7,150			4700 10,400	3050 6,750	6400 20'10"
-4500 mm -15'0"	kg lb			*9100 *19,350	*9100 *19,350	*6150 *12,950	5000 10,850					*5450 *12,000	4450 10,100	4920 15'09"



ISO 10567:2007



* Indicates that the load is limited by hydraulic lifting capacity rather than tipping load. The above loads are in compliance with hydraulic excavator lift capacity standard ISO 10567:2007. They do not exceed 87% of hydraulic lifting capacity or 75% of tipping load. Weight of all lifting accessories must be deducted from the above lifting capacities. Lifting capacities are based on the machine standing on a firm, uniform supporting surface. The use of a work tool attachment point to handle/lift objects, could affect the machine lift performance.

Lift capacity stays with ±5% for all available track shoes.

Always refer to the appropriate Operation and Maintenance Manual for specific product information.

317 GC Hydraulic Excavator Specifications

Reach Boom Lift Capacities – Counterweight: 3.05 mt (6,720 lb) – without Bucket

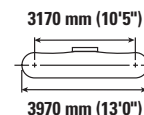
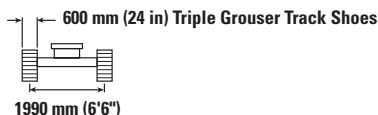

		1500 mm/5'0"		3000 mm/10'0"		4500 mm/15'0"		6000 mm/20'0"		7500 mm/25'0"		mm ft/in		
7500 mm 25'0"	kg lb					*7,700	*7,700					*3350 *7,450	*3350 *7,450	4770 15'1"
6000 mm 20'0"	kg lb							*3600 *6,650	3350 6,650			*2950 *6,450	*2950 *6,450	6190 20'0"
4500 mm 15'0"	kg lb					*4650 *10,050	*4650 *10,050	*4300 *9,450	3300 7,100			*2850 *6,200	2550 5,700	7020 22'10"
3000 mm 10'0"	kg lb			*8900 *18,900	8850 *18,900	*5900 *12,700	4850 10,450	*4850 *10,500	3200 6,850			*2900 *6,300	2300 5,050	7450 24'4"
1500 mm 5'0"	kg lb					*7250 *15,600	4500 9,700	4900 10,550	3050 6,500	*3500	2200	*3050 *6,750	2200 4,800	7560 24'9"
0 mm 0'0"	kg lb			*6200 *14,200	*6200 *14,200	7350 15,800	4300 9,250	4800 10,300	2900 6,300			*3450 *7,600	2200 4,850	7370 24'2"
-1500 mm -5'0"	kg lb	*5650 *12,650	*5650 *12,650	*10 050 *22,950	7750 16,650	7300 15,650	4250 9,100	4750 10,150	2900 6,200			3950 8,700	2450 5,350	6850 22'4"
-3000 mm -10'0"	kg lb	*9900 *22,300	*9900 *22,300	*10 750 *23,250	7900 16,950	7350 15,750	4300 9,200					4900 10,950	3000 6,650	5900 19'2"
-4500 mm -15'0"	kg lb			*7750 *16,400	*7750 *16,400							*5450 *11,900	4900 11,250	4240 13'6"

Reach Boom Lift Capacities – Counterweight: 3.05 mt (6,720 lb) – without Bucket

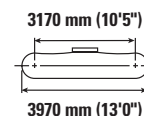
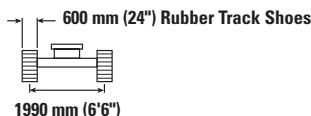

		1500 mm/5'0"		3000 mm/10'0"		4500 mm/15'0"		6000 mm/20'0"		7500 mm/25'0"		mm ft/in		
7500 mm 25'0"	kg lb					*7,700	*7,700					*3350 *7,450	*3350 *7,450	4770 15'1"
6000 mm 20'0"	kg lb							*3600 *6,650	3400 *6,650			*2950 *6,450	*2950 *6,450	6190 20'0"
4500 mm 15'0"	kg lb					*4650 *10,050	*4650 *10,050	*4300 *9,450	3400 7,250			*2850 *6,200	2600 5,800	7020 22'10"
3000 mm 10'0"	kg lb			*8900 *18,900	*8900 *18,900	*5900 *12,700	4950 10,600	*4850 *10,500	3250 6,950			*2900 *6,300	2350 5,150	7450 24'4"
1500 mm 5'0"	kg lb					*7250 *15,600	4600 9,900	5000 10,750	3100 6,650	*3500	2250	*3050 *6,750	2250 4,900	7560 24'9"
0 mm 0'0"	kg lb			*6200 *14,200	*6200 *14,200	7500 16,150	4400 9,450	4900 10,500	3000 6,400			*3450 *7,600	2250 4,950	7370 24'2"
-1500 mm -5'0"	kg lb	*5650 *12,650	*5650 *12,650	*10 050 *22,950	7900 17,000	7450 15,950	4350 9,300	4850 10,400	2950 6,300			4050 8,900	2500 5,450	6850 22'4"
-3000 mm -10'0"	kg lb	*9900 *22,300	*9900 *22,300	*10 750 *23,250	8050 17,250	*7450 *16,050	4350 9,400					5000 11,150	3050 6,800	5900 19'2"
-4500 mm -15'0"	kg lb			*7750 *16,400	*7750 *16,400							*5450 *11,900	5000 11,450	4240 13'6"



ISO 10567:2007



* Indicates that the load is limited by hydraulic lifting capacity rather than tipping load. The above loads are in compliance with hydraulic excavator lift capacity standard ISO 10567:2007. They do not exceed 87% of hydraulic lifting capacity or 75% of tipping load. Weight of all lifting accessories must be deducted from the above lifting capacities. Lifting capacities are based on the machine standing on a firm, uniform supporting surface. The use of a work tool attachment point to handle/lift objects, could affect the machine lift performance.

Lift capacity stays with ±5% for all available track shoes.

Always refer to the appropriate Operation and Maintenance Manual for specific product information.

317 GC Hydraulic Excavator Specifications

Reach Boom Lift Capacities – Counterweight: 3.05 mt (6,720 lb) – without Bucket

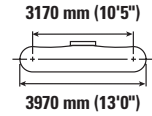
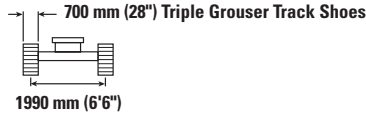
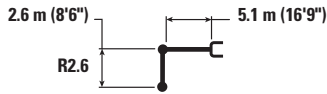

		1500 mm/5'0"		3000 mm/10'0"		4500 mm/15'0"		6000 mm/20'0"		7500 mm/25'0"		mm ft/in		
7500 mm 25'0"	kg lb					*7,700	*7,700					*3350 *7,450	*3350 *7,450	4770 15'1"
6000 mm 20'0"	kg lb							*3600 *6,650	3400 *6,650			*2950 *6,450	*2950 *6,450	6190 20'0"
4500 mm 15'0"	kg lb					*4650 *10,050	*4650 *10,050	*4300 *9,450	3350 7,200			*2850 *6,200	2600 5,750	7020 22'10"
3000 mm 10'0"	kg lb			*8900 *18,900	*8900 *18,900	*5900 *12,700	4900 10,550	*4850 *10,500	3250 6,950			*2900 *6,300	2300 5,100	7450 24'4"
1500 mm 5'0"	kg lb					*7250 *15,600	4550 9,850	4950 10,700	3100 6,600	*3500	2250	*3050 *6,750	2200 4,850	7560 24'9"
0 mm 0'0"	kg lb			*6200 *14,200	*6200 *14,200	7450 16,000	4350 9,400	4850 10,400	2950 6,350			*3450 *7,600	2250 4,950	7370 24'2"
-1500 mm -5'0"	kg lb	*5650 *12,650	*5650 *12,650	*10 050 *22,950	7850 16,850	7400 15,850	4300 9,250	4800 10,300	2900 6,250			4000 8,800	2450 5,400	6850 22'4"
-3000 mm -10'0"	kg lb	*9900 *22,300	*9900 *22,300	*10 750 *23,250	8000 17,150	7450 15,950	4350 9,350					5000 11,100	3050 6,750	5900 19'2"
-4500 mm -15'0"	kg lb			*7750 *16,400								*5450 *11,900	4950 11,350	4240 13'6"

Reach Boom Lift Capacities – Counterweight: 3.05 mt (6,720 lb) – without Bucket

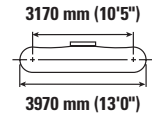
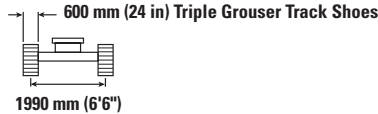
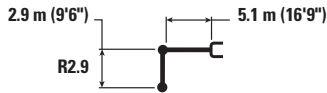

		1500 mm/5'0"		3000 mm/10'0"		4500 mm/15'0"		6000 mm/20'0"		7500 mm/25'0"		mm ft/in		
7500 mm 25'0"	kg lb											*2950 *6,600	*2950 *6,600	5100 16'2"
6000 mm 20'0"	kg lb							*3650 *7,450	3400 7,250			*2650 *5,900	*2650 *5,900	6450 20'11"
4500 mm 15'0"	kg lb							*4050 *8,850	3350 7,150			*2600 *5,700	2450 5,400	7240 23'7"
3000 mm 10'0"	kg lb			*8000 *17,050	*8000 *17,050	*5550 *11,950	4900 10,500	*4600 *10,000	3200 6,850	*3350 *6,200	2250 4,800	*2700 *5,850	2200 4,800	7660 25'1"
1500 mm 5'0"	kg lb			*6950 *16,650	*6950 *16,650	*6950 *14,950	4500 9,750	4900 10,550	3000 6,500	3500 7,550	2200 4,700	*2900 *6,300	2050 4,550	7780 25'5"
0 mm 0'0"	kg lb			*6950 *15,950	*6950 *15,950	7350 15,750	4300 9,200	4750 10,200	2900 6,200	3450	2150	*3250 *7,150	2100 4,600	7590 24'10"
-1500 mm -5'0"	kg lb	*5650 *12,550	*5650 *12,550	*10 000 *22,750	7650 16,450	7250 15,500	4200 9,000	4700 10,100	2850 6,100			3750 8,200	2300 5,000	7080 23'2"
-3000 mm -10'0"	kg lb	*9250 *20,750	*9250 *20,750	*11 150 *24,050	7750 16,700	7250 15,600	4200 9,050	4700 10,150	2850 6,150			4550 10,100	2750 6,150	6160 20'1"
-4500 mm -15'0"	kg lb			*8550 *18,200	8050 17,300	*5750	4400					*5550 *12,200	4250 9,700	4610 14'9"



ISO 10567:2007



* Indicates that the load is limited by hydraulic lifting capacity rather than tipping load. The above loads are in compliance with hydraulic excavator lift capacity standard ISO 10567:2007. They do not exceed 87% of hydraulic lifting capacity or 75% of tipping load. Weight of all lifting accessories must be deducted from the above lifting capacities. Lifting capacities are based on the machine standing on a firm, uniform supporting surface. The use of a work tool attachment point to handle/lift objects, could affect the machine lift performance.

Lift capacity stays with ±5% for all available track shoes.

Always refer to the appropriate Operation and Maintenance Manual for specific product information.

317 GC Hydraulic Excavator Specifications

Reach Boom Lift Capacities – Counterweight: 3.05 mt (6,720 lb) – without Bucket

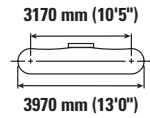
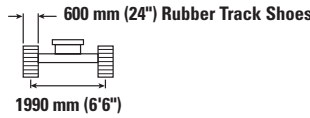
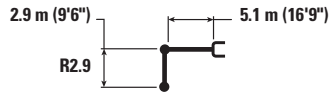

		1500 mm/5'0"		3000 mm/10'0"		4500 mm/15'0"		6000 mm/20'0"		7500 mm/25'0"		mm ft/in		
7500 mm 25'0"	kg lb											*2950 *6,600	*2950 *6,600	5100 16'2"
6000 mm 20'0"	kg lb							*3650 *7,450	3450 7,400			*2650 *5,900	*2650 *5,900	6450 20'11"
4500 mm 15'0"	kg lb							*4050 *8,850	3400 7,250			*2600 *5,700	2500 5,500	7240 23'7"
3000 mm 10'0"	kg lb			*8000 *17,050	*8000 *17,050	*5550 *11,950	4950 10,700	*4600 *10,000	3250 6,950	*3350 *6,200	2300 4,900	*2700 *5,850	2200 4,900	7660 25'1"
1500 mm 5'0"	kg lb			*6950 *16,650	*6950 *16,650	*6950 *14,950	4600 9,900	5000 10,750	3100 6,650	3600 7,700	2250 4,800	*2900 *6,300	2100 4,650	7780 25'5"
0 mm 0'0"	kg lb			*6950 *15,950	*6950 *15,950	7500 16,100	4350 9,400	4850 10,450	2950 6,350	3550 2200		*3250 *7,150	2150 4,700	7590 24'10"
-1500 mm -5'0"	kg lb	*5650 *12,550	*5650 *12,550	*10 000 *22,750	7800 16,750	7400 15,850	4250 9,200	4800 10,300	2900 6,200			3800 8,400	2350 5,150	7080 23'2"
-3000 mm -10'0"	kg lb	*9250 *20,750	*9250 *20,750	*11 150 *24,050	7950 17,000	7400 15,900	4300 9,250	4800 10,400	2950 6,300			4650 10,300	2850 6,250	6160 20'1"
-4500 mm -15'0"	kg lb			*8550 *18,200	8200 17,650	*5750	4500					*5550 *12,200	4350 9,900	4610 14'9"

Reach Boom Lift Capacities – Counterweight: 3.05 mt (6,720 lb) – without Bucket

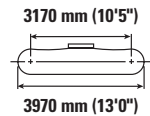
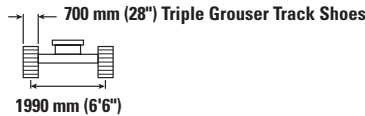

		1500 mm/5'0"		3000 mm/10'0"		4500 mm/15'0"		6000 mm/20'0"		7500 mm/25'0"		mm ft/in		
7500 mm 25'0"	kg lb											*2950 *6,600	*2950 *6,600	5100 16'2"
6000 mm 20'0"	kg lb							*3650 *7,450	3450 7,350			*2650 *5,900	*2650 *5,900	6450 20'11"
4500 mm 15'0"	kg lb							*4050 *8,850	3350 7,200			*2600 *5,700	2450 5,450	7240 23'7"
3000 mm 10'0"	kg lb			*8000 *17,050	*8000 *17,050	*5550 *11,950	4950 10,600	*4600 *10,000	3250 6,950	*3350 *6,200	2300 4,900	*2700 *5,850	2200 4,850	7660 25'1"
1500 mm 5'0"	kg lb			*6950 *16,650	*6950 *16,650	*6950 *14,950	4600 9,850	4950 10,650	3050 6,600	3550 7,650	2200 4,750	*2900 *6,300	2100 4,600	7780 25'5"
0 mm 0'0"	kg lb			*6950 *15,950	*6950 *15,950	7450 16,000	4350 9,350	4800 10,350	2950 6,300	3500	2150	*3250 *7,150	2150 4,650	7590 24'10"
-1500 mm -5'0"	kg lb	*5650 *12,550	*5650 *12,550	*10 000 *22,750	7750 16,650	7350 15,750	4250 9,100	4750 10,200	2850 6,150			3800 8,300	2300 5,100	7080 23'2"
-3000 mm -10'0"	kg lb	*9250 *20,750	*9250 *20,750	*11 150 *24,050	7850 16,900	7350 15,800	4250 9,200	4800 10,300	2900 6,250			4600 10,250	2800 6,200	6160 20'1"
-4500 mm -15'0"	kg lb			*8550 *18,200	8150 17,500	*5750	4450					*5550 *12,200	4300 9,800	4610 14'9"



ISO 10567:2007



* Indicates that the load is limited by hydraulic lifting capacity rather than tipping load. The above loads are in compliance with hydraulic excavator lift capacity standard ISO 10567:2007. They do not exceed 87% of hydraulic lifting capacity or 75% of tipping load. Weight of all lifting accessories must be deducted from the above lifting capacities. Lifting capacities are based on the machine standing on a firm, uniform supporting surface. The use of a work tool attachment point to handle/lift objects, could affect the machine lift performance.

Lift capacity stays with ±5% for all available track shoes.

Always refer to the appropriate Operation and Maintenance Manual for specific product information.

317 GC Hydraulic Excavator Specifications

Reach Boom Lift Capacities – Counterweight: 3.05 mt (6,720 lb) – without Bucket

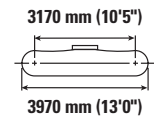
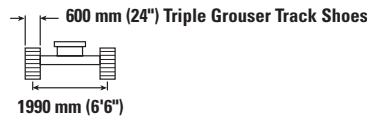
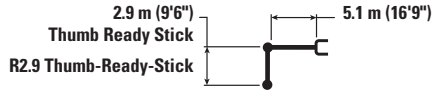

Reach Boom Lift Configuration	1500 mm/5'0"		3000 mm/10'0"		4500 mm/15'0"		6000 mm/20'0"		7500 mm/25'0"		mm ft/in		
	kg lb	kg lb	kg lb	kg lb	kg lb	kg lb	kg lb	kg lb	kg lb	kg lb	kg lb	mm ft/in	
7500 mm 25'0"											*2900 *6,500	*2900 *6,500	5100 16'2"
6000 mm 20'0"							*3600 *7,350	3350 7,150			*2650 *5,800	*2650 *5,800	6450 20'11"
4500 mm 15'0"							*4000 *8,700	3250 7,000			*2550 *5,600	2400 5,250	7240 23'7"
3000 mm 10'0"			*7900 *16,850	*7900 *16,850	*5450 *11,750	4800 10,350	*4550 *9,850	3150 6,700	*3300 *6,100	2200 4,700	*2650 *5,750	2100 4,650	7660 25'1"
1500 mm 5'0"			*6900 *16,550	*6900 *16,550	*6850 *14,750	4450 9,550	4850 10,400	2950 6,350	3450 7,400	2100 4,550	*2850 *6,200	2000 4,400	7780 25'5"
0 mm 0'0"			*6900 *15,850	*6900 *15,850	7250 15,600	4200 9,000	4700 10,050	2850 6,050	3400	2050	*3200 *7,050	2050 4,450	7590 24'10"
-1500 mm -5'0"	*5600 *12,500	*5600 *12,500	*9950 *22,650	7550 16,150	7150 15,350	4100 8,800	4600 9,900	2750 5,950			3650 8,050	2200 4,900	7080 23'2"
-3000 mm -10'0"	*9200 *20,650	*9200 *20,650	*11 000 *23,800	7650 16,450	7200 15,400	4150 8,900	4650 10,050	2800 6,050			4500 9,950	2700 6,000	6160 20'1"
-4500 mm -15'0"			*8450 *18,000	7950 17,100	*5650	4300					*5450 *12,000	4200 9,550	4610 14'9"

Reach Boom Lift Capacities – Counterweight: 3.05 mt (6,720 lb) – without Bucket

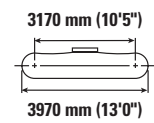
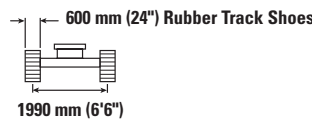
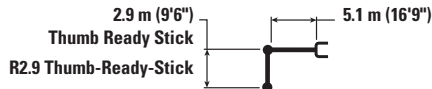

Reach Boom Lift Configuration	1500 mm/5'0"		3000 mm/10'0"		4500 mm/15'0"		6000 mm/20'0"		7500 mm/25'0"		mm ft/in		
	kg lb	kg lb	kg lb	kg lb	kg lb	kg lb	kg lb	kg lb	kg lb	kg lb	kg lb	mm ft/in	
7500 mm 25'0"											*2900 *6,500	*2900 *6,500	5100 16'2"
6000 mm 20'0"							*3600 *7,350	3400 7,250			*2650 *5,800	*2650 *5,800	6450 20'11"
4500 mm 15'0"							*4000 *8,700	3350 7,150			*2550 *5,600	2450 5,350	7240 23'7"
3000 mm 10'0"			*7900 *16,850	*7900 *16,850	*5450 *11,750	4900 10,550	*4550 *9,850	3200 6,850	*3300 *6,100	2250 4,800	*2650 *5,750	2150 4,750	7660 25'1"
1500 mm 5'0"			*6900 *16,550	*6900 *16,550	*6850 *14,750	4550 9,750	4950 10,600	3000 6,500	3550 7,550	2150 4,650	*2850 *6,200	2050 4,500	7780 25'5"
0 mm 0'0"			*6900 *15,850	*6900 *15,850	7400 15,900	4300 9,200	4800 10,300	2900 6,200	3450	2100	*3200 *7,050	2100 4,550	7590 24'10"
-1500 mm -5'0"	*5600 *12,500	*5600 *12,500	*9950 *22,650	7700 16,500	7300 15,650	4200 9,000	4700 10,150	2800 6,050			3750 8,250	2250 5,000	7080 23'2"
-3000 mm -10'0"	*9200 *20,650	*9200 *20,650	*11 000 *23,800	7800 16,750	7350 15,750	4200 9,050	4750 10,250	2850 6,150			4600 10,200	2750 6,100	6160 20'1"
-4500 mm -15'0"			*8450 *18,000	8100 17,450	*5650	4400					*5450 *12,000	4300 9,750	4610 14'9"



ISO 10567:2007



* Indicates that the load is limited by hydraulic lifting capacity rather than tipping load. The above loads are in compliance with hydraulic excavator lift capacity standard ISO 10567:2007. They do not exceed 87% of hydraulic lifting capacity or 75% of tipping load. Weight of all lifting accessories must be deducted from the above lifting capacities. Lifting capacities are based on the machine standing on a firm, uniform supporting surface. The use of a work tool attachment point to handle/lift objects, could affect the machine lift performance.

Lift capacity stays with ±5% for all available track shoes.

Always refer to the appropriate Operation and Maintenance Manual for specific product information.

317 GC Hydraulic Excavator Specifications

Reach Boom Lift Capacities – Counterweight: 3.05 mt (6,720 lb) – without Bucket

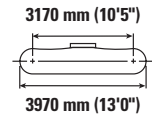
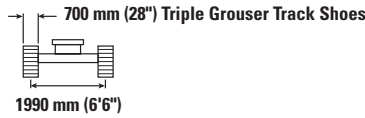
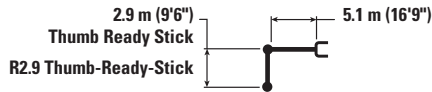

Reach Boom	1500 mm/5'0"		3000 mm/10'0"		4500 mm/15'0"		6000 mm/20'0"		7500 mm/25'0"		mm ft/in		
	kg lb	kg lb	kg lb	kg lb	kg lb	kg lb	kg lb	kg lb	kg lb	kg lb	kg lb	mm ft/in	
7500 mm 25'0"											*2900 *6,500	*2900 *6,500	5100 16'2"
6000 mm 20'0"							*3600 *7,350	3400 7,200			*2650 *5,800	*2650 *5,800	6450 20'11"
4500 mm 15'0"							*4000 *8,700	3300 7,100			*2550 *5,600	2400 5,350	7240 23'7"
3000 mm 10'0"			*7900 *16,850	*7900 *16,850	*5450 *11,750	4850 10,500	*4550 *9,850	3150 6,800	*3300 *6,100	2200 4,750	*2650 *5,750	2150 4,700	7660 25'1"
1500 mm 5'0"			*6900 *16,550	*6900 *16,550	*6850 *14,750	4500 9,700	4900 10,550	3000 6,450	3500 7,500	2150 4,600	*2850 *6,200	2050 4,450	7780 25'5"
0 mm 0'0"			*6900 *15,850	*6900 *15,850	7350 15,800	4250 9,150	4750 10,200	2850 6,150	3450	2100	*3200 *7,050	2050 4,500	7590 24'10"
-1500 mm -5'0"	*5600 *12,500	*5600 *12,500	*9950 *22,650	7650 16,400	7250 15,550	4150 8,950	4700 10,050	2800 6,000			3700 8,200	2250 4,950	7080 23'2"
-3000 mm -10'0"	*9200 *20,650	*9200 *20,650	*11,000 *23,800	7750 16,650	7300 15,600	4200 9,000	4700 10,150	2850 6,100			4550 10,100	2750 6,100	6160 20'1"
-4500 mm -15'0"			*8450 *18,000	8050 17,300	*5650	4400					*5450 *12,000	4250 9,650	4610 14'9"

Reach Boom Lift Capacities – Counterweight: 3.05 mt (6,720 lb) – without Bucket

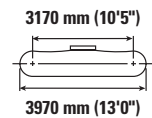
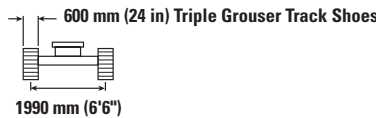

Reach Boom	1500 mm/5'0"		3000 mm/10'0"		4500 mm/15'0"		6000 mm/20'0"		7500 mm/25'0"		mm ft/in		
	kg lb	kg lb	kg lb	kg lb	kg lb	kg lb	kg lb	kg lb	kg lb	kg lb	kg lb	mm ft/in	
7500 mm 25'0"											*2700 *6,050	*2700 *6,050	5380 17'2"
6000 mm 20'0"							*3650 *7,550	3400 7,300			*2450 *5,400	*2450 *5,400	6670 21'7"
4500 mm 15'0"							*3900 *8,500	3350 7,200			*2400 *5,250	2350 5,200	7440 24'3"
3000 mm 10'0"			*7500 *15,950	*7500 *15,950	*5300 *11,450	4900 10,600	*4500 *9,700	3200 6,900	*3600 *7,100	2250 4,850	*2450 *5,400	2100 4,600	7850 25'8"
1500 mm 5'0"			*8250 *19,750	8150 17,550	*6750 *14,550	4550 9,800	4900 10,550	3050 6,550	3500 7,550	2200 4,700	*2650 *5,800	2000 4,400	7960 26'1"
0 mm 0'0"			*7150 *16,450	*7150 *16,450	7350 15,800	4300 9,250	4750 10,250	2900 6,250	3450 7,400	2150 4,550	*3000 *6,550	2050 4,450	7780 25'5"
-1500 mm -5'0"	*5400 *12,050	*5400 *12,050	*9700 *22,100	7650 16,450	7250 15,550	4200 9,000	4700 10,050	2850 6,100			3600 7,850	2200 4,800	7280 23'10"
-3000 mm -10'0"	*8700 *19,450	*8700 *19,450	*11,400 *24,650	7750 16,600	7250 15,550	4200 9,050	4700 10,100	2850 6,150			4300 9,550	2650 5,800	6400 20'10"
-4500 mm -15'0"			*9100 *19,350	8000 17,200	*6150 *12,950	4350 9,400					*5450 *12,000	3850 8,750	4920 15'9"



ISO 10567:2007



* Indicates that the load is limited by hydraulic lifting capacity rather than tipping load. The above loads are in compliance with hydraulic excavator lift capacity standard ISO 10567:2007. They do not exceed 87% of hydraulic lifting capacity or 75% of tipping load. Weight of all lifting accessories must be deducted from the above lifting capacities. Lifting capacities are based on the machine standing on a firm, uniform supporting surface. The use of a work tool attachment point to handle/lift objects, could affect the machine lift performance.

Lift capacity stays with ±5% for all available track shoes.

Always refer to the appropriate Operation and Maintenance Manual for specific product information.

317 GC Hydraulic Excavator Specifications

Reach Boom Lift Capacities – Counterweight: 3.05 mt (6,720 lb) – without Bucket

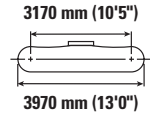
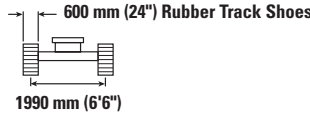
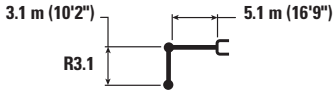

		1500 mm/5'0"		3000 mm/10'0"		4500 mm/15'0"		6000 mm/20'0"		7500 mm/25'0"		mm ft/in		
7500 mm 25'0"	kg lb											*2700 *6,050	*2700 *6,050	5380 17'2"
6000 mm 20'0"	kg lb							*3650 *7,550	3500 7,450			*2450 *5,400	*2450 *5,400	6670 21'7"
4500 mm 15'0"	kg lb							*3900 *8,500	3400 7,300			*2400 *5,250	2400 *5,250	7440 24'3"
3000 mm 10'0"	kg lb			*7500 *15,950	*7500 *15,950	*5300 *11,450	5000 10,800	*4500 *9,700	3250 7,000	*3600 *7,100	2300 4,950	*2450 *5,400	2150 4,700	7850 25'8"
1500 mm 5'0"	kg lb			*8250 *19,750	*8250 *17,900	*6750 *14,550	4650 10,000	5000 10,800	3100 6,650	3600 7,700	2250 4,800	*2650 *5,800	2050 4,500	7960 26'1"
0 mm 0'0"	kg lb			*7150 *16,450	*7150 *16,450	7500 16,150	4400 9,450	4850 10,450	2950 6,350	3550 7,600	2200 4,650	*3000 *6,550	2050 4,550	7780 25'5"
-1500 mm -5'0"	kg lb	*5400 *12,050	*5400 *12,050	*9700 *22,100	7800 16,750	7400 15,850	4300 9,200	4800 10,300	2900 6,200			*3600 *7,950	2250 4,950	7280 23'10"
-3000 mm -10'0"	kg lb	*8700 *19,450	*8700 *19,450	*11,400 *24,650	7900 16,950	7400 15,900	4300 9,200	4800 10,350	2900 6,250			4400 9,750	2700 5,950	6400 20'10"
-4500 mm -15'0"	kg lb			*9100 *19,350	8150 17,500	*6150 *12,950	4450 9,550					*5450 *12,000	3950 8,900	4920 15'9"

Reach Boom Lift Capacities – Counterweight: 3.05 mt (6,720 lb) – without Bucket

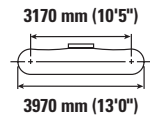
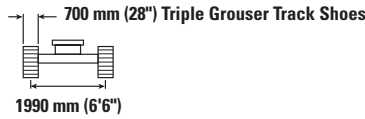

		1500 mm/5'0"		3000 mm/10'0"		4500 mm/15'0"		6000 mm/20'0"		7500 mm/25'0"		mm ft/in		
7500 mm 25'0"	kg lb											*2700 *6,050	*2700 *6,050	5380 17'2"
6000 mm 20'0"	kg lb							*3650 *7,550	3450 7,400			*2450 *5,400	*2450 *5,400	6670 21'7"
4500 mm 15'0"	kg lb							*3900 *8,500	3400 7,250			*2400 *5,250	2400 5,250	7440 24'3"
3000 mm 10'0"	kg lb			*7500 *15,950	*7500 *15,950	*5300 *11,450	5000 10,700	*4500 *9,700	3250 6,950	*3600 *7,100	2300 4,900	*2450 *5,400	2150 4,700	7850 25'8"
1500 mm 5'0"	kg lb			*8250 *19,750	*8250 *17,800	*6750 *14,550	4600 9,950	5000 10,700	3100 6,600	3550 7,650	2200 4,750	*2650 *5,800	2050 4,450	7960 26'1"
0 mm 0'0"	kg lb			*7150 *16,450	*7150 *16,450	7450 16,050	4350 9,350	4850 10,400	2950 6,300	3500 7,500	2150 4,650	*3000 *6,550	2050 4,500	7780 25'5"
-1500 mm -5'0"	kg lb	*5400 *12,050	*5400 *12,050	*9700 *22,100	7750 16,650	7350 15,750	4250 9,150	4750 10,200	2850 6,150			*3600 *7,950	2250 4,900	7280 23'10"
-3000 mm -10'0"	kg lb	*8700 *19,450	*8700 *19,450	*11,400 *24,650	7850 16,850	7350 15,750	4250 9,150	4750 10,250	2900 6,200			4350 9,700	2650 5,900	6400 20'10"
-4500 mm -15'0"	kg lb			*9100 *19,350	8100 17,400	*6150 *12,950	4400 9,500					*5450 *12,000	3900 8,850	4920 15'9"



ISO 10567:2007



* Indicates that the load is limited by hydraulic lifting capacity rather than tipping load. The above loads are in compliance with hydraulic excavator lift capacity standard ISO 10567:2007. They do not exceed 87% of hydraulic lifting capacity or 75% of tipping load. Weight of all lifting accessories must be deducted from the above lifting capacities. Lifting capacities are based on the machine standing on a firm, uniform supporting surface. The use of a work tool attachment point to handle/lift objects, could affect the machine lift performance.

Lift capacity stays with ±5% for all available track shoes.

Always refer to the appropriate Operation and Maintenance Manual for specific product information.

317 GC Hydraulic Excavator Specifications

Reach Boom Lift Capacities – Counterweight: 3.57 mt (7,870 lb) – without Bucket

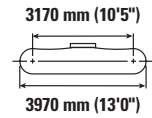
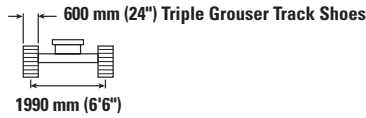
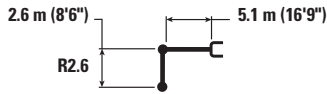

Reach Boom Lift Configuration	1500 mm/5'0"		3000 mm/10'0"		4500 mm/15'0"		6000 mm/20'0"		7500 mm/25'0"		mm ft/in		
	kg lb	kg lb	kg lb	kg lb	kg lb	kg lb	kg lb	kg lb	kg lb	kg lb	kg lb	mm ft/in	
7500 mm 25'0"					*7,700	*7,700					*3350 *7,450	*3350 *7,450	4770 15'1"
6000 mm 20'0"							*3600 *6,650	*3600 *6,650			*2950 *6,450	*2950 *6,450	6190 20'0"
4500 mm 15'0"					*4650 *10,050	*4650 *10,050	*4300 *9,450	3600 7,700			*2850 *6,200	2800 6,150	7020 22'10"
3000 mm 10'0"			*8900 *18,900	*8900 *18,900	*5900 *12,700	5200 11,250	*4850 *10,500	3450 7,400			*2900 *6,300	2500 5,450	7450 24'4"
1500 mm 5'0"					*7250 *15,600	4900 10,500	5250 11,250	3300 7,100	*3500 2400		*3050 *6,750	2400 5,200	7560 24'9"
0 mm 0'0"			*6200 *14,200	*6200 *14,200	7900 16,900	4700 10,050	5100 11,000	3200 6,850			*3450 *7,600	2400 5,300	7370 24'2"
-1500 mm -5'0"	*5650 *12,650	*5650 *12,650	*10 050 *22,950	8450 18,100	7800 16,750	4600 9,900	5050 10,900	3150 6,750			*4200 *9,300	2650 5,850	6850 22'4"
-3000 mm -10'0"	*9900 *22,300	*9900 *22,300	*10 750 *23,250	8550 18,350	*7450 *16,050	4650 10,050					5250 11,700	3250 7,250	5900 19'2"
-4500 mm -15'0"			*7750 *16,400	*7750 *16,400							*5450 *11,900	5300 *11,900	4240 13'6"

Reach Boom Lift Capacities – Counterweight: 3.57 mt (7,870 lb) – without Bucket

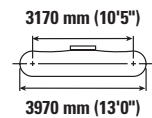
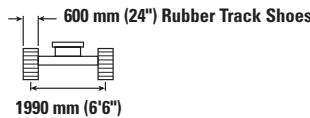

Reach Boom Lift Configuration	1500 mm/5'0"		3000 mm/10'0"		4500 mm/15'0"		6000 mm/20'0"		7500 mm/25'0"		mm ft/in		
	kg lb	kg lb	kg lb	kg lb	kg lb	kg lb	kg lb	kg lb	kg lb	kg lb	kg lb	mm ft/in	
7500 mm 25'0"					*7,700	*7,700					*3350 *7,450	*3350 *7,450	4770 15'1"
6000 mm 20'0"							*3600 *6,650	*3600 *6,650			*2950 *6,450	*2950 *6,450	6190 20'0"
4500 mm 15'0"					*4650 *10,050	*4650 *10,050	*4300 *9,450	3650 7,800			*2850 *6,200	*2850 *6,200	7020 22'10"
3000 mm 10'0"			*8900 *18,900	*8900 *18,900	*5900 *12,700	5300 11,450	*4850 *10,500	3500 7,550			*2900 *6,300	2550 5,600	7450 24'4"
1500 mm 5'0"					*7250 *15,600	4950 10,700	5350 11,500	3350 7,200	*3500 2450		*3050 *6,750	2400 5,300	7560 24'9"
0 mm 0'0"			*6200 *14,200	*6200 *14,200	8050 17,250	4750 10,250	5200 11,200	3250 7,000			*3450 *7,600	2450 5,400	7370 24'2"
-1500 mm -5'0"	*5650 *12,650	*5650 *12,650	*10 050 *22,950	8600 18,400	7950 17,050	4700 10,100	5150 11,100	3200 6,900			*4200 *9,300	2700 5,950	6850 22'4"
-3000 mm -10'0"	*9900 *22,300	*9900 *22,300	*10 750 *23,250	8700 18,700	*7450 *16,050	4750 10,200					5350 *11,800	3350 7,400	5900 19'2"
-4500 mm -15'0"			*7750 *16,400	*7750 *16,400							*5450 *11,900	5400 *11,900	4240 13'6"



ISO 10567:2007



* Indicates that the load is limited by hydraulic lifting capacity rather than tipping load. The above loads are in compliance with hydraulic excavator lift capacity standard ISO 10567:2007. They do not exceed 87% of hydraulic lifting capacity or 75% of tipping load. Weight of all lifting accessories must be deducted from the above lifting capacities. Lifting capacities are based on the machine standing on a firm, uniform supporting surface. The use of a work tool attachment point to handle/lift objects, could affect the machine lift performance.

Lift capacity stays with ±5% for all available track shoes.

Always refer to the appropriate Operation and Maintenance Manual for specific product information.

317 GC Hydraulic Excavator Specifications

Reach Boom Lift Capacities – Counterweight: 3.57 mt (7,870 lb) – without Bucket

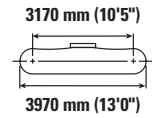
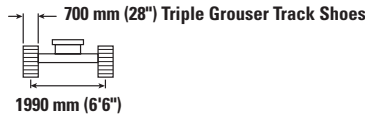
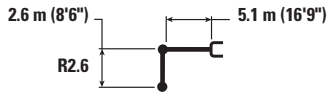

Reach	Unit	1500 mm/5'0"		3000 mm/10'0"		4500 mm/15'0"		6000 mm/20'0"		7500 mm/25'0"		mm ft/in		
		kg lb	kg lb	kg lb	kg lb	kg lb	kg lb	kg lb	kg lb	kg lb	kg lb	kg lb	mm ft/in	
7500 mm 25'0"	kg lb					*7,700 *7,700						*3350 *7,450	*3350 *7,450	4770 15'1"
6000 mm 20'0"	kg lb							*3600 *6,650	*3600 *6,650			*2950 *6,450	*2950 *6,450	6190 20'0"
4500 mm 15'0"	kg lb					*4650 *10,050	*4650 *10,050	*4300 *9,450	3600 7,750			*2850 *6,200	2800 *6,200	7020 22'10"
3000 mm 10'0"	kg lb			*8900 *18,900	*8900 *18,900	*5900 *12,700	5250 11,350	*4850 *10,500	3500 7,500			*2900 *6,300	2500 5,550	7450 24'4"
1500 mm 5'0"	kg lb					*7250 *15,600	4950 10,650	5300 11,400	3350 7,150	*3500 2450		*3050 *6,750	2400 5,300	7560 24'9"
0 mm 0'0"	kg lb			*6200 *14,200	*6200 *14,200	7950 17,100	4750 10,200	5200 11,150	3200 6,950			*3450 *7,600	2450 5,400	7370 24'2"
-1500 mm -5'0"	kg lb	*5650 *12,650	*5650 *12,650	*10 050 *22,950	8550 18,300	7900 16,950	4650 10,050	5150 11,050	3200 6,850			*4200 *9,300	2700 5,900	6850 22'4"
-3000 mm -10'0"	kg lb	*9900 *22,300	*9900 *22,300	*10 750 *23,250	8650 18,600	*7450 *16,050	4700 10,150					5350 *11,800	3300 7,350	5900 19'2"
-4500 mm -15'0"	kg lb			*7750 *16,400	*7750 *16,400							*5450 *11,900	5350 *11,900	4240 13'6"

Reach Boom Lift Capacities – Counterweight: 3.57 mt (7,870 lb) – without Bucket

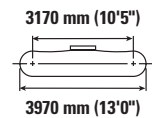
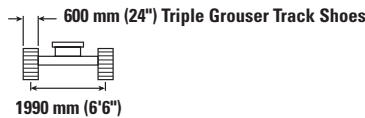

Reach	Unit	1500 mm/5'0"		3000 mm/10'0"		4500 mm/15'0"		6000 mm/20'0"		7500 mm/25'0"		mm ft/in		
		kg lb	kg lb	kg lb	kg lb	kg lb	kg lb	kg lb	kg lb	kg lb	kg lb	kg lb	mm ft/in	
7500 mm 25'0"	kg lb											*2950 *6,600	*2950 *6,600	5100 16'2"
6000 mm 20'0"	kg lb							*3650 *7,450	3650 *7,450			*2650 *5,900	*2650 *5,900	6450 20'11"
4500 mm 15'0"	kg lb							*4050 *8,850	3600 7,700			*2600 *5,700	*2600 *5,700	7240 23'7"
3000 mm 10'0"	kg lb			*8000 *17,050	*8000 *17,050	*5550 *11,950	5250 11,300	*4600 *10,000	3450 7,400	*3350 *6,200	2450 5,250	*2700 *5,850	2350 5,200	7660 25'1"
1500 mm 5'0"	kg lb			*6950 *16,650	*6950 *16,650	*6950 *14,950	4900 10,550	5250 11,250	3300 7,050	3750 *7,950	2400 5,100	*2900 *6,300	2250 4,950	7780 25'5"
0 mm 0'0"	kg lb			*6950 *15,950	*6950 *15,950	7850 16,850	4650 10,000	5100 10,950	3150 6,800	3700 2350		*3250 *7,150	2300 5,050	7590 24'10"
-1500 mm -5'0"	kg lb	*5650 *12,550	*5650 *12,550	*10 000 *22,750	8350 17,850	7750 16,600	4550 9,800	5050 10,800	3100 6,650			*4000 *8,800	2500 5,500	7080 23'2"
-3000 mm -10'0"	kg lb	*9250 *20,750	*9250 *20,750	*11 150 *24,050	8450 18,100	*7600 *16,450	4600 9,850	5050 10,900	3150 6,750			4900 10,850	3050 6,700	6160 20'1"
-4500 mm -15'0"	kg lb			*8550 *18,200	*8550 *18,200	*5750	4750					*5550 *12,200	4600 10,500	4610 14'9"



ISO 10567:2007



* Indicates that the load is limited by hydraulic lifting capacity rather than tipping load. The above loads are in compliance with hydraulic excavator lift capacity standard ISO 10567:2007. They do not exceed 87% of hydraulic lifting capacity or 75% of tipping load. Weight of all lifting accessories must be deducted from the above lifting capacities. Lifting capacities are based on the machine standing on a firm, uniform supporting surface. The use of a work tool attachment point to handle/lift objects, could affect the machine lift performance.

Lift capacity stays with ±5% for all available track shoes.

Always refer to the appropriate Operation and Maintenance Manual for specific product information.

317 GC Hydraulic Excavator Specifications

Reach Boom Lift Capacities – Counterweight: 3.57 mt (7,870 lb) – without Bucket

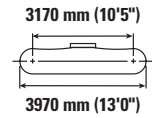
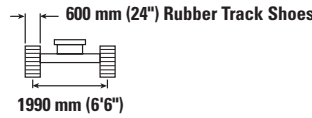
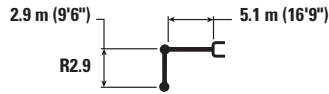

		1500 mm/5'0"		3000 mm/10'0"		4500 mm/15'0"		6000 mm/20'0"		7500 mm/25'0"		mm ft/in		
7500 mm 25'0"	kg lb											*2950 *6,600	*2950 *6,600	5100 16'2"
6000 mm 20'0"	kg lb							*3650 *7,450	*3650 *7,450			*2650 *5,900	*2650 *5,900	6450 20'11"
4500 mm 15'0"	kg lb							*4050 *8,850	3650 7,850			*2600 *5,700	*2600 *5,700	7240 23'7"
3000 mm 10'0"	kg lb			*8000 *17,050	*8000 *17,050	*5550 *11,950	5350 11,500	*4600 *10,000	3500 7,550	*3350 *6,200	2500 5,350	*2700 *5,850	2400 5,300	7660 25'1"
1500 mm 5'0"	kg lb			*6950 *16,650	*6950 *16,650	*6950 *14,950	5000 10,750	*5250 *11,400	3350 7,200	3850 *7,950	2450 5,200	*2900 *6,300	2300 5,050	7780 25'5"
0 mm 0'0"	kg lb			*6950 *15,950	*6950 *15,950	*7850 *17,000	4750 10,200	5200 11,150	3200 6,900	3800	2400	*3250 *7,150	2350 5,150	7590 24'10"
-1500 mm -5'0"	kg lb	*5650 *12,550	*5650 *12,550	*10 000 *22,750	8500 18,200	7900 16,950	4650 10,000	5150 11,000	3150 6,800			*4000 *8,800	2550 5,600	7080 23'2"
-3000 mm -10'0"	kg lb	*9250 *20,750	*9250 *20,750	*11 150 *24,050	8600 18,450	*7600 *16,450	4650 10,050	5150 11,100	3200 6,850			5000 11,050	3100 6,850	6160 20'1"
-4500 mm -15'0"	kg lb			*8550 *18,200	*8550 *18,200	*5750	4850					*5550 *12,200	4700 10,700	4610 14'9"

Reach Boom Lift Capacities – Counterweight: 3.57 mt (7,870 lb) – without Bucket

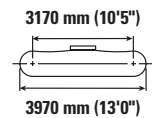
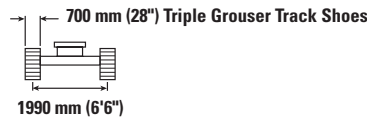

		1500 mm/5'0"		3000 mm/10'0"		4500 mm/15'0"		6000 mm/20'0"		7500 mm/25'0"		mm ft/in		
7500 mm 25'0"	kg lb											*2950 *6,600	*2950 *6,600	5100 16'2"
6000 mm 20'0"	kg lb							*3650 *7,450	*3650 *7,450			*2650 *5,900	*2650 *5,900	6450 20'11"
4500 mm 15'0"	kg lb							*4050 *8,850	3650 7,800			*2600 *5,700	*2600 *5,700	7240 23'7"
3000 mm 10'0"	kg lb			*8000 *17,050	*8000 *17,050	*5550 *11,950	5300 11,450	*4600 *10,000	3500 7,500	*3350 *6,200	2500 5,300	*2700 *5,850	2400 5,250	7660 25'1"
1500 mm 5'0"	kg lb			*6950 *16,650	*6950 *16,650	*6950 *14,950	4950 10,650	*5250 11,400	3300 7,150	3800 *7,950	2400 5,150	*2900 *6,300	2300 5,000	7780 25'5"
0 mm 0'0"	kg lb			*6950 *15,950	*6950 *15,950	*7850 *17,000	4700 10,150	5150 11,100	3200 6,850	3750	2350	*3250 *7,150	2300 5,100	7590 24'10"
-1500 mm -5'0"	kg lb	*5650 *12,550	*5650 *12,550	*10 000 *22,750	8450 18,100	7850 16,850	4600 9,950	5100 10,950	3150 6,750			*4000 *8,800	2550 5,550	7080 23'2"
-3000 mm -10'0"	kg lb	*9250 *20,750	*9250 *20,750	*11 150 *24,050	8550 18,300	*7600 *16,450	4650 10,000	5100 11,050	3150 6,800			4950 10,950	3050 6,800	6160 20'1"
-4500 mm -15'0"	kg lb			*8550 *18,200	*8550 *18,200	*5750	4800					*5550 *12,200	4700 10,650	4610 14'9"



ISO 10567:2007



* Indicates that the load is limited by hydraulic lifting capacity rather than tipping load. The above loads are in compliance with hydraulic excavator lift capacity standard ISO 10567:2007. They do not exceed 87% of hydraulic lifting capacity or 75% of tipping load. Weight of all lifting accessories must be deducted from the above lifting capacities. Lifting capacities are based on the machine standing on a firm, uniform supporting surface. The use of a work tool attachment point to handle/lift objects, could affect the machine lift performance.

Lift capacity stays with ±5% for all available track shoes.

Always refer to the appropriate Operation and Maintenance Manual for specific product information.

317 GC Hydraulic Excavator Specifications

Reach Boom Lift Capacities – Counterweight: 3.57 mt (7,870 lb) – without Bucket

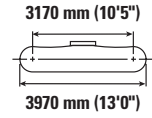
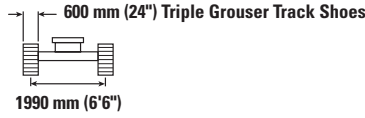
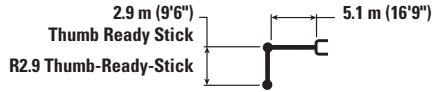

		1500 mm/5'0"		3000 mm/10'0"		4500 mm/15'0"		6000 mm/20'0"		7500 mm/25'0"		mm ft/in		
7500 mm 25'0"	kg lb											*2900 *6,500	*2900 *6,500	5100 16'2"
6000 mm 20'0"	kg lb							*3600 *7,350	3600 *7,350			*2650 *5,800	*2650 *5,800	6450 20'11"
4500 mm 15'0"	kg lb							*4000 *8,700	3550 7,600			*2550 *5,600	*2550 *5,600	7240 23'7"
3000 mm 10'0"	kg lb			*7900 *16,850	*7900 *16,850	*5450 *11,750	5200 11,150	*4550 *9,850	3400 7,250	*3300 *6,100	2400 5,100	*2650 *5,750	2300 5,100	7660 25'1"
1500 mm 5'0"	kg lb			*6900 *16,550	*6900 *16,550	*6850 *14,750	4800 10,350	5150 11,100	3200 6,900	3700 *7,850	2300 4,950	*2850 *6,200	2200 4,800	7780 25'5"
0 mm 0'0"	kg lb			*6900 *15,850	*6900 *15,850	*7750 16,700	4550 9,850	5050 10,800	3100 6,650	3650	2250	*3200 *7,050	2250 4,900	7590 24'10"
-1500 mm -5'0"	kg lb	*5600 *12,500	*5600 *12,500	*9950 *22,650	8200 17,600	7650 16,450	4450 9,600	4950 10,650	3000 6,500			3950 8,650	2450 5,350	7080 23'2"
-3000 mm -10'0"	kg lb	*9200 *20,650	*9200 *20,650	*11 000 *23,800	8300 17,850	*7550 *16,250	4500 9,700	5000 10,750	3050 6,600			4800 10,700	2950 6,550	6160 20'1"
-4500 mm -15'0"	kg lb			*8450 *18,000	*8450 *18,000	*5650	4700					*5450 *12,000	4550 10,350	4610 14'9"

Reach Boom Lift Capacities – Counterweight: 3.57 mt (7,870 lb) – without Bucket

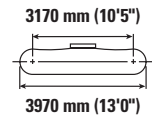
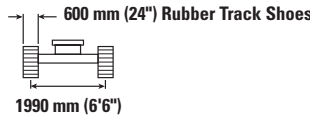
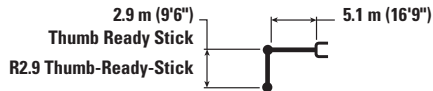

		1500 mm/5'0"		3000 mm/10'0"		4500 mm/15'0"		6000 mm/20'0"		7500 mm/25'0"		mm ft/in		
7500 mm 25'0"	kg lb											*2900 *6,500	*2900 *6,500	5100 16'2"
6000 mm 20'0"	kg lb							*3600 *7,350	*3600 *7,350			*2650 *5,800	*2650 *5,800	6450 20'11"
4500 mm 15'0"	kg lb							*4000 *8,700	3600 7,700			*2550 *5,600	*2550 *5,600	7240 23'7"
3000 mm 10'0"	kg lb			*7900 *16,850	*7900 *16,850	*5450 *11,750	5300 11,350	*4550 *9,850	3450 7,400	*3300 *6,100	2450 5,200	*2650 *5,750	2350 5,200	7660 25'1"
1500 mm 5'0"	kg lb			*6900 *16,550	*6900 *16,550	*6850 *14,750	4900 10,550	*5200 *11,250	3300 7,050	3800 *7,850	2350 5,050	*2850 *6,200	2250 4,900	7780 25'5"
0 mm 0'0"	kg lb			*6900 *15,850	*6900 *15,850	*7750 *16,800	4650 10,000	5100 11,000	3150 6,750	3700	2300	*3200 *7,050	2300 5,000	7590 24'10"
-1500 mm -5'0"	kg lb	*5600 *12,500	*5600 *12,500	*9950 *22,650	8350 17,950	7800 16,750	4550 9,800	5050 10,850	3100 6,650			*3950 *8,700	2500 5,450	7080 23'2"
-3000 mm -10'0"	kg lb	*9200 *20,650	*9200 *20,650	*11 000 *23,800	8500 18,200	*7550 *16,250	4600 9,900	5100 10,950	3100 6,700			4900 10,900	3000 6,700	6160 20'1"
-4500 mm -15'0"	kg lb			*8450 *18,000	*8450 *18,000	*5650	4800					*5450 *12,000	4650 10,550	4610 14'9"



ISO 10567:2007



* Indicates that the load is limited by hydraulic lifting capacity rather than tipping load. The above loads are in compliance with hydraulic excavator lift capacity standard ISO 10567:2007. They do not exceed 87% of hydraulic lifting capacity or 75% of tipping load. Weight of all lifting accessories must be deducted from the above lifting capacities. Lifting capacities are based on the machine standing on a firm, uniform supporting surface. The use of a work tool attachment point to handle/lift objects, could affect the machine lift performance.

Lift capacity stays with ±5% for all available track shoes.

Always refer to the appropriate Operation and Maintenance Manual for specific product information.

317 GC Hydraulic Excavator Specifications

Reach Boom Lift Capacities – Counterweight: 3.57 mt (7,870 lb) – without Bucket

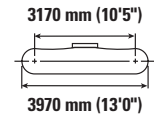
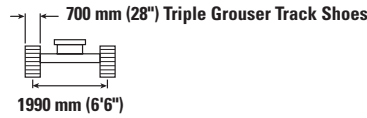
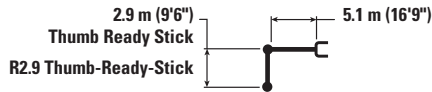

		1500 mm/5'0"		3000 mm/10'0"		4500 mm/15'0"		6000 mm/20'0"		7500 mm/25'0"		mm ft/in		
7500 mm 25'0"	kg lb											*2900 *6,500	*2900 *6,500	5100 16'2"
6000 mm 20'0"	kg lb							*3600 *7,350	*3600 *7,350			*2650 *5,800	*2650 *5,800	6450 20'11"
4500 mm 15'0"	kg lb							*4000 *8,700	3550 7,650			*2550 *5,600	*2550 *5,600	7240 23'7"
3000 mm 10'0"	kg lb			*7900 *16,850	*7900 *16,850	*5450 *11,750	5250 11,300	*4550 *9,850	3450 7,350	*3300 *6,100	2400 5,200	*2650 *5,750	2350 5,150	7660 25'1"
1500 mm 5'0"	kg lb			*6900 *16,550	*6900 *16,550	*6850 *14,750	4850 10,500	*5200 *11,250	3250 7,000	3750 *7,850	2350 5,050	*2850 *6,200	2250 4,900	7780 25'5"
0 mm 0'0"	kg lb			*6900 *15,850	*6900 *15,850	*7750 *16,800	4650 9,950	5100 10,950	3150 6,700	3700	2300	*3200 *7,050	2250 4,950	7590 24'10"
-1500 mm -5'0"	kg lb	*5600 *12,500	*5600 *12,500	*9950 *22,650	8300 17,800	7750 16,650	4550 9,750	5000 10,800	3050 6,600			*3950 *8,700	2450 5,400	7080 23'2"
-3000 mm -10'0"	kg lb	*9200 *20,650	*9200 *20,650	*11 000 *23,800	8400 18,100	*7550 *16,250	4550 9,800	5050 10,900	3100 6,650			4900 10,800	3000 6,650	6160 20'1"
-4500 mm -15'0"	kg lb			*8450 *18,000		*5650	4750					*5450 *12,000	4600 10,500	4610 14'9"

Reach Boom Lift Capacities – Counterweight: 3.57 mt (7,870 lb) – without Bucket

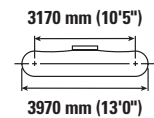
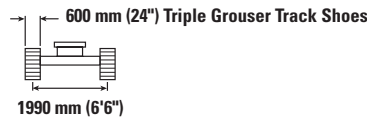

		1500 mm/5'0"		3000 mm/10'0"		4500 mm/15'0"		6000 mm/20'0"		7500 mm/25'0"		mm ft/in		
7500 mm 25'0"	kg lb											*2700 *6,050	*2700 *6,050	5380 17'2"
6000 mm 20'0"	kg lb							*3650 *7,550	*3650 *7,550			*2450 *5,400	*2450 *5,400	6670 21'7"
4500 mm 15'0"	kg lb							*3900 *8,500	3600 7,750			*2400 *5,250	*2400 *5,250	7440 24'3"
3000 mm 10'0"	kg lb			*7500 *15,950	*7500 *15,950	*5300 *11,450	5300 11,400	*4500 *9,700	3450 7,450	*3600 *7,100	2450 5,300	*2450 *5,400	2300 5,050	7850 25'8"
1500 mm 5'0"	kg lb			*8250 *19,750	*8250 19,000	*6750 *14,550	4950 10,600	*5150 *11,200	3300 7,100	3750 8,100	2400 5,150	*2650 *5,800	2200 4,800	7960 26'1"
0 mm 0'0"	kg lb			*7150 *16,450	*7150 *16,450	*7750 *16,800	4700 10,050	5100 10,950	3150 6,800	3700 7,950	2350 5,000	*3000 *6,550	2200 4,850	7780 25'5"
-1500 mm -5'0"	kg lb	*5400 *12,050	*5400 *12,050	*9700 *22,100	8350 17,850	7750 16,650	4550 9,800	5000 10,800	3100 6,650			*3600 *7,950	2400 5,300	7280 23'10"
-3000 mm -10'0"	kg lb	*8700 *19,450	*8700 *19,450	*11 400 *24,650	8400 18,050	*7750 16,650	4550 9,850	5050 10,850	3100 6,700			4600 10,250	2850 6,350	6400 20'10"
-4500 mm -15'0"	kg lb			*9100 *19,350	8650 18,600	*6150 *12,950	4700 10,200					*5450 *12,000	4200 9,500	4920 15'9"



ISO 10567:2007



* Indicates that the load is limited by hydraulic lifting capacity rather than tipping load. The above loads are in compliance with hydraulic excavator lift capacity standard ISO 10567:2007. They do not exceed 87% of hydraulic lifting capacity or 75% of tipping load. Weight of all lifting accessories must be deducted from the above lifting capacities. Lifting capacities are based on the machine standing on a firm, uniform supporting surface. The use of a work tool attachment point to handle/lift objects, could affect the machine lift performance.

Lift capacity stays with ±5% for all available track shoes.

Always refer to the appropriate Operation and Maintenance Manual for specific product information.

317 GC Hydraulic Excavator Specifications

Reach Boom Lift Capacities – Counterweight: 3.57 mt (7,870 lb) – without Bucket

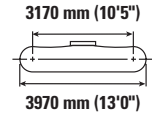
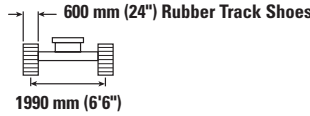
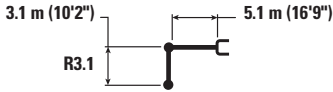

		1500 mm/5'0"		3000 mm/10'0"		4500 mm/15'0"		6000 mm/20'0"		7500 mm/25'0"		mm ft/in		
7500 mm 25'0"	kg lb											*2700 *6,050	*2700 *6,050	5380 17'2"
6000 mm 20'0"	kg lb							*3650 *7,550	*3650 *7,550			*2450 *5,400	*2450 *5,400	6670 21'7"
4500 mm 15'0"	kg lb							*3900 *8,500	3650 7,900			*2400 *5,250	*2400 *5,250	7440 24'3"
3000 mm 10'0"	kg lb			*7500 *15,950	*7500 *15,950	*5300 *11,450	*5300 *11,450	*4500 *9,700	3500 7,600	*3600 *7,100	2500 5,400	*2450 *5,400	2350 5,150	7850 25'8"
1500 mm 5'0"	kg lb			*8250 *19,750	*8250 *19,350	*6750 *14,550	5000 10,800	*5150 *11,200	3350 7,200	3850 8,250	2450 5,250	*2650 *5,800	2250 4,900	7960 26'1"
0 mm 0'0"	kg lb			*7150 *16,450	*7150 *16,450	*7750 *16,800	4750 10,250	5200 11,200	3250 6,950	3800 8,100	2400 5,100	*3000 *6,550	2250 4,950	7780 25'5"
-1500 mm -5'0"	kg lb	*5400 *12,050	*5400 *12,050	*9700 *22,100	8500 18,200	7900 16,950	4650 10,000	5100 11,000	3150 6,800			*3600 *7,950	2450 5,400	7280 23'10"
-3000 mm -10'0"	kg lb	*8700 *19,450	*8700 *19,450	*11,400 *24,650	8550 18,400	*7750 *16,700	4650 10,050	5150 11,050	3150 6,800			4700 10,450	2950 6,450	6400 20'10"
-4500 mm -15'0"	kg lb			*9100 *19,350	8800 18,950	*6150 *12,950	4800 10,400					*5450 *12,000	4300 9,700	4920 15'9"

Reach Boom Lift Capacities – Counterweight: 3.57 mt (7,870 lb) – without Bucket

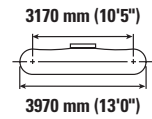
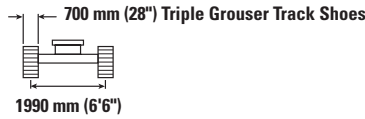

		1500 mm/5'0"		3000 mm/10'0"		4500 mm/15'0"		6000 mm/20'0"		7500 mm/25'0"		mm ft/in		
7500 mm 25'0"	kg lb											*2700 *6,050	*2700 *6,050	5380 17'2"
6000 mm 20'0"	kg lb							*3650 *7,550	*3650 *7,550			*2450 *5,400	*2450 *5,400	6670 21'7"
4500 mm 15'0"	kg lb							*3900 *8,500	3650 7,850			*2400 *5,250	*2400 *5,250	7440 24'3"
3000 mm 10'0"	kg lb			*7500 *15,950	*7500 *15,950	*5300 *11,450	*5300 *11,450	*4500 *9,700	3500 7,550	*3600 *7,100	2500 5,350	*2450 *5,400	2300 5,100	7850 25'8"
1500 mm 5'0"	kg lb			*8250 *19,750	*8250 *19,200	*6750 *14,550	5000 10,750	*5150 *11,200	3350 7,200	3800 8,200	2400 5,200	*2650 *5,800	2200 4,850	7960 26'1"
0 mm 0'0"	kg lb			*7150 *16,450	*7150 *16,450	*7750 *16,800	4750 10,200	5150 11,100	3200 6,900	3750 8,050	2350 5,050	*3000 *6,550	2250 4,900	7780 25'5"
-1500 mm -5'0"	kg lb	*5400 *12,050	*5400 *12,050	*9700 *22,100	8450 18,100	7850 16,850	4600 9,950	5100 10,950	3150 6,750			*3600 *7,950	2450 5,350	7280 23'10"
-3000 mm -10'0"	kg lb	*8700 *19,450	*8700 *19,450	*11,400 *24,650	8500 18,250	*7750 *16,700	4650 9,950	5100 11,000	3150 6,750			4700 10,350	2900 6,450	6400 20'10"
-4500 mm -15'0"	kg lb			*9100 *19,350	8750 18,850	*6150 *12,950	4800 10,300					*5450 *12,000	4250 9,600	4920 15'9"



ISO 10567:2007



* Indicates that the load is limited by hydraulic lifting capacity rather than tipping load. The above loads are in compliance with hydraulic excavator lift capacity standard ISO 10567:2007. They do not exceed 87% of hydraulic lifting capacity or 75% of tipping load. Weight of all lifting accessories must be deducted from the above lifting capacities. Lifting capacities are based on the machine standing on a firm, uniform supporting surface. The use of a work tool attachment point to handle/lift objects, could affect the machine lift performance.

Lift capacity stays with ±5% for all available track shoes.

Always refer to the appropriate Operation and Maintenance Manual for specific product information.

317 GC Hydraulic Excavator Specifications

Bucket Specifications and Compatibility

	Linkage	Width		Capacity		Weight		Fill %	3.05 mt (6,720 lb) Counterweight		
		mm	in	m ³	yd ³	kg	lb		Reach Boom		
									R2.6 (8'6")	R2.9 (9'6")	R3.1 (10'2")
Pin-On (No Quick Coupler)											
General Duty	316	600	24	0.35	0.46	454	1,001	100	●	●	●
	316	750	30	0.49	0.64	516	1,137	100	●	●	●
	316	900	36	0.62	0.81	580	1,278	100	●	●	●
	316	1050	42	0.76	1.00	629	1,386	100	●	⊙	⊙
	316	1200	48	0.91	1.19	697	1,538	100	⊖	⊖	⊖
General Duty – Wide Tip	316	600	24	0.42	0.55	473	1,042	100	●	●	●
	316	750	30	0.58	0.76	535	1,179	100	●	●	●
	316	1050	42	0.90	1.18	670	1,478	100	⊖	⊖	⊖
	316	1200	48	1.07	1.40	737	1,625	100	○	○	○
Severe Duty	316	900	36	0.62	0.81	669	1,475	100	●	●	●
	316	1050	42	0.76	1.00	728	1,605	100	⊙	⊙	⊖
Clean Up	316	1500	60	1.24	1.62	770	1,698	100	○	◇	◇
Ditch Cleaning – Tilt	316	1500	60	0.64	0.84	830	1,829	100	●	⊙	⊙
	316	1800	72	0.78	1.02	928	2,046	100	⊖	⊖	○
	316	2000	79	0.86	1.12	1043	2,299	100	○	○	◇
Maximum load with pin-on (payload + bucket)								kg	2200	2080	2000
								lb	4,842	4,583	4,410

The above loads are in compliance with hydraulic excavator standard EN474-5:2006+A3:2013, they do not exceed 87% of hydraulic lifting capacity or 75% of tipping capacity with front linkage fully extended at ground line with bucket curled.

Capacity based on ISO 7451:2007.

Maximum Material Density:

- 2100 kg/m³ (3,500 lb/yd³)
- ⊙ 1800 kg/m³ (3,000 lb/yd³)
- ⊖ 1500 kg/m³ (2,500 lb/yd³)
- 1200 kg/m³ (2,000 lb/yd³)
- ◇ 900 kg/m³ (1,500 lb/yd³)

Caterpillar recommends using appropriate work tools to maximize the value customers receive from our products. Use of work tools, including buckets, which are outside of Caterpillar's recommendations or specifications for weight, dimensions, flows, pressures, etc. may result in less-than-optimal performance, including but not limited to reductions in production, stability, reliability, and component durability. Improper use of a work tool resulting in sweeping, prying, twisting and/or catching of heavy loads will reduce the life of the boom and stick.

(continued on next page)

317 GC Hydraulic Excavator Specifications

Bucket Specifications and Compatibility *(continued)*

	Linkage	Width		Capacity		Weight		Fill %	3.05 mt (6,720 lb) Counterweight		
		mm	in	m ³	yd ³	kg	lb		Reach Boom		
									R2.6 (8'6")	R2.9 (9'6")	R3.1 (10'2")
With Cat Pin Grabber Coupler											
General Duty	316	600	24	0.35	0.46	454	1,001	100	●	●	●
	316	750	30	0.49	0.64	516	1,137	100	●	●	●
	316	900	36	0.62	0.81	580	1,278	100	●	●	⊙
	316	1050	42	0.76	1.00	629	1,386	100	⊖	⊖	⊖
	316	1200	48	0.91	1.19	697	1,538	100	○	○	○
General Duty – Wide Tip	316	600	24	0.42	0.55	473	1,042	100	●	●	●
	316	750	30	0.58	0.76	535	1,179	100	●	●	●
	316	1050	42	0.90	1.18	670	1,478	100	○	○	○
	316	1200	48	1.07	1.40	737	1,625	100	◇	◇	◇
Severe Duty	318	900	36	0.62	0.81	669	1,475	100	⊙	⊙	⊙
	318	1050	42	0.76	1.00	728	1,605	100	⊖	⊖	○
General Duty – Pin Grabber Performance	316	600	24	0.33	0.43	436	961	100	●	●	●
	316	900	36	0.57	0.75	578	1,273	100	●	●	●
Clean Up	316	1500	60	1.24	1.62	770	1,698	100	◇	◇	X
Ditch Cleaning – Tilt	316	1500	60	0.64	0.84	830	1,829	100	⊖	⊖	⊖
	316	1800	72	0.78	1.02	928	2,046	100	○	○	◇
	316	2000	79	0.86	1.12	1043	2,299	100	◇	◇	◇
Maximum load with coupler (payload + bucket)								kg	1896	1879	1800
								lb	4,180	4,142	3,969

The above loads are in compliance with hydraulic excavator standard EN474-5:2006+A3:2013, they do not exceed 87% of hydraulic lifting capacity or 75% of tipping capacity with front linkage fully extended at ground line with bucket curled.

Capacity based on ISO 7451:2007.

Maximum Material Density:

- 2100 kg/m³ (3,500 lb/yd³)
- ⊙ 1800 kg/m³ (3,000 lb/yd³)
- ⊖ 1500 kg/m³ (2,500 lb/yd³)
- 1200 kg/m³ (2,000 lb/yd³)
- ◇ 900 kg/m³ (1,500 lb/yd³)
- X Not Recommended

Caterpillar recommends using appropriate work tools to maximize the value customers receive from our products. Use of work tools, including buckets, which are outside of Caterpillar's recommendations or specifications for weight, dimensions, flows, pressures, etc. may result in less-than-optimal performance, including but not limited to reductions in production, stability, reliability, and component durability. Improper use of a work tool resulting in sweeping, prying, twisting and/or catching of heavy loads will reduce the life of the boom and stick.

(continued on next page)

317 GC Hydraulic Excavator Specifications

Bucket Specifications and Compatibility *(continued)*

	Linkage	Width		Capacity		Weight		Fill %	3.57 mt (7,870 lb) Counterweight			
		mm	in	m ³	yd ³	kg	lb		Reach Boom			
									R2.6 (8'6")	R2.9 (9'6")	R2.9 (9'6") Thumb Ready	R3.1 (10'2")
Pin-On (No Quick Coupler)												
General Duty	316	600	24	0.35	0.46	454	1,001	100	●	●	●	●
	316	750	30	0.49	0.64	516	1,137	100	●	●	●	●
	316	900	36	0.62	0.81	580	1,278	100	●	●	●	●
	316	1050	42	0.76	1.00	629	1,386	100	●	●	●	●
	316	1200	48	0.91	1.19	697	1,538	100	⊙	⊙	⊖	⊖
General Duty – Wide Tip	316	600	24	0.42	0.55	473	1,042	100	●	●	●	●
	316	750	30	0.58	0.76	535	1,179	100	●	●	●	●
	316	1050	42	0.90	1.18	670	1,478	100	⊙	⊙	⊖	⊖
	316	1200	48	1.07	1.40	737	1,625	100	⊖	⊖	○	○
Severe Duty	316	900	36	0.62	0.81	669	1,475	100	●	●	●	●
	316	1050	42	0.76	1.00	728	1,605	100	●	●	⊙	⊙
Clean Up	316	1500	60	1.24	1.62	770	1,698	100	○	○	○	○
Ditch Cleaning – Tilt	316	1500	60	0.64	0.84	830	1,829	100	●	●	●	●
	316	1800	72	0.78	1.02	928	2,046	100	⊙	⊙	⊖	⊖
	316	2000	79	0.86	1.12	1043	2,299	100	⊖	⊖	○	○
Maximum load with pin-on (payload + bucket)								kg	2420	2290	2210	2420
								lb	5,331	5,059	4,867	5,331

The above loads are in compliance with hydraulic excavator standard EN474-5:2006+A3:2013, they do not exceed 87% of hydraulic lifting capacity or 75% of tipping capacity with front linkage fully extended at ground line with bucket curled.

Capacity based on ISO 7451:2007.

Maximum Material Density:

- 2100 kg/m³ (3,500 lb/yd³)
- ⊙ 1800 kg/m³ (3,000 lb/yd³)
- ⊖ 1500 kg/m³ (2,500 lb/yd³)
- 1200 kg/m³ (2,000 lb/yd³)

Caterpillar recommends using appropriate work tools to maximize the value customers receive from our products. Use of work tools, including buckets, which are outside of Caterpillar's recommendations or specifications for weight, dimensions, flows, pressures, etc. may result in less-than-optimal performance, including but not limited to reductions in production, stability, reliability, and component durability. Improper use of a work tool resulting in sweeping, prying, twisting and/or catching of heavy loads will reduce the life of the boom and stick.

(continued on next page)

317 GC Hydraulic Excavator Specifications

Bucket Specifications and Compatibility (continued)

	Linkage	Width		Capacity		Weight		Fill %	3.57 mt (7,870 lb) Counterweight				
		mm	in	m ³	yd ³	kg	lb		Reach Boom				
									R2.6 (8'6")	R2.9 (9'6")	R2.9 (9'6") Thumb Ready	R3.1 (10'2")	
With Cat Pin Grabber Coupler													
General Duty	316	600	24	0.35	0.46	454	1,001	100	●	●	●	●	
	316	750	30	0.49	0.64	516	1,137	100	●	●	●	●	
	316	900	36	0.62	0.81	580	1,278	100	●	●	●	●	
	316	1050	42	0.76	1.00	629	1,386	100	⊙	⊙	⊙	⊙	
	316	1200	48	0.91	1.19	697	1,538	100	⊖	⊖	⊖	⊖	
General Duty – Wide Tip	316	600	24	0.42	0.55	473	1,042	100	●	●	●	●	
	316	750	30	0.58	0.76	535	1,179	100	●	●	●	●	
	316	1050	42	0.90	1.18	670	1,478	100	⊖	⊖	⊖	⊖	
	316	1200	48	1.07	1.40	737	1,625	100	○	○	○	○	
Severe Duty	318	900	36	0.62	0.81	669	1,475	100	●	●	●	●	
	318	1050	42	0.76	1.00	728	1,605	100	⊙	⊙	⊖	⊖	
General Duty – Pin Grabber Performance	316	600	24	0.33	0.43	436	961	100	●	●	●	●	
	316	900	36	0.57	0.75	578	1,273	100	●	●	●	●	
Clean Up	316	1500	60	1.24	1.62	770	1,698	100	◇	◇	◇	◇	
Ditch Cleaning – Tilt	316	1500	60	0.64	0.84	830	1,829	100	●	●	⊙	⊙	
	316	1800	72	0.78	1.02	928	2,046	100	⊖	⊖	○	○	
	316	2000	79	0.86	1.12	1043	2,299	100	○	○	◇	◇	
Maximum load with coupler (payload + bucket)									kg	2118	2118	2008	2218
									lb	4,670	4,670	4,427	4,891

The above loads are in compliance with hydraulic excavator standard EN474-5:2006+A3:2013, they do not exceed 87% of hydraulic lifting capacity or 75% of tipping capacity with front linkage fully extended at ground line with bucket curled.

Capacity based on ISO 7451:2007.

Maximum Material Density:

- 2100 kg/m³ (3,500 lb/yd³)
- ⊙ 1800 kg/m³ (3,000 lb/yd³)
- ⊖ 1500 kg/m³ (2,500 lb/yd³)
- 1200 kg/m³ (2,000 lb/yd³)
- ◇ 900 kg/m³ (1,500 lb/yd³)

Caterpillar recommends using appropriate work tools to maximize the value customers receive from our products. Use of work tools, including buckets, which are outside of Caterpillar's recommendations or specifications for weight, dimensions, flows, pressures, etc. may result in less-than-optimal performance, including but not limited to reductions in production, stability, reliability, and component durability. Improper use of a work tool resulting in sweeping, prying, twisting and/or catching of heavy loads will reduce the life of the boom and stick.

317 GC Hydraulic Excavator Specifications

Attachments Offering Guide

Not all Attachments are available in all regions. Consult your Cat dealer for configurations available in your region.

Match
 * Working range front only
 No Match
 1800 kg/m³ (3,000 lb/yd³)
 1200 kg/m³ (2,000 lb/yd³)

PIN-ON ATTACHMENTS

Counterweight		3.05 mt (6,720 lb)			3.57 mt (7,870 lb)		
		Reach			Reach		
Boom Type		2.60 m (8'6")	2.90 m (9'6")	3.10 m (10'2")	2.60 m (8'6")	2.90 m (9'6")	2.90 m (9'6") TRS (10'2")
Stick Length							
Hydraulic Hammers	H110 S		✓		✓	✓	✓
	H115 GC		✓		✓	✓	✓
	H115 GC S		✓		✓	✓	✓
	H115 S		✓		✓	✓	✓
	H120 S		✓		✓	✓	✓
Demolition and Sorting Grapples	G314		✓		✓	✓	✓
Mobile Scrap and Demolition Shears	S3015 Flat Top		✓		✓	✓	✓
Pulverizers	P214 Secondary Pulverizer	✓	✓	✓	✓	✓	✓
Compactors (Vibratory Plate)	CVP75		✓		✓	✓	✓
Orange Peel Grapples	GSH420-500		○		●	●	●
	GSH420-600		○		●	○	○
	GSH420-750				○	○	○
	GSH520-500		○		●	○	○
	GSH520-600				○	○	○

CAT PIN GRABBER COUPLER ATTACHMENTS

Counterweight		3.05 mt (6,720 lb)			3.57 mt (7,870 lb)		
		Reach			Reach		
Boom Type		2.60 m (8'6")	2.90 m (9'6")	2.60 m (8'6")	2.90 m (9'6")	2.90 m (9'6") TRS	3.10 m (10'2")
Stick Length							
Hydraulic Hammers	H110 S		✓	✓	✓	✓	✓
	H115 GC		✓	✓	✓	✓	✓
	H115 GC S		✓	✓	✓	✓	✓
	H115 S		✓	✓	✓	✓	✓
	H120 S		✓*	✓	✓	✓	✓
Demolition and Sorting Grapples	G314		✓*	✓	✓	✓	✓
Mobile Scrap and Demolition Shears	S3015 Flat Top		✓*	✓	✓	✓	✓
Pulverizers	P214 Secondary Pulverizer	✓*		✓	✓*	✓*	✓*
Compactors (Vibratory Plate)	CVP75		✓	✓	✓	✓	✓

(continued on next page)

317 GC Hydraulic Excavator Specifications

Attachments Offering Guide (continued)

Not all Attachments are available in all regions. Consult your Cat dealer for configurations available in your region.

Match

* Working range front only

No Match

HCS60 DEDICATED COUPLER ATTACHMENTS

Counterweight		3.05 mt (6,720 lb)			3.57 mt (7,870 lb)		
Boom Type		Reach			Reach		
Stick Length		2.60 m (8'6")	2.90 m (9'6")	3.10 m (10'2")	2.60 m (8'6")	2.90 m (9'6")	2.90 m (9'6") TRS (10'2")
Hydraulic Hammers	H110 S	✓	✓	✓	✓	✓	✓
	H115 S	✓	✓	✓	✓	✓	✓
	H120 S	✓	✓	✓	✓	✓	✓
Demolition and Sorting Grapples	G314	✓	✓	✓	✓	✓	✓
Mobile Scrap and Demolition Shears	S3015 Flat Top	✓	✓	✓	✓	✓	✓
Pulverizers	P214 Secondary Pulverizer	✓	✓*		✓	✓	✓
Compactors (Vibratory Plate)	CVP75	✓	✓	✓	✓	✓	✓

HCS65 DEDICATED COUPLER ATTACHMENTS

Counterweight		3.05 mt (6,720 lb)			3.57 mt (7,870 lb)		
Boom Type		Reach			Reach		
Stick Length		2.60 m (8'6")	2.90 m (9'6")	3.10 m (10'2")	2.60 m (8'6")	2.90 m (9'6")	2.90 m (9'6") TRS (10'2")
Hydraulic Hammers	H110 S	✓	✓	✓	✓	✓	✓
	H115 S	✓	✓	✓	✓	✓	✓
	H120 S	✓			✓	✓	✓
Demolition and Sorting Grapples	G314	✓	✓*	✓*	✓	✓	✓
Mobile Scrap and Demolition Shears	S3015 Flat Top	✓	✓*	✓*	✓	✓	✓
Pulverizers	P214 Secondary Pulverizer	✓*			✓	✓*	✓*
Compactors (Vibratory Plate)	CVP75	✓	✓	✓	✓	✓	✓

S60 DEDICATED COUPLER ATTACHMENTS

Counterweight		3.05 mt (6,720 lb)			3.57 mt (7,870 lb)		
Boom Type		Reach			Reach		
Stick Length		2.60 m (8'6")	2.90 m (9'6")	3.10 m (10'2")	2.60 m (8'6")	2.90 m (9'6")	2.90 m (9'6") TRS (10'2")
Hydraulic Hammers	H110 S	✓	✓	✓	✓	✓	✓
	H115 GC	✓	✓	✓	✓	✓	✓
	H115 GC S	✓	✓	✓	✓	✓	✓
	H115 S	✓	✓	✓	✓	✓	✓
	H120 S	✓	✓	✓	✓	✓	✓
Demolition and Sorting Grapples	G314	✓	✓	✓	✓	✓	✓
Mobile Scrap and Demolition Shears	S3015 Flat Top	✓	✓	✓	✓	✓	✓
Pulverizers	P214 Secondary Pulverizer	✓	✓*	✓*	✓	✓	✓
Compactors (Vibratory Plate)	CVP75	✓	✓	✓	✓	✓	✓

BOOM-MOUNT ATTACHMENTS

Undercarriage		Long	Long
Counterweight		3.05 mt (6,720 lb)	3.57 mt (7,870 lb)
Boom Type		Reach	Reach
Mobile Scrap and Demolition Shears	S3035 Flat Top	✓*	✓

Standard and Optional Equipment

Standard and optional equipment may vary. Consult your Cat dealer for details.

	Standard	Optional		Standard	Optional
BOOMS, STICKS AND LINKAGES			CAT TECHNOLOGY		
5.1 m (16'9") Reach boom	✓		VisionLink®	✓*	
2.6 m (8'6") Reach stick		✓	VisionLink Productivity		✓
2.9 m (9'6") Reach stick		✓	Remote Flash	✓	
2.9 m (9'6") Thumb Ready stick		✓	Remote Troubleshoot	✓	
3.1 m (10'2") Reach stick		✓	ELECTRICAL SYSTEM		
Bucket linkage, without lifting eye	✓		Maintenance free battery	✓	
CAB			Centralized electrical disconnect switch	✓	
ROPS	✓		Programmable time-delay LED working lights	✓	
High-resolution 203 mm (8") LCD touchscreen monitor	✓		LED chassis and left-side boom light – 1,800 lumens	✓	
Auto bi-level air conditioner	✓		LED right-side boom light and cab lights – 1,800 lumens		✓
Jog dial and shortcut keys for monitor control	✓		ENGINE		
Keyless push-to-start engine control	✓		Cat® C3.6 single turbo diesel engine	✓	
Height-adjustable console	✓		Two selectable modes: Power, Smart	✓	
Fixed left-side console	✓		One-touch low idle with automatic engine speed control	✓	
Mechanical-suspension seat	✓		Auto engine idle shutdown	✓	
51 mm (2") seat belt	✓		–18° C (0° F) cold start capability		✓
Bluetooth® integrated radio with USB port	✓		–25° C (–13° F) cold start capability		✓
12V DC outlets	✓		Single fuel filtration system with water separator and indicator	✓	
Console storage	✓		Sealed double element air filter with integrated pre-cleaner	✓	
Cup and bottle holders	✓		Electric fuel priming pump	✓	
Openable two-piece front window	✓		Electric cooling fans	✓	
Rear window emergency exit	✓		*Connect subscription only. Additional subscriptions are available. Contact your Cat dealer for availability.		
Washable floor mat	✓		<i>(continued on next page)</i>		
Upper radial wiper with washer	✓				
Openable steel hatch	✓				
LED dome light	✓				
Roller rear sunscreen		✓			
Beacon ready	✓				

317 GC Standard and Optional Equipment

Standard and Optional Equipment *(continued)*

Standard and optional equipment may vary. Consult your Cat dealer for details.

	Standard	Optional		Standard	Optional
HYDRAULIC SYSTEM			SERVICE AND MAINTENANCE		
Electronic main control valve	✓		Integrated vehicle health management system		✓
Single type electronic main pump	✓		Side entry to service platform	✓	
Boom and stick regeneration circuits	✓		Grouped engine oil and fuel filters	✓	
Boom and stick drift reduction valve	✓		Ground level engine oil dipstick	✓	
Automatic hydraulic oil warm up	✓		Lockable disconnect switch	✓	
Automatic two-speed travel	✓		Scheduled Oil Sampling (S·O·S SM) ports	✓	
Element type main hydraulic filter	✓		Travel alarm with cancel switch	✓	
SAFETY AND SECURITY			UNDERCARRIAGE AND STRUCTURES		
Rear and right-side-view cameras	✓		600 mm (24") triple grouser track shoes		✓
Ground level accessible secondary engine shutoff switch in cab	✓		600 mm (24") rubber track shoes		✓
Service platform with anti-skid plate and countersunk bolts	✓		700 mm (28") triple grouser track shoes with additional steps		✓
Signaling/warning horn	✓		2600 mm (8'6") blade		✓
Swing alarm		✓	2700 mm (8'10") blade		✓
Hydraulic lock out lever	✓		Grease lubricated track link	✓	
Inspection lighting		✓	Center track guiding guard	✓	
Auto Hammer Stop	✓		Bottom without swivel guard	✓	
			Travel motor guards	✓	
			3.05 mt (6,720 lb) counterweight		✓
			3.57 mt (7,870 lb) counterweight		✓
			Tie-down points at base frame	✓	

Dealer Installed Kits and Attachments

Attachments may vary. Consult your Cat dealer for details.

CAB

- Radial lower wiper
- Left-hand and right-hand electrical pedal (two-way) for tool control
- Dual exit rear window kit
- Rain protector plus cab light cover
- Polycarbonate roof hatch
- Front windshield laminated glass (P5A glass, EU demolition regulation)
- Key fob (for use with Bluetooth receiver)

SAFETY AND SECURITY

- 76 mm (3") retractable seat belt
- Bluetooth receiver

GUARDS

- OPG (not compatible with cab light cover, rain protector)
- Mesh guard full front (not compatible with cab light cover, rain protector)
- Mesh guard lower front half
- Full protecting vandalism guard

317 GC Environmental Declaration

The following information applies to the machine at the time of final manufacture as configured for sale in the regions covered in this document. The content of this declaration is valid as of the date issued; however, content related to machine features and specifications are subject to change without notice. For additional information, please see the machine's Operation and Maintenance Manual.

For more information on sustainability in action and our progress, please visit <https://www.caterpillar.com/en/company/sustainability>.

Engine

- The Cat® C3.6 engine meets U.S. EPA Tier 4 Final and EU Stage V emission standards.
- Cat diesel engines are required to use ULSD (ultra-low sulfur diesel fuel with 15 ppm of sulfur or less) or ULSD blended with the following lower-carbon intensity fuels** up to:
 - ✓ 20% biodiesel FAME (fatty acid methyl ester)*
 - ✓ 100% renewable diesel, HVO (hydrotreated vegetable oil) and GTL (gas-to-liquid) fuels

Refer to guidelines for successful application. Please consult your Cat dealer or “Caterpillar Machine Fluids Recommendations” (SEBU6250) for details.

**Engines with no aftertreatment devices can use higher blends, up to 100% biodiesel (for use of blends higher than 20% biodiesel, consult your Cat dealer).*

***Tailpipe greenhouse gas emissions from lower-carbon intensity fuels are essentially the same as traditional fuels.*

Air Conditioning System

- The air conditioning system on this machine contains the fluorinated greenhouse gas refrigerant R134a (Global Warming Potential = 1430). The system contains 0.9 kg (2.0 lb) of refrigerant which has a CO₂ equivalent of 1.418 metric tonnes (1.261 tons).

Paint

- Based on best available knowledge, the maximum allowable concentration, measured in parts per million (PPM), of the following heavy metals in paint are:
 - Barium < 0.01%
 - Cadmium < 0.01%
 - Chromium < 0.01%
 - Lead < 0.01%

Sound Performance

ISO 6395:2008 external 101 dB(A)

ISO 6396:2008 internal 70 dB(A)

- Hearing protection may be needed when operating with an open operator station and cab (when not properly maintained or doors/windows open) for extended periods or in a noisy environment.

Oils and Fluids

- Caterpillar factory fills with ethylene glycol coolants. Cat Diesel Engine Antifreeze/Coolant (DEAC) and Cat Extended Life Coolant (ELC) can be recycled. Consult your Cat dealer for more information.
- Cat Bio HYDO™ Advanced is an EU Ecolabel approved biodegradable hydraulic oil.
- Additional fluids are likely to be present, please consult the Operations and Maintenance Manual or the Application and Installation guide for complete fluid recommendations and maintenance intervals.

Features and Technology

- The following features and technology may contribute to fuel savings and/or carbon reduction. Features may vary. Consult your Cat dealer for details.
 - Advanced hydraulic systems balance power and efficiency
 - Smart mode matches machine power to digging requirements automatically
 - Cut maintenance costs up to 20% with extended maintenance intervals
 - Automatic engine speed control and engine shutdown
 - Complete work quickly and efficiently with expanded work tool offering

For more complete information on Cat products, dealer services, and industry solutions, visit us on the web at www.cat.com

© 2024 Caterpillar
All rights reserved

Materials and specifications are subject to change without notice. Featured machines in photos may include additional equipment. See your Cat dealer for available options.

CAT, CATERPILLAR, LET'S DO THE WORK, their respective logos, "Caterpillar Corporate Yellow," the "Power Edge" and Cat "Modern Hex" trade dress as well as corporate and product identity used herein, are trademarks of Caterpillar and may not be used without permission. VisionLink is a trademark of Caterpillar Inc., registered in the United States and in other countries.

AEXQ3029-03 (01-2024)
Replaces AEXQ3029-02
Build Number: 07E
(N Am)

