



317

Hydraulic Excavator

Technical Specifications

Configurations and features may vary by region. Please consult your Cat® dealer for availability in your area.

Table of Contents

Specifications	2
Engine	2
Swing Mechanism	2
Weights	2
Track	2
Drive	2
Hydraulic System	2
Service Refill Capacities	2
Standards	2
Sound Performance	2
Operating Weights and Ground Pressures	3
Major Component Weights	4
Dimensions	5
Working Ranges and Forces	7
Blade Working Ranges	8
Reach Boom Lift Capacities – Counterweight: 3.25 mt (7,165 lb):	
Without Blade	9
With Blade Up	21
Reach Boom Lift Capacities – Counterweight: 3.77 mt (8,311 lb):	
Without Blade	15
With Blade Up	27
Bucket Specifications and Compatibility	33
Attachments Offering Guide	35
Standard and Optional Equipment	40
Dealer Installed Kits and Attachments	42
317 Environmental Declaration	43

317 Hydraulic Excavator Specifications

Engine

Engine Model	Cat® C3.6	
Net Power		
ISO 9249	98.9 kW	133 hp
ISO 9249 (DIN)	134 hp (metric)	
Engine Power		
ISO 14396	100 kW	134 hp
ISO 14396 (DIN)	136 hp (metric)	
Bore	98 mm	4 in
Stroke	120 mm	5 in
Displacement	3.6 L	220 in ³
Biodiesel Capability	Up to B20 ⁽¹⁾	

- Meets U.S. EPA Tier 4 Final, EU Stage V, and Japan 2014 emission standards.
- No engine power derate required below 3000 m (9,840 ft) altitude.
- Advertised power is tested per the specified standard in effect at the time of manufacture.
- Net power advertised is the power available at the flywheel when the engine is equipped with fan, air intake system, exhaust system and alternator.
- Engine speed at 2,200 rpm.

⁽¹⁾Cat diesel engines are required to use ULSD (ultra-low sulfur diesel fuel with 15 ppm of sulfur or less) or ULSD blended with the following lower-carbon intensity fuels** up to:

- ✓ 20% biodiesel FAME (fatty acid methyl ester)*
- ✓ 100% renewable diesel, HVO (hydrotreated vegetable oil) and GTL (gas-to-liquid) fuels

Refer to guidelines for successful application. Please consult your Cat dealer or “Caterpillar Machine Fluids Recommendations” (SEBU6250) for details.

**Engines with no aftertreatment devices can use higher blends, up to 100% biodiesel (for use of blends higher than 20% biodiesel, consult your Cat dealer).*

***Tailpipe greenhouse gas emissions from lower-carbon intensity fuels are essentially the same as traditional fuels.*

Swing Mechanism

Swing Speed	8.7 rpm	
Maximum Swing Torque	64.6 kN·m	47,647 lbf·ft

Weights

Operating Weight	18 200 kg	40,200 lb
------------------	-----------	-----------

- Long undercarriage, Reach boom, R3.1 (10'2") stick, GD 0.76 m³ (0.99 yd³) bucket, 700 mm (28") triple grouser shoes and 3.77 mt (8,311 lb) counterweight.

Track

Standard Track Shoes Width	700 mm	28 in
Optional Track Shoes Width	600 mm	24 in
Number of Shoes (each side)	44	
Number of Track Rollers (each side)	7	
Number of Carrier Rollers (each side)	2	

Drive

Gradeability	35°/70%	
Maximum Travel Speed	5.3 km/h	3.3 mph
Maximum Drawbar Pull	157 kN	35,295 lbf

Hydraulic System

Main System – Maximum Flow – Implement	296 L/min	78 gal/min
Maximum Pressure – Equipment	35 000 kPa	5,075 psi
Maximum Pressure – Travel	35 000 kPa	5,075 psi
Maximum Pressure – Swing	25 800 kPa	3,741 psi
Boom Cylinder – Bore	110 mm	4.3 in
Boom Cylinder – Stroke	1193 mm	47.0 in
Stick Cylinder – Bore	120 mm	4.7 in
Stick Cylinder – Stroke	1331 mm	52.4 in
Bucket Cylinder – Bore	105 mm	4.1 in
Bucket Cylinder – Stroke	1039 mm	40.9 in

Service Refill Capacities

Fuel Tank Capacity	271 L	71.6 gal
Cooling System	22 L	5.8 gal
Engine Oil	11 L	2.9 gal
Final Drive (each)	6 L	1.6 gal
Hydraulic System (including tank)	94 L	24.8 gal
Hydraulic Tank	87 L	23.0 gal
Diesel Exhaust Fluid (DEF) Tank	22 L	5.9 gal

Standards

Brakes	ISO 10265:2008
Cab/Rollover Protective Structure (ROPS)	ISO 12117-2:2008
Cab/Operator Protective Guards (OPG) (optional)	ISO 10262:1998 (Level II)

Sound Performance

ISO 6395:2008 (external)	101 dB(A)
ISO 6396:2008 (inside cab)	72 dB(A)

- Hearing protection may be needed when operating with an open operator station and cab (when not properly maintained or doors/windows open) for extended periods or in a noisy environment.

317 Hydraulic Excavator Specifications

Operating Weights and Ground Pressures

Base Machine Configurations	600 mm (24") Triple Grouser Shoes		600 mm (24") Rubber Track Shoes		700 mm (28") Triple Grouser Shoes	
	Weight	Ground Pressure	Weight	Ground Pressure	Weight	Ground Pressure
Base machine with 3.25 mt (7,165 lb) Counterweight and Long Undercarriage	kg (lb)	kPa (psi)	kg (lb)	kPa (psi)	kg (lb)	kPa (psi)
Reach Boom + R2.6 m (8'6") Stick + 0.76 m ³ (0.99 yd ³) GD Bucket	17 400 (38,400)	41.2 (6.0)	17 800 (39,200)	42.1 (6.1)	17 600 (38,900)	35.8 (5.2)
Reach Boom + R2.9 m (9'6") Stick + 0.76 m ³ (0.99 yd ³) GD Bucket	17 500 (38,500)	41.4 (6.0)	17 800 (39,300)	42.3 (6.1)	17 700 (39,000)	35.9 (5.2)
Reach Boom + R2.6 m (8'6") Stick + 0.76 m ³ (0.99 yd ³) GD Bucket + Blade	18 300 (40,300)	43.3 (6.3)	18 600 (41,100)	44.1 (6.4)	18 500 (40,800)	37.6 (5.5)
Reach Boom + R2.9 m (9'6") Thumb Ready Stick + 0.76 m ³ (0.99 yd ³) GD Bucket	17 600 (38,800)	41.6 (6.0)	18 000 (39,600)	42.5 (6.2)	17 800 (39,300)	36.2 (5.3)
Reach Boom + R3.1 m (10'2") Stick + 0.76 m ³ (0.99 yd ³) GD Bucket	17 500 (38,500)	41.4 (6.0)	17 900 (39,400)	42.3 (6.1)	17 700 (39,100)	36.0 (5.2)
Reach Boom + R3.1 m (10'2") Stick + 0.76 m ³ (0.99 yd ³) GD Bucket + Blade	18 300 (40,400)	43.4 (6.3)	18 700 (41,200)	44.3 (6.4)	18 600 (41,000)	37.7 (5.5)
Base machine with 3.77 mt (8,311 lb) Counterweight and Long Undercarriage						
Reach Boom + R2.6 m (8'6") Stick + 0.76 m ³ (0.99 yd ³) GD Bucket	17 900 (39,500)	42.4 (6.1)	18 300 (40,300)	43.3 (6.3)	18 200 (40,000)	36.9 (5.4)
Reach Boom + R2.9 m (9'6") Stick + 0.76 m ³ (0.99 yd ³) GD Bucket	18 000 (39,700)	42.6 (6.2)	18 400 (40,500)	43.5 (6.3)	18 200 (40,200)	37.0 (5.4)
Reach Boom + R2.9 m (9'6") Stick + 0.76 m ³ (0.99 yd ³) GD Bucket + Blade	19 000 (41,800)	44.9 (6.5)	19 300 (42,600)	45.8 (6.6)	19 200 (42,300)	39.0 (5.7)
Reach Boom + R2.9 m (9'6") Thumb Ready Stick + 0.76 m ³ (0.99 yd ³) GD Bucket	18 100 (39,900)	42.8 (6.2)	18 500 (40,700)	43.7 (6.3)	18 300 (40,400)	37.2 (5.4)
Reach Boom + R3.1 m (10'2") Stick + 0.76 m ³ (0.99 yd ³) GD Bucket	18 000 (39,700)	42.6 (6.2)	18 400 (40,500)	43.5 (6.3)	18 200 (40,200)	37.0 (5.4)
Reach Boom + R3.1 m (10'2") Stick + 0.76 m ³ (0.99 yd ³) GD Bucket + Blade	18 900 (41,600)	44.7 (6.5)	19 200 (42,400)	45.5 (6.6)	19 100 (42,100)	38.8 (5.6)

All operating weights include a 90% fuel tank with 75 kg (165 lb) operator.

317 Hydraulic Excavator Specifications

Major Component Weights

	kg	lb
Base Machine (with counterweight, upper frame, long undercarriage – does not include boom, stick, bucket, boom cylinders, stick cylinder, bucket cylinders, tracks, 90% fuel tank and 75 kg [165 lb] operator).		
With 3.25 mt (7,165 lb) Counterweight	11 680	25,750
With 3.77 mt (8,311 lb) Counterweight	12 200	26,900
Track Shoes:		
600 mm (24") Triple Grouser Track Shoes	2340	5,160
600 mm (24") Rubber Track Shoes	2710	5,980
700 mm (28") Triple Grouser Track Shoes with Additional Steps	2580	5,680
Two Boom Cylinders	300	670
Weight of 90% Fuel Tank and 75 kg (165 lb) Operator	300	660
Counterweights:		
3.25 mt (7,165 lb) Counterweight	3250	7,165
3.77 mt (8,311 lb) Counterweight	3770	8,311
Swing Frame	1700	3,760
Undercarriage:		
Base Frame with Long Undercarriage	3900	8,600
Boom (including lines, pins, stick cylinder):		
Reach Boom 5.1 m (16'9")	1320	2,910
Sticks (including lines, pins, bucket cylinder, bucket linkage):		
Reach Stick R2.6 (8'6")	810	1,780
Reach Stick R2.9 m (9'6")	880	1,930
Thumb Ready Stick R2.9 m (9'6")	980	2,160
Reach Stick R3.1 m (10'2")	880	1,940
Buckets (without linkage):		
0.62 m ³ (0.81 yd ³) GD Bucket	740	1,630
0.76 m ³ (0.99 yd ³) GD Bucket	640	1,410
0.91 m ³ (1.19 yd ³) GD Bucket	730	1,600
0.62 m ³ (0.81 yd ³) SD Bucket	680	1,510
0.76 m ³ (0.99 yd ³) SD Bucket	740	1,630
0.91 m ³ (1.19 yd ³) SD Bucket	820	1,800
Quick Coupler:		
Pin Grabber Quick Coupler	260	580

317 Hydraulic Excavator Specifications

Dimensions

All dimensions are approximate and may vary depending on bucket selection.

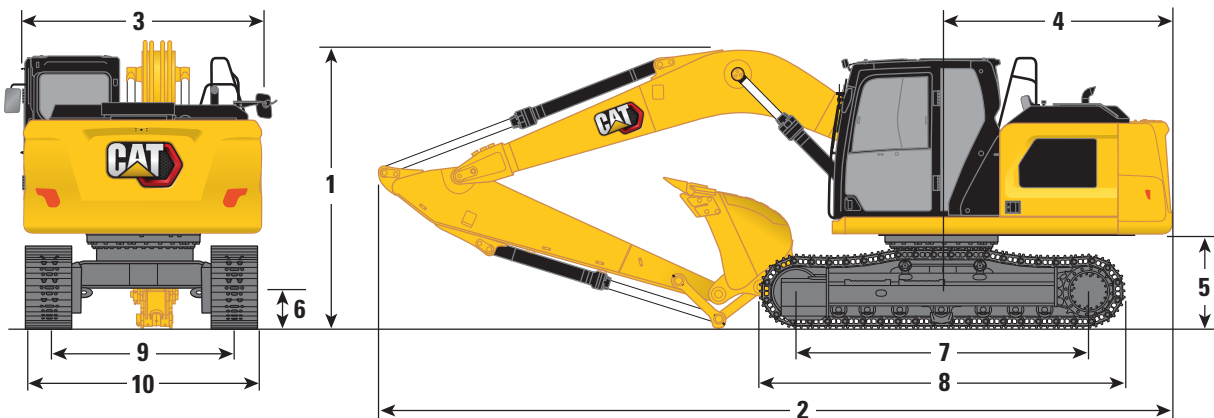

Boom Option

Reach Boom 5.1 m (16'9")

Stick Options

Reach Stick R2.6 (8'6")

Reach Stick R2.9 (9'6")

Thumb Ready Stick R2.9 (9'6")

Reach Stick R3.1 (10'2")

1 Machine Height (without rubber track shoes):

Top of Cab Height	2930 mm	9'7"	2930 mm	9'7"	2930 mm	9'7"	2930 mm	9'7"
Top of OPG Height	3070 mm	10'1"	3070 mm	10'1"	3070 mm	10'1"	3070 mm	10'1"
Handrail Height	2940 mm	9'8"	2940 mm	9'8"	2940 mm	9'8"	2940 mm	9'8"
With Boom/Stick/Bucket Installed (with stick cylinder lines)	2980 mm	9'9"	3030 mm	9'11"	3030 mm	9'11"	3120 mm	10'3"
With Boom/Stick Installed (with stick cylinder lines)	2870 mm	9'5"	2910 mm	9'7"	2910 mm	9'7"	2970 mm	9'9"
With Boom Installed (with stick cylinder lines)	2460 mm	8'1"	2460 mm	8'1"	2460 mm	8'1"	2460 mm	8'1"

Machine Height (with rubber track shoes):

Top of Cab Height	2980 mm	9'9"	2980 mm	9'9"	2980 mm	9'9"	2980 mm	9'9"
Top of OPG Height	3120 mm	10'3"	3120 mm	10'3"	3120 mm	10'3"	3120 mm	10'3"
Handrails Height	3000 mm	9'10"	3000 mm	9'10"	3000 mm	9'10"	3000 mm	9'10"
With Boom/Stick/Bucket Installed (with stick cylinder lines)	3040 mm	10'0"	3040 mm	10'0"	3040 mm	10'0"	3040 mm	10'0"
With Boom/Stick Installed (with stick cylinder lines)	2930 mm	9'7"	2970 mm	9'9"	2970 mm	9'9"	3030 mm	9'11"
With Boom Installed (with stick cylinder lines)	2520 mm	8'3"	2520 mm	8'3"	2520 mm	8'3"	2520 mm	8'3"

2 Machine Length (without Blade):

With Boom/Stick/Bucket Installed (with stick cylinder lines)	8550 mm	28'1"	8570 mm	28'1"	8570 mm	28'1"	8570 mm	28'1"
With Boom/Stick Installed (with stick cylinder lines)	8520 mm	27'11"	8550 mm	28'1"	8550 mm	28'1"	8560 mm	28'1"
With Boom Installed (with stick cylinder lines)	7560 mm	24'10"	7560 mm	24'10"	7560 mm	24'10"	7560 mm	24'10"

Bucket Type	GD		GD		GD		GD	
Bucket Capacity	1.00 m ³	1.31 yd ³	0.76 m ³	0.99 yd ³	0.76 m ³	0.99 yd ³	1.00 m ³	1.31 yd ³
Bucket Tip Radius	1390 mm	4'7"	1390 mm	4'7"	1390 mm	4'7"	1390 mm	4'7"

317 Hydraulic Excavator Specifications

Dimensions

All dimensions are approximate and may vary depending on bucket selection.

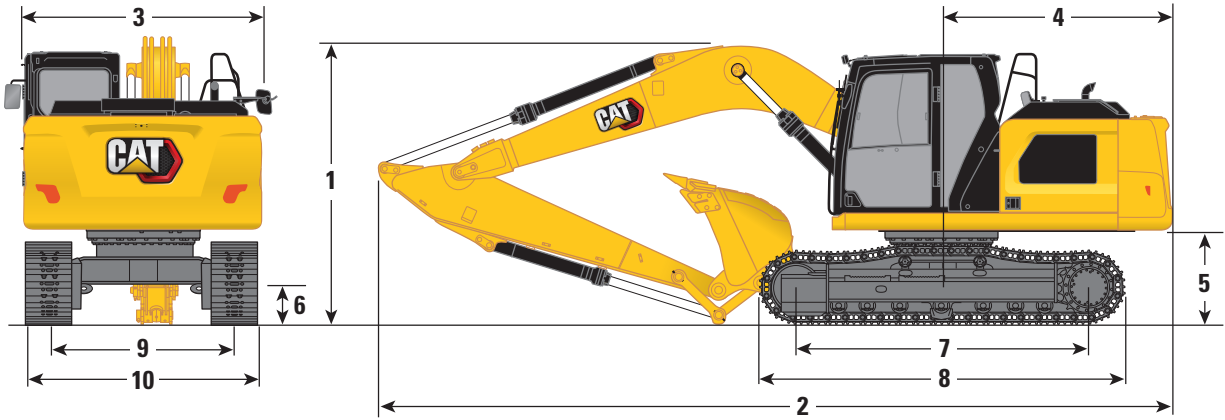

Boom Option	Reach Boom 5.1 m (16'9")							
Stick Options	Reach Stick R2.6 (8'6")		Reach Stick R2.9 (9'6")		Thumb Ready Stick R2.9 (9'6")		Reach Stick R3.1 (10'2")	
2 Machine Length (with Blade, Blade Rear):								
With Boom/Stick/Bucket Installed (with stick cylinder lines)	8590 mm	28'2"	8610 mm	28'3"	8610 mm	28'3"	8620 mm	28'3"
With Boom/Stick Installed (with stick cylinder lines)	8570 mm	28'1"	8590 mm	28'2"	8590 mm	28'2"	8610 mm	28'3"
With Boom Installed (with stick cylinder lines)	7600 mm	24'11"	7600 mm	24'11"	7600 mm	24'11"	7600 mm	24'11"
3 Upperframe Width	2540 mm	8'4"	2540 mm	8'4"	2540 mm	8'4"	2540 mm	8'4"
4 Tail Swing Radius:								
3.25 mt (7,165 lb) Counterweight	2500 mm	8'2"	2500 mm	8'2"	2500 mm	8'2"	2500 mm	8'2"
3.77 mt (8,311 lb) Counterweight	2500 mm	8'2"	2500 mm	8'2"	2500 mm	8'2"	2500 mm	8'2"
5 Counterweight Clearance	1010 mm	3'4"	1010 mm	3'4"	1010 mm	3'4"	1010 mm	3'4"
6 Ground Clearance	430 mm	1'5"	430 mm	1'5"	430 mm	1'5"	430 mm	1'5"
7 Length to Center of Rollers	3170 mm	10'5"	3170 mm	10'5"	3170 mm	10'5"	3170 mm	10'5"
8 Track Length	3970 mm	13'0"	3970 mm	13'0"	3970 mm	13'0"	3970 mm	13'0"
9 Track Gauge	1990 mm	6'6"	1990 mm	6'6"	1990 mm	6'6"	1990 mm	6'6"
10 Undercarriage Width:								
600 mm (24") Shoes	2590 mm	8'6"	2590 mm	8'6"	2590 mm	8'6"	2590 mm	8'6"
700 mm (28") Shoes (with steps)	2690 mm	8'10"	2690 mm	8'10"	2690 mm	8'10"	2690 mm	8'10"
Bucket Type	GD		GD		GD		GD	
Bucket Capacity	1.00 m ³	1.31 yd ³	0.76 m ³	0.99 yd ³	0.76 m ³	0.99 yd ³	1.00 m ³	1.31 yd ³
Bucket Tip Radius	1390 mm	4'7"	1390 mm	4'7"	1390 mm	4'7"	1390 mm	4'7"

317 Hydraulic Excavator Specifications

Working Ranges and Forces

All dimensions are approximate and may vary depending on bucket selection.

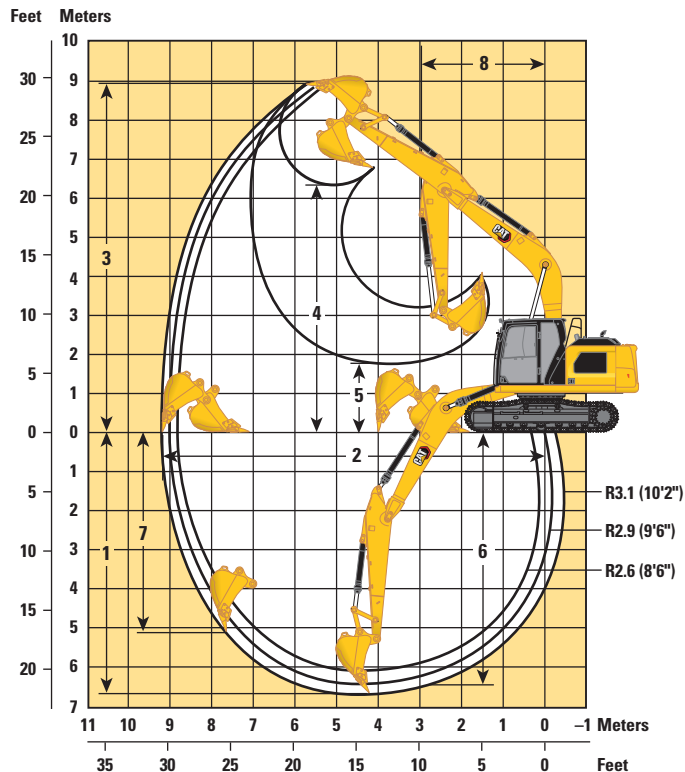

Boom Option

Reach Boom 5.1 m (16'9")

Stick Options	Reach Stick R2.6 (8'6")		Reach Stick R2.9 (9'6")		Thumb Ready Stick R2.9 (9'6")		Reach Stick R3.1 (10'2")	
1 Maximum Digging Depth	6100 mm	20'0"	6400 mm	21'0"	6400 mm	21'0"	6600 mm	21'8"
2 Maximum Reach at Ground Line	8790 mm	28'10"	9010 mm	29'7"	9010 mm	29'7"	9200 mm	30'2"
3 Maximum Cutting Height	8940 mm	29'4"	8900 mm	29'2"	8940 mm	29'4"	8990 mm	29'6"
4 Maximum Loading Height	6270 mm	20'7"	6280 mm	20'7"	6270 mm	20'7"	6370 mm	20'11"
5 Minimum Loading Height	2290 mm	7'6"	1990 mm	6'6"	2290 mm	7'6"	1790 mm	5'10"
6 Maximum Depth Cut for 2440 mm (8'0") Level Bottom	5880 mm	19'3"	6170 mm	20'3"	5880 mm	19'3"	6380 mm	20'11"
7 Maximum Vertical Wall Digging Depth	4980 mm	16'4"	4960 mm	16'3"	4980 mm	16'4"	5150 mm	16'11"
8 Minimum Working Equipment Radius	2980 mm	9'9"	2940 mm	9'8"	2940 mm	9'8"	2930 mm	9'7"
Bucket Digging Force (ISO)	123 kN	27,650 lbf	123 kN	27,650 lbf	123 kN	27,650 lbf	123 kN	27,650 lbf
Stick Digging Force (ISO)	80 kN	17,980 lbf	75 kN	16,860 lbf	75 kN	16,860 lbf	71 kN	15,960 lbf
Bucket Type	GD		GD		GD		GD	
Bucket Capacity	1.00 m ³	1.31 yd ³	0.76 m ³	0.99 yd ³	0.76 m ³	0.99 yd ³	1.00 m ³	1.31 yd ³
Bucket Tip Radius	1390 mm	4'7"	1390 mm	4'7"	1390 mm	4'7"	1390 mm	4'7"

317 Hydraulic Excavator Specifications

Blade Working Ranges

All dimensions are approximate and may vary depending on bucket selection.

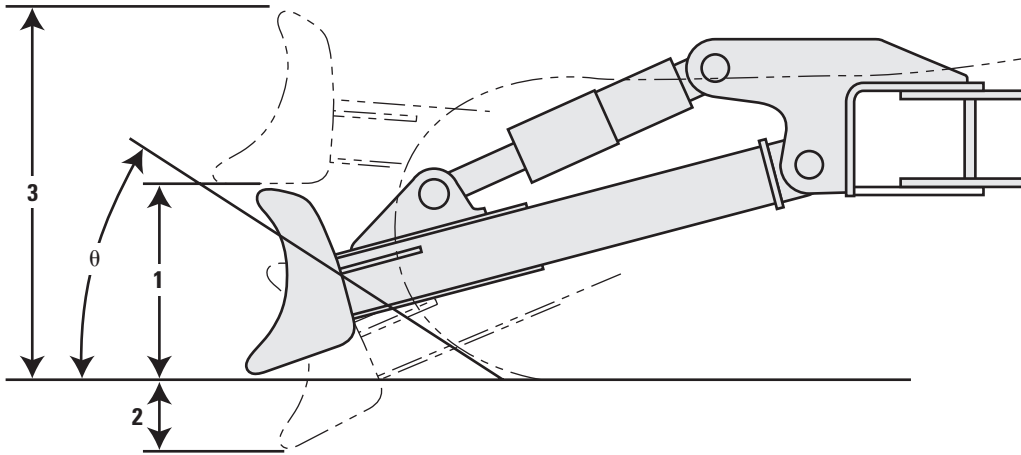

Blade Working Ranges Blade Options	Blade			
	2600 mm (8'6")		2700 mm (8'10")	
1 Blade Height	614 mm	2'0"	614 mm	2'0"
2 Maximum Lowering Depth from Ground	518 mm	1'8"	518 mm	1'8"
3 Maximum Raising Height above Ground	976 mm	3'2"	976 mm	3'2"
θ Approach Angle	23.5°		23.5°	

317 Hydraulic Excavator Specifications

Reach Boom Lift Capacities – Counterweight: 3.25 mt (7,165 lb) – without Bucket

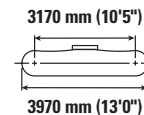
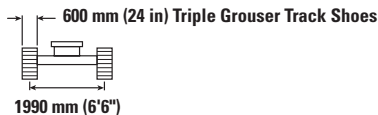
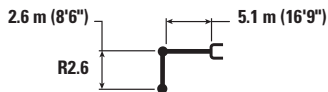

		1500 mm/5'0"		3000 mm/10'0"		4500 mm/15'0"		6000 mm/20'0"		7500 mm/25'0"		mm ft/in		
7500 mm 25'0"	kg lb					*7,700	*7,700					*3350 *7,450	*3350 *7,450	4770 15'1"
6000 mm 20'0"	kg lb							*3600 *6,650	3450 *6,650			*2950 *6,450	*2950 *6,450	6190 20'0"
4500 mm 15'0"	kg lb					*4650 *10,050	*4650 *10,050	*4300 *9,450	3400 7,350			*2850 *6,200	2650 5,900	7020 22'10"
3000 mm 10'0"	kg lb			*8900 *18,900	*8900 *18,900	*5900 *12,700	5000 10,750	*4850 *10,500	3300 7,050			*2900 *6,300	2350 5,200	7450 24'4"
1500 mm 5'0"	kg lb					*7250 *15,600	4650 10,050	5050 10,850	3150 6,750	*3500	2300	*3050 *6,750	2250 4,950	7560 24'9"
0 mm 0'0"	kg lb			*6200 *14,200	*6200 *14,200	7600 16,250	4450 9,600	4900 10,550	3050 6,500			*3450 *7,600	2300 5,050	7370 24'2"
-1500 mm -5'0"	kg lb	*5650 *12,650	*5650 *12,650	*10 050 *22,950	8050 17,200	7500 16,100	4400 9,450	4850 10,450	3000 6,400			4050 8,950	2500 5,550	6850 22'4"
-3000 mm -10'0"	kg lb	*9900 *22,300	*9900 *22,300	*10 750 *23,250	8150 17,500	*7450 *16,050	4450 9,550					5050 11,250	3100 6,900	5900 19'2"
-4500 mm -15'0"	kg lb			*7750 *16,400	*7750 *16,400							*5450 *11,900	5050 11,600	4240 13'6"

Reach Boom Lift Capacities – Counterweight: 3.25 mt (7,165 lb) – without Bucket

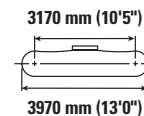
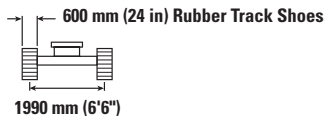
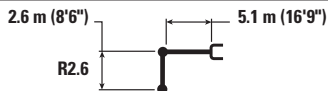

		1500 mm/5'0"		3000 mm/10'0"		4500 mm/15'0"		6000 mm/20'0"		7500 mm/25'0"		mm ft/in		
7500 mm 25'0"	kg lb					*7,700	*7,700					*3350 *7,450	*3350 *7,450	4770 15'1"
6000 mm 20'0"	kg lb							*3600 *6,650	3550 *6,650			*2950 *6,450	*2950 *6,450	6190 20'0"
4500 mm 15'0"	kg lb					*4650 *10,050	*4650 *10,050	*4300 *9,450	3500 7,450			*2850 *6,200	2700 6,000	7020 22'10"
3000 mm 10'0"	kg lb			*8900 *18,900	*8900 *18,900	*5900 *12,700	5100 10,950	*4850 *10,500	3350 7,200			*2900 *6,300	2400 5,300	7450 24'4"
1500 mm 5'0"	kg lb					*7250 *15,600	4750 10,200	5150 11,050	3200 6,900	*3500	2350	*3050 *6,750	2300 5,050	7560 24'9"
0 mm 0'0"	kg lb			*6200 *14,200	*6200 *14,200	7750 16,600	4550 9,750	5000 10,800	3100 6,650			*3450 *7,600	2350 5,150	7370 24'2"
-1500 mm -5'0"	kg lb	*5650 *12,650	*5650 *12,650	*10 050 *22,950	8200 17,550	7650 16,400	4450 9,600	4950 10,700	3050 6,550			4150 9,150	2550 5,650	6850 22'4"
-3000 mm -10'0"	kg lb	*9900 *22,300	*9900 *22,300	*10 750 *23,250	8300 17,850	*7450 *16,050	4500 9,750					5150 11,450	3150 7,050	5900 19'2"
-4500 mm -15'0"	kg lb			*7750 *16,400	*7750 *16,400							*5450 *11,900	5150 11,800	4240 13'6"



ISO 10567:2007



* Indicates that the load is limited by hydraulic lifting capacity rather than tipping load. The above loads are in compliance with hydraulic excavator lift capacity standard ISO 10567:2007. They do not exceed 87% of hydraulic lifting capacity or 75% of tipping load. Weight of all lifting accessories must be deducted from the above lifting capacities. Lifting capacities are based on the machine standing on a firm, uniform supporting surface. The use of a work tool attachment point to handle/lift objects, could affect the machine lift performance.

Lift capacity stays with ±5% for all available track shoes.

Always refer to the appropriate Operation and Maintenance Manual for specific product information.

317 Hydraulic Excavator Specifications

Reach Boom Lift Capacities – Counterweight: 3.25 mt (7,165 lb) – without Bucket

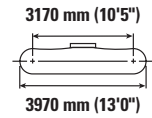
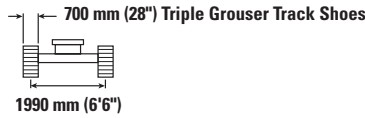
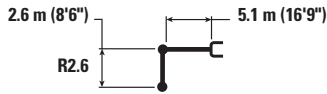

		1500 mm/5'0"		3000 mm/10'0"		4500 mm/15'0"		6000 mm/20'0"		7500 mm/25'0"		mm ft/in		
7500 mm 25'0"	kg lb					*7,700	*7,700					*3350 *7,450	*3350 *7,450	4770 15'1"
6000 mm 20'0"	kg lb							*3600 *6,650	3500 *6,650			*2950 *6,450	*2950 *6,450	6190 20'0"
4500 mm 15'0"	kg lb					*4650 *10,050	*4650 *10,050	*4300 *9,450	3450 7,400			*2850 *6,200	2700 5,950	7020 22'10"
3000 mm 10'0"	kg lb			*8900 *18,900	*8900 *18,900	*5900 *12,700	5050 10,850	*4850 *10,500	3350 7,150			*2900 *6,300	2400 5,250	7450 24'4"
1500 mm 5'0"	kg lb					*7250 *15,600	4700 10,150	5100 11,000	3200 6,850	*3500 2300		*3050 *6,750	2300 5,000	7560 24'9"
0 mm 0'0"	kg lb			*6200 *14,200	*6200 *14,200	7650 16,450	4500 9,700	5000 10,700	3050 6,600			*3450 *7,600	2350 5,100	7370 24'2"
-1500 mm -5'0"	kg lb	*5650 *12,650	*5650 *12,650	*10 050 *22,950	8150 17,450	7600 16,300	4450 9,550	4950 10,600	3000 6,500			4100 9,050	2550 5,600	6850 22'4"
-3000 mm -10'0"	kg lb	*9900 *22,300	*9900 *22,300	*10 750 *23,250	8250 17,700	*7450 *16,050	4500 9,650					5150 11,400	3150 7,000	5900 19'2"
-4500 mm -15'0"	kg lb			*7750 *16,400	*7750 *16,400							*5450 *11,900	5100 11,750	4240 13'6"

Reach Boom Lift Capacities – Counterweight: 3.25 mt (7,165 lb) – without Bucket

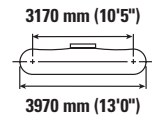
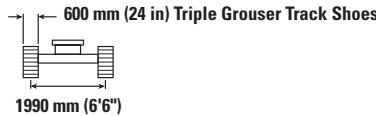
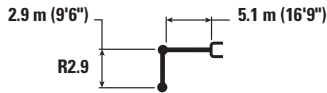

		1500 mm/5'0"		3000 mm/10'0"		4500 mm/15'0"		6000 mm/20'0"		7500 mm/25'0"		mm ft/in		
7500 mm 25'0"	kg lb											*2950 *6,600	*2950 *6,600	5100 16'2"
6000 mm 20'0"	kg lb							*3650 *7,450	3500 *7,450			*2650 *5,900	*2650 *5,900	6450 20'11"
4500 mm 15'0"	kg lb							*4050 *8,850	3450 7,350			*2600 *5,700	2500 5,600	7240 23'7"
3000 mm 10'0"	kg lb			*8000 *17,050	*8000 *17,050	*5550 *11,950	5000 10,800	*4600 *10,000	3300 7,050	*3350 *6,200	2350 5,000	*2700 *5,850	2250 4,950	7660 25'1"
1500 mm 5'0"	kg lb			*6950 *16,650	*6950 *16,650	*6950 *14,950	4650 10,050	5050 10,800	3150 6,700	3600 7,750	2250 4,850	*2900 *6,300	2150 4,700	7780 25'5"
0 mm 0'0"	kg lb			*6950 *15,950	*6950 *15,950	7550 16,200	4450 9,550	4900 10,500	3000 6,450	3550 2200		*3250 *7,150	2200 4,750	7590 24'10"
-1500 mm -5'0"	kg lb	*5650 *12,550	*5650 *12,550	*10 000 *22,750	7950 17,000	7450 15,950	4350 9,300	4850 10,350	2950 6,300			3850 8,450	2350 5,200	7080 23'2"
-3000 mm -10'0"	kg lb	*9250 *20,750	*9250 *20,750	*11 150 *24,050	8050 17,250	7450 16,050	4350 9,400	4850 10,450	2950 6,400			4700 10,400	2850 6,350	6160 20'1"
-4500 mm -15'0"	kg lb			*8550 *18,200	8300 17,850	*5750	4550					*5550 *12,200	4400 10,000	4610 14'9"



ISO 10567:2007



* Indicates that the load is limited by hydraulic lifting capacity rather than tipping load. The above loads are in compliance with hydraulic excavator lift capacity standard ISO 10567:2007. They do not exceed 87% of hydraulic lifting capacity or 75% of tipping load. Weight of all lifting accessories must be deducted from the above lifting capacities. Lifting capacities are based on the machine standing on a firm, uniform supporting surface. The use of a work tool attachment point to handle/lift objects, could affect the machine lift performance.

Lift capacity stays with ±5% for all available track shoes.

Always refer to the appropriate Operation and Maintenance Manual for specific product information.

317 Hydraulic Excavator Specifications

Reach Boom Lift Capacities – Counterweight: 3.25 mt (7,165 lb) – without Bucket

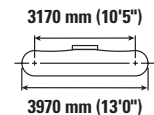
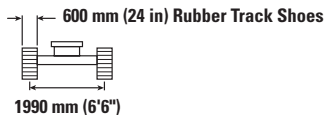
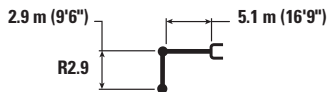

Reach Boom mm ft/in	1500 mm/5'0"		3000 mm/10'0"		4500 mm/15'0"		6000 mm/20'0"		7500 mm/25'0"		mm ft/in		
	kg lb	kg lb	kg lb	kg lb	kg lb	kg lb	kg lb	kg lb	kg lb	kg lb	kg lb	mm ft/in	
7500 mm 25'0"											*2950 *6,600	*2950 *6,600	5100 16'2"
6000 mm 20'0"							*3650 *7,450	3550 *7,450			*2650 *5,900	*2650 *5,900	6450 20'11"
4500 mm 15'0"							*4050 *8,850	3500 7,500			*2600 *5,700	2550 5,700	7240 23'7"
3000 mm 10'0"			*8000 *17,050	*8000 *17,050	*5550 *11,950	5100 11,000	*4600 *10,000	3350 7,200	*3350 *6,200	2400 5,100	*2700 *5,850	2300 5,050	7660 25'1"
1500 mm 5'0"			*6950 *16,650	*6950 *16,650	*6950 *14,950	4750 10,250	5150 11,050	3200 6,850	3700 7,900	2300 4,950	*2900 *6,300	2200 4,800	7780 25'5"
0 mm 0'0"			*6950 *15,950	*6950 *15,950	7700 16,550	4500 9,700	5000 10,750	3050 6,550	3650	2250	*3250 *7,150	2200 4,850	7590 24'10"
-1500 mm -5'0"	kg lb	*5650 *12,550	*5650 *12,550	*10 000 *22,750	8100 17,350	7600 16,300	4400 9,500	4950 10,600	3000 6,450		3900 8,600	2400 5,300	7080 23'2"
-3000 mm -10'0"	kg lb	*9250 *20,750	*9250 *20,750	*11 150 *24,050	8200 17,600	*7600 16,350	4450 9,550	4950 10,700	3050 6,550		4800 10,600	2950 6,500	6160 20'1"
-4500 mm -15'0"	kg lb			*8550 *18,200	8450 18,200	*5750	4650				*5550 *12,200	4500 10,200	4610 14'9"

Reach Boom Lift Capacities – Counterweight: 3.25 mt (7,165 lb) – without Bucket

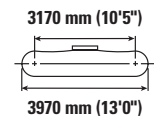
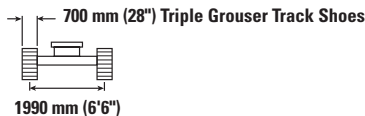
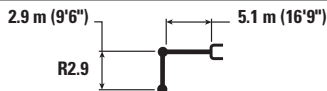

Reach Boom mm ft/in	1500 mm/5'0"		3000 mm/10'0"		4500 mm/15'0"		6000 mm/20'0"		7500 mm/25'0"		mm ft/in		
	kg lb	kg lb	kg lb	kg lb	kg lb	kg lb	kg lb	kg lb	kg lb	kg lb	kg lb	mm ft/in	
7500 mm 25'0"											*2950 *6,600	*2950 *6,600	5100 16'2"
6000 mm 20'0"							*3650 *7,450	3550 *7,450			*2650 *5,900	*2650 *5,900	6450 20'11"
4500 mm 15'0"							*4050 *8,850	3450 7,450			*2600 *5,700	2550 5,650	7240 23'7"
3000 mm 10'0"			*8000 *17,050	*8000 *17,050	*5550 *11,950	5100 10,950	*4600 *10,000	3350 7,150	*3350 *6,200	2350 5,050	*2700 *5,850	2300 5,000	7660 25'1"
1500 mm 5'0"			*6950 *16,650	*6950 *16,650	*6950 *14,950	4700 10,150	5100 10,950	3150 6,800	3650 7,850	2300 4,900	*2900 *6,300	2200 4,750	7780 25'5"
0 mm 0'0"			*6950 *15,950	*6950 *15,950	7650 16,400	4500 9,650	4950 10,650	3050 6,550	3600	2250	*3250 *7,150	2200 4,850	7590 24'10"
-1500 mm -5'0"	kg lb	*5650 *12,550	*5650 *12,550	*10 000 *22,750	8050 17,200	7550 16,200	4400 9,450	4900 10,500	3000 6,400		3900 8,550	2400 5,300	7080 23'2"
-3000 mm -10'0"	kg lb	*9250 *20,750	*9250 *20,750	*11 150 *24,050	8150 17,450	7550 16,250	4400 9,500	4900 10,600	3000 6,500		4750 10,550	2900 6,450	6160 20'1"
-4500 mm -15'0"	kg lb			*8550 *18,200	8400 18,100	*5750	4600				*5550 *12,200	4450 10,150	4610 14'9"



ISO 10567:2007



* Indicates that the load is limited by hydraulic lifting capacity rather than tipping load. The above loads are in compliance with hydraulic excavator lift capacity standard ISO 10567:2007. They do not exceed 87% of hydraulic lifting capacity or 75% of tipping load. Weight of all lifting accessories must be deducted from the above lifting capacities. Lifting capacities are based on the machine standing on a firm, uniform supporting surface. The use of a work tool attachment point to handle/lift objects, could affect the machine lift performance.

Lift capacity stays with ±5% for all available track shoes.

Always refer to the appropriate Operation and Maintenance Manual for specific product information.

317 Hydraulic Excavator Specifications

Reach Boom Lift Capacities – Counterweight: 3.25 mt (7,165 lb) – without Bucket

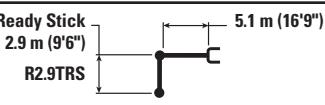



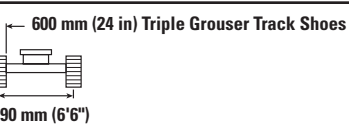



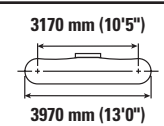





Thumb Ready Stick
2.9 m (9'6")
R2.9TRS



600 mm (24 in) Triple Grouser Track Shoes
1990 mm (6'6")



3170 mm (10'5")
3970 mm (13'0")

		1500 mm/5'0"		3000 mm/10'0"		4500 mm/15'0"		6000 mm/20'0"		7500 mm/25'0"				mm ft/in		
																
7500 mm 25'0"	kg lb													*2900 *6,500	*2900 *6,500	5100 16'2"
6000 mm 20'0"	kg lb							*3600 *7,350	3450 *7,350					*2650 *5,800	*2650 *5,800	6450 20'11"
4500 mm 15'0"	kg lb							*4000 *8,700	3400 7,250					*2550 *5,600	2450 5,450	7240 23'7"
3000 mm 10'0"	kg lb			*7900 *16,850	*7900 *16,850	*5450 *11,750	4950 10,700	*4550 *9,850	3250 6,950	*3300 *6,100	2250 4,850			*2650 *5,750	2200 4,800	7660 25'1"
1500 mm 5'0"	kg lb			*6900 *16,550	*6900 *16,550	*6850 *14,750	4600 9,900	4950 10,700	3050 6,550	3550 7,600	2200 4,700			*2850 *6,200	2100 4,550	7780 25'5"
0 mm 0'0"	kg lb			*6900 *15,850	*6900 *15,850	7450 16,050	4350 9,350	4850 10,350	2950 6,300	3500	2150			*3200 *7,050	2100 4,650	7590 24'10"
-1500 mm -5'0"	kg lb	*5600 *12,500	*5600 *12,500	*9950 *22,650	7800 16,750	7350 15,800	4250 9,150	4750 10,200	2850 6,150					3750 8,300	2300 5,050	7080 23'2"
-3000 mm -10'0"	kg lb	*9200 *20,650	*9200 *20,650	*11 000 *23,800	7900 17,000	7400 15,850	4300 9,200	4800 10,300	2900 6,250					4600 10,250	2800 6,200	6160 20'1"
-4500 mm -15'0"	kg lb			*8450 *18,000	8200 17,650	*5650	4450							*5450 *12,000	4350 9,850	4610 14'9"

Reach Boom Lift Capacities – Counterweight: 3.25 mt (7,165 lb) – without Bucket









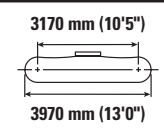





Thumb Ready Stick
2.9 m (9'6")
R2.9TRS



600 mm (24 in) Rubber Track Shoes
1990 mm (6'6")



3170 mm (10'5")
3970 mm (13'0")

		1500 mm/5'0"		3000 mm/10'0"		4500 mm/15'0"		6000 mm/20'0"		7500 mm/25'0"				mm ft/in		
																
7500 mm 25'0"	kg lb													*2900 *6,500	*2900 *6,500	5100 16'2"
6000 mm 20'0"	kg lb							*3600 *7,350	3500 *7,350					*2650 *5,800	*2650 *5,800	6450 20'11"
4500 mm 15'0"	kg lb							*4000 *8,700	3450 7,350					*2550 *5,600	2500 5,550	7240 23'7"
3000 mm 10'0"	kg lb			*7900 *16,850	*7900 *16,850	*5450 *11,750	5050 10,850	*4550 *9,850	3300 7,050	*3300 *6,100	2300 4,950			*2650 *5,750	2250 4,900	7660 25'1"
1500 mm 5'0"	kg lb			*6900 *16,550	*6900 *16,550	*6850 *14,750	4700 10,050	5050 10,900	3100 6,700	3650 7,800	2250 4,800			*2850 *6,200	2150 4,650	7780 25'5"
0 mm 0'0"	kg lb			*6900 *15,850	*6900 *15,850	7600 16,350	4450 9,550	4950 10,600	3000 6,400	3550	2200			*3200 *7,050	2150 4,750	7590 24'10"
-1500 mm -5'0"	kg lb	*5600 *12,500	*5600 *12,500	*9950 *22,650	7950 17,050	7500 16,100	4350 9,300	4850 10,450	2950 6,300					3850 8,500	2350 5,150	7080 23'2"
-3000 mm -10'0"	kg lb	*9200 *20,650	*9200 *20,650	*11 000 *23,800	8100 17,350	*7550 16,200	4350 9,400	4900 10,550	2950 6,400					4700 10,450	2850 6,350	6160 20'1"
-4500 mm -15'0"	kg lb			*8450 *18,000	8350 *18,000	*5650	4550							*5450 *12,000	4400 10,050	4610 14'9"



ISO 10567:2007



* Indicates that the load is limited by hydraulic lifting capacity rather than tipping load. The above loads are in compliance with hydraulic excavator lift capacity standard ISO 10567:2007. They do not exceed 87% of hydraulic lifting capacity or 75% of tipping load. Weight of all lifting accessories must be deducted from the above lifting capacities. Lifting capacities are based on the machine standing on a firm, uniform supporting surface. The use of a work tool attachment point to handle/lift objects, could affect the machine lift performance.

Lift capacity stays with ±5% for all available track shoes.

Always refer to the appropriate Operation and Maintenance Manual for specific product information.

317 Hydraulic Excavator Specifications

Reach Boom Lift Capacities – Counterweight: 3.25 mt (7,165 lb) – without Bucket

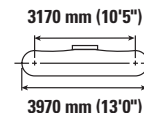
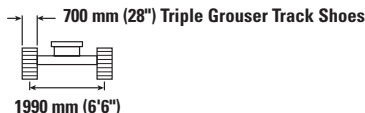

Reach mm ft/in	kg lb	1500 mm/5'0"		3000 mm/10'0"		4500 mm/15'0"		6000 mm/20'0"		7500 mm/25'0"		mm ft/in		
7500 mm 25'0"	kg lb											*2900 *6,500	*2900 *6,500	5100 16'2"
6000 mm 20'0"	kg lb							*3600 *7,350	3500 *7,350			*2650 *5,800	*2650 *5,800	6450 20'11"
4500 mm 15'0"	kg lb							*4000 *8,700	3400 7,300			*2550 *5,600	2500 5,500	7240 23'7"
3000 mm 10'0"	kg lb			*7900 *16,850	*7900 *16,850	*5450 *11,750	5000 10,800	*4550 *9,850	3250 7,000	*3300 *6,100	2300 4,900	*2650 *5,750	2200 4,900	7660 25'1"
1500 mm 5'0"	kg lb			*6900 *16,550	*6900 *16,550	*6850 *14,750	4650 10,000	5050 10,800	3100 6,650	3600 7,750	2250 4,800	*2850 *6,200	2100 4,650	7780 25'5"
0 mm 0'0"	kg lb			*6900 *15,850	*6900 *15,850	7550 16,250	4400 9,450	4900 10,500	2950 6,350	3550 2200		*3200 *7,050	2150 4,700	7590 24'10"
-1500 mm -5'0"	kg lb	*5600 *12,500	*5600 *12,500	*9950 *22,650	7900 16,950	7450 16,000	4300 9,250	4800 10,350	2900 6,250			3800 8,400	2350 5,150	7080 23'2"
-3000 mm -10'0"	kg lb	*9200 *20,650	*9200 *20,650	*11 000 *23,800	8000 17,200	7500 16,050	4350 9,300	4850 10,450	2950 6,350			4700 10,400	2850 6,300	6160 20'1"
-4500 mm -15'0"	kg lb			*8450 *18,000	8300 17,900	*5650 12,450	4550					*5450 *12,000	4400 10,000	4610 14'9"

Reach Boom Lift Capacities – Counterweight: 3.25 mt (7,165 lb) – without Bucket

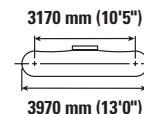
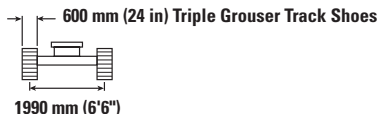

Reach mm ft/in	kg lb	1500 mm/5'0"		3000 mm/10'0"		4500 mm/15'0"		6000 mm/20'0"		7500 mm/25'0"		mm ft/in		
7500 mm 25'0"	kg lb											*2700 *6,050	*2700 *6,050	5380 17'2"
6000 mm 20'0"	kg lb							*3650 *7,550	3500 7,550			*2450 *5,400	*2450 *5,400	6670 21'7"
4500 mm 15'0"	kg lb							*3900 *8,500	3450 7,400			*2400 *5,250	*2400 *5,250	7440 24'3"
3000 mm 10'0"	kg lb			*7500 *15,950	*7500 *15,950	*5300 *11,450	5050 10,900	*4500 *9,700	3300 7,100	*3600 *7,100	2350 5,000	*2450 *5,400	2200 4,800	7850 25'8"
1500 mm 5'0"	kg lb			*8250 *19,750	*8250 18,150	*6750 *14,550	4700 10,150	5050 10,850	3150 6,750	3600 7,800	2250 4,850	*2650 *5,800	2100 4,550	7960 26'1"
0 mm 0'0"	kg lb			*7150 *16,450	*7150 *16,450	7600 16,250	4450 9,550	4900 10,550	3000 6,450	3550 7,650	2200 4,750	*3000 *6,550	2100 4,600	7780 25'5"
-1500 mm -5'0"	kg lb	*5400 *12,050	*5400 *12,050	*9700 *22,100	7900 17,000	7450 16,000	4350 9,300	4800 10,350	2950 6,300			*3600 *7,950	2300 5,000	7280 23'10"
-3000 mm -10'0"	kg lb	*8700 *19,450	*8700 *19,450	*11 400 *24,650	8000 17,200	7450 16,000	4350 9,350	4850 10,400	2950 6,350			4450 9,850	2700 6,000	6400 20'10"
-4500 mm -15'0"	kg lb			*9100 *19,350	8250 17,750	*6150 *12,950	4500 9,700					*5450 *12,000	4000 9,050	4920 15'9"



ISO 10567:2007



* Indicates that the load is limited by hydraulic lifting capacity rather than tipping load. The above loads are in compliance with hydraulic excavator lift capacity standard ISO 10567:2007. They do not exceed 87% of hydraulic lifting capacity or 75% of tipping load. Weight of all lifting accessories must be deducted from the above lifting capacities. Lifting capacities are based on the machine standing on a firm, uniform supporting surface. The use of a work tool attachment point to handle/lift objects, could affect the machine lift performance.

Lift capacity stays with ±5% for all available track shoes.

Always refer to the appropriate Operation and Maintenance Manual for specific product information.

317 Hydraulic Excavator Specifications

Reach Boom Lift Capacities – Counterweight: 3.25 mt (7,165 lb) – without Bucket

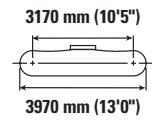
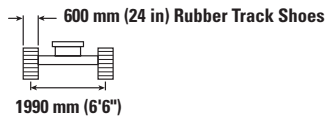
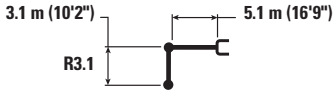

Reach mm ft/in	1500 mm/5'0"		3000 mm/10'0"		4500 mm/15'0"		6000 mm/20'0"		7500 mm/25'0"		mm ft/in		
	kg lb	kg lb	kg lb	kg lb	kg lb	kg lb	kg lb	kg lb	kg lb	kg lb	kg lb	mm ft/in	
7500 mm 25'0"											*2700 *6,050	*2700 *6,050	5380 17'2"
6000 mm 20'0"							*3650 *7,550	3600 7,550			*2450 *5,400	*2450 *5,400	6670 21'7"
4500 mm 15'0"							*3900 *8,500	3500 7,550			*2400 *5,250	*2400 *5,250	7440 24'3"
3000 mm 10'0"			*7500 *15,950	*7500 *15,950	*5300 *11,450	5150 11,100	*4500 *9,700	3350 7,250	*3600 *7,100	2400 5,100	*2450 *5,400	2200 4,900	7850 25'8"
1500 mm 5'0"			*8250 *19,750	*8250 *18,450	*6750 *14,550	4800 10,300	5150 11,100	3200 6,900	3700 7,950	2300 4,950	*2650 *5,800	2100 4,650	7960 26'1"
0 mm 0'0"			*7150 *16,450	*7150 *16,450	7750 16,600	4550 9,750	5000 10,750	3050 6,600	3650 7,800	2250 4,850	*3000 *6,550	2150 4,700	7780 25'5"
-1500 mm -5'0"	kg lb	*5400 *12,050	*5400 *12,050	*9700 *22,100	8100 17,350	7600 16,300	4450 9,500	4900 10,600	3000 6,450		*3600 *7,950	2300 5,100	7280 23'10"
-3000 mm -10'0"	kg lb	*8700 *19,450	*8700 *19,450	*11,400 *24,650	8150 17,500	7600 16,350	4450 9,550	4950 10,650	3000 6,500		4550 10,050	2800 6,150	6400 20'10"
-4500 mm -15'0"	kg lb			*9100 *19,350	8400 18,100	*6150 *12,950	4600 9,900				*5450 *12,000	4100 9,200	4920 15'9"

Reach Boom Lift Capacities – Counterweight: 3.25 mt (7,165 lb) – without Bucket

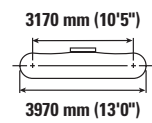
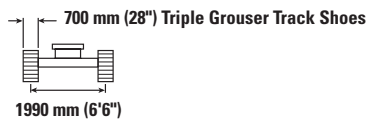

Reach mm ft/in	1500 mm/5'0"		3000 mm/10'0"		4500 mm/15'0"		6000 mm/20'0"		7500 mm/25'0"		mm ft/in		
	kg lb	kg lb	kg lb	kg lb	kg lb	kg lb	kg lb	kg lb	kg lb	kg lb	kg lb	mm ft/in	
7500 mm 25'0"											*2700 *6,050	*2700 *6,050	5380 17'2"
6000 mm 20'0"							*3650 *7,550	3550 *7,550			*2450 *5,400	*2450 *5,400	6670 21'7"
4500 mm 15'0"							*3900 *8,500	3500 7,500			*2400 *5,250	*2400 *5,250	7440 24'3"
3000 mm 10'0"			*7500 *15,950	*7500 *15,950	*5300 *11,450	5150 11,050	*4500 *9,700	3350 7,200	*3600 *7,100	2400 5,100	*2450 *5,400	2200 4,850	7850 25'8"
1500 mm 5'0"			*8250 *19,750	*8250 *18,350	*6750 *14,550	4750 10,250	5100 11,000	3200 6,850	3650 7,900	2300 4,950	*2650 *5,800	2100 4,600	7960 26'1"
0 mm 0'0"			*7150 *16,450	*7150 *16,450	7700 16,500	4500 9,700	4950 10,700	3050 6,550	3600 7,750	2250 4,800	*3000 *6,550	2150 4,650	7780 25'5"
-1500 mm -5'0"	kg lb	*5400 *12,050	*5400 *12,050	*9700 *22,100	8000 17,200	7550 16,200	4400 9,450	4900 10,500	2950 6,400		*3600 *7,950	2300 5,050	7280 23'10"
-3000 mm -10'0"	kg lb	*8700 *19,450	*8700 *19,450	*11,400 *24,650	8100 17,400	7550 16,200	4400 9,450	4900 10,550	3000 6,450		4500 9,950	2750 6,100	6400 20'10"
-4500 mm -15'0"	kg lb			*9100 *19,350	8350 17,950	*6150 *12,950	4550 9,800				*5450 *12,000	4050 9,150	4920 15'9"



ISO 10567:2007



* Indicates that the load is limited by hydraulic lifting capacity rather than tipping load. The above loads are in compliance with hydraulic excavator lift capacity standard ISO 10567:2007. They do not exceed 87% of hydraulic lifting capacity or 75% of tipping load. Weight of all lifting accessories must be deducted from the above lifting capacities. Lifting capacities are based on the machine standing on a firm, uniform supporting surface. The use of a work tool attachment point to handle/lift objects, could affect the machine lift performance.

Lift capacity stays with ±5% for all available track shoes.

Always refer to the appropriate Operation and Maintenance Manual for specific product information.

317 Hydraulic Excavator Specifications

Reach Boom Lift Capacities – Counterweight: 3.77 mt (8,311 lb) – without Bucket

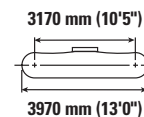
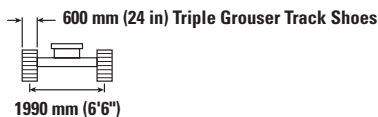

		1500 mm/5'0"		3000 mm/10'0"		4500 mm/15'0"		6000 mm/20'0"		7500 mm/25'0"		mm ft/in		
7500 mm 25'0"	kg lb					*7,700	*7,700					*3350 *7,450	*3350 *7,450	4770 15'1"
6000 mm 20'0"	kg lb							*3600 *6,650	*3600 *6,650			*2950 *6,450	*2950 *6,450	6190 20'0"
4500 mm 15'0"	kg lb					*4650 *10,050	*4650 *10,050	*4300 *9,450	3700 7,900			*2850 *6,200	*2850 *6,200	7020 22'10"
3000 mm 10'0"	kg lb			*8900 *18,900	*8900 *18,900	*5900 *12,700	5350 11,550	*4850 *10,500	3550 7,650			*2900 *6,300	2550 5,650	7450 24'4"
1500 mm 5'0"	kg lb					*7250 *15,600	5050 10,850	5400 11,550	3400 7,300	*3500	2500	*3050 *6,750	2450 5,400	7560 24'9"
0 mm 0'0"	kg lb			*6200 *14,200	*6200 *14,200	*8050 17,350	4850 10,400	5250 11,300	3300 7,050			*3450 *7,600	2500 5,500	7370 24'2"
-1500 mm -5'0"	kg lb	*5650 *12,650	*5650 *12,650	*10 050 *22,950	8700 18,650	8000 17,200	4750 10,250	5200 11,200	3250 6,950			*4200 *9,300	2750 6,050	6850 22'4"
-3000 mm -10'0"	kg lb	*9900 *22,300	*9900 *22,300	*10 750 *23,250	8800 18,950	*7450 *16,050	4800 10,350					*5350 *11,800	3400 7,500	5900 19'2"
-4500 mm -15'0"	kg lb			*7750 *16,400	*7750 *16,400							*5450 *11,900	*5450 *11,900	4240 13'6"

Reach Boom Lift Capacities – Counterweight: 3.77 mt (8,311 lb) – without Bucket

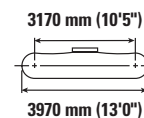
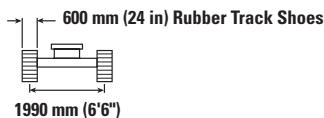

		1500 mm/5'0"		3000 mm/10'0"		4500 mm/15'0"		6000 mm/20'0"		7500 mm/25'0"		mm ft/in		
7500 mm 25'0"	kg lb					*7,700	*7,700					*3350 *7,450	*3350 *7,450	4770 15'1"
6000 mm 20'0"	kg lb							*3600 *6,650	*3600 *6,650			*2950 *6,450	*2950 *6,450	6190 20'0"
4500 mm 15'0"	kg lb					*4650 *10,050	*4650 *10,050	*4300 *9,450	3750 8,050			*2850 *6,200	*2850 *6,200	7020 22'10"
3000 mm 10'0"	kg lb			*8900 *18,900	*8900 *18,900	*5900 *12,700	5450 11,750	*4850 *10,500	3600 7,750			*2900 *6,300	2600 5,750	7450 24'4"
1500 mm 5'0"	kg lb					*7250 *15,600	5100 11,050	*5450 11,800	3450 7,450	*3500	2550	*3050 *6,750	2500 5,500	7560 24'9"
0 mm 0'0"	kg lb			*6200 *14,200	*6200 *14,200	*8050 *17,400	4900 10,600	5350 11,500	3350 7,200			*3450 *7,600	2550 5,600	7370 24'2"
-1500 mm -5'0"	kg lb	*5650 *12,650	*5650 *12,650	*10 050 *22,950	8850 19,000	*8150 17,500	4850 10,450	5300 11,400	3300 7,100			*4200 *9,300	2800 6,150	6850 22'4"
-3000 mm -10'0"	kg lb	*9900 *22,300	*9900 *22,300	*10 750 *23,250	9000 19,250	*7450 *16,050	4900 10,550					*5350 *11,800	3450 7,600	5900 19'2"
-4500 mm -15'0"	kg lb			*7750 *16,400	*7750 *16,400							*5450 *11,900	*5450 *11,900	4240 13'6"



ISO 10567:2007



* Indicates that the load is limited by hydraulic lifting capacity rather than tipping load. The above loads are in compliance with hydraulic excavator lift capacity standard ISO 10567:2007. They do not exceed 87% of hydraulic lifting capacity or 75% of tipping load. Weight of all lifting accessories must be deducted from the above lifting capacities. Lifting capacities are based on the machine standing on a firm, uniform supporting surface. The use of a work tool attachment point to handle/lift objects, could affect the machine lift performance.

Lift capacity stays with ±5% for all available track shoes.

Always refer to the appropriate Operation and Maintenance Manual for specific product information.

317 Hydraulic Excavator Specifications

Reach Boom Lift Capacities – Counterweight: 3.77 mt (8,311 lb) – without Bucket

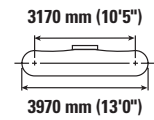
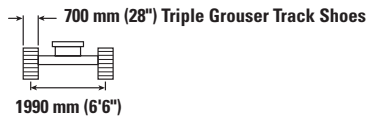
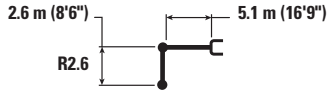

		1500 mm/5'0"		3000 mm/10'0"		4500 mm/15'0"		6000 mm/20'0"		7500 mm/25'0"		mm ft/in		
7500 mm 25'0"	kg lb					*7,700	*7,700					*3350 *7,450	*3350 *7,450	4770 15'1"
6000 mm 20'0"	kg lb							*3600 *6,650	*3600 *6,650			*2950 *6,450	*2950 *6,450	6190 20'0"
4500 mm 15'0"	kg lb					*4650 *10,050	*4650 *10,050	*4300 *9,450	3700 8,000			*2850 *6,200	*2850 *6,200	7020 22'10"
3000 mm 10'0"	kg lb			*8900 *18,900	*8900 *18,900	*5900 *12,700	5400 11,650	*4850 *10,500	3600 7,700			*2900 *6,300	2600 5,700	7450 24'4"
1500 mm 5'0"	kg lb					*7250 *15,600	5100 10,950	5450 11,700	3450 7,400	*3500 2500		*3050 *6,750	2500 5,450	7560 24'9"
0 mm 0'0"	kg lb			*6200 *14,200	*6200 *14,200	*8050 *17,400	4900 10,500	5300 11,450	3350 7,150			*3450 *7,600	2550 5,550	7370 24'2"
-1500 mm -5'0"	kg lb	*5650 *12,650	*5650 *12,650	*10 050 *22,950	8800 18,850	8100 17,400	4800 10,350	5250 11,350	3300 7,050			*4200 *9,300	2800 6,100	6850 22'4"
-3000 mm -10'0"	kg lb	*9900 *22,300	*9900 *22,300	*10 750 *23,250	8900 19,150	*7450 *16,050	4850 10,450					*5350 *11,800	3400 7,550	5900 19'2"
-4500 mm -15'0"	kg lb			*7750 *16,400	*7750 *16,400							*5450 *11,900	*5450 *11,900	4240 13'6"

Reach Boom Lift Capacities – Counterweight: 3.77 mt (8,311 lb) – without Bucket

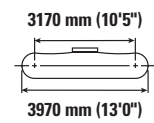
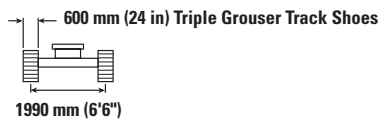

		1500 mm/5'0"		3000 mm/10'0"		4500 mm/15'0"		6000 mm/20'0"		7500 mm/25'0"		mm ft/in		
7500 mm 25'0"	kg lb											*2950 *6,600	*2950 *6,600	5100 16'2"
6000 mm 20'0"	kg lb							*3650 *7,450	*3650 *7,450			*2650 *5,900	*2650 *5,900	6450 20'11"
4500 mm 15'0"	kg lb							*4050 *8,850	3700 7,900			*2600 *5,700	*2600 *5,700	7240 23'7"
3000 mm 10'0"	kg lb			*8000 *17,050	*8000 *17,050	*5550 *11,950	5400 11,600	*4600 *10,000	3550 7,650	*3350 *6,200	2550 5,400	*2700 *5,850	2450 5,400	7660 25'1"
1500 mm 5'0"	kg lb			*6950 *16,650	*6950 *16,650	*6950 *14,950	5050 10,850	*5250 *11,400	3400 7,300	3850 *7,950	2450 5,300	*2900 *6,300	2350 5,150	7780 25'5"
0 mm 0'0"	kg lb			*6950 *15,950	*6950 *15,950	*7850 *17,000	4800 10,350	5250 11,250	3250 7,000	*3800 2400		*3250 *7,150	2350 5,200	7590 24'10"
-1500 mm -5'0"	kg lb	*5650 *12,550	*5650 *12,550	*10 000 *22,750	8600 18,450	7950 17,050	4700 10,100	5150 11,100	3200 6,850			*4000 *8,800	2600 5,700	7080 23'2"
-3000 mm -10'0"	kg lb	*9250 *20,750	*9250 *20,750	*11 150 *24,050	8700 18,650	*7600 *16,450	4750 10,200	5200 11,200	3250 6,950			5000 11,100	3100 6,900	6160 20'1"
-4500 mm -15'0"	kg lb			*8550 *18,200	*8550 *18,200	*5750	4900					*5550 *12,200	4750 10,850	4610 14'9"



ISO 10567:2007



* Indicates that the load is limited by hydraulic lifting capacity rather than tipping load. The above loads are in compliance with hydraulic excavator lift capacity standard ISO 10567:2007. They do not exceed 87% of hydraulic lifting capacity or 75% of tipping load. Weight of all lifting accessories must be deducted from the above lifting capacities. Lifting capacities are based on the machine standing on a firm, uniform supporting surface. The use of a work tool attachment point to handle/lift objects, could affect the machine lift performance.

Lift capacity stays with ±5% for all available track shoes.

Always refer to the appropriate Operation and Maintenance Manual for specific product information.

317 Hydraulic Excavator Specifications

Reach Boom Lift Capacities – Counterweight: 3.77 mt (8,311 lb) – without Bucket

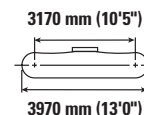
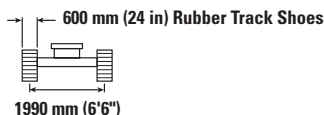

		1500 mm/5'0"		3000 mm/10'0"		4500 mm/15'0"		6000 mm/20'0"		7500 mm/25'0"		mm ft/in		
7500 mm 25'0"	kg lb											*2950 *6,600	*2950 *6,600	5100 16'2"
6000 mm 20'0"	kg lb							*3650 *7,450	*3650 *7,450			*2650 *5,900	*2650 *5,900	6450 20'11"
4500 mm 15'0"	kg lb							*4050 *8,850	3750 8,050			*2600 *5,700	*2600 *5,700	7240 23'7"
3000 mm 10'0"	kg lb			*8000 *17,050	*8000 *17,050	*5550 *11,950	5500 11,800	*4600 *10,000	3600 7,750	*3350 *6,200	2600 5,500	*2700 *5,850	2500 5,500	7660 25'1"
1500 mm 5'0"	kg lb			*6950 *16,650	*6950 *16,650	*6950 *14,950	5150 11,050	*5250 *11,400	3450 7,400	3950 *7,950	2500 5,400	*2900 *6,300	2400 5,200	7780 25'5"
0 mm 0'0"	kg lb			*6950 *15,950	*6950 *15,950	*7850 *17,000	4900 10,500	5350 11,450	3300 7,150	*3800	2450	*3250 *7,150	2400 5,300	7590 24'10"
-1500 mm -5'0"	kg lb	*5650 *12,550	*5650 *12,550	*10 000 *22,750	8750 18,750	8100 17,400	4800 10,300	5250 11,300	3250 7,000			*4000 *8,800	2650 5,800	7080 23'2"
-3000 mm -10'0"	kg lb	*9250 *20,750	*9250 *20,750	*11 150 *24,050	8850 19,000	*7600 *16,450	4800 10,350	5300 11,400	3300 7,100			5100 11,350	3200 7,050	6160 20'1"
-4500 mm -15'0"	kg lb			*8550 *18,200	*8550 *18,200	*5750	5000					*5550 *12,200	4850 11,050	4610 14'9"

Reach Boom Lift Capacities – Counterweight: 3.77 mt (8,311 lb) – without Bucket

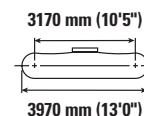
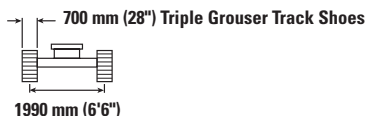

		1500 mm/5'0"		3000 mm/10'0"		4500 mm/15'0"		6000 mm/20'0"		7500 mm/25'0"		mm ft/in		
7500 mm 25'0"	kg lb											*2950 *6,600	*2950 *6,600	5100 16'2"
6000 mm 20'0"	kg lb							*3650 *7,450	*3650 *7,450			*2650 *5,900	*2650 *5,900	6450 20'11"
4500 mm 15'0"	kg lb							*4050 *8,850	3750 8,000			*2600 *5,700	*2600 *5,700	7240 23'7"
3000 mm 10'0"	kg lb			*8000 *17,050	*8000 *17,050	*5550 *11,950	5450 11,750	*4600 *10,000	3600 7,700	*3350 *6,200	2550 5,500	*2700 *5,850	2500 5,450	7660 25'1"
1500 mm 5'0"	kg lb			*6950 *16,650	*6950 *16,650	*6950 *14,950	5100 11,000	*5250 *11,400	3450 7,350	3900 *7,950	2500 5,350	*2900 *6,300	2350 5,200	7780 25'5"
0 mm 0'0"	kg lb			*6950 *15,950	*6950 *15,950	*7850 *17,000	4850 10,450	5300 11,400	3300 7,100	*3800	2450	*3250 *7,150	2400 5,250	7590 24'10"
-1500 mm -5'0"	kg lb	*5650 *12,550	*5650 *12,550	*10 000 *22,750	8700 18,650	8050 17,250	4750 10,250	5250 11,250	3250 6,950			*4000 *8,800	2600 5,750	7080 23'2"
-3000 mm -10'0"	kg lb	*9250 *20,750	*9250 *20,750	*11 150 *24,050	8800 18,900	*7600 *16,450	4800 10,300	5250 11,350	3250 7,050			5050 11,250	3150 7,000	6160 20'1"
-4500 mm -15'0"	kg lb			*8550 *18,200	*8550 *18,200	*5750	4950					*5550 *12,200	4800 10,950	4610 14'9"



ISO 10567:2007



* Indicates that the load is limited by hydraulic lifting capacity rather than tipping load. The above loads are in compliance with hydraulic excavator lift capacity standard ISO 10567:2007. They do not exceed 87% of hydraulic lifting capacity or 75% of tipping load. Weight of all lifting accessories must be deducted from the above lifting capacities. Lifting capacities are based on the machine standing on a firm, uniform supporting surface. The use of a work tool attachment point to handle/lift objects, could affect the machine lift performance.

Lift capacity stays with ±5% for all available track shoes.

Always refer to the appropriate Operation and Maintenance Manual for specific product information.

317 Hydraulic Excavator Specifications

Reach Boom Lift Capacities – Counterweight: 3.77 mt (8,311 lb) – without Bucket

Thumb Ready Stick
2.9 m (9'6")
R2.9TRS

600 mm (24 in) Triple Grouser Track Shoes
1990 mm (6'6")

3170 mm (10'5")
3970 mm (13'0")

		1500 mm/5'0"		3000 mm/10'0"		4500 mm/15'0"		6000 mm/20'0"		7500 mm/25'0"		 mm ft/in		
7500 mm 25'0"	kg lb											*2900 *6,500	*2900 *6,500	5100 16'2"
6000 mm 20'0"	kg lb							*3600 *7,350	*3600 *7,350			*2650 *5,800	*2650 *5,800	6450 20'11"
4500 mm 15'0"	kg lb							*4000 *8,700	3650 7,800			*2550 *5,600	*2550 *5,600	7240 23'7"
3000 mm 10'0"	kg lb			*7900 *16,850	*7900 *16,850	*5450 *11,750	5350 11,500	*4550 *9,850	3500 7,500	*3300 *6,100	2450 5,300	*2650 *5,750	2400 5,250	7660 25'1"
1500 mm 5'0"	kg lb			*6900 *16,550	*6900 *16,550	*6850 *14,750	4950 10,700	*5200 *11,250	3300 7,150	3800 *7,850	2400 5,150	*2850 *6,200	2300 5,000	7780 25'5"
0 mm 0'0"	kg lb			*6900 *15,850	*6900 *15,850	*7750 *16,800	4700 10,150	5150 11,100	3200 6,850	3750	2350	*3200 *7,050	2300 5,050	7590 24'10"
-1500 mm -5'0"	kg lb	*5600 *12,500	*5600 *12,500	*9950 *22,650	8450 18,150	7850 16,850	4600 9,950	5100 10,950	3150 6,700			*3950 *8,700	2500 5,550	7080 23'2"
-3000 mm -10'0"	kg lb	*9200 *20,650	*9200 *20,650	*11 000 *23,800	8600 18,450	*7550 *16,250	4650 10,000	5150 11,050	3150 6,800			4950 11,000	3050 6,750	6160 20'1"
-4500 mm -15'0"	kg lb			*8450 *18,000	*8450 *18,000	*5650	4850					*5450 *12,000	4700 10,700	4610 14'9"

Reach Boom Lift Capacities – Counterweight: 3.77 mt (8,311 lb) – without Bucket

Thumb Ready Stick
2.9 m (9'6")
R2.9TRS

600 mm (24 in) Rubber Track Shoes
1990 mm (6'6")

3170 mm (10'5")
3970 mm (13'0")

		1500 mm/5'0"		3000 mm/10'0"		4500 mm/15'0"		6000 mm/20'0"		7500 mm/25'0"		 mm ft/in		
7500 mm 25'0"	kg lb											*2900 *6,500	*2900 *6,500	5100 16'2"
6000 mm 20'0"	kg lb							*3600 *7,350	*3600 *7,350			*2650 *5,800	*2650 *5,800	6450 20'11"
4500 mm 15'0"	kg lb							*4000 *8,700	3700 7,950			*2550 *5,600	*2550 *5,600	7240 23'7"
3000 mm 10'0"	kg lb			*7900 *16,850	*7900 *16,850	*5450 *11,750	5400 11,650	*4550 *9,850	3550 7,600	*3300 *6,100	2500 5,400	*2650 *5,750	2450 5,350	7660 25'1"
1500 mm 5'0"	kg lb			*6900 *16,550	*6900 *16,550	*6850 *14,750	5050 10,900	*5200 *11,250	3400 7,250	3900 *7,850	2450 5,250	*2850 *6,200	2300 5,100	7780 25'5"
0 mm 0'0"	kg lb			*6900 *15,850	*6900 *15,850	*7750 *16,800	4800 10,350	5250 11,300	3250 7,000	*3750	2400	*3200 *7,050	2350 5,150	7590 24'10"
-1500 mm -5'0"	kg lb	*5600 *12,500	*5600 *12,500	*9950 *22,650	8600 18,500	8000 17,200	4700 10,100	5200 11,150	3200 6,850			*3950 *8,700	2550 5,650	7080 23'2"
-3000 mm -10'0"	kg lb	*9200 *20,650	*9200 *20,650	*11 000 *23,800	8750 18,750	*7550 *16,250	4750 10,200	5250 11,250	3200 6,950			5050 11,200	3100 6,900	6160 20'1"
-4500 mm -15'0"	kg lb			*8450 *18,000	*8450 *18,000	*5650	4950					*5450 *12,000	4800 10,850	4610 14'9"



ISO 10567:2007



* Indicates that the load is limited by hydraulic lifting capacity rather than tipping load. The above loads are in compliance with hydraulic excavator lift capacity standard ISO 10567:2007. They do not exceed 87% of hydraulic lifting capacity or 75% of tipping load. Weight of all lifting accessories must be deducted from the above lifting capacities. Lifting capacities are based on the machine standing on a firm, uniform supporting surface. The use of a work tool attachment point to handle/lift objects, could affect the machine lift performance.

Lift capacity stays with ±5% for all available track shoes.

Always refer to the appropriate Operation and Maintenance Manual for specific product information.

317 Hydraulic Excavator Specifications

Reach Boom Lift Capacities – Counterweight: 3.77 mt (8,311 lb) – without Bucket

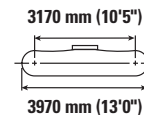
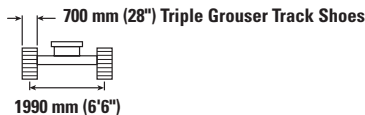
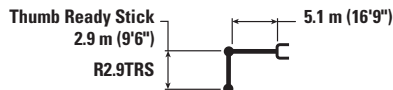

Reach Boom	Unit	1500 mm/5'0"		3000 mm/10'0"		4500 mm/15'0"		6000 mm/20'0"		7500 mm/25'0"		mm ft/in		
		kg lb	kg lb	kg lb	kg lb	kg lb	kg lb	kg lb	kg lb	kg lb	kg lb	kg lb	kg lb	
7500 mm 25'0"	kg lb											*2900 *6,500	*2900 *6,500	5100 16'2"
6000 mm 20'0"	kg lb							*3600 *7,350	*3600 *7,350			*2650 *5,800	*2650 *5,800	6450 20'11"
4500 mm 15'0"	kg lb							*4000 *8,700	3650 7,900			*2550 *5,600	*2550 *5,600	7240 23'7"
3000 mm 10'0"	kg lb			*7900 *16,850	*7900 *16,850	*5450 *11,750	5400 11,600	*4550 *9,850	3550 7,600	*3300 *6,100	2500 5,350	*2650 *5,750	2400 5,300	7660 25'1"
1500 mm 5'0"	kg lb			*6900 *16,550	*6900 *16,550	*6850 *14,750	5000 10,800	*5200 *11,250	3350 7,200	3850 *7,850	2450 5,200	*2850 *6,200	2300 5,050	7780 25'5"
0 mm 0'0"	kg lb			*6900 *15,850	*6900 *15,850	*7750 *16,800	4750 10,250	5200 11,250	3250 6,950	*3750	2350	*3200 *7,050	2350 5,150	7590 24'10"
-1500 mm -5'0"	kg lb	*5600 *12,500	*5600 *12,500	*9950 *22,650	8550 18,400	7950 17,100	4700 10,050	5150 11,100	3150 6,800			*3950 *8,700	2550 5,600	7080 23'2"
-3000 mm -10'0"	kg lb	*9200 *20,650	*9200 *20,650	*11,000 *23,800	8700 18,650	*7550 *16,250	4700 10,150	5200 11,200	3200 6,900			5000 11,100	3100 6,850	6160 20'1"
-4500 mm -15'0"	kg lb			*8450 *18,000	8450 *18,000	*5650	4900					*5450 *12,000	4750 10,800	4610 14'9"

Reach Boom Lift Capacities – Counterweight: 3.77 mt (8,311 lb) – without Bucket

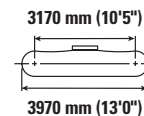
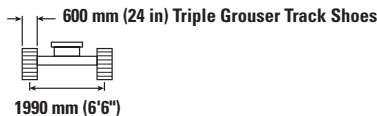
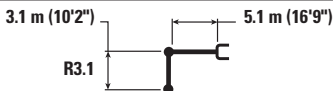

Reach Boom	Unit	1500 mm/5'0"		3000 mm/10'0"		4500 mm/15'0"		6000 mm/20'0"		7500 mm/25'0"		mm ft/in		
		kg lb	kg lb	kg lb	kg lb	kg lb	kg lb	kg lb	kg lb	kg lb	kg lb	kg lb	kg lb	
7500 mm 25'0"	kg lb											*2700 *6,050	*2700 *6,050	5380 17'2"
6000 mm 20'0"	kg lb							*3650 *7,550	*3650 *7,550			*2450 *5,400	*2450 *5,400	6670 21'7"
4500 mm 15'0"	kg lb							*3900 *8,500	3700 7,950			*2400 *5,250	*2400 *5,250	7440 24'3"
3000 mm 10'0"	kg lb			*7500 *15,950	*7500 *15,950	*5300 *11,450	*5300 *11,450	*4500 *9,700	3550 7,650	*3600 *7,100	2550 5,450	*2450 *5,400	2350 5,200	7850 25'8"
1500 mm 5'0"	kg lb			*8250 *19,750	*8250 19,550	*6750 *14,550	5100 10,950	*5150 *11,200	3400 7,300	3850 8,300	2450 5,300	*2650 *5,800	2250 4,950	7960 26'1"
0 mm 0'0"	kg lb			*7150 *16,450	*7150 *16,450	*7750 *16,800	4800 10,400	5250 11,250	3250 7,000	3800 8,200	2400 5,150	*3000 *6,550	2300 5,000	7780 25'5"
-1500 mm -5'0"	kg lb	*5400 *12,050	*5400 *12,050	*9700 *22,100	8600 18,450	7950 17,050	4700 10,150	5150 11,100	3200 6,850			*3600 *7,950	2500 5,450	7280 23'10"
-3000 mm -10'0"	kg lb	*8700 *19,450	*8700 *19,450	*11,400 *24,650	8650 18,600	*7750 *16,700	4700 10,150	5150 11,150	3200 6,900			4750 10,500	2950 6,550	6400 20'10"
-4500 mm -15'0"	kg lb			*9100 *19,350	8900 19,200	*6150 *12,950	4850 10,500					*5450 *12,000	4350 9,800	4920 15'9"



ISO 10567:2007



* Indicates that the load is limited by hydraulic lifting capacity rather than tipping load. The above loads are in compliance with hydraulic excavator lift capacity standard ISO 10567:2007. They do not exceed 87% of hydraulic lifting capacity or 75% of tipping load. Weight of all lifting accessories must be deducted from the above lifting capacities. Lifting capacities are based on the machine standing on a firm, uniform supporting surface. The use of a work tool attachment point to handle/lift objects, could affect the machine lift performance.

Lift capacity stays with ±5% for all available track shoes.

Always refer to the appropriate Operation and Maintenance Manual for specific product information.

317 Hydraulic Excavator Specifications

Reach Boom Lift Capacities – Counterweight: 3.77 mt (8,311 lb) – without Bucket

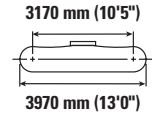
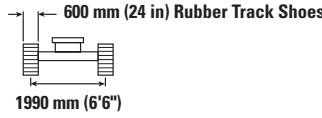
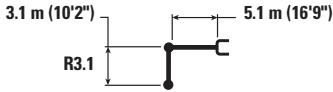

		1500 mm/5'0"		3000 mm/10'0"		4500 mm/15'0"		6000 mm/20'0"		7500 mm/25'0"		mm ft/in		
7500 mm 25'0"	kg lb											*2700 *6,050	*2700 *6,050	5380 17'2"
6000 mm 20'0"	kg lb							*3650 *7,550	*3650 *7,550			*2450 *5,400	*2450 *5,400	6670 21'7"
4500 mm 15'0"	kg lb							*3900 *8,500	3800 8,100			*2400 *5,250	*2400 *5,250	7440 24'3"
3000 mm 10'0"	kg lb			*7500 *15,950	*7500 *15,950	*5300 *11,450	*5300 *11,450	*4500 *9,700	3650 7,800	*3600 *7,100	2600 5,550	*2450 *5,400	2400 5,300	7850 25'8"
1500 mm 5'0"	kg lb			*8250 *19,750	*8250 *19,750	*6750 *14,550	5150 11,150	*5150 *11,200	3450 7,450	3950 8,500	2500 5,400	*2650 *5,800	2300 5,050	7960 26'1"
0 mm 0'0"	kg lb			*7150 *16,450	*7150 *16,450	*7750 *16,800	4900 10,550	5350 11,500	3350 7,150	3900 8,350	2450 5,250	*3000 *6,550	2350 5,100	7780 25'5"
-1500 mm -5'0"	kg lb	*5400 *12,050	*5400 *12,050	*9700 *22,100	8750 18,750	8100 17,900	4800 10,300	5250 11,300	3250 7,000			*3600 *7,950	2550 5,550	7280 23'10"
-3000 mm -10'0"	kg lb	*8700 *19,450	*8700 *19,450	*11,400 *24,650	8850 18,950	*7750 *16,700	4800 10,350	5250 11,350	3250 7,050			4850 10,700	3000 6,700	6400 20'10"
-4500 mm -15'0"	kg lb			*9100 *19,350	9000 *19,350	*6150 *12,950	4950 10,700					*5450 *12,000	4400 10,000	4920 15'9"

Reach Boom Lift Capacities – Counterweight: 3.77 mt (8,311 lb) – without Bucket

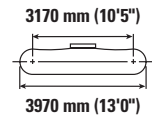
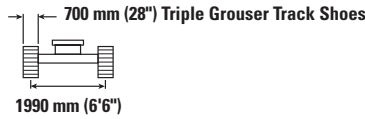

		1500 mm/5'0"		3000 mm/10'0"		4500 mm/15'0"		6000 mm/20'0"		7500 mm/25'0"		mm ft/in		
7500 mm 25'0"	kg lb											*2700 *6,050	*2700 *6,050	5380 17'2"
6000 mm 20'0"	kg lb							*3650 *7,550	*3650 *7,550			*2450 *5,400	*2450 *5,400	6670 21'7"
4500 mm 15'0"	kg lb							*3900 *8,500	3750 8,050			*2400 *5,250	*2400 *5,250	7440 24'3"
3000 mm 10'0"	kg lb			*7500 *15,950	*7500 *15,950	*5300 *11,450	*5300 *11,450	*4500 *9,700	3600 7,750	*3600 *7,100	2600 5,500	*2450 *5,400	2400 5,250	7850 25'8"
1500 mm 5'0"	kg lb			*8250 *19,750	*8250 *19,750	*6750 *14,550	5150 11,050	*5150 *11,200	3450 7,400	3900 8,400	2500 5,350	*2650 *5,800	2300 5,000	7960 26'1"
0 mm 0'0"	kg lb			*7150 *16,450	*7150 *16,450	*7750 *16,800	4900 10,500	5300 11,400	3300 7,100	3850 8,300	2450 5,250	*3000 *6,550	2300 5,100	7780 25'5"
-1500 mm -5'0"	kg lb	*5400 *12,050	*5400 *12,050	*9700 *22,100	8700 18,650	8050 17,300	4750 10,250	5200 11,250	3250 6,950			*3600 *7,950	2500 5,500	7280 23'10"
-3000 mm -10'0"	kg lb	*8700 *19,450	*8700 *19,450	*11,400 *24,650	8750 18,850	*7750 *16,700	4800 10,250	5250 11,250	3250 7,000			4800 10,650	3000 6,650	6400 20'10"
-4500 mm -15'0"	kg lb			*9100 *19,350	9000 *19,350	*6150 *12,950	4900 10,600					*5450 *12,000	4400 9,900	4920 15'9"



ISO 10567:2007



* Indicates that the load is limited by hydraulic lifting capacity rather than tipping load. The above loads are in compliance with hydraulic excavator lift capacity standard ISO 10567:2007. They do not exceed 87% of hydraulic lifting capacity or 75% of tipping load. Weight of all lifting accessories must be deducted from the above lifting capacities. Lifting capacities are based on the machine standing on a firm, uniform supporting surface. The use of a work tool attachment point to handle/lift objects, could affect the machine lift performance.

Lift capacity stays with ±5% for all available track shoes.

Always refer to the appropriate Operation and Maintenance Manual for specific product information.

317 Hydraulic Excavator Specifications

Reach Boom Lift Capacities – Counterweight: 3.25 mt (7,165 lb) – without Bucket – with Blade Up

2700 mm (8'10") Blade

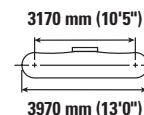
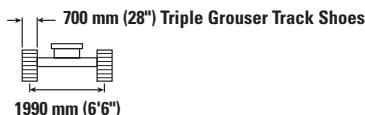

		1500 mm/5'0"		3000 mm/10'0"		4500 mm/15'0"		6000 mm/20'0"		7500 mm/25'0"		mm ft/in		
7500 mm 25'0"	kg lb					*7700	*7700					*3350 *7,450	*3350 *7,450	4770 15'1"
6000 mm 20'0"	kg lb							*3600 *6,650	*3600 *6,650			*2950 *6,450	*2950 *6,450	6190 20'0"
4500 mm 15'0"	kg lb					*4650 *10,050	*4650 *10,050	*4300 *9,450	3600 7,750			*2850 *6,200	2800 *6,200	7020 22'10"
3000 mm 10'0"	kg lb			*8900 *18,900	*8900 *18,900	*5900 *12,700	5250 11,350	*4850 *10,500	3500 7,500			*2900 *6,300	2500 5,550	7450 24'4"
1500 mm 5'0"	kg lb					*7250 *15,600	4950 10,650	5100 10,950	3350 7,150	*3500	2450	*3050 *6,750	2400 5,250	7560 24'9"
0 mm 0'0"	kg lb			*6200 *14,200	*6200 *14,200	7650 16,400	4750 10,150	4950 10,650	3200 6,900			*3450 *7,600	2450 5,350	7370 24'2"
-1500 mm -5'0"	kg lb	*5650 *12,650	*5650 *12,650	*10 050 *22,950	8500 18,250	7550 16,200	4650 10,000	4900 10,550	3150 6,800			4100 9,000	2700 5,900	6850 22'4"
-3000 mm -10'0"	kg lb	*9900 *22,300	*9900 *22,300	*10 750 *23,250	8650 18,550	*7450 *16,050	4700 10,150					5100 11,350	3300 7,350	5900 19'2"
-4500 mm -15'0"	kg lb			*7750 *16,400	*7750 *16,400							*5450 *11,900	5350 *11,900	4240 13'6"

Reach Boom Lift Capacities – Counterweight: 3.25 mt (7,165 lb) – without Bucket – with Blade Up

2600 mm (8'6") Blade

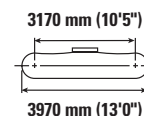
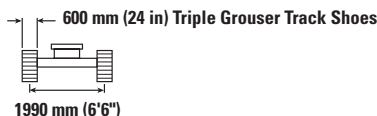

		1500 mm/5'0"		3000 mm/10'0"		4500 mm/15'0"		6000 mm/20'0"		7500 mm/25'0"		mm ft/in		
7500 mm 25'0"	kg lb					*7,700	*7,700					*3350 *7,450	*3350 *7,450	4770 15'1"
6000 mm 20'0"	kg lb							*3600 *6,650	*3600 *6,650			*2950 *6,450	*2950 *6,450	6190 20'0"
4500 mm 15'0"	kg lb					*4650 *10,050	*4650 *10,050	*4300 *9,450	3550 7,650			*2850 *6,200	2800 6,150	7020 22'10"
3000 mm 10'0"	kg lb			*8900 *18,900	*8900 *18,900	*5900 *12,700	5200 11,200	*4850 *10,500	3450 7,400			*2900 *6,300	2500 5,450	7450 24'4"
1500 mm 5'0"	kg lb					*7250 *15,600	4900 10,500	5000 10,800	3300 7,050	*3500	2400	*3050 *6,750	2350 5,200	7560 24'9"
0 mm 0'0"	kg lb			*6200 *14,200	*6200 *14,200	7550 16,200	4650 10,050	4900 10,500	3200 6,850			*3450 *7,600	2400 5,300	7370 24'2"
-1500 mm -5'0"	kg lb	*5650 *12,650	*5650 *12,650	*10 050 *22,950	8400 18,050	7450 16,000	4600 9,900	4850 10,400	3150 6,750			4050 8,900	2650 5,850	6850 22'4"
-3000 mm -10'0"	kg lb	*9900 *22,300	*9900 *22,300	*10 750 *23,250	8550 18,350	*7450 *16,050	4650 10,000					5050 11,200	3250 7,250	5900 19'2"
-4500 mm -15'0"	kg lb			*7750 *16,400	*7750 *16,400							*5450 *11,900	5300 *11,900	4240 13'6"



ISO 10567:2007



* Indicates that the load is limited by hydraulic lifting capacity rather than tipping load. The above loads are in compliance with hydraulic excavator lift capacity standard ISO 10567:2007. They do not exceed 87% of hydraulic lifting capacity or 75% of tipping load. Weight of all lifting accessories must be deducted from the above lifting capacities. Lifting capacities are based on the machine standing on a firm, uniform supporting surface. The use of a work tool attachment point to handle/lift objects, could affect the machine lift performance.

Lift capacity stays with ±5% for all available track shoes.

Always refer to the appropriate Operation and Maintenance Manual for specific product information.

317 Hydraulic Excavator Specifications

Reach Boom Lift Capacities – Counterweight: 3.25 mt (7,165 lb) – without Bucket – with Blade Up

2600 mm (8'6") Blade

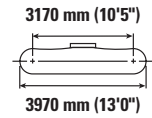
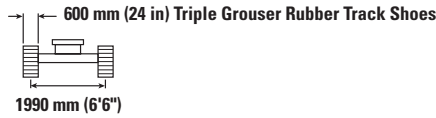
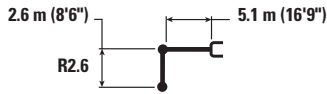

Reach	Unit	1500 mm/5'0"		3000 mm/10'0"		4500 mm/15'0"		6000 mm/20'0"		7500 mm/25'0"		mm ft/in		
		kg lb	kg lb	kg lb	kg lb	kg lb	kg lb	kg lb	kg lb	kg lb	kg lb	kg lb	mm ft/in	
7500 mm 25'0"	kg lb					*7,700 *7,700						*3350 *7,450	*3350 *7,450	4770 15'1"
6000 mm 20'0"	kg lb							*3600 *6,650	*3600 *6,650			*2950 *6,450	*2950 *6,450	6190 20'0"
4500 mm 15'0"	kg lb					*4650 *10,050	*4650 *10,050	*4300 *9,450	3650 7,800			*2850 *6,200	*2850 *6,200	7020 22'10"
3000 mm 10'0"	kg lb			*8900 *18,900	*8900 *18,900	*5900 *12,700	5300 11,400	*4850 *10,500	3500 7,500			*2900 *6,300	2550 5,550	7450 24'4"
1500 mm 5'0"	kg lb					*7250 *15,600	4950 10,700	5100 11,000	3350 7,200	*3500 2450		*3050 *6,750	2400 5,300	7560 24'9"
0 mm 0'0"	kg lb			*6200 *14,200	*6200 *14,200	7700 16,500	4750 10,250	5000 10,750	3250 6,950			*3450 *7,600	2450 5,400	7370 24'2"
-1500 mm -5'0"	kg lb	*5650 *12,650	*5650 *12,650	*10 050 *22,950	8550 18,400	7600 16,350	4700 10,100	4950 10,650	3200 6,850			4150 9,100	2700 5,950	6850 22'4"
-3000 mm -10'0"	kg lb	*9900 *22,300	*9900 *22,300	*10 750 *23,250	8700 18,650	*7450 *16,050	4750 10,200					5150 11,400	3300 7,350	5900 19'2"
-4500 mm -15'0"	kg lb			*7750 *16,400	*7750 *16,400							*5450 *11,900	5400 *11,900	4240 13'6"

Reach Boom Lift Capacities – Counterweight: 3.25 mt (7,165 lb) – without Bucket – with Blade Up

2600 mm (8'6") Blade

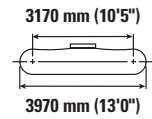
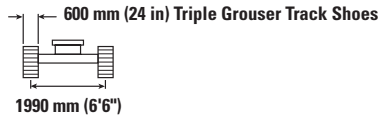
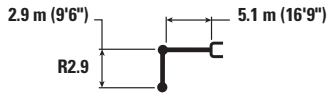

Reach	Unit	1500 mm/5'0"		3000 mm/10'0"		4500 mm/15'0"		6000 mm/20'0"		7500 mm/25'0"		mm ft/in		
		kg lb	kg lb	kg lb	kg lb	kg lb	kg lb	kg lb	kg lb	kg lb	kg lb	kg lb	mm ft/in	
7500 mm 25'0"	kg lb											*2950 *6,600	*2950 *6,600	5100 16'2"
6000 mm 20'0"	kg lb							*3650 *7,450	*3650 *7,450			*2650 *5,900	*2650 *5,900	6450 20'11"
4500 mm 15'0"	kg lb							*4050 *8,850	3600 7,750			*2600 *5,700	*2600 *5,700	7240 23'7"
3000 mm 10'0"	kg lb			*8000 *17,050	*8000 *17,050	*5550 *11,950	5300 11,400	*4600 *10,000	3500 7,500	*3350 *6,200	2500 5,300	*2700 *5,850	2400 5,250	7660 25'1"
1500 mm 5'0"	kg lb			*6950 *16,650	*6950 *16,650	*6950 *14,950	4950 10,650	5100 10,900	3300 7,150	3650 7,800	2400 5,150	*2900 *6,300	2300 5,000	7780 25'5"
0 mm 0'0"	kg lb			*6950 *15,950	*6950 *15,950	7600 16,350	4700 10,100	4950 10,600	3200 6,850	3600 3600	2350	*3250 *7,150	2300 5,100	7590 24'10"
-1500 mm -5'0"	kg lb	*5650 *12,550	*5650 *12,550	*10 000 *22,750	8400 18,050	7500 16,100	4600 9,900	4850 10,450	3150 6,700			3850 8,500	2550 5,550	7080 23'2"
-3000 mm -10'0"	kg lb	*9250 *20,750	*9250 *20,750	*11 150 *24,050	8500 18,300	7550 16,150	4650 9,950	4900 10,550	3150 6,800			4750 10,500	3050 6,750	6160 20'1"
-4500 mm -15'0"	kg lb			*8550 *18,200	*8550 *18,200	*5750	4800					*5550 *12,200	4650 10,600	4610 14'9"



ISO 10567:2007



* Indicates that the load is limited by hydraulic lifting capacity rather than tipping load. The above loads are in compliance with hydraulic excavator lift capacity standard ISO 10567:2007. They do not exceed 87% of hydraulic lifting capacity or 75% of tipping load. Weight of all lifting accessories must be deducted from the above lifting capacities. Lifting capacities are based on the machine standing on a firm, uniform supporting surface. The use of a work tool attachment point to handle/lift objects, could affect the machine lift performance.

Lift capacity stays with ±5% for all available track shoes.

Always refer to the appropriate Operation and Maintenance Manual for specific product information.

317 Hydraulic Excavator Specifications

Reach Boom Lift Capacities – Counterweight: 3.25 mt (7,165 lb) – without Bucket – with Blade Up

2700 mm (8'10") Blade

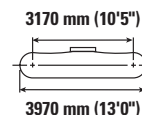
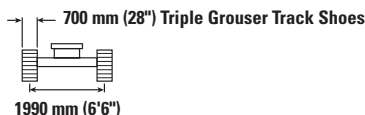

		1500 mm/5'0"		3000 mm/10'0"		4500 mm/15'0"		6000 mm/20'0"		7500 mm/25'0"		mm ft/in		
7500 mm 25'0"	kg lb											*2950 *6,600	*2950 *6,600	5100 16'2"
6000 mm 20'0"	kg lb							*3650 *7,450	*3650 *7,450			*2650 *5,900	*2650 *5,900	6450 20'11"
4500 mm 15'0"	kg lb							*4050 *8,850	3600 7,700			*2600 *5,700	*2600 *5,700	7240 23'7"
3000 mm 10'0"	kg lb			*8000 *17,050	*8000 *17,050	*5550 *11,950	5250 11,300	*4600 *10,000	3450 7,400	*3350 *6,200	2450 5,250	*2700 *5,850	2350 5,200	7660 25'1"
1500 mm 5'0"	kg lb			*6950 *16,650	*6950 *16,650	*6950 *14,950	4900 10,500	5000 10,750	3300 7,050	3600 7,700	2400 5,100	*2900 *6,300	2250 4,950	7780 25'5"
0 mm 0'0"	kg lb			*6950 *15,950	*6950 *15,950	7500 16,150	4650 10,000	4850 10,450	4850 6,750	3150 6,750	3550 2300	*3250 *7,150	2300 5,000	7590 24'10"
-1500 mm -5'0"	kg lb	*5650 *12,550	*5650 *12,550	*10 000 *22,750	8300 17,850	7400 15,900	4550 9,800	4800 10,300	3100 6,650			3800 8,400	2500 5,500	7080 23'2"
-3000 mm -10'0"	kg lb	*9250 *20,750	*9250 *20,750	*11 150 *24,050	8400 18,050	7450 15,950	4550 9,850	4850 10,400	3100 6,700			4650 10,350	3000 6,700	6160 20'1"
-4500 mm -15'0"	kg lb			*8550 *18,200	*8550 *18,200	*5750	4750					*5550 *12,200	4600 10,500	4610 14'9"

Reach Boom Lift Capacities – Counterweight: 3.25 mt (7,165 lb) – without Bucket – with Blade Up

2600 mm (8'6") Blade

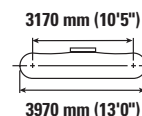
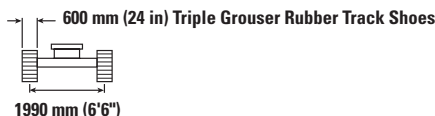

		1500 mm/5'0"		3000 mm/10'0"		4500 mm/15'0"		6000 mm/20'0"		7500 mm/25'0"		mm ft/in		
7500 mm 25'0"	kg lb											*2950 *6,600	*2950 *6,600	5100 16'2"
6000 mm 20'0"	kg lb							*3650 *7,450	*3650 *7,450			*2650 *5,900	*2650 *5,900	6450 20'11"
4500 mm 15'0"	kg lb							*4050 *8,850	3650 7,800			*2600 *5,700	*2600 *5,700	7240 23'7"
3000 mm 10'0"	kg lb			*8000 *17,050	*8000 *17,050	*5550 *11,950	5350 11,450	*4600 *10,000	3500 7,500	*3350 *6,200	2500 5,350	*2700 *5,850	2400 5,300	7660 25'1"
1500 mm 5'0"	kg lb			*6950 *16,650	*6950 *16,650	*6950 *14,950	4950 10,700	5100 11,000	3350 7,150	3650 7,900	2450 5,200	*2900 *6,300	2300 5,050	7780 25'5"
0 mm 0'0"	kg lb			*6950 *15,950	*6950 *15,950	7650 16,450	4750 10,200	4950 10,700	3200 6,900	3600	2350	*3250 *7,150	2350 5,100	7590 24'10"
-1500 mm -5'0"	kg lb	*5650 *12,550	*5650 *12,550	*10 000 *22,750	8450 18,150	7550 16,200	4650 9,950	4900 10,550	3150 6,750			3900 8,600	2550 5,600	7080 23'2"
-3000 mm -10'0"	kg lb	*9250 *20,750	*9250 *20,750	*11 150 *24,050	8550 18,400	7600 16,300	4650 10,050	4950 10,650	3200 6,850			4750 10,550	3100 6,800	6160 20'1"
-4500 mm -15'0"	kg lb			*8550 *18,200	*8550 *18,200	*5750	4850					*5550 *12,200	4700 10,700	4610 14'9"



ISO 10567:2007



* Indicates that the load is limited by hydraulic lifting capacity rather than tipping load. The above loads are in compliance with hydraulic excavator lift capacity standard ISO 10567:2007. They do not exceed 87% of hydraulic lifting capacity or 75% of tipping load. Weight of all lifting accessories must be deducted from the above lifting capacities. Lifting capacities are based on the machine standing on a firm, uniform supporting surface. The use of a work tool attachment point to handle/lift objects, could affect the machine lift performance.

Lift capacity stays with ±5% for all available track shoes.

Always refer to the appropriate Operation and Maintenance Manual for specific product information.

317 Hydraulic Excavator Specifications

Reach Boom Lift Capacities – Counterweight: 3.25 mt (7,165 lb) – without Bucket – with Blade Up

2700 mm (8'10") Blade

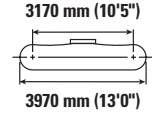
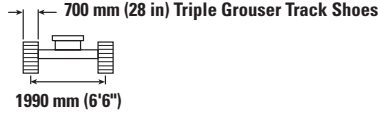
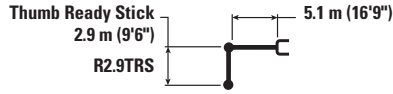

		1500 mm/5'0"		3000 mm/10'0"		4500 mm/15'0"		6000 mm/20'0"		7500 mm/25'0"		mm ft/in		
7500 mm 25'0"	kg lb											*2900 *6,500	*2900 *6,500	5100 16'2"
6000 mm 20'0"	kg lb							*3600 *7,350	*3600 *7,350			*2650 *5,800	*2650 *5,800	6450 20'11"
4500 mm 15'0"	kg lb							*4000 *8,700	3550 7,650			*2550 *5,600	*2550 *5,600	7240 23'7"
3000 mm 10'0"	kg lb			*7900 *16,850	*7900 *16,850	*5450 *11,750	5250 11,250	*4550 *9,850	3400 7,350	*3300 *6,100	2400 5,150	*2650 *5,750	2350 5,150	7660 25'1"
1500 mm 5'0"	kg lb			*6900 *16,550	*6900 *16,550	*6850 *14,750	4850 10,450	5000 10,750	3250 7,000	3600 7,700	2350 5,050	*2850 *6,200	2200 4,900	7780 25'5"
0 mm 0'0"	kg lb			*6900 *15,850	*6900 *15,850	7550 16,150	4600 9,950	4850 10,450	3100 6,700	3500 2300		*3200 *7,050	2250 4,950	7590 24'10"
-1500 mm -5'0"	kg lb	*5600 *12,500	*5600 *12,500	*9950 *22,650	8300 17,800	7400 15,900	4500 9,700	4800 10,300	3050 6,550			3800 8,400	2450 5,400	7080 23'2"
-3000 mm -10'0"	kg lb	*9200 *20,650	*9200 *20,650	*11,000 *23,800	8400 18,050	7450 16,000	4550 9,800	4850 10,400	3100 6,650			4650 10,350	3000 6,600	6160 20'1"
-4500 mm -15'0"	kg lb			*8450 *18,000	*8450 *18,000	*5650	4750					*5450 *12,000	4600 10,450	4610 14'9"

Reach Boom Lift Capacities – Counterweight: 3.25 mt (7,165 lb) – without Bucket – with Blade Up

2600 mm (8'6") Blade

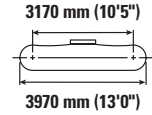
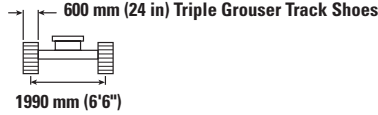
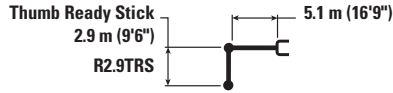

		1500 mm/5'0"		3000 mm/10'0"		4500 mm/15'0"		6000 mm/20'0"		7500 mm/25'0"		mm ft/in		
7500 mm 25'0"	kg lb											*2900 *6,500	*2900 *6,500	5100 16'2"
6000 mm 20'0"	kg lb							*3600 *7,350	3600 *7,350			*2650 *5800	*2650 *5800	6450 20'11"
4500 mm 15'0"	kg lb							*4000 *8,700	3550 7,550			*2550 *5,600	*2550 *5,600	7240 23'7"
3000 mm 10'0"	kg lb			*7900 *16,850	*7900 *16,850	*5450 *11,750	5200 11,150	*4550 *9,850	3400 7,250	*3300 *6,100	2400 5,100	*2650 *5,750	2300 5,050	7660 25'1"
1500 mm 5'0"	kg lb			*6900 *16,550	*6900 *16,550	*6850 *14,750	4800 10,350	4950 10,650	3200 6,900	3550 7,600	2300 4,950	*2850 *6,200	2200 4,800	7780 25'5"
0 mm 0'0"	kg lb			*6900 *15,850	*6900 *15,850	7450 15,950	4550 9,800	4800 10,300	3100 6,600	3500	2250	*3200 *7,050	2250 4,900	7590 24'10"
-1500 mm -5'0"	kg lb	*5600 *12,500	*5600 *12,500	*9950 *22,650	8200 17,550	7300 15,700	4450 9,600	4750 10,150	3000 6,500			3750 8,250	2450 5,350	7080 23'2"
-3000 mm -10'0"	kg lb	*9200 *20,650	*9200 *20,650	*11,000 *23,800	8300 17,800	7350 15,800	4500 9,650	4750 10,250	3050 6,550			4600 10,200	2950 6,550	6160 20'1"
-4500 mm -15'0"	kg lb			*8450 *18,000	*8450 *18,000	*5650	4700					*5450 *12,000	4550 10,350	4610 14'9"



ISO 10567:2007



* Indicates that the load is limited by hydraulic lifting capacity rather than tipping load. The above loads are in compliance with hydraulic excavator lift capacity standard ISO 10567:2007. They do not exceed 87% of hydraulic lifting capacity or 75% of tipping load. Weight of all lifting accessories must be deducted from the above lifting capacities. Lifting capacities are based on the machine standing on a firm, uniform supporting surface. The use of a work tool attachment point to handle/lift objects, could affect the machine lift performance.

Lift capacity stays with ±5% for all available track shoes.

Always refer to the appropriate Operation and Maintenance Manual for specific product information.

317 Hydraulic Excavator Specifications

Reach Boom Lift Capacities – Counterweight: 3.25 mt (7,165 lb) – without Bucket – with Blade Up

2600 mm (8'6") Blade

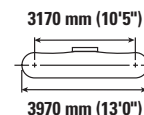
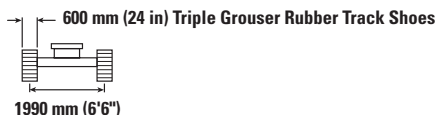
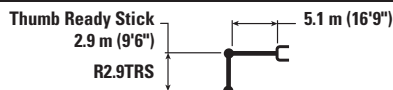

		1500 mm/5'0"		3000 mm/10'0"		4500 mm/15'0"		6000 mm/20'0"		7500 mm/25'0"		mm ft/in		
7500 mm 25'0"	kg lb											*2900 *6,500	*2900 *6,500	5100 16'2"
6000 mm 20'0"	kg lb							*3600 *7,350	*3600 *7,350			*2650 *5,800	*2650 *5,800	6450 20'11"
4500 mm 15'0"	kg lb							*4000 *8,700	3600 7,700			*2550 *5,600	*2550 *5,600	7240 23'7"
3000 mm 10'0"	kg lb			*7900 *16,850	*7900 *16,850	*5450 *11,750	5250 11,350	*4550 *9,850	3450 7,400	*3300 *6,100	2450 5,200	*2650 *5,750	2350 5,150	7660 25'1"
1500 mm 5'0"	kg lb			*6900 *16,550	*6900 *16,550	*6850 *14,750	4900 10,550	5050 10,850	3250 7,050	3600 7,750	2350 5,050	*2850 *6,200	2250 4,900	7780 25'5"
0 mm 0'0"	kg lb			*6900 *15,850	*6900 *15,850	7600 16,300	4650 10,000	4900 10,550	3150 6,750	3550 7,750	2300	*3200 *7,050	2250 5,000	7590 24'10"
-1500 mm -5'0"	kg lb	*5600 *12,500	*5600 *12,500	*9950 *22,650	8350 17,900	7450 16,050	4550 9,800	4850 10,400	3100 6,600			3850 8,450	2500 5,450	7080 23'2"
-3000 mm -10'0"	kg lb	*9200 *20,650	*9200 *20,650	*11000 *23,800	8450 18,150	7500 16,100	4600 9,850	4850 10,500	3100 6,700			4700 10,400	3000 6,650	6160 20'1"
-4500 mm -15'0"	kg lb			*8450 *18,000	*8450 *18,000	*5650	4750					*5450 *12,000	4650 10,500	4610 14'9"

Reach Boom Lift Capacities – Counterweight: 3.25 mt (7,165 lb) – without Bucket – with Blade Up

2700 mm (8'10") Blade

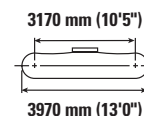
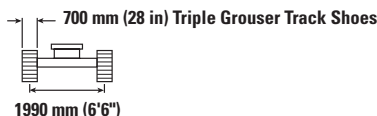

		1500 mm/5'0"		3000 mm/10'0"		4500 mm/15'0"		6000 mm/20'0"		7500 mm/25'0"		mm ft/in		
7500 mm 25'0"	kg lb											*2700 *6,050	*2700 *6,050	5380 17'2"
6000 mm 20'0"	kg lb							*3650 *7,550	*3650 *7,550			*2450 *5,400	*2450 *5,400	6670 21'7"
4500 mm 15'0"	kg lb							*3900 *8,500	3650 7,800			*2400 *5,250	*2400 *5,250	7440 24'3"
3000 mm 10'0"	kg lb			*7500 *15,950	*7500 *15,950	*5300 *11,450	*5300 *11,450	*4500 *9,700	3500 7,500	*3600 *7,100	2500 5,350	*2450 *5,400	2300 5,100	7850 25'8"
1500 mm 5'0"	kg lb			*8250 *19,750	*8250 19,200	*6750 *14,550	5000 10,700	5100 10,950	3350 7,150	3650 7,850	2400 5,200	*2650 *5,800	2200 4,850	7960 26'1"
0 mm 0'0"	kg lb			*7150 *16,450	*7150 *16,450	7650 16,400	4700 10,150	4950 10,600	3200 6,850	3600 7,700	2350 5,050	*3000 *6,550	2250 4,900	7780 25'5"
-1500 mm -5'0"	kg lb	*5400 *12,050	*5400 *12,050	*9700 *22,100	8400 18,050	7500 16,100	4600 9,900	4850 10,450	3150 6,700			*3600 *7,950	2450 5,350	7280 23'10"
-3000 mm -10'0"	kg lb	*8700 *19,450	*8700 *19,450	*11400 *24,650	8500 18,250	7500 16,150	4600 9,950	4900 10,500	3150 6,750			4450 9,900	2900 6,400	6400 20'10"
-4500 mm -15'0"	kg lb			*9100 *19,350	8750 18,800	*6150 *12,950	4750 10,300					*5450 *12,000	4250 9,600	4920 15'9"



ISO 10567:2007



* Indicates that the load is limited by hydraulic lifting capacity rather than tipping load. The above loads are in compliance with hydraulic excavator lift capacity standard ISO 10567:2007. They do not exceed 87% of hydraulic lifting capacity or 75% of tipping load. Weight of all lifting accessories must be deducted from the above lifting capacities. Lifting capacities are based on the machine standing on a firm, uniform supporting surface. The use of a work tool attachment point to handle/lift objects, could affect the machine lift performance.

Lift capacity stays with ±5% for all available track shoes.

Always refer to the appropriate Operation and Maintenance Manual for specific product information.

317 Hydraulic Excavator Specifications

Reach Boom Lift Capacities – Counterweight: 3.25 mt (7,165 lb) – without Bucket – with Blade Up

2600 mm (8'6") Blade

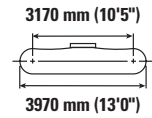
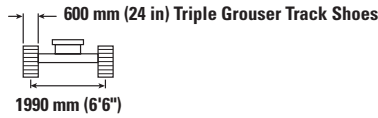
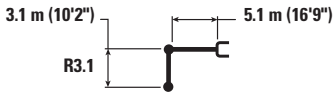

		1500 mm/5'0"		3000 mm/10'0"		4500 mm/15'0"		6000 mm/20'0"		7500 mm/25'0"		mm ft/in		
7500 mm 25'0"	kg lb											*2700 *6,050	*2700 *6,050	5380 17'2"
6000 mm 20'0"	kg lb							*3650 *7,550	*3650 *7,550			*2450 *5,400	*2450 *5,400	6670 21'7"
4500 mm 15'0"	kg lb							*3900 *8,500	3600 7,750			*2400 *5,250	*2400 *5,250	7440 24'3"
3000 mm 10'0"	kg lb			*7500 *15,950	*7500 *15,950	*5300 *11,450	5300 11,400	*4500 *9,700	3450 7,450	*3600 *7,100	2450 5,250	*2450 *5,400	2300 5,000	7850 25'8"
1500 mm 5'0"	kg lb			*8250 *19,750	*8250 *18,950	*6750 *14,550	4900 10,600	5050 10,800	3300 7,100	3600 7,750	2400 5,100	*2650 *5,800	2200 4,800	7960 26'1"
0 mm 0'0"	kg lb			*7150 *16,450	*7150 *16,450	7550 16,200	4650 10,050	4900 10,500	3150 6,800	3550 7,600	2300 5,000	*3000 *6,550	2200 4,850	7780 25'5"
-1500 mm -5'0"	kg lb	*5400 *12,050	*5400 *12,050	*9700 *22,100	8300 17,800	7400 15,900	4550 9,800	4800 10,300	3100 6,650			*3600 *7,950	2400 5,250	7280 23'10"
-3000 mm -10'0"	kg lb	*8700 *19,450	*8700 *19,450	*11,400 *24,650	8400 18,000	7400 15,950	4550 9,800	4800 10,350	3100 6,650			4400 9,800	2850 6,350	6400 20'10"
-4500 mm -15'0"	kg lb			*9100 *19,350	8650 18,550	*6150 *12,950	4700 10,150					*5450 *12,000	4200 9,500	4920 15'9"

Reach Boom Lift Capacities – Counterweight: 3.25 mt (7,165 lb) – without Bucket – with Blade Up

2600 mm (8'6") Blade

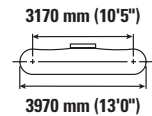
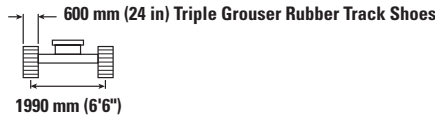
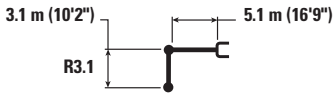

		1500 mm/5'0"		3000 mm/10'0"		4500 mm/15'0"		6000 mm/20'0"		7500 mm/25'0"		mm ft/in		
7500 mm 25'0"	kg lb											*2700 *6,050	*2700 *6,050	5380 17'2"
6000 mm 20'0"	kg lb							*3650 *7,550	*3650 *7,550			*2450 *5,400	*2450 *5,400	6670 21'7"
4500 mm 15'0"	kg lb							*3900 *8,500	3650 7,850			*2400 *5,250	*2400 *5,250	7440 24'3"
3000 mm 10'0"	kg lb			*7500 *15,950	*7500 *15,950	*5300 *11,450	*5300 *11,450	*4500 *9,700	3500 7,550	*3600 *7,100	2500 5,350	*2450 *5,400	2350 5,100	7850 25'8"
1500 mm 5'0"	kg lb			*8250 *19,750	*8250 *19,300	*6750 *14,550	5000 10,800	5,150 11,050	3350 7,200	3700 7,900	2450 5,200	*2650 *5,800	2250 4,900	7960 26'1"
0 mm 0'0"	kg lb			*7150 *16,450	*7150 *16,450	7700 16,500	4750 10,200	5,000 10,700	3200 6,900	3600 7,750	2350 5,100	*3000 *6,550	2250 4,950	7780 25'5"
-1500 mm -5'0"	kg lb	*5400 *12,050	*5400 *12,050	*9700 *22,100	8450 18,150	7550 16,250	4650 10,000	4900 10,550	3150 6,750			*3600 *7,950	2450 5,350	7280 23'10"
-3000 mm -10'0"	kg lb	*8700 *19,450	*8700 *19,450	*11,400 *24,650	8550 18,350	7550 16,250	4650 10,000	4900 10,600	3150 6,800			4500 10,000	2900 6,450	6400 20'10"
-4500 mm -15'0"	kg lb			*9100 *19,350	8800 18,900	*6150 *12,950	4800 10,350					*5450 *12,000	4250 9,650	4920 15'9"



ISO 10567:2007



* Indicates that the load is limited by hydraulic lifting capacity rather than tipping load. The above loads are in compliance with hydraulic excavator lift capacity standard ISO 10567:2007. They do not exceed 87% of hydraulic lifting capacity or 75% of tipping load. Weight of all lifting accessories must be deducted from the above lifting capacities. Lifting capacities are based on the machine standing on a firm, uniform supporting surface. The use of a work tool attachment point to handle/lift objects, could affect the machine lift performance.

Lift capacity stays with ±5% for all available track shoes.

Always refer to the appropriate Operation and Maintenance Manual for specific product information.

317 Hydraulic Excavator Specifications

Reach Boom Lift Capacities – Counterweight: 3.77 mt (8,311 lb) – without Bucket – with Blade Up

2700 mm (8'10") Blade

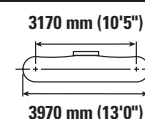
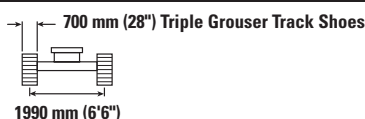

		1500 mm/5'0"		3000 mm/10'0"		4500 mm/15'0"		6000 mm/20'0"		7500 mm/25'0"		mm ft/in		
7500 mm 25'0"	kg lb					*7,700	*7,700					*3350 *7,450	*3350 *7,450	4770 15'1"
6000 mm 20'0"	kg lb							*3600 *6,650	*3600 *6,650			*2950 *6,450	*2950 *6,450	6190 20'0"
4500 mm 15'0"	kg lb					*4650 *10,050	*4650 *10,050	*4300 *9,450	3850 8,300			*2850 *6,200	*2850 *6,200	7020 22'10"
3000 mm 10'0"	kg lb			*8900 *18,900	*8900 *18,900	*5900 *12,700	5650 12,150	*4850 *10,500	3750 8,050			*2900 *6,300	2700 5,950	7450 24'4"
1500 mm 5'0"	kg lb					*7250 *15,600	5300 11,450	5400 11,650	3600 7,700	*3500 2650		*3050 *6,750	2600 5,700	7560 24'9"
0 mm 0'0"	kg lb			*6200 *14,200	*6200 *14,200	*8050 *17,400	5100 11,000	5300 11,400	3500 7,500			*3450 *7,600	2650 5,800	7370 24'2"
-1500 mm -5'0"	kg lb	*5650 *12,650	*5650 *12,650	*10 050 *22,950	9200 *19,700	8050 17,300	5050 10,850	5250 11,250	3450 7,400			*4200 *9,300	2900 6,400	6850 22'4"
-3000 mm -10'0"	kg lb	*9900 *22,300	*9900 *22,300	*10 750 *23,250	9300 *20,000	*7450 *16,050	5100 10,950					*5350 *11,800	3550 7,900	5900 19'2"
-4500 mm -15'0"	kg lb			*7750 *16,400	*7750 *16,400							*5450 *11,900	*5450 *11,900	4240 13'6"

Reach Boom Lift Capacities – Counterweight: 3.77 mt (8,311 lb) – without Bucket – with Blade Up

2600 mm (8'6") Blade

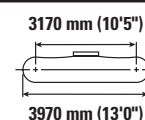

		1500 mm/5'0"		3000 mm/10'0"		4500 mm/15'0"		6000 mm/20'0"		7500 mm/25'0"		mm ft/in		
7500 mm 25'0"	kg lb					*7,700	*7,700					*3350 *7,450	*3350 *7,450	4770 15'1"
6000 mm 20'0"	kg lb							*3600 *6,650	*3600 *6,650			*2950 *6,450	*2950 *6,450	6190 20'0"
4500 mm 15'0"	kg lb					*4650 *10,050	*4650 *10,050	*4300 *9,450	3850 8,200			*2850 *6,200	*2850 *6,200	7020 22'10"
3000 mm 10'0"	kg lb			*8900 *18,900	*8900 *18,900	*5900 *12,700	5600 12,000	*4850 *10,500	3700 7,950			*2900 *6,300	2700 5,900	7450 24'4"
1500 mm 5'0"	kg lb					*7250 *15,600	5250 11,300	5350 11,500	3550 7,650	*3500 2600		*3050 *6,750	2550 5,650	7560 24'9"
0 mm 0'0"	kg lb			*6200 *14,200	*6200 *14,200	*8050 17,250	5050 10,850	5250 11,250	3450 7,400			*3450 *7,600	2600 5,750	7370 24'2"
-1500 mm -5'0"	kg lb	*5650 *12,650	*5650 *12,650	*10 050 *22,950	9050 19,450	7950 17,100	4950 10,700	5200 11,150	3400 7,300			*4200 *9,300	2850 6,300	6850 22'4"
-3000 mm -10'0"	kg lb	*9900 *22,300	*9900 *22,300	*10 750 *23,250	9200 19,750	*7450 *16,050	5000 10,800					*5350 *11,800	3550 7,800	5900 19'2"
-4500 mm -15'0"	kg lb			*7750 *16,400	*7750 *16,400							*5450 *11,900	*5450 *11,900	4240 13'6"



ISO 10567:2007



* Indicates that the load is limited by hydraulic lifting capacity rather than tipping load. The above loads are in compliance with hydraulic excavator lift capacity standard ISO 10567:2007. They do not exceed 87% of hydraulic lifting capacity or 75% of tipping load. Weight of all lifting accessories must be deducted from the above lifting capacities. Lifting capacities are based on the machine standing on a firm, uniform supporting surface. The use of a work tool attachment point to handle/lift objects, could affect the machine lift performance.

Lift capacity stays with ±5% for all available track shoes.

Always refer to the appropriate Operation and Maintenance Manual for specific product information.

317 Hydraulic Excavator Specifications

Reach Boom Lift Capacities – Counterweight: 3.77 mt (8,311 lb) – without Bucket – with Blade Up

2600 mm (8'6") Blade

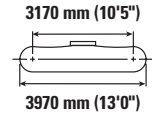
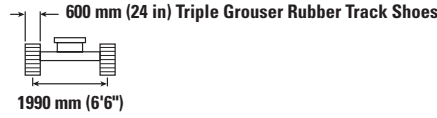
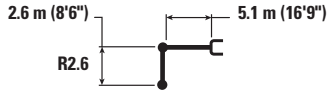

		1500 mm/5'0"		3000 mm/10'0"		4500 mm/15'0"		6000 mm/20'0"		7500 mm/25'0"		mm ft/in		
7500 mm 25'0"	kg lb					*7,700	*7,700					*3350 *7,450	*3350 *7,450	4770 15'1"
6000 mm 20'0"	kg lb							*3600 *6,650	*3600 *6,650			*2950 *6,450	*2950 *6,450	6190 20'0"
4500 mm 15'0"	kg lb					*4650 *10,050	*4650 *10,050	*4300 *9,450	3900 8,350			*2850 *6,200	*2850 *6,200	7020 22'10"
3000 mm 10'0"	kg lb			*8900 *18,900	*8900 *18,900	*5900 *12,700	5650 12,200	*4850 *10,500	3750 8,100			*2900 *6,300	2750 6,000	7450 24'4"
1500 mm 5'0"	kg lb					*7250 *15,600	5350 11,500	5450 11,750	3600 7,750	*3500 2650		*3050 *6,750	2600 5,750	7560 24'9"
0 mm 0'0"	kg lb			*6200 *14,200	*6200 *14,200	*8050 *17,400	5150 11,050	5350 11,450	3500 7,500			*3450 *7,600	2650 5,850	7370 24'2"
-1500 mm -5'0"	kg lb	*5650 *12,650	*5650 *12,650	*10 050 *22,950	9250 19,800	8100 17,400	5050 10,900	5300 11,350	3450 7,450			*4200 *9,300	2900 6,450	6850 22'4"
-3000 mm -10'0"	kg lb	*9900 *22,300	*9900 *22,300	*10 750 *23,250	9350 20,100	*7450 *16,050	5100 11,000					*5350 *11,800	3600 7,950	5900 19'2"
-4500 mm -15'0"	kg lb			*7750 *16,400	*7750 *16,400							*5450 *11,900	*5450 *11,900	4240 13'6"

Reach Boom Lift Capacities – Counterweight: 3.77 mt (8,311 lb) – without Bucket – with Blade Up

2700 mm (8'10") Blade

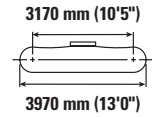
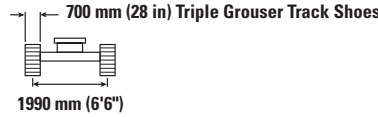
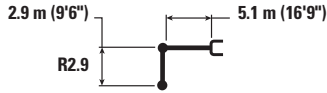

		1500 mm/5'0"		3000 mm/10'0"		4500 mm/15'0"		6000 mm/20'0"		7500 mm/25'0"		mm ft/in		
7500 mm 25'0"	kg lb											*2950 *6,600	*2950 *6,600	5100 16'2"
6000 mm 20'0"	kg lb							*3650 *7,450	*3650 *7,450			*2650 *5,900	*2650 *5,900	6450 20'11"
4500 mm 15'0"	kg lb							*4050 *8,850	3900 8,350			*2600 *5,700	*2600 *5,700	7240 23'7"
3000 mm 10'0"	kg lb			*8000 *17,050	*8000 *17,050	*5550 *11,950	*5550 *11,950	*4600 *10,000	3750 8,050	*3350 *6,200	2700 5,750	*2700 *5,850	2600 5,700	7660 25'1"
1500 mm 5'0"	kg lb			*6950 *16,650	*6950 *16,650	*6950 *14,950	5300 11,450	*5250 *11,400	3600 7,700	3900 *7,950	2600 5,600	*2900 *6,300	2500 5,450	7780 25'5"
0 mm 0'0"	kg lb			*6950 *15,950	*6950 *15,950	*7850 *17,000	5100 10,900	5250 11,300	3450 7,400	*3800 2550		*3250 *7,150	2500 5,500	7590 24'10"
-1500 mm -5'0"	kg lb	*5650 *12,550	*5650 *12,550	*10 000 *22,750	9100 19,500	8000 17,200	5000 10,700	5200 11,200	3400 7,300			*4000 *8,800	2750 6,000	7080 23'2"
-3000 mm -10'0"	kg lb	*9250 *20,750	*9250 *20,750	*11 150 *24,050	9200 19,700	*7600 *16,450	5000 10,750	5250 11,250	3400 7,350			5050 11,200	3300 7,350	6160 20'1"
-4500 mm -15'0"	kg lb			*8550 *18,200	*8550 *18,200	*5750	5200					*5550 *12,200	5050 11,450	4610 14'9"



ISO 10567:2007



* Indicates that the load is limited by hydraulic lifting capacity rather than tipping load. The above loads are in compliance with hydraulic excavator lift capacity standard ISO 10567:2007. They do not exceed 87% of hydraulic lifting capacity or 75% of tipping load. Weight of all lifting accessories must be deducted from the above lifting capacities. Lifting capacities are based on the machine standing on a firm, uniform supporting surface. The use of a work tool attachment point to handle/lift objects, could affect the machine lift performance.

Lift capacity stays with ±5% for all available track shoes.

Always refer to the appropriate Operation and Maintenance Manual for specific product information.

317 Hydraulic Excavator Specifications

Reach Boom Lift Capacities – Counterweight: 3.77 mt (8,311 lb) – without Bucket – with Blade Up

2600 mm (8'6") Blade

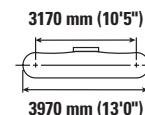
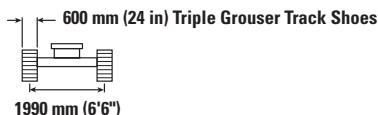

		1500 mm/5'0"		3000 mm/10'0"		4500 mm/15'0"		6000 mm/20'0"		7500 mm/25'0"		mm ft/in		
7500 mm 25'0"	kg lb											*2950 *6,600	*2950 *6,600	5100 16'2"
6000 mm 20'0"	kg lb							*3650 *7,450	*3650 *7,450			*2650 *5,900	*2650 *5,900	6450 20'11"
4500 mm 15'0"	kg lb							*4050 *8,850	3850 8,250			*2600 *5,700	*2600 *5,700	7240 23'7"
3000 mm 10'0"	kg lb			*8000 *17,050	*8000 *17,050	*5550 *11,950	*5550 *11,950	*4600 *10,000	3700 7,950	*3350 *6,200	2650 5,650	*2700 *5,850	2550 5,600	7660 25'1"
1500 mm 5'0"	kg lb			*6950 *16,650	*6950 *16,650	*6950 *14,950	5250 11,300	*5250 *11,400	3550 7,600	3850 *7,950	2600 5,550	*2900 *6,300	2450 5,350	7780 25'5"
0 mm 0'0"	kg lb			*6950 *15,950	*6950 *15,950	*7850 *17,000	5000 10,800	5200 11,200	3400 7,300	3800	2500	*3250 *7,150	2500 5,450	7590 24'10"
-1500 mm -5'0"	kg lb	*5650 *12,550	*5650 *12,550	*10 000 *22,750	8950 19,250	7900 17,000	4900 10,600	5150 11,050	3350 7,200			*4000 *8,800	2700 5,950	7080 23'2"
-3000 mm -10'0"	kg lb	*9250 *20,750	*9250 *20,750	*11 150 *24,050	9100 19,500	*7 600 *16,450	4950 10,650	5150 11,150	3400 7,300			5000 11,050	3250 7,250	6160 20'1"
-4500 mm -15'0"	kg lb			*8550 *18,200	*8550 *18,200	*5750	5150					*5550 *12,200	4950 11,300	4610 14'9"

Reach Boom Lift Capacities – Counterweight: 3.77 mt (8,311 lb) – without Bucket – with Blade Up

2600 mm (8'6") Blade

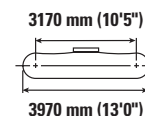
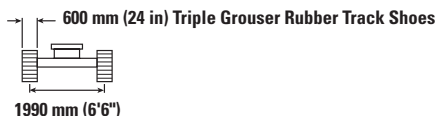

		1500 mm/5'0"		3000 mm/10'0"		4500 mm/15'0"		6000 mm/20'0"		7500 mm/25'0"		mm ft/in		
7500 mm 25'0"	kg lb											*2950 *6,600	*2950 *6,600	5100 16'2"
6000 mm 20'0"	kg lb							*3650 *7,450	*3650 *7,450			*2650 *5,900	*2650 *5,900	6450 20'11"
4500 mm 15'0"	kg lb							*4050 *8,850	3900 8,400			*2600 *5,700	*2600 *5,700	7240 23'7"
3000 mm 10'0"	kg lb			*8000 *17,050	*8000 *17,050	*5550 *11,950	*5550 *11,950	*4600 *10,000	3750 8,100	*3350 *6,200	2700 5,750	*2700 *5,850	2600 5,700	7660 25'1"
1500 mm 5'0"	kg lb			*6950 *16,650	*6950 *16,650	*6950 *14,950	5350 11,500	*5250 *11,400	3600 7,750	3900 *7950	2600 5,650	*2900 *6,300	2500 5,450	7780 25'5"
0 mm 0'0"	kg lb			*6950 *15,950	*6950 *15,950	*7850 *17,000	5100 11,000	5300 11,400	3450 7,450	*3,800	2550	*3250 *7,150	2550 5,550	7590 24'10"
-1500 mm -5'0"	kg lb	*5650 *12,550	*5650 *12,550	*10 000 *22,750	9150 19,600	8050 17,300	5000 10,750	5250 11,250	3400 7,350			*4000 *8,800	2750 6,050	7080 23'2"
-3000 mm -10'0"	kg lb	*9250 *20,750	*9250 *20,750	*11 150 *24,050	9250 19,800	*7600 *16,450	5050 10,850	5250 11,350	3450 7,400			5100 11,300	3350 7,350	6160 20'1"
-4500 mm -15'0"	kg lb			*8550 *18,200	*8550 *18,200	*5750	5200					*5550 *12,200	5050 11,500	4610 14'9"



ISO 10567:2007



* Indicates that the load is limited by hydraulic lifting capacity rather than tipping load. The above loads are in compliance with hydraulic excavator lift capacity standard ISO 10567:2007. They do not exceed 87% of hydraulic lifting capacity or 75% of tipping load. Weight of all lifting accessories must be deducted from the above lifting capacities. Lifting capacities are based on the machine standing on a firm, uniform supporting surface. The use of a work tool attachment point to handle/lift objects, could affect the machine lift performance.

Lift capacity stays with ±5% for all available track shoes.

Always refer to the appropriate Operation and Maintenance Manual for specific product information.

317 Hydraulic Excavator Specifications

Reach Boom Lift Capacities – Counterweight: 3.77 mt (8,311 lb) – without Bucket – with Blade Up

2700 mm (8'10") Blade

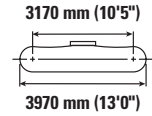
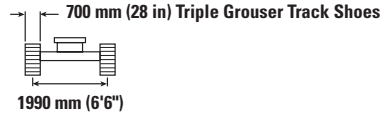
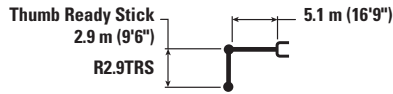

		1500 mm/5'0"		3000 mm/10'0"		4500 mm/15'0"		6000 mm/20'0"		7500 mm/25'0"		mm ft/in		
7500 mm 25'0"	kg lb											*2900 *6,500	*2900 *6,500	5100 16'2"
6000 mm 20'0"	kg lb							*3600 *7,350	*3600 *7,350			*2650 *5,800	*2650 *5,800	6450 20'11"
4500 mm 15'0"	kg lb							*4000 *8,700	3850 8,200			*2550 *5,600	*2550 *5,600	7240 23'7"
3000 mm 10'0"	kg lb			*7900 *16,850	*7900 *16,850	*5450 *11,750	*5450 *11,750	*4550 *9,850	3700 7,900	2600 *6,100	2600 5,600	*2650 *5,750	2550 5,550	7660 25'1"
1500 mm 5'0"	kg lb			*6900 *16,550	*6900 *16,550	*6850 *14,750	5250 11,300	*5200 *11,250	3500 7,550	3850 *7,850	2550 5,450	*2850 *6,200	2400 5,300	7780 25'5"
0 mm 0'0"	kg lb			*6900 *15,850	*6900 *15,850	*7750 *16,800	5000 10,750	5200 11,150	3400 7,250	*3750	2500	*3200 *7,050	2450 5,400	7590 24'10"
-1500 mm -5'0"	kg lb	*5600 *12,500	*5600 *12,500	*9950 *22,650	8950 19,200	7900 17,000	4900 10,550	5150 11,000	3300 7,150			*3950 *8,700	2650 5,900	7080 23'2"
-3000 mm -10'0"	kg lb	*9200 *20,650	*9200 *20,650	*11 000 *23,800	9050 19,450	*7550 *16,250	4900 10,600	5150 11,150	3350 7,200			5000 11,050	3250 7,200	6160 20'1"
-4500 mm -15'0"	kg lb			*8450 *18,000	*8450 *18,000	*5650	5100					*5450 *12,000	4950 11,300	4610 14'9"

Reach Boom Lift Capacities – Counterweight: 3.77 mt (8,311 lb) – without Bucket – with Blade Up

2600 mm (8'6") Blade

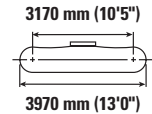
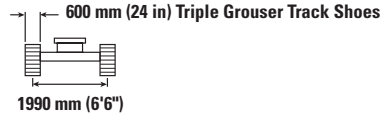
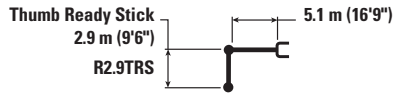

		1500 mm/5'0"		3000 mm/10'0"		4500 mm/15'0"		6000 mm/20'0"		7500 mm/25'0"		mm ft/in		
7500 mm 25'0"	kg lb											*2900 *6,500	*2900 *6,500	5100 16'2"
6000 mm 20'0"	kg lb							*3600 *7,350	*3600 *7,350			*2650 *5,800	*2650 *5,800	6450 20'11"
4500 mm 15'0"	kg lb							*4000 *8,700	3800 8,100			*2550 *5,600	*2550 *5,600	7240 23'7"
3000 mm 10'0"	kg lb			*7900 *16,850	*7900 *16,850	*5450 *11,750	*5450 *11,750	*4550 *9,850	3650 7,800	*3300 *6,100	2600 5,550	*2650 *5,750	2500 5,500	7660 25'1"
1500 mm 5'0"	kg lb			*6900 *16,550	*6900 *16,550	*6850 *14,750	5200 11,150	*5200 *11,250	3450 7,450	3800 *7,850	2500 5,400	*2850 *6,200	2400 5,250	7780 25'5"
0 mm 0'0"	kg lb			*6900 *15,850	*6900 *15,850	*7750 *16,800	4950 10,600	5150 11,050	3350 7,150	3750	2450	*3200 *7,050	2400 5,300	7590 24'10"
-1500 mm -5'0"	kg lb	*5600 *12,500	*5600 *12,500	*9950 *22,650	8850 19,000	7850 16,800	4850 10,400	5050 10,900	3250 7,050			*3950 *8,700	2650 5,800	7080 23'2"
-3000 mm -10'0"	kg lb	*9200 *20,650	*9200 *20,650	*11 000 *23,800	8950 19,250	*7550 *16,250	4850 10,450	5100 11,000	3300 7,150			4900 10,900	3200 7,100	6160 20'1"
-4500 mm -15'0"	kg lb			*8450 *18,000	*8450 *18,000	*5650	5050					*5450 *12,000	4900 11,150	4610 14'9"



ISO 10567:2007



* Indicates that the load is limited by hydraulic lifting capacity rather than tipping load. The above loads are in compliance with hydraulic excavator lift capacity standard ISO 10567:2007. They do not exceed 87% of hydraulic lifting capacity or 75% of tipping load. Weight of all lifting accessories must be deducted from the above lifting capacities. Lifting capacities are based on the machine standing on a firm, uniform supporting surface. The use of a work tool attachment point to handle/lift objects, could affect the machine lift performance.

Lift capacity stays with ±5% for all available track shoes.

Always refer to the appropriate Operation and Maintenance Manual for specific product information.

317 Hydraulic Excavator Specifications

Reach Boom Lift Capacities – Counterweight: 3.77 mt (8,311 lb) – without Bucket – with Blade Up

2600 mm (8'6") Blade

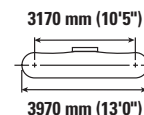
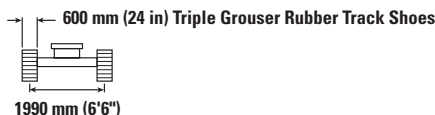
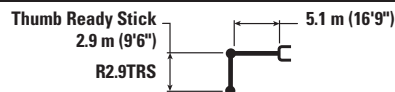

		1500 mm/5'0"		3000 mm/10'0"		4500 mm/15'0"		6000 mm/20'0"		7500 mm/25'0"		mm ft/in		
7500 mm 25'0"	kg lb											*2900 *6,500	*2900 *6,500	5100 16'2"
6000 mm 20'0"	kg lb							*3600 *7,350	*3600 *7,350			*2650 *5,800	*2650 *5,800	6450 20'11"
4500 mm 15'0"	kg lb							*4000 *8,700	3850 8,250			*2550 *5,600	*2550 *5,600	7240 23'7"
3000 mm 10'0"	kg lb			*7900 *16,850	*7900 *16,850	*5450 *11,750	*5450 *11,750	*4550 *9,850	3700 7,950	2650 *6,100	2650 5,650	*2650 *5,750	2550 5,600	7660 25'1"
1500 mm 5'0"	kg lb			*6900 *16,550	*6900 *16,550	*6850 *14,750	5250 11,350	*5200 *11,250	3550 7,600	3850 *7,850	2550 5,500	*2850 *6,200	2450 5,350	7780 25'5"
0 mm 0'0"	kg lb			*6900 *15,850	*6900 *15,850	*7750 *16,800	5000 10,800	5250 11,250	3400 7,300	*3750	2500	*3200 *7,050	2450 5,400	7590 24'10"
-1500 mm -5'0"	kg lb	*5600 *12,500	*5600 *12,500	*9950 *22,650	9000 19,300	8000 17,100	4900 10,600	5150 11,100	3350 7,150			*3950 *8,700	2700 5,900	7080 23'2"
-3000 mm -10'0"	kg lb	*9200 *20,650	*9200 *20,650	*11000 *23,800	9100 19,600	*7550 *16,250	4950 10,650	5200 11,200	3350 7,250			5000 11,150	3250 7,200	6160 20'1"
-4500 mm -15'0"	kg lb			*8450 *18,000	*8450 *18,000	*5650	5150					*5450 *12,000	5000 11,350	4610 14'9"

Reach Boom Lift Capacities – Counterweight: 3.77 mt (8,311 lb) – without Bucket – with Blade Up

2700 mm (8'10") Blade

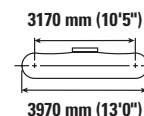
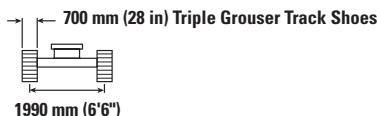

		1500 mm/5'0"		3000 mm/10'0"		4500 mm/15'0"		6000 mm/20'0"		7500 mm/25'0"		mm ft/in		
7500 mm 25'0"	kg lb											*2700 *6,050	*2700 *6,050	5380 17'2"
6000 mm 20'0"	kg lb							*3650 *7,550	*3650 *7,550			*2450 *5,400	*2450 *5,400	6670 21'7"
4500 mm 15'0"	kg lb							*3900 *8,500	*3900 8,400			*2400 *5,250	*2400 *5,250	7440 24'3"
3000 mm 10'0"	kg lb			*7500 *15,950	*7500 *15,950	*5300 *11,450	*5300 *11,450	*4500 *9,700	3750 8,100	*3600 *7,100	2700 5,750	*2450 *5,400	*2450 *5,400	7850 25'8"
1500 mm 5'0"	kg lb			*8250 *19,750	*8250 *19,750	*6750 *14,550	5350 11,550	*5150 *11,200	3600 7,700	3900 8,400	2600 5,600	*2650 *5,800	2400 5,250	7960 26'1"
0 mm 0'0"	kg lb			*7150 *16,450	*7150 *16,450	*7750 *16,800	5100 10,950	5300 11,350	3450 7,450	3850 8,250	2550 5,500	*3000 *6,550	2450 5,350	7780 25'5"
-1500 mm -5'0"	kg lb	*5400 *12,050	*5400 *12,050	*9700 *22,100	9050 19,450	8000 17,200	5000 10,700	5200 11,150	3400 7,300			*3600 *7,950	2650 5,800	7280 23'10"
-3000 mm -10'0"	kg lb	*8700 *19,450	*8700 *19,450	*11400 *24,650	9150 19,650	*7750 *16,700	5000 10,750	5200 11,200	3400 7,300			4800 10,600	3150 6,950	6400 20'10"
-4500 mm -15'0"	kg lb			*9100 *19,350	*9100 *19,350	6150 *12,950	5150 11,100					*5450 *12,000	4600 10,350	4920 15'9"



ISO 10567:2007



* Indicates that the load is limited by hydraulic lifting capacity rather than tipping load. The above loads are in compliance with hydraulic excavator lift capacity standard ISO 10567:2007. They do not exceed 87% of hydraulic lifting capacity or 75% of tipping load. Weight of all lifting accessories must be deducted from the above lifting capacities. Lifting capacities are based on the machine standing on a firm, uniform supporting surface. The use of a work tool attachment point to handle/lift objects, could affect the machine lift performance.

Lift capacity stays with ±5% for all available track shoes.

Always refer to the appropriate Operation and Maintenance Manual for specific product information.

317 Hydraulic Excavator Specifications

Reach Boom Lift Capacities – Counterweight: 3.77 mt (8,311 lb) – without Bucket – with Blade Up

2600 mm (8'6") Blade

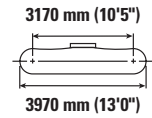
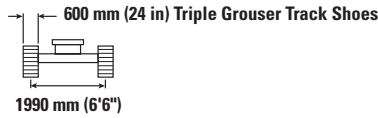
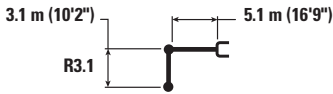

		1500 mm/5'0"		3000 mm/10'0"		4500 mm/15'0"		6000 mm/20'0"		7500 mm/25'0"		mm ft/in		
7500 mm 25'0"	kg lb											*2700 *6,050	*2700 *6,050	5380 17'2"
6000 mm 20'0"	kg lb							*3650 *7,550	*3650 *7,550			*2450 *5,400	*2450 *5,400	6670 21'7"
4500 mm 15'0"	kg lb							*3900 *8,500	3850 8,300			*2400 *5,250	*2400 *5,250	7440 24'3"
3000 mm 10'0"	kg lb			*7500 *15,950	*7500 *15,950	*5300 *11,450	*5300 *11,450	*4500 *9,700	3700 8,000	*3600 *7,100	2650 5,700	*2450 *5,400	*2450 *5,400	7850 25'8"
1500 mm 5'0"	kg lb			*8250 *19,750	*8250 *19,750	*6750 *14,550	*5300 11,400	*5150 *11,200	3550 7,650	3850 8,300	2600 5,550	*2650 *5,800	2350 5,200	7960 26'1"
0 mm 0'0"	kg lb			*7150 *16,450	*7150 *16,450	*7750 *16,800	5050 10,850	5200 11,200	3400 7,350	3800 8,150	2500 5,400	*3000 *6,550	2400 5,250	7780 25'5"
-1500 mm -5'0"	kg lb	*5400 *12,050	*5400 *12,050	*9700 *22,100	8950 19,250	7900 17,000	4900 10,600	5150 11,050	3350 7,200			*3600 *7,950	2600 5,700	7280 23'10"
-3000 mm -10'0"	kg lb	*8700 *19,450	*8700 *19,450	*11,400 *24,650	9050 19,450	*7750 *16,700	4950 10,600	5150 11,100	3350 7,250			4700 10,450	3100 6,850	6400 20'10"
-4500 mm -15'0"	kg lb			*9100 *19,350	*9100 *19,350	*6150 *12,950	5100 10,950					*5450 *12,000	4500 10,250	4920 15'9"

Reach Boom Lift Capacities – Counterweight: 3.77 mt (8,311 lb) – without Bucket – with Blade Up

2600 mm (8'6") Blade

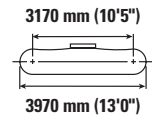
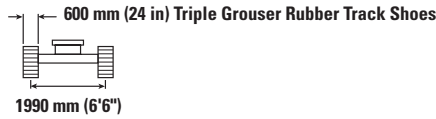
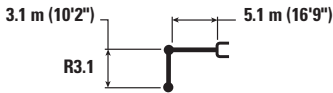

		1500 mm/5'0"		3000 mm/10'0"		4500 mm/15'0"		6000 mm/20'0"		7500 mm/25'0"		mm ft/in		
7500 mm 25'0"	kg lb											*2700 *6,050	*2700 *6,050	5380 17'2"
6000 mm 20'0"	kg lb							*3650 *7,550	*3650 *7,550			*2450 *5,400	*2450 *5,400	6670 21'7"
4500 mm 15'0"	kg lb							*3900 *8,500	*3900 8,450			*2400 *5,250	*2400 *5,250	7440 24'3"
3000 mm 10'0"	kg lb			*7500 *15,950	*7500 *15,950	*5300 *11,450	*5300 *11,450	*4500 *9,700	3800 8,100	*3600 *7,100	2700 5,800	*2450 *5,400	*2450 *5,400	7850 25'8"
1500 mm 5'0"	kg lb			*8250 *19,750	*8250 *19,750	*6750 *14,550	5400 11,600	*5150 *11,200	3600 7,750	3950 8,450	2650 5,650	*2650 *5,800	2400 5,300	7960 26'1"
0 mm 0'0"	kg lb			*7150 *16,450	*7150 *16,450	*7750 *16,800	5100 11,050	5300 11,400	3500 7,450	3850 8,300	2550 5,500	*3000 *6,550	2450 5,350	7780 25'5"
-1500 mm -5'0"	kg lb	*5400 *12,050	*5400 *12,050	*9700 *22,100	9100 19,600	8050 17,300	5000 10,800	5250 11,250	3400 7,300			*3600 *7,950	2650 5,800	7280 23'10"
-3000 mm -10'0"	kg lb	*8700 *19,450	*8700 *19,450	*11,400 *24,650	9200 19,750	*7750 *16,700	5000 10,800	5250 11,300	3400 7,350			4800 10,650	3150 7,000	6400 20'10"
-4500 mm -15'0"	kg lb			*9100 *19,350	*9100 *19,350	*6150 *12,950	5150 11,150					*5450 *12,000	4600 10,400	4920 15'9"



ISO 10567:2007



* Indicates that the load is limited by hydraulic lifting capacity rather than tipping load. The above loads are in compliance with hydraulic excavator lift capacity standard ISO 10567:2007. They do not exceed 87% of hydraulic lifting capacity or 75% of tipping load. Weight of all lifting accessories must be deducted from the above lifting capacities. Lifting capacities are based on the machine standing on a firm, uniform supporting surface. The use of a work tool attachment point to handle/lift objects, could affect the machine lift performance.

Lift capacity stays with ±5% for all available track shoes.

Always refer to the appropriate Operation and Maintenance Manual for specific product information.

317 Hydraulic Excavator Specifications

Bucket Specifications and Compatibility

	Linkage	Width		Capacity		Weight		Fill	3.05 mt (6,720 lb) Counterweight				3.57 mt (7,870 lb) Counterweight				
		mm	in	m ³	yd ³	kg	lb		Reach Boom				Reach Boom				
									R2.6 (8'6")	R2.9 (9'6")	R2.9 (9'6") Thumb Ready	R3.1 (10'2")	R2.6 (8'6")	R2.9 (9'6")	R2.9 (9'6") Thumb Ready	R3.1 (10'2")	
Pin-On (No Quick Coupler)																	
General Duty	316	600	24	0.35	0.46	454	1,001	100	●	●	●	●	●	●	●	●	●
	316	750	30	0.49	0.64	516	1,137	100	●	●	●	●	●	●	●	●	●
	316	900	36	0.62	0.81	580	1,278	100	●	●	●	●	●	●	●	●	●
	316	1050	42	0.76	1.00	629	1,386	100	●	●	⊙	⊙	●	●	●	●	●
	316	1200	48	0.91	1.19	697	1,538	100	⊙	⊖	⊖	⊖	⊙	⊙	⊙	⊙	⊙
General Duty – Wide Tip	316	600	24	0.42	0.55	473	1,042	100	●	●	●	●	●	●	●	●	●
	316	750	30	0.58	0.76	535	1,179	100	●	●	●	●	●	●	●	●	●
	316	1050	42	0.90	1.18	670	1,478	100	⊙	⊖	⊖	⊖	●	⊙	⊙	⊙	⊙
	316	1200	48	1.07	1.40	737	1,625	100	⊖	○	○	○	⊖	⊖	⊖	⊖	⊖
Severe Duty	316	900	36	0.62	0.81	669	1,475	100	●	●	●	●	●	●	●	●	●
	316	1050	42	0.76	1.00	728	1,605	100	●	⊙	⊙	⊙	●	●	●	●	●
Clean Up	316	1500	60	1.24	1.62	770	1,698	100	○	◇	◇	◇	○	○	○	○	○
Ditch Cleaning – Tilt	316	1500	60	0.64	0.84	830	1,829	100	●	●	⊙	⊙	●	●	●	●	●
	316	1800	72	0.78	1.02	928	2,046	100	⊙	⊖	⊖	⊖	●	⊙	⊙	⊙	⊙
	316	2000	79	0.86	1.12	1043	2,299	100	⊖	○	○	○	⊖	⊖	⊖	⊖	⊖
Maximum load with pin-on (payload + bucket)									kg	2280	2160	2080	2080	2510	2380	2290	2290
									lb	5,035	4,771	4,579	4,592	5,523	5,245	5,053	5,053

The above loads are in compliance with hydraulic excavator standard EN474-5:2006+A3:2013, they do not exceed 87% of hydraulic lifting capacity or 75% of tipping capacity with front linkage fully extended at ground line with bucket curled.

Capacity based on ISO 7451:2007.

Maximum Material Density:

- 2100 kg/m³ (3,500 lb/yd³)
- ⊙ 1800 kg/m³ (3,000 lb/yd³)
- ⊖ 1500 kg/m³ (2,500 lb/yd³)
- 1200 kg/m³ (2,000 lb/yd³)
- ◇ 900 kg/m³ (1,500 lb/yd³)

Caterpillar recommends using appropriate work tools to maximize the value customers receive from our products. Use of work tools, including buckets, which are outside of Caterpillar's recommendations or specifications for weight, dimensions, flows, pressures, etc. may result in less-than-optimal performance, including but not limited to reductions in production, stability, reliability, and component durability. Improper use of a work tool resulting in sweeping, prying, twisting and/or catching of heavy loads will reduce the life of the boom and stick.

317 Hydraulic Excavator Specifications

Bucket Specifications and Compatibility (continued)

	Linkage	Width		Capacity		Weight		Fill	3.05 mt (6,720 lb) Counterweight				3.57 mt (7,870 lb) Counterweight				
		mm	in	m ³	yd ³	kg	lb		Reach Boom				Reach Boom				
									R2.6 (8'6")	R2.9 (9'6")	R2.9 (9'6") Thumb Ready	R3.1 (10'2")	R2.6 (8'6")	R2.9 (9'6")	R2.9 (9'6") Thumb Ready	R3.1 (10'2")	
With Cat Pin Grabber Coupler																	
General Duty	316	600	24	0.35	0.46	454	1,001	100	●	●	●	●	●	●	●	●	●
	316	750	30	0.49	0.64	516	1,137	100	●	●	●	●	●	●	●	●	●
	316	900	36	0.62	0.81	580	1,278	100	●	●	●	●	●	●	●	●	●
	316	1050	42	0.76	1.00	629	1,386	100	⊙	⊙	⊖	⊖	●	●	⊙	⊙	
	316	1200	48	0.91	1.19	697	1,538	100	⊖	○	○	○	⊙	⊖	⊖	⊖	
General Duty – Wide Tip	316	600	24	0.42	0.55	473	1,042	100	●	●	●	●	●	●	●	●	●
	316	750	30	0.58	0.76	535	1,179	100	●	●	●	●	●	●	●	●	●
	316	1050	42	0.90	1.18	670	1,478	100	⊖	⊖	○	○	⊙	⊖	⊖	⊖	
	316	1200	48	1.07	1.40	737	1,625	100	○	○	◇	◇	⊖	○	○	○	
Severe Duty	318	900	36	0.62	0.81	669	1,475	100	●	●	⊙	⊙	●	●	●	●	
	318	1050	42	0.76	1.00	728	1,605	100	⊙	⊖	⊖	⊖	●	⊙	⊙	⊙	
General Duty – Pin Grabber Performance	316	600	24	0.33	0.43	436	961	100	●	●	●	●	●	●	●	●	●
	316	900	36	0.57	0.75	578	1,273	100	●	●	●	●	●	●	●	●	●
Clean Up	316	1500	60	1.24	1.62	770	1,698	100	◇	◇	◇	◇	○	◇	◇	◇	
Ditch Cleaning – Tilt	316	1500	60	0.64	0.84	830	1,829	100	⊙	⊙	⊖	⊖	●	●	⊙	⊙	
	316	1800	72	0.78	1.02	928	2,046	100	⊖	○	○	○	⊙	⊖	⊖	⊖	
	316	2000	79	0.86	1.12	1043	2,299	100	○	◇	◇	◇	⊖	○	○	○	
Maximum load with pin-on (payload + bucket)								kg	2084	1964	1877	1883	2305	2179	2092	2092	
								lb	4,595	4,330	4,139	4,152	5,082	4,805	4,613	4,613	

The above loads are in compliance with hydraulic excavator standard EN474-5:2006+A3:2013, they do not exceed 87% of hydraulic lifting capacity or 75% of tipping capacity with front linkage fully extended at ground line with bucket curled.

Capacity based on ISO 7451:2007.

Maximum Material Density:

- 2100 kg/m³ (3,500 lb/yd³)
- ⊙ 1800 kg/m³ (3,000 lb/yd³)
- ⊖ 1500 kg/m³ (2,500 lb/yd³)
- 1200 kg/m³ (2,000 lb/yd³)
- ◇ 900 kg/m³ (1,500 lb/yd³)

Caterpillar recommends using appropriate work tools to maximize the value customers receive from our products. Use of work tools, including buckets, which are outside of Caterpillar's recommendations or specifications for weight, dimensions, flows, pressures, etc. may result in less-than-optimal performance, including but not limited to reductions in production, stability, reliability, and component durability. Improper use of a work tool resulting in sweeping, prying, twisting and/or catching of heavy loads will reduce the life of the boom and stick.

317 Hydraulic Excavator Specifications

Attachments Offering Guide

Not all Attachments are available in all regions. Consult your Cat dealer for configurations available in your region.

Match
 * Working range front only
 No Match
 1800 kg/m³ (3,000 lb/yd³)
 1200 kg/m³ (2,000 lb/yd³)

PIN-ON ATTACHMENTS

Counterweight		3.25 mt (7,165 lb)				3.77 mt (8,311 lb)			
		Reach				Reach			
Boom Type		2.60 m (8'6")	2.90 m (9'6")	2.90 m TR (9'6")	3.10 m (10'2")	2.60 m (8'6")	2.90 m (9'6")	2.90 m TR (9'6")	3.10 m (10'2")
Stick Length									
Hydraulic Hammers	H110 S	✓	✓	✓	✓	✓	✓	✓	✓
	H115 GC S	✓	✓	✓	✓	✓	✓	✓	✓
	H115 S	✓	✓	✓	✓	✓	✓	✓	✓
	H120 S	✓	✓	✓	✓	✓	✓	✓	✓
Demolition and Sorting Grapples	G314	✓	✓	✓	✓	✓	✓	✓	✓
Mobile Scrap and Demolition Shears	S3015 Flat Top	✓	✓	✓	✓	✓	✓	✓	✓
Pulverizers	P214 Secondary Pulverizer	✓	✓	✓	✓	✓	✓	✓	✓
Compactors (Vibratory Plate)	CVP75	✓	✓	✓	✓	✓	✓	✓	✓
Mulchers	HM3013	✓	✓	✓	✓	✓	✓	✓	✓
	HM4015	✓	✓	✓	✓	✓	✓	✓	✓
	HM4815	✓	✓	✓	✓	✓	✓	✓	✓
Orange Peel Grapples	GSH420-500	●	●	○	○	●	●	●	●
	GSH420-600	○	○	○	○	●	●	○	○
	GSH420-750	○				○	○	○	○
	GSH520-500	○	○	○	○	●	●	○	○
	GSH520-600	○				○	○	○	○
	GSH520-750					○			

CAT PIN GRABBER COUPLER ATTACHMENTS

Counterweight		3.25 mt (7,165 lb)				3.77 mt (8,311 lb)			
		Reach				Reach			
Boom Type		2.60 m (8'6")	2.90 m (9'6")	2.90 m TR (9'6")	3.10 m (10'2")	2.60 m (8'6")	2.90 m (9'6")	2.90 m TR (9'6")	3.10 m (10'2")
Stick Length									
Hydraulic Hammers	H110 S	✓	✓	✓	✓	✓	✓	✓	✓
	H115 GC S	✓	✓	✓	✓	✓	✓	✓	✓
	H115 S	✓	✓	✓	✓	✓	✓	✓	✓
	H120 S	✓	✓	✓*	✓*	✓	✓	✓	✓
Demolition and Sorting Grapples	G314	✓	✓	✓*	✓*	✓	✓	✓	✓
Mobile Scrap and Demolition Shears	S3015 Flat Top	✓	✓	✓*	✓*	✓	✓	✓	✓
Pulverizers	P214 Secondary Pulverizer	✓*				✓	✓	✓*	✓*
Compactors (Vibratory Plate)	CVP75	✓	✓	✓	✓	✓	✓	✓	✓
Mulchers	HM3013	✓	✓	✓	✓	✓	✓	✓	✓
	HM4015	✓*				✓	✓	✓*	✓*
	HM4815	✓*				✓	✓	✓*	✓*

(continued on next page)

317 Hydraulic Excavator Specifications

Attachments Offering Guide *(continued)*

Not all Attachments are available in all regions. Consult your Cat dealer for configurations available in your region.

Match

* Working range front only

No Match

S60 DEDICATED COUPLER ATTACHMENTS

Counterweight		3.25 mt (7,165 lb)				3.77 mt (8,311 lb)			
		Reach				Reach			
Boom Type		2.60 m (8'6")	2.90 m (9'6")	2.90 m TR (9'6")	3.10 m (10'2")	2.60 m (8'6")	2.90 m (9'6")	2.90 m TR (9'6")	3.10 m (10'2")
Stick Length									
Hydraulic Hammers	H110 S	✓	✓	✓	✓	✓	✓	✓	✓
	H115 GC S	✓	✓	✓	✓	✓	✓	✓	✓
	H115 S	✓	✓	✓	✓	✓	✓	✓	✓
	H120 S	✓	✓	✓	✓	✓	✓	✓	✓
Demolition and Sorting Grapples	G314	✓	✓	✓	✓	✓	✓	✓	✓
Mobile Scrap and Demolition Shears	S3015 Flat Top	✓	✓	✓	✓	✓	✓	✓	✓
Pulverizers	P214 Secondary Pulverizer	✓	✓	✓*	✓	✓	✓	✓	✓
Compactors (Vibratory Plate)	CVP75	✓	✓	✓	✓	✓	✓	✓	✓

HCS60 DEDICATED COUPLER ATTACHMENTS

Counterweight		3.25 mt (7,165 lb)				3.77 mt (8,311 lb)			
		Reach				Reach			
Boom Type		2.60 m (8'6")	2.90 m (9'6")	2.90 m TR (9'6")	3.10 m (10'2")	2.60 m (8'6")	2.90 m (9'6")	2.90 m TR (9'6")	3.10 m (10'2")
Stick Length									
Hydraulic Hammers	H110 S	✓	✓	✓	✓	✓	✓	✓	✓
	H115 S	✓	✓	✓	✓	✓	✓	✓	✓
	H120 S	✓	✓	✓	✓	✓	✓	✓	✓
Demolition and Sorting Grapples	G314	✓	✓	✓	✓	✓	✓	✓	✓
Mobile Scrap and Demolition Shears	S3015 Flat Top	✓	✓	✓	✓	✓	✓	✓	✓
Pulverizers	P214 Secondary Pulverizer	✓	✓*	✓*	✓*	✓	✓	✓	✓
Compactors (Vibratory Plate)	CVP75	✓	✓	✓	✓	✓	✓	✓	✓

(continued on next page)

317 Hydraulic Excavator Specifications

Attachments Offering Guide *(continued)*

Not all Attachments are available in all regions. Consult your Cat dealer for configurations available in your region.

Match * Working range front only No Match

HCS65 DEDICATED COUPLER ATTACHMENTS

Counterweight		3.25 mt (7,165 lb)				3.77 mt (8,311 lb)			
Boom Type		Reach				Reach			
Stick Length		2.60 m (8'6")	2.90 m (9'6")	2.90 m TR (9'6")	3.10 m (10'2")	2.60 m (8'6")	2.90 m (9'6")	2.90 m TR (9'6")	3.10 m (10'2")
Hydraulic Hammers	H110 S	✓	✓	✓	✓	✓	✓	✓	✓
	H115 S	✓	✓	✓	✓	✓	✓	✓	✓
	H120 S	✓	✓	✓*	✓*	✓	✓	✓	✓
Demolition and Sorting Grapples	G314	✓	✓	✓*	✓*	✓	✓	✓	✓
Mobile Scrap and Demolition Shears	S3015 Flat Top	✓	✓	✓*	✓*	✓	✓	✓	✓
Pulverizers	P214 Secondary Pulverizers	✓*	✓*			✓	✓	✓	✓
Compactors (Vibratory Plate)	CVP75	✓	✓	✓	✓	✓	✓	✓	✓

TRS14 (PIN-ON TOP/S60 BOTTOM) ATTACHMENTS

Some attachments require more hydraulic flow and are best suited with a machine that has HP2 circuits and a tiltrotator with a high flow swivel. Check the hydraulic capability of your machine and tiltrotator and the requirements of your attachment to ensure a proper match.

Counterweight		3.25 mt (7,165 lb)				3.77 mt (8,311 lb)			
Boom Type		Reach				Reach			
Stick Length		2.60 m (8'6")	2.90 m (9'6")	2.90 m TR (9'6")	3.10 m (10'2")	2.60 m (8'6")	2.90 m (9'6")	2.90 m TR (9'6")	3.10 m (10'2")
Hydraulic Hammers	H110 S	✓	✓	✓	✓	✓	✓	✓	✓
	H115 GC S	✓	✓	✓	✓	✓	✓	✓	✓
	H115 S	✓	✓	✓	✓	✓	✓	✓	✓
Compactors (Vibratory Plate)	CVP75	✓	✓	✓	✓	✓	✓	✓	✓

NOTE: Hammer on tiltrotator usage less than 10% of working hours. Refer to your OMM for recommended hydraulic flow requirements.

TRS14 (S60 TOP/S60 BOTTOM) ATTACHMENTS

Some attachments require more hydraulic flow and are best suited with a machine that has HP2 circuits and a tiltrotator with a high flow swivel. Check the hydraulic capability of your machine and tiltrotator and the requirements of your attachment to ensure a proper match.

Counterweight		3.25 mt (7,165 lb)				3.77 mt (8,311 lb)			
Boom Type		Reach				Reach			
Stick Length		2.60 m (8'6")	2.90 m (9'6")	2.90 m TR (9'6")	3.10 m (10'2")	2.60 m (8'6")	2.90 m (9'6")	2.90 m TR (9'6")	3.10 m (10'2")
Hydraulic Hammers	H110 S	✓	✓	✓	✓	✓	✓	✓	✓
	H115 GC S	✓	✓*			✓	✓	✓	✓
	H115 S	✓	✓	✓	✓	✓	✓	✓	✓
Compactors (Vibratory Plate)	CVP75	✓	✓	✓	✓	✓	✓	✓	✓

NOTE: Hammer on tiltrotator usage less than 10% of working hours. Refer to your OMM for recommended hydraulic flow requirements.

(continued on next page)

317 Hydraulic Excavator Specifications

Attachments Offering Guide *(continued)*

Not all Attachments are available in all regions. Consult your Cat dealer for configurations available in your region.

Match

* Working range front only

No Match

TRS14 (PIN-ON TOP/HCS60 BOTTOM) ATTACHMENTS

Some attachments require more hydraulic flow and are best suited with a machine that has HP2 circuits and a tiltrotator with a high flow swivel. Check the hydraulic capability of your machine and tiltrotator and the requirements of your attachment to ensure a proper match.

Counterweight		3.25 mt (7,165 lb)				3.77 mt (8,311 lb)			
		Reach				Reach			
Boom Type		2.60 m (8'6")	2.90 m (9'6")	2.90 m TR (9'6")	3.10 m (10'2")	2.60 m (8'6")	2.90 m (9'6")	2.90 m TR (9'6")	3.10 m (10'2")
Hydraulic Hammers	H110 S	✓	✓	✓	✓	✓	✓	✓	✓
	H115 S	✓	✓	✓	✓	✓	✓	✓	✓
Compactors (Vibratory Plate)	CVP75	✓	✓	✓	✓	✓	✓	✓	✓

NOTE: Hammer on tiltrotator usage less than 10% of working hours. Refer to your OMM for recommended hydraulic flow requirements.

TRS14 (HCS60 TOP/HCS60 BOTTOM) ATTACHMENTS

Some attachments require more hydraulic flow and are best suited with a machine that has HP2 circuits and a tiltrotator with a high flow swivel. Check the hydraulic capability of your machine and tiltrotator and the requirements of your attachment to ensure a proper match.

Counterweight		3.25 mt (7,165 lb)				3.77 mt (8,311 lb)			
		Reach				Reach			
Boom Type		2.60 m (8'6")	2.90 m (9'6")	2.90 m TR (9'6")	3.10 m (10'2")	2.60 m (8'6")	2.90 m (9'6")	2.90 m TR (9'6")	3.10 m (10'2")
Hydraulic Hammers	H110 S	✓	✓	✓	✓	✓	✓	✓	✓
	H115 S	✓	✓*	✓*	✓*	✓	✓	✓	✓
Compactors (Vibratory Plate)	CVP75	✓	✓	✓	✓	✓	✓	✓	✓

NOTE: Hammer on tiltrotator usage less than 10% of working hours. Refer to your OMM for recommended hydraulic flow requirements.

TRS14 (PIN-ON TOP/HCS65 BOTTOM) ATTACHMENTS

Some attachments require more hydraulic flow and are best suited with a machine that has HP2 circuits and a tiltrotator with a high flow swivel. Check the hydraulic capability of your machine and tiltrotator and the requirements of your attachment to ensure a proper match.

Counterweight		3.25 mt (7,165 lb)				3.77 mt (8,311 lb)			
		Reach				Reach			
Boom Type		2.60 m (8'6")	2.90 m (9'6")	2.90 m TR (9'6")	3.10 m (10'2")	2.60 m (8'6")	2.90 m (9'6")	2.90 m TR (9'6")	3.10 m (10'2")
Hydraulic Hammers	H110 S	✓	✓	✓	✓	✓	✓	✓	✓
	H115 S	✓	✓	✓*	✓*	✓	✓	✓	✓*
Compactors (Vibratory Plate)	CVP75	✓	✓	✓	✓	✓	✓	✓	✓

NOTE: Hammer on tiltrotator usage less than 10% of working hours. Refer to your OMM for recommended hydraulic flow requirements.

(continued on next page)

317 Hydraulic Excavator Specifications

Attachments Offering Guide *(continued)*

Not all Attachments are available in all regions. Consult your Cat dealer for configurations available in your region.

Match

* Working range front only

No Match

TRS14 (HCS65 TOP/HCS65 BOTTOM) ATTACHMENTS

Some attachments require more hydraulic flow and are best suited with a machine that has HP2 circuits and a tiltrotator with a high flow swivel. Check the hydraulic capability of your machine and tiltrotator and the requirements of your attachment to ensure a proper match.

Counterweight		3.25 mt (7,165 lb)				3.77 mt (8,311 lb)			
		Reach							
Boom Type		Reach				Reach			
Stick Length		2.60 m (8'6")	2.90 m (9'6")	2.90 m TR (9'6")	3.10 m (10'2")	2.60 m (8'6")	2.90 m (9'6")	2.90 m TR (9'6")	3.10 m (10'2")
Hydraulic Hammers	H110 S	✓*	✓*			✓	✓	✓	✓
	H115 S					✓	✓*		
Compactors (Vibratory Plate)	CVP75	✓	✓*	✓*	✓*	✓	✓	✓	✓

NOTE: Hammer on tiltrotator usage less than 10% of working hours. Refer to your OMM for recommended hydraulic flow requirements.

BOOM-MOUNT ATTACHMENTS

Counterweight		3.25 mt (7,165 lb)		3.77 mt (8,311 lb)	
Boom Type		Reach		Reach	
Mobile Scrap and Demolition Shears	S3035 Flat Top	✓		✓	

317 Standard and Optional Equipment

Standard and Optional Equipment

Standard and optional equipment may vary. Consult your Cat dealer for details.

	Standard	Optional		Standard	Optional
BOOMS, STICKS AND LINKAGES			CAT TECHNOLOGY		
5.1 m (16'9") Reach boom	✓		VisionLink®	✓*	
2.6 m (8'6") Reach stick		✓	VisionLink Productivity		✓
2.9 m (9'6") Reach stick		✓	Remote Flash	✓	
2.9 m (9'6") Thumb Ready stick		✓	Remote Troubleshoot	✓	
3.1 m (10'2") Reach stick		✓	Cat Grade Connectivity		✓
Bucket linkage, without lifting eye, Cat Grade	✓		Compatibility with radios and base stations from Trimble, Topcon, and Leica	✓	
CAB			Capability to install 3D grade systems from Trimble, Topcon, and Leica	✓	
ROPS	✓		Cat Grade 2D	✓	
High-resolution 254 mm (10") LCD touchscreen monitor	✓		Cat Grade 2D with Attachment Ready Option (ARO)		✓
Auto bi-level air conditioner	✓		Cat Grade 3D single GNSS		✓
Jog dial and shortcut keys for monitor control	✓		Cat Grade 3D dual GNSS		✓
Keyless push-to-start engine control	✓		Laser catcher		✓
Height-adjustable console	✓		Cat Assist:	✓	
Tilt-up left-side console	✓		– Grade Assist		
Heated air-suspension seat	✓		– Boom Assist		
51 mm (2") seat belt	✓		– Bucket Assist		
Monitor integrated Bluetooth® radio with USB/Auxiliary ports	✓		– Swing Assist		
12V DC outlets	✓		– Lift Assist		
Document storage	✓		Cat Payload	✓	
Overhead storage and rear storage with nets	✓		– Static weigh		
Beverage holder	✓		– Semiautomatic calibration		
Cup holder	✓		– Payload/cycle information		
Openable two-piece front window	✓		– USB reporting capability		
Rear window emergency exit	✓		Work tool recognition (PL161)	✓	
Radial wiper with washer	✓		Work tool tracking (PL161)	✓	
Openable polycarbonate skylight hatch	✓		Cat Tilt Rotator (TRS) Integration		✓
LED dome light	✓		Operator Coaching		✓
Floor welcome light	✓		ELECTRICAL SYSTEM		
Roof sunscreen	✓		Maintenance free battery	✓	
Roller front sunscreen	✓		Centralized electrical disconnect switch	✓	
Roller rear sunscreen		✓	Programmable time-delay LED working lights	✓	
Washable floor mat	✓		LED chassis and left-side boom light – 1,800 lumens	✓	
Beacon ready	✓		LED right-side boom light and cab lights – 1,800 lumens		✓
Cat Stick Steer		✓	360° lighting		✓
Auxiliary relay		✓	*Connect subscription only. Additional subscriptions are available. Contact your Cat dealer for availability.		

(continued on next page)

Standard and Optional Equipment *(continued)*

Standard and optional equipment may vary. Consult your Cat dealer for details.

	Standard	Optional		Standard	Optional
ENGINE			SAFETY AND SECURITY		
Cat® C3.6 single turbo diesel engine	✓		Rear and right-side-view cameras	✓	
Three selectable modes: Power, Smart, Eco	✓		360° visibility		✓
One-touch low idle with automatic engine speed control	✓		Ground level accessible secondary engine shutoff switch in cab	✓	
Auto engine idle shutdown	✓		Lockable disconnect switch	✓	
-18° C (0° F) cold start capability		✓	Service platform with anti-skid plate and countersunk bolts	✓	
-25° C (-13° F) cold start capability		✓	Signaling/warning horn	✓	
Two-stage fuel filtration system with water separator and indicator	✓		Swing alarm		✓
Sealed double element air filter with integrated pre-cleaner	✓		Hydraulic lock out lever	✓	
Electric fuel priming pump	✓		Inspection lighting		✓
Electric cooling fans	✓		2D E-Fence:	✓	
HYDRAULIC SYSTEM			- E-ceiling		
Electronic main control valve	✓		- E-floor		
Single type electronic main pump	✓		- E-swing		
Boom and stick regeneration circuits	✓		- E-wall		
Boom and stick drift reduction valve	✓		- E-cab avoidance		
Automatic hydraulic oil warm up	✓		Auto hammer stop	✓	
Automatic two-speed travel	✓		SERVICE AND MAINTENANCE		
Element type main hydraulic filter	✓		Side entry to service platform	✓	
Dedicated hydraulic circuit for Auxiliary pump		✓	Grouped engine oil and fuel filters	✓	
Hydraulic efficiency monitoring		✓	Ground level engine oil dipstick	✓	
			Scheduled Oil Sampling (S-O-S SM) sampling ports	✓	
			Integrated vehicle health management system	✓	
			UNDERCARRIAGE AND STRUCTURES		
			600 mm (24") triple grouser track shoes		✓
			600 mm (24") rubber track shoes		✓
			700 mm (28") triple grouser track shoes with additional steps		✓
			Grease lubricated track link	✓	
			Center track guiding guard	✓	
			Two-piece segmented track guiding guard		✓
			Bottom without swivel guard	✓	
			Travel motor guards	✓	
			3.25 mt (7,165 lb) counterweight		✓
			3.77 mt (8,311 lb) counterweight		✓
			Tie-down points	✓	
			2600 mm (8'6") blade	✓	
			2700 mm (8'10") blade	✓	

Dealer Installed Kits and Attachments

Attachments may vary. Consult your Cat dealer for details.

CAB

- Radial lower wiper
- Left-hand and right-hand electrical pedal (two-way) for tool control
- Dual exit rear window kit
- Rain protector plus cab light cover
- Front windshield laminated glass (P5A glass, EU demolition regulation)
- Key fob (for use with Bluetooth receiver)

SAFETY AND SECURITY

- 76 mm (3") retractable seat belt

GUARDS

- OPG (not compatible with cab light cover, rain protector)
- Mesh guard full front (not compatible with cab light cover, rain protector)
- Mesh guard lower front half
- Full protecting vandalism guard

The following information applies to the machine at the time of final manufacture as configured for sale in the regions covered in this document. The content of this declaration is valid as of the date issued; however, content related to machine features and specifications are subject to change without notice. For additional information, please see the machine's Operation and Maintenance Manual.

For more information on sustainability in action and our progress, please visit <https://www.caterpillar.com/en/company/sustainability>.

Engine

- The Cat® C3.6 engine meets U.S. EPA Tier 4 Final, EU Stage V, and Japan 2014 emission standards.
- Cat diesel engines are required to use ULSD (ultra-low sulfur diesel fuel with 15 ppm of sulfur or less) or ULSD blended with the following lower-carbon intensity fuels** up to:
 - ✓ 20% biodiesel FAME (fatty acid methyl ester)*
 - ✓ 100% renewable diesel, HVO (hydrotreated vegetable oil) and GTL (gas-to-liquid) fuels

Refer to guidelines for successful application. Please consult your Cat dealer or “Caterpillar Machine Fluids Recommendations” (SEBU6250) for details.

**Engines with no aftertreatment devices can use higher blends, up to 100% biodiesel (for use of blends higher than 20% biodiesel, consult your Cat dealer).*

***Tailpipe greenhouse gas emissions from lower-carbon intensity fuels are essentially the same as traditional fuels.*

Air Conditioning System

- The air conditioning system on this machine contains the fluorinated greenhouse gas refrigerant R134a (Global Warming Potential = 1430). The system contains 0.9 kg (2.0 lb) of refrigerant which has a CO₂ equivalent of 1.418 metric tonnes (1.261 tons).

Paint

- Based on best available knowledge, the maximum allowable concentration, measured in parts per million (PPM), of the following heavy metals in paint are:
 - Barium < 0.01%
 - Cadmium < 0.01%
 - Chromium < 0.01%
 - Lead < 0.01%

Sound Performance

ISO 6395:2008 (external) 101 dB(A)

ISO 6396:2008 (inside cab) 72 dB(A)

- Hearing protection may be needed when operating with an open operator station and cab (when not properly maintained or doors/windows open) for extended periods or in a noisy environment.

Oils and Fluids

- Caterpillar factory fills with ethylene glycol coolants. Cat Diesel Engine Antifreeze/Coolant (DEAC) and Cat Extended Life Coolant (ELC) can be recycled. Consult your Cat dealer for more information.
- Cat Bio HYDO™ Advanced is an EU Ecolabel approved biodegradable hydraulic oil.
- Additional fluids are likely to be present, please consult the Operations and Maintenance Manual or the Application and Installation guide for complete fluid recommendations and maintenance intervals.

Features and Technology

- The following features and technology may contribute to fuel savings and/or carbon reduction. Features may vary. Consult your Cat dealer for details.
 - Advanced hydraulic systems balance power and efficiency
 - Smart mode matches machine power to digging requirements automatically
 - Eco mode minimizes fuel consumption for light applications
 - One-touch low idle with automatic engine speed control
 - Increase operating efficiency up to 45% with standard Cat technologies
 - The latest hydraulic oil filter provides longer life with a 3,000-hour replacement interval
 - Remote Flash and Remote Troubleshoot

For more complete information on Cat products, dealer services, and industry solutions, visit us on the web at www.cat.com

© 2023 Caterpillar
All rights reserved

Materials and specifications are subject to change without notice. Featured machines in photos may include additional equipment. See your Cat dealer for available options.

CAT, CATERPILLAR, LET'S DO THE WORK, their respective logos, "Caterpillar Corporate Yellow," the "Power Edge" and Cat "Modern Hex" trade dress as well as corporate and product identity used herein, are trademarks of Caterpillar and may not be used without permission. VisionLink is a trademark of Caterpillar Inc., registered in the United States and in other countries.

AEXQ3028-05 (12-2023)
Replaces AEXQ3028-04
Build Number: 07E
(N Am)

