

**CAT® PAVING PRODUCTS**

# GUIDE TO ASPHALT COMPACTION

**CATERPILLAR®**





COS48 CAT



**CAT® PAVING PRODUCTS**

# GUIDE TO ASPHALT COMPACTION

The *Guide to Asphalt Compaction* is published by Cat® Paving Products. Every attempt has been made to ensure that specifications and information contained in this book are correct. Performance information is intended for estimating purposes only. Because of the many variables specific to individual asphalt paving jobs (including mix design and characteristics, project specifications, equipment owner application preferences, equipment operator efficiencies, underfoot conditions, altitude, etc.), neither Caterpillar Inc. nor its dealers warrant that the machines and methodologies described herein will perform as estimated. Because equipment specifications and materials are subject to change without notice, check with your Cat Dealer for the latest product information and available options. Machines shown may include optional and/or add-on equipment. CAT, CATERPILLAR, their respective logos, "Caterpillar Yellow," and the POWER EDGE trade dress, as well as the corporate and product identity used herein, are trademarks of Caterpillar and may not be used without permission.

**Note:** Always refer to the appropriate Caterpillar Operation and Maintenance Manual for specific product information.

QEBQ1583

© 2012 Caterpillar Inc. - All rights reserved.

## TABLE OF CONTENTS

<b>Unit 1:</b>	THE BASICS OF COMPACTION	6
<b>Unit 2:</b>	THE FORCES OF COMPACTION	12
<b>Unit 3:</b>	FACTORS THAT AFFECT COMPACTION	28
<b>Unit 4:</b>	METHODS AND SPECIFICATIONS	50
<b>Unit 5:</b>	ROLLING PATTERNS	78
<b>Unit 6:</b>	JOINT COMPACTION	96
<b>Unit 7:</b>	COMPACTION ISSUES	116
	GLOSSARY OF TERMS	136





## INTRODUCTION

The Cat Paving Products *Guide to Asphalt Compaction* is a practical, hands-on reference manual to be used by machine operators, quality control personnel and supervisors. It covers the basic principles of asphalt compaction and provides specific examples of how to use those principles most effectively.

In this guide, the word “asphalt” will be used to describe what may be called “bituminous material” or “asphalt concrete” in some parts of the world. Individual asphalt design formulas are discussed in Unit 3 and those will be referred to using commonly accepted terminology.

The design and manufacture of asphalt varies greatly around the world. Sources of aggregate are different. Likewise, asphalt cements used in the manufacture of asphalt have significant chemical variability. Finally, the types of paving equipment used to lay down asphalt are different in different locations. Therefore, with all this variability, it is impossible to develop specific and detailed asphalt compaction techniques that can be employed in all situations.

However, the principles of asphalt compaction remain the same for all applications. Equipment operators and quality control personnel must have a good understanding of these principles. They must know how to respond to the many variables.





## Unit 1

# THE BASICS OF COMPACTION

Your crew can develop analytical skills that all but guarantee successful asphalt compaction. It starts with a commitment to fundamental best practices and proper planning.



### [ WHAT IS COMPACTION? ]

Asphalt compaction is a mechanical process. Various forces are used to make the asphalt layer denser after the asphalt paver has laid it down. The purpose of compaction is to reduce the amount of air voids in the asphalt layer and to move the aggregate in the layer closer together. Strength is built into the asphalt layer by removing most of the air voids and developing stone-on-stone contact.

Usually compaction starts at the highest temperature possible. Once the asphalt layer has cooled below a given temperature, additional density is difficult or impossible to achieve. Therefore, only a short window of opportunity is normally available to create the required density. Planning and preparation are extremely important for the compaction of asphalt in order to complete the work in a timely manner.

For example, the density of an asphalt layer after it passes under a vibratory screed may be 85% of Theoretical Maximum Density. On another project using a different mix design and the same paving equipment, the density of the asphalt layer may be as low as 78% of Theoretical Maximum Density. Or, using paving equipment with tamping and vibrating screeds that deliver more energy to the asphalt layer, the screed laid density may be as high as 92% of Theoretical Maximum Density.

It is obvious that the compaction process will be different on each of these projects, even though the specified final density may be the same. Operators, quality control personnel and project supervisors must plan each project differently. It is likely that the type and number of compactors will be different. Rolling patterns also will be different.

In some places, public works officials have created method specifications for the compaction process. In those situations the compaction team must follow the specified procedure.

In other places, however, the public works department provides an end-result specification. In those situations, the compaction team is free to develop its own compaction method. For the most part in this guide, an assumption is made that the crew is working toward an end-result specification. A typical method specification is shown in Unit 4.



*Asphalt compaction is started by the paver screed and finished by compactors working immediately behind the paver. Crew members often monitor the compaction process.*

## RELATIVE COST COMPARISON BETWEEN ASPHALT PAVEMENT COMPONENTS

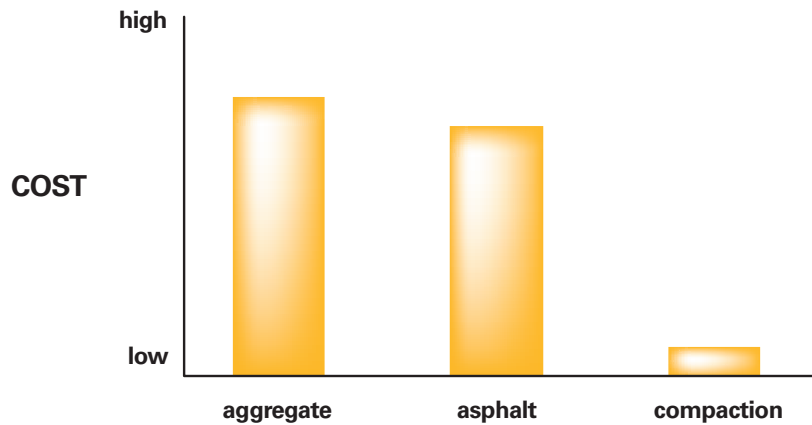

*The compaction process costs very little compared to the cost of aggregate and asphalt cement.*

### [ THE VALUE OF COMPACTION ]

Many years ago, asphalt compaction was considered a necessary evil and the process did not really add value to the pavement structure. In many instances, compactor operators were considered to be at the entry level of operating skills and typically were provided with very little training.

In recent years, the cost of quality aggregates has risen while their availability has declined. The price of asphalt cement has gone up even more. So, the cost relationship between materials and the compaction process places more emphasis on material production and laydown. Compaction actually costs very little per ton of bituminous material.

However, without the specified density, the bituminous material produced and laid down is virtually worthless. The compaction process must be viewed as equally important as production and laydown of material. Compactor operators need training to develop the necessary skills. Quality control personnel must be able to plan the compaction process and to solve problems when there is inadequate density or when the compaction process creates roughness in the surface layer.

## RELATIVE COST COMPARISON BETWEEN EACH COMPONENT'S CONTRIBUTION TO EXTENDED PAVEMENT LIFE

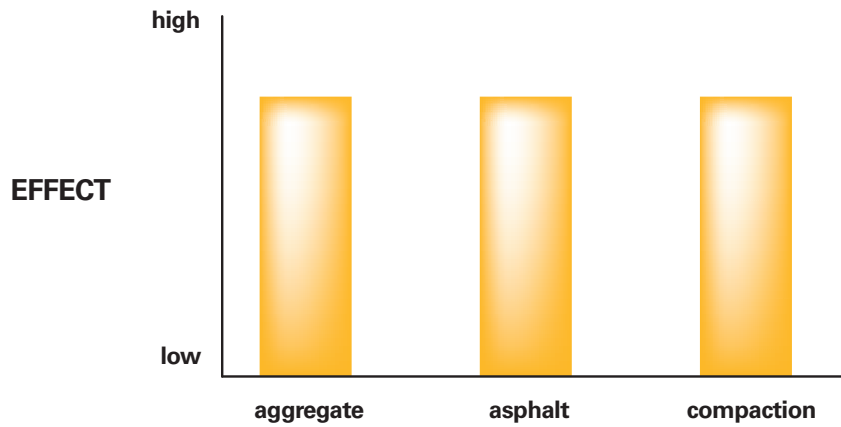

*Compaction has the same value as the material being produced.*

### [ COMPACTION AIDS IN SUSTAINABILITY ]

Properly compacted asphalt structures contribute to sustainability in several ways.

First, an asphalt structure is designed to support traffic volume and load over a given period of time. The design engineer calculates type of material, depths of layers and specified density in each layer to create the needed overall strength.

When the asphalt layers have consistently high density, the structure will usually provide the expected service life or even a service life that exceeds the plan.

When pavement maintenance is delayed because the pavement remains in good condition, energy is saved (fewer emissions) and there is less traffic disruption (inconvenience and higher emissions)

over the life of the structure. It is possible that one maintenance procedure may be eliminated over the life of the structure.

Second, highly-skilled compactor operators know how to create density in the asphalt layer with minimal influence on the smoothness of the surface layer. Plus, high density helps minimize surface defects such as rutting and cracking.

A smooth surface reduces rolling resistance and it takes less energy to propel a given vehicle over the surface at a given speed.

Even if fuel consumption improves by only 1% due to pavement smoothness, the global impact is enormous.

**COMPONENT COSTS VS IMPACT ON PAVEMENT LIFE**

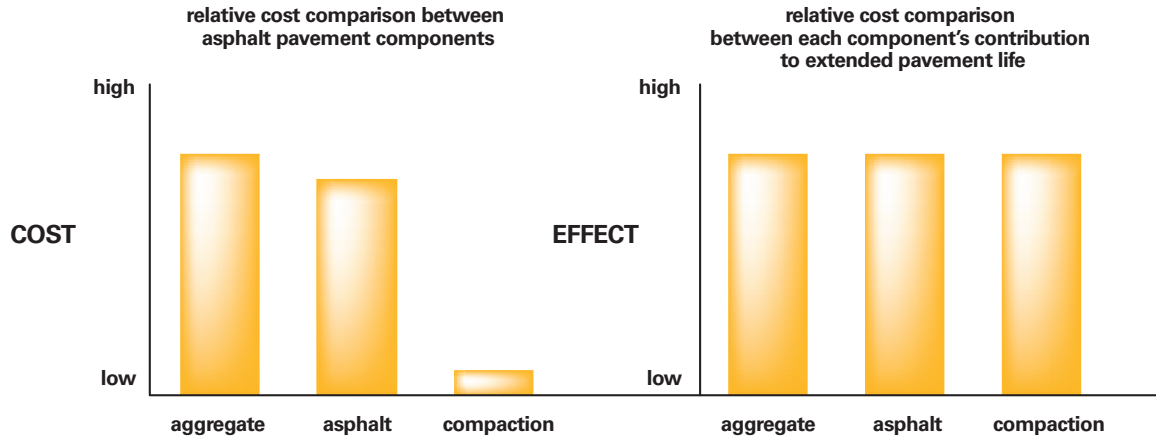

*A close comparison between cost and impact on pavement life.*

**Summary:** *With so much riding on the creation of specified density in asphalt layers, it is important for operators to be trained, for quality control personnel to have problem-solving skills, and for technologically advanced equipment to be used.*

*Compaction problems or issues are usually solvable when the crew plans well and applies fundamental best practices. The goal of this guide is to help all personnel involved in the compaction process to develop those analytical skills and a good working knowledge of best practices.*

*Unit 2 starts with an explanation of the forces that impact asphalt compaction.*





## Unit 2

# THE FORCES OF COMPACTION

Successful crews understand the relationship between the forces of compaction—and how a mat accepts those forces.



# FORCES

Four forces are used to expel air voids and create support in asphalt layers: static load, manipulation, impact and vibration. Machine operators and quality control personnel must understand how to use the four forces in order to create the required density in a productive manner while maintaining the smoothness of the asphalt layer.

Static load and manipulation usually involve lower forces and are the easiest to understand. Static load

is created by a steel drum compactor operated in the static mode or by a pneumatic compactor.

Impact and vibration are dynamic forces and typically generate higher compaction forces. Vibratory steel drum compactors develop impact and vibration forces and typically receive most of the attention.

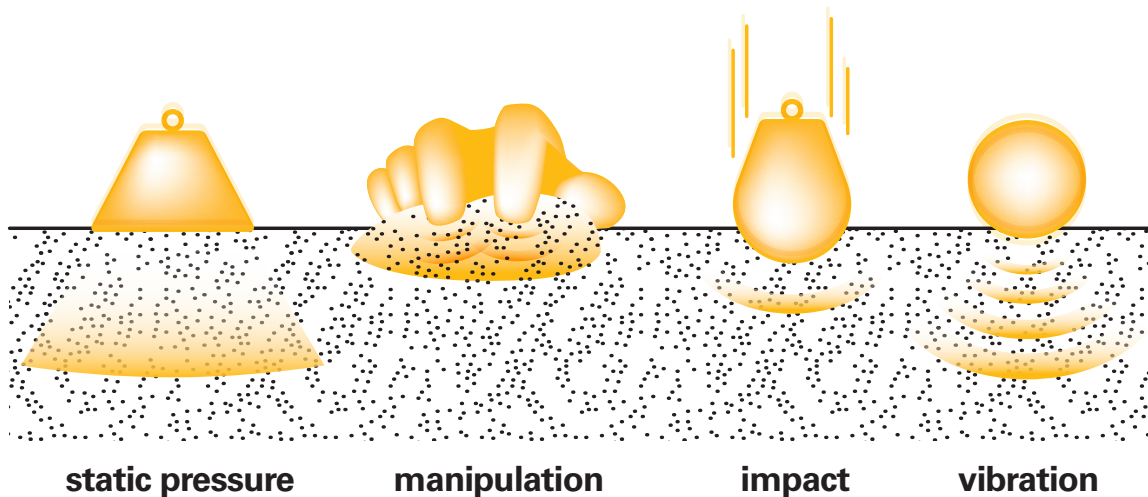

## [ STEEL DRUM STATIC PRESSURE ]

Steel drum compactors operated in the non-vibratory mode apply static pressure on the asphalt mat. The amount of static pressure depends on the weight at the drum and the area of the drum that actually contacts the mat. A higher weight at the drum produces higher static pressure. Likewise a smaller contact area yields higher pressure. Static pressure is rated in bar or pounds per square inch (psi).

A simpler way to look at static force is to divide weight at the drum by width of the drum. This result is expressed as kilograms per centimeter or pounds per inch. It is important to remember

that the highest machine weight does not always produce the highest static load.

The chart below shows three Cat Tandem Vibratory Rollers. The heaviest machine is the CB64, a unit with 213 cm (84") wide drums. The next unit, the CB54XW, weighs less and has drums that are 200 cm (79") wide. The lightest machine is the CB54 with 170 cm (67") drums.

	<b>CB64</b>	<b>CB54XW</b>	<b>CB54</b>
Weight @ drum	6490 kg	5949 kg	5402 kg
Drum width	213 cm	200 cm	170 cm
Static linear load	31 kg/cm	30 kg/cm	32 kg/cm

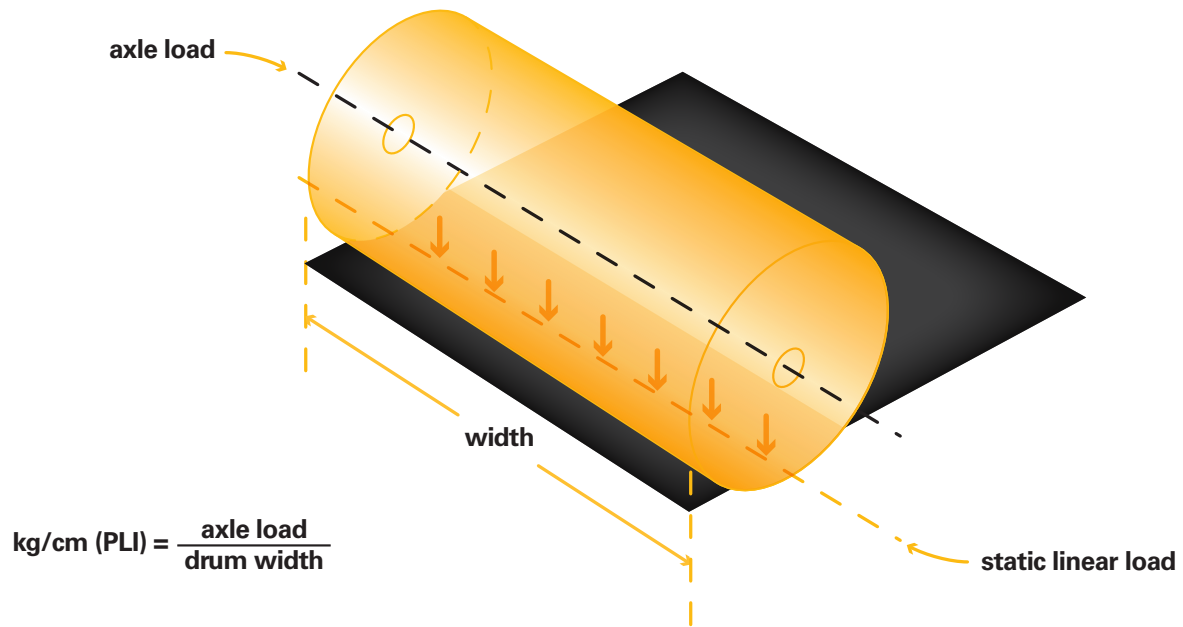

What is interesting to note is that the lightest unit, the CB54, has the highest static linear load. This is often the case because the drums are narrower.

Therefore, if you are working on a project and you need a compactor to deliver a relatively high static force, then you will probably want to use the narrowest drum model available to you that can still match the production requirement.

So, to summarize, classify all your steel drum compactors by static linear load. This knowledge will help you select the right equipment for static applications.

**User Tip:** The finish compaction phase is usually accomplished by a steel drum compactor set in the static mode. A compactor with relatively narrow drums and which has a higher linear load will clean up drum stop marks better than a compactor with wider drums and less linear load. The compactor with narrower drums and higher linear load may even achieve a little more density in the finish phase.

**VARIABLE TIRE PRESSURE EFFECT ON COMPACTION FORCE**

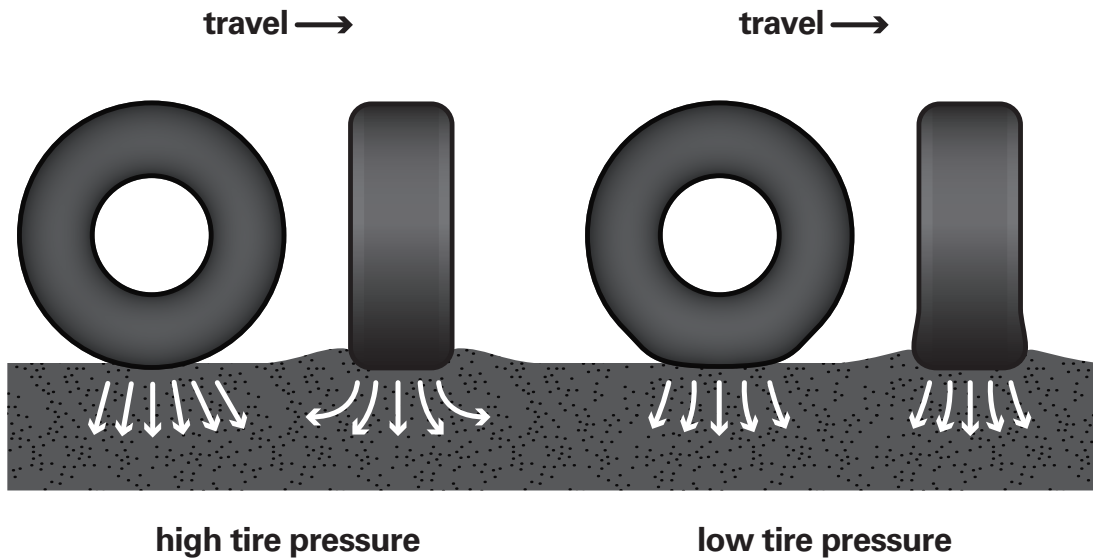

**[ PNEUMATIC COMPACTOR STATIC PRESSURE ]**

The other type of compactor which exerts static force is a pneumatic, or rubber-tire roller. The amount of ground pressure depends on the weight at each tire and the area of the tire in contact with the mat.

You can change the weight at each tire by changing the amount of ballast in the compactor. Adding weight increases the load per tire and static force will penetrate deeper into the mat.

Most pneumatic compactors have ballast tanks that are filled with water, or wet sand, or other material. Some pneumatic compactors come with optional,

removable steel weights. Once the pneumatic compactor has been delivered to the jobsite, its ballasted weight is seldom changed. At the jobsite, the common way to change the amount of static force is by adjusting tire pressure.

When the tire pressure is decreased, the tire flattens more and the contact area is greater. Therefore, less static pressure is applied to the mat.

**CW34 BALLASTED TO 2000 KG AND 3000 KG**

<b>Tire Pressure</b>	<b>Ground Contact Pressure</b>	
	<b>@ 2000 kg</b>	<b>@ 3000 kg</b>
300 kpa (44 psi)	260 kpa (38 psi)	397 kpa (58 psi)
500 kpa (73 psi)	357 kpa (52 psi)	386 kpa (56 psi)
700 kpa (102 psi)	498 kpa (72 psi)	457 kpa (66 psi)
900 kpa (131 psi)	764 kpa (111 psi)	573 kpa (83 psi)



*The air-on-the-run option makes it easier to adjust tire inflation pressure.*

When the tire pressure is increased, the tire stands up straighter and the mat contact area is less. A smaller contact area results in higher static force applied to the mat.

There are two things to be aware of when increasing tire pressure. First, the higher static force will leave deeper cut marks in the surface of the mat. These deep cut marks may be difficult to clean up during the finish compaction phase.

Second, never exceed the manufacturer's recommended maximum tire inflation pressure. Over-inflating rubber tires can cause premature tire failure.

**User Tip:** *When checking and adjusting tire pressures, be sure to inflate each tire to the same pressure. If tire pressures are variable, density across the mat will also be variable. In addition, you may notice that hot asphalt sticks more readily to the under-inflated tire or tires. Tire maintenance and inspection are critical on pneumatic compactors.*

**User Tip:** *Static force exerted by a steel drum compactor or pneumatic compactor is affected by the working speed of the machine. The faster the working speed, the lower the density. Therefore, if you need higher density behind a static compactor, your first change should be to a slower working speed. You can add more passes, too, but a slower working speed should be the first variable that you consider.*

## [ MANIPULATION ]

Manipulation, which is also a static force, occurs when the forces exerted into the mat are not entirely vertical. Instead, the lines of force are sent in many directions. The benefit of manipulation is that this force changes the surface texture by making it tighter. Manipulation is associated with pneumatic compactors and oscillatory compactors.

The staggered, overlapping tires on the axles of pneumatic compactors manipulate the mat under and between the tires in a confined manner. The lines of force are not only vertical but also move

sideways. The vertical forces push down the large aggregate to increase density while the side-to-side forces create a tighter surface finish that helps prevent moisture penetration.

Some compactors have oscillatory drums. Oscillatory drums create tangential, or back-and-forth, lines of force that work primarily on the surface of the mat. Oscillatory force produces the same benefit of manipulation. It tightens and seals the surface of the mat.

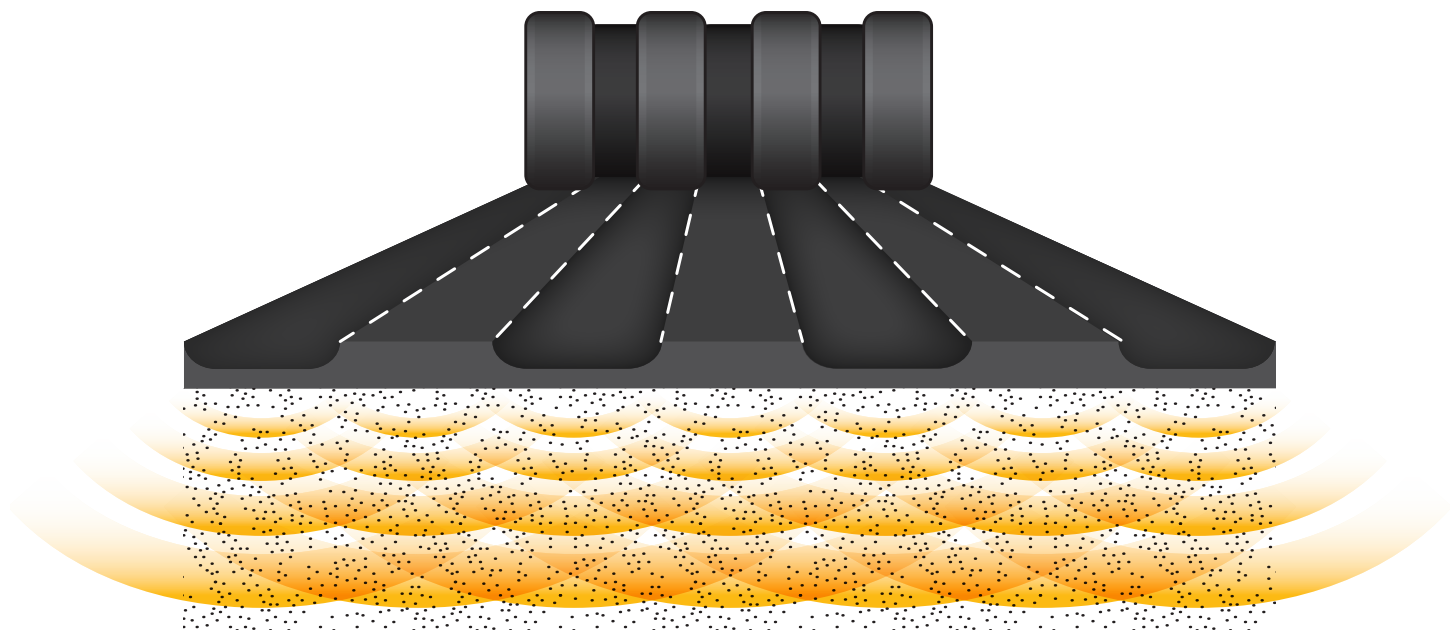

*Overlapping tires develop overlapping areas of contact pressure, creating manipulation forces.*

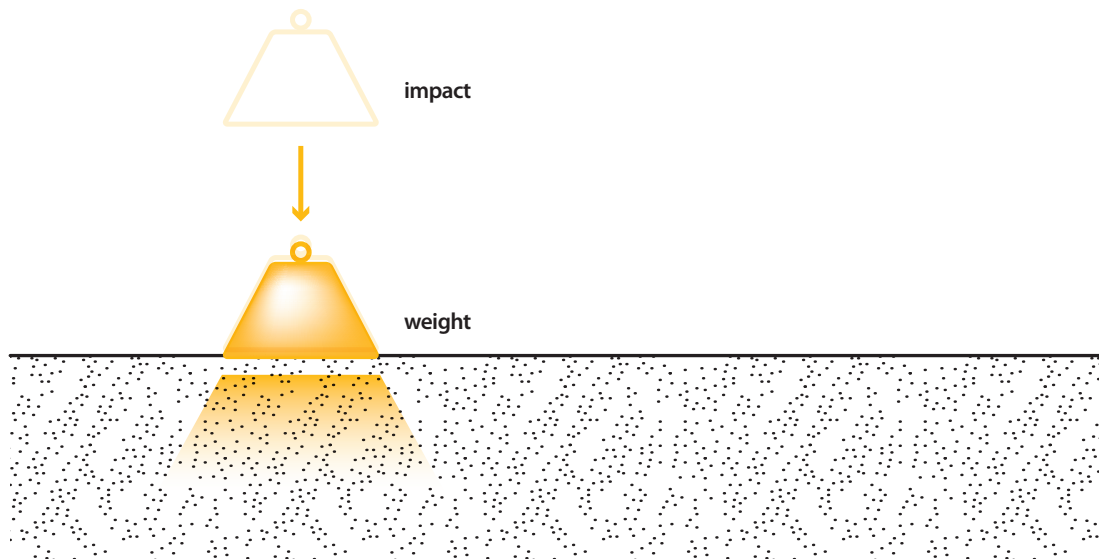

### [ IMPACT ]

Impact, the next compaction force, is dynamic and creates more force on the mat than an equivalent static load. You have already learned that the weight at the drum divided by the width of the drum produces a static linear load.

On vibratory steel drum compactors, the drum actually moves into the mat. The static force of the drum is increased by drum movement or drum impact. The impact generates more energy. The impact energy is strongest at the surface of the mat and diminishes as it penetrates deeper into the mat.

Impact forces create density in the mat faster than static forces. Increased production is the benefit of using vibratory steel drum compactors.

The risk of using impact force is that too much energy may damage the aggregates in the mat. It is possible to over-compact the mat by using too much impact force; mat density can actually decrease when too much force is applied. What is needed for effective compaction is a balance between impact forces and other machine characteristics like weight, working speed and vibration frequency.

## VIBRATION

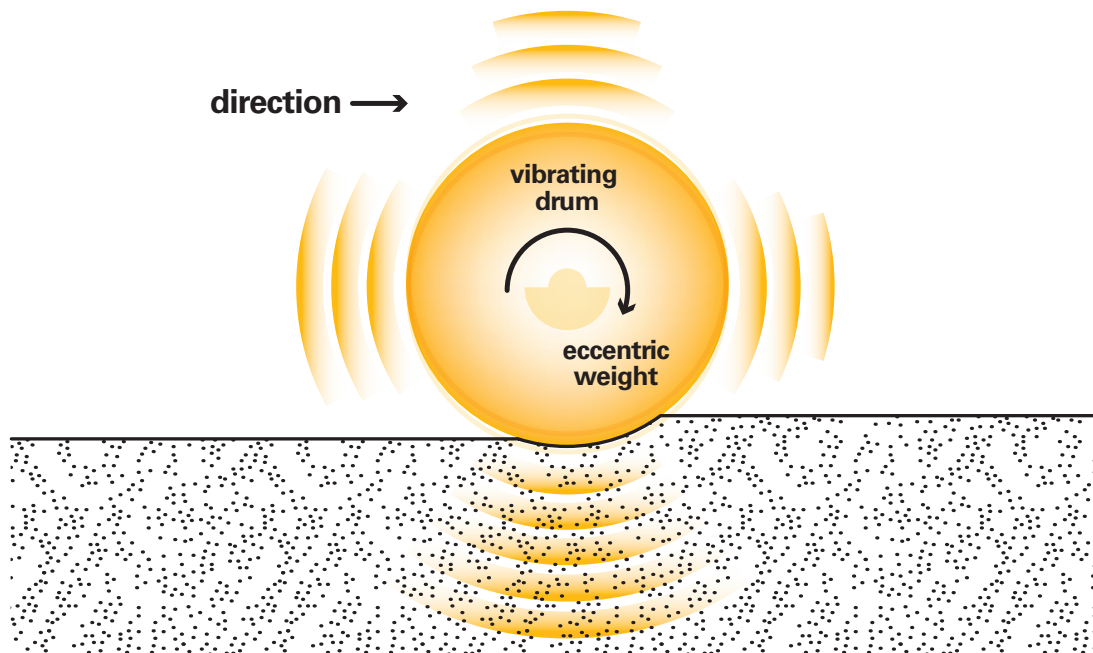

### [ VIBRATION ]

The force of vibration is the most complex of the four compaction forces. Vibratory forces increase the energy developed by weight and impact.

A vibratory shaft is inside the steel drum. On the center of the vibratory shaft, there is an eccentric weight. When the vibratory system is activated, the vibratory shaft begins to spin rapidly. The rotation of the eccentric weight shaft causes the

drum to move, or vibrate, in all directions. Vibration causes a series of pressure waves to be released into the mat. The vibratory pressure waves cause the aggregates in the mat to move. Aggregate movement helps to reorient the larger aggregates so the impact force can more easily reduce the air voids between the aggregates, thereby locking them into contact position.

**User Tip:** In general, select the highest amplitude that will be accepted by the mat without causing the drums to bounce or creating impact marks. Remember, amplitude selection has the greatest impact on the creation of density and, therefore, the production rate of the compactor.



**AMPLITUDE**

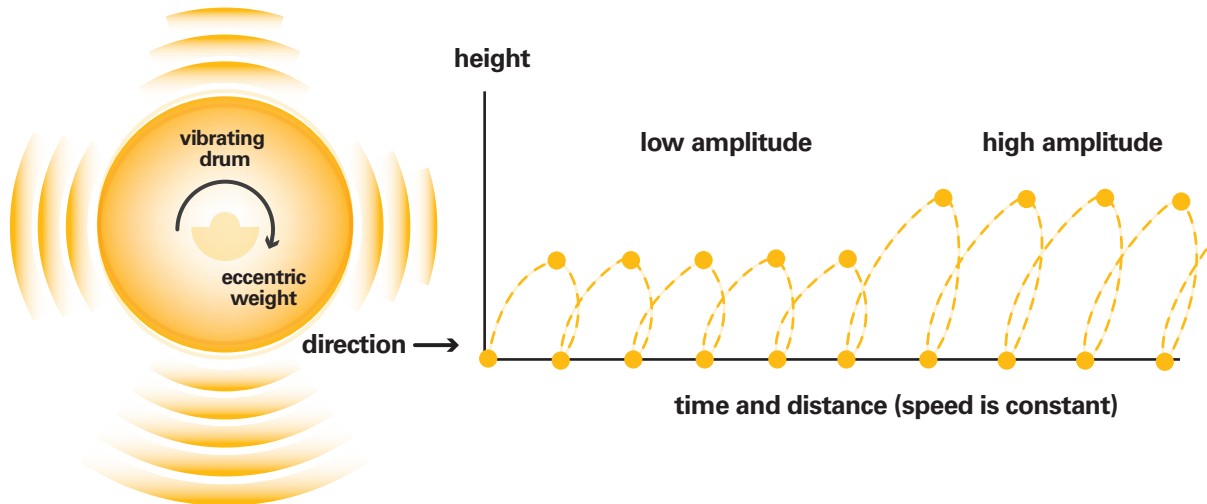

**[ IMPACT EQUALS AMPLITUDE ]**

On a steel drum vibratory compactor, you have learned that the drums move up and down rapidly to create impact and vibration. The impact force caused by the drum moving into the mat is rated by the term known as amplitude.

Amplitude is the distance that the drum moves into the mat. Amplitude is the most significant factor when discussing compaction effectiveness.

Most vibratory compactors offer a variety of amplitude settings. When the amplitude is changed by the operator, the configuration of the eccentric weight inside the drum is changed. When the

eccentric weight is the most off-center, amplitude is the highest and impact force is increased. When the eccentric weight is more balanced, the amplitude is decreased and the impact force is smaller.

All personnel involved in the compaction process should know the amplitude capabilities of each compactor on the job. They should be able to develop a checklist to help them select the correct amplitude, if required.

In general there are three amplitude ranges: low, medium and high.

<b>Low Amplitude Range</b>	0.2 mm to 0.5 mm (0.01" - 0.02")
<b>Medium Amplitude Range</b>	0.5 mm to 0.8 mm (0.02" - 0.03")
<b>High Amplitude Range</b>	Above 0.8 mm (0.03")

## FREQUENCY

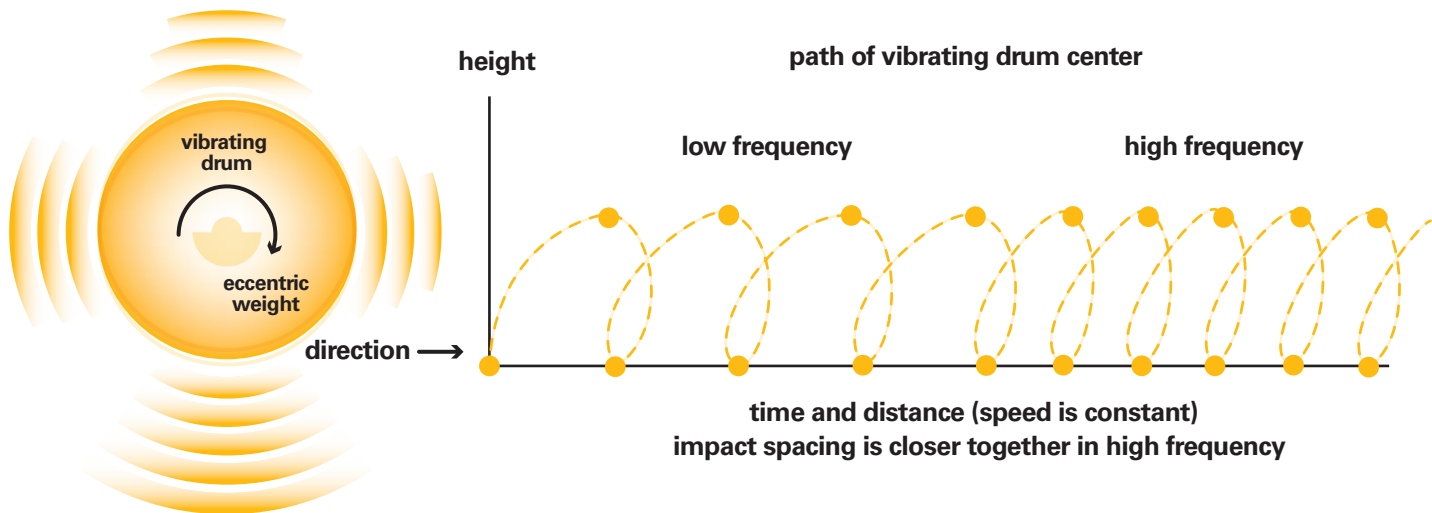

### [ VIBRATION EQUALS FREQUENCY ]

Vibratory force is referred to as frequency. Frequency is defined as the number of times that the drum hits the mat and is rated in Hertz, or vibrations per minute.

The primary effect of vibratory frequency is its relationship to the compactor's working speed. Because the drum is moving into the mat, you need to make sure that these impacts are properly spaced. If the impact spacing is too wide, you can

actually see impact marks at the surface of the mat. If the impact spacing is too narrow, you can see ridges in the surface of the mat. The correct impact spacing occurs when 26 to 46 impacts per meter (8 to 14 impacts per foot) are applied.

Many modern compactors have two vibratory frequencies, or sometimes frequencies that are variable. Frequencies are classified as low, medium or high.

<b>Low Frequency</b>	40 to 47 Hz (2,400 to 2,800 vibrations per minute)
<b>Medium Frequency</b>	47 to 57 Hz (2,800 to 3,400 vibrations per minute)
<b>High Frequency</b>	Above 57 Hz (above 3,400 vibrations per minute)

### [ CONNECTING AMPLITUDE AND FREQUENCY ]

Next, you must understand the relationship between amplitude and frequency. High amplitude is created when the eccentric weight is at its most off-center configuration. When the eccentric weight is in the most off-center or out-of-balance configuration, the eccentric weight shaft has to spin slowly in order to prevent excessive heat and wear on the weight shaft bearing. Therefore, high amplitude can only be associated with low vibratory frequency.

Low amplitude is created when the eccentric weight is in a more balanced configuration. When the eccentric weight shaft is more balanced, it can be spun more rapidly without damaging

the vibratory drum components. Therefore, low amplitude can be associated with either high or low vibratory frequency.

On the job, the compaction team has to determine what are the correct vibratory characteristics in order to achieve density effectively and efficiently. If the mat requires a lot of force or energy in order to reach the specified density, then the crew will select a medium or high amplitude. When higher amplitudes are selected, a lower frequency will always be in use.

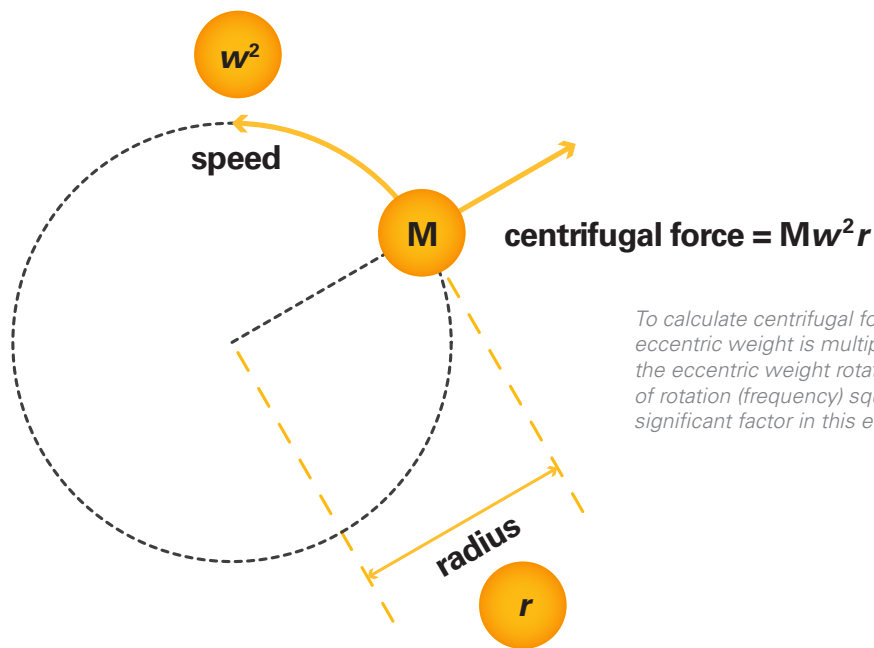

*To calculate centrifugal force, the mass (M) of the eccentric weight is multiplied by the radius (r) of the eccentric weight rotation and by the speed of rotation (frequency) squared ( $w^2$ ). The most significant factor in this equation is frequency.*

**[ WHAT IS CENTRIFUGAL FORCE? ]**

Centrifugal force is a calculation that helps compactor designers establish the correct balance between drum weight, the mass of the eccentric weight and the speed of rotation of the eccentric weight. Centrifugal force has no practical meaning to the compactor operator or to quality control personnel.

There is often confusion about the meaning of centrifugal force as shown in compactor specification material. Many people think the higher the centrifugal force, the higher the compaction energy. This is an incorrect conclusion. A look at

the formula for calculating centrifugal force will help clarify the situation.

To calculate centrifugal force, the mass of the eccentric weight is multiplied by the radius of the eccentric weight rotation and by the speed of rotation (frequency) squared. The most significant factor in this equation is frequency. If frequency increases, centrifugal force is increased significantly. This concept is illustrated by looking at the vibratory system specifications for the Cat Tandem Drum Roller equipped with dual frequency and four amplitudes.

**CAT VIBRATORY SYSTEM**

<b>Frequency</b>	<b>Amplitude</b>	<b>Centrifugal Force</b>
42 Hz (2520 vpm)	High: 0.86 mm (0.034")	89 kN (19,980 lb)
42 Hz (2520 vpm)	Low: 0.73 mm (0.029")	75 kN (16,965 lb)
63 Hz (3800 vpm)	High: 0.44 mm (0.017")	103 kN (23,243 lb)
63 Hz (3800 vpm)	Low: 0.33 mm (0.013")	78 kN (17,438 lb)

On this machine, the highest centrifugal force numbers result when high frequency is selected. In high frequency, the amplitude, or impact force, is relatively small.

The lowest centrifugal force numbers result when low frequency is selected. As shown earlier, amplitudes are always higher when low frequency

is selected. So, as the chart shows, higher centrifugal force does not necessarily correspond to higher compaction energy. Higher centrifugal force often means lower compaction energy. Compactor operators and quality control personnel are advised to ignore centrifugal force when considering vibratory system characteristics.

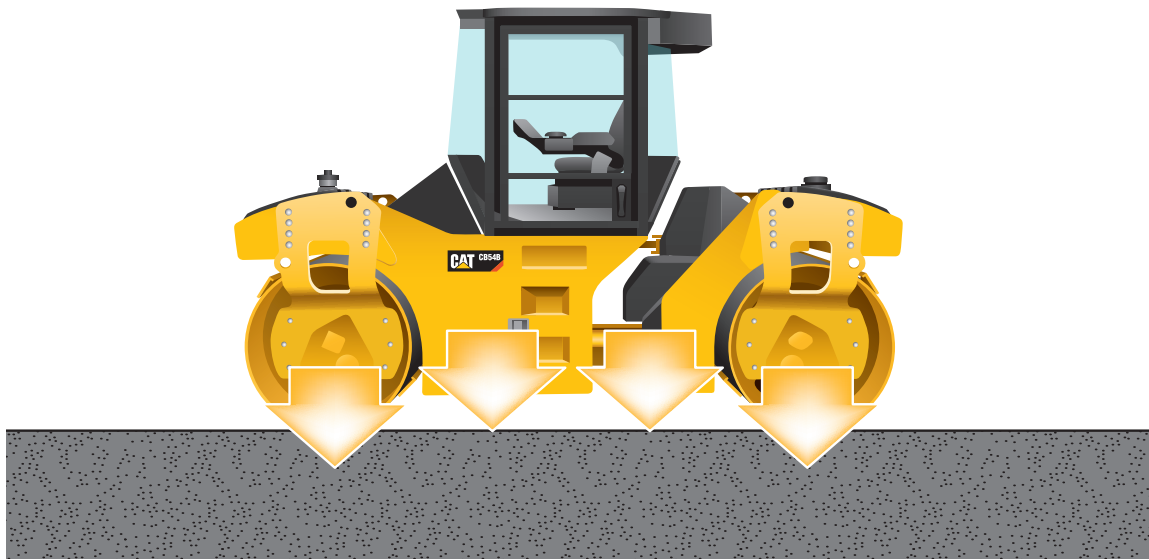

*When compaction is balanced, most of the vibratory force is transmitted into the mat.*

### [ **BALANCED COMPACTOR VIBRATION** ]

When everything is in balance—amplitude, frequency, machine speed and drum weight—then impact and vibration forces are accepted by the mat. All vibratory characteristics are working together close to what is called system resonance and the machine operates smoothly. In this condition, most of the vibratory force is transmitted into the mat. The transmitted compaction force is maximized for the most productive operation.

Using the same machine on the same mat, you can select the same amplitude, but increase the frequency. Centrifugal force increases with

the increase in frequency. The machine may no longer have the correct system resonance. In this condition, some of the compaction energy is not accepted by the mat, but instead is sent back up to the machine. The drums begin to lose contact with the mat. When the drums bounce, the operator loses steering control. Unbalanced vibration provides less effective compaction, may damage the mat, and is uncomfortable for the operator.

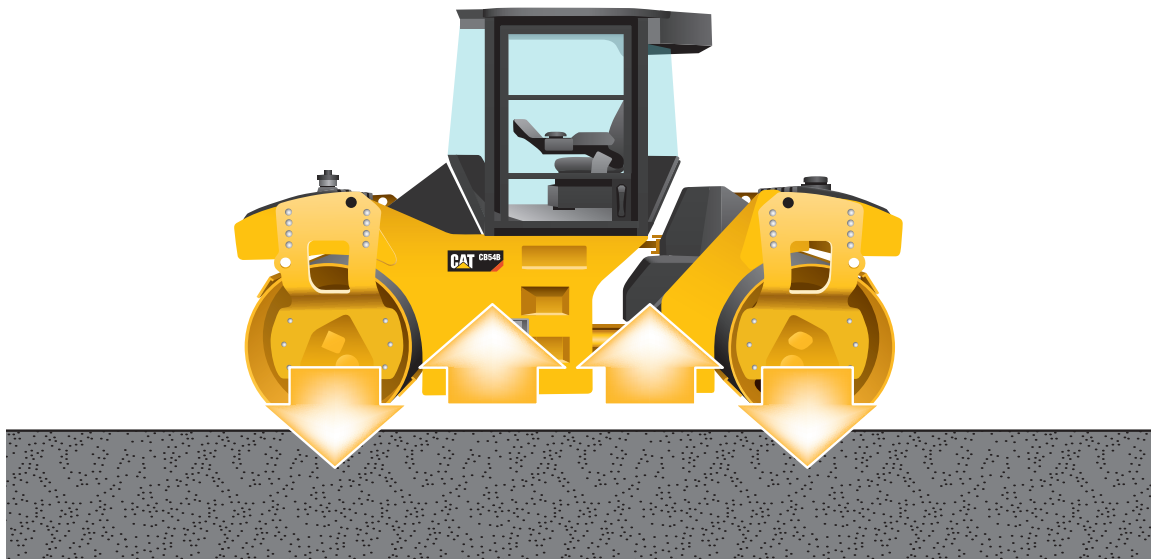

*Some compaction energy will be transferred back to the machine if compaction is not balanced.*

**User Tip:** *If drum bouncing occurs, try one of the following to restore smooth operation:*

- *Check the working speed to make sure you are operating in the range that produces 26 to 46 impacts per meter (8 to 14 impacts per foot).*
- *Switch to a lower amplitude setting.*
- *If available on the machine, switch to a higher frequency.*
- *Operate with one drum vibrating and one drum static.*
- *Operate in the static mode.*

**Summary:** *The forces of compaction and other machine characteristics are related. It is important for the crew to understand the relationship between the forces of compaction and how a mat accepts these forces. When the forces of compaction and other characteristics are aligned properly, efficient compaction will result.*





## Unit 3

# FACTORS THAT AFFECT COMPACTION

Compaction is about more than experience—about more than what happened on the last job. Your compaction process will be more successful when you learn what information to gather, and how to interpret it.



## FACTORS

In Unit Two, you learned about the forces of compaction and other factors that affect asphalt compaction.

Those factors, such as frequency, amplitude, working speed and drum width, can be controlled by the compaction crew.

Many other factors that affect asphalt compaction cannot be controlled by compactor operators, on-site quality control personnel and supervisors.

Those factors include:

- Project design
- Mix design
- Asphalt layer thickness
- Mix temperature
- Climate conditions

It is important that operators and quality control personnel have information about these factors because they must consider them when developing the compaction techniques best suited for each unique project.

## ROAD SECTION

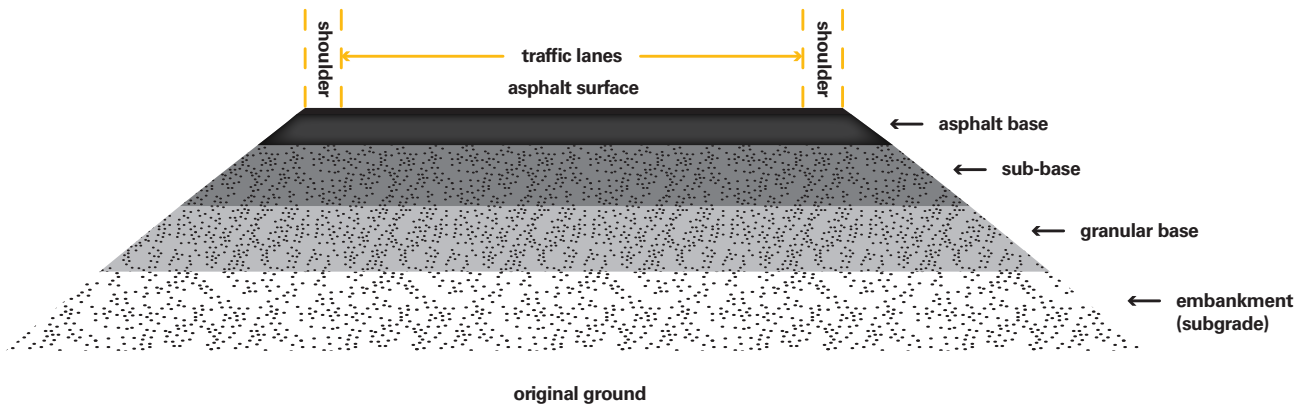

### [ PROJECT DESIGN ]

The design of the paving project affects compaction techniques. On new road construction or total reconstruction projects, multiple layers of asphalt will typically be applied. Each layer is made up of different material and has a different thickness. The first layer, called the base, is laid down on

aggregate base or stabilized subgrade and normally consists of mix with fairly large aggregates. This is usually the thickest layer. It is being laid on a flexible base so high compaction energy is usually needed to achieve required density.

**User Tip:** Any time you are compacting asphalt laid on a granular base, you need to remember that some of the compactor's impact force, or amplitude, will be absorbed by the somewhat flexible base. As you create your checklist for selecting amplitude, always consider the type of base under the asphalt layer. If it is a rigid base like a milled surface, you have to be careful not to use too much amplitude. If the base is flexible, there is less worry about using medium or high amplitudes.

Often a second layer of asphalt, called the binder or intermediate layer, is used. The binder layer is usually thinner than the base layer and utilizes smaller aggregate. The binder layer normally requires less compaction energy to achieve the desired density. The base and binder layers contribute to structural support. The Intermediate course can contribute to drainage in conjunction with open-graded wearing courses.

Finally a surface layer, sometimes called the wear layer or friction layer, is applied. The surface layer is ordinarily the thinnest layer and is made up of the smallest aggregate. The surface layer is designed to be the stiffest layer and to contribute the most to pavement strength. Because the surface layer is usually relatively thin and laid down over a rigid surface, lower compaction energy is needed.

### PERPETUAL PAVEMENT DESIGN

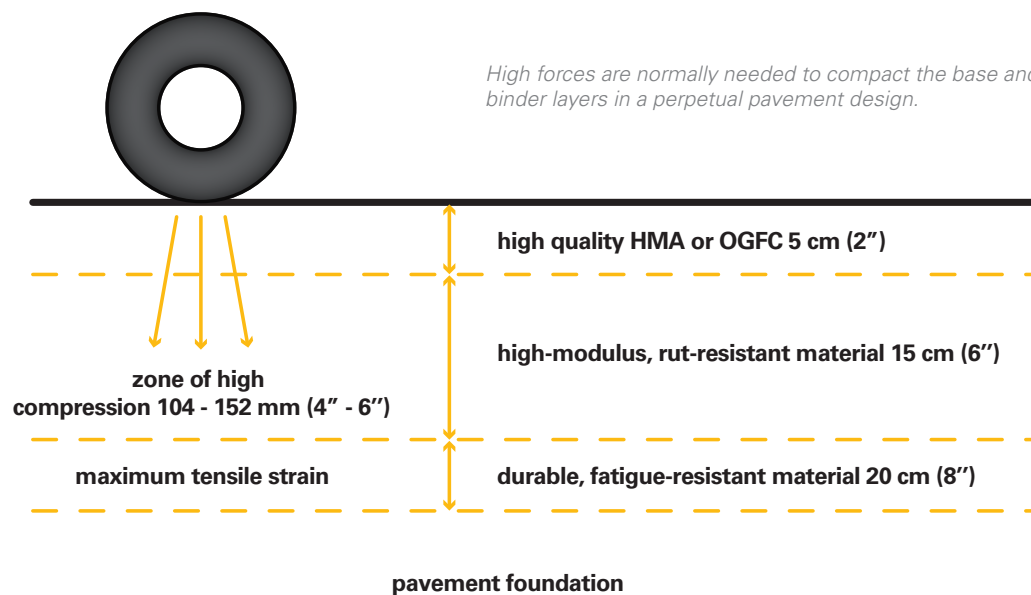

Perpetual pavement is a term used to describe another, long-life structural design. Perpetual pavement is designed to withstand an almost infinite number of axle loads without structural deterioration. Thick asphalt layers, sometimes totaling up to 60 cm (22"), limit the level of load-induced strain at the bottom of the asphalt layers.

Perpetual pavement design usually uses high-quality, deformation-resistant mixes. Most lower layers in the perpetual layer design require a high degree of compaction energy to reach the specified density.

Another very common pavement compaction application is compacting one or two fairly thin layers on a milled surface. Much of the work on asphalt structures now consists of maintenance through partial depth removal and repaving.

Following the cold planing step, there may be a leveling layer and then a surface layer. Seldom are these layers in excess of 50 mm (2"). Therefore, lower compaction energy is normally used for this application.



*Compaction of thin layers on milled surfaces usually requires less compaction force.*

### [ MIX DESIGN ]

Asphalt is a generic term that includes many different types of mixtures of aggregates, fines, modifiers and asphalt cement produced in an asphalt plant at temperatures between 145° C and 190° C (300-350° F). A variation of traditional hot-mix asphalt is warm-mix asphalt. Warm-mix asphalt technology enables mix production and lay down at temperatures up to 40° C (100° F) lower than conventional hot-mix asphalt without sacrificing performance. In this manual, compaction of hot-mix asphalt and warm-mix asphalt designs is approached in the same manner.

Dense-graded mixes are produced with continuously graded aggregate. In other words, there are a

variety of sizes of aggregates in the design. The design formula includes asphalt cement and fines. Typically the larger aggregates are surrounded by a matrix of mastic composed of asphalt cement and fines. The asphalt cement may be modified by materials such as polymer or latex rubber to develop additional stiffness.

Because the larger aggregates are surrounded by the mixture of asphalt cement and fines, there is less danger of damaging aggregates through the use of high compaction force. Depending on the layer thickness, medium to high amplitude is often selected when compacting dense-graded mixes.

**User Tip:** *Continuing to add to the checklist for amplitude selection, the type of asphalt cement must be considered. If the asphalt cement has modifiers like polymers, fibers or latex rubber, the viscosity of the asphalt cement will be high. Moving the aggregates closer together during the compaction process will be more difficult due to the high viscosity of the modified asphalt cement. Therefore, you should be thinking of higher amplitudes when you know there is high-viscosity asphalt cement in the layer being compacted. Information about the type of asphalt cement can be found in the job mix formula that should be available to supervisors and quality control personnel.*

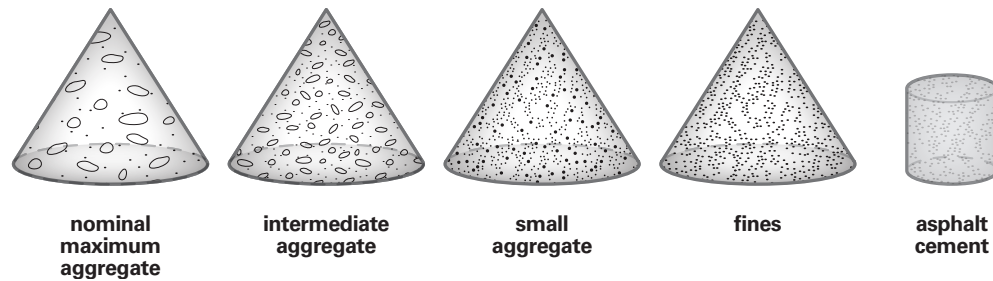
**DENSE-GRADED MIX**

Dense-graded mixes are often classified as either coarse or fine. Coarse mixes have a maximum aggregate size of 19 mm (3/4") or larger. Coarse mixes are usually laid down in fairly thick layers of 75 mm (3") or thicker. Mats that consist

of coarse mix are less likely to move around under heavy compaction energy. You can use vibratory compactors in higher amplitude ranges and pneumatic compactors with higher ground pressures.

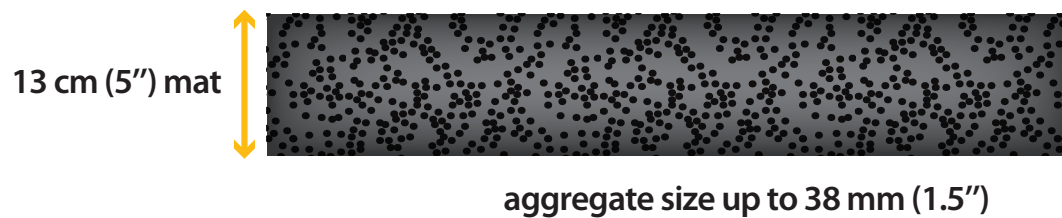
**COARSE OR HARSH MIX**

*Dense-graded mixes with large aggregates are referred to as coarse mixes.*

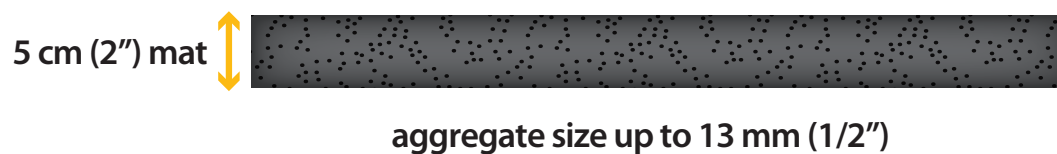
**FINE OR TENDER MIX**

*Dense-graded mixes with smaller aggregates are referred to as fine mixes.*

Some dense-graded mixes are classified as fine mixes. Fine mixes have a maximum aggregate up to 13 mm (1/2") and typically a fairly large percent of fines and asphalt cement. Some fine mixes can be unstable during the compaction process, especially if layer thickness exceeds 50 mm (2"). Static

compaction may be needed to help stabilize fine mixes prior to vibratory passes. High compaction energy can damage layers of fine mix. Lighter compactors, either steel drum or pneumatic, are recommended for use on fine mixes.

**OPEN-GRADED MIX**

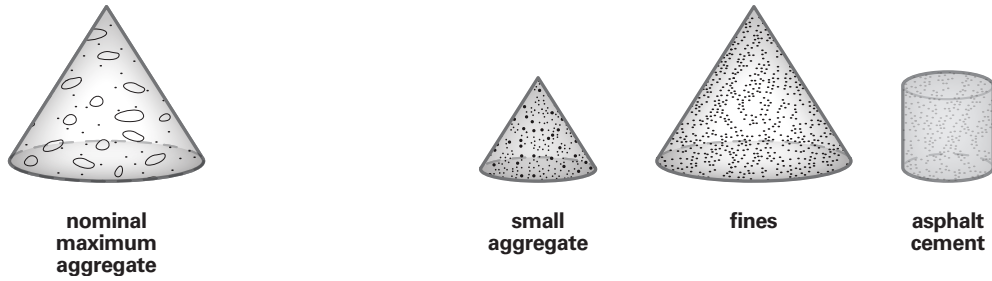

Open-graded mixes have relatively uniform-sized aggregate typified by an absence of intermediate sized particles. Mix designs typical of this structure are permeable friction layers and asphalt-treated permeable bases. Because of their open structures, precautions are taken to minimize the amount of

asphalt cement draining to the bottom of the layer by using modified asphalt cement, usually latex rubber or fibers. Stone-on-stone contact with a heavy asphalt cement particle coating is typical for open-graded mixes.

**GAP-GRADED MIX**

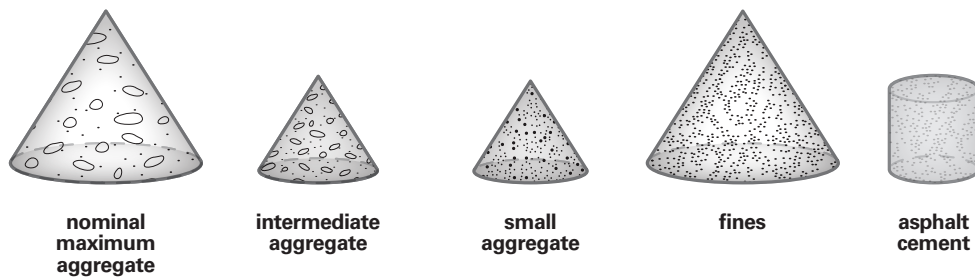

Gap-graded mixes use an aggregate gradation with particles ranging from large to fine with some intermediate sizes missing. Gap-graded mixes are

also typified by stone-on-stone contact and are more permeable than dense-graded mixes.

## STONE-MATRIX ASPHALT

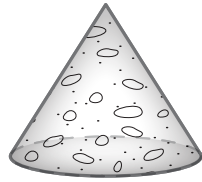

**nominal  
maximum  
aggregate**

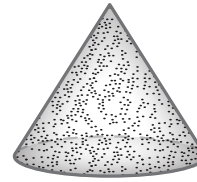

**fines**

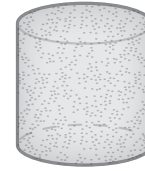

**asphalt  
cement**

Stone-matrix asphalt (SMA), like other open-graded mixes, will be missing most intermediate aggregate sizes. However, stone-matrix asphalt mixes have a much higher proportion of fines. Modified asphalt

cement combines with these fines to produce a thick mastic coating around and between the large aggregate particles.

**User Tip:** *Open-graded mixes, gap-graded mixes and stone-matrix asphalt all have more stone-on-stone contact than dense-graded mixes. Because of the high stone-on-stone contact, there is more likelihood that aggregates will be damaged during the compaction process. Lower amplitude settings on vibratory compactors or static compaction is usually recommended for these types of mixes. Method specifications that control the compaction process when these mixes are used may apply. Additionally, some SMA mixes that are heavily modified may be extremely stiff and may require more compaction force.*

**[ AGGREGATE SHAPE ]**

Aggregate shape also affects compaction. The shape of the aggregate determines the amount of internal friction between the particles.

Rounded aggregates have low internal friction and move closer together within the layer under less compaction energy. However, mixes with rounded aggregates tend to be unstable and move around under the weight of the compactor. Therefore, when you know the shape of the aggregate is rounded, select low vibratory amplitude or a light static compactor.

Angular aggregates, on the other hand, have high internal friction. Once they are moved into contact with each other, angular aggregates produce high pavement strength. More force and heavier compactors are needed to overcome the internal friction between the fractured faces of crushed stone aggregate. Most high-traffic mix designs specify the use of crushed aggregates with a certain number and shape of fractured faces.

**ROUNDED AGGREGATES**  
**low internal friction**

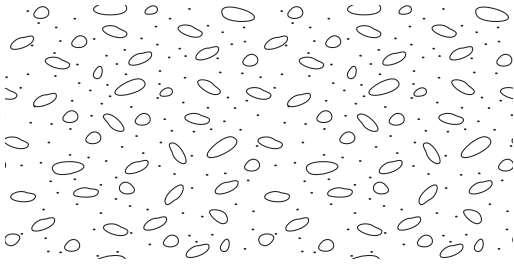

**ANGULAR AGGREGATES**  
**high internal friction**

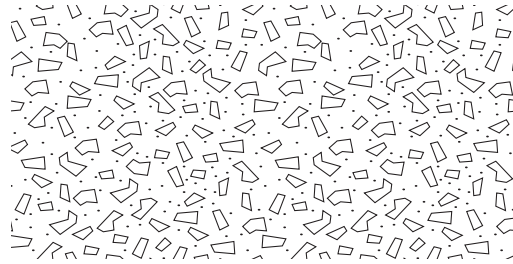



### [ LAYER THICKNESS / AGGREGATE SIZE ]

No matter what type of mix or what type of project, a very important factor is the ratio between the size of the largest aggregate in the mix and the thickness of the layer. This ratio strongly affects the ability of the mat to accept compaction energy and reach the specified density.

For example, a layer thickness of 10 cm (4") and a maximum aggregate size of 25 mm (1") is relatively easy to compact. You can use high compaction forces and not worry about damaging aggregates.

With a 4:1 ratio, there is ample space for aggregate movement allowing the aggregates to re-orient. Many public works departments specify a 3:1 ratio as a minimum for high-traffic mix design.

#### 4:1 RATIO LAYER THICKNESS TO AGGREGATE SIZE

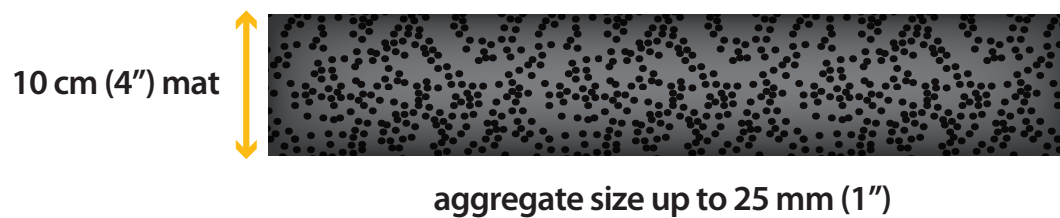

#### 2:1 RATIO LAYER THICKNESS TO AGGREGATE SIZE



## FACTORS

When the ratio of layer thickness to aggregate size is less than 3:1, the compaction process is much more difficult. In particular, when there are angular aggregates in the layer, it is likely that those aggregates will not move into the proper compacted orientation without being damaged. The compactor operator is more likely to notice

drum bouncing or the appearance of uncoated rock at the surface of the mat. Lack of density and damaged aggregates will lead to premature mat failure. When the ratio of layer thickness to aggregate size is less than 3:1, low compaction energy is needed.



*Mat thickness can be variable when slope control is used by the paving crew.*

**User Tip:** Even though the design may call for the required minimum 3:1 ratio, there are instances when the ratio of layer thickness to aggregate size will be less. The most common situation occurs when slope control is used on the paving equipment to create profile. Slope control of the paver screed means that mat thickness will probably be variable across the width of the mat. The left half of the mat may be 75 mm to 50 mm (3-2") thick and the right half of the mat may be 50 mm to 25 mm (2-1") thick. The left side of the mat will compact normally, but the drums will probably begin to bounce when the compactor moves over to the right side. Less compaction energy is needed on the right side. The easiest solution to the problem is operating the compactor with one drum vibrating and one drum static, or both drums static. Changing vibratory system operation can be done easily with the flip of a switch at the operator station. The operator does not have to get off the machine and change the amplitude setting to overcome the drum bouncing.

### [ MIX TEMPERATURE ]

The next factor, temperature of the asphalt layer, has a major effect on compaction. Creating density in any asphalt layer normally is the easiest at the highest possible temperature. At high temperature, the asphalt cement that is part of the mix is at its lowest viscosity. The aggregates in the mix move closer together easily when the asphalt cement is fluid, or at its lowest viscosity. The asphalt cement becomes stiffer as it cools. The aggregates in the mix lock in position and no more air can be forced out.

Depending on how a mix performs at high temperatures, the upper limit that permits compaction is approximately 160° C (320° F).

Some types of mixes may be unstable at high temperatures and will move in front of the drum rather than consolidate under the drum. Mixes that are unstable at high temperatures usually have a high percentage of small aggregate, fines and asphalt cement. When a mix deforms due to high temperatures, the solution is to stay farther behind the paver to allow the mat to cool enough to permit normal compaction.



Most, if not all, the required layer density should be completed by the time the mat cools to about 90° C (190° F). At this temperature the asphalt becomes so stiff that no additional aggregate movement is possible. While you may be able to clean up marks in the surface of the mat, it's not likely that you will get additional density. If the mat is cooling before required density is reached:

- Work closer to the paver
- Increase compaction energy
- Add more compactors

There are exceptions to the general rules concerning upper and lower temperature limits for compaction. Some mixes have a tender zone that is between the traditional upper and lower temperature limits. The mat will compact normally in a very high temperature range. Then it will become unstable in an intermediate temperature range, usually called the tender zone.



*One sign that the compactor is working in a tender zone is a rolled over and cracked drum edge cut mark.*

If a compactor operates on the mat during the tender zone, you will normally see the mat moving in front of the drum or pneumatic tires. Another sign that you are operating in the tender zone will be the appearance of a rolled-over and cracked drum edge cut mark. Normally the drum edge leaves a straight cut mark. The rolled-over cut mark that indicates the compactor is in the tender zone is probably easier for the operator to see.

When compacting a mix that has a tender zone, you need to achieve as much density as possible in the high temperature zone. Compaction should normally be stopped when the mat enters the tender zone. When the tender zone ends, the mat normally becomes stable again and additional density can be achieved. The mat should be close to final density before the tender zone starts. When the tender zone ends and compaction starts again, select low amplitude to avoid drum bouncing on the cool, dense mat.

### [ CLIMATE CONDITIONS ]

The final factor that influences compaction is climate, primarily ambient temperature and wind conditions. On hot, sunny days with high ambient temperatures, the mat retains its heat longer, so the period of workability is increased.

On cool and windy days, the mat loses heat faster. A crust can actually form over the surface of the mix and prevent the compaction forces from uniformly penetrating into the mat.

Checking mat temperature is done in two ways. The most common is to use an infrared temperature scanner. The scanner provides a quick check of the surface temperature at a certain point. The operator or quality control technician can quickly monitor mat temperatures at various locations. The other way to check mat temperature is using a probe thermometer. The probe shows the internal temperature of the mat and is a better indicator of how the mix will react to the forces of compaction.

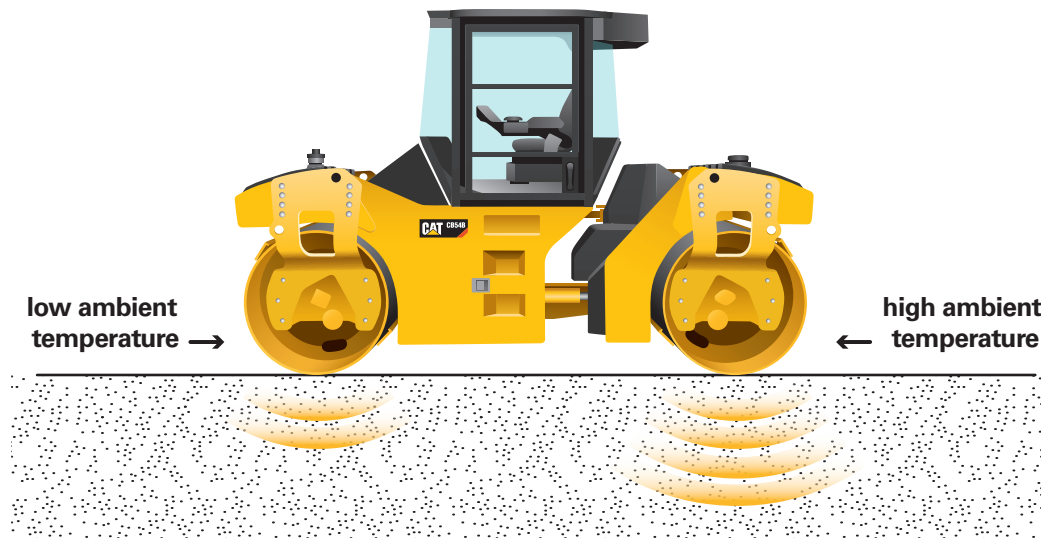

**User Tip:** Compactor operators may have to adjust their rolling patterns as ambient conditions change throughout the day. In the morning when the temperature is normally the lowest, a short rolling pattern may be used in order to stay very close to the paver. As the ambient temperature increases and the mat stays hot longer, the compactor operators can increase the length of their rolling patterns and not worry as much about staying close to the paver.

All these temperature and mix design factors are important because they determine how much time you have to get the required density before the mat cools to below 90° C (190° F). You can also use this information to determine how much time you have before the start of a tender zone, if any exists.

In the past, quality control personnel had to use engineering charts to determine the time

available for compaction based on layer thickness, layer temperature behind the paver and ambient conditions. Today, there are several software programs available to calculate the time with more accuracy and faster. One type of software is called PaveCool (PaveCoolVersion 2.400 copyright 2001-2005 Minnesota Department of Transportation). A series of PaveCool calculations follows.

**User Tip:** Mat surface temperature is always lower than the mat’s internal temperature. If available, use a probe to check internal temperature. Then use the infrared scanner to check surface temperature at the same location. You may find that the surface temperature is up to 15° C (30° F) cooler than the internal temperature. Knowing the temperature differential will allow you to correlate the surface temperature shown by the scanner to the actual internal temperature.

**User Tip:** Caterpillar recommends that quality control personnel develop a series of cooling curves prior to the start of a project. The cooling curves should represent any changes in layer thickness and should anticipate changes in mix temperature and ambient conditions.

**User Tip:** Cooling curves are also extremely useful when compacting mixes that have a tender zone. You can set the PaveCool software to show the length of time prior to the start of tenderness and the length of time that tenderness will persist.

## [ COOLING CURVES ]

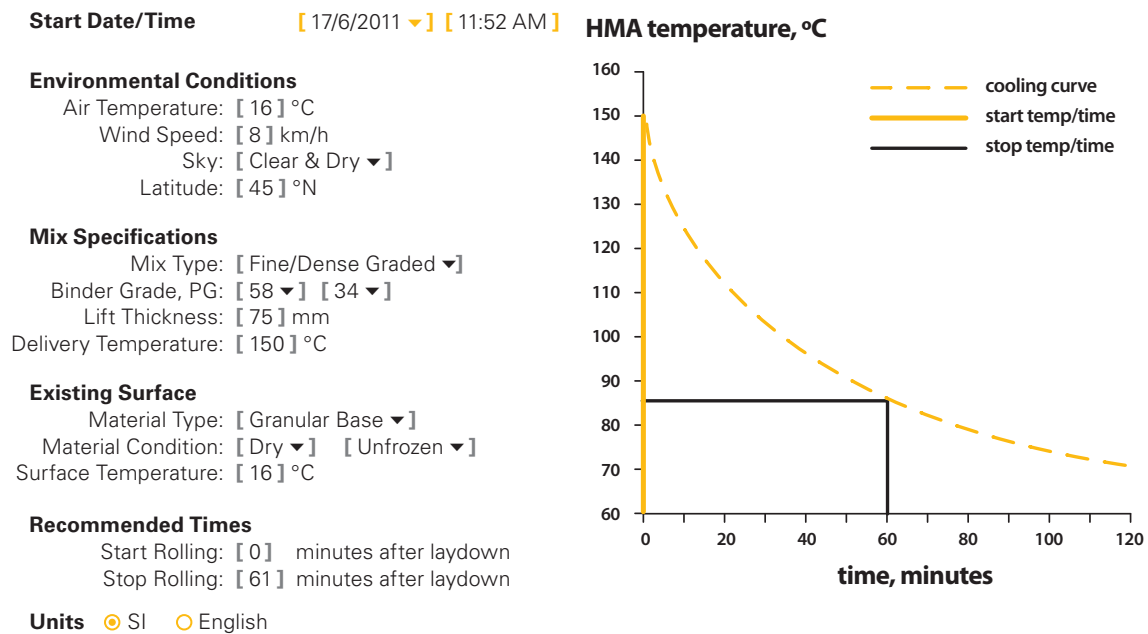

PaveCool software requires input on environmental conditions, mix specifications, and the existing surface. In this example, the air temperature is 16° C (60° F), the wind is light, it is sunny and the project is located near Paris, France (45° north latitude). The asphalt layer consists of dense-graded material laid 75 mm (3") thick, and passing under the paver screed at 150° C (302° F). The asphalt layer is being laid down on granular material that is also 16° C (61° F). The resulting cooling curve shows that there are 61 minutes for compaction before the mat cools to the minimum temperature that has been set at 85° C (185° F).

Start Date/Time [ 17/6/2011 ▼ ] [ 11:52 AM ]

**Environmental Conditions**

Air Temperature: [ 16 ] °C  
 Wind Speed: [ 8 ] km/h  
 Sky: [ Clear & Dry ▼ ]  
 Latitude: [ 45 ] °N

**Mix Specifications**

Mix Type: [ Fine/Dense Graded ▼ ]  
 Binder Grade, PG: [ 58 ▼ ] [ 34 ▼ ]  
 Lift Thickness: [ 50 ] mm  
 Delivery Temperature: [ 150 ] °C

**Existing Surface**

Material Type: [ Granular Base ▼ ]  
 Material Condition: [ Dry ▼ ] [ Unfrozen ▼ ]  
 Surface Temperature: [ 16 ] °C

**Recommended Times**

Start Rolling: [ 0 ] minutes after laydown  
 Stop Rolling: [ 31 ] minutes after laydown

Units  SI  English

HMA temperature, °C

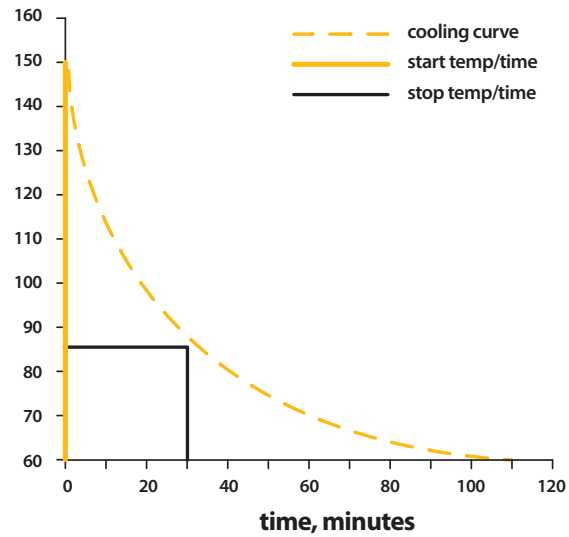

In this example, all the inputs are the same except the layer thickness has been changed to 50 mm (2"). When the new cooling curve is calculated, the time available for compaction had decreased by 50%. Time available for compaction is now 31 minutes.

Start Date/Time [ 17/6/2011 ▼ ] [ 11:52 AM ]

**Environmental Conditions**

Air Temperature: [ 16 ] °C  
 Wind Speed: [ 8 ] km/h  
 Sky: [ Clear & Dry ▼ ]  
 Latitude: [ 45 ] °N

**Mix Specifications**

Mix Type: [ Fine/Dense Graded ▼ ]  
 Binder Grade, PG: [ 58 ▼ ] [ 34 ▼ ]  
 Lift Thickness: [ 38 ] mm  
 Delivery Temperature: [ 150 ] °C

**Existing Surface**

Material Type: [ Granular Base ▼ ]  
 Material Condition: [ Dry ▼ ] [ Unfrozen ▼ ]  
 Surface Temperature: [ 16 ] °C

**Recommended Times**

Start Rolling: [ 0 ] minutes after laydown  
 Stop Rolling: [ 19 ] minutes after laydown

Units  SI  English

HMA temperature, °C

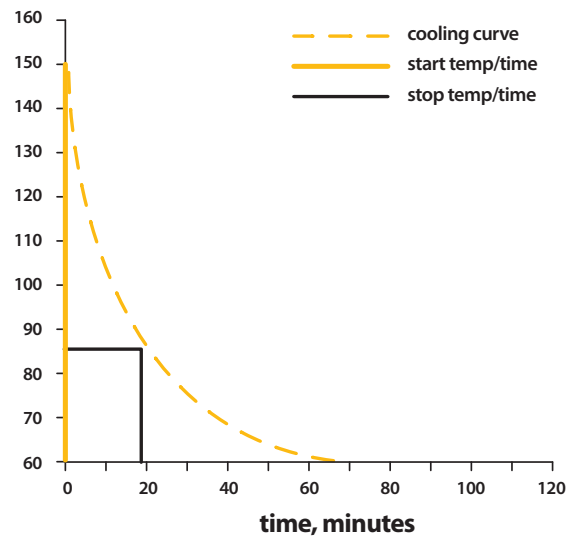

Next, assume that you are laying down a relatively thin surface layer that is 38 mm (1.5") thick. Everything else remains the same. The cooling curve shows that only 19 minutes are available for compaction.

Layer thickness has a major impact on the time available for compaction. The thinner the layer, the more difficult the compaction process. Knowing

how much time is available to get density on thin mats will help you determine rolling patterns and the number of compactors needed for the project.



Offset drum capability facilitates wider coverage for faster compaction on thin mats that lose heat rapidly.

**User Tip:** Some compactors feature the ability to offset the front and rear drums to almost double the width of the compaction coverage. Therefore, fewer overlapping passes are generally required to cover the width of the mat. With the drums offset, the amount of compaction force delivered to the mat is reduced. However, thin mats require less compaction force and the compactor is able to work closer to the paver where the mat is hotter and more susceptible to compaction.

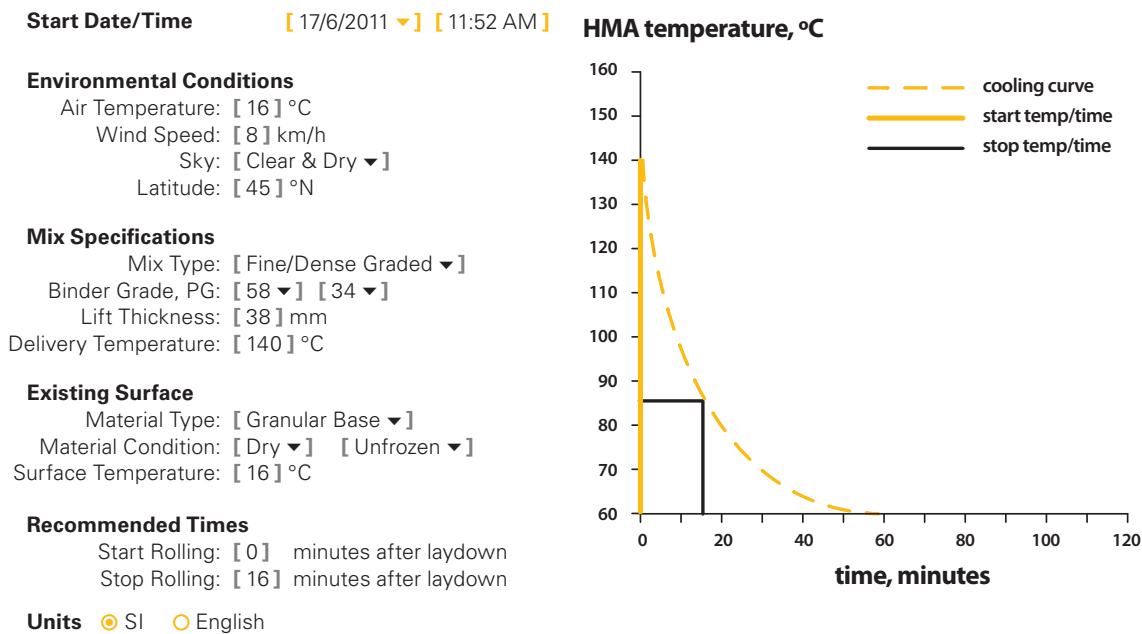

Next, consider how mat temperature affects the time available for compaction. In this example, mat thickness is 38 mm (1.5"), but the temperature of the mat passing under the screed is lowered to 140° C (284° F). Compared to mat temperature of 150° C (302° F) where 19 minutes was available for compaction, the slightly cooler mat reduces the time available for compaction to 16 minutes.



Start Date/Time [ 17/6/2011 ▼ ] [ 11:52 AM ]

**Environmental Conditions**

Air Temperature: [ 16 ] °C  
 Wind Speed: [ 8 ] km/h  
 Sky: [ Clear & Dry ▼ ]  
 Latitude: [ 45 ] °N

**Mix Specifications**

Mix Type: [ Fine/Dense Graded ▼ ]  
 Binder Grade, PG: [ 58 ▼ ] [ 34 ▼ ]  
 Lift Thickness: [ 38 ] mm  
 Delivery Temperature: [ 130 ] °C

**Existing Surface**

Material Type: [ Granular Base ▼ ]  
 Material Condition: [ Dry ▼ ] [ Unfrozen ▼ ]  
 Surface Temperature: [ 16 ] °C

**Recommended Times**

Start Rolling: [ 0 ] minutes after laydown  
 Stop Rolling: [ 12 ] minutes after laydown

Units  SI  English

**HMA temperature, °C**

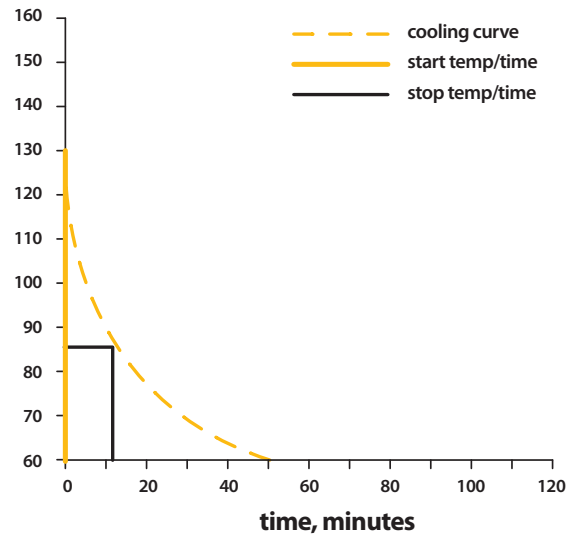

Finally, when the mat temperature is lowered to 130° C (266° F), the time available for compaction drops to 12 minutes. Lowering the mat temperature does reduce the time available for compaction but not to the extent that mat thickness affects time available for compaction.

Start Date/Time [ 17/6/2011 ▼ ] [ 11:52 AM ]

**Environmental Conditions**

Air Temperature: [ 10 ] °C  
 Wind Speed: [ 8 ] km/h  
 Sky: [ Clear & Dry ▼ ]  
 Latitude: [ 45 ] °N

**Mix Specifications**

Mix Type: [ Fine/Dense Graded ▼ ]  
 Binder Grade, PG: [ 58 ▼ ] [ 34 ▼ ]  
 Lift Thickness: [ 75 ] mm  
 Delivery Temperature: [ 150 ] °C

**Existing Surface**

Material Type: [ Granular Base ▼ ]  
 Material Condition: [ Dry ▼ ] [ Unfrozen ▼ ]  
 Surface Temperature: [ 10 ] °C

**Recommended Times**

Start Rolling: [ 0 ] minutes after laydown  
 Stop Rolling: [ 54 ] minutes after laydown

Units  SI  English

**HMA temperature, °C**

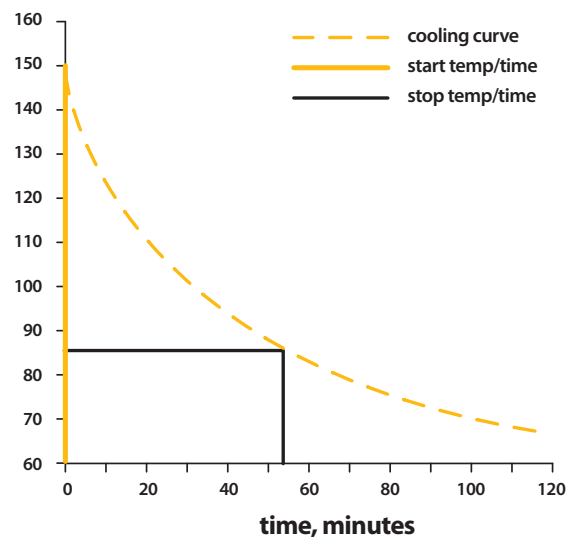

Now consider the affect of ambient temperature on the time available for compaction. In this example, mat thickness reverts to 75 mm (3"). When the ambient temperature was 16° C (61° F), there were 61 minutes available for compaction. When the ambient temperature is reduced to 10° C (50° F), the time available for compaction is reduced by about 10% down to 54 minutes.

# FACTORS

**Start Date/Time** [ 17/6/2011 ▼ ] [ 11:52 AM ]

**Environmental Conditions**

Air Temperature: [ 5 ] °C  
 Wind Speed: [ 8 ] km/h  
 Sky: [ Clear & Dry ▼ ]  
 Latitude: [ 45 ] °N

**Mix Specifications**

Mix Type: [ Fine/Dense Graded ▼ ]  
 Binder Grade, PG: [ 58 ▼ ] [ 34 ▼ ]  
 Lift Thickness: [ 75 ] mm  
 Delivery Temperature: [ 150 ] °C

**Existing Surface**

Material Type: [ Granular Base ▼ ]  
 Material Condition: [ Dry ▼ ] [ Unfrozen ▼ ]  
 Surface Temperature: [ 5 ] °C

**Recommended Times**

Start Rolling: [ 0 ] minutes after laydown  
 Stop Rolling: [ 49 ] minutes after laydown

**Units**  SI  English

**HMA temperature, °C**

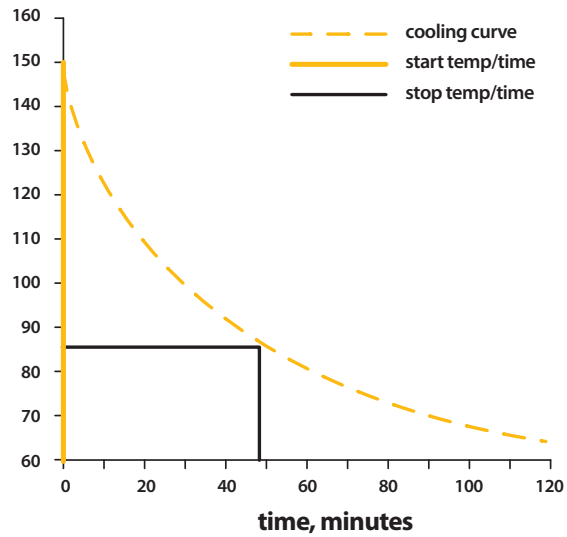

Finally, the ambient temperature is reduced to 5° C (41° F). Time available for compaction is reduced again to 49 minutes. It is evident that reducing ambient temperature reduces time available for compaction, however, not to the extent resulting from reduced mat thickness.

**Start Date/Time** [ 17/6/2011 ▼ ] [ 11:52 AM ]

**Environmental Conditions**

Air Temperature: [ 16 ] °C  
 Wind Speed: [ 8 ] km/h  
 Sky: [ Clear & Dry ▼ ]  
 Latitude: [ 45 ] °N

**Mix Specifications**

Mix Type: [ Fine/Dense Graded ▼ ]  
 Binder Grade, PG: [ 58 ▼ ] [ 34 ▼ ]  
 Lift Thickness: [ 65 ] mm  
 Delivery Temperature: [ 150 ] °C

**Existing Surface**

Material Type: [ Granular Base ▼ ]  
 Material Condition: [ Dry ▼ ] [ Unfrozen ▼ ]  
 Surface Temperature: [ 16 ] °C

**Recommended Times**

Start Rolling: [ 12 ] minutes after laydown  
 Stop Rolling: [ 52 ] minutes after laydown

**Units**  SI  English

**HMA temperature, °C**

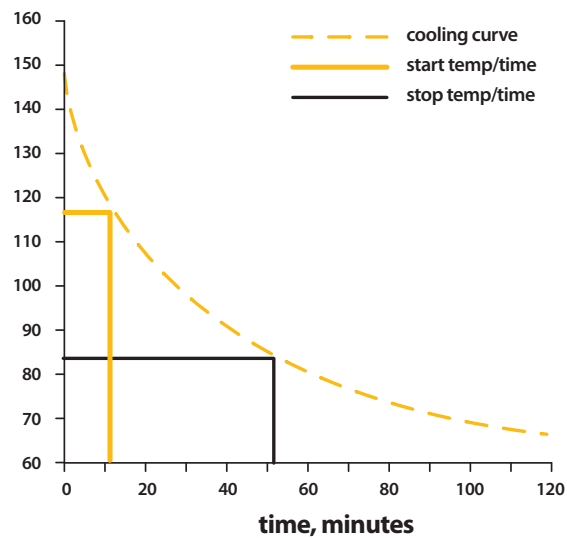

In this example, the ambient temperature is 16° C (61° F). We are laying down a dense-graded mix at a depth of 65 mm (2.5"). The mix is passing under the screed at 150° C (302° F). Documentation indicates that the mix begins to display tenderness at 115° C (239° F) and that the mat becomes stable again at 85° C (185° F). The cooling curve shows that there are 12 minutes available for compaction prior to the start of the tender zone. You will want to achieve as much density as possible during this 12-minute period and then stay off the mat for 40 minutes. After the tender zone disappears, high frequency with low amplitude is commonly used to gain additional density if needed. Or, static rolling to clean up any drum marks may be all that is necessary. Again, knowing the time available for compaction before the tender zone will help you set up the rolling pattern and determine the number and types of compaction equipment.

### [ AMPLITUDE CHECKLIST ]

In Unit 2, you learned that amplitude is defined as the distance the drum moves into the mat and that the impact force created by drum movement is the primary factor for creating density in an asphalt layer. You also learned that too much amplitude can damage an asphalt layer. Selecting the correct amplitude is a vital step during the planning process for any asphalt compaction application.

The compactor operator, quality control technician or supervisor need to create a checklist of the factors covered in Unit 3. Whether this is a mental checklist or a printed form, each factor must be considered. Following is a sample checklist.

### AMPLITUDE CHECKLIST

<b>Factor</b>	<b>Low Force</b>	<b>High Force</b>
Layer Thickness	< 50 mm (2")	>50 mm (2")
Base Support	Rigid	Flexible
Oil Viscosity	Low	High
Aggregate Shape	Rounded	Angular
Ambient Temperature	High	Low

This checklist helps tie together all the compaction factors that have been covered in Unit Three and will help determine how much compaction force is needed for a particular application. Down the left side are the application factors that would tend to result in selecting medium-amplitude settings. Down the right side are the application factors that would tend to lead to the selection of medium- or high-amplitude settings.

As a rule, layer thickness less than 50 mm (2") would not accept high compaction energy. Therefore, amplitude settings in the range 0.25 mm to 0.6 mm (0.01 - 0.025") would typically be selected. When the asphalt layer is thicker than 50 mm (2"), the mat can accept more compaction energy and you would tend to select amplitude that is 0.6 mm (0.025") or higher.

The type of base being paved over has an effect on amplitude selection. If the base is rigid, like a milled surface or an existing asphalt surface, too much compaction energy will cause drum bouncing more easily. If you are paving over granular material or stabilized subgrade, that type of base is more yielding. You would tend to select higher amplitudes for that application because the flexible base will absorb some of the compaction energy.

You also need to consider the type of asphalt cement used in a particular mix design. If the asphalt cement has been modified with fibers or latex rubber, for example, the oil will have high viscosity, the mix will be considered stiff and will need higher forces. Unmodified asphalt cement has a lower viscosity and that mix will need lower compaction energy to achieve the required density.

Always consider the shape of the aggregate in the mix design. Most high-traffic, highway-class asphalt structures use mixes with all fractured faces.

The angular aggregates produce high internal friction. You would tend to select higher amplitude settings in order to move the rock and remove air voids.

Most street and parking lot mixes have aggregates with some rounded faces. Since the aggregate moves more easily, these mixes require lower compaction energy.

Climate conditions are the final factor in the checklist. On hot, sunny days, asphalt layers tend to retain their heat longer and since you have more time you can use lower forces.

When the ambient temperature is low and there are high winds, the asphalt layer will cool off rapidly. In order to reach density before the mat loses too much temperature, you would select the highest amplitude setting to try to hit density quickly. Following are two examples of how using the checklist can be beneficial.

[ **AMPLITUDE SELECTION EXERCISE I** ]

**AMPLITUDE CHECKLIST**

<b>Factor</b>	<b>Low Force</b>	<b>High Force</b>
Layer Thickness	40 mm (1.6")	–
Base Support	Milled Surface	–
Oil Viscosity	–	High
Aggregate Shape	–	Crushed
Ambient Temperature	–	10° C (50° F)

On this project, the paver is laying down a 40 mm (1.6") thick layer of dense-graded asphalt with polymer-modified asphalt cement, largest aggregate size 12.5 mm (1/2") and aggregate with all fractured faces. This is a single layer of asphalt being laid on a milled surface. Looking at the amplitude checklist, you'll see that two of the factors are on the lower force side, while three of the factors indicate higher force will be needed.

Does this mean that you should select a medium to high amplitude?

In this application, you would probably select a low to medium amplitude. The layer thickness, less than 50 mm (2"), and the rigid base would not accept high amplitude energy. Sometimes certain factors, especially layer thickness, are more important than other factors in the amplitude checklist. Selecting the correct amplitude is not always easy. Remember the general rule when selecting amplitude: Select the highest amplitude that the mat can accept without creating drum bouncing or damage to the mat.

## [ AMPLITUDE SELECTION EXERCISE 2 ]

## AMPLITUDE CHECKLIST

<b>Factor</b>	<b>Low Force</b>	<b>High Force</b>
Layer Thickness	–	75 mm (3")
Base Support	–	Granular
Oil Viscosity	–	High
Aggregate Shape	–	Crushed
Ambient Temperature	32° C (90° F)	–

For this project, the amplitude choice is relatively easy. You are laying down 75 mm (3") of dense graded asphalt as the first lift on granular material. The mix design uses high-viscosity asphalt cement and 19 mm (3/4") crushed aggregate with fractured faces. It is a hot day. Four factors line up on the high force side. Only the high temperature shows

on the low-force side. This asphalt layer will accept high amplitude for several reasons. First, the layer is fairly thick. Second, and very importantly, the ratio of layer thickness to maximum aggregate size is 4:1.

**Summary:** Knowing the factors that affect asphalt compaction is a vital skill for operators, quality control technicians and supervisors. Much of the information about mix design is contained in the job mix formula that should be available from the asphalt plant. Items such as layer thickness and type of base for each layer will be shown on cross section plans. Only climate conditions need to be analyzed for each shift.

If you gather enough information and know how to interpret it, you and your team can make better decisions when setting up the compaction process. If you rely only on past performance or experience, you may be ignoring new valuable information.

What you have learned about the forces of compaction and the factors that affect compaction will help you set up the compaction train. That is the subject of Unit 4.



## Unit 4

# METHODS AND SPECIFICATIONS

Properly setting up the compaction process is the key to your project's success. Following are the appropriate procedures, whether using method or end-result specifications.





*Cat CD54 working in the initial phase of compaction.*

Units 2 and 3 covered the forces of compaction and other factors that affect asphalt compaction. Unit 4 deals with setting up a compaction train that meets the project requirements for production, density and smoothness.

Unit 4 contains two distinct sections. The first section deals with setting up the compaction process with the guidance of a method specification that dictates type of equipment,

working speed, number of passes, and other factors. The second section deals with setting up the compaction train under the assumption that an end result specification is in effect. In other words, the crew members and quality control personnel determine types of equipment and rolling patterns that will produce the desired density and match the production requirement, as well.



## Section I: METHOD SPECIFICATIONS

The information in Section I is based on research done by the Central Laboratory for Bridges and Roads in Paris, France. Based on this widely-accepted research, the type of compaction

equipment, number of passes, and working speed are specified for various types of bituminous pavement layers.

### ROAD SECTION

**Wearing Course thin lift (Wc1) - 3 to 5 cm**

**Wearing Course std lift (Wc2) - 6 to 9 cm**

**Intermediate Course (Ic) - 6 to 9 cm**

**Binder Course (Bc1) - 8 to 12 cm**

**Binder Course (Bc2) - 12 to 15 cm**

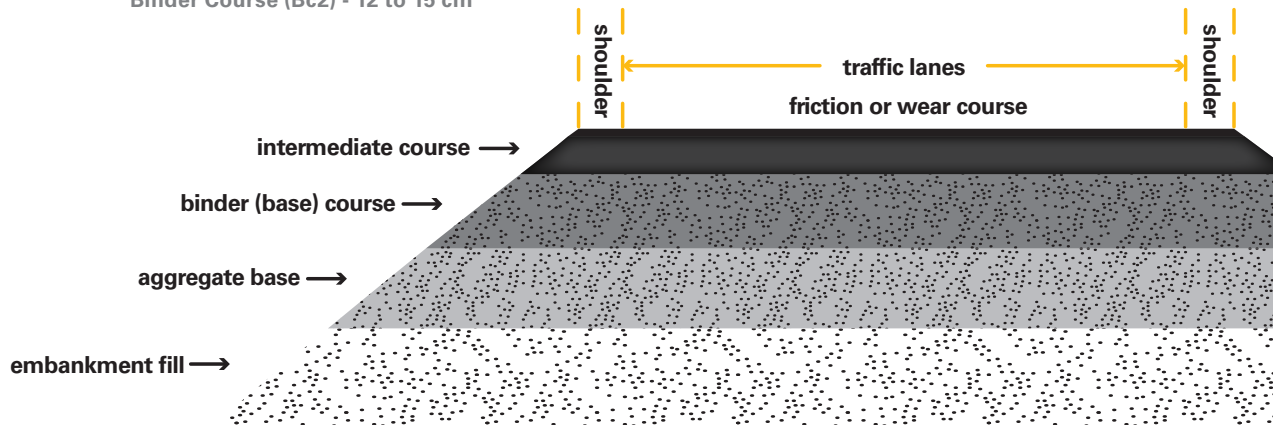

### [ LAYER TYPE ]

There are five categories of layers (courses) in this specification. A thin lift wear course (Wc1) has a thickness ranging from 3 to 5 cm. There is a standard lift wear course (Wc2) with a thickness ranging from 6 to 9 cm.

One binder (intermediate) course category is based on a thickness range from 6 to 9 cm.

There are two base course classifications. The standard base course (Bc1) is for thickness that ranges from 8 to 12 cm. The optional course (Bc2) ranges from 12 cm to 15 cm.

As explained in Unit 2, each layer type typically uses a different mix type and is laid to different thicknesses. Therefore, the amount of compaction force will be different for each layer.

**[ COVERAGE BASED ON DRUM WIDTH ]**

The relationship between drum width and the width of the layer is an important consideration. In order to match the production of the paving process, the drum width must be such that a compactor can cover the width of the layer in no more than three overlapping passes. The overlap is assumed to be a minimum of 15 cm. If the available compactor cannot cover the width of the layer in three overlapping passes, then more compactors must be added.

This chart is used as a guide to help determine how many rollers of a certain drum width would be required to cover various paving widths. The shaded areas indicate the need for at least one more roller, or a roller with wider drums, in order to match the production requirement. For example, one compactor with drums that are 170 cm wide will be effective on paving widths up to 4.5 m.

**NUMBER OF ROLLERS REQUIRED BY ROAD WIDTH (COVERAGE)**

Paving Width (meters)	Drum Width				
	150 mm	170 mm	200 mm	210 mm	300 mm
3.3	1	1	1	1	1
3.6	1	1	1	1	1
3.9	1	1	1	1	1
4.2	2	1	1	1	1
4.5	2	1	1	1	1
4.8	2	2	1	1	1
5.1	2	2	1	1	1
5.4	2	2	1	1	1
5.7	2	2	2	1	1
6	2	2	2	2	1
7	2	2	2	2	1
8	2	2	2	2	1
9	3	2	2	2	2

*Note: Compactors with drums offset to maximum width are recommended only when compacting thin wear courses.*

### [ COMPACTOR CLASSIFICATIONS ]

In the French system, vibratory steel drum rollers are classified according to static linear load per drum and the amplitude of the drum. The classification formula is expressed as linear load in kilograms per centimeter multiplied by the square root of the rated amplitude.

Most vibratory compactors have more than one amplitude. Therefore, the classification can change when amplitude is changed on a compactor.

#### Vibratory Compactor Example

4680 kg (weight at the drum) / 170 cm (drum width) = 27.5 kg/cm

27.5 kg/cm x square root 0.62 mm = 21.7

21.7 = Class V1

### [ VIBRATORY COMPACTOR CLASSES ]

The compactor in the chart below has three amplitude choices. Changing amplitude results in changing the classification of the compactor. The VO class will have a relatively low amount of compaction energy. The V1 class will have a mid-range amount

of compaction energy. The V2 class will deliver a high amount of compaction energy.

Range	Low	Mid	High
<b>amplitude (AO) (mm)</b>	0.34	0.80	1.05
<b>weight at drum (kg/cm)</b>	27.50	27.50	27.50
<b>weight x sq. root of AO =</b>	16.04	24.60	28.18
<b>classification</b>	<b>VO</b>	<b>V1</b>	<b>V2</b>

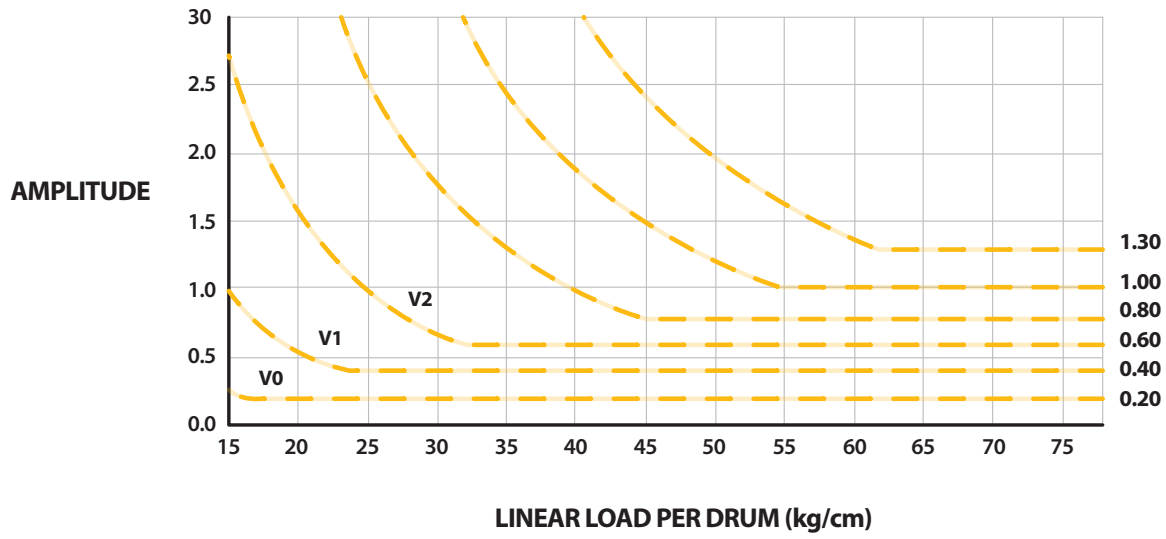

This chart shows the ranges of the various compactor classifications based on linear load per drum and amplitude. For practical purposes, only three classification ranges are used in the method specification: V0, V1 and V2.

There are two classifications for pneumatic compactors. The formula for pneumatic compactor classification is written as total weight in tons divided by number of wheels.

**Pneumatic Compactor Example**

21 tons (machine weight) ÷ 7 (number of wheels) = 3 tons/wheel  
 3 tons / wheel = Class P1

**Pneumatic Compactor Classes**

Class	Weight Per Wheel
P0	Greater than 1.5 tons and less than 2.5 tons
P1	Greater than 2.5 tons and less then 4.0 tons

	Wc1		Wc2		Ic		Bc1		Bc2	
	passes	speed	passes	speed	passes	speed	passes	speed	passes	speed
<b>class P0</b>	18	6								
<b>class P1</b>	14	6	20	6						
<b>class V2</b>			4	4	5	4	15	4	25	3
<b>class V1</b>	4	4	8	4	7	4				
<b>class V0</b>	7	4								

**Note:** Speeds shown in km/h.

### [ SELECTING MACHINE CLASSIFICATIONS ]

The aim of the method specification is to blend the information regarding machine classification and layer type into a reference chart that will guide the user to selection of machine type, number of passes and working speed. Across the top of the chart are the five types of layers: thin wear course (Wc1); thick wear course (Wc2); intermediate course (Ic); standard base course (Bc1); and thick base course (Bc2).

Machines classes are shown on the left side of the chart. Light pneumatic compactor is P0. Heavy pneumatic compactor is P1. The three vibratory compactor classes range from the highest vibratory energy (V2) through the mid-range vibratory energy (V1) and ending with the lowest vibratory energy (V0).

For thin wear courses (Wc1), the P0 class pneumatic compactor should make 18 passes at a speed of 6 kilometers per hour. If a P1 class pneumatic compactor is used, that machine should make 14 passes at 6 kilometers per hour. A class V1 vibratory compactor must complete four passes at 4 kilometers per hour. A class V0 vibratory

compactor must complete seven passes at 4 kilometers per hour. Note that V2 classes are not permitted on thin wear courses.

On thick wear courses (Wc2), P0 class pneumatic compactors are not allowed. P1 pneumatic compactors will complete twenty passes at 6 kilometers per hour. V2 class vibratory compactors are directed to complete four passes at 4 kilometers per hour. V1 class vibratory compactors must complete eight passes at 4 kilometers per hour. The chart provides specific directions for each machine class on each type of pavement layer.

Other tools, such as the Cat® Interactive Production Calculator, can help determine the number of compactors that will be needed based on the paving speed, the width of the layer and the drum width of the compactor.

COMPACTION CALCULATOR

Trucking
Paver Speed
<b>Compaction</b>
Material Used
Slope
Thickness
Job Summary
Legal
Exit

Roller Model: [ [Click to Select Another Model](#) ] [ **CB534D** ]  
 Course Type: [ [Click to Select Course Type](#) ] [ **Wearing Course Std Lift 0/10 - 6 to 9 cm** ]

General Inputs

Production Rate of Hot Plant:	[ <b>160</b> ] tonnes/hr
Paving Thickness:	[ <b>65</b> ] mm
Paving Width:	[ <b>4.00</b> ] meter
Actual Drum Width:	[ <b>170</b> ] cm
[ <a href="#">Click to Change Roller Efficiency Rate</a> ]	[ <b>77</b> ] %
Actual Roller Speed:	[ <b>4</b> ] km/h
Total Number of Passes:	[ <b>4</b> ]
Number of Roller Needed (based on width):	[ <b>1</b> ]
Number of Roller Needed (based on speed):	[ <b>1</b> ]
<b>Number of Roller Needed:</b>	[ <b>1</b> ]

One version of the Cat Interactive Production Calculator has been programmed with the formulas and requirements of the Central Laboratory for Bridges and Roads in Paris, France method specification for compactor selection and rolling patterns. In the first example, the production rate is 160 tonnes per hour. The project has a standard thickness wear course being paved at a depth of 65 mm and a width of 4 meters. The number of passes and the working speed are selected automatically based on the charts from the method specification. The program has calculated that one compactor with a drum width of 170 cm will be able to match the requirement for coverage and the requirement for production. What would happen if the production rate were increased?



COMPACTION CALCULATOR

<b>Trucking</b>	Roller Model: [ <a href="#">Click to Select Another Model</a> ] [ <b>CB534D</b> ]
<b>Paver Speed</b>	Course Type: [ <a href="#">Click to Select Course Type</a> ] [ <b>Wearing Course Std Lift 0/10 - 6 to 9 cm</b> ]
<b>Compaction</b>	<b>General Inputs</b>
<b>Material Used</b>	Production Rate of Hot Plant: [ <b>200</b> ] tonnes/hr
<b>Slope</b>	Paving Thickness: [ <b>65</b> ] mm
<b>Thickness</b>	Paving Width: [ <b>4.00</b> ] meter
<b>Job Summary</b>	Actual Drum Width: [ <b>170</b> ] cm
<b>Legal</b>	[ <a href="#">Click to Change Roller Efficiency Rate</a> ] [ <b>77</b> ] %
	Actual Roller Speed: [ <b>4</b> ] km/h
	Total Number of Passes: [ <b>4</b> ]
	Number of Roller Needed (based on width): [ <b>1</b> ]
	Number of Roller Needed (based on speed): [ <b>2</b> ]
<b>Exit</b>	<b>Number of Roller Needed:</b> [ <b>2</b> ]

When the hourly production rate is increased from 160 tonnes per hour to 200 tonnes per hour, the calculation shows that two compactors will be needed to match the increased production. Remember, the calculator is programmed to select the working speed and the number of passes based on course type and thickness.



COMPACTION CALCULATOR

<b>Trucking</b>	Roller Model: [ <a href="#">Click to Select Another Model</a> ] [ <b>CB534D</b> ]
<b>Paver Speed</b>	Course Type: [ <a href="#">Click to Select Course Type</a> ] [ <b>Binder Course 0/12 (Bc2) - 12 to 15 cm</b> ]
<b>Compaction</b>	
<b>Material Used</b>	
<b>Slope</b>	
<b>Thickness</b>	
<b>Job Summary</b>	
<b>Legal</b>	
<b>Exit</b>	

<b>General Inputs</b>	
Production Rate of Hot Plant:	[ <b>200</b> ] tonnes/hr
Paving Thickness:	[ <b>125</b> ] mm
Paving Width:	[ <b>4.00</b> ] meter
Actual Drum Width:	[ <b>170</b> ] cm
[ <a href="#">Click to Change Roller Efficiency Rate</a> ]	[ <b>77</b> ] %
Actual Roller Speed:	[ <b>4</b> ] km/h
Total Number of Passes:	[ <b>25</b> ]
Number of Roller Needed (based on width):	[ <b>1</b> ]
Number of Roller Needed (based on speed):	[ <b>4</b> ]
<b>Number of Roller Needed:</b>	[ <b>4</b> ]

*It is interesting to note how many compactors will be needed when the course type is changed to a thick binder course (Bc2) being laid to a depth of 125 mm. Compaction speed stays the same according to the specification, but the number of passes increases to 25. The calculation shows that 4 compactors with 170 cm wide drums will be needed to match the production rate. And, it is also important to remember that those must be V2 class compactors.*

Method specifications are used in many areas and are based on research and project experience. If method specifications are required, that fact will be included in the project plans or in guidelines published by the controlling public works agency. Always consult the public works officials for clarifications if you have questions about method specifications.

End result specifications give more choices to the crews who are doing the work. The second section of Unit 4 deals with the steps for setting up the compaction process to satisfy an end result specification.



## Section II: END RESULT SPECIFICATIONS

### [ DRUM WIDTH ]

When selecting compactors for a project, one general rule states that the drums must be wide enough to cover the width of the mat in no more than three overlapping passes. In some situations, the compactor will need more than three passes. If this is the case, another compactor should be added. This general rule applies to projects such as highways, roads and major street paving where

production is usually an important factor. The rule typically does not apply for projects like parking lots or low-production projects. The chart below is a reference that is used to help select the correct drum width based solely on covering the mat in no more than three overlapping passes. Drum widths shown are minimum and maximum typically available for higher-production projects.

**Required Number of Overlapping Passes per Drum Width**

Paving Width Meters / Feet	Drum Widths				
	140 cm (55")	150 cm (59")	170 cm (67")	200 cm (79")	213 cm (84")
2.5 / 8	2	2	2		
2.75 / 9	3	3	2		
3.00 / 10	3	3	3	2	2
3.35 / 11	3	3	3	2	2
3.70 / 12	(4)	3	3	2	2
4.00 / 13			3	3	2
4.25 / 14			3	3	3
4.50 / 15				3	3
4.80 / 16				3	3
5.20 / 17				3	3
5.50 / 18					3

**Note 1:** The wider drum models are not recommended on narrower paving widths (less than 3 m / 10') because mat deformation can occur when turning wide drums on narrow mats.

**Note 2:** Some double drum asphalt compactors feature drum offset. Drum offset significantly increases the width of coverage by the compactor. For example, the Cat CD54 has a drum width of 170 cm (67"). At maximum offset, the CD54 compaction width is 300 cm (118"). Caterpillar recommends

drum offset to be used only on mats less than 50 mm (2") thick if you are trying to meet a density specification during the initial phase of compaction.

Drum width is most important for the first compactor operating behind the paver. In general, the compaction process is divided into three phases: initial, intermediate and finish. Different types of compaction equipment and compaction techniques are used on each phase.

### [ INITIAL COMPACTION ]

Initial compaction is the first step in the compaction process and should produce the majority of the target density in the mat. For example, if the target density for final compaction is 95% of theoretical maximum density, the initial phase should produce at least 91% to 93% of theoretical maximum.

Initial compaction should begin at the highest possible mat temperature that supports the weight of the roller without distorting the mat. Remember, once the mat begins to cool, the asphalt cement in the mix gets stiffer and density is harder to achieve.

For this reason, the initial compaction phase must occur in a zone very close to the paver. The paver and initial phase compactor(s) must have the same production rate.

**Note:** The paving speeds discussed in this section assume the use of vibratory screeds and not screeds which include both tamping and vibration.



*The initial phase roller works close to the paver.*



*Steel drum, vibratory rollers are commonly used for initial compaction.*

Steel drum, vibratory rollers are commonly selected for the initial phase of compaction. Because vibratory rollers combine weight and impact, they normally have the highest production rates. Pneumatic compactors are sometimes used in the initial compaction phase on base or binder layers.

Vibratory rollers have different vibratory characteristics as well as different drum widths. How you set up the vibratory system affects how well the initial phase roller will match the paver's production. Let's look at some examples from the Cat Interactive Production Calculator.

PAVER SPEED CALCULATOR

<b>Trucking</b>	<b>General Inputs</b>		
<b>Paver Speed</b>	Paving Thickness:	[ 2.00 ] in	[ 50.8 ] mm
<b>Compaction</b>	Paving Width:	[ 12.00 ] feet	[ 3.658 ] meter
<b>Windrow</b>	Material Density Uncompacted:	[ 130 ] lbs/ft <sup>3</sup>	[ 2082 ] kg/m <sup>3</sup>
<b>Yield</b>	<b>Paver Speed @ Given Production Rate</b>		
<b>Slope</b>	Production Rate of Hot Plant:	[ 200 ] tons/hr	[ 181 ] tonnes/hr
<b>Thickness</b>	Calculated Paving Speed - 100% Efficiency:	[ 25.6 ] ft/min	[ 7.81 ] m/min
<b>Job Summary</b>	Calculated Paving Speed - 95% Efficiency:	[ 26.9 ] ft/min	[ 8.20 ] m/min
<b>Legal</b>	Calculated Paving Speed - 90% Efficiency:	[ 28.2 ] ft/min	[ 8.59 ] m/min
	Calculated Paving Speed - 85% Efficiency:	[ 29.4 ] ft/min	[ 8.98 ] m/min
	Calculated Paving Speed - 80% Efficiency:	[ 30.7 ] ft/min	[ 9.37 ] m/min
	Calculated Paving Speed - 75% Efficiency:	[ 32.0 ] ft/min	[ 9.76 ] m/min
<b>Exit</b>	<b>Effective Paving Speed:</b>	[ 25.6 ] ft/min	[ 7.81 ] m/min

In this example, the production rate is 181 tonnes per hour (200 tons per hour). The paving width is 3.66 m (12') and the paving thickness is 50 mm (2"). The weight of the material as it passes under the screed (vibratory energy only) is 2082 kg/m<sup>3</sup> (130 lb/ft<sup>3</sup>). If a material transfer device is used on the project, the actual paving speed may be as low as 7.8 m per minute (25.6 feet per minute). If mix is being transferred directly from haul units to the paver, the actual paving speed is calculated at 9.8 meters per minute (32 feet per minute). At a 75% efficiency rate, the effective speed is 7.8 meters per minute (25.6 feet per minute). Therefore, the production rate of the initial compactor must be high enough to match the effective paving speed.



COMPACTION CALCULATOR

<b>Trucking</b>	Roller Model: [ <a href="#">Click to Select Another Model</a> ] [ <b>CB54</b> ]
<b>Paver Speed</b>	<b>General Inputs</b>
<b>Compaction</b>	Paving Width: [ <b>12.00</b> ] feet [ <b>3.658</b> ] meter
<b>Windrow</b>	Actual Drum Width: [ <b>67</b> ] in [ <b>170.18</b> ] cm
<b>Yield</b>	Amount of Overlap: [ <b>6.0</b> ] in [ <b>15.2</b> ] cm
<b>Slope</b>	Speed of Vibrator: [ <b>2520</b> ] VPM [ <b>2520</b> ] VPM
<b>Thickness</b>	Impacts (recommended): [ <b>11</b> ] per ft [ <b>36</b> ] per m
<b>Job Summary</b>	<b>Number of Passes to Cover Mat Width Once:</b> [ <b>3</b> ]
<b>Legal</b>	Number of Repeated Passes (from test strips): [ <b>2</b> ]
<b>Exit</b>	<b>Total Number of Passes:</b> [ <b>7</b> ]
	Roller Efficiency Rate (recommended 75 to 85%): [ <b>80</b> ] %
	<b>Actual Roller Speed:</b> [ <b>229</b> ] fpm [ <b>70</b> ] mpm [ <b>25.6</b> ] ft/min <small>Effective Paver Speed</small>
	<b>Effective Roller Speed*:</b> [ <b>26</b> ] fpm [ <b>8</b> ] mpm [ <b>7.81</b> ] m/min
	<small>* Effective Roller Speed should be at least 100% but no more than 115% of the Effective Paver Speed.</small> [ <b>% = 102</b> ]

In this example, a Cat CB54 Asphalt Compactor is available. The CB54 has 170 cm (67") wide drums that can cover the mat in three overlapping passes. Low frequency, 42 Hz (2520 vibrations per minute), has been selected. From work with similar mix on test strips, it is estimated that two repeat passes will produce the target density for the initial phase. Three overlapping passes with two repeat passes creates a seven-pass pattern. An 80% efficiency rate accounts for water refill stops and compactor stops for reversing. An actual working speed of 70 meters per minute (229 feet per minute) will match the effective paving speed. The production calculator also shows that the impact spacing is well within the desired range, which is 26 to 46 impacts per meter (8-14 impacts per foot).



PAVER SPEED CALCULATOR

<b>Trucking</b>	<b>General Inputs</b>		
<b>Paver Speed</b>	Paving Thickness:	[ 2.00 ] in	[ 50.8 ] mm
<b>Compaction</b>	Paving Width:	[ 12.00 ] feet	[ 3.658 ] meter
<b>Windrow</b>	Material Density Uncompacted:	[ 130 ] lbs/ft <sup>3</sup>	[ 2082 ] kg/m <sup>3</sup>
<b>Yield</b>	<b>Paver Speed @ Given Production Rate</b>		
<b>Slope</b>	Production Rate of Hot Plant:	[ 276 ] tons/hr	[ 250 ] tonnes/hr
<b>Thickness</b>	Calculated Paving Speed - 100% Efficiency:	[ 35.4 ] ft/min	[ 10.80 ] m/min
<b>Job Summary</b>	Calculated Paving Speed - 95% Efficiency:	[ 37.2 ] ft/min	[ 11.34 ] m/min
<b>Legal</b>	Calculated Paving Speed - 90% Efficiency:	[ 38.9 ] ft/min	[ 11.88 ] m/min
	Calculated Paving Speed - 85% Efficiency:	[ 40.7 ] ft/min	[ 12.42 ] m/min
	Calculated Paving Speed - 80% Efficiency:	[ 42.5 ] ft/min	[ 12.96 ] m/min
	Calculated Paving Speed - 75% Efficiency:	[ 44.2 ] ft/min	[ 13.50 ] m/min
<b>Exit</b>	<b>Effective Paving Speed:</b>	[ 35.4 ] ft/min	[ 10.80 ] m/min

What if the production rate were higher, say 250 tonnes per hour (276 tons per hour)? The paver speed calculation shows that paving speed increases as hourly tonnage increases, assuming that paving thickness and width do not change. After increasing hourly production to 250 tonnes per hour (276 tons per hour), the effective speed increases to 10.8 meters per minute (35.4 feet per minute).



COMPACTION CALCULATOR

<b>Trucking</b>	Roller Model: [ <a href="#">Click to Select Another Model</a> ] [ <b>CB54</b> ]
<b>Paver Speed</b>	<b>General Inputs</b>
<b>Compaction</b>	Paving Width: [ <b>12.00</b> ] feet [ <b>3.658</b> ] meter
<b>Windrow</b>	Actual Drum Width: [ <b>67</b> ] in [ <b>170.18</b> ] cm
<b>Yield</b>	Amount of Overlap: [ <b>6.0</b> ] in [ <b>16.5</b> ] cm
<b>Slope</b>	Speed of Vibrator: [ <b>2520</b> ] VPM [ <b>2520</b> ] VPM
<b>Thickness</b>	Impacts (recommended): [ <b>8</b> ] per ft [ <b>26</b> ] per m
<b>Job Summary</b>	<b>Number of Passes to Cover Mat Width Once:</b> [ <b>3</b> ]
<b>Legal</b>	Number of Repeated Passes (from test strips): [ <b>2</b> ]
<b>Exit</b>	<b>Total Number of Passes:</b> [ <b>7</b> ]
	Roller Efficiency Rate (recommended 75 to 85%): [ <b>80</b> ] %
	<b>Actual Roller Speed:</b> [ <b>315</b> ] fpm [ <b>96</b> ] mpm [ <b>35.4</b> ] ft/min
	<b>Effective Roller Speed*:</b> [ <b>36</b> ] fpm [ <b>11</b> ] mpm [ <b>10.80</b> ] m/min
	<i>Effective Paver Speed</i> [ <b>% = 102</b> ]

\* Effective Roller Speed should be at least 100% but no more than 115% of the Effective Paver Speed.

Next, it is important to determine if the initial phase compactor can keep up with the higher production. The actual working speed of the compactor has to be increased to 96 meters per minute (315 feet per minute) to match the effective paving speed. Keeping the vibratory frequency at 42 Hz (2520 vibrations per minute) while increasing the working speed to 96 meters per minute (315 feet per minute) creates drum impact spacing of 26 impacts per meter (8 impacts per foot). That impact spacing is the minimum allowable. If possible, it would be better to utilize closer impact spacing. One way to affect impact spacing is to increase frequency while keeping working speed the same.



COMPACTION CALCULATOR

Trucking
Paver Speed
<b>Compaction</b>
Windrow
Yield
Slope
Thickness
Job Summary
Legal
Exit

Roller Model:  [ **CB54** ]

General Inputs

Paving Width:	[ <b>12.00</b> ] feet	[ <b>3.658</b> ] meter
Actual Drum Width:	[ <b>67</b> ] in	[ <b>170.18</b> ] cm
Amount of Overlap:	[ <b>6.5</b> ] in	[ <b>16.5</b> ] cm
Speed of Vibrator:	[ <b>3800</b> ] VPM	[ <b>3800</b> ] VPM
Impacts (recommended):	[ <b>12</b> ] per ft	[ <b>39</b> ] per m
<b>Number of Passes to Cover Mat Width Once:</b>	[ <b>3</b> ]	
Number of Repeated Passes (from test strips):	[ <b>2</b> ]	
<b>Total Number of Passes:</b>	[ <b>7</b> ]	
Roller Efficiency Rate (recommended 75 to 85%):	[ <b>80</b> ] %	

<b>Actual Roller Speed:</b>	[ <b>317</b> ] fpm	[ <b>97</b> ] mpm	Effective Paver Speed [ <b>35.4</b> ] ft/min
<b>Effective Roller Speed*:</b>	[ <b>36</b> ] fpm	[ <b>11</b> ] mpm	[ <b>10.80</b> ] m/min

\* Effective Roller Speed should be at least 100% but no more than 115% of the Effective Paver Speed. [ **% = 102** ]

The CB54 is often equipped with dual frequency. High frequency on the CB54 is 63.3 Hz (3800 vibrations per minute). With high frequency selected and the working speed set at 97 meters per minute (317 feet per minute), the impact spacing is 39 impacts per meter (12 impacts per foot). That impact spacing is more conducive to producing uniform density and smoothness. Another solution for this example would be to increase drum width so the compactor can cover the mat in two overlapping passes instead of three passes.



COMPACTION CALCULATOR

Trucking
Paver Speed
<b>Compaction</b>
Windrow
Yield
Slope
Thickness
Job Summary
Legal
Exit

Roller Model: [ [Click to Select Another Model](#) ] [ **CB54 XW** ]

**General Inputs**

Paving Width:	[ <b>12.00</b> ] feet	[ <b>3.658</b> ] meter
Actual Drum Width:	[ <b>79</b> ] in	[ <b>200.66</b> ] cm
Amount of Overlap:	[ <b>6.5</b> ] in	[ <b>16.5</b> ] cm
Speed of Vibrator:	[ <b>2520</b> ] VPM	[ <b>2520</b> ] VPM
Impacts (recommended):	[ <b>11</b> ] per ft	[ <b>36</b> ] per m
<b>Number of Passes to Cover Mat Width Once:</b>	[ <b>2</b> ]	
Number of Repeated Passes (from test strips):	[ <b>2</b> ]	
<b>Total Number of Passes:</b>	[ <b>5</b> ]	
Roller Efficiency Rate (recommended 75 to 85%):	[ <b>80</b> ] %	

<b>Actual Roller Speed:</b>	[ <b>229</b> ] fpm	[ <b>70</b> ] mpm	<i>Effective Paver Speed</i> [ <b>35.4</b> ] ft/min
<b>Effective Roller Speed*:</b>	[ <b>37</b> ] fpm	[ <b>11</b> ] mpm	[ <b>10.80</b> ] m/min

\* Effective Roller Speed should be at least 100% but no more than 115% of the Effective Paver Speed. [ **% = 105** ]

A compactor with 200 cm (79") drum width, if available, will cover the 3.66 m (12') mat in two overlapping passes instead of three passes. The extra drum width changes the rolling pattern from seven passes to five passes. Working speed decreases to 70 meters per minute (229 feet per minute). The vibratory frequency reverts back to 42 Hz (2520 vibrations per minute). That working speed produces more acceptable impact spacing, 36 impacts per meter (11 impacts per foot).

Remember, low frequency is always associated with higher amplitude. You will generally reach target density faster using low frequency and medium to high amplitude on mats that are 50 mm (2") and thicker.

Selecting the correct compactor for the initial phase of compaction is critical to achieving consistent and acceptable density. Pre-project planning is needed to confirm that the compactor will be able to match the paving speed.



## [ INTERMEDIATE COMPACTION ]

Intermediate compaction follows immediately after the initial phase on most mixes. The goals of intermediate compaction are to create the final target density in the mat and to begin the process of cleaning up marks left by the initial phase compactor.

The mat should be hot enough to allow some aggregate movement so usually intermediate compactors work in the temperature zone just behind the initial phase temperature zone. Depending on the thickness of the mat, you have

to be careful about the type and amount of force you apply. Remember, the mat in the final phase is already close to the final target density and you're trying to increase density by 1% to 3%.

Pneumatic compactors are a common choice for intermediate compaction because they can exert high static pressure without delivering impact forces. The type of pneumatic compactor selected for the intermediate phase depends on mat thickness and asphalt mix formula.

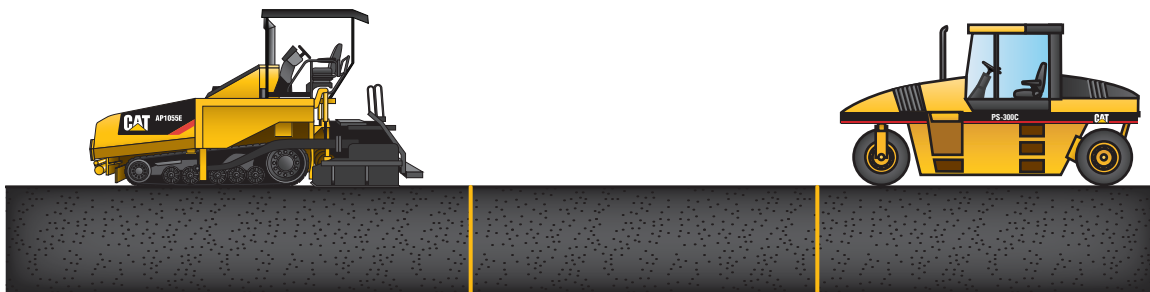

*Intermediate compaction closely follows the initial phase.*



*Pneumatic compactors can exert high forces without delivering impact forces.*

**WIDE-TIRE PRESSURE DISTRIBUTION**

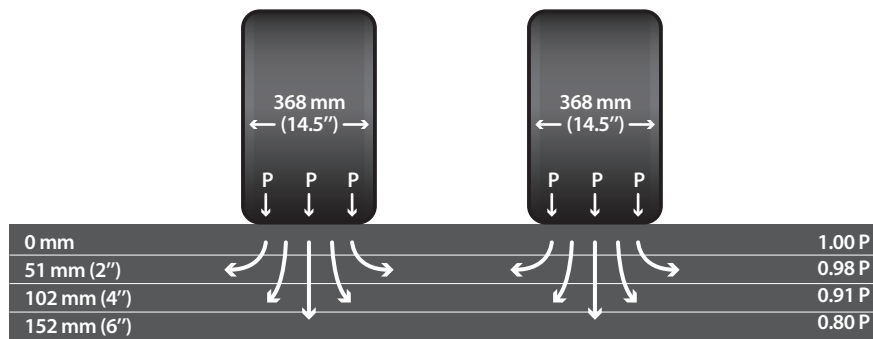

For thick, harsh mat compaction, a pneumatic compactor with wide tires is the best choice. The wide tires can withstand much higher loads that are needed to get final density in harsh mixes that are characterized by large aggregates. Notice that

even at a depth of 100 mm (4") the compaction pressure is still 90% effective. Wide-tire pneumatic compactors are a good choice for base and binder layers that are normally the thickest layers in the pavement structure.

**NARROW-TIRE PRESSURE DISTRIBUTION**

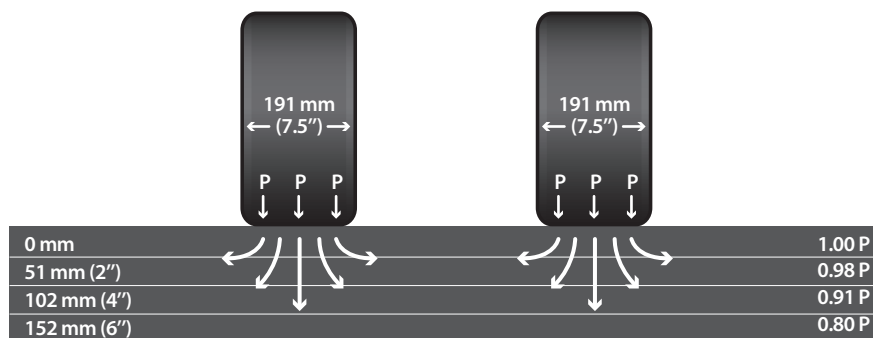

Pneumatic compactors with narrow tires exert high ground contact pressure, but that pressure is most effective on thin, stiff mats. Notice that the pressure diminishes rapidly when mat depth

exceeds 50 mm (2"). Pneumatic compactors with narrow tires are a good choice for wear layers that are typically the thinnest and made of the stiffest material.

If steel drum vibratory rollers are selected for the intermediate phase of compaction, be careful not to use too much impact force. The mat is already close to final density so high frequency combined with the lowest amplitude is probably going to work the best. Also, the mat temperature in the intermediate zone will have cooled to around 110° C (230° F). Vibrating aggressively on cool mats can result in impact marks that do not clean up during the finish phase or can cause fractured aggregates at the surface of the mat.



*Vibratory rollers used in the intermediate phase are set to low amplitude.*

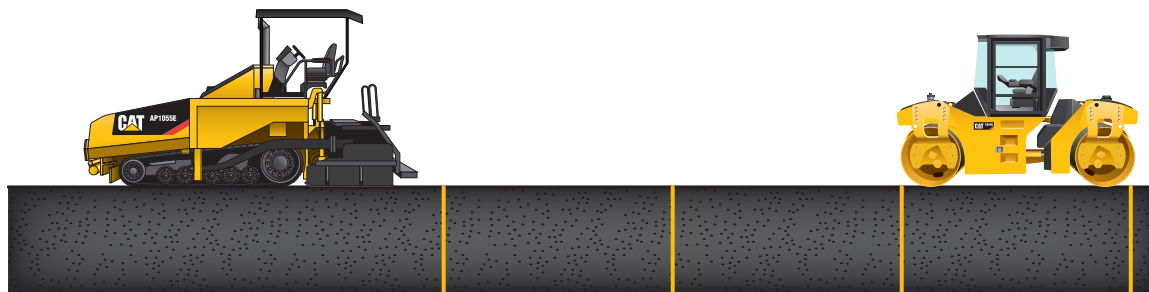

*The finish roller may be an hour behind the paver where the mat is cool.*

### [ FINISH COMPACTION ]

The final phase is finish compaction. The primary goal of the finish phase is to remove any drum stop marks or pneumatic tire marks. There may be small gains in density during the finish phase, but if you depend on getting more density during the finish phase, you are taking a risk.

The finish phase normally takes place when the mat is still warm enough to allow the removal of marks

in the surface. If the finish compactor is leaving its own stop marks, the mat is still too warm and finish compaction should be delayed even more. It is common for the finish compactor to be as much as an hour behind the paver. Finish compactor operators benefit from on-board temperature sensors or hand-held temperature scanners to help them stay in the correct temperature zone.

Tandem drum rollers operated in the static mode are the most common finish compactors. Remember, the narrower the drum width, the higher the static force exerted. It is common to see smaller compactors used in the finish position.

Vibration should not be used in the finish phase. If additional density is required, the problem needs to be addressed in the initial and intermediate phases. The goal of the finish phase is smoothness, not density gains. The finish compactor should make long, slow passes to make the mat smoother. If the finish phase on a portion of the mat is completed and the finish compactor needs to park and wait, park on only a portion of the mat or an adjoining surface that is cool enough to support the machine without deforming the mat.



*Tandem drum rollers operated in the static mode are common during the finish compaction phase.*

### [ TEST STRIPS ]

On many projects, the public works department in charge will require that a test strip be successfully completed before the start of full production. The requirements for test strips vary greatly from one location to another. In general, the test strip verifies that asphalt production meets the job mix formula, that the paving equipment lays down a satisfactory mat, and that the selected compaction equipment achieves the specified density.

A test strip can be a separate element or part of the paving project. It will consist of adequate tonnage to complete the required tests. In this manual, the only concern is about the density testing.

To complete the test strip, the quality control technician or supervisor will need to have an accurate temperature measuring device and a calibrated density testing gauge. The compaction equipment used on the test strip must be the equipment that is planned for the project.

The quality control technician or supervisor should have planned a rolling pattern for each phase of compaction, and should have selected vibratory amplitude, vibratory frequency and working speed for the initial phase compactor. The vibratory characteristics are determined by type of mix and thickness of the asphalt layer and the working speed of the paver.

As soon as the paver pulls off the starting joint, begin to collect data. Once the paver has reached planned paving speed and the correct mat thickness has been established, check the temperature of the mat directly behind the paver screed. Throughout the length of the test strip, continue to check and document mat temperature. Consistent mat temperature is one of the keys to creating consistent mat density. If the mix used on the project has a tender zone, you will be able to document the temperature for the start of the tender zone and the temperature when tenderness disappears.



Check the density of the mat laid by the screed before the compaction process begins. Knowing the screed laid density will help you select amplitude and the number of passes that may be necessary to get the required density.

Check screed laid density at several places across the width of the mat. Check the density of the mat after each pass made by the initial phase compactor.



*Sometimes, checking the density of the mat before initial compaction (top) is overlooked on the test strip. Density values and temperatures written on the mat (above) help compactor operators.*

**User Tip:** When you place the density testing gauge on the mat to make the first density check, draw an outline around the base of the gauge with chalk. The chalk outline will help you put the gauge in exactly the same spot after each pass.

Continue to make passes with the initial phase compactor until you have reached the target density for the initial phase. Let's look at an example of a test strip created on a highway project.

### [ DENSITY SPECIFICATIONS ]

Minimum density:	92% theoretical maximum density
Target density:	93.5 to 95.5 theoretical maximum density

### [ PROJECT CONDITIONS ]

Asphalt mix:	25 mm (1") dense graded
Asphalt cement:	5.8% polymer-modified oil
Paving thickness:	80 mm (3.1")
Paving width:	3.66 m (12')
Screed laid density:	80% theoretical maximum density
Mat temperature:	149° C (300° F)

### [ VIBRATORY CHARACTERISTICS, INITIAL PHASE ]

Drum width:	200 cm (79")
Static force per drum:	29.7 kg/cm (166 lb/in)
Amplitude:	0.78 mm (0.031")
Frequency:	42 Hz (2520 vibrations per minute)

### [ TEST STRIP RESULTS, INITIAL PHASE ]

Pass One:	84%
Pass Two:	87%
Pass Three:	90%
Pass Four:	92%

### [ VIBRATORY CHARACTERISTICS, INTERMEDIATE PHASE ]

Drum width:	200 cm (79")
Static force per drum:	29.7 kg/cm (166 lb/in)
Amplitude:	0.30 mm (0.012")
Frequency:	63.3 Hz (3800 vpm)

### [ TEST STRIP RESULTS, INTERMEDIATE PHASE ]

Pass Five:	93%
Pass Six:	94%

### [ STATIC CHARACTERISTICS, FINISH PHASE ]

Drum width:	170 cm (67")
Static force per drum:	31.8 kg/cm (178 lb/in)

### [ TEST STRIP RESULTS, FINISH PHASE ]

Pass Seven:	94.5%
Pass Eight:	95.0%

**Summary:** This test strip required four passes in the initial phase to reach the minimum density acceptance level. Two more intermediate passes added enough density to meet the target specification. Finish compaction added another percent. The compaction process met the requirement for density, but did it meet the production requirement? We can use the Cat Interactive Production Calculator to confirm that compaction production matches the paving production.

## PAVER SPEED CALCULATOR

<b>Trucking</b>	<b>General Inputs</b>		
<b>Paver Speed</b>	Paving Thickness:	[ 3.15 ] in	[ 80.0 ] mm
<b>Compaction</b>	Paving Width:	[ 12.00 ] feet	[ 3.658 ] meter
<b>Windrow</b>	Material Density Uncompacted:	[ 127 ] lbs/ft <sup>3</sup>	[ 2034 ] kg/m <sup>3</sup>
<b>Yield</b>	<b>Paver Speed @ Given Production Rate</b>		
<b>Slope</b>	Production Rate of Hot Plant:	[ 220 ] tons/hr	[ 200 ] tonnes/hr
<b>Thickness</b>	Calculated Paving Speed - 100% Efficiency:	[ 18.3 ] ft/min	[ 5.58 ] m/min
<b>Job Summary</b>	Calculated Paving Speed - 95% Efficiency:	[ 19.2 ] ft/min	[ 5.86 ] m/min
<b>Legal</b>	Calculated Paving Speed - 90% Efficiency:	[ 20.1 ] ft/min	[ 6.14 ] m/min
	Calculated Paving Speed - 85% Efficiency:	[ 21.0 ] ft/min	[ 6.42 ] m/min
	Calculated Paving Speed - 80% Efficiency:	[ 22.0 ] ft/min	[ 6.70 ] m/min
	Calculated Paving Speed - 75% Efficiency:	[ 22.9 ] ft/min	[ 6.97 ] m/min
<b>Exit</b>	<b>Effective Paving Speed:</b>	[ 18.3 ] ft/min	[ 5.58 ] m/min

The production rate planned for this project is 200 tonnes per hour (220 tons per hour). You have checked the screed laid density and can, therefore, accurately calculate the weight of the material laid by the screed. On this project, screed laid weight is 2034 kg/m<sup>3</sup> (127 lb/ft<sup>3</sup>). The paving depth is 80 mm (3.15") and the paving width is 3.66 m (12'). The effective paving speed is therefore 5.58 meters per minute (18.3' per minute). You now have to confirm that the initial phase compactor can keep up with the paver.

COMPACTION CALCULATOR

Trucking
Paver Speed
<b>Compaction</b>
Windrow
Yield
Slope
Thickness
Job Summary
Legal
Exit

Roller Model: [ [Click to Select Another Model](#) ] [ **CB54 XW** ]

**General Inputs**

Paving Width:	[ <b>12.00</b> ] feet	[ <b>3.658</b> ] meter
Actual Drum Width:	[ <b>79</b> ] in	[ <b>200.66</b> ] cm
Amount of Overlap:	[ <b>6.0</b> ] in	[ <b>15.2</b> ] cm
Speed of Vibrator:	[ <b>2520</b> ] VPM	[ <b>2520</b> ] VPM
Impacts (recommended):	[ <b>12</b> ] per ft	[ <b>38</b> ] per m
<b>Number of Passes to Cover Mat Width Once:</b>	[ <b>2</b> ]	
Number of Repeated Passes (from test strips):	[ <b>4</b> ]	
<b>Total Number of Passes:</b>	[ <b>9</b> ]	
Roller Efficiency Rate (recommended 75 to 85%):	[ <b>80</b> ] %	

<b>Actual Roller Speed:</b>	[ <b>210</b> ] fpm	[ <b>64</b> ] mpm	<i>Effective Paver Speed</i> [ <b>18.3</b> ] ft/min
<b>Effective Roller Speed*:</b>	[ <b>19</b> ] fpm	[ <b>6</b> ] mpm	[ <b>5.58</b> ] m/min

\* Effective Roller Speed should be at least 100% but no more than 115% of the Effective Paver Speed. [ **% = 104** ]

The compactor selected for the initial phase has 200 cm (79") wide drums. This compactor can cover the mat in two overlapping passes. On the test strip, four passes were needed to reach minimum acceptance density. The calculator shows that this will be a nine-pass pattern. At an actual working speed of 64 meters per minute (210 feet per minute), the initial phase compactor will match the paving speed. The vibratory frequency has been set at 42 Hz (2520 vibrations per minute). Frequency and working speed in this example combine to create 38 impacts per meter (12 impacts per foot). That impact spacing is ideal for consistent density and smoothness.



The test strip has been successfully completed from the standpoint of density measurements taken in the field. Cores extracted from the asphalt layer and analyzed in a laboratory will confirm the densities and allow you to further calibrate the density testing gauge, if necessary.



*Cutting cores and lab analysis provide the final confirmation that the test strip test density meets the target.*

### [ GETTING MORE DENSITY ON THE TEST STRIP ]

If the initial phase compactor using the selected vibratory settings and rolling pattern does not achieve the required density, changes will be necessary. Sometimes you can continue working on the same area of the test strip if the mat is still hot enough. Following is a list of ways to increase density:

- **Add more passes.** You can add more passes only if you can continue to match the paving speed.
- **Increase amplitude.** If a higher amplitude setting is available and the asphalt layer will accept the additional force without causing drum bounce, select the higher amplitude.
- **Increase tire pressure or ballast weight.** If a pneumatic compactor is used for initial compaction, you should be able to increase the compaction force without damaging the mat.
- **Use a higher production compactor.** If one is available, a compactor with wider drums or higher amplitude may be substituted. A compactor with wider drums may cover the mat in fewer overlapping passes and create a faster pattern that makes it easier to add passes.
- **Work closer to the paver.** By keeping the initial compactor very close to the paver, you will be working on the hottest asphalt. You may have to shorten the length of the rolling pattern to accomplish this.
- **Slow the working speed of the compactor.** A slower working speed delivers more force to the area being covered because the impact spacing is closer. This assumes that the slower speed will still allow the compactor to keep up with the paver.

**Summary:** *Setting up the compaction process and successfully completing test strips require planning and gathering data. Assuming a process that was successful on one project will also be successful on another project is very risky. True, experience is a good teacher, but there are many variables that affect density. Each project deserves a full analysis prior to starting work.*



## Unit 5

# ROLLING PATTERNS

By using the Cat® Interactive Production Calculator and creating cooling curves, you can plan successful patterns prior to the start of your project.



A rolling pattern is a series of movements made by a compactor or compactors on a freshly-laid, uncompacted asphalt layer. The rolling pattern is intended to be consistently repeated in order to produce uniform density in the asphalt layer.

The rolling pattern covers a certain area of square meters (feet) defined by the length and width of the pattern. It is assumed that the thickness of the asphalt layer is relatively consistent from one edge of the mat to the other within the pattern. The temperature of the asphalt mix within the rolling pattern will also be reasonably consistent as long as the area covered by the pattern is always in the same relationship to the paver as the paver moves forward. Therefore, a rolling pattern with a consistent number of passes, a consistent working

speed and consistent compaction forces should produce uniform density.

**Note:** In this manual, the term “pass” shall mean the movement of the compactor in one direction. In other words, when the compactor begins a pattern by moving forward from a starting point to a point closer to the paver, that movement is considered one pass. When the compactor reverses to return to the starting point of the pattern, that movement is considered another pass.

Once a rolling pattern has been established, it should not be altered unless there are changes in the paving process in front of the compactor, changes in the mix formula or changes in climate conditions.

**REVERSING**

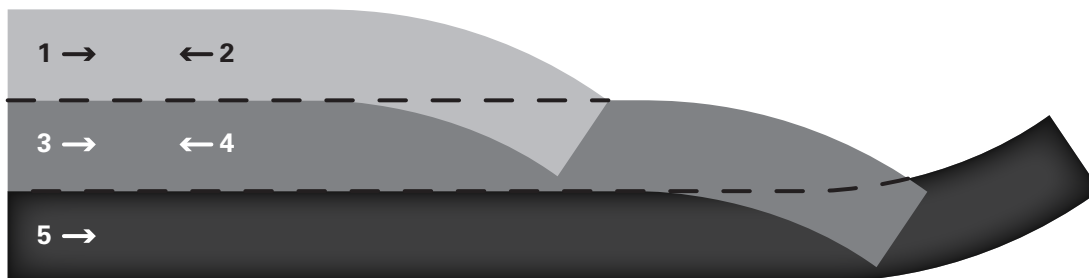

**[ BASIC ROLLING PATTERN ]**

There are certain techniques that are common to any rolling pattern. One technique is stopping and reversing a tandem drum roller at the end of a pass.

In the drawing shown above, it is assumed that the mat has two unconfined edges or that there is no adjacent cold mat to roll onto. The compactor operator must stop and reverse on the hot mat.

Notice that the first two passes are along one edge of the mat. At the end of Pass One, the operator

turns toward the center of the mat and stops slowly with both drums turned at least 30° leaving the stop mark at an angle to the direction of compaction. The operator reverses in the same path for Pass Two.

Pass Three is down the center of the mat with some overlap on the coverage of Passes One and Two. Pass Three is longer than Pass One in order to keep up with the paver and to clean up the stop mark left at the end of Pass One.



*Two initial phase compactors reversing direction behind a paver. Note angled stop.*

At the end of Pass Three, the operator turns toward the uncompacted edge, being careful to not push out the edge of the mat. Again, the stop mark is left at an angle to the direction of compaction. The operator reverses in the same path for Pass Four.

Pass Five is along the other unconfined edge with some overlap on the coverage of Passes Three and Four. Pass Five continues through the stop mark left at the end of Pass Three. At the end of Pass Five, the operator turns toward the center of the mat leaving an angled stop mark where the next pattern will clean it up. The operator reverses in the same path for Pass Six.

Pass Seven will reposition the compactor to start another pattern. This is called a seven-pass pattern.

This pattern results when it takes three overlapping passes to cover the width of the mat and it takes two passes per coverage to create the required density.

Initial phase compactors are always stopping to reverse in proximity to the rear of the paver. There are no absolute rules that dictate how far behind the paver the compactor should stop. Workplace safety should be the primary consideration. A reasonable guideline would be for the compactor(s) to stop at least 5 m (16') behind the paver. Remember, there may be laborers or screed operators working on the mat behind the paver.

**User Tip:** *When stopping a steel drum roller to reverse direction, whether on a hot mat or a cold adjacent mat, always shut off the vibratory system as soon as you begin to slow down. Remember, it is important to maintain drum impact spacing. As the machine speed decreases, the impacts may be too close together. You can manually deactivate the vibratory system or you can select the "AutoVibe" feature that will automatically stop and start the vibratory system when the working speed reaches programmed levels.*



*Pneumatic compactors are allowed to stop straight on the mat.*

Unlike steel drums, the rubber tires on pneumatic compactors should not be turned when bringing the compactor to a stop. Aggressive turns with pneumatic compactors will tear the mat. The

pneumatic compactor should stop slowly without turning. There will be a slight stop mark in the mat, but usually the finish roller will clean up those marks completely.

### [ **PATTERN FOR TWO UNCONFINED EDGES** ]

In this example, assume that the mat has two unconfined edges, that the left edge is the centerline of the structure and that there is a 2% slope from the centerline to the right unconfined edge.

When the structure to be compacted has two unconfined edges and a sloped surface, Caterpillar recommends making the first passes along the lower edge of the structure. The next series should be in the center of the mat. The final passes should be along the upper unconfined edge. Compaction

from the low side to the high side tends to build strength in the mat and reduce the amount of mat deformation.

In general, the First Pass along any unconfined edge should be made with the drum edge at least 15 cm (6") away from the edge. The Second Pass, typically the return pass in the same coverage area as the first pass, should be made with the drum slightly overlapping the edge. This sequence also helps minimize mat distortion.

**TWO UNCONFINED EDGES**

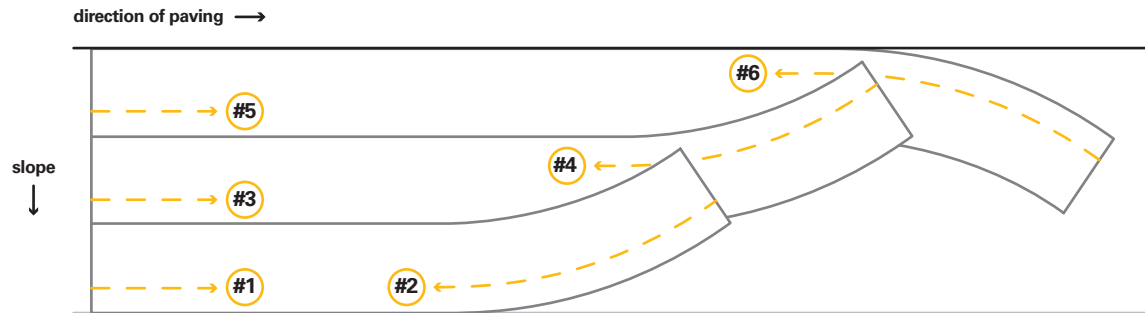

When compacting unconfined edges, watch for cracks in the mat along the drum edge when the drum edge is set back from the unconfined edge. Some mixes with large aggregates and low asphalt cement content will show deep cracks if the edge is not overlapped during the first pass.

Pneumatic compactors should not overlap unconfined edges. The rubber tires should be at least 15 cm (6") away from the unconfined edge to avoid rolling over or distorting the edge of the mat.

When cracks appear, immediately change the rolling pattern to overlap the unconfined edge with every pass along the edge of the mat.



*Crack in the mat along drum edge set back from the unconfined edge.*



*Pneumatic compactors always stay at least 15 cm (6") from unconfined edges.*

**[ PATTERN FOR ONE CONFINED EDGE ]**

In this example, assume that the left edge of the mat is matching an adjacent mat along the centerline of the structure. The adjacent mat is compacted and is cold. Traffic cones are set adjacent to the centerline edge on the cold mat and traffic is present on the cold mat. A 2% slope runs from the centerline down to the unconfined edge. You have two acceptable rolling patterns for this application.

If there is a joint density specification on the project, then the first pass should be along the left edge of the mat to take advantage of the highest mat temperature resulting in the highest joint density. Both drums should be completely on the hot mat about 15-30 cm (6-12") away from the cold mat. During Pass Two, the return pass along the left edge, the drums should be positioned to overlap the hot / cold joint by about 15 cm (6"). The overlap will begin the process of sealing the longitudinal centerline joint.

Passes Three and Four will be along the unconfined edge to build strength and minimize mat deformation at the unconfined edge.

Passes Five and Six are made in the center of the mat. This portion of the mat will be the coolest by this time, but the center portion of the mat will have, in effect, two confined edges to aid in compaction.

If there is no joint density specification, then Passes One and Two can be along the right edge on the low side of the sloped mat as shown in the illustration for two unconfined edges. The center of the mat is compacted by Passes Three and Four. Finally, the centerline joint is compacted with Pass Five slightly off the joint and Pass Six overlapping the joint.

**ONE UNCONFINED EDGE**

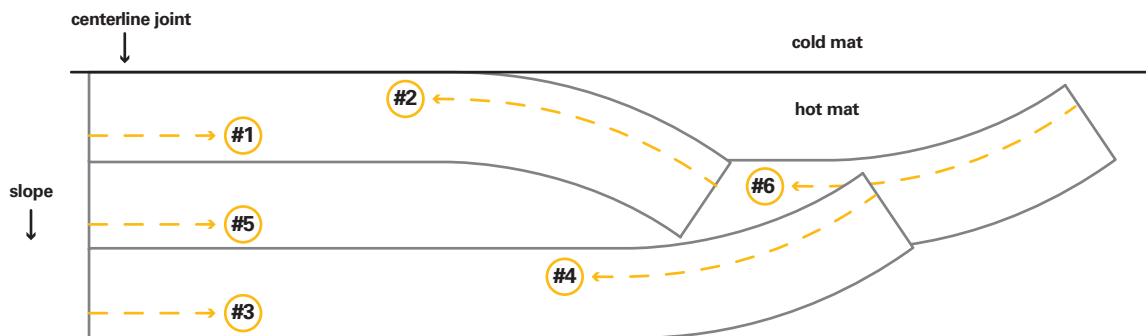





*Pneumatic compactors in the intermediate phase are effective at sealing hot / cold longitudinal joints.*



*There are no drum stop marks in the fresh mat when the compactor is able to roll onto a cold, compacted mat.*

All other compactors during intermediate or finish phases may overlap the longitudinal joint. The rubber tires of pneumatic compactors are particularly efficient at “pinching” joints. The pneumatic compactor operator should try to straddle the joint with one of the tires.

On some projects, the edge of the mat that is matching a joint will be adjacent to a cold, compacted mat. Whenever possible, compactor operators should roll off the hot mat and onto the cold mat to stop and reverse direction. By reversing direction on the cold mat, there will be no stop marks left on the hot asphalt layer and smoothness will be improved.

The compactor operator must be aware of several safety issues when rolling off the hot mat to stop and reverse. First, there may be traffic using the adjacent lane. Pilot vehicles may be leading traffic through the work zone. The operator should never pull onto the adjacent mat if there is traffic present.

Second, there may be workers around the paver. In particular, laborers may be raking the joint behind the paver. Be sure to pull off the mat far enough behind the paver if there are workers present.

**[ PATTERN USING EMERGENCY LANE FOR REVERSING ]**

On some projects, the plan calls for the paving width to include an emergency lane (also referred to as a shoulder or breakdown lane) along with one driving lane. Normally, if the emergency lane is less than 1.5 m (5') wide, it will be included in the conventional pattern used by the initial phase compactor. Or, if the emergency lane has a separate slope, sometimes the emergency lane will be compacted by a utility compactor and will not be included in the pattern with the driving lane.

However, if the emergency lane is at least 1.5 m (5') wide, the emergency lane can be included in the initial phase pattern and can be used for all compactor stopping and reversing.

The rolling pattern will resemble a series of half circles. After each pass, forward and backward,

the compactor operator will arc slowly across the driving lane and straighten out on the emergency lane and straighten out on the emergency lane with both drums on the emergency lane. The compactor operator will stop straight. Stopping straight is generally permitted on emergency lanes since there is no smoothness specification for emergency lanes.

If a pneumatic compactor is part of the compaction train, the pneumatic compactor will continue to stop straight on the driving lane and will not turn off onto the emergency lane. The finish compactor should use the emergency lane for stopping and reversing, too.

**REVERSING ON EMERGENCY LANE**

213 cm (84") drum width

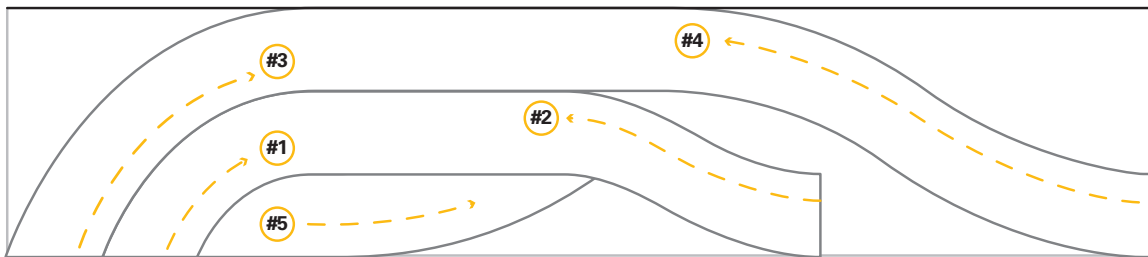

[ **ECHELON COMPACTION PATTERNS** ]

On some projects, two or more compactors may operate in the initial compaction position directly behind the paver. For the following reasons, an echelon pattern should be selected.

- **Wide width paving.** When the paving width exceeds 6 m (20'), it is unlikely that one compactor will be able to cover the paving width in three or fewer passes. Therefore, in general, one initial compactor will not be able to match the paver production.
- **Stiff mix requiring many passes.** Some mix designs, especially those including modified asphalt cement, are very stiff and require many

passes to bring density up to required levels. In that situation, the pattern needed for one compactor will cause that compactor to fall behind the paver.

- **Limited time for initial compaction.** The time available for initial compaction may be limited by the thickness of the mat, ambient temperature, or the appearance of a tender zone in the mat. Sometimes, more than one initial compactor is needed to cope with rapid temperature loss and a short opportunity to get initial density.

**INITIAL PHASE – PASS ONE**

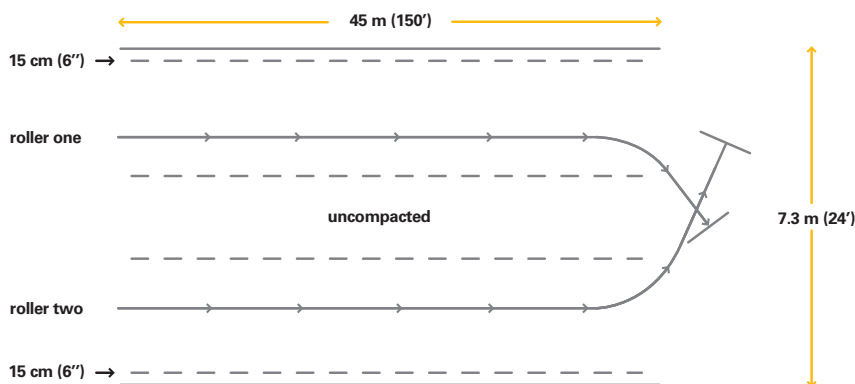

In the first example, assume that the paver is laying down 275 tonnes per hour (300 tons per hour) at a width of 7.3 m (24') and at a depth of 50 mm (2"). The effective paving speed is 6 meters per minute (20 feet per minute). There are two 200 cm (79") wide tandem drum rollers available for initial compaction. It takes two passes to bring density to the compaction target of the initial phase.

unconfined edge. Roller Two begins just after Roller One and operates along the right edge, also staying away from the unconfined edge. Roller One comes to a slow stop at an angle in the center of the mat and reverses. Roller Two moves slightly past the Roller One stop and also turns toward the center and reverses.

Roller One starts first along the left edge with the outer drum edge about 15 cm (6") away from the

**User Tip:** When employing an echelon pattern, the lead roller should be far enough in front of the second roller that the operator can complete the stop and reverse maneuver before the second roller starts to turn and reverse.

**INITIAL PHASE – PASS TWO**

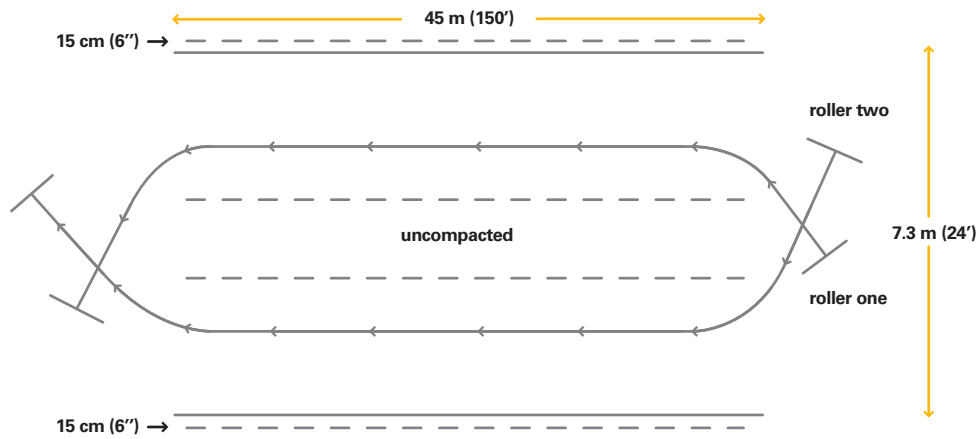

During Pass Two, the return to the starting point, Roller One is in the lead with Roller Two slightly behind. During Pass Two, the outer drums slightly overlap the unconfined edges. Again, both compactors turn toward the center of the mat

to make the stop and reverse. At this point, the outside edges of the mat have been compacted twice. There is a strip in the center of the mat that is about 3.5 m (11.5') wide.

**INITIAL PHASE – PASS THREE**

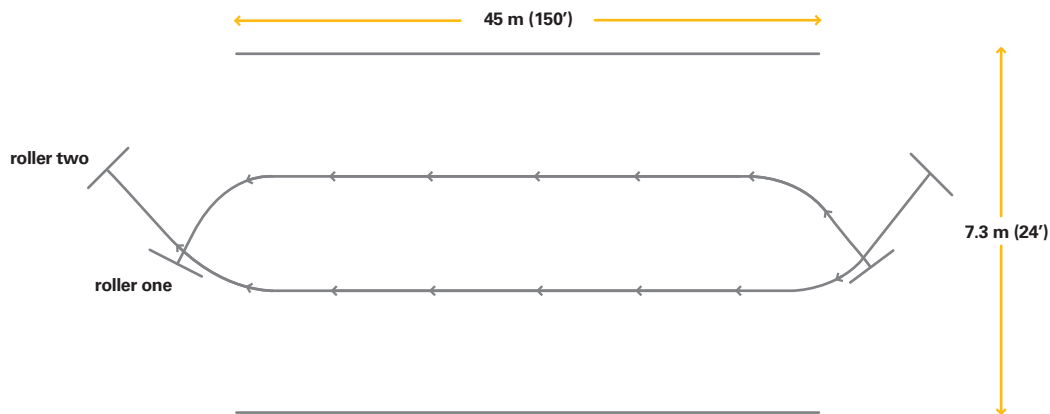

For Pass Three, Roller One goes first and operates on the left center of the mat with a slight overlap of the left drum edge onto the area covered in the first two passes. Roller One will pass straight over the drum stop mark left by Roller Two, moving forward about 8 m (25') past the stop mark before turning toward the right edge to stop and reverse.

Roller Two is slightly behind and operates on the right center portion of the mat with the right drum edge slightly overlapping onto the area covered in the first two passes. Roller Two will clean up the first stop mark left by Roller One, continue forward another 8 m (25') past the stop mark and turn toward the left edge to stop and reverse.

**INITIAL PHASE – PASS FOUR**

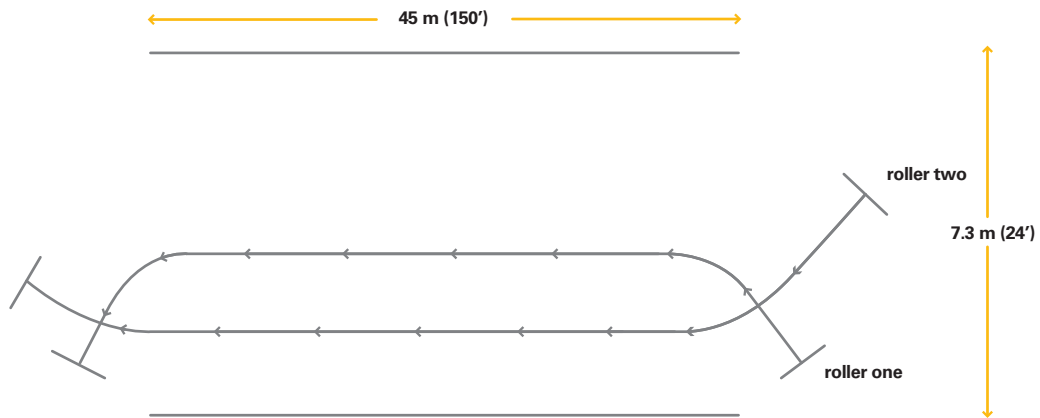

During Pass Four, the two compactors return in the same area back to the starting point with Roller One slightly ahead of Roller Two. It is recommended that

they roll straight through the stop marks they left at the end of Pass Two before stopping and reversing.



*Stopping to reverse repeatedly in the same area will overwork the fresh asphalt.*

**User Tip:** *Whenever possible, use a pattern that cleans up compactor stop marks. Do not stop and reverse in the same area. Stopping and reversing in the same area can distort the mat and create bumps that cannot be cleaned up. While it is most important to avoid stopping in the same area when the compactors move forward and reverse on the hot mat behind the paver, it is also a good practice to stagger the stop marks at the end of the return passes.*

Pass Five will be a static pass moving forward toward the paver. Both compactor operators should position their machines along the edges of the fresh mat and start the vibrator systems when the compactors enter the uncompacted zones. There

should be a new pattern area about 36 m (120') long in front of the old pattern.

**User Tip:** *If the new pattern is too short, in other words, the paver has not moved far enough forward, the compactor operators should reduce their working speeds during Pass Five. Pass Five is done in the static mode so there is no concern about drum impact spacing. Reduce the compactor speed, but never park on the fresh mat.*

**User Tip:** *Sometimes the area left uncompacted in the center of the mat is relatively narrow. In that situation, there will be a large overlap between the drums of the two compactors in the center of the mat. Because a lot of the drum surface will be vibrating on an already dense mat, there is likelihood that the drums will bounce. The operators should be ready to reduce the amount of force being delivered by operating with one drum vibrating and one drum static.*



[ **ECHELON PATTERN WITH TWO ROLLERS** ]

Next, let’s look at an echelon pattern using two compactors on a mat that is 4.6 m (15') wide. The paver is laying down 360 tonnes per hour (400 tons per hour) at a loose depth of 76 mm (3"). A material transfer device is feeding mix to the paver and the paving speed is 9 meters per minute (29 feet per minute). The density of the mat passing under the vibratory screed is 80% of theoretical maximum density.

On the test strip, you verified that it takes four vibratory passes at medium-high amplitude to

reach target density for the initial phase. Compactor working speed is 70 meters per minute (230 feet per minute). Vibratory frequency is 42 Hz (2520 vibrations per minute). The impact spacing is therefore 36 impacts per meter (11 impacts per foot).

The temperature of the asphalt layer as it passes under the screed is consistently around 150° C (300° F). When the mat cools to around 115° C (240° F), it becomes tender. The tenderness persists until the mat has cooled to 85° C (185° F).

**Start Date/Time** [ 7/3/2011 ▼ ] [ 7:08 AM ]

**Environmental Conditions**

Air Temperature: [ 15.6 ] °C  
 Wind Speed: [ 8 ] km/h  
 Sky: [ Clear & Dry ▼ ]  
 Latitude: [ 45 ] °N

**Mix Specifications**

Mix Type: [ Fine/Dense Graded ▼ ]  
 Binder Grade, PG: [ 64 ▼ ] [ -28 ▼ ]  
 Lift Thickness: [ 76 ] mm  
 Delivery Temperature: [ 149 ] °C

**Existing Surface**

Material Type: [ AC ▼ ]  
 Material Condition: [ - ▼ ] [ - ▼ ]  
 Surface Temperature: [ 15.6 ] °C

**Recommended Times**

Start Rolling: [ 13 ] minutes after laydown  
 Stop Rolling: [ 45 ] minutes after laydown

**Units**  SI  English

**HMA temperature, °C**

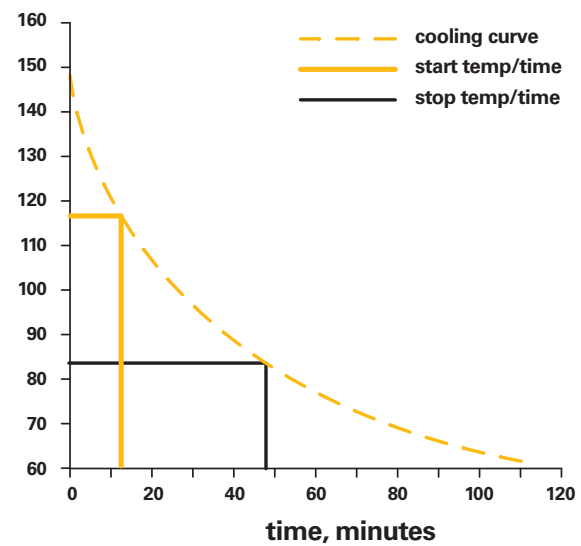

The cooling curve shows that at the start of the shift with the ambient temperature about 16° C (61° F), there are 13 minutes available for compaction behind the paver in the initial phase before the mat becomes tender. The tenderness lasts another 32 minutes. Intermediate and finish phases of compaction can start 45 minutes behind the paver. The more important problem is to determine if the initial phase can be accomplished in less than 13 minutes using two compactors.

**INITIAL PHASE – PASS ONE**

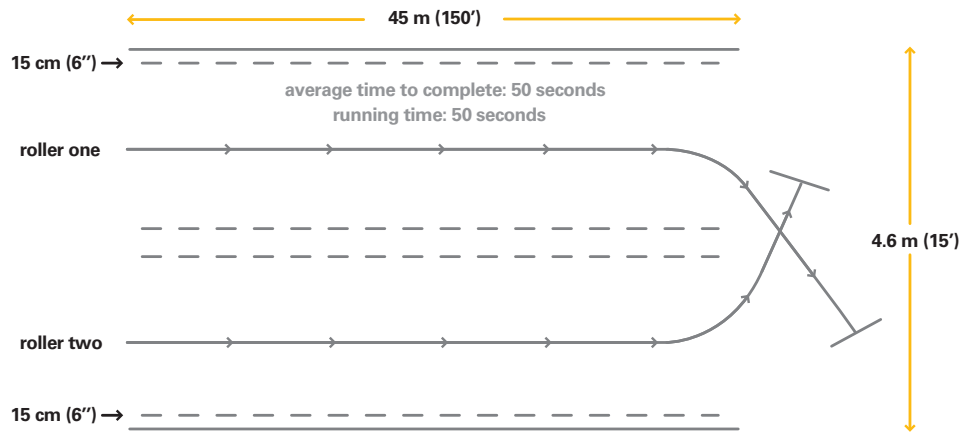

The first pass in the initial phase of compaction is about 45 m (150') long. Roller One starts first and compacts the area along the left edge with the drum edge set back about 15 cm (6") from the edge. Roller Two is slightly behind and is compacting the area along the right side of the mat with the drum set away from the edge. Both compactors turn toward the center of the mat to stop and reverse directions. As soon as Roller Two completes its reversing maneuver, both compactors start the second pass. At a working speed of 70 meters per minute (230 feet per minute), Pass One consumes 50 seconds.

**Note:** When calculating the time it takes a compactor to complete a pass, use an efficiency factor of 75%. It accounts for the time spent slowing the compactor and coming to an angled stop prior to reversing.

**INITIAL PHASE – PASS TWO**

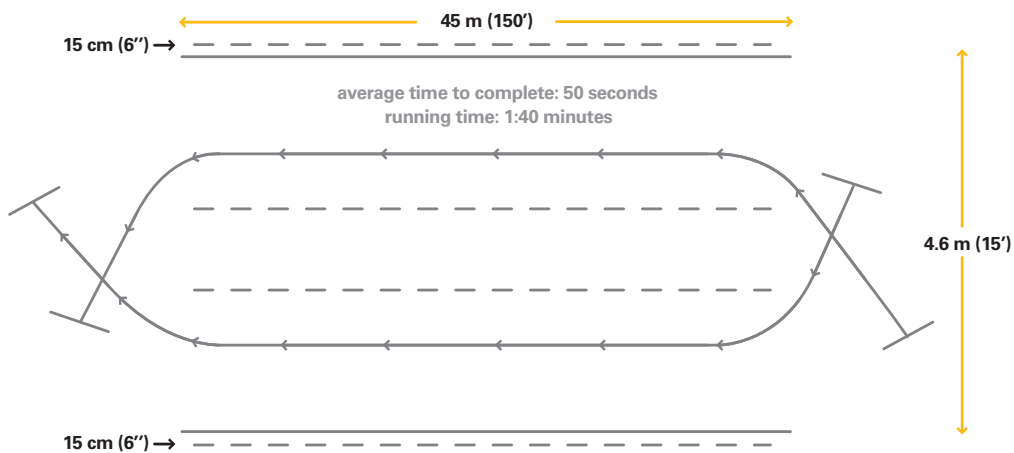

During the second pass, both compactors' drums are set to slightly overlap the edges. Roller Two is in the lead on the return pass and both rollers turn to the center to reverse direction. The second pass takes another 50 seconds. Total running time is 1 minute and 40 seconds.



**INITIAL PHASE – PASS THREE**

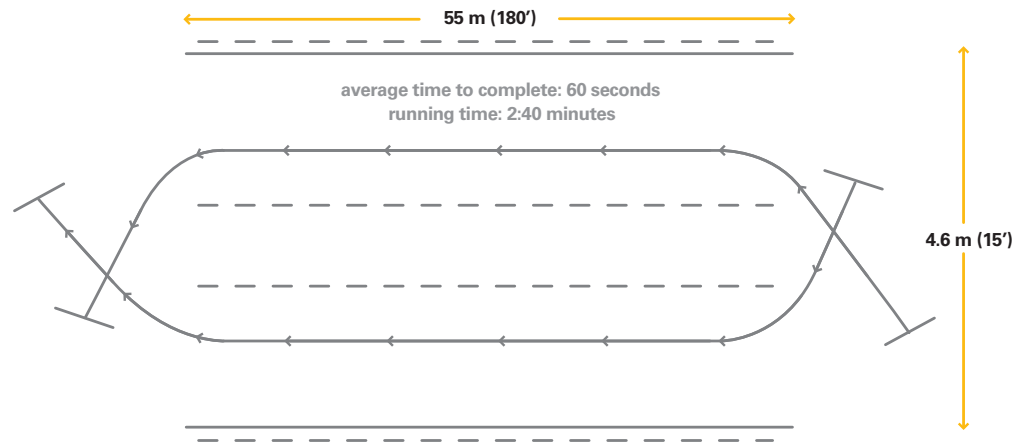

*During Pass Three, Roller One goes back in the lead and extends the pattern length by another 10 m (30') in order to roll past the previous stop marks and to move the pattern closer to the paver. This pass will consume about 60 seconds and the total running time is 2 minutes and 40 seconds.*

**INITIAL PHASE – PASS FOUR**

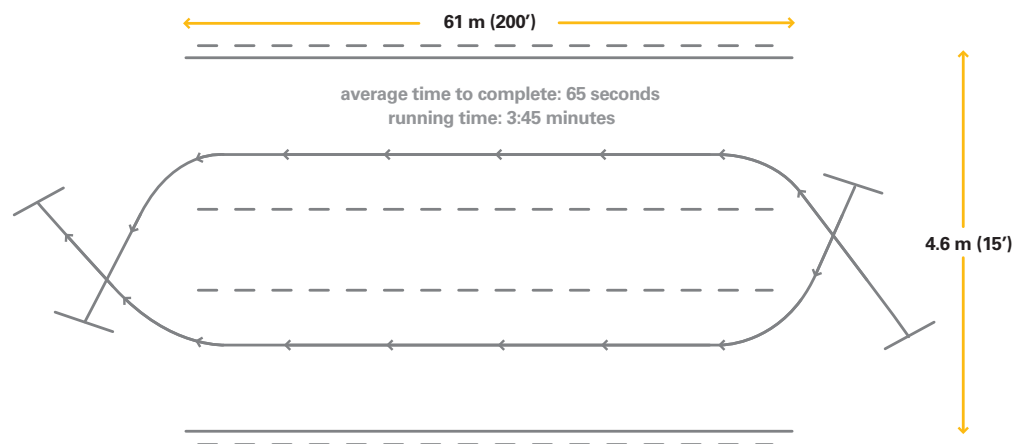

*During Pass Four, both compactors return back along the edges. The pattern increases a little in length as both compactors work past the previous stop marks. Now, the right edge and left edge of the mat have been rolled four times, the number of passes verified by the test strip. The running time is at 3 minutes and 45 seconds. A strip about 1.3 m (52") wide remains in the center of the mat. Since the drum width of the two compactors is 1.7 m (67"), the two compactors can now operate in single file to complete coverage of the mat.*

**INITIAL PHASE – PASS FIVE**

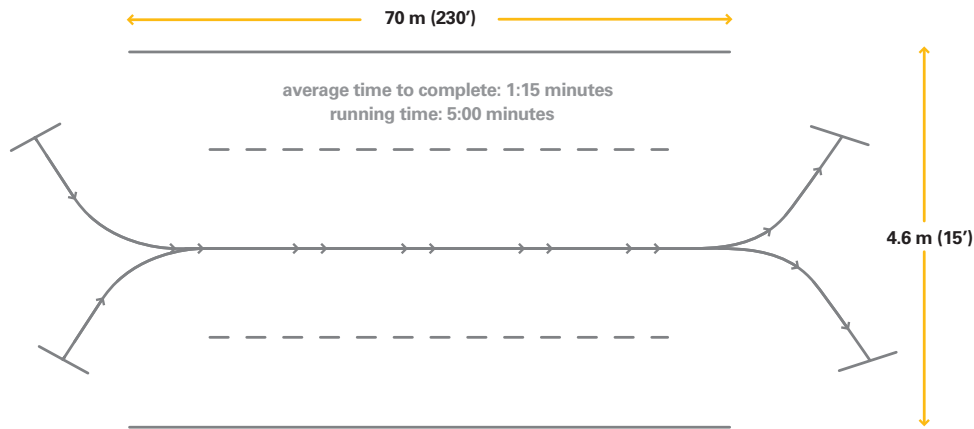

*The width of the uncompacted area is slightly less than the width of the drums so there is a small overlap on both sides of the drum. Since there is a small overlap, there is less need to worry about drums bouncing on the denser portion of the mat. Roller One and Roller Two turn toward the edges of the mat at the end of the pass. This pass is again slightly longer to keep up with the paver's progress. Pass Five will take 1 minute and 15 seconds for a running time of 5 minutes at this point.*

**INITIAL PHASE – PASS SIX**

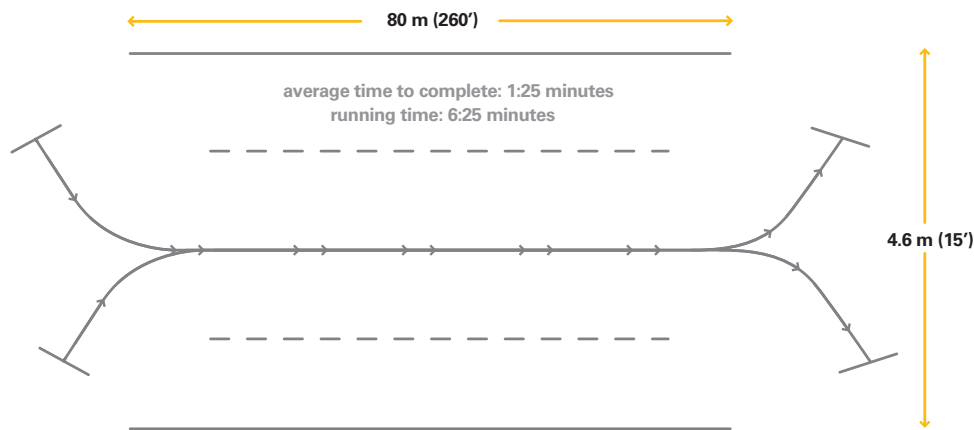

*Both compactors come back down the center of the mat in single file during Pass Six. They roll a little farther back through their stop marks. At this point, every part of the asphalt layer has had four vibratory passes. Density should be consistent across the width and length of the pattern. The running time is 6 minutes and 25 seconds.*

**INITIAL PHASE – PASS SEVEN**

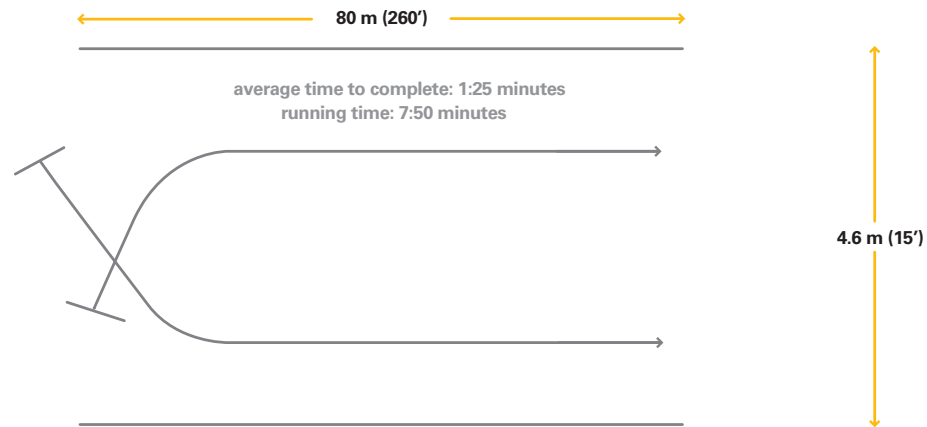

The last pass, Pass Seven, will be completed in the static mode as both compactors reposition themselves along the edges of the mat to start a new pattern. A little less than 8 minutes has been used by the two compactors assigned to the initial phase of compaction. Their pattern will stay well ahead of the tender zone.

**Note:** The examples shown in this section illustrate two-compactors echelon patterns. Three-compactors echelon patterns are used less frequently but may be needed on wide-width paving applications using hard-to-compact, stiff mixes.

**Summary:** Compactor operators and quality control personnel should understand how to set up rolling patterns that accomplish three goals. First is to achieve the specified density. Second is to match the production rate of the paver. Third is to create patterns that take advantage of opportunities to ensure mat smoothness. By using the Cat Interactive Production Calculator and creating cooling curves, you can plan successful patterns prior to the start of the project.



## Unit 6

# JOINT COMPACTION

Creating quality joints requires the best efforts of both the paving and the compaction crews. Make sure your team holds up its end of the job.





*A well-built and properly compacted transverse joint should be flat and smooth.*

There are two types of joints, longitudinal and transverse. Longitudinal joints are formed at the parallel intersection of two layers of asphalt. Longitudinal joints can exist between a hot and a cold layer, a hot and a warm layer, or two hot layers laid down simultaneously.

Transverse joints are formed at the perpendicular intersection of two layers of asphalt. Most commonly, a transverse joint is created when paving starts as a continuation of a previously laid mat. The first part of Unit 6 will deal with construction and compaction of transverse joints.

### [ TRANSVERSE JOINT COMPACTION PATTERNS ]

A transverse joint is created when paving begins at a point where the fresh asphalt layer meets a previously laid and compacted asphalt layer. The transverse joint will then be perpendicular to the direction of paving and the direction of compaction.

There are several techniques used to compact transverse joints, but the goal is always the same. The joint should be compacted flat and the area in front of the joint should be flat and smooth without high spots or depressions. Before paving and compacting a transverse joint, there are fundamental best practices that the crew should follow.

First, always make sure the transverse joint is in good condition prior to paving and compaction. Never start with a rounded or irregular edge at the transverse joint.

A utility cold planer, a skid steer with a cold planer attachment, or a circular saw must be used to cut a straight vertical face at the transverse joint. The area where the joint is cut should be the correct thickness and parallel to the line of paving.

**User Tip:** *When paving a lane and preparing to stop for the end of a shift, the paving crew commonly changes the feeder system control to the manual mode in order to use all the mix and avoid leaving a large pile of mix when the screed is picked up. Consequently, the head of material in front of the screed starts to change and the mat thickness becomes variable. Caterpillar recommends that the crew mark the mat as soon as they switch to manual feeder system control. The transverse joint should be cut at the point where the mat is marked to avoid cutting in a location where the mat is decreasing or increasing in depth.*



*Example of a poor starting reference. Rounded face with deep plunge cut will hinder compaction.*



*Cutting or milling a straight vertical face is a requirement for a transverse joint.*

A good starting joint will have a vertical face and the asphalt layer will be flat, not rounded, tilted up or tilted down. The face of the joint should be coated with tack to help create a bond between the cold asphalt layer and the hot asphalt layer. Clean the area of the cold mat just behind the joint so the height reference for the paver screed is accurate.

Another important factor in constructing and compacting a transverse joint is putting the correct starter boards under the paver screed as the screed is set down at the starting point. The starter boards

provide the pre-compaction thickness of the mat as the paving crew pulls the screed off the starting joint. For estimating purposes, you can assume that the mat laid by a vibratory screed will compact at a rate of about 6 mm (1/4") per 25 mm (1") of loose mat thickness. Therefore, if the loose depth is 50 mm (2"), the starter boards would need to be 12 mm (1/2") thick. If the paver has a tamping screed, the compaction rate will be much less, typically around 10% and the starter board thickness will be less.



*Example of a good saw-cut joint that has been tacked prior to the start of paving.*



*Checking the thickness of the starting joint helps the crew select the correct starter board thickness.*



*After the paver pulls off the transverse starting joint, minimal handwork should be needed.*

If the paving crew has done a good job building the transverse starting joint, the joint should need only minor handwork. If the joint is too high or too low, substantial handwork may have to be done prior to the start of the joint compaction process. Joint compaction should begin as soon as all corrections, if any, have been completed.

The transverse joint compaction technique recommended by Caterpillar is designed to flatten the hot / cold transverse joint while maintaining the smoothness of the mat in front of the joint.



**User Tip:** Caterpillar recommends that the crew measure the height of the compacted starting joint. Then, subtract that number from the thickness of the loose mat that was being laid during the previous shift. The result will be an accurate starter board thickness. For example, if the compacted transverse joint height is 40 mm (1.6") and the thickness of the loose mat laid by the screed was 50 mm (2"), then the starter boards should be as close to 10 mm (0.4") as possible.



The compactor operator can start in the center of the cold compacted mat or along one side of the compacted mat. Proceed forward, starting to turn the drums at an angle as the first drum approaches the joint. Work the front drum across the outer portion of the joint at an angle with both drums static, being careful not to distort the edge of the fresh mat if the edge is unconfined. Back up in the same path.

front drum across the joint in the center of the mat. Reverse in the same path.

Move to the center of the cold mat. Proceed forward and work the front drum at an angle across the remaining outer portion of the mat. Use a straight edge to verify that the joint has been compacted flat across its entire width. Repeat static passes if needed.

Move over to one edge of the cold, compacted mat. Proceed forward in the static mode and work the

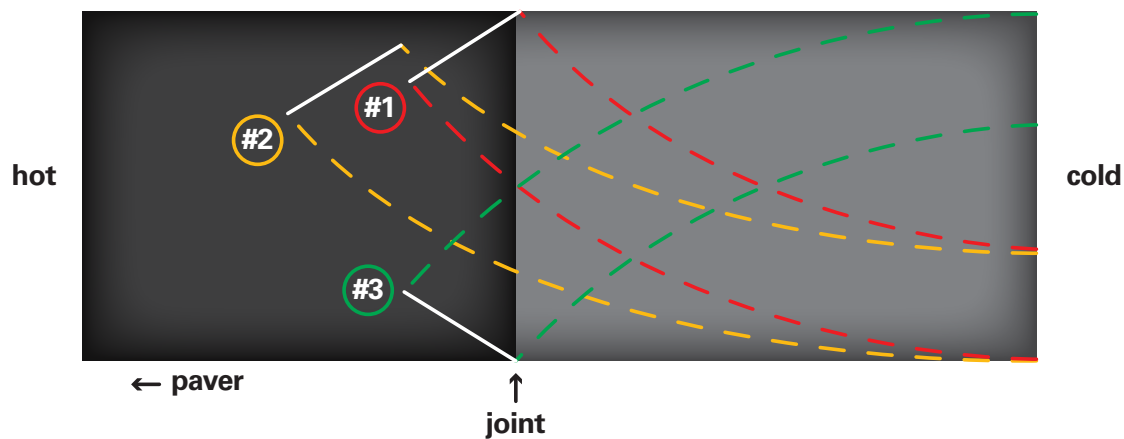

This transverse joint rolling pattern provides two benefits. First, the approach to the hot / cold transverse joint is at an angle. The angled approach helps flatten the hot mix while minimizing the tendency for the drum to push mix away from the joint.

its first pattern, the stop marks will be cleaned up and smoothness will be better in the joint area. Notice, also, how the operator made sure to pull farther forward at the end of the second pass so stop marks were not left in the same area.

Second, all the drum stop marks on the fresh mat in front of the joint are left at an angle to the direction of compaction. As the initial phase compactor starts



*Initial compactor starting first pattern and cleaning up stop marks left during joint compaction pattern.*

When all the elements of paving and compacting the transverse joint have been done correctly, the operator of the initial compactor should be able to start the established rolling pattern.

The paver should not have to wait for the transverse joint to be compacted, but should be able to pave at the calculated speed and still be a reasonable distance away from the joint as initial compaction starts.

Another transverse joint rolling pattern that is sometimes used requires adequate space for the compactor to approach the joint from the side.

Some crews prefer, when possible, to compact a transverse joint by rolling across the joint from the side. This technique is very effective at flattening the joint, but it leaves drum edge cut marks that are perpendicular to the direction of compaction.



When space permits, compacting a transverse joint from the side can be done.

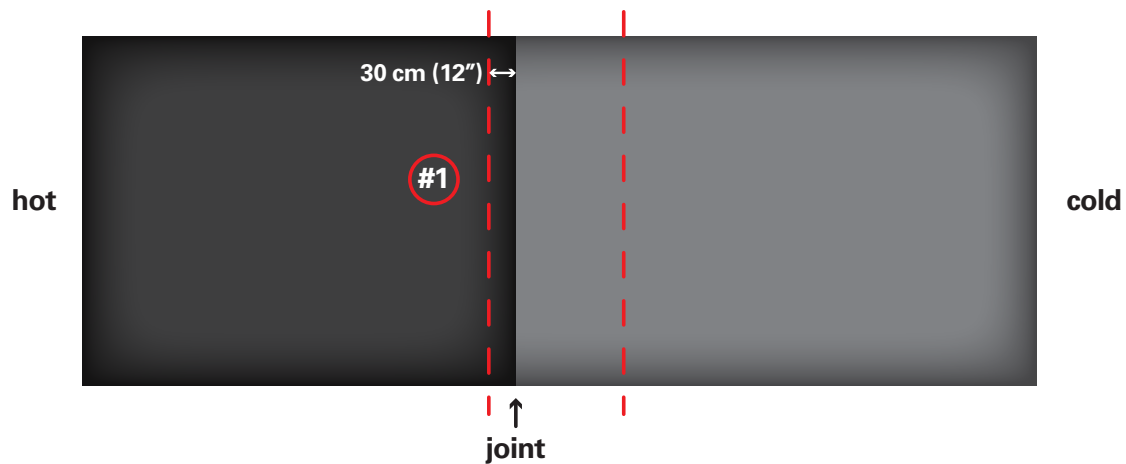

When compacting a transverse joint from the side, make the first pass with most of the drums on the cold mat with a 30 cm (12") overlap on the hot mat. Check the flatness of the joint.

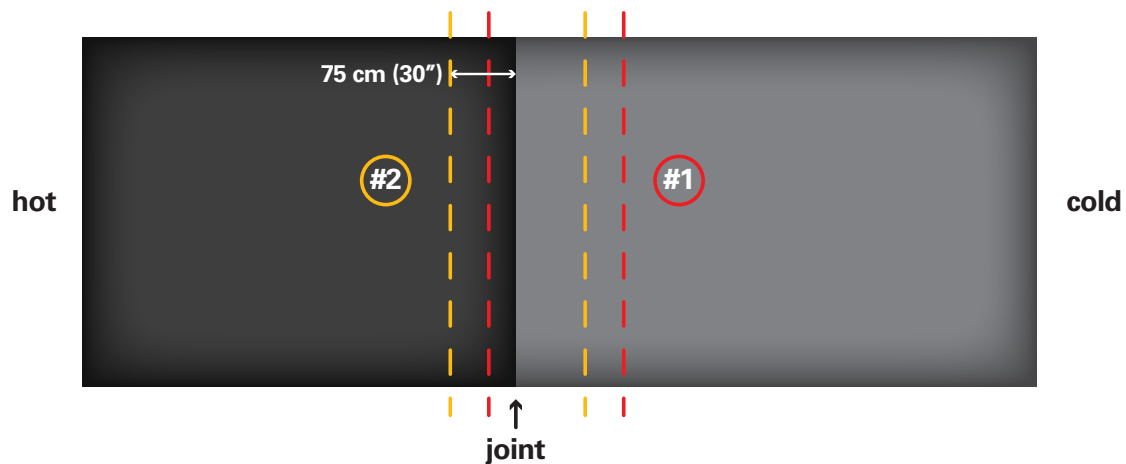

If another pass is necessary to flatten the transverse joint, move over with more of the drums on the hot mat. The larger overlap will help clean up the first drum edge mark.

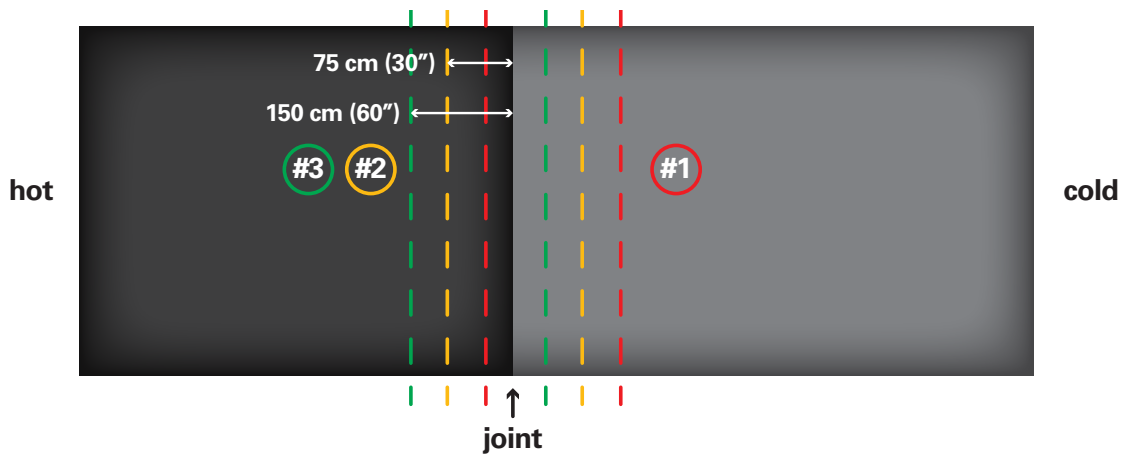

If another pass is necessary, move across the joint with most of the drum on the hot mat to clean up the second drum edge mark. The drum edge cut mark left by the third pass is perpendicular to the direction of compaction. When the initial compactor starts its first pattern, it will tend to push over the drum edge mark and can create a bump a short distance in front of the transverse joint. Caterpillar does not recommend this pattern for any project that will be measured for smoothness.

All transverse joint passes, no matter what pattern is used, should be made in static mode. It should not be necessary to activate the drum vibratory system in order to flatten the joint. If a utility compactor is used for transverse joint compaction, low amplitude vibration may be used, if necessary.

If a joint is constructed poorly, it may require a lot of handwork before compaction can begin. Never use the compactor to try to flatten a joint that has the hot mat laid too thickly by the paver.

Remember, the mat will only compact so much. If you continue to vibrate on the joint, you will fracture

aggregates, overwork the mat in that area and end up losing density due to over-compaction.

Finally, Caterpillar does not recommend compacting a transverse mat by rolling straight across the joint from the cold side to the hot side.

If a compactor rolls straight across the transverse joint, the drum tends to bump over the hot mat rather than tuck the mix under the drum. Also, the drum is moving mix away from the face of the joint, an action that can contribute to high air voids and premature joint failure.

**Summary:** Transverse joint compaction is truly a team effort. First, the paving crew must construct the joint correctly, leaving the correct pre-compaction height and a flat surface without bumps or low spots. Then, the compaction crew must flatten and seal the joint without distorting the mat or creating bumps. Adherence to best practices is the key to paving and compacting transverse joints.

### [ LONGITUDINAL JOINT COMPACTION PATTERNS ]

Longitudinal joint construction and compaction involve another multi-step process that requires doing many fundamentals correctly. How the compaction team approaches the work on longitudinal joints depends on the objectives of the project.

If appearance is the main objective, then the compaction process should focus on making the joint as invisible as possible. Joint appearance is normally most important for parking lots and city streets.

If joint density is the main objective, then the compaction process should focus on achieving high density at and around the longitudinal joint. Joint density is normally most important on high-volume roads and airports. The process of creating the highest density at the longitudinal joint is the first topic to be addressed.



*Having a straight edge for joint matching is a key part of building a quality longitudinal joint.*

**User Tip:** A useful option for some applications is an edge cutter. The edge cutter installs on Cat Asphalt Compactors in order to trim unconfined edges. The trimmed edges provide an improved vertical face and a better line for matching.

## [ HIGH-DENSITY LONGITUDINAL JOINTS ]

The first step in creating a quality, high-density longitudinal joint is building it correctly during the paving process. The paver operator should have a steering guide, paint stripe or string to follow. The joint edge should be as straight as possible in order to make the joint matching as easy as possible.

Next, the paving crew should have the end gate ski in contact with the grade being paved. The end gate ski should float on the grade and create a uniform vertical edge that will provide a good bonding surface for joint matching.



Create a vertical unconfined edge by running the screed end gate in the float position on the grade being paved.

## INCORRECT SQUARE JOINT — END GATE UP

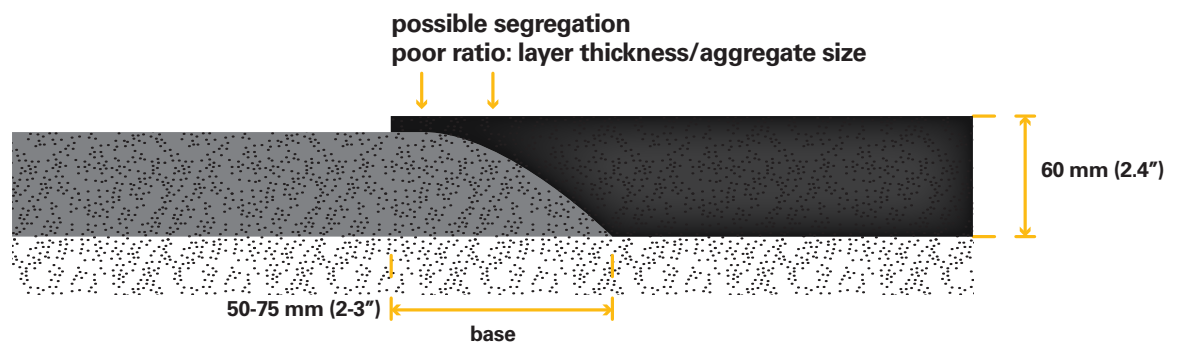

When the paving crew operates the screed with the end gates in the raised position, the unconfined edge rolls over, especially when being compacted. The sloped edge causes larger aggregate to drag under the screed when the joint is being matched by the next paving operation. You are likely to see broken aggregate along the longitudinal joint when the joint is compacted. Caterpillar recommends always running the end gates down in the float position when creating an unconfined edge that will be matched by the next lane.

**CORRECT SQUARE JOINT – END GATE DOWN**

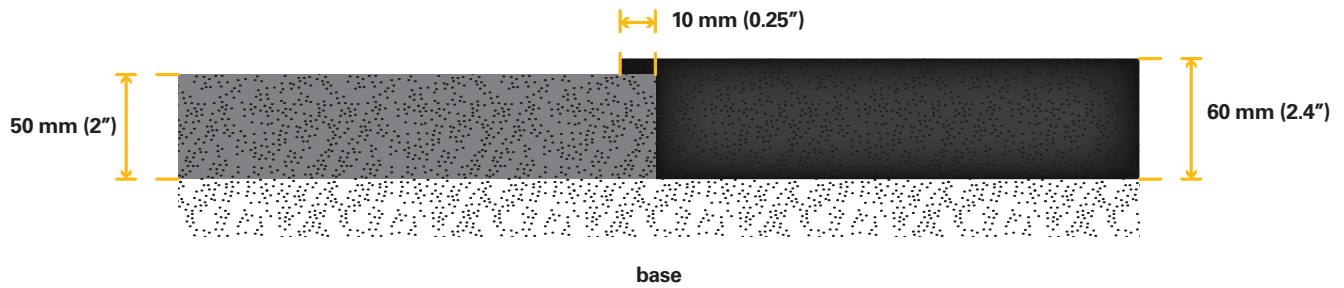

Finally, when the paving crew matches the unconfined edge to create the longitudinal joint, they should overlap the cold asphalt layer about 10 mm (0.25"). The overlap is necessary to make sure there is enough material at the joint to provide a good seal in order to prevent moisture penetration. The height of the hot asphalt layer should be enough to allow for its compaction rate. In the example above, the cold compacted layer is 50 mm (2") thick. The hot asphalt layer is laid 60 mm (2.4"). After compaction, the hot asphalt layer will match the height of the cold mat, assuming that the crew has correctly calculated the compaction rate. Remember, the compaction rate, as a general rule, is about 6 mm (1/4") per 25 mm (1") of screed laid thickness when a vibratory screed is used and about 5 mm (1/5") per 25 mm (1") when a tamping and vibrating screed is used. Always verify the compaction rate of the fresh layer when building a longitudinal joint.

Longitudinal joint raking should be avoided. If the joint overlap and the height of the hot layer are correct, the joint will not need to be raked. Light bumping or minor handwork is permissible. The

paving crew should immediately correct the paving technique if excessive raking is needed prior to compaction.

**FIRST PASS FOR HIGHER JOINT DENSITY**

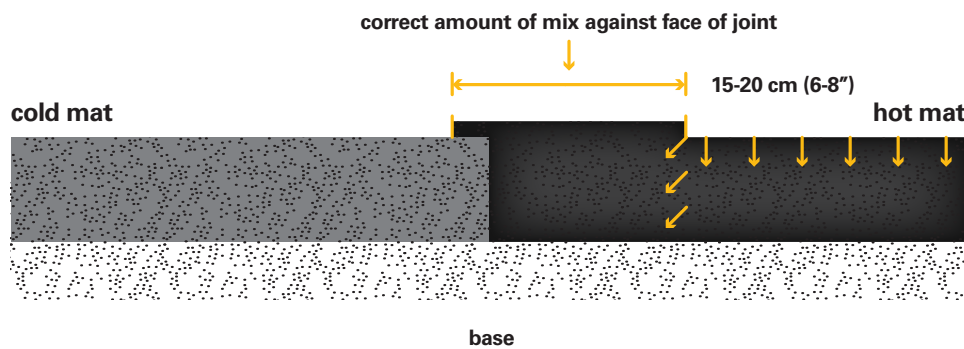

When joint density is the main objective of the compaction process, the first pass made by the initial phase compactor should be made with both drums on the hot mat about 15-20 cm (6-8") away from the joint. By keeping the drums slightly away from the hot / cold joint, asphalt mix is pushed toward the vertical joint face. Pushing mix toward the joint helps ensure that there will be fewer air voids in the mat after compaction is completed.

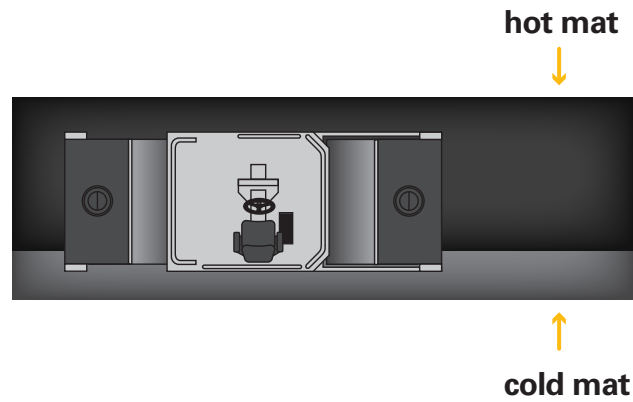

*During the return pass along the longitudinal joint, the drums should slightly overlap onto the cold mat. The slight overlap will begin the process of creating joint density, sealing the joint and knocking down the hot mat so its height will be the same as the cold mat.*



*Pneumatic compactor sealing a hot / cold longitudinal joint.*

During all phases of compaction and with all types of compaction equipment, the longitudinal joint can be overlapped once the initial pass has been made.

Pneumatic compactors are especially good at knocking down the hot layer in order to equalize the height of the two asphalt layers.



**User Tip:** If a vibratory compactor is used to overlap the joint, be careful not to overlap more than about 16 cm (6"). If too much of the vibratory drum is on the cold, compacted mat, drum bouncing is likely to occur. You may see ripples in the fresh mat and fractured aggregates showing on the cold side of the joint.

**User Tip:** If there is a slope difference between the cold mat and the hot mat, be careful not to straddle the joint. Two different slopes create a crown along the joint. The crown is specified for drainage. Straddling the joint will knock down the crown and interfere with moisture drainage.

### CORRECT SQUARE JOINT – END GATE DOWN

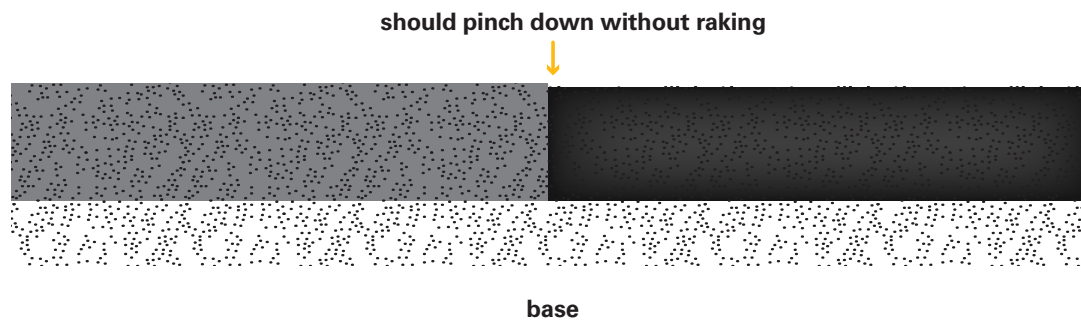

The compacted longitudinal joint should result in height match between the two layers and a high degree of density. The joint should be sealed and tight to resist moisture penetration. Remember, there are three keys to achieving good longitudinal joint density.

- Joint faces are vertical with the correct pre-compaction height
- No raking—light bumping permitted
- First pass 15-20 cm (6 -8") away from the joint

## [ JOINT COMPACTION FOR APPEARANCE ]

On some projects, the main goal is to make the longitudinal joint disappear as much as possible. The task is made easier if the longitudinal joint is between hot mats being laid down simultaneously

by multiple pavers working in echelon. Creating better appearance is also easier if the joint is between a hot mat and a warm mat that is still somewhat pliable at the surface.



*Sealing the longitudinal joint during the first pass improves the appearance of the joint.*

To create a longitudinal joint with the best final appearance, make the first pass along the joint with most of the drums on the cold side of the joint and a slight overlap on the hot side. The compactor must be operated in the static mode during this pass to avoid bouncing on the cold side.

Before setting up a pattern to include a first pass to seal the joint, be sure you have considered the following factors:

- Is there enough time to include this pass in the pattern? Since you make this pass in the static mode with the drums mostly on the cold mat, there will be no density increase in the hot mat. You may have to increase compactor working speed in order to keep up with the paver. Use the Cat Interactive Production Calculator to verify that the extra pass is possible.

- How much mat temperature will be lost by adding the extra pass? The temperature of the asphalt layer is critical to achieving target density. When the ambient temperature is low and the mat is thin, heat loss occurs quickly. It may not be possible to use the initial phase compactor for the pass that seals the joint. Perhaps you'll need to add another compactor to complete this extra pass.
- Is there enough space on the cold side of the joint to accommodate the width of the compactor? If you are working on a road or street project, there may be traffic cones or some sort of barrier close to the longitudinal joint that would prevent you from working on the cold side. You may have to use a narrow drum compactor more suitable for operating in a confined space.

If you're paving and compacting a parking lot or working in a new residential area, you probably will not have to worry about traffic or space. However,

you should always confirm production requirements and mat temperatures when planning to include a joint-sealing pass.

### LONGITUDINAL JOINT – FIRST PASS

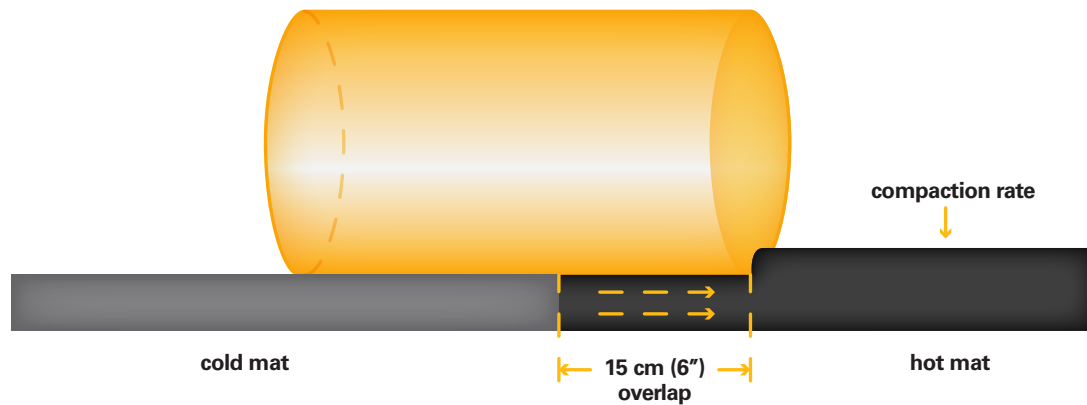

*During Pass One, the drums slightly overlap onto the hot side. From an appearance standpoint, the drums effectively push the hot mix down to make the joint height equal on both sides. From a density standpoint, some mix is pushed away from the joint as there is no confinement near the drum edge.*

### LONGITUDINAL JOINT – SECOND PASS

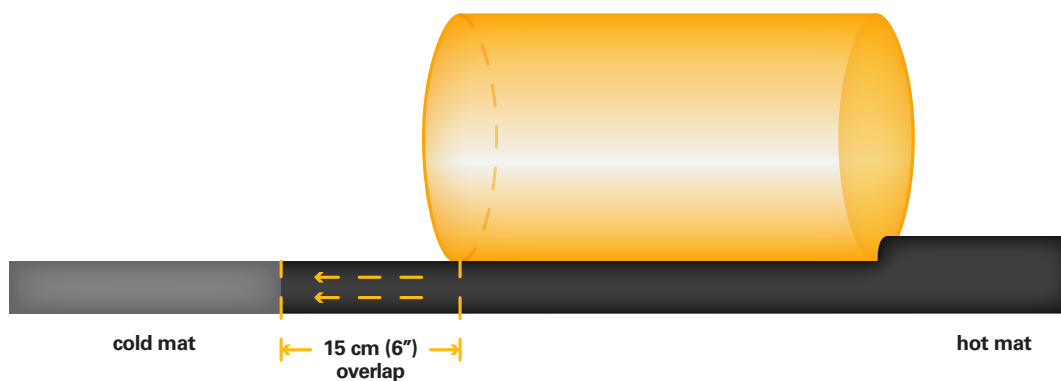

*During Pass Two, position the compactor with both vibratory drums completely on the hot mat with the drum edge about 15 cm (6") away from the joint face. This vibratory pass starts to create the required density and tends to push a little mix back toward the longitudinal joint.*

**LONGITUDINAL JOINT – THIRD PASS**

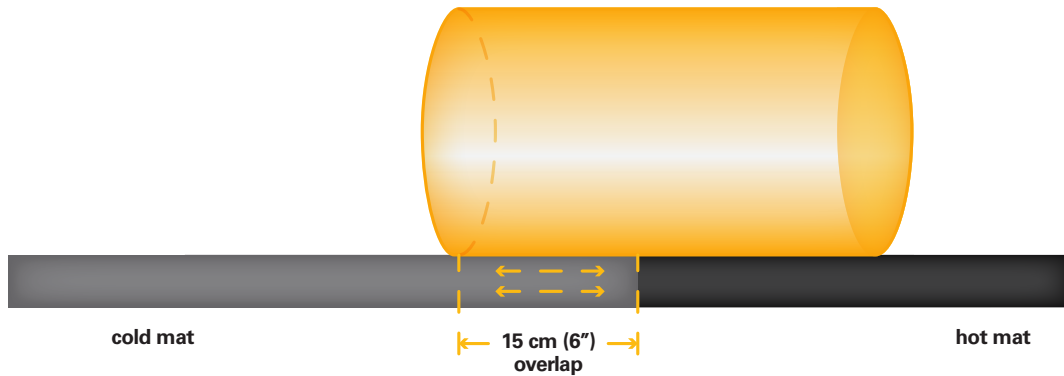

During Pass Three, position the compactor so the drums slightly overlap the longitudinal joint with most of the drums on the hot mat. Since the overlap onto the cold mat is small, you can operate with the drums vibrating. All other passes, if any, with all other compactors can overlap the joint during passes adjacent to the longitudinal joint.

**COMPLETE ROLLING PATTERN**

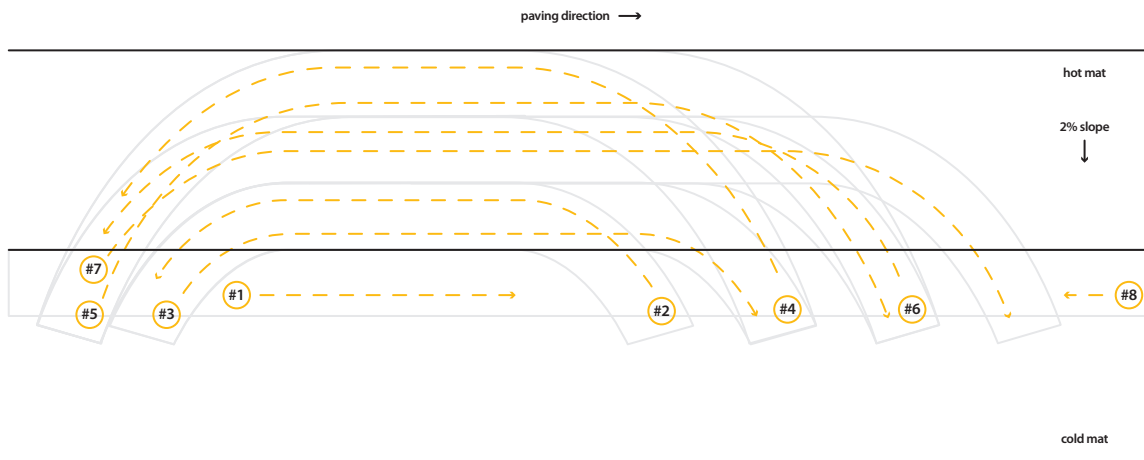

Assuming that two passes achieve target density, the rolling pattern looks a little different because of the first pass to seal the joint. In this pattern, you also can take advantage of the cold mat to stop and reverse the compactor. Notice that during Passes Four and Five the operator has moved to the unconfined edge. The unconfined edge should be compacted after the mat slopes down from the joint toward the unconfined edge. Passes Six and Seven complete the mat coverage by compacting the center of the mat.

At the end of Pass Seven, the compactor operator has stopped to reverse on the cold mat and is located some distance ahead of the point where the joint has already been sealed. Therefore, Pass Eight is a return static pass with most of the drums on the cold mat. After Pass Eight, the operator can position the compactor to begin a new pattern. Because of the joint-sealing pass, the rolling patterns end with the initial compactor in different locations.

If you use a rolling pattern like the one shown, the pass counting map is a good option to help the operator develop consistency.

### [ COMPACTION OF SPECIALTY JOINTS ]

In addition to vertically faced joints, there are wedge joints and notched wedge joints. These types of joints may be specified on highway projects for traffic safety.

Some public works departments require the construction of a notched wedge joint whenever there is a possibility that an unconfined edge may be opened to traffic and that unconfined edge is 50 mm (2") high or higher. The purpose of the notched wedge is to make it easier for vehicles to cross the open vertical edge.

As an aid to the compaction of notched wedge joints, towed rollers are sometimes attached to the paver screed. The towed roller is normally used when the asphalt layer includes a notch that is at least 50 mm (2") high and a wedge that is at least 50 mm (2") thick. Properly constructing notched wedges is the key to achieving good notched wedge joint density.



*A notched wedge joint being laid down by the paver.*



*Towed rollers may be used in conjunction with notched wedge joints.*

### NOTCH WEDGE

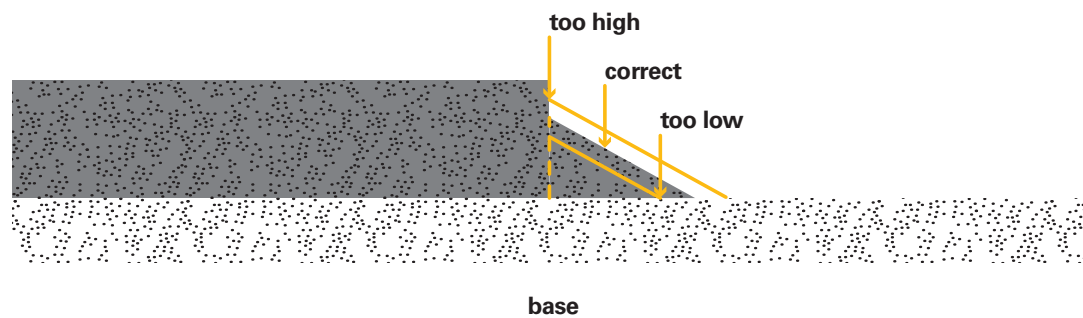

*Planning for the correct notch height and wedge thickness is critical when paving notched wedges. The height of the notch should be at least twice the size of the largest aggregate in the asphalt mix. Likewise, the thickness of the wedge should be at least twice the size of the largest aggregate. If the notch is too short, aggregate will drag along the face of the notch. If the wedge is too thin, aggregate will drag along the edge of the wedge.*

## INCORRECT NOTCH WEDGE

notch not deep enough

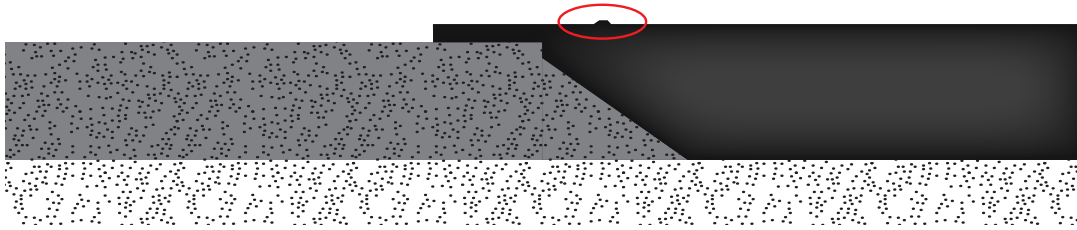

base

*A shallow notch will result in a line of segregated large aggregate along the face of the notch. You may see uncoated rock surfaces in this area, a sign that aggregates are being fractured because the layer is too thin. Over time, moisture will penetrate through the segregated material and the joint will begin to separate, causing premature joint failure.*

## CORRECT NOTCH WEDGE

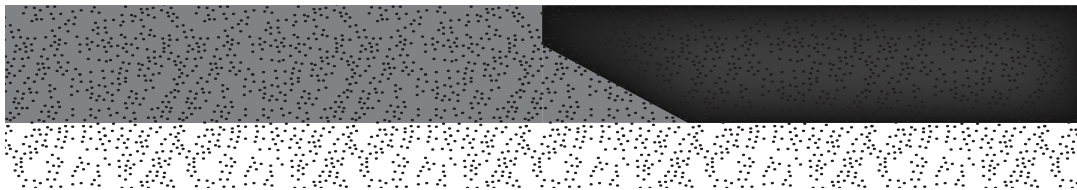

base

*When the notched wedge is built correctly, it can be compacted correctly. Follow the same procedures as if you were compacting a joint with a vertical face. Stay 15-20 cm (6-8") away from the joint with the drums entirely on the hot mat during the first pass along the longitudinal joint. Most research shows that notched wedge joints have as high or even higher density when compared to the densities of vertical joints. Wedge joints are another option sometimes specified by public works departments for the same reason that notched wedges are specified: traffic safety.*

## WEDGE JOINT

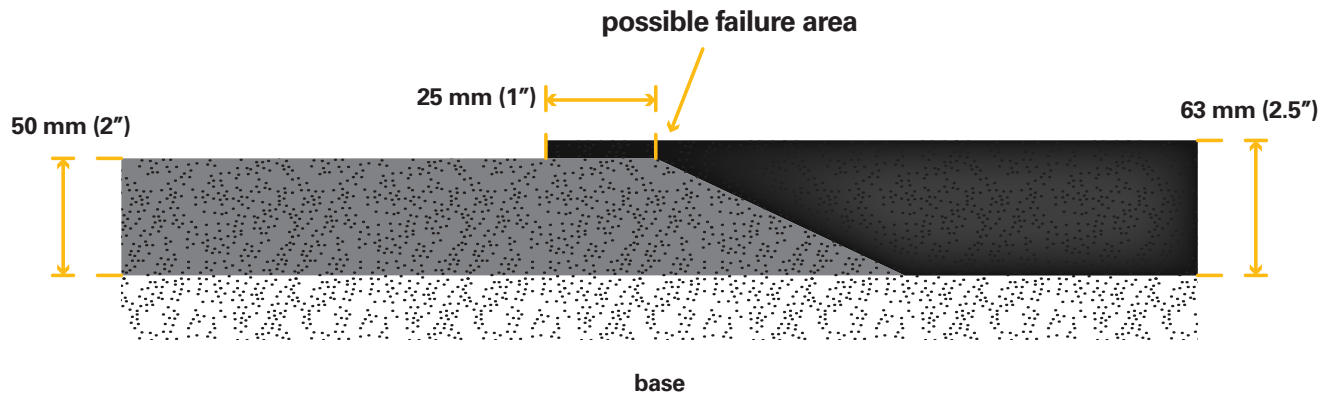

## WEDGE JOINT

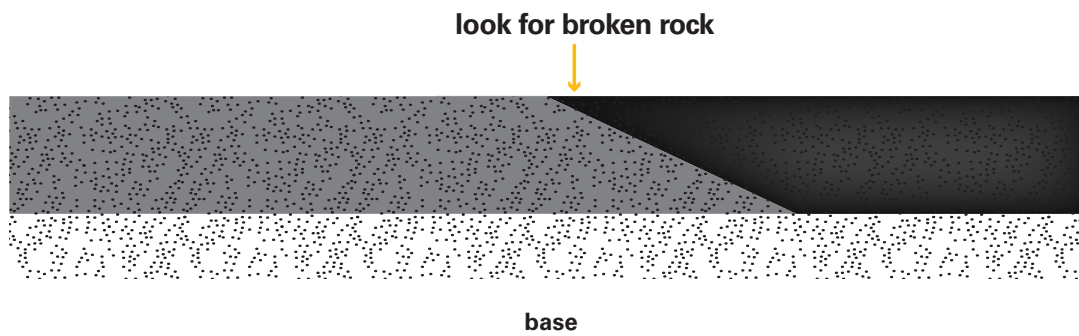

Wedge joints have an inherent problem due to lack of mat thickness in the area next to the intersection of the hot and cold mats. There is no vertical notch. There is only an angled face, or wedge, upon which the fresh asphalt is placed. Therefore, there is always a possibility of segregation at the top of the wedge. Prior to compaction, you may see a segregation stripe just inside of the joint. After compaction, you may see a stripe of uncoated rock just inside the joint. Wedge joints are most suitable when the largest aggregate in the mix formula is 9 mm (3/8"). Mixes with larger aggregates are prone to segregation at the wedge joint.

**Summary:** Much like transverse joints, building quality longitudinal joints requires the best efforts of both the paving crew and the compaction crew. The compaction process cannot correct mistakes made during the paving process. When troubleshooting longitudinal joint problems, start by looking at the edge of cold mats. Then verify that overlap and height of the hot mat are correct. Finally, adjust your rolling pattern to conform to the requirements for joint density or for joint appearance.





## Unit 7

# COMPACTION ISSUES

Compaction issues typically result from variability. Start your troubleshooting efforts by looking for variability in the paving process, mat temperature, rolling patterns, and rolling speed.





*Stone Matrix Asphalt with polymer-modified asphalt cement stuck to steel drum.*

This unit reviews some of the most common compaction issues that are faced by operators, quality control personnel and supervisors. There

is no significance to the order in which the issues are presented. When possible, similar issues are grouped for ease of understanding.

### [ ASPHALT PICK-UP ON DRY DRUM SURFACES ]

The most common cause of downtime on double drum, asphalt compactors is a malfunctioning drum spray system.

If any part of the steel drum does not have a water film on the surface, hot asphalt is likely to stick to

the drum. The stickier the asphalt mix, the more severe the problem. A small amount of asphalt pick-up on the drum quickly becomes a large problem. With each drum rotation, the amount of pick-up increases and the mat will begin to show divots.



*Divot made in the fresh mat by asphalt stuck to the drum.*



*Water spray nozzles operate properly when maintenance guidelines are followed and clean water is used.*

When asphalt begins to stick to a drum surface, operation of that compactor must be terminated until the drum is completely clean and any problem with the drum spray system is repaired. Continuing to operate the compactor will result in severe mat damage that will require extensive handwork to fill in and level divots left in the mat.

- **Use clean water.** Whenever possible, fill water spray reservoirs with water from approved sources. If you have to use pond water, for example, increase the frequency of maintenance steps.
- **Change main spray system filters.** Follow the filter change interval shown in the machine's Operation and Maintenance Manual. When the main spray system filter is plugged, water bypasses the filter and unfiltered water goes to the spray bars. Unfiltered water is more likely to cause spray nozzles to plug. Always have a spare filter stored on the compactor or in the maintenance vehicle.
- **Maintain inlet filters.** Most water reservoirs have an inlet filter inside the reservoir fill port. The inlet filter is the first stage of water filtration. Do not discard the inlet filter. Place the water supply hose inside the inlet filter.
- **Clean spray nozzles.** The spray nozzles have internal brass or plastic screens. Nozzle screens should be examined daily for contamination. Clean nozzle screens thoroughly as needed. If you use contaminated

The primary cause of dry areas on the drum surface is a plugged spray nozzle. Good maintenance and clean water supply are the keys to preventing plugged spray nozzles.

water, increase the frequency of nozzle maintenance. If only one side of the nozzle is plugged, the spray pattern will be smaller and can cause the dry strip on the drum and start the asphalt pickup.

- **Maintain water distribution mats.** The drum will have some type of water distribution mat to help spread the water film evenly on the drum surface. As the distribution mats wear, you may have to adjust them to maintain good drum contact. Replace distribution mats according to wear indicators.
- **Understand spray system capabilities.** Most water spray systems offer full-time or intermittent spray. Never sacrifice water coverage in an effort to conserve water. It is better to stop more frequently for water refills than to stop for drum cleaning.
- **Protect the water spray system during cold weather.** An optional water spray system antifreeze kit is available. It includes a separate reservoir for antifreeze. At the end of the shift, the operator can circulate antifreeze through the system to prevent overnight freezing.

**User Tip:** Know how to operate the water spray system in the event of water spray pump failure. Most water spray systems include two water pumps and most systems have the capability to supply both spray bars with only one pump. Know what needs to be done to operate with one pump while a replacement pump is being delivered.



*Hot asphalt can stick to rubber tires and the clumps can fall off the tires to create a substantial loss of smoothness and cosmetic appearance.*

### [ ASPHALT PICK-UP ON RUBBER TIRES ]

Asphalt also can stick to rubber tires. The severity of asphalt sticking to rubber tires depends primarily on the stickiness of the asphalt. Tire pick-up is also affected by the difference in temperature between the surface of the asphalt layer and the rubber tires.

- Use a bio-degradable release agent to clean the affected tires. Apply more release agent to the tires before resuming the compaction process.
- Be sure the distribution mats and tire scrapers are properly positioned and in good working condition.
- Move the pneumatic compactor on the asphalt layer in an area where the surface temperature is relatively low.
- Heat the tires by operating on the warm mat before moving ahead to a higher temperature zone.



*Wheel covers are an important feature on pneumatic compactors and should be installed to help prevent heat loss in the rubber tires.*

Heating the rubber tires and keeping them at the correct temperature are very important. Wheel covers help keep heat confined around the front and rear axles. Caterpillar recommends using wheel covers on pneumatic compactors for all asphalt compaction applications. Covers are especially important when compacting asphalt that contains modified asphalt cement. If wheel covers are not installed, the tires are exposed to the ambient conditions and can lose heat rapidly.

Release agents are sometimes used to help prevent hot asphalt from sticking to rubber tires. Always confirm with the public works department what release agents are permitted.

Most compactors have a tire spray system that is often filled with water and an additive. Common additives include detergents, water softeners or purpose-designed additives that increase the film thickness of the water sprayed on the tires.

**User Tip:** *When loading a pneumatic compactor on a transport, be sure to roll up the wheel covers and secure them in the transport position. If you leave the covers down, the tires may run over the covers and damage them.*



*Release agents can be applied using a spray canister or by using the compactor's tire spray system.*

In some areas, natural vegetable oil is substituted for water in the spray system reservoir. Do not use petroleum distillates as they are harmful to asphalt and the environment.

- Before the start of the paving and compaction process, operate the pneumatic compactor on a paved surface behind the starting point. Operate at high speed to build up heat in the rubber tires by flexing them.
- When using a release agent, wet the tires thoroughly just as the compactor is ready to start its first pattern.
- Check the temperature of the asphalt layer and guide the pneumatic compactor operator into the correct temperature zone.
- Be alert for any sign of excessive asphalt pick-up on the tires. Especially watch for asphalt clumps falling off the tires when the compactor stops and reverses.

To prepare the pneumatic compactor for placement in the desired position behind the paver, plan your approach to heating the tires. Apply a release agent (if needed), and keep the tires hot.

- If you see excessive asphalt pick-up, immediately clean the tires. Move the compactor back to a cooler temperature zone. Gradually move the compactor forward allowing the tires to heat up prior to reaching the desired temperature zone.
- Once the tires are heated, keep them heated. If there is an interruption to the paving and compaction process, do not park the pneumatic compactor. Move the compactor to a place on the asphalt layer where it can continue to roll in order to keep the rubber tires heated.

### [ DEEP PNEUMATIC TIRE MARKS ]

Using a pneumatic compactor on hot asphalt layers, especially layers 75 mm (3") thick or thicker can result in deep tire marks that are difficult to clean up, particularly behind vibratory screeds.

Ordinarily, a pneumatic compactor is used during the intermediate phase of compaction on an asphalt layer that is already close to final target density. The tire marks it leaves in the mat are normally shallow and can be smoothed out by the finish-phase compactor.

However, if the compactor is used during the initial compaction phase or if the pneumatic compactor rolls an area where the mat is thicker and hotter than normal, the rubber tires can leave deep marks that do not clean up easily during finish compaction.

Using a pneumatic compactor during the initial phase is usually done when compacting a base or

binder layer that is going to have another layer laid on top of it. In that instance, the tire marks and loss of smoothness are less of an issue.

Using a pneumatic compactor during the initial phase on the final layer (wearing layer) of asphalt is not common because the final layer is often measured for smoothness. A pneumatic compactor is normally in the intermediate position when compacting the final asphalt layer.

If deep tire marks appear during the compaction of the final layer:

- Move the pneumatic compactor farther behind the paver where the asphalt layer is cooler, or
- Decrease tire pressure to flatten the tires somewhat and reduce the tire contact pressure.



*Tire marks left by the pneumatic compactor can normally be cleaned up by the finish-phase compactor.*



*Deep tire marks created by operating on a thick layer composed of a tender mix will be difficult to clean up.*

### [ VIBRATORY DRUM IMPACT MARKS ]

When too much vibratory compaction energy is applied to an asphalt layer, impact marks that do not clean up during the finish phase may appear on the surface of the asphalt layer.

In Unit 2, “Forces of Compaction,” you learned about the affects of weight and amplitude. In Unit 3, you learned about other factors, like working speed and layer thickness, that influence the compaction process. In the lower-left photo, it is obvious why the asphalt layer has drum impact marks.

The compactor made numerous, slow vibratory passes over the joint between the asphalt layer and the concrete gutter in an effort to knock down the asphalt layer for a better height match. It is certain that the drums were bouncing in this area. You can even see the resulting white, powdery surface that indicates fractured aggregate. In this case, the problem was created by the paving crew that paved the joint height too high. The compactor can only

reduce the thickness of the layer so much. When the layer becomes dense, the drums will begin to bounce and leave impact marks.

By way of review, if you begin to feel drum bouncing or if you begin to see impact marks in the surface of the asphalt layer, you should adjust one or more of the following variables:

- Check the working speed to make sure you are operating in the range that produces 26 to 46 impacts per meter (8-14 impacts per foot).
- Switch to a lower amplitude setting.
- If available on the machine, switch to a higher frequency.
- Operate with one drum vibrating and one drum static.
- Operate in the static mode.



*Drum impact marks, above. At right, establish a pattern that does not distort the hot asphalt when reversing.*





## [ REVERSING ON THE ASPHALT LAYER ]

Most of the rolling patterns used by steel drum, vibratory compactors require the compactor to stop and reverse on the hot asphalt layer. Unit 5 covers rolling patterns in detail. In this unit, we review the potentially significant problems caused by stopping on a fresh asphalt layer.

A steel drum compactor always stops at an angle on the fresh asphalt layer when reversing at the end of a pass. Leaving a stop mark that is at least a 30° angle will make it easier for the next compactor to clean up the stop mark. Be sure to use a compactor with drum width that makes it possible to complete an angled turn while stopping to reverse.

The operator will have a hard time stopping and reversing on a relatively narrow mat when using a compactor with drums that are 200 cm (79")

wide or wider. Prior to the start of a project, be sure to understand all the paving widths that the compaction crew will encounter. Use a tool like the Cat Interactive Production Calculator to match the compactor's production to the paver's production.

As a general rule, select compactors with drum widths that cover the mat in three overlapping passes. These compactors will have more space to make angled stops on the fresh asphalt layer. When production requires you to select compactors with wider drums that cover a mat in two overlapping passes, be sure to help the compactor operators establish a pattern that does not distort the hot asphalt.



### [ PARKING ON THE ASPHALT LAYER ]

An asphalt compactor of any type should never be stopped to wait on an asphalt layer until that layer is completely compacted and has cooled below 20° C (70° F). It is especially important to avoid stopping and waiting on an asphalt layer that will

be measured for smoothness. Make every effort to stop the compactor in a location that will not damage the freshly placed mat.



*Stopped and parked partially on shoulder.*



*Pulled away after six-minute stop.*

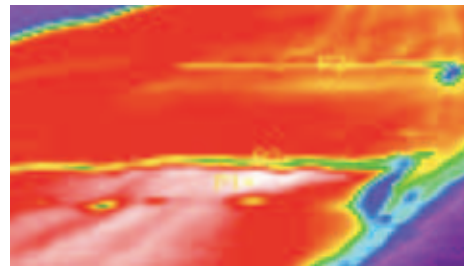

*Thermal image shows cold areas.*

Anytime a roller stops and parks on a fresh asphalt layer, the drums or tires will dent the mat. The photos illustrate the effect of a six-minute stop on the asphalt layer. In this example, the paver had stopped while waiting for more haul units. The initial phase compactor completed its pattern and the operator parked with the drums at an angle and with a portion of the drums on the 90 cm (3') emergency lane and a portion of the drums extending onto the driving lane that is going to be measured for smoothness.

After a six-minute stop, the paving process started again and the compactor operator started a new pattern. A view of the mat where the compactor had been parked reveals that water has pooled in the area where the drums sat and where the mat has been dented.

A thermal image shows that the steel drums caused significant heat loss in the mat where the drums sat. The temperature of the mat is 65° C (150° F) where the two steel drums were located. The mat has two more compaction phases remaining, intermediate and finish. However, the temperature of the mat in this area is now much lower than found in the normal patterns.

At the end of the shift, the finish-compacted driving lane was measured for smoothness using a profilograph. The Profile Index at the location where the compactor parked for six minutes shows two depressions and bulges caused by the steel drums and not cleaned up during the intermediate and finish compaction phases. The Profile Index is proof that parking on a hot mat for any length of time and at any angle is likely to leave permanent bumps in the mat.

If the paving process is interrupted, Caterpillar recommends parking any affected compactor on a surface that is cold and completely dense or that is not part of a driving lane. If no suitable parking area is available, the compactor(s) should deactivate the vibratory system, move to an area of the asphalt layer that is away from an active rolling pattern and continue to operate at slow speed on the mat until the paving process resumes.

### [ STOPPING FOR WATER REFILL ]

Depending on the size of the water spray system reservoirs and the climate conditions, a steel drum compactor must stop for a water refill one or more times per shift. It is important that the crew plan for water stops to avoid long interruptions to the compaction process and to avoid stopping the compactor on any portion of the asphalt layer that is part of the driving lane. Following are some recommendations for minimizing disruptions during water refill stops.

Park the compactor on a cold, compacted surface or on the shoulder when stopping to refill water spray system reservoirs. Often this means that the water supply truck must have a long hose. In some situations, the water supply truck must park on a cold surface and the water hose must extend across the 3.65 m (12') wide driving lane to reach a compactor parked on the opposite shoulder. Plan ahead by knowing the maximum hose length that will be required for water refills on each project. Make sure the water supply hose is long enough for every situation.

On some projects, the mat will have two unconfined edges without a shoulder for the

compactor to stop on. Or, the mat may have one unconfined edge and no room on the opposite side for the compactor to get off the mat. In those situations, plan to provide sturdy boards to place along the unconfined edge of the mat. The compactor can exit and enter the mat by using the boards for support and not crush the unconfined edge of the mat.

Minimizing the length of the water refill stops is important. The paving process may have to be temporarily halted until the compactor(s) can resume the pattern(s). Or, depending on the project and the types of compactors, you can move the intermediate compactor up to the initial phase while the initial phase compactor is stopped for water refill.

No matter what steps you take during the water refill process, there is a likelihood that the temperature of the mat will vary and it is possible that density will vary according to the severity of temperature loss. One way to save time during water refill stops is to position the water supply truck in a convenient location for quickly refilling the compactors.



*Compactor parked on the shoulder during water refill (left) to avoid denting the mat in the driving lane. Provide a way for the compactor to get off a mat with unconfined edges, if necessary.*

## COMPACTION CALCULATOR

Trucking			
Paver Speed			
Compaction			
Windrow			
<b>Yield</b>			
Slope			
Thickness			
Job Summary			
Legal			
Exit			

**General Inputs**

Paving Thickness:	[ 2.95 ] in	[ 75.0 ] mm
Paving Width:	[ 12.00 ] feet	[ 3.658 ] meter
Material Density Uncompacted:	[ 130 ] lbs/ft <sup>3</sup>	[ 2082 ] kg/m <sup>3</sup>
Truck Capacity or Total Tonnage:	[ 881.8 ] ton	[ 800.0 ] tonnes
<b>Length of Mat at 100% Yield:</b>	[ 4598.70 ] feet	[ 1402 ] meter
Actual Length of Mat produced:	[ 4691.60 ] feet	[ 1430 ] meter

**% Yield for given truck load or tonnage:** [ 102 ]

<b>Thickness:</b>	[ 2.95 ] in	[ 75 ] mm
<b>Length of Mat produced:</b>	[ 4691.6 ] feet	[ 1430 ] meters
<b>Width:</b>	[ 12 ] feet	[ 3.658 ] meters

Using the "Yield" feature on the Cat Interactive Production Calculator can help you position the water refill truck.

An example using the Cat Interactive Production Calculator demonstrates the importance of planning for positioning of the water refill truck. On this project, the production rate is 200 tonnes (220 tons) per hour. The paving width is 3.65 m (12'). The paving thickness is 75 mm (3"). The weight of the mix laid down by the screed is 2082 kg/cm<sup>3</sup> (130 lbs/ft<sup>3</sup>). One lane of a highway project is being paved continuously for the entire shift.

Based on the water reservoir capacity and the climate conditions, the compactor must stop for a water refill every four hours. In four hours, the paver should have laid down 800 tonnes (880 tons). Once all the data is entered into the yield calculator, the

result is 1402 m (4598') of paving in four hours. You should look for a location on the project that is close to the calculated yield distance, that is a convenient place to park the water supply truck, and that is appropriate for the compactor to stop. If there is no place for the compactor to park without denting the mat, plan to get the compactor off the mat using boards.

Having the water supply truck in position and personnel ready to refill the water spray system reservoirs will shorten the interruption to production and minimize mat temperature variations.

### [ TIGHT RADIUS COMPACTION ]

In some applications, most notably streets and parking lots, there will be areas where the compactor will be working on curved surfaces such as cul-de-sacs and around dividers and other

obstructions. The correct equipment and the correct techniques must be used to avoid distorting the fresh asphalt layer when compacting curved surfaces.



*Conventional 170 cm (67") drum compactor rolled continuously around the radius.*



*The outer edge of the drum stretched and distorted the fresh asphalt.*

Anytime the mat has a tight radius, the mat will be distorted if a conventional, high-production, steel drum compactor makes a continuous pass around the radius. The outer edge of the drum is covering a longer distance than the inner edge of the drum. Consequently, the outer edge stretches the mat in an effort to turn the radius at the same speed as the inner edge.

If the only available compactor is a conventional, high-production model, then a unique rolling pattern must be used to avoid distorting the mat.

The operator should work toward the radius along one edge of the mat. Roll forward (1) into the radius, stopping at an angle close to the outer edge of the radius. Reverse back along the same path.

Move toward the center of the mat (2) overlapping the first pass slightly and roll forward into the radius, again stopping at an angle close to the outer edge. Reverse back along the same path.

Repeat this pattern as many times as necessary (3,4,5) to cover the width of the mat.

Reposition the compactor at the start of the radius so the compactor is at an angle to the passes already completed in the radius area. Roll forward and backward to finish the remainder of the radius area.

Then, reposition the compactor to begin straight passes going forward out of the middle of the radius.

## BENDS OR JUNCTIONS

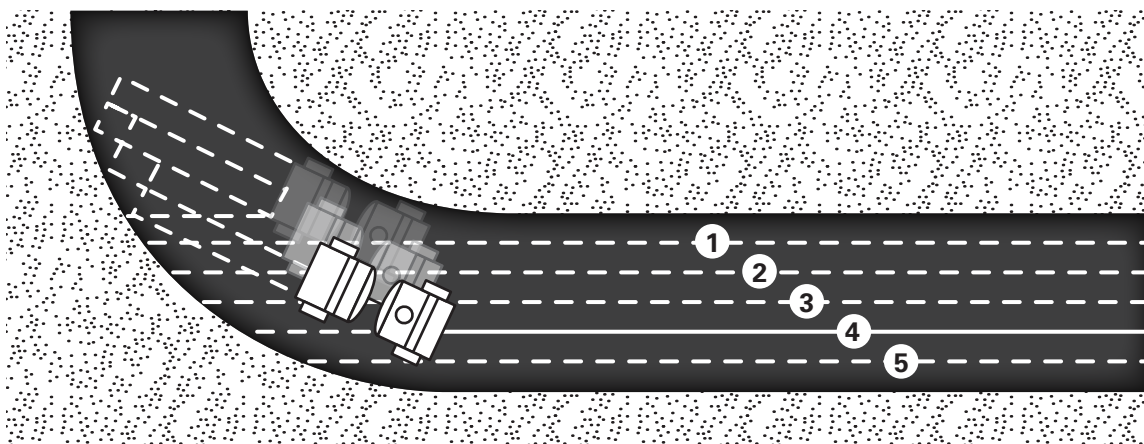

*Rolling pattern for radius compaction using conventional steel drum compactor.*



*Utility-size compactors make it easier to compact around obstacles without tearing the fresh asphalt.*



*Split drum compactors can perform radius compaction without tearing fresh asphalt.*

On low-production jobs, another solution is using a utility-size compactor for radius compaction.

Utility class compactors with drums less than 1 m (40") wide can turn sharper on a fresh mat without tearing the mat. For cul-de-sacs, city streets, parking lots and other lower-production projects, a utility-size compactor provides versatility and usually enough productive capability to keep up with the paving process.

Another option in some areas is the split drum asphalt compactor. These units have unique propel systems which synchronize steering and drum speed to move one half of the drum at a faster

speed than the other half. When the steering wheel is turned, the outer half of the drum (along the larger arc of the radius) speeds up in comparison to the inner drum half (along the smaller arc of the radius). The more the steering wheel is turned, the greater is the difference in the speeds of the two drum halves. Thus, the drum halves cover different distances but in the same time frame. The fresh mat reaches target density without distortion.

If split drum models are distributed in your area and you work on projects with radius compaction, Caterpillar recommends including one or more split drum models in your compactor fleet.

**User Tip:** *This radius pattern increases the number of passes and requires carefully positioning the compactor. All this movement takes time and means that the paver is likely to move so far ahead that the mat will lose too much heat before the initial phase compactor can catch up. Caterpillar recommends that the paver make several short stops, three minutes for example, as it completes paving the radius. Short paver stops will not seriously affect mat temperature and will enable the initial compactor to keep pace with the paver.*

### [ INCONSISTENT DENSITY ]

Many public works departments now require not only high asphalt layer density, but also consistent density. There may be pay factors associated with standard deviation derived from multiple core measurements or percent within engineering limits derived from multiple core measurements.

One of the responsibilities of the paving crew is to present a uniform asphalt layer to the initial phase compactor. Behind the paver, to the extent possible, the mat should be:

- Uniform screed laid density
- Uniform thickness
- Uniform temperature



*Consistent operation of the paver and the initial phase compactor are key to achieving consistent density.*

**User Tip:** Caterpillar recommends periodic checks of screed-laid density across the width of the mat and checks of surface temperature across the width of the mat. The public works department may have written specifications for uniformity of screed-laid density and mat surface temperature. As a rule, the density of the mat should vary by no more than  $60 \text{ kg/m}^3$  ( $5 \text{ lb/ft}^3$ ) across the width of the mat. Surface temperature should not vary by more than  $10^\circ \text{ C}$  ( $23^\circ \text{ F}$ ) across the width of the mat.

Each compactor in the compaction process, especially the initial phase compactor, must also be consistent in the approach to achieving consistently high density. Each compactor must work in such a manner that creates:

- Uniform pattern
- Uniform compaction force
- Uniform working speed
- Uniform temperature zone



*Maintaining a consistent pattern and consistent density behind the paver can be challenging.*

Some operators have difficulty repeating the same pattern as they follow the paver. They do not always hit each portion of the mat the same number of times. Therefore, density checks made by the quality control technician will vary. When this happens, the quality control technician or supervisor must work with the compactor operator to define the pattern and make sure that the pattern is being repeated.

Also, verify that the paving speed has not been changed. Often changes in paving speed are not communicated to the compaction team and the quality control team. A rolling pattern that has been

working well is suddenly causing the compactor to fall behind the paver and to be working in a lower temperature zone, for example. The compactor falls behind because the paving speed has been increased. And, the operator tries to alter the rolling pattern to stay close to the paver.

Never change paving speed without doing two things. First, communicate the speed change to the compaction team. Second, verify that the initial phase compactor can keep up if the speed is being increased.







*New technology helps operators maintain consistency of rolling patterns.*

Options are available for asphalt compactors to help operators maintain uniform rolling patterns. Screens in the operator's compartment can be programmed to show the operator where the roller is located on the mat and how much of the pattern has been completed.

Global positioning systems provide very accurate maps of rolling patterns. The control can be

programmed with the required number of passes. Then, the screen will display different colors as the passes are completed. The operator no longer has to guess at the end of the pattern for reversing. And, there is less chance that the operator will miss any of the areas in the pattern because the screen provides immediate feedback for quick corrective action.

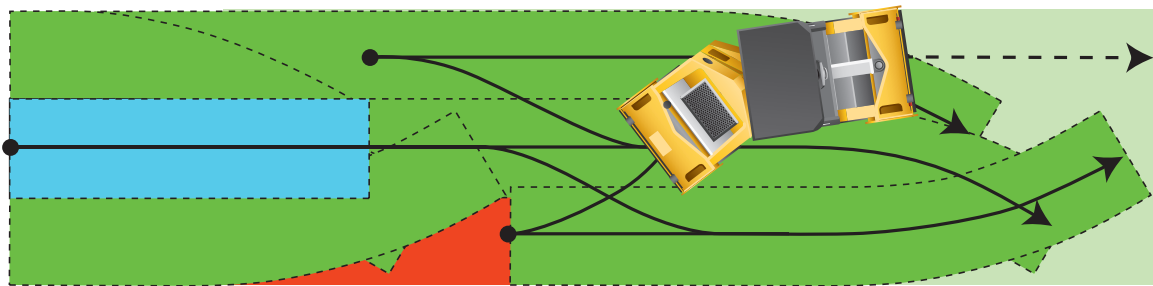

*Example of a pass-counting map.*



*Infrared sensors send temperature data to the display in the operator's compartment.*

Infrared temperature sensors are another option for some asphalt compactors. On Cat models, sensors are installed on the front and rear of the machine. The sensors are continually cleaned by compressed air that keeps dust, fumes and moisture away from the sensor lenses. The temperature systems are accurate and provide constant, visual reference at the operator's station display. Not only does the operator know where the machine is located in relation to the defined rolling pattern, the operator knows where the machine is located relative to the desired temperature zone.

Large temperature variations are caused by long paver stops. The portion of the mat under the screed remains hot because it is confined. The portion of the mat just behind the screed loses heat because it is exposed to the elements.

Heat loss depends on mat thickness, air temperature and wind speed. If the mat temperature varies by more than 15° C (30° F), there is likely to be significant density variation. To help promote uniform density, limit paver stops to no more than five minutes.



*Temperature variation caused by 10-minute paver stop. Screed imprint seen in infrared image is not visible in digital image.*

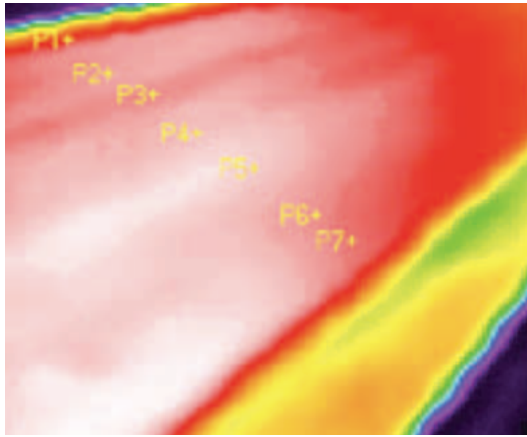

*Temperature variation caused by thin mat on the shoulder side.*

In some instances, mat thickness varies across the width of the mat. The thinner portion will lose heat at a faster rate than the thicker portion. In the example shown above, the shoulder was higher than the driving lane in this area of the project. The mat laid over the driving lane was the specified 50 mm (2"). The mat thickness diminished to around 25 mm (1") over the shoulder. The density of the mat varied significantly due to temperature variation and also due to the thin mat having a low ratio of

layer thickness to aggregate size. In this instance, all density checks taken in the shoulder failed to meet the minimum requirement, while all density checks taken in the driving lane passed the density requirement.

There is always a reason why density is variable. If you are troubleshooting density variability, look for variability in the paving process, mat temperature, rolling patterns, and rolling speed.

**User Tip:** *Temperature sensing and display are especially important when compacting mixes that have a tender zone. The operator can use the temperature display to verify that the initial compactor is staying ahead of the tender zone or that the intermediate compactor is staying behind the tender zone.*

**Summary:** *Compaction issues can be caused by a range of factors. Poor drum system maintenance, lack of planning, incorrect equipment selection, and inadequate operator training are just some of the factors that can cause problems during the compaction process. Certain mixes are more difficult to lay down and compact than others. In those cases, experimentation on the job may be the only solution when a mix is being used for the first time. What a crew learns from working on one project should be remembered and put to use on others when similar issues are encountered.*

## GLOSSARY OF TERMS

**- A -**

<b>Aggregate</b>	Aggregate refers to the type or types of stones used in the manufacture of bituminous paving material.
<b>Air Voids</b>	Air voids are pockets of air trapped within an asphalt layer that has been laid down by a paving screed.
<b>Ambient Conditions</b>	Ambient conditions include air temperature, wind speed and direction, and cloud cover. Ambient conditions affect heat loss in the asphalt layer prior to final compaction.
<b>Amplitude</b>	Amplitude is the distance the drum moves into the asphalt layer. Amplitude is a critical measurement of impact force generated by a vibratory steel drum roller.
<b>low</b>	Drum movement between 0.25 – 0.5 mm (0.01 – 0.02")
<b>mid</b>	Drum movement between 0.5 – 0.75 mm (0.02 – 0.03")
<b>high</b>	Drum movement over 0.75 mm (0.03")
<b>Asphalt</b>	Asphalt is the generic term used to describe bituminous paving material, also called hot mix asphalt or sometimes warm mix asphalt.
<b>Asphalt Cement</b>	Asphalt cement is the oil used in the manufacture of bituminous paving material.
<b>Asphalt Concrete</b>	Asphalt concrete is another phrase used to describe bituminous paving material.
<b>Asphalt Pick-up</b>	Asphalt pick-up is the term used to describe hot asphalt sticking to the steel drum or to a rubber tire.
<b>Axle Load</b>	Axle load is the total weight applied by a steel drum or rubber tire.

**- B -**

<b>Ballast</b>	Ballast is weight added to or removed from a compactor in order to change the static force exerted by the compactor.
<b>Base Layer</b>	The base layer is usually the first layer of bituminous material in a roadway structure. The base layer usually consists of large aggregates and is laid 75 mm (3") thick or thicker.
<b>Binder Layer</b>	The binder layer is bituminous material laid on top of the base layer. The binder layer consists of medium size aggregates and is usually 50 - 100 mm (2 - 4") thick.
<b>Bitumen</b>	Bitumen is a black, sticky mixture of hydrocarbons found naturally or obtained as a residue from petroleum distillation. Bitumen is also called asphalt cement.
<b>Bituminous Material</b>	Bituminous material is the combination of aggregates, asphalt cement, and certain additives. Bituminous material is manufactured at asphalt plants.
<b>hot mix</b>	Bituminous material produced in an asphalt plant at temperatures between 149 – 177° C (300 – 350° F).
<b>warm mix</b>	Bituminous material produced in an asphalt plant at temperatures up to 38° C (100° F) lower than hot mix.
<b>Bouncing Drum</b>	Drum bouncing occurs when the asphalt layer cannot accept the amount of force being applied by a vibratory compactor. Drum bouncing is also referred to as de-coupling.

**Breakdown Phase** In some areas, the initial phase of compaction is referred to as the breakdown phase. The breakdown phase should accomplish the majority of the final target density.

## - C -

**Centrifugal Force** Centrifugal force is an engineering calculation obtained by multiplying the mass of the eccentric weight by the radius of the weight rotation by the square of the speed of rotation (frequency). Centrifugal force has no direction relationship to compaction energy.

**Cessation Temperature** The cessation temperature is that temperature at which further attempts to gain density are likely to be unsuccessful. The cessation temperature varies by mix design, but as a rule, the cessation temperature is around 85° C (185° F).

**Compaction** Compaction is the mechanical process of reducing air voids and developing load-bearing strength in a layer of bituminous material by moving aggregates into interlocking contact.

**Confined Edge** A confined edge is an edge of an asphalt layer that is confined by a previously laid layer. The intersection of the two layers is called a longitudinal joint.

**Cooling Curve** A cooling curve is a graphical time chart of the heat loss in an asphalt layer based on layer thickness, type of material and ambient conditions.

**Core Sample** A core sample is a small portion of the cooled, compacted asphalt layer that is removed by quality control personnel and taken to a laboratory for quality analysis.

**Core Temperature** Core temperature refers to the temperature measured by a probe inserted into the center of an asphalt layer. Core temperature is always higher than surface temperature and is the true indicator of an asphalt layer's workability.

## - D -

**Dense-Graded Mix** Dense-graded mixes are produced with a variety of aggregate sizes, asphalt cement and fines. The larger aggregates are surrounded by a mastic of fines and asphalt cement.

**Density** Density is the weight of a given volume of material, normally expressed as kilograms per cubic meter or pounds per cubic foot.

**Density Testing Gauge** Density testing gauges are used to test density on the project while the bituminous material is still hot enough to make adjustments. The quality control technician calibrates and uses the gauge on the project.

**Density, Theoretical Maximum** Theoretical maximum density is the weight of a given volume of bituminous material compacted in a repeatable, controlled manner in a laboratory environment.

**Design Ratio** Design ratio is defined as the ratio between the thickness of the asphalt layer and the largest aggregate in the layer. Most public works departments require at least a 3:1 ratio of layer thickness to aggregate size. The higher the design ratio, the easier is the compaction process.

## - E -

**Eccentric Weight** The eccentric weight is an off-center mass inside the drum of a vibratory compactor. Rapid rotation of the eccentric weight creates forces that cause the drum to vibrate and to move into the asphalt layer.

**Echelon Compaction** Echelon compaction is a rolling pattern using two or more compactors for one phase of compaction.

- Edge Cutter** An edge cutter is an attachment that can be installed on a compactor drum. An edge cutter trims the unconfined edge of an asphalt layer to provide a vertical face and straight line for joint matching.
- Efficiency Factor** An efficiency factor should be used when calculating the working speed of a compactor to compensate for water refill stops and non-vibratory reversing. The normal efficiency factor for compactors is 75% to 85%.
- End Gate** A paving screed has left and right end gates that confine the asphalt layer to the desired width. The bottom of an end gate has a metal strip called a ski. When the end gate is down, the ski floats on the grade and the edge of the asphalt layer is vertical for best joint matching.

**- F -**

- Finish Phase** The finish phase of compaction is the final phase and has the goal of cleaning up any marks left in the surface by the previous compactors. Small gains in density may result from the finish phase.
- Frequency** Frequency is the number of times that the drum hits the asphalt layer and is rated in vibrations per minute. Frequency can also be defined as the rotational speed of the eccentric weight shaft inside the drum.
  - low** 40 – 46.7 HZ (2400 - 2800 vibrations per minute)
  - medium** 46.7 – 56.7 Hz (2800 - 3400 vibrations per minute)
  - high** Above 56.7 Hz (3400 vibrations per minute)

**- G -**

- Gap-Graded Mix** Gap-graded mixes use an aggregate gradation with particles ranging from large to fine with some intermediate sizes missing. Gap-graded mixes are permeable with lots of stone-on-stone contact.

**- I -**

- Impact** Impact is a dynamic compaction force. Impact occurs when the steel drum of a vibratory compactor moves into the asphalt layer.
- Impact Marks** Impact marks are visible lines in the surface of the asphalt layer. Impact marks are caused by applying too much force (amplitude and weight) to the asphalt layer.
- Impact Spacing** Impact spacing is the relationship between the frequency of a vibratory compactor and the working speed of a vibratory compactor. Impact spacing is the number of times per meter or foot that the drum moves into the mat.
- Infrared Camera** An infrared camera produces an image of the temperature of the surface of the asphalt layer. The image usually encompasses the width of the mat for a distance of no more than 9 m (30').
- Infrared Scanner** An infrared scanner is a hand-held device that measures and displays the temperature of a point at the surface of an asphalt layer.
- Initial Phase Compaction** The initial phase of compaction occurs immediately behind the paver where the asphalt layer is the hottest. The initial phase should get the majority of the target final density.
- Intermediate Phase Compaction** The intermediate phase of compaction occurs immediately after the initial phase in a temperature zone where the asphalt layer is still hot enough to allow for gains in density. The intermediate phase should achieve the final density target.

<b>Internal Friction</b>	Internal friction is the resistance to movement by the aggregate in an asphalt layer. The shape of the aggregate determines the amount of internal friction.
<b>- L -</b>	
<b>Leveling Layer</b>	A leveling layer is a thin layer of bituminous material laid on a milled surface for the dual purpose of restoring profile and improving smoothness.
<b>Longitudinal Joint</b>	A longitudinal joint is the intersection of two asphalt layers along the edges that are parallel to the direction of paving.
<b>hot/cold joint</b>	A hot/cold longitudinal joint is created by laying down a hot asphalt layer adjacent to a cold, previously compacted asphalt layer.
<b>hot/warm joint</b>	A hot/warm longitudinal joint is created by laying down a hot asphalt layer adjacent to a layer laid down a short time before.
<b>hot/hot joint</b>	A hot/hot longitudinal joint is created by two pavers laying down adjacent mats in echelon.
<b>- M -</b>	
<b>Manipulation</b>	Manipulation is a static force generated when forces exerted into the asphalt layer are not entirely vertical but are sent in all directions. Manipulation, normally associated with pneumatic compactors, helps seal the surface of the layer.
<b>- N -</b>	
<b>Notched Wedge Joint</b>	A notched wedge joint is created by installing a joint shaper at the end of the paving screed. Notched wedge joints are often specified to avoid creating a large vertical unconfined edge that may be open to traffic.
<b>- O -</b>	
<b>Offset Drums</b>	On some articulated dual drum compactors, the drums can be offset to increase the width of coverage beyond the standard drum width.
<b>Open-Graded Mix</b>	Open-graded bituminous material is made up of only a few aggregate sizes with intermediate sizes absent. Modified asphalt cement is usually part of the design. There is a lot of stone-on-stone contact.
<b>Overhang</b>	Overhang refers to the amount of drum that extends past the edge of the asphalt layer.
<b>Overlap</b>	Overlap refers to the amount of drum that extends onto the previously completed, adjacent pass.
<b>- P -</b>	
<b>Pass</b>	A pass is one movement of the compactor in one direction from the starting point to the point where the rolling pattern ends or a new rolling pattern begins. In some locations, a pass is defined as movement forward and backward in the same coverage area.
<b>Pass Mapping</b>	Pass mapping through the use of a Global Positioning Satellite is an option on some compactors. A display at the operator's station shows the operator the machine's current position on the project and whether the compactor has successfully completed the designated rolling pattern.
<b>Perpetual Pavement</b>	Perpetual pavement is a term used to describe a full-depth asphalt structure designed to withstand an almost infinite number of axle loads without structural deterioration.

**Polymer Modified Asphalt** A polymer is a synthetic compound in the form of a string of similar linked molecules. Polymers are added to asphalt cement to enhance layer strength at high temperature and layer elasticity at low temperature. Polymer-modified asphalt cement has high viscosity.

**Profile** Profile is the cross section of a roadway structure, most specifically the slope of the surface of the roadway for drainage.

**- Q -**

**Quality Analysis** Quality analysis is testing, measuring and analyzing bituminous material and other specified aspects of a project in a laboratory or other controlled environment.

**Quality Control** Quality control is testing, measuring and analyzing bituminous material and other specified aspects of a project at the jobsite while work is in progress.

**- R -**

**Release Agent** A release agent is a liquid that helps prevent bituminous material from sticking to steel or rubber surfaces. Petroleum distillates, like diesel fuel, are prohibited in most locations because of their harmful effects on bituminous material. There are a variety of bio-degradable release agents.

**Resonant Frequency** The resonant frequency is that combination of vibratory system frequency, amplitude, working speed, and asphalt layer stiffness that causes the drum to bounce (oscillate) away from the surface of the mat. A vibratory compactor should operate close to, but not at, resonant frequency.

**Rolling Pattern** A rolling pattern consists of the number and order of passes with overlaps and overhangs that are required by the compactor to cover the width and length of its assigned area while matching the effective speed of the paving process.

**- S -**

**Segregation** Segregation, in relation to asphalt paving, refers to the tendency of larger aggregates in a bituminous mixture to separate from the smaller particles and form pockets or stripes of large aggregates within the layer.

**Specification, End Result** An end result specification is a written quality control / quality analysis series of measurement targets for items like ride quality, density and asphalt mix conformance.

**Specification, Method** A method specification describes either the type of equipment or the technique(s) that must be used on a project.

**Split Drum** A split drum asphalt compactor has drums that are split in the middle. Steering and propel speeds are synchronized to allow one half of the drum to turn faster or slower than the other half of the drum. Split drums are beneficial when compacting tight radius applications like cul-de-sacs.

**Starter Boards** Starter boards are wood or metal strips placed under the paver screed before the screed is lowered to the starting point. Starter boards should be the same thickness as the compaction rate of the asphalt layer being laid down.

**Static Pressure** Static pressure is axle load divided by the area of the drum or rubber tire that contacts the surface of the asphalt layer. Static pressure is expressed in kilopascals or pounds per square inch.

**Static Linear Load** Static linear load is calculated by dividing axle load by the width of the drum. Static linear load is expressed as kilograms per centimeter or pounds per inch.

**Stone Matrix Asphalt** Stone matrix asphalt is composed almost entirely of large aggregates, fines and modified asphalt cement. There is stone-on-stone contact, but the stones are coated with a thick mastic of fines and viscous asphalt cement.



## - T -

<b>Tack</b>	Tack is an emulsion consisting of paving grade oil, water and an emulsifying agent. Tack is applied to surfaces prior to paving to help improve the bond between layers.
<b>Tamping Screed</b>	A tamping screed uses one or more tamper bars to deliver extra compaction energy to the asphalt layer and produce higher density in the asphalt layer prior to the compaction process. Tamping screeds typically also use vibration to help tighten surface texture.
<b>Temperature Mapping</b>	Temperature mapping is an option on some asphalt compactors. Infrared temperature sensors send data to a display at the operator's station. The display tells the operator surface temperatures within the rolling pattern.
<b>Tender Zone</b>	The tender zone is that temperature range in which the asphalt layer becomes tender and moves away from the drum rather than consolidating under the drum.
<b>Test Strip</b>	A test strip is used to confirm that the proposed rolling pattern and equipment are adequate to achieve target density and match the paving production. The test strip may be part of the project or may be a separate element.
<b>Transverse Joint</b>	A transverse joint is the perpendicular intersection of two layers of asphalt. Often a transverse joint is the resumption of paving from a cold, compacted layer. A transverse joint is also called a butt joint.

## - U -

<b>Unconfined Edge</b>	An unconfined edge is the edge of an asphalt layer that is open and not bound by an adjacent layer or gutter.
<b>Utility Compactor</b>	Utility compactors have drum widths less than 1 m (40") wide and are typically used on low production projects or to supplement larger compactors on projects where there is a need for more maneuverable equipment.

## - V -

<b>Vibration</b>	Vibration is a dynamic compaction force. Vibration helps the aggregates in an asphalt layer to re-orient and move into closer contact. Vibration occurs when the eccentric weight inside the drum begins to rotate rapidly.
<b>Vibratory Screed</b>	A vibratory screed delivers vibratory force to the asphalt layer as the layer passes under the screed. Screed vibration increases the density of the asphalt layer by a small amount and also helps tighten the surface texture.
<b>Viscosity</b>	Viscosity refers to the flow rate of a liquid at a given temperature. The viscosity of asphalt cement used in bituminous material is affected by temperature and by the additives mixed with the asphalt cement. For compaction purposes, the higher the viscosity of the asphalt cement, the more difficult is the compaction process.

## - W -

<b>Water Distribution Mat</b>	Water distribution mats help spread water evenly to the surface of a compactor's steel drums.
<b>Water Spray Nozzle</b>	Water spray nozzles are located on spray bars over the compactor's steel drums. Spray nozzles apply a fan-shaped spray pattern to the drum surface to help prevent hot asphalt from sticking to the drum.
<b>Wear Layer</b>	The wear layer, or the friction or surface layer, is the final layer in the roadway structure. Usually the thinnest layer, it is designed to be the stiffest layer.
<b>Wedge Joint</b>	A wedge joint is a tapered edge that eliminates a vertical face on the unconfined edge that may be open to traffic. A wedge joint is formed by installing a shaper at the end of a paver screed.

**Wheel Covers**

Wheel covers are an option for pneumatic compactors. Wheel covers wrap around the front and rear axles to help the rubber tires maintain heat and minimize asphalt pick-up.

- Y -

**Yield**

Yield refers to the linear distance that a given amount of bituminous material will pave at a certain depth and width.











C054B CAT

**CATERPILLAR®**