



315 GC

Hydraulic Excavator

Technical Specifications

Configurations and features may vary by region. Please consult your Cat® dealer for availability in your area.

Table of Contents

Specifications	2
Engine	2
Swing Mechanism	2
Weights	2
Track	2
Drive	2
Hydraulic System	2
Service Refill Capacities	2
Standards	2
Sound Performance	3
Air Conditioning System	3
Operating Weights and Ground Pressures	3
Major Component Weights	4
Dimensions	5
Working Ranges and Forces	7
Blade Working Ranges	8
Reach Boom Lift Capacities	9
Reach Boom Lift Capacities – Blade Up	15
Bucket Specifications and Compatibility:	
Europe	21
Australia and New Zealand	23
Attachments Offering Guide:	
Europe	24
Australia and New Zealand	26
Standard and Optional Equipment	27
Dealer Installed Kits and Attachments	29
315 GC Environmental Declaration	30

315 GC Hydraulic Excavator Specifications

Engine

Engine Model	Cat® C3.6	
Net Power		
ISO 9249	73.3 kW	98 hp
ISO 9249 (DIN)	100 hp (metric)	
Engine Power		
ISO 14396	74.4 kW	100 hp
ISO 14396 (DIN)	101 hp (metric)	
Bore	98 mm	4 in
Stroke	120 mm	5 in
Displacement	3.6 L	220 in ³
Biodiesel Capability	Up to B20 ⁽¹⁾	

- Meets U.S. EPA Tier 4 Final, EU Stage V, and Japan 2014 emission standards.
- No engine power derating required below 3000 m (9,840 ft) altitude.
- Advertised power is tested per the specified standard in effect at the time of manufacture.
- Net power advertised is the power available at the flywheel when the engine is equipped with fan, air intake system, exhaust system and alternator.
- Engine speed at 2,400 rpm.

⁽¹⁾Cat diesel engines are required to use ULSD (ultra-low sulfur diesel fuel with 15 ppm of sulfur or less) or ULSD blended with the following lower-carbon intensity fuels** up to:

- ✓ 20% biodiesel FAME (fatty acid methyl ester)*
- ✓ 100% renewable diesel, HVO (hydrotreated vegetable oil) and GTL (gas-to-liquid) fuels

Refer to guidelines for successful application. Please consult your Cat dealer or “Caterpillar Machine Fluids Recommendations” (SEBU6250) for details.

*Engines with no aftertreatment devices can use higher blends, up to 100% biodiesel (for use of blends higher than 20% biodiesel, consult your Cat dealer).

**Tailpipe greenhouse gas emissions from lower-carbon intensity fuels are essentially the same as traditional fuels.

Swing Mechanism

Swing Speed	11.5 rpm	
Maximum Swing Torque	35 kN·m	25,815 lbf·ft

Weights

Operating Weight	15 400 kg	34,000 lb
------------------	-----------	-----------

- Long undercarriage, Reach boom, R3.0 (9'10") stick, GD 0.68 m³ (0.89 yd³) bucket, 700 mm (28") triple grouser shoes and 3.83 mt (8,440 lb) counterweight.

Operating Weight	14 900 kg	32,800 lb
------------------	-----------	-----------

- Long undercarriage, Reach boom, R2.5 (8'2") stick, GD 0.53 m² (0.69 yd³) bucket, 500 mm (20") triple grouser shoes and 3.83 mt (8,440 lb).

Track

Optional Track Shoes Width	500 mm	20 in
Optional Track Shoes Width	600 mm	24 in
Optional Track Shoes Width	700 mm	28 in
Optional Track Shoes Width	770 mm	30 in
Number of Shoes (each side)	46	
Number of Track Rollers (each side)	7	
Number of Carrier Rollers (each side)	1	

Drive

Gradeability	35°/70%	
Maximum Travel Speed	5.4 km/h	3.4 mph
Maximum Drawbar Pull	117 kN	26,303 lbf

Hydraulic System

Main System – Maximum Flow – Implement	247 L/min	65 gal/min
Maximum Flow – HP Auxiliary Circuit	240 L/min	63 gal/min
Maximum Flow – MP Auxiliary Circuit	60 L/m	16 gal/min
Maximum Pressure – Equipment – Normal	35 000 kPa	5,075 psi
Maximum Pressure – Travel	35 000 kPa	5,075 psi
Maximum Pressure – Swing	26 000 kPa	3,770 psi
Boom Cylinder – Bore	105 mm	4 in
Boom Cylinder – Stroke	1023 mm	40 in
Stick Cylinder – Bore	115 mm	5 in
Stick Cylinder – Stroke	1147 mm	45 in
Bucket Cylinder – Bore	95 mm	4 in
Bucket Cylinder – Stroke	939 mm	37 in

Service Refill Capacities

Fuel Tank Capacity	187 L	49.4 gal
Cooling System	15 L	4.0 gal
Engine Oil	8 L	2.1 gal
Final Drive (each)	3 L	0.8 gal
Hydraulic System (including tank)	85 L	22.5 gal
Hydraulic Tank	72 L	19.0 gal
Diesel Exhaust Fluid (DEF) Tank	21 L	5.5 gal

Standards

Brakes	ISO 10265:2008
Cab/Rollover Protective Structure (ROPS)	ISO 12117-2:2008
Cab/Operator Protective Guards (OPG) (optional)	ISO 10262:1998 Level II

315 GC Hydraulic Excavator Specifications

Sound Performance

ISO 6395:2008 (external) 101 dB(A)

ISO 6396:2008 (inside cab) 71 dB(A)

- Hearing protection may be needed when operating with an open operator station and cab (when not properly maintained or doors/windows open) for extended periods or in a noisy environment.

Air Conditioning System

The air conditioning system on this machine contains the fluorinated greenhouse gas refrigerant R134a (Global Warming Potential = 1430). The system contains 0.8 kg of refrigerant which has a CO₂ equivalent of 1.144 metric tonnes.

Operating Weights and Ground Pressures

Base Machine Configurations	500 mm (20") Triple Grouser Shoes		500 mm (20") Triple Grouser Shoes with Rubber Pad		500 mm (20") Rubber Shoes	
	Weight	Ground Pressure	Weight	Ground Pressure	Weight	Ground Pressure
	kg (lb)	kPa (psi)	kg (lb)	kPa (psi)	kg (lb)	kPa (psi)
Base Frame with Track Rollers and Carrier Rollers						
Base Machine with 3.83 mt (8,440 lb) Counterweight and Long Undercarriage						
Reach Boom + R2.5 (8'2") Stick + 0.68 m ³ (0.89 yd ³) GD Bucket	14 900 (32,800)	44.4 (6.4)	15 400 (33,900)	45.9 (6.7)	15 000 (33,100)	37.3 (5.4)
Reach Boom + R3.0 (9'10") Stick + 0.68 m ³ (0.89 yd ³) GD Bucket	15 000 (33,100)	44.7 (6.5)	15 400 (33,900)	15.8 (6.6)	15 100 (33,300)	37.5 (5.4)
Reach Boom + R2.5 (8'2") Stick + 0.68 m ³ (0.89 yd ³) GD Bucket + Blade	15 600 (34,400)	46.5 (6.7)	16 000 (35,300)	47.8 (6.9)	15 700 (34,600)	39.0 (5.7)
Reach Boom + R3.0 (9'10") Stick + 0.68 m ³ (0.89 yd ³) GD Bucket + Blade	15 700 (34,600)	46.8 (6.8)	16 200 (35,700)	48.3 (7.0)	15 800 (34,800)	39.3 (5.7)

All operating weights include a 90% fuel tank with 75 kg (165 lb) operator.

Base Machine Configurations	600 mm (24") Rubber Shoes		600 mm (24") Triple Grouser Shoes		700 mm (28") Triple Grouser Shoes		770 mm (30") Triple Grouser Shoes	
	Weight	Ground Pressure	Weight	Ground Pressure	Weight	Ground Pressure	Weight	Ground Pressure
	kg (lb)	kPa (psi)	kg (lb)	kPa (psi)	kg (lb)	kPa (psi)	kg (lb)	kPa (psi)
Base Frame with Track Rollers and Carrier Rollers								
Base Machine with 3.83 mt (8,440 lb) Counterweight and Long Undercarriage								
Reach Boom + R2.5 (8'2") Stick + 0.68 m ³ (0.89 yd ³) GD Bucket	15 400 (33,800)	38.2 (5.5)	15 200 (33,500)	37.8 (5.5)	15 400 (34,000)	32.8 (4.8)	15 500 (34,300)	30.1 (4.4)
Reach Boom + R3.0 (9'10") Stick + 0.68 m ³ (0.89 yd ³) GD Bucket	15 400 (33,800)	38.2 (5.5)	15 200 (33,500)	37.8 (5.5)	15 400 (34,000)	32.8 (4.8)	15 500 (34,300)	30.1 (4.4)
Reach Boom + R2.5 (8'2") Stick + 0.68 m ³ (0.89 yd ³) GD Bucket + Blade	16 100 (35,400)	39.9 (5.8)	15 900 (35,100)	39.5 (5.7)	16 200 (35,700)	34.5 (5.0)	16 200 (36,000)	31.7 (4.6)
Reach Boom + R3.0 (9'10") Stick + 0.68 m ³ (0.89 yd ³) GD Bucket + Blade	16 200 (35,600)	40.1 (5.8)	16 000 (35,300)	39.8 (5.8)	16 200 (35,700)	34.5 (5.0)	16 300 (36,000)	31.7 (4.6)

All operating weights include a 90% fuel tank with 75 kg (165 lb) operator.

315 GC Hydraulic Excavator Specifications

Major Component Weights

	kg	lb
Base Machine Weight: Base machine (with 3.83 mt [8,440 lb] counterweight, upper frame, long undercarriage – does not include boom, stick, bucket, boom cylinders, stick cylinders, bucket cylinders, tracks, blade, fuel tank, operator).		
With Long Undercarriage	10 770	23,730
With Long Undercarriage (blade compatible)	11 050	24,360
Track Shoes:		
500 mm (20") Triple Grouser Track Shoes	1540	3,390
500 mm (20") Triple Grouser Track Shoes with Rubber Pad	2050	4,520
500 mm (20") Rubber Shoes	1670	3,680
600 mm (24") Triple Grouser Track Shoes	1810	4,000
600 mm (24") Rubber Shoes	1970	4,340
700 mm (28") Triple Grouser Track Shoes with Additional Steps	2020	4,440
770 mm (30") Triple Grouser Track Shoes with Additional Steps	2160	4,800
Two Boom Cylinders	250	550
Weight of 90% Fuel Tank and 75 kg (165 lb) Operator	210	460
Blades (without lines, cylinders, frame modifications):		
2500 mm (8'2") Blade for use with 500 mm (20") Track Shoes	440	960
2600 mm (8'6") Blade for use with 600 mm (24") Track Shoes	490	1,080
2700 mm (8'10") Blade for use with 700 mm (28") Track Shoes	500	1,110
Counterweight:		
3.83 mt (8,440 lb) Counterweight	3830	8,440
Swing Frame	1420	3,140
Undercarriages:		
Base Frame with GD Track Rollers and One Carrier Roller	2620	5,770
Base Frame with GD Track Rollers and One Carrier Roller (blade compatible)	2900	6,390
Boom (including lines, pins, stick cylinder):		
Reach Boom 4.65 m (15'3")	1030	2,270
Sticks (including lines, pins, bucket cylinder, bucket linkage):		
Reach Stick R2.5 m (8'2")	590	1,300
Reach Stick R3.0 m (9'10")	650	1,440
Buckets (without linkage, with tips and side cutters):		
0.53 m ³ (0.69 yd ³) GD Bucket*	420	940
0.53 m ³ (0.69 yd ³) GD Bucket**	460	1,010
0.68 m ³ (0.89 yd ³) GD Bucket	500	1,090
0.76 m ³ (0.99 yd ³) GD Bucket	520	1,150
Quick Coupler:		
Pin Grabber Quick Coupler	210	470

*Europe only

**Australia and New Zealand only

315 GC Hydraulic Excavator Specifications

Dimensions

All dimensions are approximate and may vary depending on bucket selection.

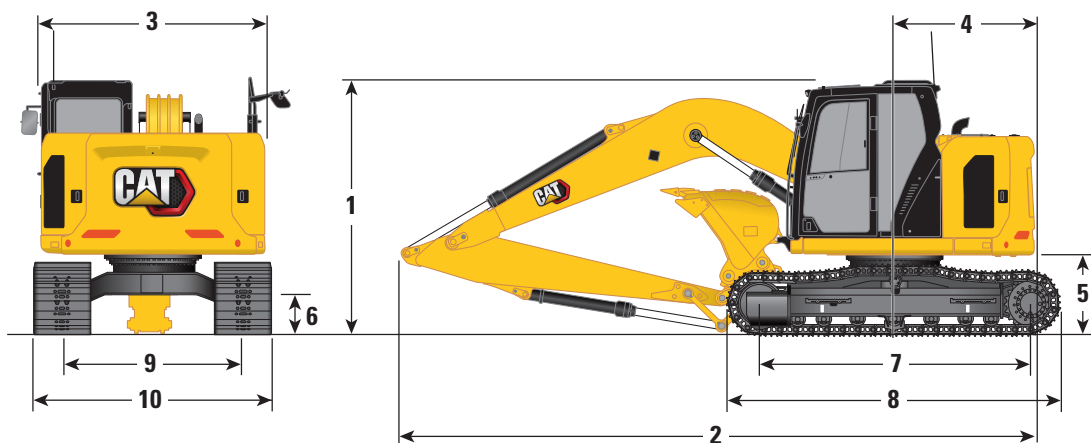

Boom Option	Reach Boom 4.65 m (15'3")			
	Stick Options		Reach Sticks	
	R2.5 (8'2")		R3.0 (9'10")	
1 Machine Height:				
Top of Cab Height	2810 mm	9'3"	2810 mm	9'3"
Top of OPG Height	2960 mm	9'9"	2960 mm	9'9"
Handrail Height	2860 mm	9'5"	2860 mm	9'5"
With Boom/Stick/Bucket Installed (with stick cylinder lines)	2890 mm	9'6"	3180 mm	10'5"
With Boom/Stick Installed (with stick cylinder lines)	2890 mm	9'6"	3180 mm	10'5"
With Boom Installed (with stick cylinder lines)	2410 mm	7'11"	2410 mm	7'11"
Machine Height (with 500 mm [20"] rubber shoes):				
Top of Cab Height	2860 mm	9'5"	2860 mm	9'5"
Top of OPG Height	3010 mm	9'11"	3010 mm	9'11"
Handrail Height	2910 mm	9'7"	2910 mm	9'7"
With Boom/Stick/Bucket Installed (with stick cylinder lines)	2940 mm	9'8"	3230 mm	10'7"
With Boom/Stick Installed (with stick cylinder lines)	2940 mm	9'8"	3230 mm	10'7"
With Boom Installed (with stick cylinder lines)	2460 mm	8'1"	2460 mm	8'1"
2 Machine Length (without blade):				
With Boom/Stick/Bucket Installed (with stick cylinder lines)	7440 mm	24'5"	7530 mm	24'8"
With Boom/Stick Installed (with stick cylinder lines)	7440 mm	24'5"	7530 mm	24'8"
With Boom Installed (with stick cylinder lines)	6640 mm	21'9"	6640 mm	21'9"
Machine Length (with blade, blade rear):				
With Boom/Stick/Bucket Installed (with stick cylinder lines)	8000 mm	26'3"	8090 mm	26'7"
With Boom/Stick Installed (with stick cylinder lines)	8000 mm	26'3"	8090 mm	26'7"
With Boom Installed (with stick cylinder lines)	7200 mm	23'7"	7200 mm	23'7"
Bucket Type	GD		GD	
Bucket Capacity	0.68 m ³	0.89 yd ³	0.68 m ³	0.89 yd ³
Bucket Tip Radius	1240 mm	4'1"	1240 mm	4'1"

315 GC Hydraulic Excavator Specifications

Dimensions

All dimensions are approximate and may vary depending on bucket selection.

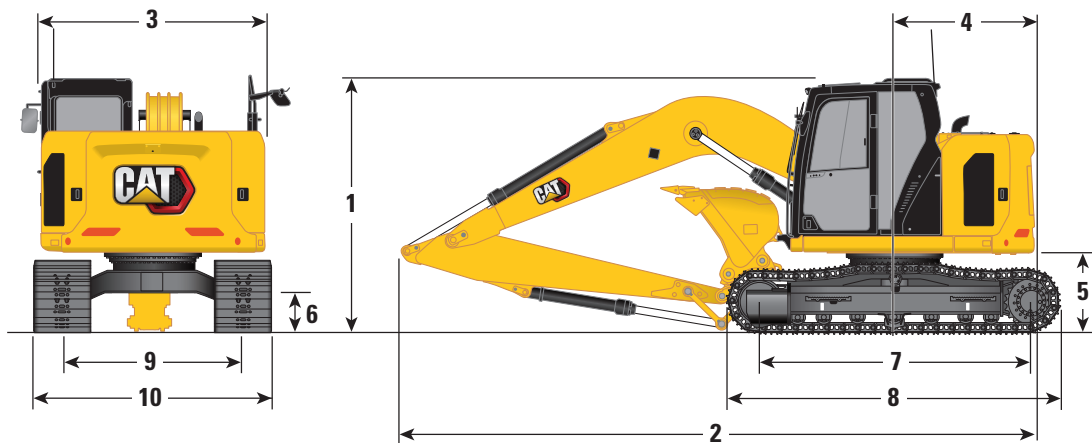

Boom Option

Reach Boom
4.65 m (15'3")

Stick Options

Reach Sticks

R2.5 (8'2")

R3.0 (9'10")

	R2.5 (8'2")		R3.0 (9'10")	
3 Upperframe Width	2480 mm	8'2"	2480 mm	8'2"
4 Tail Swing Radius – 3.83 mt (8,440 lb) Counterweight	1570 mm	5'2"	1570 mm	5'2"
5 Counterweight Clearance	880 mm	2'11"	880 mm	2'11"
6 Ground Clearance	440 mm	1'5"	440 mm	1'5"
7 Length to Center of Rollers	3040 mm	10'0"	3040 mm	10'0"
8 Overall Track Length	3750 mm	12'4"	3750 mm	12'4"
9 Track Gauge	1990 mm	6'6"	1990 mm	6'6"
10 Track Width/Undercarriage Width:				
500 mm (20") Shoes	2490 mm	8'2"	2490 mm	8'2"
600 mm (24") Shoes	2590 mm	8'6"	2590 mm	8'6"
700 mm (28") Shoes (with steps)	2690 mm	8'10"	2690 mm	8'10"
770 mm (30") Shoes (with steps)	2760 mm	9'1"	2760 mm	9'1"
Bucket Type	GD		GD	
Bucket Capacity	0.68 m ³	0.89 yd ³	0.68 m ³	0.89 yd ³
Bucket Tip Radius	1240 mm	4'1"	1240 mm	4'1"

315 GC Hydraulic Excavator Specifications

Working Ranges and Forces

All dimensions are approximate and may vary depending on bucket selection.

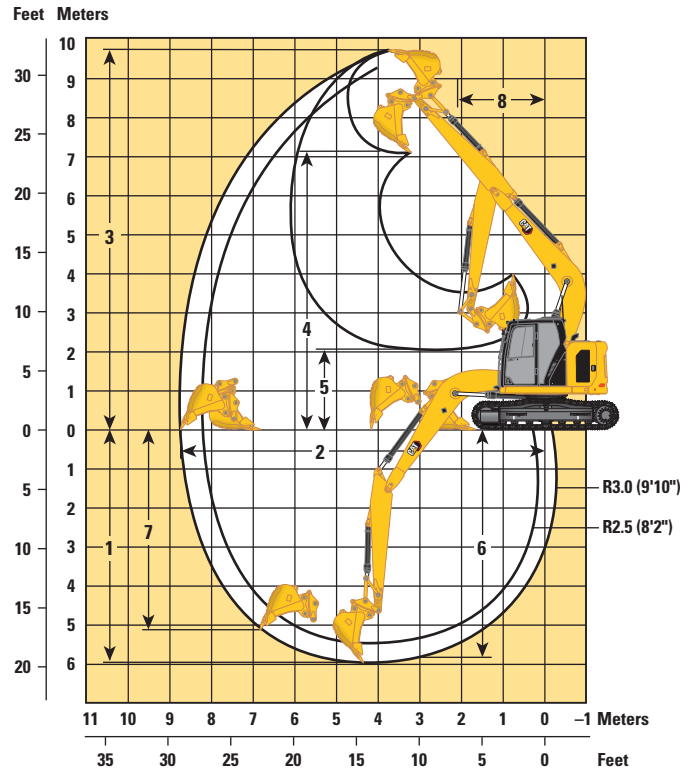

Boom Option

Reach Boom
4.65 m (15'3")

Stick Options

Reach Stick

	R2.5 (8'2")		R3.0 (9'10")	
	GD	GD	GD	GD
1 Maximum Digging Depth	5490 mm	18'0"	5990 mm	19'8"
2 Maximum Reach at Ground Line	8230 mm	27'0"	8690 mm	28'6"
3 Maximum Cutting Height	9330 mm	30'7"	9690 mm	31'9"
4 Maximum Loading Height	6850 mm	22'6"	7220 mm	23'8"
5 Minimum Loading Height	2520 mm	8'3"	2080 mm	6'10"
6 Maximum Depth Cut for 2440 mm (8'0") Level Bottom	5280 mm	17'4"	5810 mm	19'1"
7 Maximum Vertical Wall Digging Depth	4740 mm	15'7"	5180 mm	17'0"
8 Minimum Working Equipment Radius	1980 mm	6'6"	2240 mm	7'4"
Bucket Digging Force (ISO)	98.45 kN	22,130 lbf	98.67 kN	22,180 lbf
Stick Digging Force (ISO)	66.68 kN	14,990 lbf	59.29 kN	13,330 lbf
Bucket Type	GD		GD	
Bucket Capacity	0.68 m ³	0.89 yd ³	0.68 m ³	0.89 yd ³
Bucket Tip Radius	1240 mm	4'1"	1240 mm	4'1"

315 GC Hydraulic Excavator Specifications

Blade Working Ranges

All dimensions are approximate and may vary depending on bucket selection.

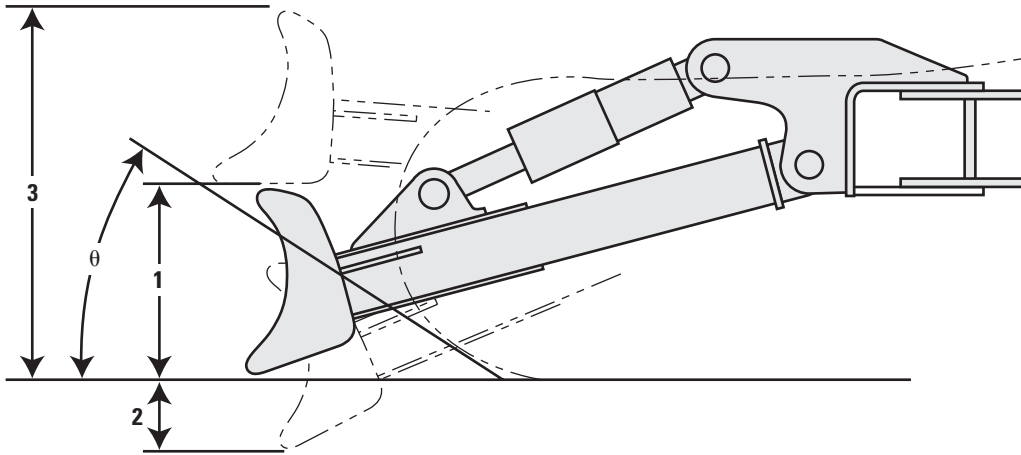

Blade Options	2500 mm (8'2")		2600 mm (8'6")		2700 mm (8'10")	
	1 Blade Height	616 mm	2'0"	616 mm	2'0"	616 mm
2 Maximum Lowering Depth from Ground	550 mm	1'10"	550 mm	1'10"	550 mm	1'10"
3 Maximum Raising Height above Ground	1018 mm	3'4"	1018 mm	3'4"	1018 mm	3'4"
θ Approach Angle	26°		26°		26°	

315 GC Hydraulic Excavator Specifications

Reach Boom Lift Capacities – Counterweight: 3.83 mt (8,440 lb) – without Bucket

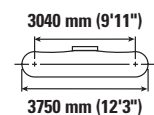
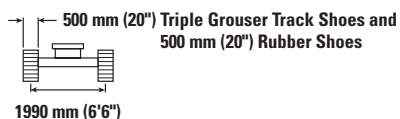
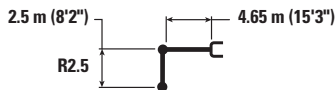

Reach Boom Length	Unit	1500 mm (5'0")		3000 mm (10'0")		4500 mm (15'0")		6000 mm (20'0")		315 GC Hydraulic Excavator		mm ft/in
		Hydraulic	Tipping	Hydraulic	Tipping	Hydraulic	Tipping	Hydraulic	Tipping	Hydraulic	Tipping	
7500 mm 25'0"	kg lb			*4350 *9,200	*4350 *9,200					*3250 *7,450	*3250 *7,450	3710 11'5"
6000 mm 20'0"	kg lb					*4050 *8,750	*4050 *8,750			*2600 *5,800	*2600 *5,800	5490 17'8"
4500 mm 15'0"	kg lb			*4150 *9,050	*4150 *9,050	*4500 *9,750	4050 8,700	*3700 *7,600	2550 5,500	*2450 *5,350	2250 5,050	6460 21'0"
3000 mm 10'0"	kg lb			*7400 *15,850	7400 15,450	*5150 *11,150	3850 8,250	3900 8,350	2500 5,350	*2450 *5,350	1950 4,300	6970 22'9"
1500 mm 5'0"	kg lb			*6800 *16,700	6400 13,800	*5850 *12,600	3600 7,750	3800 8,100	2400 5,150	*2550 *5,600	1850 4,050	7130 23'4"
0 mm 0'0"	kg lb			*6250 *14,500	6100 13,150	5650 12,150	3400 7,350	3700 7,900	2300 4,950	*2850 *6,250	1900 4,150	6960 22'9"
-1500 mm -5'0"	kg lb	*4750 *10,700	*4750 *10,700	*7900 *17,150	6100 13,050	*5550 *11,950	3350 7,200	3650 7,850	2250 4,900	3300 7,300	2100 4,550	6440 21'0"
-3000 mm -10'0"	kg lb	*7300 *15,650	*7300 *15,650	*5750 *12,350	*5750 *12,350	*4150 *8,750	3400 7,300			*2950 *6,400	2650 5,850	5460 17'9"

Reach Boom Lift Capacities – Counterweight: 3.83 mt (8,440 lb) – without Bucket

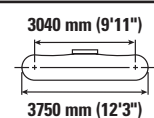
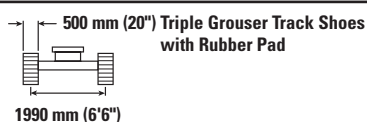
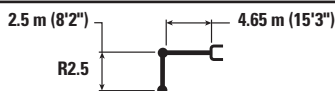

Reach Boom Length	Unit	1500 mm (5'0")		3000 mm (10'0")		4500 mm (15'0")		6000 mm (20'0")		315 GC Hydraulic Excavator		mm ft/in
		Hydraulic	Tipping	Hydraulic	Tipping	Hydraulic	Tipping	Hydraulic	Tipping	Hydraulic	Tipping	
7500 mm 25'0"	kg lb			*4350 *9,200	*4350 *9,200					*3250 *7,450	*3250 *7,450	3710 11'5"
6000 mm 20'0"	kg lb					*4050 *8,750	*4050 *8,750			*2600 *5,800	*2600 *5,800	5490 17'8"
4500 mm 15'0"	kg lb			*4150 *9,050	*4150 *9,050	*4500 *9,750	4200 9,000	*3700 *7,600	2650 5,700	*2450 *5,350	2350 5,200	6460 21'0"
3000 mm 10'0"	kg lb			*7400 *15,850	7400 *15,850	*5150 *11,150	3950 8,550	4050 8,650	2600 5,550	*2450 *5,350	2050 4,500	6970 22'9"
1500 mm 5'0"	kg lb			*6800 *16,700	6650 14,250	*5850 *12,600	3700 8,000	3900 8,400	2500 5,300	*2550 *5,600	1950 4,200	7130 23'4"
0 mm 0'0"	kg lb			*6250 *14,500	*6250 13,600	5850 12,550	3550 7,600	3800 8,200	2400 5,150	*2850 *6,250	1950 4,300	6960 22'9"
-1500 mm -5'0"	kg lb	*4750 *10,700	*4750 *10,700	*7900 *17,150	6300 13,500	*5550 *11,950	3450 7,450	3800 8,150	2350 5,050	*3400 *7,450	2150 4,750	6440 21'0"
-3000 mm -10'0"	kg lb	*7300 *15,650	*7300 *15,650	*5750 *12,350	*5750 *12,350	*4150 *8,750	3500 7,550			*2950 *6,400	2750 6,050	5460 17'9"



ISO 10567:2007



* Indicates that the load is limited by hydraulic lifting capacity rather than tipping load. The above loads are in compliance with hydraulic excavator lift capacity standard ISO 10567:2007.

They do not exceed 87% of hydraulic lifting capacity or 75% of tipping load. Weight of all lifting accessories must be deducted from the above lifting capacities. Lifting capacities are based on the machine standing on a firm, uniform supporting surface. The use of a work tool attachment point to handle/lift objects, could affect the machine lift performance.

Lift capacity stays with ±5% for all available track shoes.

Always refer to the appropriate Operation and Maintenance Manual for specific product information.

315 GC Hydraulic Excavator Specifications

Reach Boom Lift Capacities – Counterweight: 3.83 mt (8,440 lb) – without Bucket

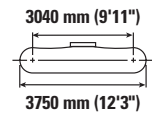
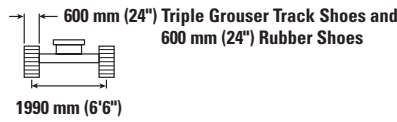
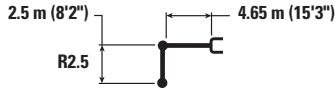

Reach Boom Length	Unit	1500 mm (5'0")		3000 mm (10'0")		4500 mm (15'0")		6000 mm (20'0")		315 GC Hydraulic Excavator		mm ft/in
		Hydraulic	Tipping	Hydraulic	Tipping	Hydraulic	Tipping	Hydraulic	Tipping	Hydraulic	Tipping	
7500 mm 25'0"	kg lb			*4350 *9,200	*4350 *9,200					*3250 *7,450	*3250 *7,450	3710 11'5"
6000 mm 20'0"	kg lb					*4050 *8,750	*4050 *8,750			*2600 *5,800	*2600 *5,800	5490 17'8"
4500 mm 15'0"	kg lb			*4150 *9,050	*4150 *9,050	*4500 *9,750	4100 8,850	*3700 *7,600	2600 5,600	*2450 *5,350	2300 5,100	6460 21'0"
3000 mm 10'0"	kg lb			*7400 *15,850	7300 15,700	*5150 *11,150	3900 8,400	3950 8,500	2550 5,450	*2450 *5,350	2000 4,400	6970 22'9"
1500 mm 5'0"	kg lb			*6800 *16,700	6550 14,050	*5850 *12,600	3650 7,850	3850 8,250	2450 5,250	*2550 *5,600	1900 4,150	7130 23'4"
0 mm 0'0"	kg lb			*6250 *14,500	6250 13,400	5750 12,350	3500 7,450	3750 8,050	2350 5,050	*2850 *6,250	1900 4,200	6960 22'9"
-1500 mm -5'0"	kg lb	*4750 *10,700	*4750 *10,700	*7900 *17,150	6200 13,300	*5550 *11,950	3400 7,300	3700 8,000	2300 5,000	*3400 *7,450	2100 4,650	6440 21'0"
-3000 mm -10'0"	kg lb	*7300 *15,650	*7300 *15,650	*5750 *12,350	*5750 *12,350	*4150 *8,750	3450 7,400			*2950 *6,400	2700 5,950	5460 17'9"

Reach Boom Lift Capacities – Counterweight: 3.83 mt (8,440 lb) – without Bucket

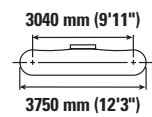
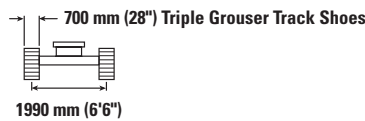
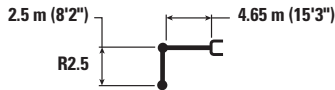

Reach Boom Length	Unit	1500 mm (5'0")		3000 mm (10'0")		4500 mm (15'0")		6000 mm (20'0")		315 GC Hydraulic Excavator		mm ft/in
		Hydraulic	Tipping	Hydraulic	Tipping	Hydraulic	Tipping	Hydraulic	Tipping	Hydraulic	Tipping	
7500 mm 25'0"	kg lb			*4350 *9,200	*4350 *9,200					*3250 *7,450	*3250 *7,450	3710 11'5"
6000 mm 20'0"	kg lb					*4050 *8,750	*4050 *8,750			*2600 *5,800	*2600 *5,800	5490 17'8"
4500 mm 15'0"	kg lb			*4150 *9,050	*4150 *9,050	*4500 *9,750	4150 8,950	*3700 *7,600	2650 5,650	*2450 *5,350	2350 5,200	6460 21'0"
3000 mm 10'0"	kg lb			*7400 *15,850	7350 *15,850	*5150 *11,150	3950 8,500	4000 8,650	2600 5,500	*2450 *5,350	2050 4,500	6970 22'9"
1500 mm 5'0"	kg lb			*6800 *16,700	6600 14,250	*5850 *12,600	3700 7,950	3900 8,400	2450 5,300	*2550 *5,600	1900 4,200	7130 23'4"
0 mm 0'0"	kg lb			*6250 *14,500	*6250 13,550	5850 12,550	3500 7,550	3800 8,200	2400 5,100	*2850 *6,250	1950 4,250	6960 22'9"
-1500 mm -5'0"	kg lb	*4750 *10,700	*4750 *10,700	*7900 *17,150	6300 13,500	*5550 *11,950	3450 7,400	3750 8,100	2350 5,050	*3400 *7,450	2150 4,750	6440 21'0"
-3000 mm -10'0"	kg lb	*7300 *15,650	*7300 *15,650	*5750 *12,350	*5750 *12,350	*4150 *8,750	3500 7,500			*2950 *6,400	2700 6,050	5460 17'9"



ISO 10567:2007



* Indicates that the load is limited by hydraulic lifting capacity rather than tipping load. The above loads are in compliance with hydraulic excavator lift capacity standard ISO 10567:2007.

They do not exceed 87% of hydraulic lifting capacity or 75% of tipping load. Weight of all lifting accessories must be deducted from the above lifting capacities. Lifting capacities are based on the machine standing on a firm, uniform supporting surface. The use of a work tool attachment point to handle/lift objects, could affect the machine lift performance.









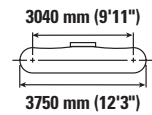
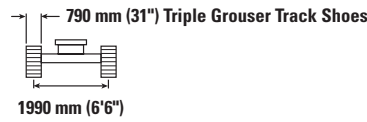
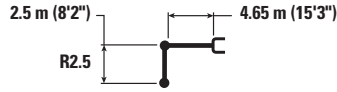



Lift capacity stays with ±5% for all available track shoes.

Always refer to the appropriate Operation and Maintenance Manual for specific product information.

315 GC Hydraulic Excavator Specifications

Reach Boom Lift Capacities – Counterweight: 3.83 mt (8,440 lb) – without Bucket



	1500 mm (5'0")		3000 mm (10'0")		4500 mm (15'0")		6000 mm (20'0")				mm ft/in	
												
7500 mm 25'0"	kg lb		*4350 *9,200	*4350 *9,200					*3250 *7,450	*3250 *7,450	3710 11'5"	
6000 mm 20'0"	kg lb				*4050 *8,750	*4050 *8,750			*2600 *5,800	*2600 *5,800	5490 17'8"	
4500 mm 15'0"	kg lb		*4150 *9,050	*4150 *9,050	*4500 *9,750	4200 9,050	*3700 *7,600	2700 5,700	*2450 *5,350	2350 5,250	6460 21'0"	
3000 mm 10'0"	kg lb		*7400 *15,850	*7400 *15,850	*5150 *11,150	4000 8,600	4050 8,700	2600 5,600	*2450 *5,350	2050 4,500	6970 22'9"	
1500 mm 5'0"	kg lb		*6800 *16,700	6700 14,400	*5850 *12,600	3750 8,050	3950 8,450	2500 5,350	*2550 *5,600	1950 4,250	7130 23'4"	
0 mm 0'0"	kg lb		*6250 *14,500	*6250 13,700	5900 12,650	3550 7,650	3850 8,250	2400 5,150	*2850 *6,250	1950 4,300	6960 22'9"	
-1500 mm -5'0"	kg lb	*4750 *10,700	*4750 *10,700	*7900 *17,150	6350 13,600	*5550 *11,950	3500 7,500	3800 8,200	2400 5,100	*3400 *7,450	2200 4,800	6440 21'0"
-3000 mm -10'0"	kg lb	*7300 *15,650	*7300 *15,650	*5750 *12,350	*5750 *12,350	*4150 *8,750	3550 7,600		*2950 *6,400	2750 6,100	5460 17'9"	



ISO 10567:2007



* Indicates that the load is limited by hydraulic lifting capacity rather than tipping load. The above loads are in compliance with hydraulic excavator lift capacity standard ISO 10567:2007. They do not exceed 87% of hydraulic lifting capacity or 75% of tipping load. Weight of all lifting accessories must be deducted from the above lifting capacities. Lifting capacities are based on the machine standing on a firm, uniform supporting surface. The use of a work tool attachment point to handle/lift objects, could affect the machine lift performance.

Lift capacity stays with ±5% for all available track shoes.

Always refer to the appropriate Operation and Maintenance Manual for specific product information.

315 GC Hydraulic Excavator Specifications

Reach Boom Lift Capacities – Counterweight: 3.83 mt (8,440 lb) – without Bucket

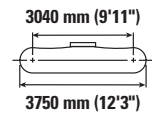
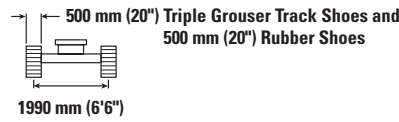
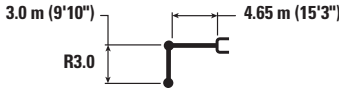

		1500 mm (5'0")		3000 mm (10'0")		4500 mm (15'0")		6000 mm (20'0")		7500 mm (25'0")		mm ft/in		
7500 mm 25'0"	kg lb					*2700	*2700					*2600 *5,850	*2600 *5,850	4540 14'3"
6000 mm 20'0"	kg lb					*3450 *7,550	*3450 *7,550	*2400	*2400			*2200 *4,850	*2200 *4,850	6070 19'8"
4500 mm 15'0"	kg lb					*3650 *7,950	*3650 *7,950	*3450 *7,400	2600 5,600			*2050 *4,500	2000 4,450	6960 22'8"
3000 mm 10'0"	kg lb			*5850 *12,100	*5850 *12,100	*4800 *10,350	3900 8,400	3950 8,400	2500 5,400			*2050 *4,500	1800 3,900	7440 24'4"
1500 mm 5'0"	kg lb			*8750 *18,800	6600 14,150	*5600 *12,050	3650 7,800	3800 8,150	2400 5,150	*2500 1700		*2150 *4,750	1700 3,700	7590 24'10"
0 mm 0'0"	kg lb			*7000 *16,150	6150 13,150	5650 12,150	3400 7,350	3650 7,900	2300 4,900			*2400 *5,250	1700 3,700	7430 24'4"
-1500 mm -5'0"	kg lb	*4300 *9,650	*4300 *9,650	*8500 *18,350	6000 12,900	5550 11,900	3300 7,100	3600 7,750	2250 4,800			*2850 *6,250	1850 4,050	6940 22'8"
-3000 mm -10'0"	kg lb	*7450 *16,700	*7450 *16,700	*6650 *14,350	6050 13,000	*4700 *10,000	3300 7,100	*3000	2250			*2950 *6,400	2250 4,950	6050 19'8"
-4500 mm -15'0"	kg lb			*3450 *7,050	*3450 *7,050							*2050 *4,250	*2050 *4,250	4490 14'4"

Reach Boom Lift Capacities – Counterweight: 3.83 mt (8,440 lb) – without Bucket

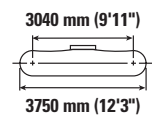
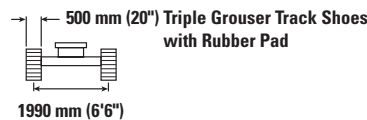
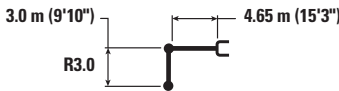

		1500 mm (5'0")		3000 mm (10'0")		4500 mm (15'0")		6000 mm (20'0")		7500 mm (25'0")		mm ft/in		
7500 mm 25'0"	kg lb					*2700	*2700					*2600 *5,850	*2600 *5,850	4540 14'3"
6000 mm 20'0"	kg lb					*3450 *7,550	*3450 *7,550	*2400	*2400			*2200 *4,850	*2200 *4,850	6070 19'8"
4500 mm 15'0"	kg lb					*3650 *7,950	*3650 *7,950	*3450 *7,400	2700 5,750			*2050 *4,500	*2050 *4,500	6960 22'8"
3000 mm 10'0"	kg lb			*5850 *12,100	*5850 *12,100	*4800 *10,350	4050 8,650	*3950 *8,550	2600 5,600			*2050 *4,500	1850 4,050	7440 24'4"
1500 mm 5'0"	kg lb			*8750 *18,800	6800 14,650	*5600 *12,050	3750 8,050	3900 8,400	2500 5,300	*2500 1750		*2150 *4,750	1750 3,800	7590 24'10"
0 mm 0'0"	kg lb			*7000 *16,150	6350 13,600	5850 12,550	3500 7,600	3800 8,150	2350 5,100			*2400 *5,250	1750 3,850	7430 24'4"
-1500 mm -5'0"	kg lb	*4300 *9,650	*4300 *9,650	*8500 *18,350	6250 13,350	5750 12,300	3400 7,350	3750 8,050	2300 4,950			*2850 *6,250	1900 4,200	6940 22'8"
-3000 mm -10'0"	kg lb	*7450 *16,700	*7450 *16,700	*6650 *14,350	6300 13,450	*4700 *10,000	3450 7,350	*3000	2350			*2950 *6,400	2300 5,150	6050 19'8"
-4500 mm -15'0"	kg lb			*3450 *7,050	*3450 *7,050							*2050 *4,250	*2050 *4,250	4490 14'4"



ISO 10567:2007



* Indicates that the load is limited by hydraulic lifting capacity rather than tipping load. The above loads are in compliance with hydraulic excavator lift capacity standard ISO 10567:2007. They do not exceed 87% of hydraulic lifting capacity or 75% of tipping load. Weight of all lifting accessories must be deducted from the above lifting capacities. Lifting capacities are based on the machine standing on a firm, uniform supporting surface. The use of a work tool attachment point to handle/lift objects, could affect the machine lift performance.

Lift capacity stays with ±5% for all available track shoes.

Always refer to the appropriate Operation and Maintenance Manual for specific product information.

315 GC Hydraulic Excavator Specifications

Reach Boom Lift Capacities – Counterweight: 3.83 mt (8,440 lb) – without Bucket

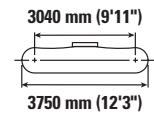
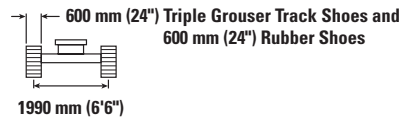
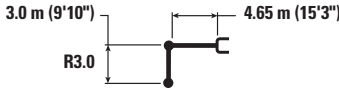

		1500 mm (5'0")		3000 mm (10'0")		4500 mm (15'0")		6000 mm (20'0")		7500 mm (25'0")		mm ft/in		
7500 mm 25'0"	kg lb					*2700	*2700					*2600 *5,850	*2600 *5,850	4540 14'3"
6000 mm 20'0"	kg lb					*3450 *7,550	*3450 *7,550	*2400	*2400			*2200 *4,850	*2200 *4,850	6070 19'8"
4500 mm 15'0"	kg lb					*3650 *7,950	*3650 *7,950	*3450 *7,400	2650 5,650			*2050 *4,500	2050 4,500	6960 22'8"
3000 mm 10'0"	kg lb			*5850 *12,100	*5850 *12,100	*4800 *10,350	3950 8,550	*3950 *8,550	2550 5,500			*2050 *4,500	1800 4,000	7440 24'4"
1500 mm 5'0"	kg lb			*8750 *18,800	6700 14,400	*5600 *12,050	3700 7,950	3850 8,300	2450 5,250	*2500	1750	*2150 *4,750	1700 3,750	7590 24'10"
0 mm 0'0"	kg lb			*7000 *16,150	6250 13,400	5750 12,350	3450 7,450	3750 8,050	2350 5,000			*2400 *5,250	1750 3,800	7430 24'4"
-1500 mm -5'0"	kg lb	*4300 *9,650	*4300 *9,650	*8500 *18,350	6150 13,150	5650 12,100	3350 7,250	3700 7,900	2300 4,900			*2850 *6,250	1900 4,150	6940 22'8"
-3000 mm -10'0"	kg lb	*7450 *16,700	*7450 *16,700	*6650 *14,350	6200 13,250	*4700 *10,000	3350 7,250	3000	2300			*2950 *6,400	2300 5,050	6050 19'8"
-4500 mm -15'0"	kg lb			*3450 *7,050	*3450 *7,050							*2050 *4,250	2050 4,250	4490 14'4"

Reach Boom Lift Capacities – Counterweight: 3.83 mt (8,440 lb) – without Bucket

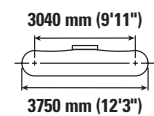
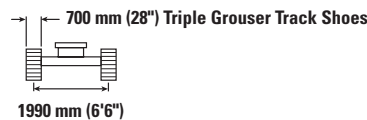
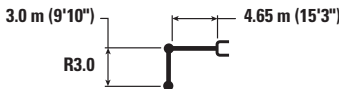

		1500 mm (5'0")		3000 mm (10'0")		4500 mm (15'0")		6000 mm (20'0")		7500 mm (25'0")		mm ft/in		
7500 mm 25'0"	kg lb					*2700	*2700					*2600 *5,850	*2600 *5,850	4540 14'3"
6000 mm 20'0"	kg lb					*3450 *7,550	*3450 *7,550	*2400	*2400			*2200 *4,850	*2200 *4,850	6070 19'8"
4500 mm 15'0"	kg lb					*3650 *7,950	*3650 *7,950	*3450 *7,400	2700 5,750			*2050 *4,500	*2050 *4,500	6960 22'8"
3000 mm 10'0"	kg lb			*5850 *12,100	*5850 *12,100	*4800 *10,350	4000 8,650	*3950 *8,550	2600 5,550			*2050 *4,500	1850 4,050	7440 24'4"
1500 mm 5'0"	kg lb			*8750 *18,800	6800 14,600	*5600 *12,050	3750 8,050	3900 8,400	2450 5,300	*2500	1750	*2150 *4,750	1750 3,800	7590 24'10"
0 mm 0'0"	kg lb			*7000 *16,150	6350 13,600	5850 12,550	3500 7,550	3800 8,150	2350 5,100			*2400 *5,250	1750 3,850	7430 24'4"
-1500 mm -5'0"	kg lb	*4300 *9,650	*4300 *9,650	*8500 *18,350	6200 13,300	5700 12,250	3400 7,350	3750 8,000	2300 4,950			*2850 *6,250	1900 4,200	6940 22'8"
-3000 mm -10'0"	kg lb	*7450 *16,700	*7450 *16,700	*6650 *14,350	6250 13,450	*4700 *10,000	3400 7,350	*3000	2350			*2950 *6,400	2300 5,100	6050 19'8"
-4500 mm -15'0"	kg lb			*3450 *7,050	*3450 *7,050							*2050 *4,250	*2050 *4,250	4490 14'4"



ISO 10567:2007



* Indicates that the load is limited by hydraulic lifting capacity rather than tipping load. The above loads are in compliance with hydraulic excavator lift capacity standard ISO 10567:2007. They do not exceed 87% of hydraulic lifting capacity or 75% of tipping load. Weight of all lifting accessories must be deducted from the above lifting capacities. Lifting capacities are based on the machine standing on a firm, uniform supporting surface. The use of a work tool attachment point to handle/lift objects, could affect the machine lift performance.

Lift capacity stays with ±5% for all available track shoes.

Always refer to the appropriate Operation and Maintenance Manual for specific product information.

315 GC Hydraulic Excavator Specifications

Reach Boom Lift Capacities – Counterweight: 3.83 mt (8,440 lb) – without Bucket

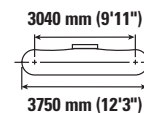
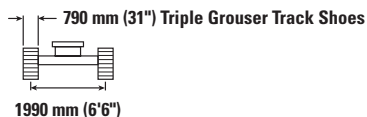

Reach mm ft/in	kg lb	1500 mm (5'0")		3000 mm (10'0")		4500 mm (15'0")		6000 mm (20'0")		7500 mm (25'0")		mm ft/in		
7500 mm 25'0"						*2700	*2700					*2600 *5,850	*2600 *5,850	4540 14'3"
6000 mm 20'0"						*3450 *7,550	*3450 *7,550	*2400	*2400			*2200 *4,850	*2200 *4,850	6070 19'8"
4500 mm 15'0"						*3650 *7,950	*3650 *7,950	*3450 *7,400	2700 5,800			*2050 *4,500	*2050 *4,500	6960 22'8"
3000 mm 10'0"				*5850 *12,100	*5850 *12,100	*4800 *10,350	4050 8,700	*3950 *8,550	2600 5,600			*2050 *4,500	1850 4,100	7440 24'4"
1500 mm 5'0"				*8750 *18,800	6850 14,750	*5600 *12,050	3800 8,100	3950 8,500	2500 5,350	*2500	1800	*2150 *4,750	1750 3,850	7590 24'10"
0 mm 0'0"				*7000 *16,150	6400 13,700	5900 12,650	3550 7,650	3850 8,250	2400 5,150			*2400 *5,250	1750 3,900	7430 24'4"
-1500 mm -5'0"		*4300 *9,650	*4300 *9,650	*8500 *18,350	6250 13,450	*5750 *12,400	3450 7,400	3750 8,100	2350 5,000			*2850 *6,250	1950 4,250	6940 22'8"
-3000 mm -10'0"		*7450 *16,700	*7450 *16,700	*6650 *14,350	6350 13,600	*4700 *10,000	3450 7,400	*3000	2350			*2950 *6,400	2350 5,200	6050 19'8"
-4500 mm -15'0"				*3450 *7,050	*3450 *7,050							*2050 *4,250	*2050 *4,250	4490 14'4"



ISO 10567:2007



* Indicates that the load is limited by hydraulic lifting capacity rather than tipping load. The above loads are in compliance with hydraulic excavator lift capacity standard ISO 10567:2007. They do not exceed 87% of hydraulic lifting capacity or 75% of tipping load. Weight of all lifting accessories must be deducted from the above lifting capacities. Lifting capacities are based on the machine standing on a firm, uniform supporting surface. The use of a work tool attachment point to handle/lift objects, could affect the machine lift performance.

Lift capacity stays with ±5% for all available track shoes.

Always refer to the appropriate Operation and Maintenance Manual for specific product information.

315 GC Hydraulic Excavator Specifications

Reach Boom Lift Capacities – Counterweight: 3.83 mt (8,440 lb) – without Bucket – Blade Up

2500 mm (8'2") Blade

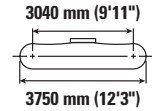
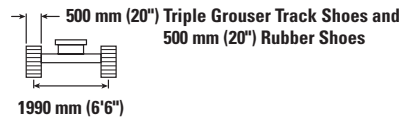
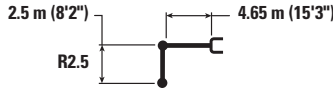

Reach Boom Lift Capacity	Unit	1500 mm (5'0")		3000 mm (10'0")		4500 mm (15'0")		6000 mm (20'0")		2500 mm (8'2") Blade		mm ft/in
		Hydraulic	Tipping	Hydraulic	Tipping	Hydraulic	Tipping	Hydraulic	Tipping	Hydraulic	Tipping	
7500 mm 25'0"	kg lb			*4350 *9,200	*4350 *9,200					*3250 *7,450	*3250 *7,450	3710 11'5"
6000 mm 20'0"	kg lb					*4050 *8,750	*4050 *8,750			*2600 *5,800	*2600 *5,800	5490 17'8"
4500 mm 15'0"	kg lb			*4150 *9,050	*4150 *9,050	*4500 *9,750	4250 9,100	*3700 *7,600	2700 5,750	*2450 *5,350	*2400 5,250	6460 21'0"
3000 mm 10'0"	kg lb			*7400 *15,850	*7400 *15,850	*5150 *11,150	4000 8,650	3900 8,350	2600 5,600	*2450 *5,350	2050 4,550	6970 22'9"
1500 mm 5'0"	kg lb			*6800 *16,700	6700 14,450	*5850 12,550	3750 8,100	3750 8,100	2500 5,400	*2550 *5,600	1950 4,300	7130 23'4"
0 mm 0'0"	kg lb			*6250 *14,500	*6250 13,800	5650 12,100	3600 7,700	3700 7,900	2400 5,200	*2850 *6,250	2000 4,350	6960 22'9"
-1500 mm -5'0"	kg lb	*4750 *10,700	*4750 *10,700	*7900 *17,150	6400 13,700	*5550 11,950	3500 7,550	3650 7,800	2400 5,150	3300 7,300	2200 4,800	6440 21'0"
-3000 mm -10'0"	kg lb	*7300 *15,650	*7300 *15,650	*5750 *12,350	*5750 *12,350	*4150 *8,750	3550 7,650			*2950 *6,400	2750 6,150	5460 17'9"

Reach Boom Lift Capacities – Counterweight: 3.83 mt (8,440 lb) – without Bucket – Blade Up

2500 mm (8'2") Blade

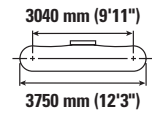
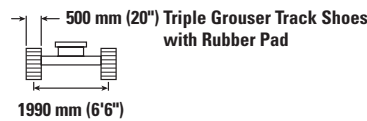
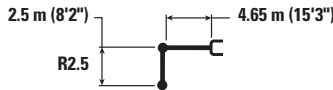

Reach Boom Lift Capacity	Unit	1500 mm (5'0")		3000 mm (10'0")		4500 mm (15'0")		6000 mm (20'0")		2500 mm (8'2") Blade		mm ft/in
		Hydraulic	Tipping	Hydraulic	Tipping	Hydraulic	Tipping	Hydraulic	Tipping	Hydraulic	Tipping	
7500 mm 25'0"	kg lb			*4350 *9,200	*4350 *9,200					*3250 *7,450	*3250 *7,450	3710 11'5"
6000 mm 20'0"	kg lb					*4050 *8,750	*4050 *8,750			*2600 *5,800	*2600 *5,800	5490 17'8"
4500 mm 15'0"	kg lb			*4150 *9,050	*4150 *9,050	*4500 *9,750	4350 9,350	*3700 *7,600	2750 5,950	*2450 *5,350	*2450 *5,350	6460 21'0"
3000 mm 10'0"	kg lb			*7400 *15,850	*7400 *15,850	*5150 *11,150	4150 8,900	4000 8,600	2700 5,800	*2450 *5,350	2150 4,700	6970 22'9"
1500 mm 5'0"	kg lb			*6800 *16,700	*6800 14,900	*5850 *12,600	3900 8,350	3900 8,400	2600 5,550	*2550 *5,600	2000 4,450	7130 23'4"
0 mm 0'0"	kg lb			*6250 *14,500	*6250 14,250	5850 12,500	3700 7,950	3800 8,150	2500 5,400	*2850 *6,250	2050 4,500	6960 22'9"
-1500 mm -5'0"	kg lb	*4750 *10,700	*4750 *10,700	*7900 *17,150	6600 14,150	*5550 *11,950	3650 7,800	3750 8,100	2450 5,300	*3400 *7,450	2250 5,000	6440 21'0"
-3000 mm -10'0"	kg lb	*7300 *15,650	*7300 *15,650	*5750 *12,350	*5750 *12,350	*4150 *8,750	3650 7,900			*2950 *6,400	2850 6,350	5460 17'9"



ISO 10567:2007



* Indicates that the load is limited by hydraulic lifting capacity rather than tipping load. The above loads are in compliance with hydraulic excavator lift capacity standard ISO 10567:2007.

They do not exceed 87% of hydraulic lifting capacity or 75% of tipping load. Weight of all lifting accessories must be deducted from the above lifting capacities. Lifting capacities are based on the machine standing on a firm, uniform supporting surface. The use of a work tool attachment point to handle/lift objects, could affect the machine lift performance.

Lift capacity stays with ±5% for all available track shoes.

Always refer to the appropriate Operation and Maintenance Manual for specific product information.

315 GC Hydraulic Excavator Specifications

Reach Boom Lift Capacities – Counterweight: 3.83 mt (8,440 lb) – without Bucket – Blade Up

2600 mm (8'6") Blade

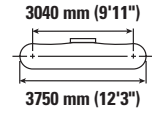
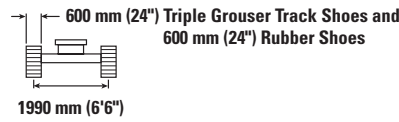
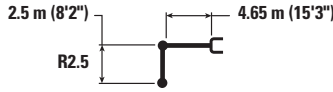

Reach Boom Length	Unit	1500 mm (5'0")		3000 mm (10'0")		4500 mm (15'0")		6000 mm (20'0")		2600 mm (8'6") Blade		mm ft/in
		Hydraulic	Tipping	Hydraulic	Tipping	Hydraulic	Tipping	Hydraulic	Tipping	Hydraulic	Tipping	
7500 mm 25'0"	kg lb			*4350 *9,200	*4350 *9,200					*3250 *7,450	*3250 *7,450	3710 11'5"
6000 mm 20'0"	kg lb					*4050 *8,750	*4050 *8,750			*2600 *5,800	*2600 *5,800	5490 17'8"
4500 mm 15'0"	kg lb			*4150 *9,050	*4150 *9,050	*4500 *9,750	4300 9,250	*3700 *7,600	2750 5,850	*2450 *5,350	2450 *5,350	6460 21'0"
3000 mm 10'0"	kg lb			*7400 *15,850	*7400 *15,850	*5150 *11,150	4100 8,800	3950 8,500	2650 5,700	*2450 *5,350	2100 4,650	6970 22'9"
1500 mm 5'0"	kg lb			*6800 *16,700	*6800 14,750	*5850 *12,600	3850 8,250	3850 8,250	2550 5,500	*2550 *5,600	2000 4,400	7130 23'4"
0 mm 0'0"	kg lb			*6250 *14,500	*6250 14,050	5750 12,300	3650 7,850	3750 8,050	2500 5,300	*2850 *6,250	2050 4,450	6960 22'9"
-1500 mm -5'0"	kg lb	*4750 *10,700	*4750 *10,700	*7900 *17,150	6500 14,000	*5550 *11,950	3600 7,700	3700 7,950	2450 5,250	3350 7,400	2250 4,900	6440 21'0"
-3000 mm -10'0"	kg lb	*7300 *15,650	*7300 *15,650	*5750 *12,350	*5750 *12,350	*4150 *8,750	3650 7,800			*2950 *6,400	2800 6,250	5460 17'9"

Reach Boom Lift Capacities – Counterweight: 3.83 mt (8,440 lb) – without Bucket – Blade Up

2700 mm (8'10") Blade

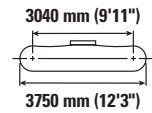
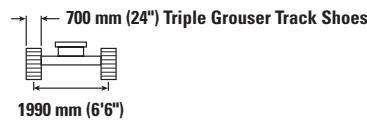
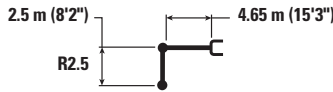

Reach Boom Length	Unit	1500 mm (5'0")		3000 mm (10'0")		4500 mm (15'0")		6000 mm (20'0")		2700 mm (8'10") Blade		mm ft/in
		Hydraulic	Tipping	Hydraulic	Tipping	Hydraulic	Tipping	Hydraulic	Tipping	Hydraulic	Tipping	
7500 mm 25'0"	kg lb			*4350 *9,200	*4350 *9,200					*3250 *7,450	*3250 *7,450	3710 11'5"
6000 mm 20'0"	kg lb					*4050 *8,750	*4050 *8,750			*2600 *5,800	*2600 *5,800	5490 17'8"
4500 mm 15'0"	kg lb			*4150 *9,050	*4150 *9,050	*4500 *9,750	4350 9,350	*3700 *7,600	2800 5,950	*2450 *5,350	*2450 *5,350	6460 21'0"
3000 mm 10'0"	kg lb			*7400 *15,850	*7400 *15,850	*5150 *11,150	4150 8,900	4000 8,600	2700 5,800	*2450 *5,350	2150 4,700	6970 22'9"
1500 mm 5'0"	kg lb			*6800 *16,700	*6800 14,950	*5850 *12,600	3900 8,350	3900 8,350	2600 5,600	*2550 *5,600	2050 4,450	7130 23'4"
0 mm 0'0"	kg lb			*6250 *14,500	*6250 14,250	5800 12,450	3700 7,950	3800 8,150	2500 5,400	*2850 *6,250	2050 4,500	6960 22'9"
-1500 mm -5'0"	kg lb	*4750 *10,700	*4750 *10,700	*7900 *17,150	6600 14,200	*5550 *11,950	3650 7,800	3750 8,050	2500 5,350	*3400 *7,450	2250 5,000	6440 21'0"
-3000 mm -10'0"	kg lb	*7300 *15,650	*7300 *15,650	*5750 *12,350	*5750 *12,350	*4150 *8,750	3700 7,900			*2950 *6,400	2850 6,350	5460 17'9"



ISO 10567:2007



* Indicates that the load is limited by hydraulic lifting capacity rather than tipping load. The above loads are in compliance with hydraulic excavator lift capacity standard ISO 10567:2007.

They do not exceed 87% of hydraulic lifting capacity or 75% of tipping load. Weight of all lifting accessories must be deducted from the above lifting capacities. Lifting capacities are based on the machine standing on a firm, uniform supporting surface. The use of a work tool attachment point to handle/lift objects, could affect the machine lift performance.

Lift capacity stays with ±5% for all available track shoes.









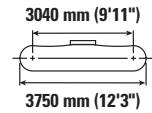
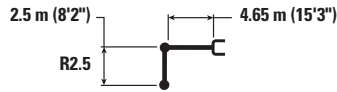

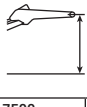

Always refer to the appropriate Operation and Maintenance Manual for specific product information.

315 GC Hydraulic Excavator Specifications

Reach Boom Lift Capacities – Counterweight: 3.83 mt (8,440 lb) – without Bucket – Blade Up

2700 mm (8'10") Blade



	1500 mm (5'0")		3000 mm (10'0")		4500 mm (15'0")		6000 mm (20'0")				mm ft/in	
												
7500 mm 25'0"	kg lb		*4350 *9,200	*4350 *9,200					*3250 *7,450	*3250 *7,450	3710 11'5"	
6000 mm 20'0"	kg lb				*4050 *8,750	*4050 *8,750			*2600 *5,800	*2600 *5,800	5490 17'8"	
4500 mm 15'0"	kg lb		*4150 *9,050	*4150 *9,050	*4500 *9,750	4400 9,450	*3700 *7,600	2800 6,000	*2450 *5,350	*2450 *5,350	6460 21'0"	
3000 mm 10'0"	kg lb		*7400 *15,850	*7400 *15,850	*5150 *11,150	4200 9,000	4050 8,700	2750 5,850	*2450 *5,350	2150 4,750	6970 22'9"	
1500 mm 5'0"	kg lb		*6800 *16,700	*6800 15,050	*5850 *12,600	3900 8,450	3950 8,450	2600 5,650	*2550 *5,600	2050 4,500	7130 23'4"	
0 mm 0'0"	kg lb		*6250 *14,500	*6250 14,400	5850 12,600	3750 8,050	3850 8,250	2550 5,450	*2850 *6,250	2100 4,550	6960 22'9"	
-1500 mm -5'0"	kg lb	*4750 *10,700	*4750 *10,700	*7900 *17,150	6650 14,300	*5550 *11,950	3650 7,900	3800 8,150	2500 5,400	*3400 *7,450	2300 5,050	6440 21'0"
-3000 mm -10'0"	kg lb	*7300 *15,650	*7300 *15,650	*5750 *12,350	*5750 *12,350	*4150 *8,750	3700 8,000		*2950 *6,400	2900 *6,400	5460 17'9"	



ISO 10567:2007



* Indicates that the load is limited by hydraulic lifting capacity rather than tipping load. The above loads are in compliance with hydraulic excavator lift capacity standard ISO 10567:2007. They do not exceed 87% of hydraulic lifting capacity or 75% of tipping load. Weight of all lifting accessories must be deducted from the above lifting capacities. Lifting capacities are based on the machine standing on a firm, uniform supporting surface. The use of a work tool attachment point to handle/lift objects, could affect the machine lift performance.

Lift capacity stays with ±5% for all available track shoes.

Always refer to the appropriate Operation and Maintenance Manual for specific product information.

315 GC Hydraulic Excavator Specifications

Reach Boom Lift Capacities – Counterweight: 3.83 mt (8,440 lb) – without Bucket – Blade Up

2500 mm (8'2") Blade

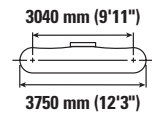
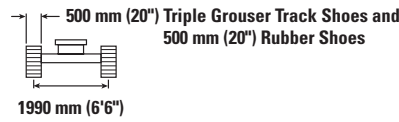
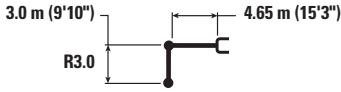

		1500 mm (5'0")		3000 mm (10'0")		4500 mm (15'0")		6000 mm (20'0")		7500 mm (25'0")		mm ft/in		
7500 mm 25'0"	kg lb					*2700	*2700					*2600 *5,850	*2600 *5,850	4540 14'3"
6000 mm 20'0"	kg lb					*3450 *7,550	*3450 *7,550	*2400	*2400			*2200 *4,850	*2200 *4,850	6070 19'8"
4500 mm 15'0"	kg lb					*3650 *7,950	*3650 *7,950	*3450 *7,400	2700 5,850			*2050 *4,500	*2050 *4,500	6960 22'8"
3000 mm 10'0"	kg lb			*5850 *12,100	*5850 *12,100	*4800 *10,350	4100 8,750	3900 8,400	2650 5,650			*2050 *4,500	1850 4,100	7440 24'4"
1500 mm 5'0"	kg lb			*8750 *18,800	6900 14,800	*5600 *12,050	3800 8,150	3800 8,100	2500 5,400	*2500 1800		*2150 *4,750	1750 3,850	7590 24'10"
0 mm 0'0"	kg lb			*7000 *16,150	6450 13,800	5650 12,100	3600 7,700	3650 7,850	2400 5,150			*2400 *5,250	1800 3,900	7430 24'4"
-1500 mm -5'0"	kg lb	*4300 *9,650	*4300 *9,650	*8500 *18,350	6300 13,550	5500 11,850	3450 7,450	3600 7,750	2350 5,050			*2850 *6,250	1950 4,250	6940 22'8"
-3000 mm -10'0"	kg lb	*7450 *16,700	*7450 *16,700	*6650 *14,350	6350 13,650	*4700 *10,000	3450 7,450	*3000	2350			*2950 *6,400	2350 5,200	6050 19'8"
-4500 mm -15'0"	kg lb			*3450 *7,050	*3450 *7,050							*2050 *4,250	*2050 *4,250	4490 14'4"

Reach Boom Lift Capacities – Counterweight: 3.83 mt (8,440 lb) – without Bucket – Blade Up

2500 mm (8'2") Blade

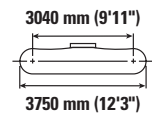
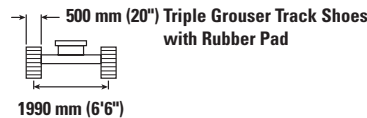
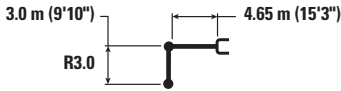

		1500 mm (5'0")		3000 mm (10'0")		4500 mm (15'0")		6000 mm (20'0")		7500 mm (25'0")		mm ft/in		
7500 mm 25'0"	kg lb					*2700	*2700					*2600 *5,850	*2600 *5,850	4540 14'3"
6000 mm 20'0"	kg lb					*3450 *7,550	*3450 *7,550	*2400	*2400			*2200 *4,850	*2200 *4,850	6070 19'8"
4500 mm 15'0"	kg lb					*3650 *7,950	*3650 *7,950	*3450 *7,400	2800 6,000			*2050 *4,500	*2050 *4,500	6960 22'8"
3000 mm 10'0"	kg lb			*5850 *12,100	*5850 *12,100	*4800 *10,350	4200 9,000	*3950 *8,550	2700 5,850			*2050 *4,500	1950 4,250	7440 24'4"
1500 mm 5'0"	kg lb			*8750 *18,800	7100 15,250	*5600 *12,050	3900 8,400	3900 8,400	2600 5,550	*2500 1850		*2150 *4,750	1850 4,000	7590 24'10"
0 mm 0'0"	kg lb			*7000 *16,150	6650 14,250	5850 12,550	3700 7,950	3800 8,150	2500 5,350			*2400 *5,250	1850 4,050	7430 24'4"
-1500 mm -5'0"	kg lb	*4300 *9,650	*4300 *9,650	*8500 *18,350	6500 14,000	5700 12,250	3600 7,700	3750 8,000	2450 5,200			*2850 *6,250	2000 4,400	6940 22'8"
-3000 mm -10'0"	kg lb	*7450 *16,700	*7450 *16,700	*6650 *14,350	6600 14,100	*4700 *10,000	3600 7,700	*3000	2450			*2950 *6,400	2450 5,400	6050 19'8"
-4500 mm -15'0"	kg lb			*3450 *7,050	*3450 *7,050							*2050 *4,250	*2050 *4,250	4490 14'4"



ISO 10567:2007



* Indicates that the load is limited by hydraulic lifting capacity rather than tipping load. The above loads are in compliance with hydraulic excavator lift capacity standard ISO 10567:2007. They do not exceed 87% of hydraulic lifting capacity or 75% of tipping load. Weight of all lifting accessories must be deducted from the above lifting capacities. Lifting capacities are based on the machine standing on a firm, uniform supporting surface. The use of a work tool attachment point to handle/lift objects, could affect the machine lift performance.

Lift capacity stays with ±5% for all available track shoes.

Always refer to the appropriate Operation and Maintenance Manual for specific product information.

315 GC Hydraulic Excavator Specifications

Reach Boom Lift Capacities – Counterweight: 3.83 mt (8,440 lb) – without Bucket – Blade Up

2600 mm (8'6") Blade

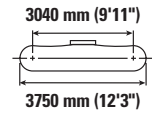
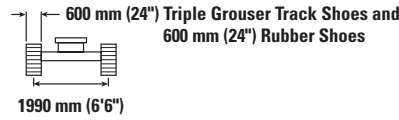
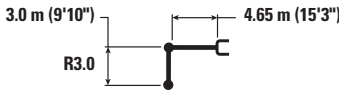

		1500 mm (5'0")		3000 mm (10'0")		4500 mm (15'0")		6000 mm (20'0")		7500 mm (25'0")		mm ft/in		
7500 mm 25'0"	kg lb					*2700	*2700					*2600 *5,850	*2600 *5,850	4540 14'3"
6000 mm 20'0"	kg lb					*3450 *7,550	*3450 *7,550	*2400	*2400			*2200 *4,850	*2200 *4,850	6070 19'8"
4500 mm 15'0"	kg lb					*3650 *7,950	*3650 *7,950	*3450 *7,400	2800 5,950			*2050 *4,500	*2050 *4,500	6960 22'8"
3000 mm 10'0"	kg lb			*5850 *12,100	*5850 *12,100	*4800 *10,350	4150 8,950	*3950 8,550	2700 5,750			*2050 *4,500	1900 4,200	7440 24'4"
1500 mm 5'0"	kg lb			*8750 *18,800	7000 15,100	*5600 *12,050	3850 8,350	3850 8,250	2550 5,500	*2500 1850		*2150 *4,750	1800 3,950	7590 24'10"
0 mm 0'0"	kg lb			*7000 *16,150	6550 14,100	5750 12,300	3650 7,850	3750 8,000	2450 5,300			*2400 *5,250	1850 4,000	7430 24'4"
-1500 mm -5'0"	kg lb	*4300 *9,650	*4300 *9,650	*8500 *18,350	6450 13,800	5600 12,050	3550 7,600	3650 7,850	2400 5,150			*2850 *6,250	2000 4,350	6940 22'8"
-3000 mm -10'0"	kg lb	*7450 *16,700	*7450 *16,700	*6650 *14,350	6500 13,950	*4700 *10,000	3550 7,650	*3000	2450			*2950 *6,400	2400 5,300	6050 19'8"
-4500 mm -15'0"	kg lb			*3450 *7,050	*3450 *7,050							*2050 *4,250	*2050 *4,250	4490 14'4"

Reach Boom Lift Capacities – Counterweight: 3.83 mt (8,440 lb) – without Bucket – Blade Up

2700 mm (8'10") Blade

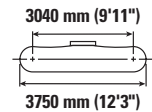
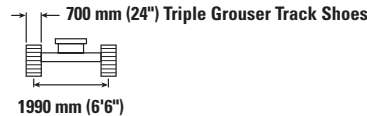
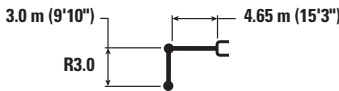

		1500 mm (5'0")		3000 mm (10'0")		4500 mm (15'0")		6000 mm (20'0")		7500 mm (25'0")		mm ft/in		
7500 mm 25'0"	kg lb					*2700	*2700					*2600 *5,850	*2600 *5,850	4540 14'3"
6000 mm 20'0"	kg lb					*3450 *7,550	*3450 *7,550	*2400	*2400			*2200 *4,850	*2200 *4,850	6070 19'8"
4500 mm 15'0"	kg lb					*3650 *7,950	*3650 *7,950	*3450 *7,400	2800 6,000			*2050 *4,500	*2050 *4,500	6960 22'8"
3000 mm 10'0"	kg lb			*5850 *12,100	*5850 *12,100	*4800 *10,350	4200 9,050	*3950 *8,550	2700 5,850			*2050 *4,500	1950 4,250	7440 24'4"
1500 mm 5'0"	kg lb			*8750 *18,800	7100 15,300	*5600 *12,050	3900 8,450	3900 8,350	2600 5,600	*2500 1850		*2150 *4,750	1850 4,000	7590 24'10"
0 mm 0'0"	kg lb			*7000 *16,150	6650 14,300	5800 12,500	3700 7,950	3800 8,100	2500 5,350			*2400 *5,250	1850 4,050	7430 24'4"
-1500 mm -5'0"	kg lb	*4300 *9,650	*4300 *9,650	*8500 *18,350	6550 14,000	5700 12,200	3600 7,750	3700 7,950	2450 5,250			*2850 *6,250	2000 4,400	6940 22'8"
-3000 mm -10'0"	kg lb	*7450 *16,700	*7450 *16,700	*6650 *14,350	6600 14,150	*4700 *10,000	3600 7,750	*3000	2450			*2950 *6,400	2450 5,400	6050 19'8"
-4500 mm -15'0"	kg lb			*3450 *7,050	*3450 *7,050							*2050 *4,250	*2050 *4,250	4490 14'4"



ISO 10567:2007



* Indicates that the load is limited by hydraulic lifting capacity rather than tipping load. The above loads are in compliance with hydraulic excavator lift capacity standard ISO 10567:2007. They do not exceed 87% of hydraulic lifting capacity or 75% of tipping load. Weight of all lifting accessories must be deducted from the above lifting capacities. Lifting capacities are based on the machine standing on a firm, uniform supporting surface. The use of a work tool attachment point to handle/lift objects, could affect the machine lift performance.

Lift capacity stays with ±5% for all available track shoes.

Always refer to the appropriate Operation and Maintenance Manual for specific product information.

315 GC Hydraulic Excavator Specifications

Reach Boom Lift Capacities – Counterweight: 3.83 mt (8,440 lb) – without Bucket – Blade Up

2700 mm (8'10") Blade

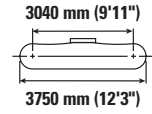
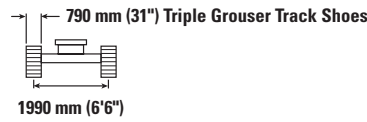
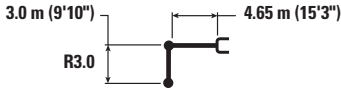

Reach	Unit	1500 mm (5'0")		3000 mm (10'0")		4500 mm (15'0")		6000 mm (20'0")		7500 mm (25'0")		2700 mm (8'10") Blade		
		kg	lb	kg	lb	kg	lb	kg	lb	kg	lb	kg	lb	mm ft/in
7500 mm 25'0"	kg lb					*2700 *2700	*2700 *2700					*2600 *5,850	*2600 *5,850	4540 14'3"
6000 mm 20'0"	kg lb					*3450 *7,550	*3450 *7,550	*2400 *2400	*2400 *2400			*2200 *4,850	*2200 *4,850	6070 19'8"
4500 mm 15'0"	kg lb					*3650 *7,950	*3650 *7,950	*3450 *7,400	2850 6,050			*2050 *4,500	*2050 *4,500	6960 22'8"
3000 mm 10'0"	kg lb			*5850 *12,100	*5850 *12,100	*4800 *10,350	4250 9,100	*3950 *8,550	2750 5,900			*2050 *4,500	1950 4,300	7440 24'4"
1500 mm 5'0"	kg lb			*8750 *18,800	7150 15,450	*5600 *12,050	3950 8,500	3950 8,450	2650 5,650	*2500 1900		*2150 *4,750	1850 4,050	7590 24'10"
0 mm 0'0"	kg lb			*7000 *16,150	6700 14,400	5900 12,600	3750 8,050	3800 8,200	2500 5,400			*2400 *5,250	1850 4,100	7430 24'4"
-1500 mm -5'0"	kg lb	*4300 *9,650	*4300 *9,650	*8500 *18,350	6600 14,150	*5750 12,350	3650 7,800	3750 8,050	2450 5,300			*2850 *6,250	2050 4,450	6940 22'8"
-3000 mm -10'0"	kg lb	*7450 *16,700	*7450 *16,700	*6650 *14,350	6650 14,300	*4700 *10,000	3650 7,800	*3000 *3000	2500 2500			*2950 *6,400	2450 5,450	6050 19'8"
-4500 mm -15'0"	kg lb			*3450 *7,050	*3450 *7,050							*2050 *4,250	*2050 *4,250	4490 14'4"



ISO 10567:2007



* Indicates that the load is limited by hydraulic lifting capacity rather than tipping load. The above loads are in compliance with hydraulic excavator lift capacity standard ISO 10567:2007. They do not exceed 87% of hydraulic lifting capacity or 75% of tipping load. Weight of all lifting accessories must be deducted from the above lifting capacities. Lifting capacities are based on the machine standing on a firm, uniform supporting surface. The use of a work tool attachment point to handle/lift objects, could affect the machine lift performance.

Lift capacity stays with ±5% for all available track shoes.

Always refer to the appropriate Operation and Maintenance Manual for specific product information.

315 GC Hydraulic Excavator Specifications

Bucket Specifications and Compatibility – Europe

	Linkage	Width		Capacity		Weight		Fill %	Reach Boom	
		mm	in	m ³	yd ³	kg	lb		R2.5 (8'2")	R3.0 (9'10")
Pin-On (No Quick Coupler)										
General Duty	312	600	24	0.31	0.40	316	696	100	●	●
	312	900	36	0.53	0.69	414	914	100	●	●
	312	900	36	0.53	0.69	420	927	100	●	●
	312	1000	39	0.60	0.78	438	967	100	●	●
General Duty (No Adjuster)	312	450	18	0.20	0.26	266	587	100	●	●
	312	600	24	0.31	0.40	310	684	100	●	●
	312	750	30	0.41	0.54	358	790	100	●	●
	312	750	30	0.41	0.54	410	903	100	●	●
	312	900	36	0.53	0.69	407	898	100	●	●
	312	900	36	0.53	0.69	451	994	100	●	●
Heavy Duty	312	1050	42	0.65	0.84	457	1,006	100	●	⊙
	312	450	18	0.20	0.27	279	615	100	●	●
Ditch Cleaning	312	1200	48	0.76	0.99	513	1,131	100	⊙	⊖
Ditch Cleaning Tilt	312	1800	72	0.68	0.89	540	1,191	100	●	⊙
								kg	1930	1720
Maximum load with pin-on (payload + bucket)								lb	4,262	3,787
With Cat Pin Grabber Coupler										
General Duty	312	600	24	0.31	0.40	316	696	100	●	●
	312	900	36	0.53	0.69	414	914	100	●	●
	312	1100	43	0.68	0.89	474	1,045	100	⊙	⊖
	312	1200	48	0.76	1.00	504	1,110	100	⊖	○
General Duty (No Adjuster)	312	450	18	0.20	0.26	266	587	100	●	●
	312	600	24	0.31	0.40	310	684	100	●	●
	312	750	30	0.41	0.54	358	790	100	●	●
	312	750	30	0.41	0.54	410	903	100	●	●
	312	900	36	0.53	0.69	407	898	100	●	●
	312	900	36	0.53	0.69	451	994	100	●	●
	312	1050	42	0.65	0.84	457	1,006	100	⊙	⊖
	312	1200	48	0.76	1.00	497	1,095	100	⊖	○
Heavy Duty	312	450	18	0.20	0.27	279	615	100	●	●
	312	1200	48	0.76	0.99	513	1,131	100	⊖	○
Ditch Cleaning	312	1800	72	0.68	0.89	540	1,191	100	⊙	⊖
Ditch Cleaning Tilt	312	1800	72	0.60	0.78	724	1,597	100	⊖	○
								kg	1734	1518
Maximum load with coupler (payload + bucket)								lb	3,822	3,347

The above loads are in compliance with hydraulic excavator standard EN474-5:2006 + A3:2013, they do not exceed 87% of hydraulic lifting capacity or 75% of tipping capacity with front linkage fully extended at ground line with bucket curled. Capacity based on ISO 7451:2007.

Maximum Material Density:

- 2100 kg/m³ (3,500 lb/yd³)
- ⊙ 1800 kg/m³ (3,000 lb/yd³)
- ⊖ 1500 kg/m³ (2,500 lb/yd³)
- 1200 kg/m³ (2,000 lb/yd³)

Caterpillar recommends using appropriate work tools to maximize the value customers receive from our products. Use of work tools, including buckets, which are outside of Caterpillar's recommendations or specifications for weight, dimensions, flows, pressures, etc. may result in less-than-optimal performance, including but not limited to reductions in production, stability, reliability, and component durability. Improper use of a work tool resulting in sweeping, prying, twisting and/or catching of heavy loads will reduce the life of the boom and stick.

(continued on next page)

315 GC Hydraulic Excavator Specifications

Bucket Specifications and Compatibility – Europe (continued)

	Linkage	Width		Capacity		Weight		Fill %	Reach Boom	
		mm	in	m ³	yd ³	kg	lb		R2.5 (8'2")	R3.0 (9'10")
With CW20 Coupler										
General Duty	312	600	24	0.31	0.40	341	752	100	●	●
	312	900	36	0.53	0.69	426	940	100	●	●
	312	1100	43	0.68	0.89	487	1,073	100	⊙	⊖
	312	1200	48	0.76	1.00	516	1,137	100	⊖	○
Heavy Duty	312	1200	48	0.76	1.00	526	1,159	100	⊖	○
General Duty – Leveling Edge	312	690	27	0.40	0.52	413	910	100	●	●
	312	600	24	0.33	0.43	395	870	100	●	●
	312	790	31	0.47	0.61	455	1,003	100	●	●
	312	996	39	0.63	0.83	517	1,140	100	⊙	⊖
	312	1184	47	0.80	1.05	603	1,328	100	○	◇
Ditch Cleaning	312	1800	72	0.68	0.89	516	1,138	100	⊙	⊖
	312	1800	72	0.90	1.18	554	1,221	100	○	◇
Maximum load with coupler (payload + bucket)								kg	1728	1513
								lb	3,810	3,335
With CW20S Coupler										
General Duty	312	450	18	0.20	0.26	301	664	100	●	●
	312	500	20	0.24	0.31	310	684	100	●	●
	312	600	24	0.31	0.40	329	726	100	●	●
	312	750	30	0.41	0.54	377	830	100	●	●
	312	900	36	0.53	0.69	426	940	100	●	●
	312	1000	39	0.60	0.78	451	995	100	●	⊙
	312	1100	43	0.68	0.89	487	1,073	100	⊙	⊖
	312	1200	48	0.76	1.00	516	1,137	100	⊖	○
Heavy Duty	312	500	20	0.24	0.31	313	689	100	●	●
	312	1200	48	0.76	1.00	524	1,154	100	⊖	○
Ditch Cleaning	312	1800	72	0.68	0.89	548	1,207	100	⊙	⊖
	312	2000	78	1.00	1.31	630	1,389	100	◇	◇
Ditch Cleaning Tilt	312	1800	72	0.60	0.78	822	1,812	100	⊖	○
Maximum load with coupler (payload + bucket)								kg	1750	1535
								lb	3,859	3,384

The above loads are in compliance with hydraulic excavator standard EN474-5:2006 + A3:2013, they do not exceed 87% of hydraulic lifting capacity or 75% of tipping capacity with front linkage fully extended at ground line with bucket curled. Capacity based on ISO 7451:2007.

Maximum Material Density:

- 2100 kg/m³ (3,500 lb/yd³)
- ⊙ 1800 kg/m³ (3,000 lb/yd³)
- ⊖ 1500 kg/m³ (2,500 lb/yd³)
- 1200 kg/m³ (2,000 lb/yd³)
- ◇ 900 kg/m³ (1,500 lb/yd³)

Caterpillar recommends using appropriate work tools to maximize the value customers receive from our products. Use of work tools, including buckets, which are outside of Caterpillar's recommendations or specifications for weight, dimensions, flows, pressures, etc. may result in less-than-optimal performance, including but not limited to reductions in production, stability, reliability, and component durability. Improper use of a work tool resulting in sweeping, prying, twisting and/or catching of heavy loads will reduce the life of the boom and stick.

315 GC Hydraulic Excavator Specifications

Bucket Specifications and Compatibility – Australia and New Zealand

	Linkage	Width		Capacity		Weight		Fill %	Reach Boom	
		mm	in	m ³	yd ³	kg	lb		R2.5 (8'2")	R3.0 (9'10")
Pin-On (No Quick Coupler)										
Utility Duty	312	450	18	0.20	0.26	256	565	100	●	●
	312	600	24	0.30	0.39	299	660	100	●	●
	312	900	36	0.50	0.65	388	856	100	●	●
General Duty	312	450	18	0.20	0.26	266	587	100	●	●
	312	600	24	0.31	0.40	310	684	100	●	●
	312	750	30	0.41	0.54	358	790	100	●	●
	312	750	30	0.41	0.54	410	903	100	●	●
	312	900	36	0.53	0.69	407	898	100	●	●
	312	900	36	0.53	0.69	451	994	100	●	●
	312	1050	42	0.65	0.84	457	1,006	100	●	⊙
Clean Up	312	1500	60	1.02	1.33	651	1,435	100	○	◇
	312	1800	72	1.29	1.68	748	1,649	100	◇	X
Ditch Cleaning Tilt	312	1500	60	0.74	0.98	704	1,553	100	⊖	○
	312	1800	72	0.90	1.18	784	1,728	100	○	◇
								kg	1930	1720
								lb	4,262	3,787
With Cat Pin Grabber Coupler										
Utility Duty	312	450	18	0.20	0.26	256	565	100	●	●
	312	600	24	0.30	0.39	299	660	100	●	●
	312	900	36	0.50	0.65	388	856	100	●	●
General Duty	312	450	18	0.20	0.26	266	587	100	●	●
	312	600	24	0.31	0.40	310	684	100	●	●
	312	750	30	0.41	0.54	358	790	100	●	●
	312	750	30	0.41	0.54	410	903	100	●	●
	312	900	36	0.53	0.69	407	898	100	●	●
	312	900	36	0.53	0.69	451	994	100	●	●
	312	1050	42	0.65	0.84	457	1,006	100	⊙	⊖
Clean Up	312	1500	60	1.02	1.33	651	1,435	100	◇	X
	312	1800	72	1.29	1.68	748	1,649	100	X	X
Ditch Cleaning Tilt	312	1500	60	0.74	0.98	704	1,553	100	○	◇
	312	1800	72	0.90	1.18	784	1,728	100	◇	X
								kg	1734	1518
								lb	3,822	3,347

The above loads are in compliance with hydraulic excavator standard EN474-5:2006 + A3:2013, they do not exceed 87% of hydraulic lifting capacity or 75% of tipping capacity with front linkage fully extended at ground line with bucket curled. Capacity based on ISO 7451:2007.

Maximum Material Density:

- 2100 kg/m³ (3,500 lb/yd³)
- ⊙ 1800 kg/m³ (3,000 lb/yd³)
- ⊖ 1500 kg/m³ (2,500 lb/yd³)
- 1200 kg/m³ (2,000 lb/yd³)
- ◇ 900 kg/m³ (1,500 lb/yd³)

Caterpillar recommends using appropriate work tools to maximize the value customers receive from our products. Use of work tools, including buckets, which are outside of Caterpillar's recommendations or specifications for weight, dimensions, flows, pressures, etc. may result in less-than-optimal performance, including but not limited to reductions in production, stability, reliability, and component durability. Improper use of a work tool resulting in sweeping, prying, twisting and/or catching of heavy loads will reduce the life of the boom and stick.

315 GC Hydraulic Excavator Specifications

Attachments Offering Guide – Europe

Not all Attachments are available in all regions. Consult your Cat dealer for configurations available in your region.

Match
 * Working range front only
 No Match
 1200 kg/m³ (2,000 lb/yd³)

PIN-ON ATTACHMENTS

Boom Type		Reach Boom	
		R2.5 (8'2")	R3.0 (9'10")
Hydraulic Hammers	H110 GC S	✓	✓
	H110 S	✓	✓
	H115 GC S	✓	✓
	H115 S	✓	✓
Demolition and Sorting Grapples	G312 GC	✓	✓
Compactors (Vibratory Plate)	CVP75	✓	✓
Orange Peel Grapples	GSV520 GC-400	○	○
	GSV520 GC-500	○	○

CAT PIN GRABBER COUPLER ATTACHMENTS

Boom Type		Reach Boom	
		R2.5 (8'2")	R3.0 (9'10")
Hydraulic Hammers	H110 GC S	✓	✓
	H110 S	✓	✓
	H115 GC S	✓	✓
	H115 S	✓	✓
Compactors (Vibratory Plate)	CVP75	✓	✓

CW-20S DEDICATED COUPLER ATTACHMENTS

Boom Type		Reach Boom	
		R2.5 (8'2")	R3.0 (9'10")
Hydraulic Hammers	H110 GC S	✓	✓
	H110 S	✓	✓
	H115 S	✓	✓
Demolition and Sorting Grapples	G312 GC	✓	✓
	G313 GC	✓	
	G314	✓*	
Compactors (Vibratory Plate)	CVP75	✓	✓

(continued on next page)

315 GC Hydraulic Excavator Specifications

Attachments Offering Guide – Europe (continued)

Not all Attachments are available in all regions. Consult your Cat dealer for configurations available in your region.

Match

* Working range front only

No Match

CW-20 DEDICATED COUPLER ATTACHMENTS

Boom Type		Reach Boom	
Stick Length		R2.5 (8'2")	R3.0 (9'10")
Hydraulic Hammers	H110 GC S	✓	✓
	H110 S	✓	✓
	H115 S	✓	✓
Demolition and Sorting Grapples	G312 GC	✓	✓*
	G312 GC Fixed CAN	✓	✓
	G313 GC	✓	
Compactors (Vibratory Plate)	CVP75	✓	✓

HCCW20 COUPLER ATTACHMENTS

Boom Type		Reach Boom	
Stick Length		R2.5 (8'2")	R3.0 (9'10")
Hydraulic Hammers	H110 S	✓	✓*
Compactors (Vibratory Plate)	CVP75	✓	✓

S60 DEDICATED COUPLER ATTACHMENTS

Boom Type		Reach Boom	
Stick Length		R2.5 (8'2")	R3.0 (9'10")
Hydraulic Hammers	H110 GC S	✓	✓
	H110 S	✓	✓
	H115 GC S	✓	✓
	H115 S	✓	✓
Demolition and Sorting Grapples	G312 GC	✓	✓
Compactors (Vibratory Plate)	CVP75	✓	✓

HCS60 COUPLER ATTACHMENTS

Boom Type		Reach Boom	
Stick Length		R2.5 (8'2")	R3.0 (9'10")
Hydraulic Hammers	H110 S	✓	✓
	H115 S	✓	✓
Demolition and Sorting Grapples	G312 GC	✓	✓*
Compactors (Vibratory Plate)	CVP75	✓	✓

HCS65 COUPLER ATTACHMENTS

Boom Type		Reach Boom	
Stick Length		R2.5 (8'2")	R3.0 (9'10")
Hydraulic Hammers	H110 S	✓	✓
	H115 S	✓	✓
Compactors (Vibratory Plate)	CVP75	✓	✓

BOOM-MOUNT ATTACHMENTS

Boom Type		Reach Boom
Mobile Scrap and Demolition Shears	S3025 Flat Top	✓

315 GC Hydraulic Excavator Specifications

Attachments Offering Guide – Australia and New Zealand

Not all Attachments are available in all regions. Consult your Cat dealer for configurations available in your region.

Match

† Allowed usage on machine less than 50%

PIN-ON ATTACHMENTS

Boom Type		Reach Boom	
		R2.5 (8'2")	R3.0 (9'10")
Hydraulic Hammers	H110 GC	✓	✓
	H110 GC S	✓	✓
	H110 S	✓	✓
	H115 GC	✓	✓
	H115 GC S	✓	✓
	H115 S	✓	✓
Compactors (Vibratory Plate)	CVP75	✓	✓

CAT PIN GRABBER COUPLER ATTACHMENTS

Boom Type		Reach Boom	
		R2.5 (8'2")	R3.0 (9'10")
Hydraulic Hammers	H110 GC	✓	✓
	H110 GC S	✓	✓
	H110 S	✓	✓
	H115 GC	✓	✓*
	H115 GC S	✓	✓
	H115 S	✓	✓
Compactors (Vibratory Plate)	CVP75	✓	✓

BOOM-MOUNT ATTACHMENTS

Boom Type		Reach Boom
Mobile Scrap and Demolition Shears	S3025 Flat Top	✓

Standard and Optional Equipment

Standard and optional equipment may vary. Consult your Cat dealer for details.

	Standard	Optional		Standard	Optional
BOOMS, STICKS AND LINKAGES			CAT TECHNOLOGY		
4.65 m (15'3") Reach boom	✓		VisionLink®	✓*	
2.5 m (8'2") Reach stick		✓	VisionLink Productivity		✓
3.0 m (9'10") Reach stick		✓	Remote Flash	✓	
Bucket linkage, with lifting eye	✓		ELECTRICAL SYSTEM		
CAB			Maintenance free battery	✓	
ROPS	✓		Centralized electrical disconnect switch	✓	
High-resolution 203 mm (8") LCD touch screen monitor	✓		LED chassis light, left-hand boom light, cab light – 1,800 lumens	✓	
Auto bi-level air conditioner	✓		LED right-hand boom light – 1,800 lumens		✓
Jog dial and shortcut keys for monitor control	✓		Programmable time-delay LED working lights	✓	
Keyless push-to-start engine control	✓		ENGINE		
Height-adjustable console	✓		Cat® C3.6 single turbo diesel engine	✓	
Tilt-up left-side console	✓		Two selectable modes: Power, Smart	✓	
Mechanical-suspension seat	✓		Automatic engine speed control	✓	
51 mm (2") seat belt	✓		Engine Idle Shutdown	✓	
Bluetooth® integrated radio (with USB, auxiliary port or microphone)	✓		52° C (125° F) high-ambient cooling capacity without derate	✓	
12V DC outlets	✓		–25° C (–13° F) cold start capability	✓	
Document storage	✓		Electric fuel priming pump	✓	
Cup and bottle holders	✓		Variable speed fan	✓	
Openable two-piece front window	✓		Single fuel filtration system with water separator and indicator	✓	
Rear window emergency exit	✓		Sealed double element air filter with pre-cleaner	✓	
Upper radial wiper with washer	✓				
Openable steel hatch	✓				
LED dome light	✓				
Roller front sunscreen	✓				
Roller rear sunscreen		✓			
Washable floor mat	✓				
Beacon ready	✓				

(continued on next page)

*Connect subscription only. Additional subscriptions are available. Contact your Cat dealer for availability.

315 GC Standard and Optional Equipment

Standard and Optional Equipment *(continued)*

Standard and optional equipment may vary. Consult your Cat dealer for details.

	Standard	Optional		Standard	Optional
HYDRAULIC SYSTEM			SERVICE AND MAINTENANCE		
Electronic main control valve	✓		Integrated vehicle health management system	✓	
Single type electronic pump	✓		Grouped engine oil and fuel filters	✓	
Boom and stick regeneration circuits	✓		Lockable disconnect switch	✓	
Automatic two-speed travel	✓		Ground level engine oil dipstick	✓	
Boom and stick drift reduction valve	✓		Scheduled Oil Sampling (S·O·S SM) ports	✓	
Swing drive, without fine swing control function	✓		UNDERCARRIAGE AND STRUCTURES		
Boom and stick lowering check valves		✓	500 mm (20") triple grouser track shoes		✓
Medium-pressure line		✓	500 mm (20") triple grouser track shoes with rubber pad		✓
High-pressure line		✓	500 mm (20") rubber shoes		✓
Quick coupler line		✓	600 mm (24") triple grouser track shoes		✓
SAFETY AND SECURITY			600 mm (24") rubber shoes		✓
Rear and right-side-view cameras	✓		700 mm (28") triple grouser track shoes ¹		✓
Ground level engine shutoff switch	✓		770 mm (30") triple grouser track shoes with additional steps ¹		✓
Service platform with anti-skid plate and countersunk bolts	✓		2500 mm (8'2") blade		✓
Signaling/warning horn	✓		2600 mm (8'6") blade		✓
Swing alarm		✓	2700 mm (8'10") blade		✓
Inspection lighting		✓	Grease lubricated track link	✓	
Auto Hammer Stop		✓	Center track guiding guards	✓	
			Travel motor guards	✓	
			Bottom guards	✓	
			3.83 mt (8,440 lb) counterweight	✓	
			Tie-down points on base frame	✓	

¹Europe only

Dealer Installed Kits and Attachments

Attachments may vary. Consult your Cat dealer for details.

CAB

- Radial lower wiper
- Left-hand and right-hand electrical pedal (two-way) for tool control
- Dual exit rear window kit
- Rain protector plus cab light cover
- Polycarbonate roof hatch
- Front windshield laminated glass (P5A glass, EU demolition regulation)
- Key fob (for use with Bluetooth receiver)

SAFETY AND SECURITY

- Bluetooth receiver
- 76 mm (3") retractable seat belt

GUARDS

- OPG (not compatible with cab light cover, rain protector)
- Mesh guard full front (not compatible with cab light cover, rain protector)
- Mesh guard lower half front
- Full protecting vandalism guard

OTHER

- Grease gun holder

315 GC Environmental Declaration

The following information applies to the machine at the time of final manufacture as configured for sale in the regions covered in this document. The content of this declaration is valid as of the date issued; however, content related to machine features and specifications are subject to change without notice. For additional information, please see the machine's Operation and Maintenance Manual.

For more information on sustainability in action and our progress, please visit <https://www.caterpillar.com/en/company/sustainability>.

Engine

- The Cat® C3.6 engine meets U.S. EPA Tier 4 Final, EU Stage V, and Japan 2014 emission standards.
- Cat diesel engines are required to use ULSD (ultra-low sulfur diesel fuel with 15 ppm of sulfur or less) or ULSD blended with the following lower-carbon intensity fuels** up to:
 - ✓ 20% biodiesel FAME (fatty acid methyl ester)*
 - ✓ 100% renewable diesel, HVO (hydrotreated vegetable oil) and GTL (gas-to-liquid) fuels

Refer to guidelines for successful application. Please consult your Cat dealer or “Caterpillar Machine Fluids Recommendations” (SEBU6250) for details.

**Engines with no aftertreatment devices can use higher blends, up to 100% biodiesel (for use of blends higher than 20% biodiesel, consult your Cat dealer).*

***Tailpipe greenhouse gas emissions from lower-carbon intensity fuels are essentially the same as traditional fuels.*

Air Conditioning System

- The air conditioning system on this machine contains the fluorinated greenhouse gas refrigerant R134a (Global Warming Potential = 1430). The system contains 0.8 kg (1.8 lb) of refrigerant which has a CO₂ equivalent of 1.144 metric tonnes (1.261 tons).

Paint

- Based on best available knowledge, the maximum allowable concentration, measured in parts per million (PPM), of the following heavy metals in paint are:
 - Barium < 0.01%
 - Cadmium < 0.01%
 - Chromium < 0.01%
 - Lead < 0.01%

Sound Performance

ISO 6395:2008 (external) 101 dB(A)

ISO 6396:2008 (inside cab) 71 dB(A)

- Hearing protection may be needed when operating with an open operator station and cab (when not properly maintained or doors/windows open) for extended periods or in a noisy environment.

Oils and Fluids

- Caterpillar factory fills with ethylene glycol coolants. Cat Diesel Engine Antifreeze/Coolant (DEAC) and Cat Extended Life Coolant (ELC) can be recycled. Consult your Cat dealer for more information.
- Cat Bio HYDO™ Advanced is an EU Ecolabel approved biodegradable hydraulic oil.
- Additional fluids are likely to be present, please consult the Operations and Maintenance Manual or the Application and Installation guide for complete fluid recommendations and maintenance intervals.

Features and Technology

- The following features and technology may contribute to fuel savings and/or carbon reduction. Features may vary. Consult your Cat dealer for details.
 - Advanced hydraulic systems balance power and efficiency
 - Smart mode matches machine power to digging requirements automatically
 - Eco mode minimizes fuel consumption for light applications
 - One-touch low idle with automatic engine speed control
 - Cat Grade with 2D improves operator efficiency by up to 45%
 - Cut maintenance costs up to 25% with extended and synchronized intervals
 - Remote Flash and Remote Troubleshoot

Recycling

- The materials included in machines are categorized as below with approximate weight percentage. Because of variations of product configurations, the following values in the table may vary.

Material Type	Weight Percentage
Steel	83.27%
Iron	5.01%
Nonferrous Metal	1.86%
Mixed Metal	0.37%
Mixed-Metal and Nonmetal	2.40%
Plastic	0.08%
Rubber	1.67%
Mixed Nonmetallic	1.45%
Fluid	2.40%
Other	1.49%
Uncategorized	0.00%
Total	100%

- A machine with higher recyclability rate will ensure more efficient usage of valuable natural resources and enhance End-of-Life value of the product. According to ISO 16714:2008 (Earthmoving machinery – Recyclability and recoverability – Terminology and calculation method), recyclability rate is defined as percentage by mass (mass fraction in percent) of the new machine potentially able to be recycled, reused or both.

All parts in the bill of material are first evaluated by component type based on a list of components defined by the ISO 16714:2008 and Japan CEMA (Construction Equipment Manufacturers Association) standards. Remaining parts are further evaluated for recyclability based on material type.

Because of variations of product configurations, the following value in the table may vary.

Recyclability – 95%

For more complete information on Cat products, dealer services, and industry solutions, visit us on the web at www.cat.com

© 2023 Caterpillar
All rights reserved

Materials and specifications are subject to change without notice. Featured machines in photos may include additional equipment. See your Cat dealer for available options.

CAT, CATERPILLAR, LET'S DO THE WORK, their respective logos, "Caterpillar Corporate Yellow," the "Power Edge" and Cat "Modern Hex" trade dress as well as corporate and product identity used herein, are trademarks of Caterpillar and may not be used without permission. VisionLink is a trademark of Caterpillar Inc., registered in the United States and in other countries.

AEXQ2918-05 (12-2023)
Replaces AEXQ2918-04
Build Number: 07E
(Eur, Aus-NZ)

