

Cat® 7.1

Diesel Generator Sets



Standby & Prime: 50 Hz



Image shown might not reflect actual configuration.

Engine Model	Cat® C7.1 Inline 4-stroke Diesel
Bore x Stroke	105.0 mm x 135.0 mm (4.1 in x 5.3 in)
Displacement	7.0 L (427.8 in³)
Compression Ratio	16.8:1
Aspiration	Turbocharged Air To Air Charge Cooled
Fuel Injection System	Inline
Governor	Electronic

Model	Standby	Prime	Emission Strategy
DE165E3	50 Hz	50 Hz	EU IIIA
	165.0 kVA (132.0 kW)	150.0 kVA (120.0 kW)	

PACKAGE PERFORMANCE

Performance	Standby	Prime
Frequency	50 Hz	50 Hz
Genset Power Rating	165.0 kVA	150.0 kVA
Genset power rating with fan @ 0.8 power factor	132.0 kW	120.0 kW
Emissions	EU IIIA	
Performance Number	P4392B	
Fuel Consumption		
Fuel Tank Capacity, litres (US gal)	349 (92.2)	
100% load with fan, L/hr (gal/hr)	37.8 (10.0)	35.2 (9.3)
75% load with fan, L/hr (gal/hr)	30.3 (8.0)	28.1 (7.4)
50% load with fan, L/hr (gal/hr)	21.6 (5.7)	19.9 (5.3)
Cooling System¹		
Radiator air flow, m³/min (cfm)	276.0 (9747)	
Total coolant capacity, L (gal)	21.0 (5.5)	
Inlet Air		
Max. Combustion Air Intake Restriction, kPa (in H ₂ O)	8.0 (32.1)	
Combustion air inlet flow rate, m³/min (cfm)	11.0 (388)	10.6 (374)
Max. Allowable Combustion Air Inlet Temp, °C (°F)	50 (122)	
Exhaust System		
Exhaust stack gas temperature, °C (°F)	513 (955)	
Exhaust gas flow rate, m³/min (cfm)	25.0 (883)	24.0 (848)
Exhaust system backpressure (maximum allowable), kPa (in H ₂ O)	15.0 (4.4)	
Heat Rejection		
Heat rejection to jacket water, kW (Btu/min)	72.5 (4123)	64.0 (3640)
Heat rejection to alternator, kW (Btu/min)	10.2 (580)	
Heat rejection to atmosphere from engine, kW (Btu/min)	35.6 (2025)	32.9 (1871)

Alternator ³	50 Hz		
	Voltages	415V	400V
Motor starting capability @ 30% Voltage Dip, skVA	233	219	199
Current, amps	230	238	251
Temperature Rise, °C	125/40		
Frame Size	M2256L4		
Excitation	S.E		

WEIGHTS & DIMENSIONS

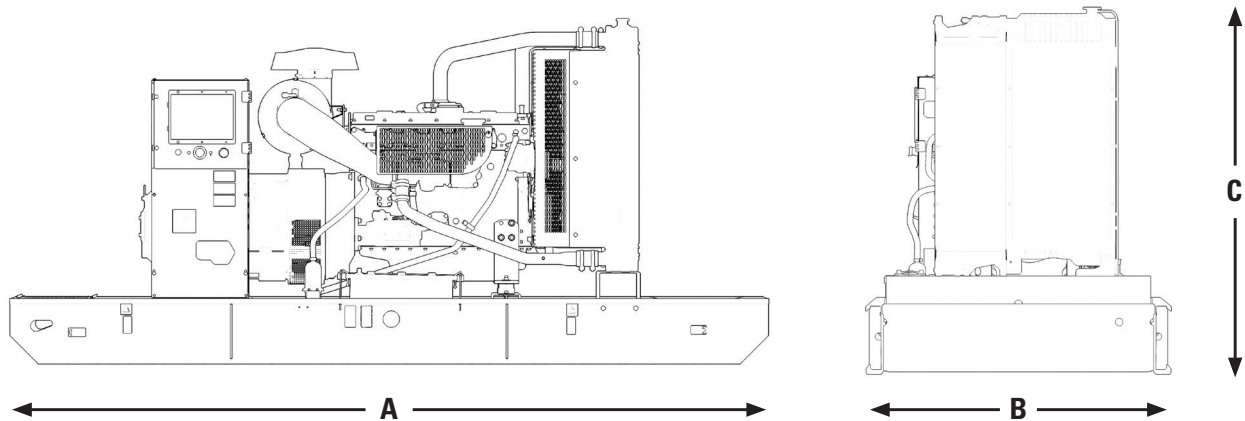

Dim "A" mm (in)	Dim "B" mm (in)	Dim "C" mm (in)	Dry Weight kg (lb)
2450 (96.5)	1010 (39.8)	1554 (61.2)	1493 (3291)

Note: General configuration not to be used for installation. See general dimension drawings for detail.

APPLICABLE CODES AND STANDARDS:

AS1359, NFPA37, NFPA70, NFPA99, NFPA110, IBC, IEC60034-1, ISO3046, ISO8528, NEMA MG1-22, NEMA MG1-33, 2006/95/EC, 2006/42/EC, 2004/108/EC.

Note: Codes may not be available in all model configurations. Please consult your local Cat Dealer representative for availability.

STANDBY: Output available with varying load for the duration of the interruption of the normal source power. Average power output is 70% of the standby power rating. Typical operation is 200 hours per year, with maximum expected usage of 500 hours per year.

PRIME: Output available with varying load for an unlimited time. Average power output is 70% of the prime power rating. Typical peak demand is 100% of prime rated kW with 10% overload capability for emergency use for a maximum of 1 hour in 12. Overload operation cannot exceed 25 hours per year

RATINGS: Ratings are based on SAE J1349 standard conditions. These ratings also apply at ISO3046 standard conditions.

DEFINITIONS AND CONDITIONS

- ¹ For ambient and altitude capabilities consult your Cat dealer. Air flow restriction (system) is added to existing restriction from factory.
- ² Emissions data measurement procedures are consistent with those described in EPA CFR 40 Part 89, Subpart D & E and ISO8178-1 for measuring HC, CO, PM, NOx. Data shown is based on steady state operating conditions of 77°F, 28.42 in HG and number 2 diesel fuel with 35° API and LHV of 18,390 BTU/lb. The nominal emissions data shown is subject to instrumentation, measurement, facility and engine to engine variations. Emissions data is based on 100% load and thus cannot be used to compare to EPA regulations which use values based on a weighted cycle.
- ³ Generator temperature rise is based on a 40°C ambient per NEMA MG1-32.

www.cat.com/electricpower
©2022 Caterpillar
All rights reserved.

LET'S DO THE WORK.™

LEHE2645-02 (03/22)

Materials and specifications are subject to change without notice. The International System of Units (SI) is used in this publication. CAT, CATERPILLAR, LET'S DO THE WORK, their respective logos, "Caterpillar Corporate Yellow", the "Power Edge" and Cat "Modern Hex" trade dress as well as corporate and product identity used herein, are trademarks of Caterpillar and may not be used without permission.