



374

Hydraulic Excavator

Technical Specifications

Configurations and features may vary by region. Please consult your Cat® dealer for availability in your area.

Table of Contents

Specifications	2
Engine	2
Swing Mechanism	2
Weights	2
Track	2
Drive	2
Hydraulic System	2
Service Refill Capacity	2
Standards	2
Sound Performance	2
Operating Weights and Ground Pressures	3
Major Component Weights	4
Dimensions	5
Working Ranges and Forces	9
Reach Boom Lift Capacities	11
Mass Boom Lift Capacities	23
Bucket Specifications and Compatibility:	
Australia and New Zealand	26
Chile	27
North America	28
South Korea	29
Turkey	30
Typical Pass Match Guide	31
Attachments Offering Guide:	
Australia and New Zealand	32
Chile	33
North America	34
Turkey	36
Standard and Optional Equipment	37
Dealer Installed Kits and Attachments	39
Cab Options	40
374 Environmental Declaration	41

374 Hydraulic Excavator Specifications

Engine

Engine Model	Cat® C15	
Net Power – ISO 9249	361 kW	484 HP
Engine Power – ISO 14396	362 kW	485 HP
Bore	137 mm	5.39 in
Stroke	171 mm	6.73 in
Displacement	15.2 L	928 in ³

- Meets U.S. EPA Tier 4 Final, EU Stage V, Korea Stage V, and Japan 2014 emission standards.
- Recommended for use up to 4500 m (14,760 ft) altitude with engine power derate above 3000 m (9,840 ft).
- Advertised power is tested per the specified standard in effect at the time of manufacture.
- Net power advertised is the power available at the flywheel when the engine is equipped with fan, air intake system, exhaust system and alternator.
- Engine speed at 1,700 rpm.
- Cat diesel engines are required to use ULSD (ultra-low sulfur diesel fuel with 15 ppm of sulfur or less) or ULSD blended with the following lower-carbon intensity fuels** up to:
 - ✓ 20% biodiesel FAME (fatty acid methyl ester)*
 - ✓ 100% renewable diesel, HVO (hydrotreated vegetable oil) and GTL (gas-to-liquid) fuels

Refer to guidelines for successful application. Please consult your Cat dealer or “Caterpillar Machine Fluids Recommendations” (SEBU6250) for details.

**Engines with no aftertreatment devices can use higher blends, up to 100% biodiesel (for use of blends higher than 20% biodiesel, consult your Cat dealer).*

***Tailpipe greenhouse gas emissions from lower-carbon intensity fuels are essentially the same as traditional fuels.*

Swing Mechanism

Swing Speed	6.34 rpm	
Maximum Swing Torque	247 kN·m	182,000 lbf·ft

Weights

Operating Weight	73 900 kg	162,900 lb
------------------	-----------	------------

- Long Variable Gauge undercarriage, Reach boom, R4.67VB (15'4") stick, SD 3.3 m³ (4.32 yd³) bucket, 900 mm (35") HD double grouser shoes and removal type counterweight.

Operating Weight	74 700 kg	164,700 lb
------------------	-----------	------------

- Long Variable Gauge undercarriage, Mass boom, M2.57WB (8'5") stick, XD 4.4 m³ (5.75 yd³) bucket, 650 mm (26") HD double grouser shoes and standard counterweight.

Track

Optional Track Shoes Width	650 mm	26 in
Optional Track Shoes Width	750 mm	30 in
Optional Track Shoes Width	900 mm	35 in
Number of Shoes (each side)	47	
Number of Track Rollers (each side)	8	
Number of Carrier Rollers (each side)	3	

Drive

Maximum Gradeability	35°/70%	
Maximum Travel Speed	4.1 km/h	2.5 mph
Maximum Drawbar Pull	491 kN	110,359 lbf

Hydraulic System

Main System – Maximum Flow – Implement	896 L/min (× 2 pumps)	237 gal/min (× 2 pumps)
Swing System – Maximum Flow	247 L/min	65 gal/min
Maximum Pressure – Equipment – Implement	37 000 kPa	5,366 psi
Maximum Pressure – Equipment – Lift Mode	38 000 kPa	5,511 psi
Maximum Pressure – Travel	35 000 kPa	5,076 psi
Maximum Pressure – Swing	35 000 kPa	5,076 psi
Boom Cylinder – Bore	190 mm	7 in
Boom Cylinder – Stroke	1792 mm	71 in
Stick Cylinder – Bore	210 mm	8 in
Stick Cylinder – Stroke	2118 mm	83 in
VB Bucket Cylinder – Bore	190 mm	7 in
VB Bucket Cylinder – Stroke	1433 mm	56 in
WB Bucket Cylinder – Bore	200 mm	8 in
WB Bucket Cylinder – Stroke	1457 mm	57 in

Service Refill Capacity

Fuel Tank Capacity	920 L	243 gal
Cooling System	71 L	19 gal
Engine Oil (with filter)	62 L	16 gal
Swing Drive	20 L	5 gal
Final Drive (each)	32 L	9 gal
Hydraulic System (including tank)	620 L	164 gal
Hydraulic Tank (including suction pipe)	326 L	86 gal
Diesel Exhaust Fluid (DEF) Tank	80 L	21 gal

Standards

Brakes	ISO 10265:2008
Cab/Operator Protective Guards (OPG) (optional)	ISO 10262:1998 Level II
Cab/Rollover Protective Structure (ROPS)	ISO 12117-2:2008

Sound Performance

ISO 6395:2008 (external)	108 dB(A)
ISO 6396:2008 (inside cab)	73 dB(A)

- Hearing protection may be needed when operating with an open operator station and cab (when not properly maintained or doors/windows open) for extended periods or in a noisy environment.

374 Hydraulic Excavator Specifications

Operating Weights and Ground Pressures

	650 mm (26") HD Double Grouser Shoes		750 mm (30") HD Double Grouser Shoes		900 mm (35") HD Double Grouser Shoes	
	Weight	Ground Pressure	Weight	Ground Pressure	Weight	Ground Pressure
	kg (lb)	kPa (psi)	kg (lb)	kPa (psi)	kg (lb)	kPa (psi)
Base Machine Configurations						
Base Frame with Track Rollers and Carrier Rollers						
Standard Counterweight + Long Variable Gauge Undercarriage Base Machine						
Reach Boom + R4.67VB (15'4") Stick + 3.30 m ³ (4.32 yd ³) SD bucket	72 100 (159,000)	106 (15)	72 800 (160,500)	93 (13)	73 800 (162,700)	79 (11)
Reach Boom + R4.15VB (13'7") Stick + 3.30 m ³ (4.32 yd ³) SD bucket	72 000 (158,700)	106 (15)	72 700 (160,200)	93 (13)	73 700 (162,500)	79 (11)
Reach Boom + R3.60VB (11'10") Stick + 3.30 m ³ (4.32 yd ³) SD bucket	71 700 (158,200)	106 (15)	72 400 (159,700)	93 (13)	73 400 (161,900)	78 (11)
Reach Boom + R2.84VB (9'4") Stick + 3.30 m ³ (4.32 yd ³) SD bucket	71 600 (157,800)	106 (15)	72 300 (159,300)	92 (13)	73 300 (161,600)	78 (11)
Mass Boom + M2.57WB (8'5") Stick + 4.40 m ³ (5.75 yd ³) XD bucket	74 700 (164,700)	110 (16)	75 400 (166,100)	96 (14)	76 400 (168,400)	81 (12)
Base Frame with Track Rollers and Carrier Rollers						
Removal Type Counterweight + Long Variable Gauge Long Undercarriage Base Machine						
Reach Boom + R4.67VB (15'4") Stick + 3.30 m ³ (4.32 yd ³) SD bucket	72 200 (159,200)	107 (15)	72 900 (160,600)	93 (14)	73 900 (162,900)	79 (11)
Reach Boom + R4.15VB (13'7") Stick + 3.30 m ³ (4.32 yd ³) SD bucket	72 100 (158,900)	106 (15)	72 700 (160,400)	93 (13)	73 800 (162,600)	79 (11)
Reach Boom + R3.60VB (11'10") Stick + 3.30 m ³ (4.32 yd ³) SD bucket	71 800 (158,300)	106 (15)	72 500 (159,800)	93 (13)	73 500 (162,000)	78 (11)
Reach Boom + R2.84VB (9'4") Stick + 3.30 m ³ (4.32 yd ³) SD bucket	71 700 (158,000)	106 (15)	72 300 (159,500)	92 (13)	73 300 (161,700)	78 (11)
Mass Boom + M2.57WB (8'5") Stick + 4.40 m ³ (5.75 yd ³) XD bucket	74 800 (164,800)	110 (16)	75 400 (166,300)	96 (14)	76 400 (168,500)	81 (12)

All operating weights include a 90% fuel tank with 75 kg (165 lb) operator.

374 Hydraulic Excavator Specifications

Major Component Weights

	kg	lb
Base Machine Weight: including upperframe, undercarriage, counterweight, boom cylinders, without boom, stick, bucket, stick cylinder, bucket cylinder, tracks, counterweight removal device, without fuel 612 kg (1,349 lb), operator 75 kg (165 lb), with hydraulic oil 184 kg (406 lb), diesel exhaust fluid 49 kg (108 lb)		
With Standard Counterweight, Swing Frame and Base Frame*	48 030	105,880
With Removal Type Counterweight, Swing Frame and Base Frame*	48 090	106,020
Track Shoes:		
650 mm (26") HD Double Grouser Track Shoes*	8220	18,110
750 mm (30") HD Double Grouser Track Shoes*	8890	19,600
900 mm (35") HD Double Grouser Track Shoes*	9900	21,840
Two Boom Cylinders	2790	6,160
Weight of 90% Fuel Tank and 75 kg (165 lb) Operator	860	1,880
Counterweight:		
Standard Counterweight	11 240	24,770
Counterweight with Removal Device*	11 300	24,910
Swing Frame:		
Standard Swing Frame	6450	14,210
Long Variable Gauge:		
Base Frame with Double Flange Track Rollers and Carrier Rollers	18 850	41,560
Booms (including lines, pins, stick cylinder):		
Reach Boom 7.8 m (25'7")	6960	15,330
Mass Boom 7.0 m (23'0")	7510	16,560
Sticks (including lines, pins, bucket cylinder, bucket linkage):		
Reach Stick R4.67VB (15'4")*	4140	9,120
Reach Stick R4.15VB (13'7")*	4010	8,840
Reach Stick R3.60VB (11'10")*	3760	8,280
Reach Stick R2.84VB (9'4")*	3600	7,940
Mass Stick M2.57WB (8'5")	4130	9,110
Mass Stick M3.00WB (9'10")	4400	9,710
Buckets (without linkage):		
3.30 m ³ (4.32 yd ³) Severe Duty for VB*	3940	8,680
4.40 m ³ (5.75 yd ³) Extreme Duty for WB	5950	13,110
Quick Couplers:		
CW Dedicated Quick Coupler for VB*	1020	2,260
CW Dedicated Quick Coupler for WB	1080	2,370
Pin Grabber Quick Coupler	1510	3,320

*Depending on regional offering.

374 Hydraulic Excavator Specifications

Dimensions

All dimensions are approximate and may vary depending on bucket selection.

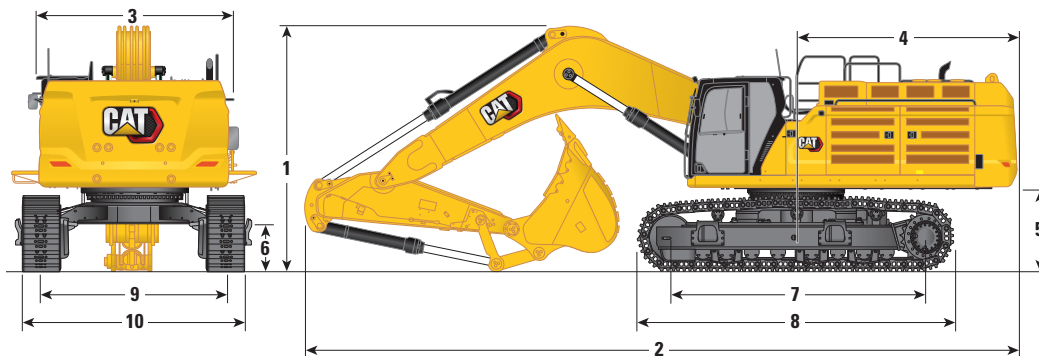

Boom Options

Reach Boom
7.8 m (25'7")

Stick Options

Reach Stick

	R4.67VB (15'4")		R4.15VB (13'7")		R3.60VB (11'10")		R2.84VB (9'4")	
1 Machine Height:								
Cab Height	3559 mm	11'8"	3559 mm	11'8"	3559 mm	11'8"	3559 mm	11'8"
OPG Height	3702 mm	12'1"	3702 mm	12'1"	3702 mm	12'1"	3702 mm	12'1"
Handrails Height	3982 mm	13'0"	3982 mm	13'0"	3982 mm	13'0"	3982 mm	13'0"
With Boom/Stick/Bucket Installed	5052 mm	16'6"	4655 mm	15'3"	4519 mm	14'9"	4292 mm	14'0"
With Boom/Stick Installed	4698 mm	15'4"	4444 mm	14'6"	4287 mm	14'0"	4063 mm	13'3"
With Boom Installed	3896 mm	12'9"	3896 mm	12'9"	3896 mm	12'9"	3896 mm	12'9"
With Boom/Stick/Bucket Installed (with auxiliary lines)	5086 mm	16'8"	4691 mm	15'4"	4555 mm	14'11"	4324 mm	14'2"
With Boom/Stick Installed (with auxiliary lines)	4735 mm	15'6"	4480 mm	14'8"	4319 mm	14'2"	4086 mm	13'4"
With Boom Installed (with auxiliary lines)	4033 mm	13'2"	4033 mm	13'2"	4033 mm	13'2"	4033 mm	13'2"
2 Machine Length:								
With Boom/Stick/Bucket Installed	13 553 mm	44'5"	13 549 mm	44'5"	13 652 mm	44'9"	13 596 mm	44'7"
With Boom/Stick Installed	13 654 mm	44'9"	13 550 mm	44'5"	13 625 mm	44'8"	13 511 mm	44'3"
With Boom Installed	11 855 mm	38'10"	11 855 mm	38'10"	11 855 mm	38'10"	11 855 mm	38'10"
With Boom/Stick/Bucket Installed (with auxiliary lines)	13 553 mm	44'5"	13 549 mm	44'5"	13 652 mm	44'9"	11 596 mm	38'0"
With Boom/Stick Installed (with auxiliary lines)	13 654 mm	44'9"	13 550 mm	44'5"	13 625 mm	44'8"	13 511 mm	44'3"
With Boom Installed (with auxiliary lines)	11 855 mm	38'10"	11 855 mm	38'10"	11 855 mm	38'10"	11 056 mm	36'3"
3 Upperframe Width:								
Without Walkways	3490 mm	11'5"	3490 mm	11'5"	3490 mm	11'5"	3490 mm	11'5"
With Walkways	4508 mm	14'9"	4508 mm	14'9"	4508 mm	14'9"	4508 mm	14'9"
Walkways Width	500 mm	1'7"	500 mm	1'7"	500 mm	1'7"	500 mm	1'7"
4 Tail Swing Radius	4171 mm	13'8"	4171 mm	13'8"	4171 mm	13'8"	4171 mm	13'8"
5 Counterweight Clearance (without shoe lug)	1494 mm	4'10"	1494 mm	4'10"	1494 mm	4'10"	1494 mm	4'10"
6 Ground Clearance (without shoe lug)	782 mm	2'6"	782 mm	2'6"	782 mm	2'6"	782 mm	2'6"

(continued on next page)

374 Hydraulic Excavator Specifications

Dimensions (continued)

All dimensions are approximate and may vary depending on bucket selection.

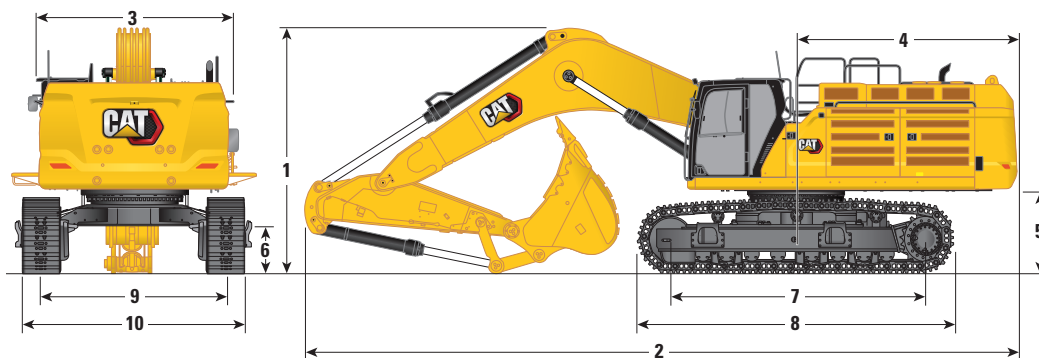

Boom Options

Reach Boom
7.8 m (25'7")

Stick Options

Reach Stick

	R4.67VB (15'4")		R4.15VB (13'7")		R3.60VB (11'10")		R2.84VB (9'4")	
7 Length to Center of Rollers	4705 mm	15'5"	4705 mm	15'5"	4705 mm	15'5"	4705 mm	15'5"
8 Track Length with Double Grouser Shoes	5873 mm	19'3"	5873 mm	19'3"	5873 mm	19'3"	5873 mm	19'3"
9 Track Gauge:								
Retracted with Double Grouser Shoes	2750 mm	9'0"	2750 mm	9'0"	2750 mm	9'0"	2750 mm	9'0"
Extended with Double Grouser Shoes	3410 mm	11'2"	3410 mm	11'2"	3410 mm	11'2"	3410 mm	11'2"
10 Undercarriage Width – Retracted (without steps):								
650 mm (26") Shoes	3400 mm	11'1"	3400 mm	11'1"	3400 mm	11'1"	3400 mm	11'1"
750 mm (30") Shoes	3500 mm	11'5"	3500 mm	11'5"	3500 mm	11'5"	3500 mm	11'5"
900 mm (35") Shoes	3650 mm	11'11"	3650 mm	11'11"	3650 mm	11'11"	3650 mm	11'11"
Undercarriage Width – Retracted (with steps):								
650 mm (26") Shoes	3678 mm	12'0"	3678 mm	12'0"	3678 mm	12'0"	3678 mm	12'0"
750 mm (30") Shoes	3678 mm	12'0"	3678 mm	12'0"	3678 mm	12'0"	3678 mm	12'0"
900 mm (35") Shoes	3678 mm	12'0"	3678 mm	12'0"	3678 mm	12'0"	3678 mm	12'0"
Undercarriage Width – Extended (without steps):								
650 mm (26") Shoes	4060 mm	13'3"	4060 mm	13'3"	4060 mm	13'3"	4060 mm	13'3"
750 mm (30") Shoes	4160 mm	13'7"	4160 mm	13'7"	4160 mm	13'7"	4160 mm	13'7"
900 mm (35") Shoes	4310 mm	14'1"	4310 mm	14'1"	4310 mm	14'1"	4310 mm	14'1"
Undercarriage Width – Extended (with steps):								
650 mm (26") Shoes	4338 mm	14'2"	4338 mm	14'2"	4338 mm	14'2"	4338 mm	14'2"
750 mm (30") Shoes	4338 mm	14'2"	4338 mm	14'2"	4338 mm	14'2"	4338 mm	14'2"
900 mm (35") Shoes	4338 mm	14'2"	4338 mm	14'2"	4338 mm	14'2"	4338 mm	14'2"
Bucket Type	SD		SD		SD		SD	
Bucket Capacity	3.30 m ³	4.32 yd ³	3.30 m ³	4.32 yd ³	3.30 m ³	4.32 yd ³	3.30 m ³	4.32 yd ³
Bucket Tip Radius	2240 mm	7'4"	2240 mm	7'4"	2240 mm	7'4"	2240 mm	7'4"

(continued on next page)

374 Hydraulic Excavator Specifications

Dimensions (continued)

All dimensions are approximate and may vary depending on bucket selection.

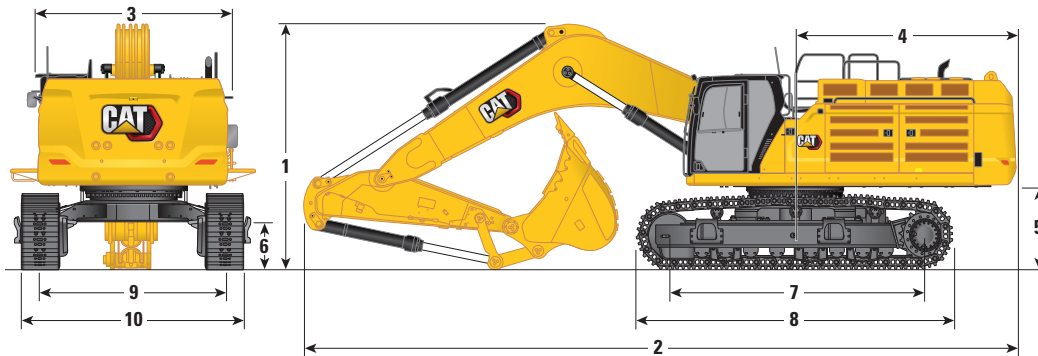

Boom Options

Mass Boom
7.0 m (23'0")

Stick Options

Mass Stick
M2.57WB (8'5")

1 Machine Height:

Cab Height	3559 mm	11'8"
OPG Height	3702 mm	12'1"
Handrail Height	3982 mm	13'0"
With Boom/Stick/Bucket Installed	4927 mm	16'1"
With Boom/Stick Installed	4368 mm	14'3"
With Boom Installed	3896 mm	12'9"
With Boom/Stick/Bucket Installed (with auxiliary lines)	4942 mm	16'2"
With Boom/Stick Installed (with auxiliary lines)	4403 mm	14'5"
With Boom Installed (with auxiliary lines)	4033 mm	13'2"

2 Machine Length:

With Boom/Stick/Bucket Installed	12 978 mm	42'6"
With Boom/Stick Installed	12 719 mm	41'8"
With Boom Installed	11 011 mm	36'1"
With Boom/Stick/Bucket Installed (with auxiliary lines)	12 978 mm	42'6"
With Boom/Stick Installed (with auxiliary lines)	12 719 mm	41'8"
With Boom Installed (with auxiliary lines)	11 056 mm	36'3"

3 Upperframe Width:

Without Walkways	3490 mm	11'5"
With Walkways	4508 mm	14'9"
Walkways Width	536 mm	1'9"

4 Tail Swing Radius

4171 mm 13'8"

5 Counterweight Clearance (without shoe lug)

1494 mm 4'10"

6 Ground Clearance (without shoe lug)

782 mm 2'6"

(continued on next page)

374 Hydraulic Excavator Specifications

Dimensions *(continued)*

All dimensions are approximate and may vary depending on bucket selection.

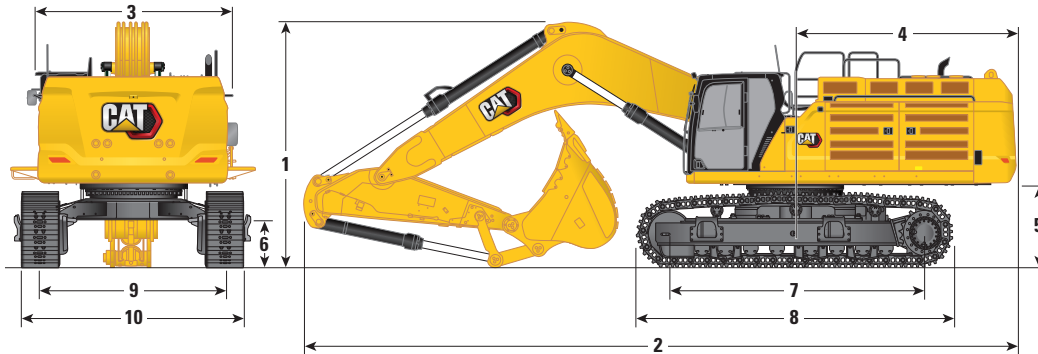

Boom Options	Mass Boom 7.0 m (23'0")	
Stick Options	Mass Stick M2.57WB (8'5")	
7 Length to Center of Rollers	4705 mm	15'5"
8 Track Length with Double Grouser Shoes	5873 mm	19'3"
9 Track Gauge:		
Retracted with Double Grouser Shoes	2750 mm	9'0"
Extended with Double Grouser Shoes	3410 mm	11'2"
10 Undercarriage Width – Retracted (without steps):		
650 mm (26") Shoes	3400 mm	11'1"
750 mm (30") Shoes	3500 mm	11'5"
900 mm (35") Shoes	3650 mm	11'11"
Undercarriage Width – Retracted (with steps):		
650 mm (26") Shoes	3678 mm	12'0"
750 mm (30") Shoes	3678 mm	12'0"
900 mm (35") Shoes	3678 mm	12'0"
Undercarriage Width – Extended (without steps):		
650 mm (26") Shoes	4060 mm	13'3"
750 mm (30") Shoes	4160 mm	13'7"
900 mm (35") Shoes	4310 mm	14'1"
Undercarriage Width – Extended (with steps):		
650 mm (26") Shoes	4338 mm	14'2"
750 mm (30") Shoes	4338 mm	14'2"
900 mm (35") Shoes	4338 mm	14'2"
Bucket Type	XD	
Bucket Capacity	4.40 m ³	5.75 yd ³
Bucket Tip Radius	2310 mm	7'6"

(continued on next page)

374 Hydraulic Excavator Specifications

Working Ranges and Forces

All dimensions are approximate and may vary depending on bucket selection.

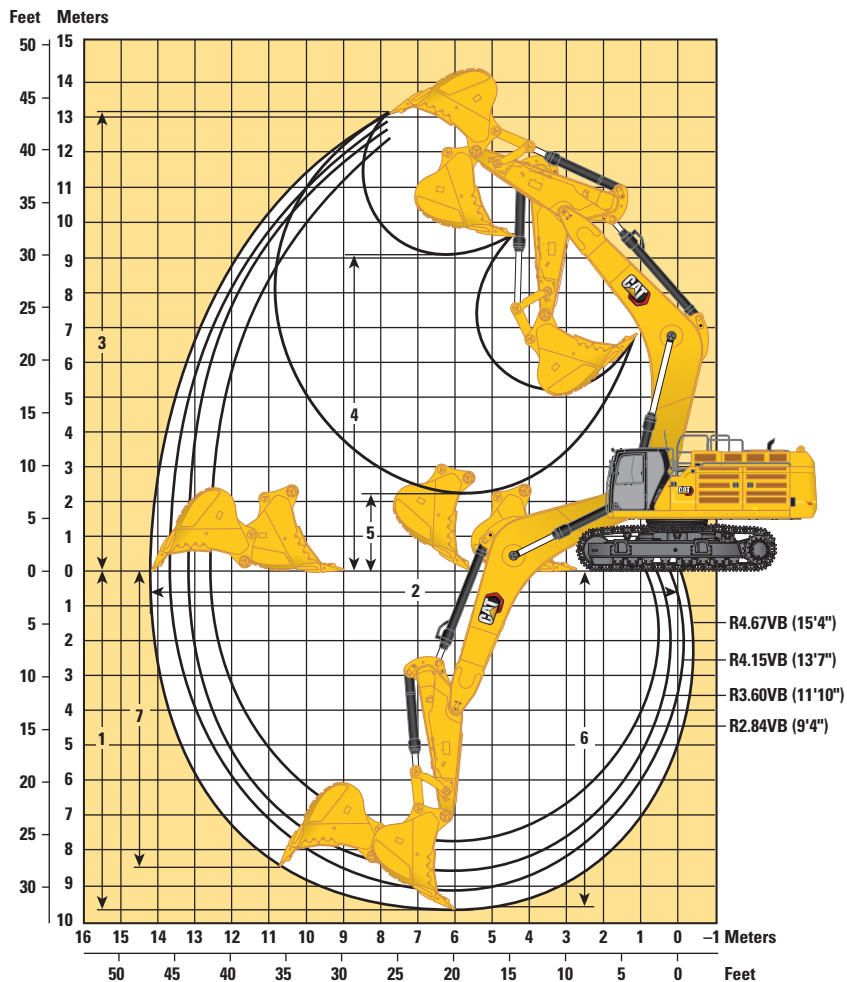

Boom Options

Reach Boom
7.8 m (25'7")

Stick Options

Reach Stick

	R4.67VB (15'4")		R4.15VB (13'7")		R3.60VB (11'10")		R2.84VB (9'4")	
1 Maximum Digging Depth	9640 mm	31'7"	9120 mm	29'11"	8570 mm	28'1"	7810 mm	25'7"
2 Maximum Reach at Ground Line	14 220 mm	46'7"	13 680 mm	44'10"	13 160 mm	43'2"	12 520 mm	41'0"
3 Maximum Cutting Height	13 210 mm	43'4"	12 810 mm	42'0"	12 550 mm	41'2"	12 440 mm	40'9"
4 Maximum Loading Height	9010 mm	29'6"	8660 mm	28'4"	8430 mm	27'7"	8260 mm	27'1"
5 Minimum Loading Height	2250 mm	7'4"	2760 mm	9'0"	3310 mm	10'10"	4070 mm	13'4"
6 Maximum Depth Cut for 2440 mm (8'0") Level Bottom	9530 mm	31'3"	9000 mm	29'6"	8440 mm	27'8"	7660 mm	25'1"
7 Maximum Vertical Wall Digging Depth	8300 mm	27'2"	7610 mm	24'11"	6910 mm	22'8"	6450 mm	21'1"
Bucket Digging Force (ISO)	359 kN	80,720 lbf	359 kN	80,720 lbf	358 kN	80,550 lbf	356 kN	80,110 lbf
Stick Digging Force (ISO)	247 kN	55,630 lbf	268 kN	60,350 lbf	295 kN	66,390 lbf	330 kN	74,190 lbf
Bucket Type	SD		SD		SD		SD	
Bucket Capacity	3.30 m ³	4.32 yd ³	3.30 m ³	4.32 yd ³	3.30 m ³	4.32 yd ³	3.30 m ³	4.32 yd ³
Bucket Tip Radius	2240 mm	7'4"	2240 mm	7'4"	2240 mm	7'4"	2240 mm	7'4"

(continued on next page)

374 Hydraulic Excavator Specifications

Working Ranges and Forces *(continued)*

All dimensions are approximate and may vary depending on bucket selection.

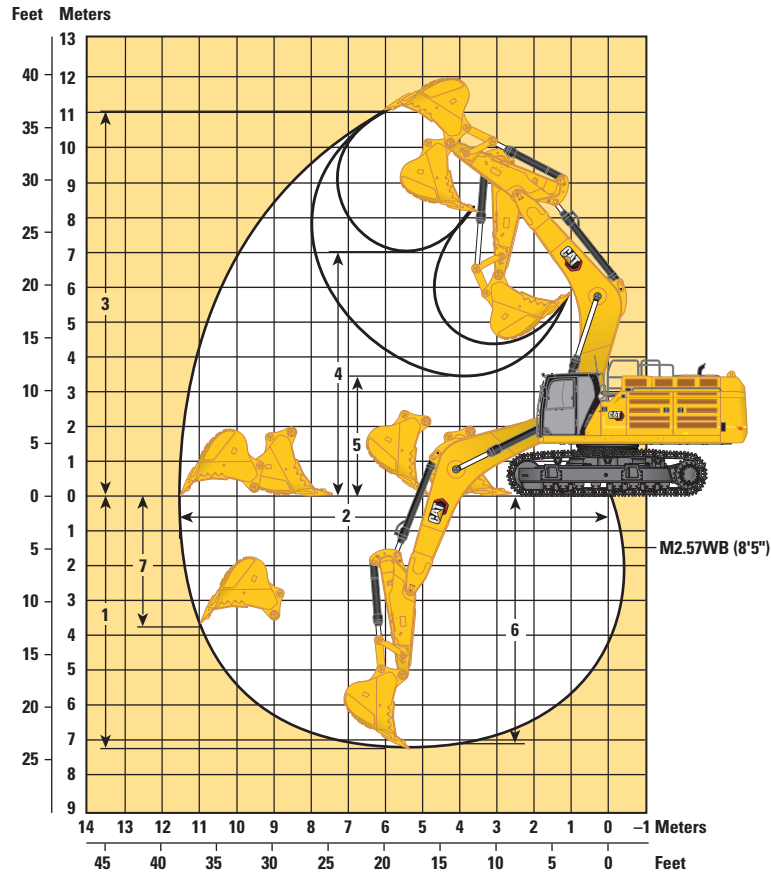

Boom Options

**Mass Boom
7.0 m (23'0")**

Stick Options

**Mass Stick
M2.57WB (8'5")**

1 Maximum Digging Depth	7240 mm	23'9"
2 Maximum Reach at Ground Line	11 460 mm	37'7"
3 Maximum Cutting Height	11 000 mm	36'1"
4 Maximum Loading Height	7050 mm	23'1"
5 Minimum Loading Height	3470 mm	11'4"
6 Maximum Depth Cut for 2440 mm (8'0") Level Bottom	7080 mm	23'2"
7 Maximum Vertical Wall Digging Depth	3620 mm	11'10"
Bucket Digging Force (ISO)	406 kN	91,230 lbf
Stick Digging Force (ISO)	352 kN	79,130 lbf
Bucket Type	XD	
Bucket Capacity	4.40 m ³	5.75 yd ³
Bucket Tip Radius	2310 mm	7'6"

374 Hydraulic Excavator Specifications

Reach Boom Lift Capacities – Standard Counterweight** – without Bucket, Heavy Lift: On

Long Variable Gauge Undercarriage

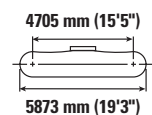
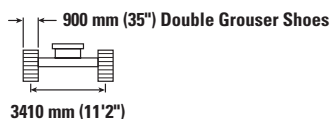
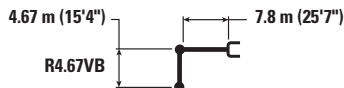

Reach Boom Length	Unit	1500 mm/5'0"		3000 mm/10'0"		4500 mm/15'0"		6000 mm/20'0"		7500 mm/25'0"		9000 mm/30'0"		10 500 mm/35'0"		12 000 mm/40'0"		mm ft/in																
		kg	lb	kg	lb	kg	lb	kg	lb	kg	lb	kg	lb	kg	lb	kg	lb																	
10 500 mm 35'0"	kg lb																	*11 750 *26,150	*11 750 *26,150	9210 29'8"														
9000 mm 30'0"	kg lb																	*11 100 *24,550	*11 100 *24,550	10 330 33'6"														
7500 mm 25'0"	kg lb																	*14 000 *30,600	*14 000 *30,600	*13 450 29,900	11 900 25,500	*10 800 *23,850	10 650 23,700	11 140 36'4"										
6000 mm 20'0"	kg lb																	*14 800 *32,200	*14 800 *32,200	*13 800 *30,150	11 700 25,150	*10 750 *23,700	9650 21,350	11 700 38'3"										
4500 mm 15'0"	kg lb																	*29 050 *63,300	*29 050 *63,300	*21 950 *47,300	*21 950 *47,300	*18 200 *39,350	*18 200 *39,350	*15 900 *34,500	14 600 31,400	*14 350 *31,300	11 400 24,500	*11 350 *24,000	9050 19,900	9000 19,900	12 050 39'5"			
3000 mm 10'0"	kg lb																	*25 350 *54,650	*25 350 *54,650	*20 150 *43,550	18 350 39,600	*17 050 *36,950	14 000 30,100	*15 000 32,550	11 050 23,750	12 250 *24,850	8900 19,100	*11 300 *24,800	8650 19,100	12 200 40'0"				
1500 mm 5'0"	kg lb																	*27 900 *60,300	24 150 52,050	*21 750 *47,050	17 500 37,650	*18 050 *39,100	13 450 28,900	14 800 31,800	10 700 23,000	12 050	8700	11 850 26,050	8550 18,800	12 160 39'10"				
0 mm 0'0"	kg lb																	*18 800 *43,450	*18 800 *43,450	*29 150 *63,100	23 250 50,000	*22 750 *49,250	16 850 36,250	18 200 39,150	13 000 28,000	14 500 31,200	10 450 22,450	12 050 26,500	8650 19,100	11 930 39'1"				
-1500 mm -5'0"	kg lb																	*13 650 *30,750	*13 650 *30,750	*24 700 *56,550	*24 700 *56,550	*29 100 *63,050	22 800 49,000	*22 900 *49,650	16 450 35,400	17 900 38,500	12 750 27,400	14 350 30,850	10 250 22,100	12 650 27,850	9100 20,000	11 500 37'8"		
-3000 mm -10'0"	kg lb																	*16 750 *37,450	*16 750 *37,450	*21 450 *48,400	*21 450 *48,400	*33 500 *76,550	*33 500 *76,550	*27 800 *60,250	22 700 48,800	*22 150 *47,900	16 300 35,150	17 800 38,300	12 650 27,250	14 350 30,900	10 250 22,150	13 750 *30,300	9850 21,800	10 850 35'5"
-4500 mm -15'0"	kg lb																	*30 900 *70,000	*30 900 *70,000	*32 050 *69,200	*32 050 *69,200	*25 200 *54,400	22 900 49,300	*20 200 *43,500	16 450 35,400	*16 150 *34,450	12 750 27,550					*13 550 *29,800	11 300 25,050	9920 32'4"
-6000 mm -20'0"	kg lb																	*32 750 *70,050	*32 750 *70,050	*25 950 *55,500	*25 950 *55,500	*20 800 *44,350	*20 800 *44,350	*16 400 *34,550	*16 400 *34,550							*12 800 *28,000	*12 800 *28,000	8640 27'11"



ISO 10567:2007



*Indicates that the load is limited by hydraulic lifting capacity rather than tipping load. The above loads are in compliance with hydraulic excavator lift capacity standard ISO 10567:2007. They do not exceed 87% of hydraulic lifting capacity or 75% of tipping load. Weight of all lifting accessories must be deducted from the above lifting capacities. Lifting capacities are based on the machine standing on a firm, uniform supporting surface. The use of a work tool attachment point to handle/lift objects, could affect the machine lift performance.

**Lift capacities apply to both standard counterweight and counterweight with removal device.

Lift capacity stays with ±5% for all available track shoes.

Always refer to the appropriate Operation and Maintenance Manual for specific product information.

374 Hydraulic Excavator Specifications

Reach Boom Lift Capacities – Standard Counterweight** – without Bucket, Heavy Lift: On

Long Variable Gauge Undercarriage

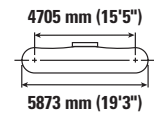
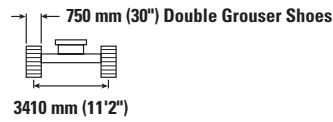
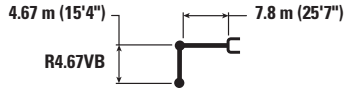

Reach	Unit	1500 mm/5'0"		3000 mm/10'0"		4500 mm/15'0"		6000 mm/20'0"		7500 mm/25'0"		9000 mm/30'0"		10 500 mm/35'0"		12 000 mm/40'0"		mm ft/in		
		kg	lb	kg	lb	kg	lb	kg	lb	kg	lb	kg	lb	kg	lb	kg	lb			
10 500 mm 35'0"	kg lb																	*11 750 *26,150	*11 750 *26,150	9210 29'8"
9000 mm 30'0"	kg lb																	*11 100 *24,550	*11 100 *24,550	10 330 33'6"
7500 mm 25'0"	kg lb																	*14 000 *30,600	*14 000 *30,600	11 140 36'4"
6000 mm 20'0"	kg lb																	*13 450 *29,000	11 750 25,150	11 700 38'3"
4500 mm 15'0"	kg lb																	*14 800 *32,200	*14 800 32,150	11 700 38'3"
3000 mm 10'0"	kg lb																	*13 800 *30,150	*13 800 30,150	11 700 38'3"
1500 mm 5'0"	kg lb																	*11 350 24,150	8950 19,600	12 050 39'5"
0 mm 0'0"	kg lb																	*10 800 *23,850	8750 18,800	12 050 39'5"
-1500 mm -5'0"	kg lb																	*11 350 24,150	8950 19,600	11 930 37'10"
-3000 mm -10'0"	kg lb																	*10 800 *23,850	8750 18,800	11 930 37'10"
-4500 mm -15'0"	kg lb																	*11 350 24,150	8950 19,600	11 930 37'10"
-6000 mm -20'0"	kg lb																	*11 350 24,150	8950 19,600	11 930 37'10"
-1500 mm -5'0"	kg lb																	*13 650 *30,750	*13 650 *30,750	11 500 37'8"
-3000 mm -10'0"	kg lb																	*24 700 *56,550	*24 700 *56,550	11 500 37'8"
-4500 mm -15'0"	kg lb																	*29 100 *63,050	22 450 48,300	11 500 37'8"
-6000 mm -20'0"	kg lb																	*22 900 *50,950	16 200 35,700	11 500 37'8"
-3000 mm -10'0"	kg lb																	*18 800 *43,450	*18 800 *43,450	10 850 35'5"
-4500 mm -15'0"	kg lb																	*29 100 *63,050	22 450 48,300	10 850 35'5"
-6000 mm -20'0"	kg lb																	*22 900 *50,950	16 200 35,700	10 850 35'5"
-1500 mm -5'0"	kg lb																	*13 650 *30,750	*13 650 *30,750	9920 32'4"
-3000 mm -10'0"	kg lb																	*24 700 *56,550	*24 700 *56,550	9920 32'4"
-4500 mm -15'0"	kg lb																	*29 100 *63,050	22 450 48,300	9920 32'4"
-6000 mm -20'0"	kg lb																	*22 900 *50,950	16 200 35,700	9920 32'4"
-1500 mm -5'0"	kg lb																	*13 650 *30,750	*13 650 *30,750	8640 27'11"
-3000 mm -10'0"	kg lb																	*24 700 *56,550	*24 700 *56,550	8640 27'11"
-4500 mm -15'0"	kg lb																	*29 100 *63,050	22 450 48,300	8640 27'11"
-6000 mm -20'0"	kg lb																	*22 900 *50,950	16 200 35,700	8640 27'11"



ISO 10567:2007



*Indicates that the load is limited by hydraulic lifting capacity rather than tipping load. The above loads are in compliance with hydraulic excavator lift capacity standard ISO 10567:2007.

They do not exceed 87% of hydraulic lifting capacity or 75% of tipping load. Weight of all lifting accessories must be deducted from the above lifting capacities. Lifting capacities are based on the machine standing on a firm, uniform supporting surface. The use of a work tool attachment point to handle/lift objects, could affect the machine lift performance.

**Lift capacities apply to both standard counterweight and counterweight with removal device.

Lift capacity stays with ±5% for all available track shoes.

Always refer to the appropriate Operation and Maintenance Manual for specific product information.

374 Hydraulic Excavator Specifications

Reach Boom Lift Capacities – Standard Counterweight^{**} – without Bucket, Heavy Lift: On

Long Variable Gauge Undercarriage

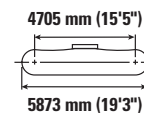
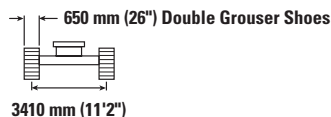

Reach	Unit	1500 mm/5'0"		3000 mm/10'0"		4500 mm/15'0"		6000 mm/20'0"		7500 mm/25'0"		9000 mm/30'0"		10 500 mm/35'0"		12 000 mm/40'0"		mm ft/in				
		kg	lb	kg	lb	kg	lb	kg	lb	kg	lb	kg	lb	kg	lb	kg	lb					
10 500 mm 35'0"	kg lb																	*11 750 *26,150	*11 750 *26,150	9210 29'8"		
9000 mm 30'0"	kg lb												*13 650 *30,050	*13 650 *30,050					*11 100 *24,550	*11 100 *24,550	10 330 33'6"	
7500 mm 25'0"	kg lb												*14 000 *30,600	*14 000 *30,600	*13 450 *29,000	11 650 24,950			*10 800 *23,850	10 400 23,150	11 140 36'4"	
6000 mm 20'0"	kg lb												*14 800 *32,200	*14 800 *31,900	*13 800 *30,150	11 450 24,550			*10 750 *23,700	9400 20,850	11 700 38'3"	
4500 mm 15'0"	kg lb					*29 050 *64,350	*29 050 *64,350	*21 950 *47,300	*21 950 *47,300	*18 200 *39,350	*18 200 *39,350	*15 900 *34,500	14 250 30,700	*14 350 *31,300	11 150 23,900	*11 350 8850			*10 900 *24,000	8800 19,400	12 050 39'5"	
3000 mm 10'0"	kg lb							*25 350 *54,650	25 100 54,100	*20 150 *43,550	17 950 38,700	*17 050 *36,950	13 650 29,400	14 800 31,800	10 750 23,150	11 950 *24,850	8650 18,600			*11 300 *24,800	8450 18,600	12 200 40'0"
1500 mm 5'0"	kg lb							*27 900 *60,300	23 600 50,850	*21 750 *47,050	17 050 36,800	*18 050 *39,100	13 100 28,200	14 400 31,000	10 450 22,450	11 750 8500			11 550 25,400	8300 18,300	12 160 39'10"	
0 mm 0'0"	kg lb					*18 800 *43,450	*18 800 *43,450	*29 150 *63,100	22 700 48,800	*22 750 *49,250	16 400 35,350	17 750 38,200	12 700 27,300	14 150 30,400	10 150 21,850				11 750 25,850	8450 18,600	11 930 39'1"	
-1500 mm -5'0"	kg lb			*13 650 *30,750	*13 650 *30,750	*24 700 *56,550	*24 700 *56,550	*29 100 *63,050	22 250 47,800	*22 900 49,300	16 050 34,550	17 450 37,550	12 400 26,700	13 950 30,050	10 000 21,550				12 300 27,100	8850 19,450	11 500 37'8"	
-3000 mm -10'0"	kg lb	*16 750 *37,450	*16 750 *37,450	*21 450 *48,400	*21 450 *48,400	*33 500 *76,550	*33 500 *76,250	*27 800 *60,250	22 150 47,600	*22 150 *47,900	15 900 34,250	17 350 37,350	12 300 26,550	13 950 30,150	10 000 21,600				13 400 29,600	9600 21,200	10 850 35'5"	
-4500 mm -15'0"	kg lb			*30 900 *70,000	*30 900 *70,000	*32 050 *69,200	*32 050 *69,200	*25 200 *54,400	22 350 48,100	*20 200 *43,500	16 000 34,550	*16 150 *34,450	12 450 26,850						*13 550 *29,800	11 000 24,400	9920 32'4"	
-6000 mm -20'0"	kg lb			*32 750 *70,050	*32 750 *70,050	*25 950 *55,500	*25 950 *55,500	*20 800 *44,350	*20 800 *44,350	*16 400 *34,550	*16 400 *34,550								*12 800 *28,000	*12 800 *28,000	8640 27'11"	



ISO 10567:2007



*Indicates that the load is limited by hydraulic lifting capacity rather than tipping load. The above loads are in compliance with hydraulic excavator lift capacity standard ISO 10567:2007. They do not exceed 87% of hydraulic lifting capacity or 75% of tipping load. Weight of all lifting accessories must be deducted from the above lifting capacities. Lifting capacities are based on the machine standing on a firm, uniform supporting surface. The use of a work tool attachment point to handle/lift objects, could affect the machine lift performance.

**Lift capacities apply to both standard counterweight and counterweight with removal device.

Lift capacity stays with ±5% for all available track shoes.

Always refer to the appropriate Operation and Maintenance Manual for specific product information.

374 Hydraulic Excavator Specifications

Reach Boom Lift Capacities – Standard Counterweight** – without Bucket, Heavy Lift: On

Long Variable Gauge Undercarriage

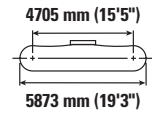
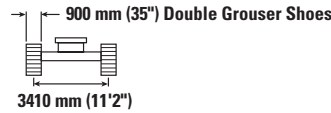
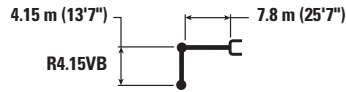

Reach (mm)	Reach (ft/in)	Unit	3000 mm/10'0"		4500 mm/15'0"		6000 mm/20'0"		7500 mm/25'0"		9000 mm/30'0"		10 500 mm/35'0"		mm ft/in		
			kg	lb	kg	lb	kg	lb	kg	lb	kg	lb	kg	lb			
10 500 mm	35'0"	kg													*13 550	*13 550	8480
		lb													*30,150	*30,150	27'3"
9000 mm	30'0"	kg									*14 600	*14 600			*12 750	*12 750	9690
		lb									*32,200	*32,200			*28,200	*28,200	31'5"
7500 mm	25'0"	kg									*14 800	*14 800	*12 850	11 700	*12 450	11 600	10 550
		lb									*32,350	*32,350			*27,400	25,850	34'4"
6000 mm	20'0"	kg							*17 250	*17 250	*15 550	14 950	*14 450	11 600	*12 400	10 400	11 140
		lb							*37,450	*37,450	*33,800	32,150	*31,550	24,800	*27,300	23,100	36'5"
4500 mm	15'0"	kg			*23 300	*23 300	*19 050	*19 050	*16 550	14 450	*14 900	11 300	*12 650	9700	*12 650	9700	11 500
		lb			*50,200	*50,200	*41,250	41,150	*35,900	31,050	*32,450	24,250	*27,800	21,400	*27,800	21,400	37'8"
3000 mm	10'0"	kg			*26 500	25 200	*20 900	18 150	*17 600	13 850	15 100	11 000	12 800	9300	12 800	9300	11 660
		lb			*57,150	54,300	*45,200	39,100	*38,150	29,850	32,400	23,600	28,200	20,500	28,200	20,500	38'2"
1500 mm	5'0"	kg			*28 650	23 900	*22 300	17 350	*18 450	13 350	14 750	10 700	12 700	9150	12 700	9150	11 620
		lb			*61,950	51,450	*48,250	37,350	40,000	28,800	31,750	22,950	27,900	20,200	27,900	20,200	38'1"
0 mm	0'0"	kg			*18 300	*18 300	*29 400	23 150	*23 050	16 800	18 150	13 000	14 500	10 450	12 950	9350	11 380
		lb			*42,400	*42,400	*63,700	49,800	*49,850	36,150	39,100	28,000	31,250	22,500	28,500	20,550	37'4"
-1500 mm	-5'0"	kg	*14 550	*14 550	*26 150	*26 150	*28 900	22 850	*22 900	16 500	17 950	12 800	14 400	10 350	13 650	9850	10 930
		lb	*32,850	*32,850	*59,850	*59,850	*62,600	49,150	*49,550	35,500	38,650	27,550	31,050	22,300	30,100	21,650	35'9"
-3000 mm	-10'0"	kg	*24 000	*24 000	*34 550	*34 550	*27 150	22 850	*21 750	16 450	*17 700	12 750			*14 550	10 800	10 240
		lb	*54,150	*54,150	*74,950	*74,950	*58,750	49,200	*47,050	35,400	*38,050	27,500			*32,000	23,850	33'5"
-4500 mm	-15'0"	kg	*35 300	*35 300	*29 900	*29 900	*24 000	23 150	*19 300	16 650	*15 000	13 000			*14 200	12 600	9250
		lb	*80,000	*80,000	*64,600	*64,600	*51,700	49,850	*41,400	35,900	*31,600	28,150			*31,200	27,950	30'1"
-6000 mm	-20'0"	kg			*23 000	*23 000	*18 700	*18 700	*14 300	*14 300					*13 050	*13 050	7850
		lb			*48,950	*48,950	*39,650	*39,650	*29,500	*29,500					*28,500	*28,500	25'4"



ISO 10567:2007



*Indicates that the load is limited by hydraulic lifting capacity rather than tipping load. The above loads are in compliance with hydraulic excavator lift capacity standard ISO 10567:2007.

They do not exceed 87% of hydraulic lifting capacity or 75% of tipping load. Weight of all lifting accessories must be deducted from the above lifting capacities. Lifting capacities are based on the machine standing on a firm, uniform supporting surface. The use of a work tool attachment point to handle/lift objects, could affect the machine lift performance.

**Lift capacities apply to both standard counterweight and counterweight with removal device.

Lift capacity stays with ±5% for all available track shoes.

Always refer to the appropriate Operation and Maintenance Manual for specific product information.

374 Hydraulic Excavator Specifications

Reach Boom Lift Capacities – Standard Counterweight** – without Bucket, Heavy Lift: On

Long Variable Gauge Undercarriage

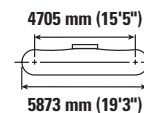
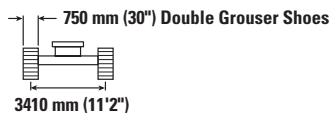

Reach	Unit	3000 mm/10'0"		4500 mm/15'0"		6000 mm/20'0"		7500 mm/25'0"		9000 mm/30'0"		10 500 mm/35'0"		mm ft/in			
		kg	lb	kg	lb	kg	lb	kg	lb	kg	lb	kg	lb	kg	lb	mm	ft/in
10 500 mm 35'0"	kg lb														*13 550 *30,150	*13 550 *30,150	8480 27'3"
9000 mm 30'0"	kg lb									*14 600 *32,200	*14 600 *32,200			*12 750 *28,200	*12 750 *28,200	9690 31'5"	
7500 mm 25'0"	kg lb									*14 800 *32,350	*14 800 *32,350	*12 850 11 550		*12 450 *27,400	*12 450 25,500	10 550 34'4"	
6000 mm 20'0"	kg lb							*17 250 *37,450	*17 250 *37,450	*15 550 *33,800	14 750 31,750	*14 450 *31,550	11 400 24,500	*12 400 *27,300	*12 400 22,750	11 140 36'5"	
4500 mm 15'0"	kg lb			*67,800 *67,800		*23 300 *50,200	*23 300 *50,200	*19 050 *41,250	18 850 40,650	*16 550 *35,900	14 250 30,650	*14 900 *32,450	11 150 23,900	*12 650 *27,800	9550 21,100	11 500 37'8"	
3000 mm 10'0"	kg lb					*26 500 *57,150	24 850 53,600	*20 900 *45,200	17 900 38,600	*17 600 *38,150	13 650 29,450	14 850 31,950	10 800 23,250	12 600 27,750	9150 20,150	11 660 38'2"	
1500 mm 5'0"	kg lb					*28 650 *61,950	23 550 50,750	*22 300 *48,250	17 100 36,850	18 300 39,400	13 150 28,350	14 550 31,300	10 500 22,600	12 500 27,500	9050 19,900	11 620 38'1"	
0 mm 0'0"	kg lb			*18 300 *42,400	*18 300 *42,400	*29 400 *63,700	22 800 49,100	*23 050 *49,850	16 550 35,600	17 900 38,550	12 800 27,550	14 300 30,800	10 300 22,150	12 750 28,050	9200 20,250	11 380 37'4"	
-1500 mm -5'0"	kg lb	*14 550 *32,850	*14 550 *32,850	*26 150 *59,850	*26 150 *59,850	*28 900 *62,600	22 500 48,400	*22 900 *49,550	16 250 35,000	17 700 38,050	12 600 27,100	14 200 30,600	10 200 22,000	13 450 29,650	9650 21,300	10 930 35'9"	
-3000 mm -10'0"	kg lb	*24 000 *54,150	*24 000 *54,150	*34 550 *74,950	*34 550 *74,950	*27 150 *58,750	22 550 48,450	*21 750 *47,050	16 200 34,900	17 650 *38,050	12 550 27,100			*14 550 *32,000	10 600 23,500	10 240 33'5"	
-4500 mm -15'0"	kg lb	*35 300 *80,000	*35 300 *80,000	*29 900 *64,600	*29 900 *64,600	*24 000 *51,700	22 850 49,150	*19 300 *41,400	16 400 35,350	*15 000 *31,600	12 800 27,700			*14 200 *31,200	12 400 27,550	9250 30'1"	
-6000 mm -20'0"	kg lb			*23 000 *48,950	*23 000 *48,950	*18 700 *39,650	*18 700 *39,650	*14 300 *29,500	*14 300 *29,500					*13 050 *28,500	*13 050 *28,500	7850 25'4"	



ISO 10567:2007



*Indicates that the load is limited by hydraulic lifting capacity rather than tipping load. The above loads are in compliance with hydraulic excavator lift capacity standard ISO 10567:2007. They do not exceed 87% of hydraulic lifting capacity or 75% of tipping load. Weight of all lifting accessories must be deducted from the above lifting capacities. Lifting capacities are based on the machine standing on a firm, uniform supporting surface. The use of a work tool attachment point to handle/lift objects, could affect the machine lift performance.

**Lift capacities apply to both standard counterweight and counterweight with removal device.

Lift capacity stays with ±5% for all available track shoes.

Always refer to the appropriate Operation and Maintenance Manual for specific product information.

374 Hydraulic Excavator Specifications

Reach Boom Lift Capacities – Standard Counterweight** – without Bucket, Heavy Lift: On

Long Variable Gauge Undercarriage

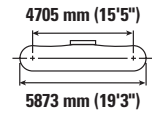
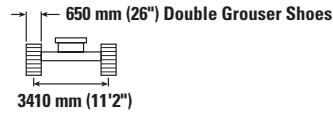
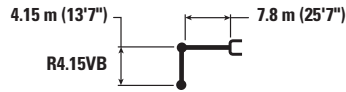

Reach mm ft/in	Unit	3000 mm/10'0"		4500 mm/15'0"		6000 mm/20'0"		7500 mm/25'0"		9000 mm/30'0"		10 500 mm/35'0"		mm ft/in		
		kg lb	kg lb	kg lb	kg lb	kg lb	kg lb	kg lb	kg lb	kg lb	kg lb	kg lb	kg lb	kg lb	kg lb	mm ft/in
10 500 mm 35'0"	kg lb													*13 550 *30,150	*13 550 *30,150	8480 27'3"
9000 mm 30'0"	kg lb									*14 600 *32,200	*14 600 *32,200			*12 750 *28,200	*12 750 *28,200	9690 31'5"
7500 mm 25'0"	kg lb									*14 800 *32,350	*14 800 *32,300	*12 850 11 450		*12 450 *27,400	*12 450 25,250	10 550 34'4"
6000 mm 20'0"	kg lb							*17 250 *37,450	*17 250 *37,450	*15 550 *33,800	14 650 31,450	*14 450 *31,550	11 300 24,250	*12 400 *27,300	10 150 22,500	11 140 36'5"
4500 mm 15'0"	kg lb			*67,800 *67,800	*67,800 *67,800	*23 300 *50,200	*23 300 *50,200	*19 050 *41,250	18 700 40,300	*16 550 *35,900	14 100 30,350	*14 900 32,350	11 050 23,700	*12 650 *27,800	9450 20,850	11 500 37'8"
3000 mm 10'0"	kg lb					*26 500 *57,150	24 650 53,100	*20 900 *45,200	17 750 38,250	*17 600 *38,150	13 550 29,150	14 700 31,650	10 700 23,000	12 450 *27,500	9050 19,950	11 660 38'2"
1500 mm 5'0"	kg lb					*28 650 *61,950	23 300 50,250	*22 300 *48,250	16 950 36,500	18 150 39,000	13 050 28,100	14 400 30,950	10 400 22,400	12 350 *27,200	8950 19,650	11 620 38'1"
0 mm 0'0"	kg lb			*18 300 *42,400	*18 300 *42,400	*29 400 *63,700	22 600 48,600	*23 050 *49,850	16 350 35,250	17 700 38,150	12 650 27,300	14 150 30,450	10 200 21,900	12 600 *27,800	9100 20,000	11 380 37'4"
-1500 mm -5'0"	kg lb	*14 550 *32,850	*14 550 *32,850	*26 150 *59,850	*26 150 *59,850	*28 900 *62,600	22 300 47,950	*22 900 49,350	16 100 34,600	17 500 37,650	12 450 26,850	14 050 30,300	10 100 21,750	13 300 29,350	9550 21,100	10 930 35'9"
-3000 mm -10'0"	kg lb	*24 000 *54,150	*24 000 *54,150	*34 550 *74,950	*34 550 *74,950	*27 150 *58,750	22 300 48,000	*21 750 *47,050	16 050 34,550	17 500 37,650	12 450 26,800			*14 550 *32,000	10 500 23,250	10 240 33'5"
-4500 mm -15'0"	kg lb	*35 300 *80,000	*35 300 *80,000	*29 900 *64,600	*29 900 *64,600	*24 000 *51,700	22 600 48,650	*19 300 *41,400	16 250 35,000	*15 000 *31,600	12 700 27,450			*14 200 *31,200	12 250 27,250	9250 30'1"
-6000 mm -20'0"	kg lb			*23 000 *48,950	*23 000 *48,950	*18 700 *39,650	*18 700 *39,650	*14 300 *29,500	*14 300 *29,500					*13 050 *28,500	*13 050 *28,500	7850 25'4"



ISO 10567:2007



*Indicates that the load is limited by hydraulic lifting capacity rather than tipping load. The above loads are in compliance with hydraulic excavator lift capacity standard ISO 10567:2007.

They do not exceed 87% of hydraulic lifting capacity or 75% of tipping load. Weight of all lifting accessories must be deducted from the above lifting capacities. Lifting capacities are based on the machine standing on a firm, uniform supporting surface. The use of a work tool attachment point to handle/lift objects, could affect the machine lift performance.

**Lift capacities apply to both standard counterweight and counterweight with removal device.

Lift capacity stays with ±5% for all available track shoes.

Always refer to the appropriate Operation and Maintenance Manual for specific product information.

374 Hydraulic Excavator Specifications

Reach Boom Lift Capacities – Standard Counterweight** – without Bucket, Heavy Lift: On

Long Variable Gauge Undercarriage

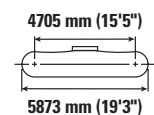
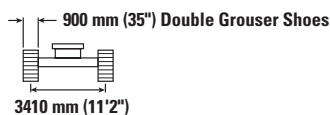
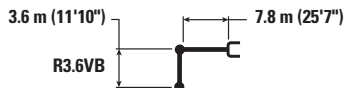

		3000 mm/10'0"		4500 mm/15'0"		6000 mm/20'0"		7500 mm/25'0"		9000 mm/30'0"		10 500 mm/35'0"		mm ft/in		
10 500 mm 35'0"	kg lb													*16 150 *36,000	*16 150 *36,000	7760 24'10"
9000 mm 30'0"	kg lb									*15 700	15 250			*15 100 *33,400	15 050 *33,400	9070 29'4"
7500 mm 25'0"	kg lb							*16 950 *36,900	*16 950 *36,900	*15 750 *34,400	15 200 32,600			*14 650 *32,350	12 650 28,250	9980 32'6"
6000 mm 20'0"	kg lb					*21 500 *46,400	*21 500 *46,400	*18 300 *39,700	*18 300 *39,700	*16 350 *35,600	14 850 31,900	*15 200 11 450		*14 650 *32,250	11 250 25,000	10 610 34'8"
4500 mm 15'0"	kg lb					*24 750 *53,350	*24 750 *53,350	*20 050 *43,350	18 900 40,750	*17 250 *37,500	14 350 30,850	15 350 33,000	11 250 24,200	14 250 31,500	10 450 23,050	10 990 35'11"
3000 mm 10'0"	kg lb					*27 700 *59,750	24 850 53,600	*21 700 *46,950	18 000 38,850	*18 200 *39,500	13 850 29,800	15 050 32,400	11 000 23,600	13 750 30,250	10 000 22,050	11 150 36'6"
1500 mm 5'0"	kg lb					*29 400 *63,550	23 750 51,200	*22 900 *49,550	17 300 37,300	18 600 40,000	13 400 28,850	14 800 31,850	10 750 23,100	13 650 30,000	9900 21,750	11 110 36'5"
0 mm 0'0"	kg lb					*29 600 *64,150	23 200 49,950	*23 300 *50,500	16 850 36,300	18 250 39,300	13 100 28,200	14 650 31,500	10 550 22,750	13 950 30,750	10 100 22,250	10 860 35'7"
-1500 mm -5'0"	kg lb					*26 800 *61,450	*26 800 *61,450	*28 550 *61,950	23 050 49,600	*22 850 *49,450	16 650 35,850	18 100 39,000	12 950 27,900	14 850 32,700	10 700 23,600	10 390 34'0"
-3000 mm -10'0"	kg lb	*26 350 *59,550	*26 350 *59,550	*32 650 *70,900	*32 650 *70,900	*26 350 *57,000	23 200 49,900	*21 300 *45,950	16 700 35,950	*17 100 *36,700	13 000 28,050			*15 250 *33,550	11 900 26,300	9660 31'6"
-4500 mm -15'0"	kg lb	*32 400 *70,200	*32 400 *70,200	*27 450 *59,250	*27 450 *59,250	*22 550 *48,500	*22 550 *48,500	*18 100 *38,650	17 000 36,700					*14 650 *32,100	14 200 31,600	8600 27'11"
-6000 mm -20'0"	kg lb					*16 100 *33,600	*16 100 *33,600							*12 750 *27,600	*12 750 *27,600	7070 22'9"



ISO 10567:2007



*Indicates that the load is limited by hydraulic lifting capacity rather than tipping load. The above loads are in compliance with hydraulic excavator lift capacity standard ISO 10567:2007. They do not exceed 87% of hydraulic lifting capacity or 75% of tipping load. Weight of all lifting accessories must be deducted from the above lifting capacities. Lifting capacities are based on the machine standing on a firm, uniform supporting surface. The use of a work tool attachment point to handle/lift objects, could affect the machine lift performance.

**Lift capacities apply to both standard counterweight and counterweight with removal device.

Lift capacity stays with ±5% for all available track shoes.

Always refer to the appropriate Operation and Maintenance Manual for specific product information.

374 Hydraulic Excavator Specifications

Reach Boom Lift Capacities – Standard Counterweight** – without Bucket, Heavy Lift: On

Long Variable Gauge Undercarriage

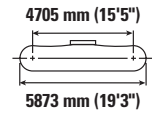
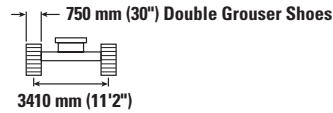
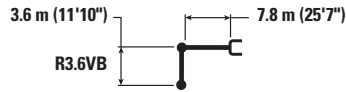

Reach Boom Lift Configuration	Unit	3000 mm/10'0"		4500 mm/15'0"		6000 mm/20'0"		7500 mm/25'0"		9000 mm/30'0"		10 500 mm/35'0"		mm ft/in		
		kg	lb	kg	lb	kg	lb	kg	lb	kg	lb	kg	lb			
10 500 mm 35'0"	kg lb													*16 150 *36,000	*16 150 *36,000	7760 24'10"
9000 mm 30'0"	kg lb									*15 700	15 050			*15 100 *33,400	14 850 *33,400	9070 29'4"
7500 mm 25'0"	kg lb							*16 950 *36,900	*16 950 *36,900	*15 750 *34,400	15 000 32,200			*14 650 *32,350	12 500 27,850	9980 32'6"
6000 mm 20'0"	kg lb					*21 500 *46,400	*21 500 *46,400	*18 300 *39,700	*18 300 *39,700	*16 350 *35,600	14 650 31,450	*15 200	11 300	*14 650 *32,250	11 100 24,650	10 610 34'8"
4500 mm 15'0"	kg lb					*24 750 *53,350	*24 750 *53,350	*20 050 *43,350	18 650 40,200	*17 250 *37,500	14 150 30,450	15 150	11 100	14 050 31,050	10 300 22,750	10 990 35'11"
3000 mm 10'0"	kg lb					*27 700 *59,750	24 500 52,900	*21 700 *46,950	17 750 38,300	*18 200 *39,500	13 650 29,350	14 850 31,950	10 800	13 550 29,850	9850 21,700	11 150 36'6"
1500 mm 5'0"	kg lb					*29 400 *63,550	23 450 50,450	*22 900 *49,550	17 050 36,750	18 300 39,450	13 200 28,400	14 600 31,400	10 550	13 450 29,550	9750 21,450	11 110 36'5"
0 mm 0'0"	kg lb					*29 600 *64,150	22 900 49,250	*23 300 *50,500	16 600 35,800	18 000 38,700	12 900 27,750	14 400 31,050	10 400	13 750 30,300	9950 21,900	10 860 35'7"
-1500 mm -5'0"	kg lb			*26 800 *61,450	*26 800 *61,450	*28 550 *61,950	22 750 48,900	*22 850 *49,450	16 400 35,350	17 850 38,400	12 750 27,450			14 600 32,250	10 550 23,250	10 390 34'0"
-3000 mm -10'0"	kg lb	*26 350 *59,550	*26 350 *59,550	*32 650 *70,900	*32 650 *70,900	*26 350 *57,000	22 850 49,200	*21 300 *45,950	16 450 35,450	*17 100 *36,700	12 800 27,650			*15 250 *33,550	11 700 25,950	9660 31'6"
-4500 mm -15'0"	kg lb	*32 400 *70,200	*32 400 *70,200	*27 450 *59,250	*27 450 *59,250	*22 550 *48,500	22 550 48,500	*18 100 *38,650	16 750 36,150					*14 650 *32,100	14 000 31,150	8600 27'11"
-6000 mm -20'0"	kg lb					*16 100 *33,600	16 100 33,600							*12 750 *27,600	*12 750 *27,600	7070 22'9"



ISO 10567:2007



*Indicates that the load is limited by hydraulic lifting capacity rather than tipping load. The above loads are in compliance with hydraulic excavator lift capacity standard ISO 10567:2007. They do not exceed 87% of hydraulic lifting capacity or 75% of tipping load. Weight of all lifting accessories must be deducted from the above lifting capacities. Lifting capacities are based on the machine standing on a firm, uniform supporting surface. The use of a work tool attachment point to handle/lift objects, could affect the machine lift performance.

**Lift capacities apply to both standard counterweight and counterweight with removal device.

Lift capacity stays with ±5% for all available track shoes.

Always refer to the appropriate Operation and Maintenance Manual for specific product information.

374 Hydraulic Excavator Specifications

Reach Boom Lift Capacities – Standard Counterweight** – without Bucket, Heavy Lift: On

Long Variable Gauge Undercarriage

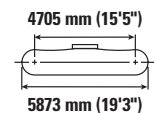
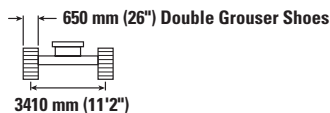

		3000 mm/10'0"		4500 mm/15'0"		6000 mm/20'0"		7500 mm/25'0"		9000 mm/30'0"		10 500 mm/35'0"		mm ft/in		
10 500 mm 35'0"	kg lb													*16 150 *36,000	*16 150 *36,000	7760 24'10"
9000 mm 30'0"	kg lb									*15 700	14 950			*15 100 *33,400	14 750 33,100	9070 29'4"
7500 mm 25'0"	kg lb							*16 950 *36,900	*16 950 *36,900	*15 750 *34,400	14 850 31,900			*14 650 *32,350	12 400 27,600	9980 32'6"
6000 mm 20'0"	kg lb					*21 500 *46,400	*21 500 *46,400	*18 300 *39,700	*18 300 *39,700	*16 350 *35,600	14 500 31,200	*15 200	11 200	*14 650 *32,250	11 000 24,400	10 610 34'8"
4500 mm 15'0"	kg lb					*24 750 *53,350	*24 750 *53,350	*20 050 *43,350	18 500 39,850	*17 250 *37,500	14 000 30,150	15 000 32,200	11 000 23,600	13 950 30,750	10 200 22,500	10 990 35'11"
3000 mm 10'0"	kg lb					*27 700 *59,750	24 300 52,400	*21 700 *46,950	17 600 37,950	*18 200 *39,500	13 500 29,100	14 700 31,650	10 700 23,050	13 400 29,550	9750 21,500	11 150 36'6"
1500 mm 5'0"	kg lb					*29 400 *63,550	23 200 50,000	*22 900 *49,550	16 900 36,400	18 150 39,050	13 050 28,150	14 450 31,100	10 450 22,500	13 300 29,250	9650 21,200	11 110 36'5"
0 mm 0'0"	kg lb					*29 600 *64,150	22 650 48,750	*23 300 50,200	16 450 35,400	17 800 38,350	12 750 27,450	14 250 30,750	10 300 22,200	13 600 30,000	9850 21,650	10 860 35'7"
-1500 mm -5'0"	kg lb					*26 800 *61,450	*26 800 *61,450	*28 550 *61,950	22 500 48,400	*22 850 *49,450	16 250 35,000	17 650 38,000	12 600 27,200	14 450 31,900	10 450 23,000	10 390 34'0"
-3000 mm -10'0"	kg lb	*26 350 *59,550	*26 350 *59,550	*32 650 *70,900	*32 650 *70,900	*26 350 *57,000	22 650 48,700	*21 300 *45,950	16 300 35,100	*17 100 *36,700	12 700 27,350			*15 250 *33,550	11 600 25,650	9660 31'6"
-4500 mm -15'0"	kg lb	*32 400 *70,200	*32 400 *70,200	*27 450 *59,250	*27 450 *59,250	*22 550 *48,500	*22 550 *48,500	*18 100 *38,650	16 600 35,800					*14 650 *32,100	13 850 30,850	8600 27'11"
-6000 mm -20'0"	kg lb					*16 100 *33,600	*16 100 *33,600							*12 750 *27,600	*12 750 *27,600	7070 22'9"



ISO 10567:2007



*Indicates that the load is limited by hydraulic lifting capacity rather than tipping load. The above loads are in compliance with hydraulic excavator lift capacity standard ISO 10567:2007. They do not exceed 87% of hydraulic lifting capacity or 75% of tipping load. Weight of all lifting accessories must be deducted from the above lifting capacities. Lifting capacities are based on the machine standing on a firm, uniform supporting surface. The use of a work tool attachment point to handle/lift objects, could affect the machine lift performance.

**Lift capacities apply to both standard counterweight and counterweight with removal device.

Lift capacity stays with ±5% for all available track shoes.

Always refer to the appropriate Operation and Maintenance Manual for specific product information.

374 Hydraulic Excavator Specifications

Reach Boom Lift Capacities – Standard Counterweight** – without Bucket, Heavy Lift: On

Long Variable Gauge Undercarriage

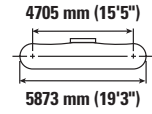
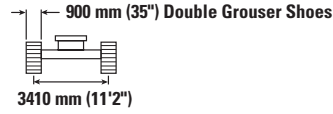
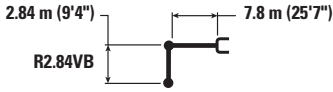

Reach	Unit	4500 mm/15'0"		6000 mm/20'0"		7500 mm/25'0"		9000 mm/30'0"		10 500 mm/35'0"		mm ft/in		
		kg lb	kg lb	kg lb	kg lb	kg lb	kg lb	kg lb	kg lb	kg lb	kg lb	kg lb	mm ft/in	
10 500 mm 35'0"	kg lb											*19 150	*19 150	6820
9000 mm 30'0"	kg lb					*17 850 *39,300	*17 850 *39,300					*17 600 *39,000	17 200 38,800	8290 26'9"
7500 mm 25'0"	kg lb					*18 300 *39,850	*18 300 *39,850	*17 000 *37,350	14 850 31,850			*16 900 *37,300	14 100 31,450	9280 30'2"
6000 mm 20'0"	kg lb	*31 150 *66,400	*31 150 *66,400	*23 350 *50,350	*23 350 *50,350	*19 550 *42,350	19 400 41,800	*17 350 *37,800	14 600 31,400			*16 550 *36,500	12 350 27,450	9950 32'6"
4500 mm 15'0"	kg lb			*26 500 *57,000	25 700 55,450	*21 100 *45,650	18 550 40,000	*18 100 *39,250	14 150 30,450			15 550 34,400	11 400 25,150	10 350 33'10"
3000 mm 10'0"	kg lb			*28 950 *62,450	24 250 52,300	*22 500 *48,700	17 750 38,250	*18 800 40,700	13 700 29,500	15 000	10 950	14 950 32,950	10 900 24,000	10 530 34'6"
1500 mm 5'0"	kg lb			*29 800 *64,500	23 450 50,500	*23 350 *50,500	17 150 36,950	18 500 39,850	13 300 28,700			14 850 32,750	10 800 23,750	10 480 34'4"
0 mm 0'0"	kg lb			*29 200 *63,350	23 150 49,850	*23 300 *50,500	16 800 36,200	18 250 39,350	13 100 28,250			15 300 33,750	11 100 24,400	10 220 33'6"
-1500 mm -5'0"	kg lb	*25 450 *59,000	*25 450 *59,000	*27 450 *59,650	23 200 49,900	*22 300 *48,300	16 750 36,050	*18 150 *39,100	13 050 28,200			*16 150 *35,550	11 900 26,200	9710 31'9"
-3000 mm -10'0"	kg lb	*28 950 *63,100	*28 950 *63,100	*24 550 *53,150	23 450 50,450	*20 050 *43,200	16 900 36,450			23 450	*20 050	*15 650 *34,400	13 500 29,850	8920 29'1"
-4500 mm -15'0"	kg lb	*23 150 *49,900	*23 150 *49,900	*19 800 *42,400	*19 800 *42,400	*15 350 *32,000	*15 350 *32,000					*14 300 *31,250	*14 300 *31,250	7770 25'2"



ISO 10567:2007



*Indicates that the load is limited by hydraulic lifting capacity rather than tipping load. The above loads are in compliance with hydraulic excavator lift capacity standard ISO 10567:2007. They do not exceed 87% of hydraulic lifting capacity or 75% of tipping load. Weight of all lifting accessories must be deducted from the above lifting capacities. Lifting capacities are based on the machine standing on a firm, uniform supporting surface. The use of a work tool attachment point to handle/lift objects, could affect the machine lift performance.

**Lift capacities apply to both standard counterweight and counterweight with removal device.

Lift capacity stays with ±5% for all available track shoes.

Always refer to the appropriate Operation and Maintenance Manual for specific product information.

374 Hydraulic Excavator Specifications

Reach Boom Lift Capacities – Standard Counterweight^{**} – without Bucket, Heavy Lift: On

Long Variable Gauge Undercarriage

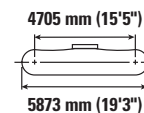
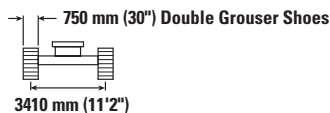

Reach	Unit	4500 mm/15'0"		6000 mm/20'0"		7500 mm/25'0"		9000 mm/30'0"		10 500 mm/35'0"		mm ft/in		
		kg lb	kg lb	kg lb	kg lb	kg lb	kg lb	kg lb	kg lb	kg lb	kg lb	kg lb	mm ft/in	
10 500 mm 35'0"	kg lb											*19 150	*19 150	6820
9000 mm 30'0"	kg lb					*17 850 *39,300	*17 850 *39,300					*17 600 *39,000	16 950 38,300	8290 26'9"
7500 mm 25'0"	kg lb					*18 300 *39,850	*18 300 *39,850	*17 000 *37,350	14 650 31,450			*16 900 *37,300	13 900 31,000	9280 30'2"
6000 mm 20'0"	kg lb	*31 150 *66,400	*31 150 *66,400	*23 350 *50,350	*23 350 *50,350	*19 550 *42,350	19 150 41,250	*17 350 *37,800	14 400 30,950			*16 550 *36,500	12 200 27,050	9950 32'6"
4500 mm 15'0"	kg lb			*26 500 *57,000	25 350 54,750	*21 100 *45,650	18 300 39,450	*18 100 *39,250	13 950 30,050			15 350 33,900	11 200 24,800	10 350 33'10"
3000 mm 10'0"	kg lb			*28 950 *62,450	23 900 51,550	*22 500 *48,700	17 500 37,700	18 650 40,150	13 500 29,100	14 800 10 750		14 750 32,500	10 750 23,650	10 530 34'6"
1500 mm 5'0"	kg lb			*29 800 *64,500	23 100 49,800	*23 350 *50,500	16 900 36,400	18 250 39,300	13 150 28,300			14 650 32,250	10 650 23,400	10 480 34'4"
0 mm 0'0"	kg lb			*29 200 *63,350	22 850 49,100	*23 300 *50,500	16 550 35,700	18 000 38,750	12 900 27,800			15 100 33,250	10 900 24,050	10 220 33'6"
-1500 mm -5'0"	kg lb	*25 450 *59,000	*25 450 *59,000	*27 450 *59,650	22 850 49,150	*22 300 *48,300	16 500 35,500	17 950 38,700	12 850 27,750			*16 150 *35,550	11 700 25,800	9710 31'9"
-3000 mm -10'0"	kg lb	*28 950 *63,100	*28 950 *63,100	*24 550 *53,150	23 100 49,750	*20 050 *43,200	16 650 35,900					*15 650 *34,400	13 300 29,400	8920 29'1"
-4500 mm -15'0"	kg lb	*23 150 *49,900	*23 150 *49,900	*19 800 *42,400	*19 800 *42,400	*15 350 *32,000	15 350 32,000					*14 300 *31,250	*14 300 *31,250	7770 25'2"



ISO 10567:2007



*Indicates that the load is limited by hydraulic lifting capacity rather than tipping load. The above loads are in compliance with hydraulic excavator lift capacity standard ISO 10567:2007. They do not exceed 87% of hydraulic lifting capacity or 75% of tipping load. Weight of all lifting accessories must be deducted from the above lifting capacities. Lifting capacities are based on the machine standing on a firm, uniform supporting surface. The use of a work tool attachment point to handle/lift objects, could affect the machine lift performance.

**Lift capacities apply to both standard counterweight and counterweight with removal device.

Lift capacity stays with ±5% for all available track shoes.

Always refer to the appropriate Operation and Maintenance Manual for specific product information.

374 Hydraulic Excavator Specifications

Reach Boom Lift Capacities – Standard Counterweight** – without Bucket, Heavy Lift: On

Long Variable Gauge Undercarriage

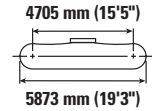
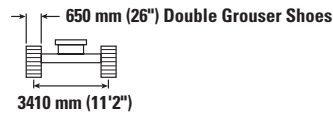
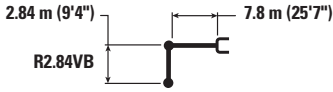

Reach	Unit	4500 mm/15'0"		6000 mm/20'0"		7500 mm/25'0"		9000 mm/30'0"		10 500 mm/35'0"		mm ft/in		
		kg lb	kg lb	kg lb	kg lb	kg lb	kg lb	kg lb	kg lb	kg lb	kg lb	kg lb	mm ft/in	
10 500 mm 35'0"	kg lb											*19 150	*19 150	6820
9000 mm 30'0"	kg lb					*17 850 *39,300	*17 850 *39,300					*17 600 *39,000	16 850 38,000	8290 26'9"
7500 mm 25'0"	kg lb					*18 300 *39,850	*18 300 *39,850	*17 000 *37,350	14 550 31,150			*16 900 *37,300	13 800 30,750	9280 30'2"
6000 mm 20'0"	kg lb	*31 150 *66,400	*31 150 *66,400	*23 350 *50,350	*23 350 *50,350	*19 550 *42,350	19 000 40,900	*17 350 *37,800	14 250 30,700			16 450 36,500	12 100 26,800	9950 32'6"
4500 mm 15'0"	kg lb			*26 500 *57,000	25 100 54,250	*21 100 *45,650	18 100 39,100	*18 100 *39,250	13 850 29,750			15 200 33,600	11 100 24,550	10 350 33'10"
3000 mm 10'0"	kg lb			*28 950 *62,450	23 650 51,100	*22 500 *48,700	17 300 37,350	18 450 39,750	13 350 28,800	14 650	10 650	14 600 32,150	10 600 23,400	10 530 34'6"
1500 mm 5'0"	kg lb			*29 800 *64,500	22 900 49,300	*23 350 *50,500	16 700 36,050	18 050 38,900	13 000 28,000			14 500 31,950	10 500 23,150	10 480 34'4"
0 mm 0'0"	kg lb			*29 200 *63,350	22 600 48,650	23 250 50,050	16 400 35,350	17 800 38,400	12 800 27,550			14 950 32,900	10 800 23,800	10 220 33'6"
-1500 mm -5'0"	kg lb	*25 450 *59,000	*25 450 *59,000	*27 450 *59,650	22 650 48,650	*22 300 *48,300	16 300 35,150	17 800 38,350	12 750 27,500			16 050 35,450	11 600 25,550	9710 31'9"
-3000 mm -10'0"	kg lb	*28 950 *63,100	*28 950 *63,100	*24 550 *53,150	22 900 49,250	*20 050 *43,200	16 500 35,550					*15 650 *34,400	13 150 29,100	8920 29'1"
-4500 mm -15'0"	kg lb	*23 150 *49,900	*23 150 *49,900	*19 800 *42,400	*19 800 *42,400	*15 350 *32,000	*15 350 *32,000					*14 300 *31,250	*14 300 *31,250	7770 25'2"



ISO 10567:2007



*Indicates that the load is limited by hydraulic lifting capacity rather than tipping load. The above loads are in compliance with hydraulic excavator lift capacity standard ISO 10567:2007. They do not exceed 87% of hydraulic lifting capacity or 75% of tipping load. Weight of all lifting accessories must be deducted from the above lifting capacities. Lifting capacities are based on the machine standing on a firm, uniform supporting surface. The use of a work tool attachment point to handle/lift objects, could affect the machine lift performance.

**Lift capacities apply to both standard counterweight and counterweight with removal device.

Lift capacity stays with ±5% for all available track shoes.

Always refer to the appropriate Operation and Maintenance Manual for specific product information.

374 Hydraulic Excavator Specifications

Mass Boom Lift Capacities – Standard Counterweight** – without Bucket, Heavy Lift: On

Long Variable Gauge Undercarriage

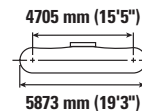
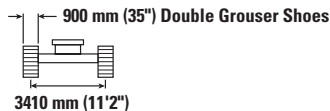

Boom Length	Unit	3000 mm/10'0"		4500 mm/15'0"		6000 mm/20'0"		7500 mm/25'0"		9000 mm/30'0"		mm ft/in		
		kg lb	kg lb	kg lb	kg lb	kg lb	kg lb	kg lb	kg lb	kg lb	kg lb	kg lb	kg lb	
9000 mm 30'0"	kg lb											*18 150 *40,350	*18 150 *40,350	6820 21'10"
7500 mm 25'0"	kg lb							*18 850 *41,450	*18 850 *41,450			*17 100 *37,750	*17 100 *37,750	8000 25'11"
6000 mm 20'0"	kg lb					*22 600 *48,900	*22 600 *48,900	*19 550 *42,600	19 400 41,750			*16 850 *37,100	14 950 33,200	8770 28'7"
4500 mm 15'0"	kg lb					*25 450 *54,950	*25 450 *54,950	*20 900 *45,300	18 650 40,150	*18 400 *40,100	14 000 30,100	*17 150 *37,750	13 450 29,700	9230 30'2"
3000 mm 10'0"	kg lb					*28 100 *60,650	24 700 53,250	*22 250 *48,150	17 850 38,450	18 900 40,650	13 600 29,300	17 600 38,800	12 700 28,000	9430 30'10"
1500 mm 5'0"	kg lb					*29 450 *63,750	23 700 51,050	*23 100 *50,100	17 200 37,100	18 550 39,900	13 300 28,650	17 450 38,450	12 550 27,650	9380 30'9"
0 mm 0'0"	kg lb			*29 500 *69,100	*29 500 *69,100	*29 300 *63,500	23 250 50,050	*23 150 *50,100	16 850 36,300	18 350 40,000	13 150 28,600	18 150 40,000	13 000 28,600	9080 29'9"
-1500 mm -5'0"	kg lb		*60,300	*34 600 *75,450	*34 600 *75,450	*27 600 *59,850	23 250 50,000	*21 900 *47,300	16 800 36,200			*18 450 *40,650	14 250 31,400	8500 27'10"
-3000 mm -10'0"	kg lb	*34 200 *74,750	*34 200 *74,750	*29 800 *64,700	*29 800 *64,700	*24 100 *51,950	23 600 50,800	*18 350	17 200			*17 950 *39,500	16 950 37,600	7590 24'9"
-4500 mm -15'0"	kg lb			*21 750 *46,400	*21 750 *46,400	*16 700	*16 700					*15 900 *34,600	*15 900 *34,600	6170 19'11"



ISO 10567:2007



*Indicates that the load is limited by hydraulic lifting capacity rather than tipping load. The above loads are in compliance with hydraulic excavator lift capacity standard ISO 10567:2007. They do not exceed 87% of hydraulic lifting capacity or 75% of tipping load. Weight of all lifting accessories must be deducted from the above lifting capacities. Lifting capacities are based on the machine standing on a firm, uniform supporting surface. The use of a work tool attachment point to handle/lift objects, could affect the machine lift performance.

**Lift capacities apply to both standard counterweight and counterweight with removal device.

Lift capacity stays with ±5% for all available track shoes.

Always refer to the appropriate Operation and Maintenance Manual for specific product information.

374 Hydraulic Excavator Specifications

Mass Boom Lift Capacities – Standard Counterweight** – without Bucket, Heavy Lift: On

Long Variable Gauge Undercarriage

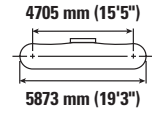
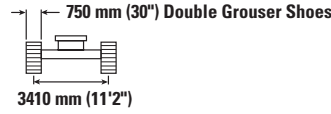
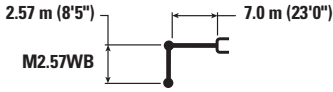

		3000 mm/10'0"		4500 mm/15'0"		6000 mm/20'0"		7500 mm/25'0"		9000 mm/30'0"		mm ft/in		
9000 mm 30'0"	kg lb											*18 150 *40,350	*18 150 *40,350	6820 21'10"
7500 mm 25'0"	kg lb							*18 850 *41,450	*18 850 *41,450			*17 100 *37,750	*17 100 *37,750	8000 25'11"
6000 mm 20'0"	kg lb					*22 600 *48,900	*22 600 *48,900	*19 550 *42,600	19 150 41,250			*16 850 *37,100	14 750 32,750	8770 28'7"
4500 mm 15'0"	kg lb					*25 450 *54,950	*25 450 *54,950	*20 900 *45,300	18 400 39,600	*18 400 *40,100	13 800 29,650	*17 150 *37,750	13 250 29,300	9230 30'2"
3000 mm 10'0"	kg lb					*28 100 *60,650	24 350 52,500	*22 250 *48,150	17 600 37,900	18 600 40,050	13 450 28,900	17 350 38,250	12 500 27,600	9430 30'10"
1500 mm 5'0"	kg lb					*29 450 *63,750	23 350 50,350	*23 100 *50,100	16 950 36,550	18 250 39,300	13 100 28,200	17 200 37,900	12 350 27,200	9380 30'9"
0 mm 0'0"	kg lb			*29 500 *69,100	*29 500 *69,100	*29 300 *63,500	22 950 49,350	*23 150 *50,100	16 600 35,800	18 100	12 950	17 900 39,400	12 800 28,200	9080 29'9"
-1500 mm -5'0"	kg lb		*60,300	*34 600 *75,450	*34 600 *75,450	*27 600 *59,850	22 900 49,300	*21 900 *47,300	16 550 35,700			*18 450 *40,650	14 050 30,950	8500 27'10"
-3000 mm -10'0"	kg lb	*34 200 *74,750	*34 200 *74,750	*29 800 *64,700	*29 800 *64,700	*24 100 *51,950	23 250 50,050	*18 350	16 950			*17 950 *39,500	16 700 37,050	7590 24'9"
-4500 mm -15'0"	kg lb			*21 750 *46,400	*21 750 *46,400	*16 700	*16 700					*15 900 *34,600	*15 900 *34,600	6170 19'11"



ISO 10567:2007



*Indicates that the load is limited by hydraulic lifting capacity rather than tipping load. The above loads are in compliance with hydraulic excavator lift capacity standard ISO 10567:2007. They do not exceed 87% of hydraulic lifting capacity or 75% of tipping load. Weight of all lifting accessories must be deducted from the above lifting capacities. Lifting capacities are based on the machine standing on a firm, uniform supporting surface. The use of a work tool attachment point to handle/lift objects, could affect the machine lift performance.

**Lift capacities apply to both standard counterweight and counterweight with removal device.

Lift capacity stays with ±5% for all available track shoes.

Always refer to the appropriate Operation and Maintenance Manual for specific product information.

374 Hydraulic Excavator Specifications

Mass Boom Lift Capacities – Standard Counterweight** – without Bucket, Heavy Lift: On

Long Variable Gauge Undercarriage

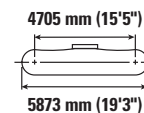
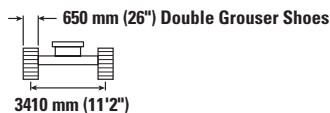

Boom Length	Unit	3000 mm/10'0"		4500 mm/15'0"		6000 mm/20'0"		7500 mm/25'0"		9000 mm/30'0"		mm ft/in		
		kg lb	kg lb	kg lb	kg lb	kg lb	kg lb	kg lb	kg lb	kg lb	kg lb	kg lb	kg lb	mm ft/in
9000 mm 30'0"	kg lb											*18 150 *40,350	*18 150 *40,350	6820 21'10"
7500 mm 25'0"	kg lb							*18 850 *41,450	*18 850 *41,450			*17 100 *37,750	*17 100 *37,750	8000 25'11"
6000 mm 20'0"	kg lb					*22 600 *48,900	*22 600 *48,900	*19 550 *42,600	19 000 40,850			*16 850 *37,100	14 600 32,450	8770 28'7"
4500 mm 15'0"	kg lb					*25 450 *54,950	*25 450 *54,950	*20 900 *45,300	18 200 39,250	*18 400 *40,100	13 700 29,400	*17 150 *37,750	13 150 29,000	9230 30'2"
3000 mm 10'0"	kg lb					*28 100 *60,650	24 150 52,050	*22 250 *48,150	17 450 37,550	18 450 39,650	13 300 28,600	17 150 37,850	12 400 27,300	9430 30'10"
1500 mm 5'0"	kg lb					*29 450 *63,750	23 150 49,850	*23 100 *50,100	16 800 36,200	18 100 38,950	12 950 27,950	17 050 37,500	12 250 26,950	9380 30'9"
0 mm 0'0"	kg lb			*29 500 *69,100	*29 500 *69,100	*29 300 *63,500	22 700 48,850	*23 150 *50,100	16 450 35,450	17 900	12 800	17 700 39,000	12 650 27,900	9080 29'9"
-1500 mm -5'0"	kg lb		*60,300	*34 600 *75,450	*34 600 *75,450	*27 600 *59,850	22 700 48,800	*21 900 *47,300	16 400 35,350			*18 450 *40,650	13 900 30,650	8500 27'10"
-3000 mm -10'0"	kg lb	*34 200 *74,750	*34 200 *74,750	*29 800 *64,700	*29 800 *64,700	*24 100 *51,950	23 050 49,600	*18 350	16 750			*17 950 *39,500	16 550 36,700	7590 24'9"
-4500 mm -15'0"	kg lb			*21 750 *46,400	*21 750 *46,400	*16 700	*16 700					*15 900 *34,600	*15 900 *34,600	6170 19'11"



ISO 10567:2007



*Indicates that the load is limited by hydraulic lifting capacity rather than tipping load. The above loads are in compliance with hydraulic excavator lift capacity standard ISO 10567:2007. They do not exceed 87% of hydraulic lifting capacity or 75% of tipping load. Weight of all lifting accessories must be deducted from the above lifting capacities. Lifting capacities are based on the machine standing on a firm, uniform supporting surface. The use of a work tool attachment point to handle/lift objects, could affect the machine lift performance.

**Lift capacities apply to both standard counterweight and counterweight with removal device.

Lift capacity stays with ±5% for all available track shoes.

Always refer to the appropriate Operation and Maintenance Manual for specific product information.

374 Hydraulic Excavator Specifications

Bucket Specifications and Compatibility – Australia and New Zealand

	Undercarriage Counterweight							Long Variable Gauge			
	Width		Capacity		Weight		Fill	11.24 mt (24,770 lb)			
	mm	in	m ³	yd ³	kg	lb		%	7.8 m (25'7") Reach Boom		7.0 m (23'0") Mass Boom
								R2.84 m (9'4")	R3.6 m (11'10")	M2.57 m (8'5")	M3.0 m (9'10")
No Coupler											
Severe Duty	1600	64	2.90	3.79	3455	7,617	90	●	●		
	1750	70	3.30	4.32	3651	8,050	90	●	●		
	2000	79	3.80	4.97	4015	8,851	90	●	⊙		
Severe Duty Spade	2150	85	4.60	6.02	5134	11,319	90			●	⊙
	2200	87	4.60	6.02	5166	11,390	90			●	⊙
Extreme Duty Spade	2050	81	4.40	5.75	5768	12,717	90			●	⊙
	2150	85	4.60	6.02	5955	13,129	90			⊙	⊖
Maximum load with pin-on (payload + bucket)							kg	11 170	10 035	13 795	12 680
							lb	2,4626	22,123	30,413	27,955
With Cat Pin Grabber Coupler											
Severe Duty	1600	64	2.90	3.79	3455	7,617	90	●	⊙		
	1750	70	3.30	4.32	3651	8,050	90	●	⊖		
	2000	79	3.80	4.97	4015	8,851	90	⊖	○		
Maximum load with coupler (payload + bucket)							kg	9778	8640		
							lb	21,557	19,048		

The above loads are in compliance with hydraulic excavator standard EN474-5:2006 + A3:2013, they do not exceed 87% of hydraulic lifting capacity or 75% of tipping capacity with front linkage fully extended at ground line with bucket curled. Capacity based on ISO 7451:2007.

Bucket weight with General Duty tips.

Caterpillar recommends using appropriate work tools to maximize the value customers receive from our products. Use of work tools, including buckets, which are outside of Caterpillar's recommendations or specifications for weight, dimensions, flows, pressures, etc. may result in less-than-optimal performance, including but not limited to reductions in production, stability, reliability, and component durability. Improper use of a work tool resulting in sweeping, prying, twisting and/or catching of heavy loads will reduce the life of the boom and stick.

Maximum Material Density:

- 2100 kg/m³ (3,500 lb/yd³)
- ⊙ 1800 kg/m³ (3,000 lb/yd³)
- ⊖ 1500 kg/m³ (2,500 lb/yd³)
- 1200 kg/m³ (2,000 lb/yd³)

374 Hydraulic Excavator Specifications

Bucket Specifications and Compatibility – Chile

								Undercarriage	Long Variable Gauge	
								Counterweight	11.24 mt (24,780 lb)	
	Width		Capacity		Weight		Fill	7.0 m (23'0") Mass Boom		
	mm	in	m ³	yd ³	kg	lb	%	M2.57 m (8'5")	M3.0 m (9'10")	
No Coupler										
Severe Duty Spade	1950	77	4.10	5.36	4821	10,629	90	●	●	
	2050	81	4.40	5.75	4977	10,973	90	●	⊙	
	2150	85	4.60	6.02	5134	11,319	90	●	⊙	
Extreme Duty Spade	2150	85	4.60	6.02	6234	13,744	90	⊙	⊖	
Maximum load with pin-on (payload + bucket)							kg	13 611	12 502	
							lb	30,005	27,558	
With CW-70										
Severe Duty Spade	1950	77	4.00	5.23	4795	10,572	90	●	⊙	
	2050	81	4.40	5.75	4950	10,913	90	⊙	⊖	
Extreme Duty Spade	2050	81	4.40	5.75	5551	12,238	90	⊙	⊖	
Maximum load with pin-on (payload + bucket)							kg	12 331	11 ,222	
							lb	27,185	24,740	

The above loads are in compliance with hydraulic excavator standard EN474-5:2006 + A3:2013, they do not exceed 87% of hydraulic lifting capacity or 75% of tipping capacity with front linkage fully extended at ground line with bucket curled.

Capacity based on ISO 7451:2007.

Bucket weight with General Duty tips.

Maximum Material Density:

- 2100 kg/m³ (3,500 lb/yd³)
- ⊙ 1800 kg/m³ (3,000 lb/yd³)
- ⊖ 1500 kg/m³ (2,500 lb/yd³)

Caterpillar recommends using appropriate work tools to maximize the value customers receive from our products. Use of work tools, including buckets, which are outside of Caterpillar's recommendations or specifications for weight, dimensions, flows, pressures, etc. may result in less-than-optimal performance, including but not limited to reductions in production, stability, reliability, and component durability. Improper use of a work tool resulting in sweeping, prying, twisting and/or catching of heavy loads will reduce the life of the boom and stick.

374 Hydraulic Excavator Specifications

Bucket Specifications and Compatibility – North America

	Undercarriage							Long Variable Gauge							
	Counterweight							11.24 mt (24,770 lb)				11.3 mt (24,910 lb) with Removal Device			
	Width		Capacity		Weight		Fill	7.8 m (25'7") Reach Boom			7.0 m (23'0") Mass Boom	7.8 m (25'7") Reach Boom			7.0 m (23'0") Mass Boom
	mm	in	m ³	yd ³	kg	lb	%	R3.6 m (11'10")	R4.15 m (13'7")	R4.67 m (15'4")	M2.57 m (8'5")	R3.6 m (11'10")	R4.15 m (13'7")	R4.67 m (15'4")	M2.57 m (8'5")
No Coupler															
General Duty	2000	79	3.80	4.97	3754	8,276	100	⊖	⊖	○		⊖	⊖	○	
General Duty – Extra Large	2050	82	4.60	6.02	3995	8,807	100	○	◇	◇		○	○	◇	
Heavy Duty	1300	52	2.20	2.88	2918	6,432	100	●	●	●		●	●	●	
	1750	70	3.30	4.32	3559	7,847	100	⊙	⊙	⊖		⊙	⊙	⊖	
	2000	79	3.80	4.97	3915	8,631	100	⊖	○	○		⊖	○	○	
Severe Duty	1150	47	1.90	2.49	2847	6,276	90	●	●	●		●	●	●	
	1600	64	2.90	3.79	3455	7,617	90	●	●	⊙		●	●	⊙	
	1750	70	3.30	4.32	3651	8,050	90	●	⊙	⊖		●	⊙	⊖	
	2000	79	3.80	4.97	4015	8,851	90	⊙	⊖	○		⊙	⊖	○	
Extreme Duty	2000	79	3.84	5.02	4472	9,860	90	⊖	○	◇		⊖	○	○	
Severe Duty Spade	1950	77	4.10	5.36	4821	10,629	90				●				●
	2050	81	4.40	5.75	4977	10,973	90				●				●
	2150	85	4.60	6.02	5134	11,319	90				●				●
Extreme Duty Spade	2150	85	4.60	6.02	6234	13,744	90				⊙				⊙
Maximum load with pin-on (payload + bucket)							kg	10 034	9210	8408	13 797	10 071	9245	8441	13 845
							lb	22,123	20,305	18,541	30,413	22,201	20,382	18,607	30,523
With Cat Pin Grabber Coupler															
General Duty	2000	79	3.80	4.97	3754	8,276	100	○	◇	◇		○	◇	◇	
General Duty – Extra Large	2050	82	4.60	6.02	3995	8,807	100	◇	X	X		◇	X	X	
Heavy Duty	1300	52	2.20	2.88	2918	6,432	100	●	●	⊙		●	●	⊙	
	1750	70	3.30	4.32	3559	7,847	100	⊖	○	◇		⊖	○	◇	
	2000	79	3.80	4.97	3915	8,631	100	○	◇	X		○	◇	X	
Severe Duty	1150	47	1.90	2.49	2847	6,276	90	●	●	●		●	●	●	
	1600	64	2.90	3.79	3455	7,617	90	⊙	⊖	○		●	⊖	○	
	1750	70	3.30	4.32	3651	8,050	90	⊖	○	◇		⊖	○	○	
	2000	79	3.80	4.97	4015	8,851	90	○	◇	◇		○	◇	◇	
Extreme Duty	2000	79	3.84	5.02	4472	9,860	90	○	◇	X		○	◇	X	
Maximum load with coupler (payload + bucket)							kg	8640	7816	7014		8677	7851	7047	
							lb	19,048	17,231	15,463		19,130	17,309	15,536	

Maximum Material Density:

- 2100 kg/m³ (3,500 lb/yd³)
- ⊙ 1800 kg/m³ (3,000 lb/yd³)
- ⊖ 1500 kg/m³ (2,500 lb/yd³)
- 1200 kg/m³ (2,000 lb/yd³)
- ◇ 900 kg/m³ (1,500 lb/yd³)
- X Not Recommended

The above loads are in compliance with hydraulic excavator standard EN474-5:2006 + A3:2013, they do not exceed 87% of hydraulic lifting capacity or 75% of tipping capacity with front linkage fully extended at ground line with bucket curled.

Capacity based on ISO 7451:2007.

Bucket weight with General Duty tips.

Caterpillar recommends using appropriate work tools to maximize the value customers receive from our products. Use of work tools, including buckets, which are outside of Caterpillar's recommendations or specifications for weight, dimensions, flows, pressures, etc. may result in less-than-optimal performance, including but not limited to reductions in production, stability, reliability, and component durability. Improper use of a work tool resulting in sweeping, prying, twisting and/or catching of heavy loads will reduce the life of the boom and stick.

374 Hydraulic Excavator Specifications

Bucket Specifications and Compatibility – South Korea

	Undercarriage Counterweight							Long Variable Gauge	
	Width		Capacity		Weight		Fill	11.24 mt (24,770 lb)	
	mm	in	m ³	yd ³	kg	lb		%	7.8 m (25'7") Reach Boom
No Coupler									
Severe Duty	1950	77	3.00	3.92	3660	8,068	90	●	
Severe Duty Spade	2200	87	4.60	6.02	5166	11,390	90		●
	2250	89	5.00	6.54	5291	11,665	90		◎
Extreme Duty Spade	2200	87	4.40	5.75	5790	12,765	90		●
Maximum load with pin-on (payload + bucket)							kg	11 170	13 795
							lb	24,626	30,413

The above loads are in compliance with hydraulic excavator standard EN474-5:2006 + A3:2013, they do not exceed 87% of hydraulic lifting capacity or 75% of tipping capacity with front linkage fully extended at ground line with bucket curled.

Capacity based on ISO 7451:2007.

Bucket weight with General Duty tips.

Maximum Material Density:

● 2100 kg/m³ (3,500 lb/yd³)

◎ 1800 kg/m³ (3,000 lb/yd³)

Caterpillar recommends using appropriate work tools to maximize the value customers receive from our products. Use of work tools, including buckets, which are outside of Caterpillar's recommendations or specifications for weight, dimensions, flows, pressures, etc. may result in less-than-optimal performance, including but not limited to reductions in production, stability, reliability, and component durability. Improper use of a work tool resulting in sweeping, prying, twisting and/or catching of heavy loads will reduce the life of the boom and stick.

374 Hydraulic Excavator Specifications

Bucket Specifications and Compatibility – Turkey

	Undercarriage							Long Variable Gauge			
	Counterweight							11.24 mt (24,770 lb)		11.3 mt (24,910 lb) with Removal Device	
	Width		Capacity		Weight		Fill	7.0 m (23'0") Mass		7.0 m (23'0") Mass	
	mm	in	m ³	yd ³	kg	lb	%	M2.57 m (8'5")	M3.0 m (9'10")	M2.57 m (8'5")	M3.0 m (9'10")
No Coupler											
General Duty	2150	85	5.00	6.54	4164	9,180	100	☉	☉	☉	☉
Heavy Duty	2150	85	5.00	6.54	4340	9,569	100	☉	☉	☉	☉
Severe Duty Spade	1950	77	4.10	5.36	4821	10,629	90	●	●	●	●
	2050	81	4.40	5.75	4977	10,973	90	●	☉	●	☉
	2150	85	4.60	6.02	5134	11,319	90	●	☉	●	☉
	2250	89	5.00	6.54	5291	11,665	90	☉	☉	☉	☉
Extreme Duty Spade	2050	81	4.40	5.75	5768	12,717	90	☉	☉	☉	☉
	2150	85	4.60	6.02	5955	13,129	90	☉	☉	☉	☉
	2250	89	5.00	6.54	6139	13,535	90	☉	☉	☉	☉
Maximum load with pin-on (payload + bucket)							kg	13 611	12 502	13 659	12 548
							lb	30,005	27,558	30,115	27,668
With CW-70											
Severe Duty Spade	1950	77	4.00	5.23	4795	10,572	90	●	☉	●	☉
	2050	81	4.40	5.75	4950	10,913	90	☉	☉	☉	☉
Extreme Duty Spade	2050	81	4.40	5.75	5551	12,238	90	☉	☉	☉	☉
Maximum load with coupler (payload + bucket)							kg	12 331	11 222	12 379	11 268
							lb	27,185	24,740	27,291	24,842

Maximum Material Density:

- 2100 kg/m³ (3,500 lb/yd³)
- ☉ 1800 kg/m³ (3,000 lb/yd³)
- ☉ 1500 kg/m³ (2,500 lb/yd³)
- 1200 kg/m³ (2,000 lb/yd³)

The above loads are in compliance with hydraulic excavator standard EN474-5:2006 + A3:2013, they do not exceed 87% of hydraulic lifting capacity or 75% of tipping capacity with front linkage fully extended at ground line with bucket curled.

Capacity based on ISO 7451:2007.

Bucket weight with General Duty tips.

Caterpillar recommends using appropriate work tools to maximize the value customers receive from our products. Use of work tools, including buckets, which are outside of Caterpillar's recommendations or specifications for weight, dimensions, flows, pressures, etc. may result in less-than-optimal performance, including but not limited to reductions in production, stability, reliability, and component durability. Improper use of a work tool resulting in sweeping, prying, twisting and/or catching of heavy loads will reduce the life of the boom and stick.

374 Hydraulic Excavator Specifications

Typical Pass Match Guide

For maximum production and efficiency, we recommend that loading and hauling machines are matched to achieve optimal performance.

Configuration*:

Long Variable Gauge undercarriage, Reach boom, R4.67VB (15'4") stick, SD 3.3 m³ (4.32 yd³) bucket, 900 mm (35") HD double grouser shoes and standard counterweight.

Passes Required to Fill Trucks to Rated Capacity

Material Type	Material Density	Cat Articulated Trucks							Cat Off-Highway Trucks
		725	730 EJ	730	735	740 GC	740 EJ	745	770G
Earth	1600 kg/m ³ (2,700 lb/yd ³)	4-5	5	5-6	6	7	7	8	7
Limestone	1540 kg/m ³ (2,600 lb/yd ³)	5	6	6	7	8	8		8

*The indicated pass match reflects the machine configuration, fill factor, and typical material density shown. Changes to machine configurations, fill factors, or material density as well as jobsite-specific factors may influence exact pass match recommendations for your application. Consult your Cat dealer for more information.

Configuration*:

Long Variable Gauge undercarriage, Mass boom, M2.57WB (8'5") stick, XD 4.4 m³ (5.75 yd³) bucket, 650 mm (26") HD double grouser shoes and and standard counterweight.

Passes Required to Fill Trucks to Rated Capacity

Material Type	Material Density	Cat Articulated Trucks						Cat Off-Highway Trucks		
		730 EJ	730	735	740 GC	740 EJ	745	770G	772G	773G
Earth	1600 kg/m ³ (2,700 lb/yd ³)	4	4	4-5	5	5-6	6	5-6	6-7	8
Limestone	1540 kg/m ³ (2,600 lb/yd ³)	4-5	4-5	5	6	6	7	6	8	

*The indicated pass match reflects the machine configuration, fill factor, and typical material density shown. Changes to machine configurations, fill factors, or material density as well as jobsite-specific factors may influence exact pass match recommendations for your application. Consult your Cat dealer for more information.

374 Hydraulic Excavator Specifications

Attachments Offering Guide – Australia and New Zealand

Not all attachments are available in all regions. Consult your Cat dealer for configurations available in your region.

Match
 Working range front only
 No Match

PIN-ON ATTACHMENTS

Undercarriage		Long Variable Gauge			
Counterweight		11.24 mt (24,770 lb)			
Boom Type		Reach		Mass	
Stick Length		2.84 m (9'4")	3.6 m (11'10")	2.57 m (8'5")	3.0 m (9'10")
Hydraulic Hammers	H180 S	✓	✓	✓	✓
	H190 S	✓	✓	✓	✓
	H215 S	✓	✓	✓	✓
Mobile Scrap and Demolition Shears	S3070 Flat Top	✓	✓	✓	✓

CAT PIN GRABBER COUPLER ATTACHMENTS

Undercarriage		Long Variable Gauge	
Counterweight		11.24 mt (24,770 lb)	
Boom Type		Reach	
Stick Length		2.84 m (9'4")	3.6 m (11'10")
Hydraulic Hammers	H180 S	✓	✓
	H190 S	✓	✓
	H215 S	✓	✓*
Mobile Scrap and Demolition Shears	S3070	✓	✓*
	S3070 Flat Top	✓*	

374 Hydraulic Excavator Specifications

Attachments Offering Guide – Chile

Not all attachments are available in all regions. Consult your Cat dealer for configurations available in your region.

Match
 No Match
 1800 kg/m³ (3,000 lb/yd³)
 1200 kg/m³ (2,000 lb/yd³)

PIN-ON ATTACHMENTS

Undercarriage		Long Variable Gauge	
Counterweight		11.24 mt (24,770 lb)	
Boom Type		Mass	
Stick Length		2.57 m (8'5")	3.00 m (9'10")
Hydraulic Hammers	H180 S	✓	✓
	H190 S	✓	✓
	H215 S	✓	✓
Multi-Processors	MP365 Concrete Cutter Jaw	✓	✓
	MP365 Demolition Jaw	✓	✓
	MP365 Pulverizer Jaw	✓	✓
	MP365 Shear Jaw	✓	✓
Mobile Scrap and Demolition Shears	S3070 Flat Top	✓	✓
Pulverizers	P365 Primary Pulverizer	✓	✓
Clamshell Grapples	CTV40-3800	●	○
	CTV40-4600	○	○
	CTV40-5000	○	○
	CTV40-5400	○	○

CW-70 DEDICATED COUPLER ATTACHMENTS

Undercarriage		Long Variable Gauge	
Counterweight		11.24 mt (24,770 lb)	
Boom Type		Mass	
Stick Length		2.57 m (8'5")	3.00 m (9'10")
Hydraulic Hammers	H180 S	✓	✓
	H190 S	✓	✓
	H215 S	✓	✓
Multi-Processors	MP365 Concrete Cutter Jaw	✓	✓
	MP365 Demolition Jaw	✓	✓
	MP365 Pulverizer Jaw	✓	✓
	MP365 Shear Jaw	✓	✓
	MP365 Concrete Cutter Jaw-Flat Top	✓	✓
	MP365 Demolition Jaw-Flat Top	✓	✓
	MP365 Pulverizer Jaw-Flat Top	✓	✓
	MP365 Shear Jaw-Flat Top	✓	✓
Mobile Scrap and Demolition Shears	S3070 Flat Top	✓	✓
Pulverizers	P365 Primary Pulverizer	✓	✓
	P365 Primary Pulverizer-Flat Top	✓	✓

BOOM-MOUNT ATTACHMENTS

Undercarriage		Long Variable Gauge	
Counterweight		11.24 mt (24,770 lb)	
Boom Type		Mass	
Mobile Scrap and Demolition Shears	S2090	✓	

374 Hydraulic Excavator Specifications

Attachments Offering Guide – North America

Not all attachments are available in all regions. Consult your Cat dealer for configurations available in your region.

Match
 Working range front only
 No Match
 1800 kg/m³ (3,000 lb/yd³)
 1200 kg/m³ (2,000 lb/yd³)

PIN-ON ATTACHMENTS

Undercarriage		Long Variable Gauge									
Counterweight		10.0 MT (Removeable)					11.24 mt (24,770 lb)				
Boom Type		Reach HD				ME	Reach HD				ME
Stick Length		2.84 m HD (9'4")	3.60 m HD (11'10")	4.15 m HD (13'7")	4.67 m HD (15'4")	2.57 m (8'5")	2.84 m HD (9'4")	3.60 m HD (11'10")	4.15 m HD (13'7")	4.67 m HD (15'4")	2.57 m (8'5")
Hydraulic Hammers	H180 S	✓	✓	✓	✓	✓	✓	✓	✓	✓	✓
	H190 S	✓	✓	✓	✓	✓	✓	✓	✓	✓	✓
	H215 S	✓	✓	✓	✓*	✓	✓	✓	✓	✓*	✓
Multi-Processors	MP365 Concrete Cutter Jaw	✓	✓	✓	✓	✓	✓	✓	✓	✓	✓
	MP365 Concrete Cutter Jaw-Flat Top	✓	✓	✓	✓						
	MP365 Demolition Jaw	✓	✓	✓	✓	✓	✓	✓	✓	✓	✓
	MP365 Demolition Jaw-Flat Top	✓	✓	✓	✓*						
	MP365 Pulverizer Jaw	✓	✓	✓	✓	✓	✓	✓	✓	✓	✓
	MP365 Pulverizer Jaw-Flat Top	✓	✓	✓	✓*						
	MP365 Shear Jaw	✓	✓	✓	✓	✓	✓	✓	✓	✓	✓
MP365 Shear Jaw-Flat Top	✓	✓	✓	✓							
Mobile Scrap and Demolition Shears	S3070 Flat Top	✓	✓	✓*		✓	✓	✓	✓*		✓
Pulverizers	P245 Secondary Pulverizer	✓	✓	✓	✓		✓	✓	✓	✓	
	P365 Primary Pulverizer	✓	✓	✓	✓	✓	✓	✓	✓	✓	✓
	P365 Primary Pulverizer-Flat Top	✓	✓	✓	✓*		✓	✓	✓	✓*	
Clamshell Grapples	CTV40-3800	○	○			●	○	○			●
	CTV40-4600					○					○
	CTV40-5000					○					○
	CTV40-5400					○					○

CAT PIN GRABBER COUPLER ATTACHMENTS

Undercarriage		Long Variable Gauge							
Counterweight		10.0 MT (Removeable)				11.24 mt (24,770 lb)			
Boom Type		Reach HD				Reach HD			
Stick Length		2.84 m HD (9'4")	3.60 m HD (11'10")	4.15 m HD (13'7")	4.67 m HD (15'4")	2.84 m HD (9'4")	3.60 m HD (11'10")	4.15 m HD (13'7")	4.67 m HD (15'4")
Hydraulic Hammers	H180 S	✓	✓	✓	✓	✓	✓	✓	✓
	H190 S	✓	✓	✓	✓	✓	✓	✓	✓
	H215 S	✓	✓*			✓	✓*		
Multi-Processors	MP365 Concrete Cutter Jaw	✓	✓	✓	✓*	✓	✓	✓	✓*
	MP365 Concrete Cutter Jaw-Flat Top	✓	✓						
	MP365 Demolition Jaw	✓	✓	✓*		✓	✓	✓*	
	MP365 Demolition Jaw-Flat Top	✓	✓*						
	MP365 Pulverizer Jaw	✓	✓	✓*		✓	✓	✓*	
	MP365 Pulverizer Jaw-Flat Top	✓	✓*						
	MP365 Shear Jaw	✓	✓	✓	✓*	✓	✓	✓	✓*
MP365 Shear Jaw-Flat Top	✓	✓*							
Mobile Scrap and Demolition Shears	S3070 Flat Top	✓*				✓*			
Pulverizers	P245 Secondary Pulverizer	✓	✓	✓	✓	✓	✓	✓	✓
	P365 Primary Pulverizer	✓	✓	✓*		✓	✓	✓*	
	P365 Primary Pulverizer-Flat Top	✓				✓			

(continued on next page)

374 Standard and Optional Equipment

Attachments Offering Guide – North America (continued)

Not all attachments are available in all regions. Consult your Cat dealer for configurations available in your region.

Match Working range front only No Match

CW-70 DEDICATED COUPLER ATTACHMENTS

Undercarriage		Long Variable Gauge									
Counterweight		10.0 MT (Removeable)					11.24 mt (24,770 lb)				
Boom Type		Reach HD				ME	Reach HD				ME
Stick Length		2.84 m HD (9'4")	3.60 m HD (11'10")	4.15 m HD (13'7")	4.67 m HD (15'4")	2.57 m (8'5")	2.84 m HD (9'4")	3.60 m HD (11'10")	4.15 m HD (13'7")	4.67 m HD (15'4")	2.57 m (8'5")
Hydraulic Hammers	H180 S	✓	✓	✓	✓	✓	✓	✓	✓	✓	✓
	H190 S	✓	✓	✓	✓	✓	✓	✓	✓	✓	✓
	H215 S	✓	✓*			✓	✓	✓*			✓
Multi-Processors	MP365 Concrete Cutter Jaw	✓	✓	✓	✓*	✓	✓	✓	✓	✓*	✓
	MP365 Concrete Cutter Jaw-Flat Top	✓	✓	✓*		✓					
	MP365 Demolition Jaw	✓	✓	✓	✓*	✓	✓	✓	✓	✓*	✓
	MP365 Demolition Jaw-Flat Top	✓	✓*			✓					
	MP365 Pulverizer Jaw	✓	✓	✓*		✓	✓	✓	✓*		✓
	MP365 Pulverizer Jaw-Flat Top	✓	✓*			✓					
	MP365 Shear Jaw	✓	✓	✓	✓*	✓	✓	✓	✓	✓*	✓
	MP365 Shear Jaw-Flat Top	✓	✓			✓					
Mobile Scrap and Demolition Shears	S3070 Flat Top	✓*				✓	✓*				✓
Pulverizers	P365 Primary Pulverizer	✓	✓	✓*		✓	✓	✓	✓		✓
	P365 Primary Pulverizer-Flat Top	✓	✓*			✓	✓	✓*			✓

BOOM-MOUNT ATTACHMENTS

Undercarriage		Long Variable Gauge									
Counterweight		10.0 MT (Removeable)					11.24 mt (24,770 lb)				
Boom Type		Reach HD				ME	Reach HD				ME
Mobile Scrap & Demolition Shears	S2090	✓				✓	✓				✓

374 Hydraulic Excavator Specifications

Attachments Offering Guide – Turkey

Not all attachments are available in all regions. Consult your Cat dealer for configurations available in your region.



Match



1800 kg/m³ (3,000 lb/yd³)



1200 kg/m³ (2,000 lb/yd³)

PIN-ON ATTACHMENTS

Undercarriage		Long Variable Gauge			
		11.24 mt (24,770 lb)		10.0 MT (Removal)	
Counterweight		Mass		Mass	
Boom Type		Mass		Mass	
Stick Length		2.57 m (8'5")	3.00 m (9'10")	2.57 m (8'5")	3.00 m (9'10")
Hydraulic Hammers	H180 S	✓	✓	✓	✓
	H190 S	✓	✓	✓	✓
	H215 S	✓	✓	✓	✓
Multi-Processors	MP365 Concrete Cutter Jaw	✓	✓	✓	✓
	MP365 Demolition Jaw	✓	✓	✓	✓
	MP365 Pulverizer Jaw	✓	✓	✓	✓
	MP365 Shear Jaw	✓	✓	✓	✓
Mobile Scrap and Demolition Shears	S3070 Flat Top	✓	✓	✓	✓
Pulverizers	P365 Primary Pulverizer	✓	✓	✓	✓
Orange Peel Grapples	GSM-60-1250	●	●	●	●
	GSM-60-1500	●	●	●	●
	GSM-60-2000	●	●	●	●
	GSM-60-2500	○	○	○	○
	GSM-60-3750	○	○	○	○
Clamshell Grapples	CTV40-3500	●	●	●	●
	CTV40-4000	●	○	●	○
	CTV40-4500	○	○	○	○
	CTV40-5000	○	○	○	○

CW-70 DEDICATED COUPLER ATTACHMENTS

Undercarriage		Long Variable Gauge			
		11.24 mt (24,770 lb)		10.0 MT (Removal)	
Counterweight		Mass		Mass	
Boom Type		Mass		Mass	
Stick Length		2.57 m (8'5")	3.00 m (9'10")	2.57 m (8'5")	3.00 m (9'10")
Hydraulic Hammers	H180 S	✓	✓	✓	✓
	H190 S	✓	✓	✓	✓
	H215 S	✓	✓	✓	✓
Multi-Processors	MP365 Concrete Cutter Jaw	✓	✓	✓	✓
	MP365 Demolition Jaw	✓	✓	✓	✓
	MP365 Pulverizer Jaw	✓	✓	✓	✓
	MP365 Shear Jaw	✓	✓	✓	✓
	MP365 Concrete Cutter Jaw-Flat Top	✓	✓	✓	✓
	MP365 Demolition Jaw-Flat Top	✓	✓	✓	✓
	MP365 Pulverizer Jaw-Flat Top	✓	✓	✓	✓
	MP365 Shear Jaw-Flat Top	✓	✓	✓	✓
Mobile Scrap and Demolition Shears	S3070 Flat Top	✓	✓	✓	✓
Pulverizers	P365 Primary Pulverizer	✓	✓	✓	✓
	P365 Primary Pulverizer-Flat Top	✓	✓	✓	✓

BOOM-MOUNT ATTACHMENTS

Undercarriage		Long Variable Gauge			
		11.24 mt (24,770 lb)		10.0 MT (Removal)	
Counterweight		Mass		Mass	
Boom Type		Mass		Mass	
Mobile Scrap and Demolition Shears	S2090	✓		✓	

Standard and Optional Equipment

Standard and optional equipment may vary. Consult your Cat dealer for details.

	Standard	Optional		Standard	Optional
BOOMS, STICKS AND LINKAGES			ELECTRICAL SYSTEM		
7.0 m (23'0") Mass boom		✓	Maintenance-free 1,400 CCA batteries (×2)	✓	
7.8 m (25'7") Reach boom		✓	Centralized electrical disconnect switch	✓	
2.57 (8'5") Mass stick		✓	Chassis light	✓	
3.00 (9'10") Mass stick		✓	LED boom and cab lights		✓
2.84 (9'4") Reach stick ¹		✓	Exterior lights (integrated into storage box)	✓	
3.60 (11'10") Reach stick ²		✓	ENGINE		
4.15 (13'7") Reach stick ³		✓	Cold start block heater ¹⁰		✓
4.67 (15'4") Reach stick ⁴		✓	Three selectable modes: Power, Smart, Eco	✓	
Bucket Linkage, VB family with lifting eye, Cat Grade ⁵		✓	Automatic engine speed control	✓	
Bucket Linkage, VB family without lifting eye, Cat Grade ⁶		✓	Up to 4500 m (14,764 ft) altitude capability	✓	
Bucket Linkage, WB family with lifting eye, Cat Grade ⁷		✓	52° C (126° F) high-ambient cooling capacity	✓	
Bucket Linkage, WB family without lifting eye, Cat Grade ⁸		✓	-18° C (0° F) cold start capability	✓	
CAT TECHNOLOGY			-32° C (-25° F) cold start capability		✓
VisionLink [®]	✓*		Hydraulic reverse fan	✓	
VisionLink Productivity		✓	Double element filter with integrated pre-cleaner air filter	✓	
Remote Flash	✓		3 vertical side-by-side cooling system	✓	
Remote Troubleshoot	✓		95 Amp alternator	✓	
Operator Coaching	✓		¹ All regions except North America ² All regions except South Korea ³ North America only ⁴ North America only ⁵ All regions except South Korea ⁶ South Korea only ⁷ All regions except South Korea ⁸ All regions except Australia and New Zealand ⁹ North America only ¹⁰ Not available in Australia and New Zealand		
Cat Grade Connectivity		✓	<i>(continued on next page)</i>		
Compatibility with radios and base stations from Trimble, Topcon, and Leica	✓				
Capability to install 3D grade systems from Trimble, Topcon, and Leica	✓				
Cat Grade 2D	✓				
Cat Grade 2D with Attachment Ready Option (ARO)		✓			
Cat Grade 3D single GNSS		✓			
Cat Grade 3D dual GNSS		✓			
Laser catcher		✓			
Cat Assist:	✓				
– Grade Assist					
– Boom Assist					
– Bucket Assist					
– Swing Assist					
– Lift Assist					
Cat Payload:	✓				
– Static weigh					
– Semiautomatic calibration					
– Payload/cycle information					
– USB reporting capability					
Work tool recognition (PL161)	✓				
Work tool tracking (PL161)	✓				
Cat Tilt Rotator (TRS) Integration		✓			

374 Standard and Optional Equipment

Standard and Optional Equipment (continued)

Standard and optional equipment may vary. Consult your Cat dealer for details.

	Standard	Optional		Standard	Optional
HYDRAULIC SYSTEM			SERVICE AND MAINTENANCE		
Boom and stick regeneration circuit	✓		Integrated vehicle health management system	✓	
Electronic main control valve	✓		Auto lube ready	✓	
Dedicated closed loop swing circuit	✓		Grouped location for engine oil and fuel filters	✓	
Auto heavy lift	✓		Scheduled Oil Sampling (S·O·S SM) ports	✓	
Auto dig boost	✓		QuickEvac TM maintenance ready	✓	
Automatic hydraulic oil warmup	✓		Electric refueling pump with auto shutoff		✓
Automatic swing parking brake	✓		UNDERCARRIAGE AND STRUCTURES		
High performance hydraulic return filter	✓		Long variable gauge undercarriage	✓	
Two speed travel	✓		Towing eye on base frame	✓	
Bio hydraulic oil and filter	✓		Three-piece segmented track guiding guards		✓
Advanced tool control		✓	Two-piece full-length track guiding guards		✓
Medium-pressure auxiliary circuit		✓	Swivel guard	✓	
Quick coupler circuit		✓	Grease lubricated track	✓	
Hydraulic efficiency monitoring		✓	Standard counterweight	✓	
SAFETY AND SECURITY			Counterweight with removal device ¹³		✓
Caterpillar One Key security system	✓		650 mm (26") HD double grouser track shoes ¹⁴		✓
2D E-Fence:	✓		750 mm (30") HD double grouser track shoes ¹⁵		✓
– E-ceiling			900 mm (35") HD double grouser track shoes ¹⁶		✓
– E-floor			HD bottom guard	✓	
– E-swing			HD travel motor guard	✓	
– E-wall					
– E-cab avoidance					
Auto hammer stop	✓				
Lockable external tool/storage box	✓				
Lockable door, fuel, and hydraulic tank locks	✓				
Lockable fuel drain compartment	✓				
Service platforms with anti-skid plate	✓				
Lockable disconnect switch	✓				
Right-hand handrail and handhold	✓				
Standard visibility mirror package	✓				
Signaling/warning horn	✓				
Travel alarm	✓ ¹¹	✓ ¹²			
Swing alarm		✓			
Ground-level secondary engine shutoff switch	✓				
Rear and right-hand-sideview cameras	✓				
360° visibility		✓			
Boom lowering check valve		✓			
Stick lowering check valve		✓			
Walkway	✓				
Tilt-up walkway		✓			
Inspection lighting		✓			

¹¹North America only

¹²All regions except North America

¹³North America only

¹⁴All regions except North America

¹⁵All regions except Australia and New Zealand

¹⁶North America only

Dealer Installed Kits and Attachments

Attachments may vary. Consult your Cat dealer for details.

CAB

- Radial lower wiper
- Joystick with horizontal sliders
- Left Hand (LH)/Right Hand (RH) electrical pedal for tool control
- Dual exit rear window kit
- Front windshield laminated glass (P5A glass, EU demolition regulation)

ELECTRICAL

- 1,800 lumen LED premium surround lights

SAFETY AND SECURITY

- Bluetooth® key fob
- 76 mm (3") retractable seat belt
- Cat Detect – People Detection

GUARDS

- OPG (not compatible with cab light cover, rain protector)
- Mesh guard full front (not compatible with cab light cover, rain protector)
- Mesh guard lower half front
- Full protecting vandalism guard
- Rain protector for front windshield plus cab light cover

OTHER ATTACHMENTS

- GNSS antennae

374 Cab Options

Cab Options

	Deluxe	Premium
Sound suppressed cab with viscount mounts	●	●
High-resolution 254 mm (10") LCD touch screen monitor	●	●
Additional high-resolution LCD touch screen monitor for Cat Grade 2D and 3D	○	○
Automatic bi-level air conditioner	●	●
Jog dial and shortcut keys for monitor control	●	●
Keyless push-to-start engine control	●	●
Height-adjustable console, infinite with no tool	●	●
Tilt-up left-side console	●	●
Cat Stick Steer	○	○
Auxiliary relay	○	○
Heated seat with air-adjustable suspension	●	X
Heated and cooled seat with automatic adjustable suspension	X	●
51 mm (2") orange seat belt	●	●
Bluetooth integrated radio (including USB, auxiliary port and microphone)	●	●
2 × 12V DC outlets	●	●
Document storage	●	●
Rear head storage net and lunchbox storage net	●	●
Cup and bottle holders	●	●
Two-piece front window, openable	●	●
Upper radial wiper with washer	●	X
Parallel wiper with washer	X	●
Openable polycarbonate skylight hatch	●	●
LED dome light	●	●
Floor welcome light	●	●
Roller front sunscreen	●	●
Roller rear sunscreen	○	●
Rear window emergency exit	●	●
Washable floor mat	●	●
Beacon ready	●	●

- Standard
- Optional
- X Not available

The following information applies to the machine at the time of final manufacture as configured for sale in the regions covered in this document. The content of this declaration is valid as of the date issued; however, content related to machine features and specifications are subject to change without notice. For additional information, please see the machine's Operation and Maintenance Manual.

For more information on sustainability in action and our progress, please visit <https://www.caterpillar.com/en/company/sustainability>.

Engine

- The Cat® C15 engine meets U.S. EPA Tier 4 Final, EU Stage V, Korea Stage V, and Japan 2014 emission standards.
- Cat diesel engines are required to use ULSD (ultra-low sulfur diesel fuel with 15 ppm of sulfur or less) or ULSD blended with the following lower-carbon intensity fuels** up to:
 - ✓ 20% biodiesel FAME (fatty acid methyl ester)*
 - ✓ 100% renewable diesel, HVO (hydrotreated vegetable oil) and GTL (gas-to-liquid) fuels

Refer to guidelines for successful application. Please consult your Cat dealer or “Caterpillar Machine Fluids Recommendations” (SEBU6250) for details.

**Engines with no aftertreatment devices can use higher blends, up to 100% biodiesel (for use of blends higher than 20% biodiesel, consult your Cat dealer).*

***Tailpipe greenhouse gas emissions from lower-carbon intensity fuels are essentially the same as traditional fuels.*

Air Conditioning System

- The air conditioning system on this machine contains the fluorinated greenhouse gas refrigerant R134a (Global Warming Potential = 1430). The system contains 1.0 kg (2.2 lb) of refrigerant which has a CO₂ equivalent of 1.430 metric tonnes (1.576 tons).

Paint

- Based on best available knowledge, the maximum allowable concentration, measured in parts per million (PPM), of the following heavy metals in paint are:
 - Barium < 0.01%
 - Cadmium < 0.01%
 - Chromium < 0.01%
 - Lead < 0.01%

Sound Performance

ISO 6395:2008 (external) – 108 dB(A)

ISO 6396:2008 (inside cab) – 73 dB(A)

- Hearing protection may be needed when operating with an open operator station and cab (when not properly maintained or doors/windows open) for extended periods or in a noisy environment.

Oils and Fluids

- Caterpillar factory fills with ethylene glycol coolants. Cat Diesel Engine Antifreeze/Coolant (DEAC) and Cat Extended Life Coolant (ELC) can be recycled. Consult your Cat dealer for more information.
- Cat Bio HYDO™ Advanced is an EU Ecolabel approved biodegradable hydraulic oil.
- Additional fluids are likely to be present, please consult the Operations and Maintenance Manual or the Application and Installation guide for complete fluid recommendations and maintenance intervals.

Features and Technology

- The following features and technology may contribute to fuel savings and/or carbon reduction. Features may vary. Consult your Cat dealer for details.
 - Smart mode matches machine power to digging requirements automatically
 - Eco mode minimizes fuel consumption for light applications
 - Standard Cat technologies boost productivity and improve operator efficiency by up to 45%
 - The latest hydraulic oil filter provides longer life with a 3,000-hour replacement interval – 50% longer than previous filter designs
 - Cut costs with extended maintenance intervals

For more complete information on Cat products, dealer services, and industry solutions, visit us on the web at www.cat.com

© 2023 Caterpillar
All rights reserved

Materials and specifications are subject to change without notice. Featured machines in photos may include additional equipment. See your Cat dealer for available options.

CAT, CATERPILLAR, LET'S DO THE WORK, their respective logos, "Caterpillar Corporate Yellow," the "Power Edge" and Cat "Modern Hex" trade dress as well as corporate and product identity used herein, are trademarks of Caterpillar and may not be used without permission. VisionLink is a trademark of Caterpillar Inc., registered in the United States and in other countries.

AEXQ2896-05 (12-2023)
Replaces AEXQ2896-04
Number: 07D
(N Am, Aus-NZ, Chile,
S Korea, Turkey)

