



374

Hydraulic Excavator

Technical Specifications

Configurations and features may vary by region. Please consult your Cat® dealer for availability in your area.

Table of Contents

Specifications	2
Engine	2
Swing Mechanism	2
Weights	2
Track	2
Drive	2
Hydraulic System	2
Service Refill Capacity	2
Standards	2
Sound Performance	2
Operating Weights and Ground Pressures	3
Major Component Weights	4
Dimensions	5
Working Ranges and Forces	9
Reach Boom Lift Capacities	11
Mass Boom Lift Capacities	20
Bucket Specifications and Compatibility:	
Africa, Middle East and Eurasia	26
Australia and New Zealand	27
Hong Kong, Taiwan	28
South America	29
Southeast Asia	29
Truck Pass Match:	
Global	30
Attachments Offering Guide:	
Africa, Middle East and Eurasia	31
Australia and New Zealand	33
South America	34
Southeast Asia, India, Indonesia	35
Standard and Optional Equipment	36
Dealer Installed Kits and Attachments	38
Cab Options	39
374 Environmental Declaration	40

374 Hydraulic Excavator Specifications

Engine

Engine Model	Cat® C15	
Net Power – ISO 9249	358 kW	480 hp
Engine Power – ISO 14396	359 kW	481 hp
Bore	137 mm	5.39 in
Stroke	171 mm	6.73 in
Displacement	15.2 L	928 in ³

- Meets Brazil MAR-1 emission standards, equivalent to U.S. EPA Tier 3 and EU Stage IIIA.
- Recommended for use up to 4500 m (14,760 ft) altitude with engine power derate above 3000 m (9,840 ft).
- Advertised power is tested per the specified standard in effect at the time of manufacture.
- Net power advertised is the power available at the flywheel when the engine is equipped with fan, air intake system, exhaust system and alternator.
- Engine speed at 1,800 rpm.
- Cat engines are compatible with diesel fuel blended with the following lower-carbon intensity fuels** up to:
 - ✓ 100% biodiesel FAME (fatty acid methyl ester)*
 - ✓ 100% renewable diesel, HVO (hydrotreated vegetable oil) and GTL (gas-to-liquid) fuels

Refer to guidelines for successful application. Please consult your Cat dealer or “Caterpillar Machine Fluids Recommendations” (SEBU6250) for details.

*For use of blends higher than 20% biodiesel, consult your Cat dealer.

**Tailpipe greenhouse gas emissions from lower-carbon intensity fuels are essentially the same as traditional fuels.

Swing Mechanism

Swing Speed	6.34 rpm	
Maximum Swing Torque	298 kN·m	220,000 lbf-ft

Weights

Operating Weight	74 000 kg	163,200 lb
------------------	-----------	------------

- Long Variable Gauge undercarriage, Mass boom, M2.57WB (8'5") stick, XD 4.40 m³ (5.75 yd³) bucket, 650 mm (26") HD double grouser shoes and standard counterweight.

Track

Optional Track Shoes Width	650 mm	26 in
Optional Track Shoes Width	750 mm	30 in
Standard Track Shoes Width	900 mm	35 in
Number of Shoes (each side)	47	
Number of Track Rollers (each side)	8	
Number of Carrier Rollers (each side)	3	

Drive

Maximum Gradeability	35°/70%	
Maximum Travel Speed	4.1 km/h	2.5 mph
Maximum Drawbar Pull	491 kN	110,359 lbf

Hydraulic System

Main System – Maximum Flow – Implement	896 L/min (× 2 pumps)	237 gal/min (× 2 pumps)
Swing System – Maximum Flow	247 L/min	65 gal/min
Maximum Pressure – Equipment – Implement	37 000 kPa	5,366 psi
Maximum Pressure – Equipment – Lift Mode	38 000 kPa	5,511 psi
Maximum Pressure – Travel	35 000 kPa	5,076 psi
Maximum Pressure – Swing	35 000 kPa	5,076 psi
Boom Cylinder – Bore	190 mm	7 in
Boom Cylinder – Stroke	1792 mm	71 in
Stick Cylinder – Bore	210 mm	8 in
Stick Cylinder – Stroke	2118 mm	83 in
VB Bucket Cylinder – Bore	190 mm	7 in
VB Bucket Cylinder – Stroke	1433 mm	56 in
WB Bucket Cylinder – Bore	200 mm	8 in
WB Bucket Cylinder – Stroke	1457 mm	57 in

Service Refill Capacity

Fuel Tank Capacity	920 L	243 gal
Cooling System	71 L	19 gal
Engine Oil (with filter)	62 L	16 gal
Swing Drive	20 L	5 gal
Final Drive (each)	32 L	9 gal
Hydraulic System (including tank)	620 L	164 gal
Hydraulic Tank (including suction pipe)	386 L	86 gal

Standards

Brakes	ISO 10265:2008
Cab/Rollover Protective Structure (ROPS)	ISO 12117-2: 2008
Cab/Operator Protective Guards (OPG) (optional)	ISO 10262:1998 Level II

Sound Performance

ISO 6395:2008 (external)	108 dB(A)
ISO 6396:2008 (inside cab)	73 dB(A)

- Hearing protection may be needed when operating with an open operator station and cab (when not properly maintained or doors/windows open) for extended periods or in a noisy environment.

374 Hydraulic Excavator Specifications

Operating Weights and Ground Pressures

	650 mm (26") HD Double Grouser Shoes		750 mm (30") HD Double Grouser Shoes		900 mm (35") HD Double Grouser Shoes	
	Weight	Ground Pressure	Weight	Ground Pressure	Weight	Ground Pressure
	kg (lb)	kPa (psi)	kg (lb)	kPa (psi)	kg (lb)	kPa (psi)
Base Machine Configurations						
Base Frame with Track Rollers and Carrier Rollers						
Standard Counterweight + Long Variable Gauge Undercarriage Base Machine						
Reach Boom + R4.67VB (15'4") Stick + 3.80 m ³ (4.97 yd ³) HD bucket	72 000 (158,600)	106 (15)	72 600 (160,100)	93 (13)	73 700 (162,300)	79 (11)
Reach Boom + R3.60VB (11'10") Stick + 3.80 m ³ (4.97 yd ³) HD bucket	71 600 (157,800)	106 (15)	72 200 (159,300)	92 (13)	73 300 (161,500)	78 (11)
Reach Boom + R2.84VB (9'4") Stick + 3.80 m ³ (4.97 yd ³) HD bucket	71 400 (157,400)	105 (15)	72 100 (158,900)	92 (13)	73 100 (161,200)	78 (11)
Mass Boom + M3.0WB (9'10") Stick + 4.40 m ³ (5.75 yd ³) XD bucket	74 300 (163,800)	110 (16)	75 000 (165,300)	96 (14)	76 000 (167,500)	81 (12)
Mass Boom + M2.57WB (8'5") Stick + 4.40 m ³ (5.75 yd ³) XD bucket	74 000 (163,200)	109 (16)	74 700 (164,700)	96 (14)	75 700 (166,900)	81 (12)

All operating weights include a 90% fuel tank with 75 kg (165 lb) operator.

374 Hydraulic Excavator Specifications

Major Component Weights

	kg	lb
Base Machine Weight: including upperframe, undercarriage, counterweight, boom cylinders, without boom, stick, bucket, stick cylinder, bucket cylinder, tracks, without fuel 612 kg (1,349 lb), operator 75 kg (165 lb), with hydraulic oil 184 kg (406 lb), diesel exhaust fluid 49 kg (108 lb)		
With Standard Counterweight, Swing Frame and Base Frame	47 870	105,520
Track Shoes:		
650 mm (26") HD Double Grouser Track Shoes	8220	18,110
750 mm (30") HD Double Grouser Track Shoes*	8890	19,600
900 mm (35") HD Double Grouser Track Shoes*	9900	21,840
Two Boom Cylinders	2790	6,160
Weight of 90% Fuel Tank and 75 kg (165 lb) Operator	860	1,880
Counterweight:		
Standard Counterweight	11 240	24,770
Swing Frame:		
Standard Swing Frame	6450	14,210
Long Variable Gauge Undercarriage:		
Base Frame with Double Flange Track Rollers and Carrier Rollers	18 850	41,560
Booms (including lines, pins, stick cylinder):		
Reach Boom 7.8 m (25'7")*	6960	15,330
Mass Boom 7.0 m (23'0")	7510	16,560
Sticks (including lines, pins, bucket cylinder, bucket linkage):		
Reach Stick R4.67VB (15'4")*	4140	9,120
Reach Stick R3.60VB (11'10")*	3760	8,280
Reach Stick R2.84VB (9'4")*	3600	7,940
Mass Stick M3.0WB (9'10")*	4400	9,710
Mass Stick M2.57WB (8'5")*	4130	9,110
Buckets (without linkage):		
3.80 m ³ (4.97 yd ³) Heavy Duty for VB*	3920	8,650
4.40 m ³ (5.75 yd ³) Extreme Duty for WB*	5440	12,000
Quick Couplers (QC):		
CW Dedicated Quick Coupler for VB*	1020	2,260
CW Dedicated Quick Coupler for WB	1080	2,370
Pin Grabber QC	1510	3,320

*Depending on regional offering.

374 Hydraulic Excavator Specifications

Dimensions

All dimensions are approximate and may vary depending on bucket selection.

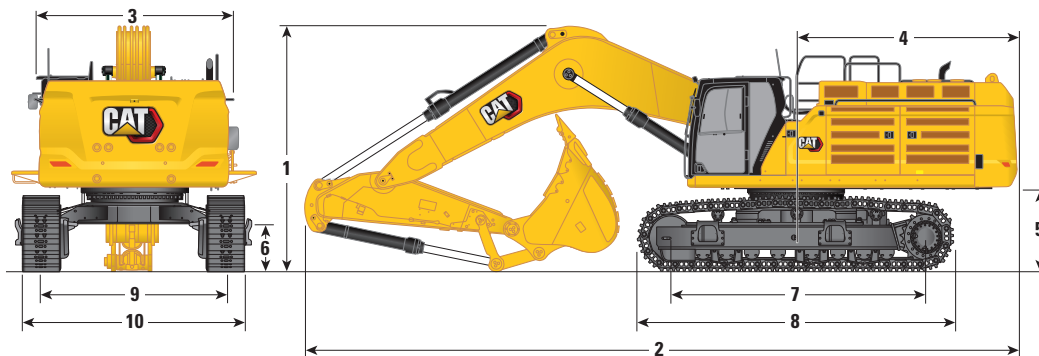

Boom Options

Reach Boom
7.8 m (25'7")

Stick Options

Reach Stick

R4.67VB (15'4") R3.60VB (11'10") R2.84VB (9'4")

1 Machine Height:

	R4.67VB (15'4")	R3.60VB (11'10")	R2.84VB (9'4")
Cab Height	3559 mm 11'8"	3559 mm 11'8"	3559 mm 11'8"
OPG Height	3702 mm 12'1"	3702 mm 12'1"	3702 mm 12'1"
Handrails Height	3982 mm 13'0"	3982 mm 13'0"	3982 mm 13'0"
With Boom/Stick/Bucket Installed	5052 mm 16'6"	4519 mm 14'9"	4292 mm 14'0"
With Boom/Stick Installed	4698 mm 15'4"	4287 mm 14'0"	4063 mm 13'3"
With Boom Installed	3958 mm 12'11"	3958 mm 12'11"	3958 mm 12'11"
With Boom/Stick/Bucket Installed (with auxiliary lines)	5086 mm 16'8"	4555 mm 14'11"	4324 mm 14'2"
With Boom/Stick Installed (with auxiliary lines)	4735 mm 15'6"	4319 mm 14'2"	4086 mm 13'4"
With Boom Installed (with auxiliary lines)	4033 mm 13'2"	4033 mm 13'2"	4033 mm 13'2"

2 Machine Length:

With Boom/Stick/Bucket Installed	13 553 mm 44'5"	13 652 mm 44'9"	13 596 mm 44'7"
With Boom/Stick Installed	13 654 mm 44'9"	13 625 mm 44'8"	13 511 mm 44'3"
With Boom Installed	11 855 mm 38'10"	11 855 mm 38'10"	11 855 mm 38'10"
With Boom/Stick/Bucket Installed (with auxiliary lines)	13 553 mm 44'5"	13 652 mm 44'9"	11 596 mm 38'0"
With Boom/Stick Installed (with auxiliary lines)	13 654 mm 44'9"	13 625 mm 44'8"	13 511 mm 44'3"
With Boom Installed (with auxiliary lines)	11 855 mm 38'10"	11 855 mm 38'10"	11 056 mm 36'3"

3 Upperframe Width:

Without Walkways	3490 mm 11'5"	3490 mm 11'5"	3490 mm 11'5"
With Walkways	4508 mm 14'9"	4508 mm 14'9"	4508 mm 14'9"
Walkways Width	500 mm 1'7"	500 mm 1'7"	500 mm 1'7"

4 Tail Swing Radius

4171 mm 13'8" 4171 mm 13'8" 4171 mm 13'8"

5 Counterweight Clearance (without shoe lug)

1494 mm 4'10" 1494 mm 4'10" 1494 mm 4'10"

6 Ground Clearance (without shoe lug)

782 mm 2'6" 782 mm 2'6" 782 mm 2'6"

(continued on next page)

374 Hydraulic Excavator Specifications

Dimensions *(continued)*

All dimensions are approximate and may vary depending on bucket selection.

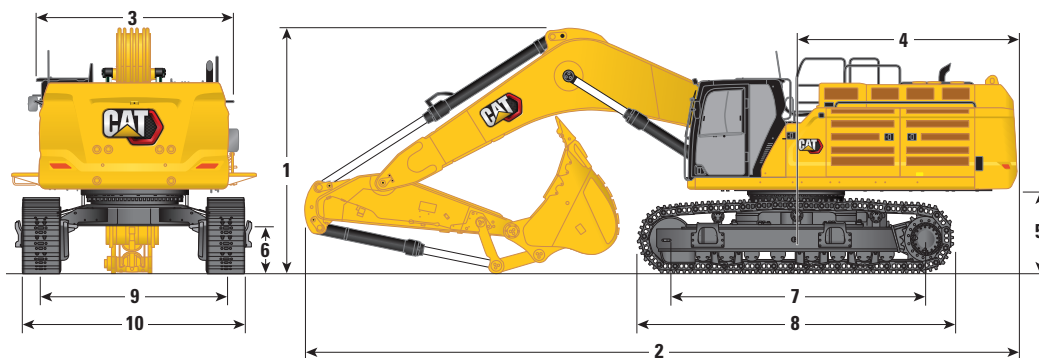

Boom Options

Reach Boom
7.8 m (25'7")

Stick Options

Reach Stick

	R4.67VB (15'4")		R3.60VB (11'10")		R2.84VB (9'4")	
7 Length to Center of Rollers	4705 mm	15'5"	4705 mm	15'5"	4705 mm	15'5"
8 Track Length with Double Grouser Shoes	5873 mm	19'3"	5873 mm	19'3"	5873 mm	19'3"
9 Track Gauge:						
Retracted with Double Grouser Shoes	2750 mm	9'0"	2750 mm	9'0"	2750 mm	9'0"
Extended with Double Grouser Shoes	3410 mm	11'2"	3410 mm	11'2"	3410 mm	11'2"
10 Undercarriage Width – Retracted (without steps):						
650 mm (26") Shoes	3400 mm	11'1"	3400 mm	11'1"	3400 mm	11'1"
750 mm (30") Shoes	3500 mm	11'5"	3500 mm	11'5"	3500 mm	11'5"
900 mm (35") Shoes	3650 mm	11'11"	3650 mm	11'11"	3650 mm	11'11"
Undercarriage Width – Retracted (with steps):						
650 mm (26") Shoes	3678 mm	12'0"	3678 mm	12'0"	3678 mm	12'0"
750 mm (30") Shoes	3678 mm	12'0"	3678 mm	12'0"	3678 mm	12'0"
900 mm (35") Shoes	3678 mm	12'0"	3678 mm	12'0"	3678 mm	12'0"
Undercarriage Width – Extended (without steps):						
650 mm (26") Shoes	4060 mm	13'3"	4060 mm	13'3"	4060 mm	13'3"
750 mm (30") Shoes	4160 mm	13'7"	4160 mm	13'7"	4160 mm	13'7"
900 mm (35") Shoes	4310 mm	14'1"	4310 mm	14'1"	4310 mm	14'1"
Undercarriage Width – Extended (with steps):						
650 mm (26") Shoes	4338 mm	14'2"	4338 mm	14'2"	4338 mm	14'2"
750 mm (30") Shoes	4338 mm	14'2"	4338 mm	14'2"	4338 mm	14'2"
900 mm (35") Shoes	4338 mm	14'2"	4338 mm	14'2"	4338 mm	14'2"
Bucket Type	HD		HD		HD	
Bucket Capacity	3.80 m ³	4.97 yd ³	3.80 m ³	4.97 yd ³	3.80 m ³	4.97 yd ³
Bucket Tip Radius	2250 mm	7'4"	2250 mm	7'4"	2250 mm	7'4"

(continued on next page)

374 Hydraulic Excavator Specifications

Dimensions *(continued)*

All dimensions are approximate and may vary depending on bucket selection.

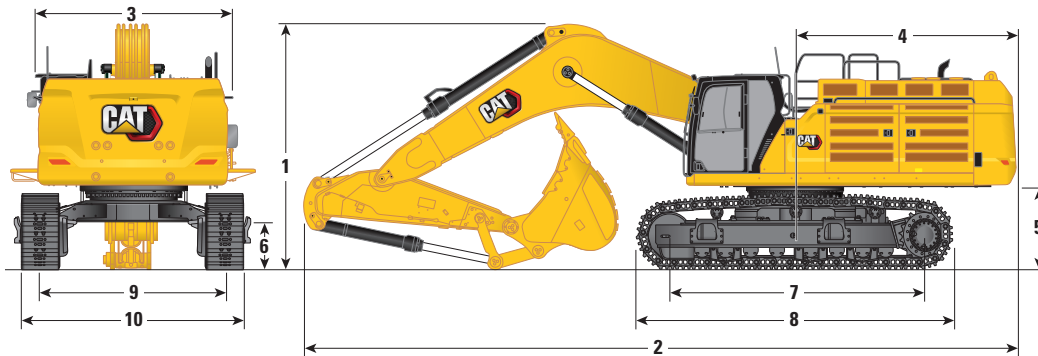

Boom Options

Mass Boom
7.0 m (23'0")

Stick Options

Mass Stick

M3.0WB (9'10")

M2.57WB (8'5")

	M3.0WB (9'10")		M2.57WB (8'5")	
1 Machine Height:				
Cab Height	3559 mm	11'8"	3559 mm	11'8"
OPG Height	3702 mm	12'1"	3702 mm	12'1"
Handrail Height	3982 mm	13'0"	3982 mm	13'0"
With Boom/Stick/Bucket Installed	4902 mm	16'0"	4927 mm	16'1"
With Boom/Stick Installed	4463 mm	14'7"	4368 mm	14'3"
With Boom Installed	3958 mm	12'11"	3958 mm	12'11"
With Boom/Stick/Bucket Installed (with auxiliary lines)	4918 mm	16'1"	4942 mm	16'2"
With Boom/Stick Installed (with auxiliary lines)	4496 mm	14'9"	4403 mm	14'5"
With Boom Installed (with auxiliary lines)	4033 mm	13'2"	4033 mm	13'2"
2 Machine Length:				
With Boom/Stick/Bucket Installed	12 856 mm	42'2"	12 978 mm	42'6"
With Boom/Stick Installed	12 702 mm	41'8"	12 719 mm	41'8"
With Boom Installed	11 011 mm	36'1"	11 011 mm	36'1"
With Boom/Stick/Bucket Installed (with auxiliary lines)	12 856 mm	42'2"	12 978 mm	42'6"
With Boom/Stick Installed (with auxiliary lines)	12 702 mm	41'8"	12 719 mm	41'8"
With Boom Installed (with auxiliary lines)	11 056 mm	36'3"	11 056 mm	36'3"
3 Upperframe Width:				
Without Walkways	3490 mm	11'5"	3490 mm	11'5"
With Walkways	4508 mm	14'9"	4508 mm	14'9"
Walkways Width	536 mm	1'9"	536 mm	1'9"
4 Tail Swing Radius	4171 mm	13'8"	4171 mm	13'8"
5 Counterweight Clearance (without shoe lug)	1494 mm	4'10"	1494 mm	4'10"
6 Ground Clearance (without shoe lug)	782 mm	2'6"	782 mm	2'6"

(continued on next page)

374 Hydraulic Excavator Specifications

Dimensions (continued)

All dimensions are approximate and may vary depending on bucket selection.

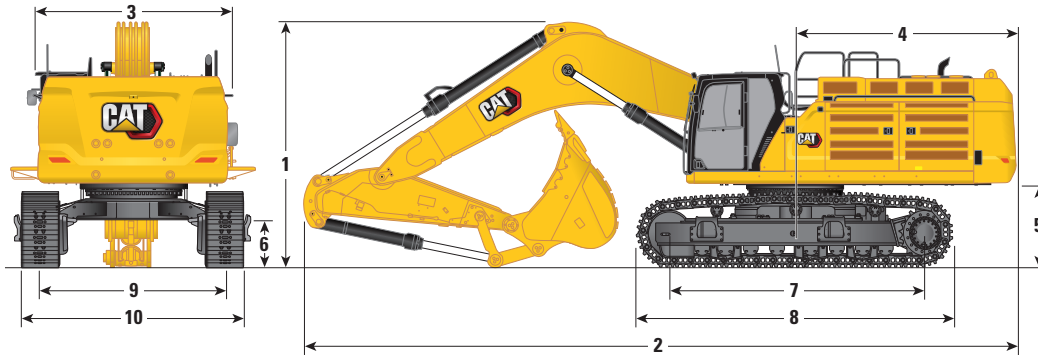

Boom Options

Mass Boom
7.0 m (23'0")

Stick Options

Mass Stick

	M3.0WB (9'10")		M2.57WB (8'5")	
	mm	ft/in	mm	ft/in
7 Length to Center of Rollers	4705 mm	15'5"	4705 mm	15'5"
8 Track Length with Double Grouser Shoes	5873 mm	19'3"	5873 mm	19'3"
9 Track Gauge:				
Retracted with Double Grouser Shoes	2750 mm	9'0"	2750 mm	9'0"
Extended with Double Grouser Shoes	3410 mm	11'2"	3410 mm	11'2"
10 Undercarriage Width – Retracted (without steps):				
650 mm (26") Shoes	3400 mm	11'1"	3400 mm	11'1"
750 mm (30") Shoes	3500 mm	11'5"	3500 mm	11'5"
900 mm (35") Shoes	3650 mm	11'11"	3650 mm	11'11"
Undercarriage Width – Retracted (with steps):				
650 mm (26") Shoes	3678 mm	12'0"	3678 mm	12'0"
750 mm (30") Shoes	3678 mm	12'0"	3678 mm	12'0"
900 mm (35") Shoes	3678 mm	12'0"	3678 mm	12'0"
Undercarriage Width – Extended (without steps):				
650 mm (26") Shoes	4060 mm	13'3"	4060 mm	13'3"
750 mm (30") Shoes	4160 mm	13'7"	4160 mm	13'7"
900 mm (35") Shoes	4310 mm	14'1"	4310 mm	14'1"
Undercarriage Width – Extended (with steps):				
650 mm (26") Shoes	4338 mm	14'2"	4338 mm	14'2"
750 mm (30") Shoes	4338 mm	14'2"	4338 mm	14'2"
900 mm (35") Shoes	4338 mm	14'2"	4338 mm	14'2"
Bucket Type	XD		XD	
Bucket Capacity	4.40 m ³	5.75 yd ³	4.40 m ³	5.75 yd ³
Bucket Tip Radius	2310 mm	7'6"	2310 mm	7'6"

374 Hydraulic Excavator Specifications

Working Ranges and Forces

All dimensions are approximate and may vary depending on bucket selection.

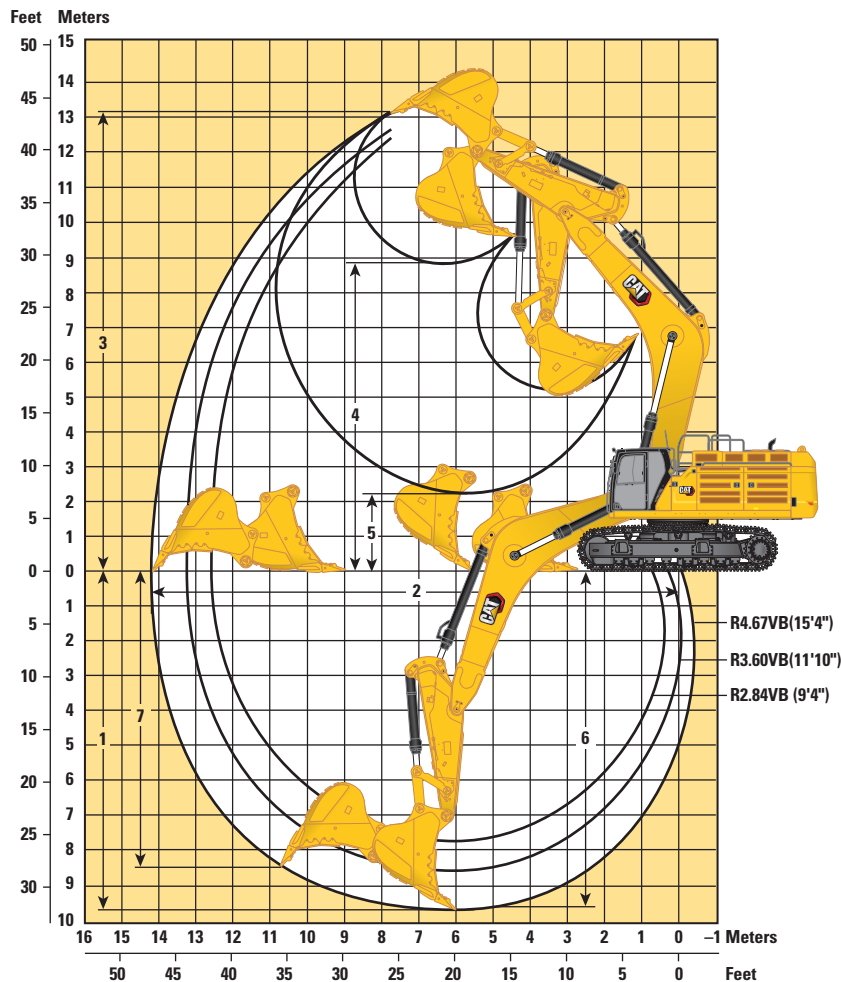

Boom Options Stick Options	Reach Boom 7.8 m (25'7")					
	Reach Stick					
	R4.67VB(15'4")		R3.60VB(11'10")		R2.84VB (9'4")	
1 Maximum Digging Depth	9660 mm	31'8"	8590 mm	28'2"	7830 mm	25'8"
2 Maximum Reach at Ground Line	14 240 mm	46'8"	13 180 mm	43'2"	12 540 mm	41'1"
3 Maximum Cutting Height	13 220 mm	43'4"	12 560 mm	41'2"	12 450 mm	40'10"
4 Maximum Loading Height	8990 mm	29'5"	8410 mm	27'7"	8240 mm	27'0"
5 Minimum Loading Height	2230 mm	7'3"	3290 mm	10'9"	4050 mm	13'3"
6 Maximum Depth Cut for 2440 mm (8'0") Level Bottom	9550 mm	31'3"	8460 mm	27'9"	7680 mm	25'2"
7 Maximum Vertical Wall Digging Depth	8400 mm	27'6"	7010 mm	22'11"	6540 mm	21'5"
Bucket Digging Force (ISO)	359 kN	80,730 lbf	358 kN	80,550 lbf	356 kN	80,120 lbf
Stick Digging Force (ISO)	247 kN	55,630 lbf	295 kN	66,390 lbf	330 kN	74,190 lbf
Bucket Type	HD		HD		HD	
Bucket Capacity	3.80 m ³	4.97 yd ³	3.80 m ³	4.97 yd ³	3.80 m ³	4.97 yd ³
Bucket Tip Radius	2250 mm	7'4"	2250 mm	7'4"	2250 mm	7'4"

(continued on next page)

374 Hydraulic Excavator Specifications

Working Ranges and Forces (continued)

All dimensions are approximate and may vary depending on bucket selection.

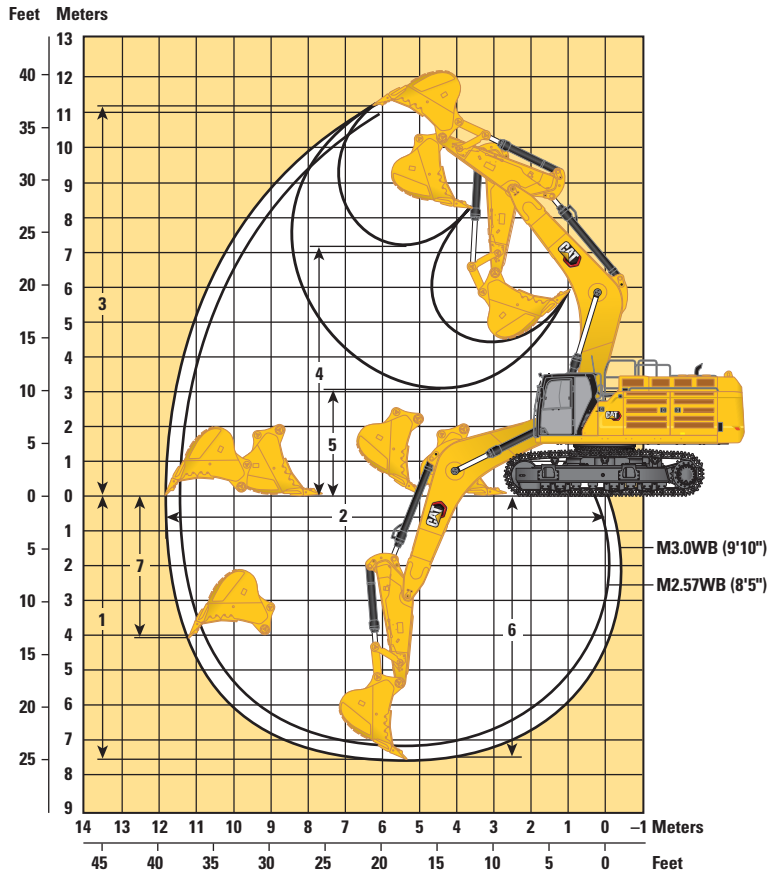

Boom Options	Mass Boom 7.0 m (23'0")			
	Stick Options			
	M3.0WB (9'10")		M2.57WB (8'5")	
1 Maximum Digging Depth	7660 mm	25'1"	7240 mm	23'9"
2 Maximum Reach at Ground Line	11 860 mm	38'10"	11 470 mm	37'7"
3 Maximum Cutting Height	11 170 mm	36'7"	11 000 mm	36'1"
4 Maximum Loading Height	7210 mm	23'7"	7050 mm	23'1"
5 Minimum Loading Height	3050 mm	10'0"	3470 mm	11'4"
6 Maximum Depth Cut for 2440 mm (8'0") Level Bottom	7520 mm	24'8"	7080 mm	23'2"
7 Maximum Vertical Wall Digging Depth	4070 mm	13'4"	3710 mm	12'2"
Bucket Digging Force (ISO)	406 kN	91,200 lbf	405 kN	91,090 lbf
Stick Digging Force (ISO)	322 kN	72,420 lbf	352 kN	79,110 lbf
Bucket Type	XD		XD	
Bucket Capacity	4.40 m ³	5.75 yd ³	4.40 m ³	5.75 yd ³
Bucket Tip Radius	2310 mm	7'6"	2310 mm	7'6"

374 Hydraulic Excavator Specifications

Reach Boom Lift Capacities – Standard Counterweight – without Bucket, Heavy Lift: On

Long Variable Gauge Undercarriage

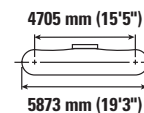
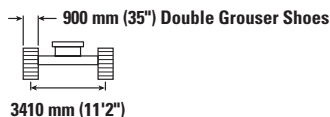

Reach	Unit	1500 mm/5'0"		3000 mm/10'0"		4500 mm/15'0"		6000 mm/20'0"		7500 mm/25'0"		9000 mm/30'0"		10 500 mm/35'0"		12 000 mm/40'0"		mm ft/in			
		kg	lb	kg	lb	kg	lb	kg	lb	kg	lb	kg	lb	kg	lb	kg	lb				
10 500 mm 35'0"	kg lb												*12800 *12800					*11750 *26,150	*11750 *26,150	9210 29'8"	
9000 mm 30'0"	kg lb												*13 650 *30,050	*13 650 *30,050					*11 100 *24,550	*11 100 *24,550	10 330 33'6"
7500 mm 25'0"	kg lb												*14 000 *30,600	*14 000 *30,600	*13 450 *29,000	11 800 25,300			*10 800 *23,850	10 550 23,500	11 140 36'4"
6000 mm 20'0"	kg lb												*14 800 *32,200	*14 800 *32,200	*13 800 *30,150	11 600 24,900			*10 750 *23,700	9550 21,150	11 700 38'3"
4500 mm 15'0"	kg lb					*29 050 *64,350	*29 050 *64,350	*21 950 *47,300	*21 950 *47,300	*18 200 *39,350	*18 200 *39,350	*15 900 *34,500	14 450 31,100	*14 350 *31,300	11 300 24,250	*11 350 9000			*10 900 *24,000	8900 19,700	12 050 39'5"
3000 mm 10'0"	kg lb							*25 350 *54,650	*25 350 *54,650	*20 150 *43,550	18 200 39,250	*17 050 *36,950	13 850 29,850	*15 000 32,300	10 950 23,500	12 150 *24,850	8800 18,900		*11 300 *24,800	10 550 18,900	12 200 40'0"
1500 mm 5'0"	kg lb							*27 900 *60,300	23 950 51,600	*21 750 *47,050	17 300 37,300	*18 050 *39,100	13 300 28,650	14 650 31,550	10 600 22,800	11 950 8650			11 700 25,800	8450 18,600	12 160 39'10"
0 mm 0'0"	kg lb					*18 800 *43,450	*18 800 *43,450	*29 150 *63,100	23 000 49,550	*22 750 *49,250	16 650 35,900	18 050 38,800	12 850 27,700	14 350 30,900	10 300 22,200				11 950 26,300	8600 18,900	11 930 39'1"
-1500 mm -5'0"	kg lb			*13 650 *30,750	*13 650 *30,750	*24 700 *56,550	*24 700 *56,550	*29 100 *63,050	22 550 48,550	*22 900 *49,650	16 300 35,050	17 750 38,150	12 600 27,150	14 200 30,600	10 150 21,900				12 500 27,600	9000 19,800	11 500 37'8"
-3000 mm -10'0"	kg lb	*16 750 *37,450	*16 750 *37,450	*21 450 *48,400	*21 450 *48,400	*33 500 *76,550	*33 500 *76,550	*27 800 *60,250	22 500 48,350	*22 150 *47,900	16 150 34,800	17 650 38,000	12 500 26,950	14 200 30,650	10 150 21,950				13 600 30,100	9750 21,550	10 850 35'5"
-4500 mm -15'0"	kg lb			*30 900 *70,000	*30 900 *70,000	*32 050 *69,200	*32 050 *69,200	*25 200 *54,400	22 700 48,800	*20 200 *43,500	16 250 35,050	*16 150 *34,450	12 650 27,300						*13 550 *29,800	11 150 24,800	9920 32'4"
-6000 mm -20'0"	kg lb			*32 750 *70,050	*32 750 *70,050	*25 950 *55,500	*25 950 *55,500	*20 800 *44,350	*20 800 *44,350	*16 400 *34,550	*16 400 *34,550								*12 800 *28,000	*12 800 *28,000	8640 27'11"



ISO 10567:2007



*Indicates that the load is limited by hydraulic lifting capacity rather than tipping load. The above loads are in compliance with hydraulic excavator lift capacity standard ISO 10567:2007. They do not exceed 87% of hydraulic lifting capacity or 75% of tipping load. Weight of all lifting accessories must be deducted from the above lifting capacities. Lifting capacities are based on the machine standing on a firm, uniform supporting surface. The use of a work tool attachment point to handle/lift objects, could affect the machine lift performance.

Lift capacity stays with ±5% for all available track shoes.

Always refer to the appropriate Operation and Maintenance Manual for specific product information.

374 Hydraulic Excavator Specifications

Reach Boom Lift Capacities – Standard Counterweight – without Bucket, Heavy Lift: On

Long Variable Gauge Undercarriage

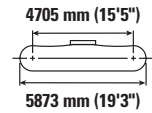
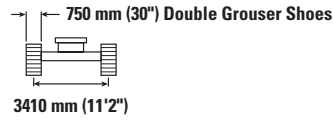
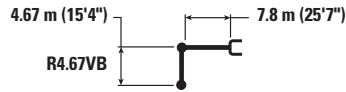

Reach	Unit	1500 mm/5'0"		3000 mm/10'0"		4500 mm/15'0"		6000 mm/20'0"		7500 mm/25'0"		9000 mm/30'0"		10 500 mm/35'0"		12 000 mm/40'0"		mm ft/in				
		kg	lb	kg	lb	kg	lb	kg	lb	kg	lb	kg	lb	kg	lb	kg	lb					
10 500 mm 35'0"	kg lb																	*11 750 *26,150	*11 750 *26,150	9210 29'8"		
9000 mm 30'0"	kg lb												*13 650 *30,050	*13 650 *30,050					*11 100 *24,550	*11 100 *24,550	10 330 33'6"	
7500 mm 25'0"	kg lb												*14 000 *30,600	*14 000 *30,600	*13 450 *29,000	11 650 24,950			*10 800 *23,850	10 400 23,150	11 140 36'4"	
6000 mm 20'0"	kg lb												*14 800 *32,200	*14 800 *31,900	*13 800 *30,150	11 450 24,550			*10 750 *23,700	9400 20,850	11 700 38'3"	
4500 mm 15'0"	kg lb					*29 050 *64,300	*29 050 *64,300	*21 950 *47,300	*21 950 *47,300	*18 200 *39,350	*18 200 *39,350	*15 900 *34,500	14 250 30,700	*14 350 *31,300	11 150 23,900	*11 350 8850			*10 900 *24,000	8800 19,400	12 050 39'5"	
3000 mm 10'0"	kg lb							*25 350 *54,650	25 100 54,100	*20 150 *43,550	17 950 38,700	*17 050 *36,950	13 650 29,400	14 800 31,850	10 750 23,150	11 950 *24,850	8650 18,600			*11 300 *24,800	8450 18,600	12 200 40'0"
1500 mm 5'0"	kg lb							*27 900 *60,300	23 600 50,850	*21 750 *47,050	17 050 36,800	*18 050 *39,100	13 100 28,200	14 450 31,050	10 450 22,450	11 800 8500			11 550 25,400	8300 18,300	12 160 39'10"	
0 mm 0'0"	kg lb					*18 800 *43,450	*18 800 *43,450	*29 150 *63,100	22 700 48,800	*22 750 *49,250	16 400 35,350	17 750 38,200	12 700 27,300	14 150 30,450	10 150 21,850				11 750 25,850	8450 18,600	11 930 39'1"	
-1500 mm -5'0"	kg lb			*13 650 *30,750	*13 650 *30,750	*24 700 *56,550	*24 700 *56,550	*29 100 *63,050	22 250 47,800	*22 900 49,350	16 050 34,550	17 450 37,600	12 400 26,700	14 000 30,100	10 000 21,550				12 300 27,150	8850 19,450	11 500 37'8"	
-3000 mm -10'0"	kg lb	*16 750 *37,450	*16 750 *37,450	*21 450 *48,400	*21 450 *48,400	*33 500 *76,550	*33 500 *76,300	*27 800 *60,250	22 150 47,600	*22 150 *47,900	15 900 34,250	17 350 37,400	12 300 26,550	14 000 30,150	10 000 21,600				13 400 29,600	9600 21,200	10 850 35'5"	
-4500 mm -15'0"	kg lb			*30 900 *70,000	*30 900 *70,000	*32 050 *69,200	*32 050 *69,200	*25 200 *54,400	22 350 48,100	*20 200 *43,500	16 050 34,550	*16 150 *34,450	12 450 26,850						*13 550 *29,800	11 000 24,400	9920 32'4"	
-6000 mm -20'0"	kg lb			*32 750 *70,050	*32 750 *70,050	*25 950 *55,500	*25 950 *55,500	*20 800 *44,350	*20 800 *44,350	*16 400 *34,550	*16 400 *34,550								*12 800 *28,000	*12 800 *28,000	8640 27'11"	



ISO 10567:2007



*Indicates that the load is limited by hydraulic lifting capacity rather than tipping load. The above loads are in compliance with hydraulic excavator lift capacity standard ISO 10567:2007.

They do not exceed 87% of hydraulic lifting capacity or 75% of tipping load. Weight of all lifting accessories must be deducted from the above lifting capacities. Lifting capacities are based on the machine standing on a firm, uniform supporting surface. The use of a work tool attachment point to handle/lift objects, could affect the machine lift performance.

Lift capacity stays with ±5% for all available track shoes.

Always refer to the appropriate Operation and Maintenance Manual for specific product information.

374 Hydraulic Excavator Specifications

Reach Boom Lift Capacities – Standard Counterweight – without Bucket, Heavy Lift: On

Long Variable Gauge Undercarriage

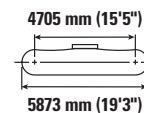
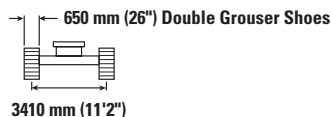

Reach	Unit	1500 mm/5'0"		3000 mm/10'0"		4500 mm/15'0"		6000 mm/20'0"		7500 mm/25'0"		9000 mm/30'0"		10 500 mm/35'0"		12 000 mm/40'0"		mm ft/in			
		kg	lb	kg	lb	kg	lb	kg	lb	kg	lb	kg	lb	kg	lb	kg	lb				
10 500 mm 35'0"	kg lb																	*11 750 *26,150	*11 750 *26,150	9210 29'8"	
9000 mm 30'0"	kg lb																	*11 100 *24,550	*11 100 *24,550	10 330 33'6"	
7500 mm 25'0"	kg lb																	*14 000 *30,600	*14 000 *30,600	11 550 24,700	
6000 mm 20'0"	kg lb																	*13 450 *29,000	11 550 24,700	*10 800 *23,850	10 300 22,950
4500 mm 15'0"	kg lb																	*13 800 *30,150	11 350 24,300	*10 750 *23,700	9300 20,600
3000 mm 10'0"	kg lb																	*14 800 *32,200	14 700 31,600	*11 350 *24,300	11 700 26,000
1500 mm 5'0"	kg lb																	*14 000 *30,600	14 150 30,400	*13 800 *30,150	11 350 24,300
0 mm 0'0"	kg lb																	*14 350 *31,300	11 000 23,650	*11 350 *24,300	8750 19,200
-1500 mm -5'0"	kg lb																	*10 900 *24,000	8700 19,200	*11 300 *24,800	8350 18,400
-3000 mm -10'0"	kg lb																	*10 800 *23,850	8600 18,400	*11 350 *24,800	8350 18,400
-4500 mm -15'0"	kg lb																	*11 350 *24,800	8400 18,400	11 400 25,150	8250 18,100
-6000 mm -20'0"	kg lb																	*11 400 *25,150	8400 18,400	11 400 25,150	8250 18,100
-1500 mm -5'0"	kg lb																	*18 800 *41,450	*18 800 *41,450	*29 150 *63,100	22 450 48,350
-3000 mm -10'0"	kg lb																	*29 150 *63,100	22 450 48,350	*22 750 *49,250	16 250 35,000
-4500 mm -15'0"	kg lb																	*22 750 *49,250	16 250 35,000	*17 600 *37,850	12 550 27,000
-6000 mm -20'0"	kg lb																	*17 600 *37,850	12 550 27,000	*14 000 *30,150	10 050 21,650
-1500 mm -5'0"	kg lb																	*15 900 *34,500	14 150 30,400	*13 850 *30,150	9900 21,300
-3000 mm -10'0"	kg lb																	*14 350 *31,300	11 000 23,650	*13 850 *30,150	9900 21,300
-4500 mm -15'0"	kg lb																	*14 700 *31,600	11 350 24,300	*13 850 *30,150	9900 21,300
-6000 mm -20'0"	kg lb																	*14 000 *30,600	14 150 30,400	*13 850 *30,150	9900 21,300
-1500 mm -5'0"	kg lb																	*13 650 *30,750	*13 650 *30,750	*24 700 *56,550	*24 700 *56,550
-3000 mm -10'0"	kg lb																	*21 450 *48,400	*21 450 *48,400	*33 500 *76,550	*33 500 *76,550
-4500 mm -15'0"	kg lb																	*27 800 *60,250	21 900 47,150	*27 800 *60,250	21 900 47,150
-6000 mm -20'0"	kg lb																	*22 150 *47,900	15 750 33,900	*22 150 *47,900	15 750 33,900
-1500 mm -5'0"	kg lb																	*25 200 *54,400	22 100 47,600	*25 200 *54,400	22 100 47,600
-3000 mm -10'0"	kg lb																	*20 200 *43,500	15 850 34,200	*20 200 *43,500	15 850 34,200
-4500 mm -15'0"	kg lb																	*16 150 *34,450	12 300 26,600	*16 150 *34,450	12 300 26,600
-6000 mm -20'0"	kg lb																	*16 400 *34,550	16 300 34,550	*16 400 *34,550	16 300 34,550



ISO 10567:2007



*Indicates that the load is limited by hydraulic lifting capacity rather than tipping load. The above loads are in compliance with hydraulic excavator lift capacity standard ISO 10567:2007. They do not exceed 87% of hydraulic lifting capacity or 75% of tipping load. Weight of all lifting accessories must be deducted from the above lifting capacities. Lifting capacities are based on the machine standing on a firm, uniform supporting surface. The use of a work tool attachment point to handle/lift objects, could affect the machine lift performance.

Lift capacity stays with ±5% for all available track shoes.

Always refer to the appropriate Operation and Maintenance Manual for specific product information.

374 Hydraulic Excavator Specifications

Reach Boom Lift Capacities – Standard Counterweight – without Bucket, Heavy Lift: On

Long Variable Gauge Undercarriage

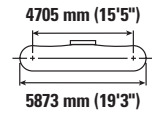
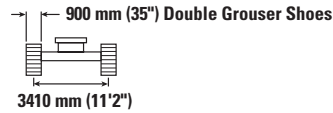
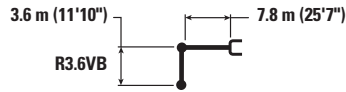

Reach	Unit	3000 mm/10'0"		4500 mm/15'0"		6000 mm/20'0"		7500 mm/25'0"		9000 mm/30'0"		10 500 mm/35'0"		mm ft/in		
		kg lb	kg lb	kg lb	kg lb	kg lb	kg lb	kg lb	kg lb	kg lb	kg lb	kg lb	kg lb	kg lb	mm ft/in	
10 500 mm 35'0"	kg lb													*16 150 *36,000	*16 150 *36,000	7760 24'10"
9000 mm 30'0"	kg lb									*15 700	15 150			*15 100 *33,400	14 900 *33,400	9070 29'4"
7500 mm 25'0"	kg lb							*16 950 *36,900	*16 950 *36,900	*15 750 *34,400	15 050 32,300			*14 650 *32,350	12 550 27,950	9980 32'6"
6000 mm 20'0"	kg lb					*21 500 *46,400	*21 500 *46,400	*18 300 *39,700	*18 300 *39,700	*16 350 *35,600	14 700 31,600	*15 200	11 350	*14 650 *32,250	11 150 24,750	10 610 34'8"
4500 mm 15'0"	kg lb					*24 750 *53,350	*24 750 *53,350	*20 050 *43,350	18 750 40,400	*17 250 *37,500	14 200 30,600	15 250 32,750	11 150 23,950	14 150 31,250	10 350 22,850	10 990 35'11"
3000 mm 10'0"	kg lb					*27 700 *59,750	24 650 53,150	*21 700 *46,950	17 850 38,500	*18 200 *39,500	13 700 29,500	14 950 32,150	10 900 23,400	13 600 30,000	9900 21,850	11 150 36'6"
1500 mm 5'0"	kg lb					*29 400 *63,550	23 550 50,700	*22 900 *49,550	17 150 36,950	18 450 39,650	13 250 28,550	14 700 31,600	10 650 22,850	13 500 29,750	9800 21,550	11 110 36'5"
0 mm 0'0"	kg lb					*29 600 *64,150	23 000 49,500	*23 300 *50,500	16 700 35,950	18 100 38,950	12 950 27,900	14 500 31,250	10 450 22,550	13 850 30,500	10 000 22,000	10 860 35'7"
-1500 mm -5'0"	kg lb			*26 800 *61,450	*26 800 *61,450	*28 550 *61,950	22 850 49,150	*22 850 *49,450	16 500 35,500	17 950 38,650	12 800 27,600			14 700 32,450	10 600 23,350	10 390 34'0"
-3000 mm -10'0"	kg lb	*26 350 *59,550	*26 350 *59,550	*32 650 *70,900	*32 650 *70,900	*26 350 *57,000	23 000 49,400	*21 300 *45,950	16 550 35,600	*17 100 *36,700	12 850 27,800			*15 250 *33,550	11 800 26,050	9660 31'6"
-4500 mm -15'0"	kg lb	*32 400 *70,200	*32 400 *70,200	*27 450 *59,250	*27 450 *59,250	*22 550 *48,500	*22 550 *48,500	*18 100 *38,650	16 850 36,350					*14 650 *32,100	14 050 31,300	8600 27'11"
-6000 mm -20'0"	kg lb					*16 100 *33,600	*16 100 *33,600							*12 750 *27,600	*12 750 *27,600	7070 22'9"



ISO 10567:2007



*Indicates that the load is limited by hydraulic lifting capacity rather than tipping load. The above loads are in compliance with hydraulic excavator lift capacity standard ISO 10567:2007.

They do not exceed 87% of hydraulic lifting capacity or 75% of tipping load. Weight of all lifting accessories must be deducted from the above lifting capacities. Lifting capacities are based on the machine standing on a firm, uniform supporting surface. The use of a work tool attachment point to handle/lift objects, could affect the machine lift performance.

Lift capacity stays with ±5% for all available track shoes.

Always refer to the appropriate Operation and Maintenance Manual for specific product information.

374 Hydraulic Excavator Specifications

Reach Boom Lift Capacities – Standard Counterweight – without Bucket, Heavy Lift: On

Long Variable Gauge Undercarriage

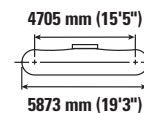
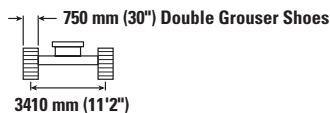
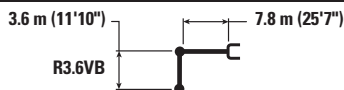

		3000 mm/10'0"		4500 mm/15'0"		6000 mm/20'0"		7500 mm/25'0"		9000 mm/30'0"		10 500 mm/35'0"		mm ft/in		
10 500 mm 35'0"	kg lb													*16 150 *36,000	*16 150 *36,000	7760 24'10"
9000 mm 30'0"	kg lb									*15 700	14 950			*15 100 *33,400	14 750 33,100	9070 29'4"
7500 mm 25'0"	kg lb							*16 950 *36,900	*16 950 *36,900	*15 750 *34,400	14 850 31,900			*14 650 *32,350	12 400 27,600	9980 32'6"
6000 mm 20'0"	kg lb					*21 500 *46,400	*21 500 *46,400	*18 300 *39,700	*18 300 *39,700	*16 350 *35,600	14 500 31,200	*15 200	11 200	*14 650 *32,250	11 000 24,400	10 610 34'8"
4500 mm 15'0"	kg lb					*24 750 *53,350	*24 750 *53,350	*20 050 *43,350	18 500 39,850	*17 250 *37,500	14 000 30,150	15 000 32,250	11 000 23,600	13 950 30,800	10 200 22,500	10 990 35'11"
3000 mm 10'0"	kg lb					*27 700 *59,750	24 300 52,400	*21 700 *46,950	17 600 37,950	*18 200 *39,500	13 500 29,100	14 750 31,650	10 700 23,050	13 400 29,550	9750 21,500	11 150 36'6"
1500 mm 5'0"	kg lb					*29 400 *63,550	23 200 50,000	*22 900 *49,550	16 900 36,400	18 150 39,100	13 050 28,150	14 450 31,100	10 450 22,550	13 300 29,300	9650 21,200	11 110 36'5"
0 mm 0'0"	kg lb					*29 600 *64,150	22 650 48,750	*23 300 50,250	16 450 35,400	17 850 38,400	12 750 27,500	14 300 30,750	10 300 22,200	13 650 30,000	9850 21,650	10 860 35'7"
-1500 mm -5'0"	kg lb					*26 800 *61,450	*26 800 *61,450	*28 550 *61,950	22 500 48,400	*22 850 *49,450	16 250 35,000	17 700 38,050	12 600 27,200	14 500 31,950	10 450 23,000	10 390 34'0"
-3000 mm -10'0"	kg lb	*26350 *59,550	*26350 *59,550	*32 650 *70,900	*32 650 *70,900	*26 350 *57,000	22 650 48,700	*21 300 *45,950	16 300 35,100	*17 100 *36,700	12 700 27,350			*15 250 *33,550	11 600 25,650	9660 31'6"
-4500 mm -15'0"	kg lb	*32 400 *70,200	*32 400 *70,200	*27 450 *59,250	*27 450 *59,250	*22 550 *48,500	*22 550 *48,500	*18 100 *38,650	16 600 35,800					*14 650 *32,100	13 850 30,850	8600 27'11"
-6000 mm -20'0"	kg lb					*16 100 *33,600	*16 100 *33,600							*12 750 *27,600	*12 750 *27,600	7070 22'9"



ISO 10567:2007



*Indicates that the load is limited by hydraulic lifting capacity rather than tipping load. The above loads are in compliance with hydraulic excavator lift capacity standard ISO 10567:2007. They do not exceed 87% of hydraulic lifting capacity or 75% of tipping load. Weight of all lifting accessories must be deducted from the above lifting capacities. Lifting capacities are based on the machine standing on a firm, uniform supporting surface. The use of a work tool attachment point to handle/lift objects, could affect the machine lift performance.

Lift capacity stays with ±5% for all available track shoes.

Always refer to the appropriate Operation and Maintenance Manual for specific product information.

374 Hydraulic Excavator Specifications

Reach Boom Lift Capacities – Standard Counterweight – without Bucket, Heavy Lift: On

Long Variable Gauge Undercarriage

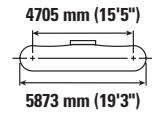
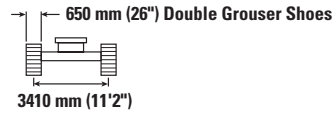
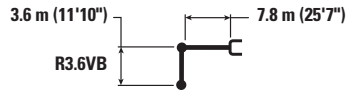

Reach	Unit	3000 mm/10'0"		4500 mm/15'0"		6000 mm/20'0"		7500 mm/25'0"		9000 mm/30'0"		10 500 mm/35'0"		mm ft/in		
		kg lb	kg lb	kg lb	kg lb	kg lb	kg lb	kg lb	kg lb	kg lb	kg lb	kg lb	kg lb	kg lb	kg lb	mm ft/in
10 500 mm 35'0"	kg lb													*16 150 *36,000	*16 150 *36,000	7760 24'10"
9000 mm 30'0"	kg lb									*15 700	14 800			*15 100 *33,400	14 600 32,850	9070 29'4"
7500 mm 25'0"	kg lb							*16 950 *36,900	*16 950 *36,900	*15 750 *34,400	14 750 31,600			*14 650 *32,350	12 250 27,350	9980 32'6"
6000 mm 20'0"	kg lb					*21 500 *46,400	*21 500 *46,400	*18 300 *39,700	*18 300 *39,700	*16 350 *35,600	14 350 30,900	15 100	11 100	*14 650 *32,250	10 900 24,150	10 610 34'8"
4500 mm 15'0"	kg lb					*24 750 *53,350	*24 750 *53,350	*20 050 *43,350	18 300 39,500	*17 250 *37,500	13 900 29,900	14 850 31,950	10 900 23,350	13 800 30,500	10 100 22,300	10 990 35'11"
3000 mm 10'0"	kg lb					*27 700 *59,750	24 050 51,900	*21 700 *46,950	17 450 37,600	*18 200 *39,500	13 350 28,800	14 600 31,350	10 600 22,800	13 300 29,250	9650 21,300	11 150 36'6"
1500 mm 5'0"	kg lb					*29 400 *63,550	23 000 49,500	*22 900 *49,550	16 750 36,050	18 000 38,700	12 950 27,850	14 300 30,800	10 350 22,300	13 150 29,000	9550 21,000	11 110 36'5"
0 mm 0'0"	kg lb					*29 600 *64,150	22 450 48,300	23 150 49,750	16 300 35,050	17 650 38,000	12 600 27,200	14 150 30,450	10 200 21,950	13 500 29,700	9750 21,450	10 860 35'7"
-1500 mm -5'0"	kg lb			*26 800 *61,450	*26 800 *61,450	*28 550 *61,950	22 300 47,950	*22 850 49,300	16 100 34,650	17 500 37,700	12 500 26,900			14 350 31,600	10 300 22,750	10 390 34'0"
-3000 mm -10'0"	kg lb	*26 350 *59,550	*26 350 *59,550	*32 650 *70,900	*32 650 *70,900	*26 350 *57,000	22 400 48,200	*21 300 *45,950	16 100 34,750	*17 100 *36,700	12 550 27,100			*15 250 *33,550	11 500 25,400	9660 31'6"
-4500 mm -15'0"	kg lb	*32 400 *70,200	*32 400 *70,200	*27 450 *59,250	*27 450 *59,250	*22 550 *48,500	*22 550 *48,500	*18 100 *38,650	16 450 35,450					*14 650 *32,100	13 700 30,550	8600 27'11"
-6000 mm -20'0"	kg lb					*16 100 *33,600	*16 100 *33,600							*12 750 *27,600	*12 750 *27,600	7070 22'9"



ISO 10567:2007



*Indicates that the load is limited by hydraulic lifting capacity rather than tipping load. The above loads are in compliance with hydraulic excavator lift capacity standard ISO 10567:2007.

They do not exceed 87% of hydraulic lifting capacity or 75% of tipping load. Weight of all lifting accessories must be deducted from the above lifting capacities. Lifting capacities are based on the machine standing on a firm, uniform supporting surface. The use of a work tool attachment point to handle/lift objects, could affect the machine lift performance.

Lift capacity stays with ±5% for all available track shoes.

Always refer to the appropriate Operation and Maintenance Manual for specific product information.

374 Hydraulic Excavator Specifications

Reach Boom Lift Capacities – Standard Counterweight – without Bucket, Heavy Lift: On

Long Variable Gauge Undercarriage

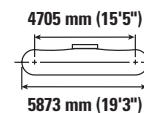
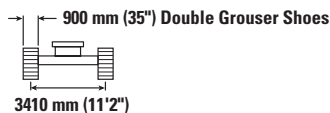

		4500 mm/15'0"		6000 mm/20'0"		7500 mm/25'0"		9000 mm/30'0"		10 500 mm/35'0"		mm ft/in		
10 500 mm 35'0"	kg lb											*19 150	*19 150	6820
9000 mm 30'0"	kg lb					*17 850 *39,300	*17 850 *39,300					*17 600 *39,000	17 050 38,450	8290 26'9"
7500 mm 25'0"	kg lb					*18 300 *39,850	*18 300 *39,850	*17 000 *37,350	14 750 31,550			*16 900 *37,300	13 950 31,150	9280 30'2"
6000 mm 20'0"	kg lb	*31 150 *66,400	*31 150 *66,400	*23 350 *50,350	*23 350 *50,350	*19 550 *42,350	19 250 41,450	*17 350 *37,800	14 450 31,100			*16 550 *36,500	12 250 27,200	9950 32'6"
4500 mm 15'0"	kg lb			*26 500 *57,000	25 450 54,950	*21 100 *45,650	18 350 39,600	*18 100 *39,250	14 000 30,200			15 450 34,100	11 300 24,900	10 350 33'10"
3000 mm 10'0"	kg lb			*28 950 *62,450	24 000 51,800	*22 500 *48,700	17 550 37,900	18 750 40,350	13 550 29,250	14 900	10 800	14 800 32,700	10 800 23,750	10 530 34'6"
1500 mm 5'0"	kg lb			*29 800 *64,500	23 200 50,000	*23 350 *50,500	16 950 36,600	18 350 39,500	13 200 28,450			14 750 32,450	10 700 23,500	10 480 34'4"
0 mm 0'0"	kg lb			*29 200 *63,350	22 950 49,350	*23 300 *50,500	16 650 35,850	18 100 39,000	12 950 27,950			15 200 33,450	10 950 24,150	10 220 33'6"
-1500 mm -5'0"	kg lb	*25 450 *59,000	*25 450 *59,000	*27 450 *59,650	22 950 49,400	*22 300 *48,300	16 550 35,700	18 050 38,950	12 950 27,900			*16 150 *35,550	11 750 25,950	9710 31'9"
-3000 mm -10'0"	kg lb	*28 950 *63,100	*28 950 *63,100	*24 550 *53,150	23 250 50,000	*20 050 *43,200	16 750 36,100					*15 650 *34,400	13 350 29,550	8920 29'1"
-4500 mm -15'0"	kg lb	*23 150 *49,900	*23 150 *49,900	*19 800 *42,400	*19 800 *42,400	*15 350 *32,000	*15 350 *32,000					*14 300 *31,250	*14 300 *31,250	7770 25'2"



ISO 10567:2007



*Indicates that the load is limited by hydraulic lifting capacity rather than tipping load. The above loads are in compliance with hydraulic excavator lift capacity standard ISO 10567:2007. They do not exceed 87% of hydraulic lifting capacity or 75% of tipping load. Weight of all lifting accessories must be deducted from the above lifting capacities. Lifting capacities are based on the machine standing on a firm, uniform supporting surface. The use of a work tool attachment point to handle/lift objects, could affect the machine lift performance.

Lift capacity stays with ±5% for all available track shoes.

Always refer to the appropriate Operation and Maintenance Manual for specific product information.

374 Hydraulic Excavator Specifications

Reach Boom Lift Capacities – Standard Counterweight – without Bucket, Heavy Lift: On

Long Variable Gauge Undercarriage

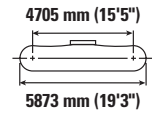
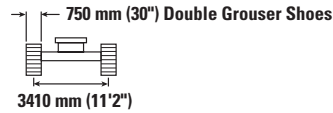
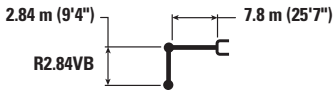

Reach	Unit	4500 mm/15'0"		6000 mm/20'0"		7500 mm/25'0"		9000 mm/30'0"		10 500 mm/35'0"		mm ft/in		
		kg lb	kg lb	kg lb	kg lb	kg lb	kg lb	kg lb	kg lb	kg lb	kg lb	kg lb	mm ft/in	
10 500 mm 35'0"	kg lb											*19150	*19150	6820
9000 mm 30'0"	kg lb					*17 850 *39,300	*17 850 *39,300					*17 600 *39,000	16 850 38,000	8290 26'9"
7500 mm 25'0"	kg lb					*18 300 *39,850	*18 300 *39,850	*17 000 *37,350	14 550 31,150			*16 900 *37,300	13 800 30,750	9280 30'2"
6000 mm 20'0"	kg lb	*31 150 *66,400	*31 150 *66,400	*23 350 *50,350	*23 350 *50,350	*19 550 *42,350	19 000 40,900	*17 350 *37,800	14 250 30,700			16 450 *36,500	12 100 26,800	9950 32'6"
4500 mm 15'0"	kg lb			*26 500 *57,000	25 100 54,250	*21 100 *45,650	18 100 39,100	*18 100 *39,250	13 850 29,800			15 200 33,600	11 100 24,550	10 350 33'10"
3000 mm 10'0"	kg lb			*28 950 *62,450	23 650 51,100	*22 500 *48,700	17 300 37,350	18 500 39,800	13 350 28,800	14 650	10 650	14 600 32,200	10 600 23,400	10 530 34'6"
1500 mm 5'0"	kg lb			*29 800 *64,500	22 900 49,300	*23 350 *50,500	16 700 36,050	18 100 38,950	13 000 28,000			14 500 31,950	10 500 23,150	10 480 34'4"
0 mm 0'0"	kg lb			*29 200 *63,350	22 600 48,650	23 300 50,150	16 400 35,350	17 850 38,450	12 800 27,550			14 950 32,950	10 800 23,800	10 220 33'6"
-1500 mm -5'0"	kg lb	*25 450 *59,000	*25 450 *59,000	*27 450 *59,650	22 650 48,700	*22 300 *48,300	16 300 35,150	17 800 38,400	12 750 27,500			16 100 35,500	11 600 25,550	9710 31'9"
-3000 mm -10'0"	kg lb	*28 950 *63,100	*28 950 *63,100	*24 550 *53,150	22 900 49,250	*20 050 *43,200	16 500 35,550					*15 650 *34,400	13 150 29,100	8920 29'1"
-4500 mm -15'0"	kg lb	*23 150 *49,900	*23 150 *49,900	*19 800 *42,400	*19 800 *42,400	*15 350 *32,000	*15 350 *32,000					*14 300 *31,250	*14 300 *31,250	7770 25'2"



ISO 10567:2007



*Indicates that the load is limited by hydraulic lifting capacity rather than tipping load. The above loads are in compliance with hydraulic excavator lift capacity standard ISO 10567:2007. They do not exceed 87% of hydraulic lifting capacity or 75% of tipping load. Weight of all lifting accessories must be deducted from the above lifting capacities. Lifting capacities are based on the machine standing on a firm, uniform supporting surface. The use of a work tool attachment point to handle/lift objects, could affect the machine lift performance.

Lift capacity stays with ±5% for all available track shoes.

Always refer to the appropriate Operation and Maintenance Manual for specific product information.

374 Hydraulic Excavator Specifications

Reach Boom Lift Capacities – Standard Counterweight – without Bucket, Heavy Lift: On

Long Variable Gauge Undercarriage

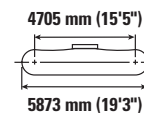
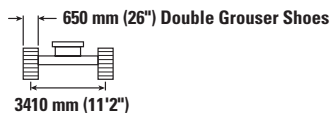

		4500 mm/15'0"		6000 mm/20'0"		7500 mm/25'0"		9000 mm/30'0"		10 500 mm/35'0"		mm ft/in		
10 500 mm 35'0"	kg lb											*19 150	*19 150	6820
9000 mm 30'0"	kg lb					*17 850 *39,300	*17 850 *39,300					*17 600 *39,000	16 700 37,650	8290 26'9"
7500 mm 25'0"	kg lb					*18 300 *39,850	*18 300 *39,850	*17 000 *37,350	14 400 30,850			*16 900 *37,300	13 650 30,450	9280 30'2"
6000 mm 20'0"	kg lb	*31 150 *66,400	*31 150 *66,400	*23 350 *50,350	*23 350 *50,350	*19 550 *42,350	18 800 40,550	*17 350 *37,800	14 150 30,400			16 300 36,200	11 950 26,550	9950 32'6"
4500 mm 15'0"	kg lb			*26 500 *57,000	24 900 53,750	*21 100 *45,650	17 950 38,750	*18 100 *39,250	13 700 29,500			15 050 33,300	11 000 24,300	10 350 33'10"
3000 mm 10'0"	kg lb			*28 950 *62,450	23 450 50,600	*22 500 *48,700	17 150 37,000	18 300 39,400	13 250 28,550	14 500	10 550	14 450 31,900	10 500 23,150	10 530 34'6"
1500 mm 5'0"	kg lb			*29 800 *64,500	22 650 48,800	*23 350 50,450	16 550 35,700	17 900 38,550	12 850 27,750			14 350 31,650	10 400 22,900	10 480 34'4"
0 mm 0'0"	kg lb			*29 200 *63,350	22 400 48,150	23 050 49,650	16 250 35,000	17 650 38,050	12 650 27,250			14 800 32,600	10 700 23,550	10 220 33'6"
-1500 mm -5'0"	kg lb	*25 450 *59,000	*25 450 *59,000	*27 450 *59,650	22 400 48,200	*22 300 *48,300	16 150 34,800	17 650 38,000	12 600 27,200			15 900 35,150	11 450 25,300	9710 31'9"
-3000 mm -10'0"	kg lb	*28 950 *63,100	*28 950 *63,100	*24 550 *53,150	22 700 48,800	*20 050 *43,200	16 350 35,200					*15 650 *34,400	13 000 28,800	8920 29'1"
-4500 mm -15'0"	kg lb	*23 150 *49,900	*23 150 *49,900	*19 800 *42,400	*19 800 *42,400	*15 350 *32,000	*15 350 *32,000					*14 300 *31,250	*14 300 *31,250	7770 25'2"



ISO 10567:2007



*Indicates that the load is limited by hydraulic lifting capacity rather than tipping load. The above loads are in compliance with hydraulic excavator lift capacity standard ISO 10567:2007. They do not exceed 87% of hydraulic lifting capacity or 75% of tipping load. Weight of all lifting accessories must be deducted from the above lifting capacities. Lifting capacities are based on the machine standing on a firm, uniform supporting surface. The use of a work tool attachment point to handle/lift objects, could affect the machine lift performance.

Lift capacity stays with ±5% for all available track shoes.

Always refer to the appropriate Operation and Maintenance Manual for specific product information.

374 Hydraulic Excavator Specifications

Mass Boom Lift Capacities – Standard Counterweight – without Bucket, Heavy Lift: On

Long Variable Gauge Undercarriage

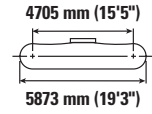
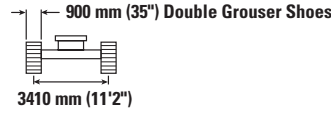
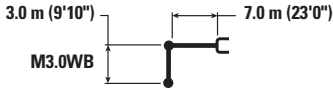

Boom Length	Unit	3000 mm/10'0"		4500 mm/15'0"		6000 mm/20'0"		7500 mm/25'0"		9000 mm/30'0"		mm ft/in		
		kg lb	kg lb	kg lb	kg lb	kg lb	kg lb	kg lb	kg lb	kg lb	kg lb	kg lb	kg lb	
9000 mm 30'0"	kg lb											*15 100 *33,500	*15 100 *33,500	7350 23'7"
7500 mm 25'0"	kg lb							*17 800 *39,000	*17 800 *39,000			*14 300 *31,550	*14 300 *31,550	8450 27'5"
6000 mm 20'0"	kg lb					*21 400 *46,300	*21 400 *46,300	*18 650 *40,600	*18 650 *40,600	*17 200 14 250		*14 100 *31,050	*13 750 30,500	9180 29'11"
4500 mm 15'0"	kg lb			*33 250 *71,100	*33 250 *71,100	*24 350 *52,550	*24 350 *52,550	*20 100 *43,550	18 550 39,950	*17 700 *38,550	13 900 29,800	*14 350 *31,550	12 400 27,450	9620 31'6"
3000 mm 10'0"	kg lb					*27 200 *58,700	24 650 53,100	*21 600 *46,800	17 700 38,100	*18 400 *39,900	13 450 28,900	*15 000 *32,950	11 750 25,900	9810 32'1"
1500 mm 5'0"	kg lb					*28 950 *62,650	23 500 50,600	*22 700 *49,150	17 000 36,600	18 250 39,300	13 050 28,100	*16 150 *35,550	11 600 25,500	9760 32'0"
0 mm 0'0"	kg lb			*31 750 *73,600	*31 750 *73,600	*29 250 *63,350	22 900 49,300	*23 000 *49,800	16 550 35,650	18 000 38,750	12 800 27,600	16 750 36,850	11 950 26,300	9480 31'0"
-1500 mm -5'0"	kg lb	*26 150 *59,100	*26 150 *59,100	*36 050 *78,350	*36 050 *78,350	*28 000 *60,700	22 750 48,950	*22 150 *47,900	16 400 35,350			*17 650 *38,850	12 950 28,600	8930 29'2"
-3000 mm -10'0"	kg lb	*38 850 *84,650	*38 850 *84,650	*31 650 *68,600	*31 650 *68,600	*25 100 *54,200	23 000 49,500	*19 550 *41,850	16 600 35,850			*17 400 *38,250	15 150 33,550	8060 26'3"
-4500 mm -15'0"	kg lb			*24 550 *52,550	*24 550 *52,550	*19 250 *40,750	*19 250 *40,750					*16 100 *35,250	*16 100 *35,250	6750 21'10"



ISO 10567:2007



*Indicates that the load is limited by hydraulic lifting capacity rather than tipping load. The above loads are in compliance with hydraulic excavator lift capacity standard ISO 10567:2007. They do not exceed 87% of hydraulic lifting capacity or 75% of tipping load. Weight of all lifting accessories must be deducted from the above lifting capacities. Lifting capacities are based on the machine standing on a firm, uniform supporting surface. The use of a work tool attachment point to handle/lift objects, could affect the machine lift performance.

Lift capacity stays with ±5% for all available track shoes.

Always refer to the appropriate Operation and Maintenance Manual for specific product information.

374 Hydraulic Excavator Specifications

Mass Boom Lift Capacities – Standard Counterweight – without Bucket, Heavy Lift: On

Long Variable Gauge Undercarriage

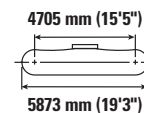
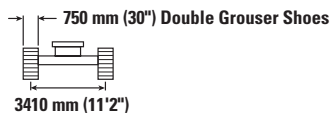

		3000 mm/10'0"		4500 mm/15'0"		6000 mm/20'0"		7500 mm/25'0"		9000 mm/30'0"		mm ft/in		
9000 mm 30'0"	kg lb											*15 100 *33,500	*15 100 *33,500	7350 23'7"
7500 mm 25'0"	kg lb							*17 800 *39,000	*17 800 *39,000			*14 300 *31,550	*14 300 *31,550	8450 27'5"
6000 mm 20'0"	kg lb					*21 400 *46,300	*21 400 *46,300	*18 650 *40,600	*18 650 *40,600	*17 200 14 050		*14 100 *31,050	*13 550 30,100	9180 29'11"
4500 mm 15'0"	kg lb			*33 250 *71,100	*33 250 *71,100	*24 350 *52,550	*24 350 *52,550	*20 100 *43,550	18 300 39,400	*17 700 *38,550	13 700 29,400	*14 350 *31,550	12 250 27,050	9620 31'6"
3000 mm 10'0"	kg lb					*27 200 *58,700	24 300 52,400	*21 600 *46,800	17 450 37,550	*18 400 39,600	13 250 28,500	*15 000 *32,950	11 550 25,500	9810 32'1"
1500 mm 5'0"	kg lb					*28 950 *62,650	23 150 49,850	*22 700 *49,150	16 750 36,050	18 000 38,750	12 850 27,650	15 950 35,100	11 400 25,150	9760 32'0"
0 mm 0'0"	kg lb			*31 750 *73,600	*31 750 *73,600	*29 250 *63,350	22 550 48,550	*23 000 *49,800	16 300 35,100	17 750 38,200	12 600 27,150	16 500 36,300	11 750 25,900	9480 31'0"
-1500 mm -5'0"	kg lb	*26 150 *59,100	*26 150 *59,100	*36 050 *78,350	*36 050 *77,300	*28 000 *60,700	22 450 48,250	*22 150 *47,900	16 150 34,800			*17 650 *38,850	12 750 28,150	8930 29'2"
-3000 mm -10'0"	kg lb	*38 850 *84,650	*38 850 *84,650	*31 650 *68,600	*31 650 *68,600	*25 100 *54,200	22 650 48,800	*19 550 *41,850	16 350 35,350			*17 400 *38,250	14 900 33,050	8060 26'3"
-4500 mm -15'0"	kg lb			*24 550 *52,550	*24 550 *52,550	*19 250 *40,750	*19 250 *40,750					*16 100 *35,250	*16 100 *35,250	6750 21'10"



ISO 10567:2007



*Indicates that the load is limited by hydraulic lifting capacity rather than tipping load. The above loads are in compliance with hydraulic excavator lift capacity standard ISO 10567:2007. They do not exceed 87% of hydraulic lifting capacity or 75% of tipping load. Weight of all lifting accessories must be deducted from the above lifting capacities. Lifting capacities are based on the machine standing on a firm, uniform supporting surface. The use of a work tool attachment point to handle/lift objects, could affect the machine lift performance.

Lift capacity stays with ±5% for all available track shoes.

Always refer to the appropriate Operation and Maintenance Manual for specific product information.

374 Hydraulic Excavator Specifications

Mass Boom Lift Capacities – Standard Counterweight – without Bucket, Heavy Lift: On

Long Variable Gauge Undercarriage

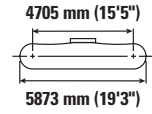
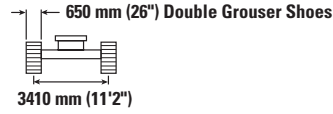
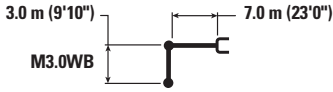

Boom Length	Unit	3000 mm/10'0"		4500 mm/15'0"		6000 mm/20'0"		7500 mm/25'0"		9000 mm/30'0"		mm ft/in		
		kg lb	kg lb	kg lb	kg lb	kg lb	kg lb	kg lb	kg lb	kg lb	kg lb	kg lb	kg lb	
9000 mm 30'0"	kg lb											*15 100 *33,500	*15 100 *33,500	7350 23'7"
7500 mm 25'0"	kg lb							*17 800 *39,000	*17 800 *39,000			*14 300 *31,550	*14 300 *31,550	8450 27'5"
6000 mm 20'0"	kg lb					*21 400 *46,300	*21 400 *46,300	*18 650 *40,600	*18 650 *40,600	*17 200 13 900		*14 100 *31,050	*14 100 29,800	13 400 29'11"
4500 mm 15'0"	kg lb			*33 250 *71,100	*33 250 *71,100	*24 350 *52,550	*24 350 *52,550	*20 100 *43,550	18 150 39,050	*17 700 *38,550	13 550 29,100	*14 350 *31,550	12 100 26,800	9620 31'6"
3000 mm 10'0"	kg lb					*27 200 *58,700	24 050 51,900	*21 600 *46,800	17 250 37,200	18 250 39,250	13 100 28,200	*15 000 *32,950	11 450 25,250	9810 32'1"
1500 mm 5'0"	kg lb					*28 950 *62,650	22 950 49,400	*22 700 *49,150	16 600 35,700	17 800 38,350	12 700 27,400	15 800 34,750	11 300 24,850	9760 32'0"
0 mm 0'0"	kg lb			*31 750 *73,600	*31 750 *73,600	*29 250 *63,350	22 350 48,050	*23 000 49,600	16 150 34,750	17 550 37,800	12 500 26,900	16 300 35,950	11 650 25,650	9480 31'0"
-1500 mm -5'0"	kg lb	*26 150 *59,100	*26 150 *59,100	*36 050 *78,350	35 750 76,550	*28 000 *60,700	22 200 47,750	*22 150 *47,900	16 000 34,450			*17 650 *38,850	12 650 27,900	8930 29'2"
-3000 mm -10'0"	kg lb	*38 850 *84,650	*38 850 *84,650	*31 650 *68,600	*31 650 *68,600	*25 100 *54,200	22 450 48,300	*19 550 *41,850	16 200 35,000			*17 400 *38,250	14 750 32,700	8060 26'3"
-4500 mm -15'0"	kg lb			*24 550 *52,550	*24 550 *52,550	*19 250 *40,750	*19 250 *40,750					*16 100 *35,250	*16 100 *35,250	6750 21'10"



ISO 10567:2007



*Indicates that the load is limited by hydraulic lifting capacity rather than tipping load. The above loads are in compliance with hydraulic excavator lift capacity standard ISO 10567:2007. They do not exceed 87% of hydraulic lifting capacity or 75% of tipping load. Weight of all lifting accessories must be deducted from the above lifting capacities. Lifting capacities are based on the machine standing on a firm, uniform supporting surface. The use of a work tool attachment point to handle/lift objects, could affect the machine lift performance.

Lift capacity stays with ±5% for all available track shoes.

Always refer to the appropriate Operation and Maintenance Manual for specific product information.

374 Hydraulic Excavator Specifications

Mass Boom Lift Capacities – Standard Counterweight – without Bucket, Heavy Lift: On

Long Variable Gauge Undercarriage

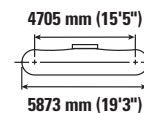
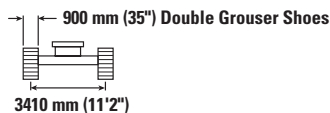
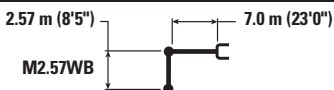

Boom Length	Unit	3000 mm/10'0"		4500 mm/15'0"		6000 mm/20'0"		7500 mm/25'0"		9000 mm/30'0"		mm ft/in		
		kg lb	kg lb	kg lb	kg lb	kg lb	kg lb	kg lb	kg lb	kg lb	kg lb	kg lb	kg lb	
9000 mm 30'0"	kg lb											*18 150 *40,350	*18 150 *40,350	6820 21'10"
7500 mm 25'0"	kg lb							*18 850 *41,450	*18 850 *41,450			*17 100 *37,750	*17 100 *37,750	8000 25'11"
6000 mm 20'0"	kg lb					*22 600 *48,900	*22 600 *48,900	*19 550 *42,600	19 250 41,400			*16 850 *37,100	14 800 32,900	8770 28'7"
4500 mm 15'0"	kg lb					*25 450 *54,950	*25 450 *54,950	*20 900 *45,300	18 450 39,800	*18 400 *40,100	13 850 29,800	*17 150 *37,750	13 300 29,450	9230 30'2"
3000 mm 10'0"	kg lb					*28 100 *60,650	24 450 52,750	*22 250 *48,150	17 650 38,100	18 750 40,300	13 500 29,050	17 450 38,450	12 600 27,750	9430 30'10"
1500 mm 5'0"	kg lb					*29 450 *63,750	23 500 50,600	*23 100 *50,100	17 050 36,750	18 400 39,550	13 150 28,350	17 300 38,100	12 400 27,350	9380 30'9"
0 mm 0'0"	kg lb			*29 500 *69,100	*29 500 *69,100	*29 300 *63,500	23 050 49,600	*23 150 *50,100	16 700 35,950	18 200	13 000	18 000 39,650	12 850 28,350	9080 29'9"
-1500 mm -5'0"	kg lb		*60,300	*34 600 *75,450	*34 600 *75,450	*27 600 *59,850	23 000 49,500	*21 900 *47,300	16 650 35,850			*18 450 *40,650	14 100 31,100	8500 27'10"
-3000 mm -10'0"	kg lb	*34 200 *74,750	*34 200 *74,750	*29 800 *64,700	*29 800 *64,700	*24 100 *51,950	23 350 50,300	*18 350	17 000			*17 950 *39,500	16 800 37,250	7590 24'9"
-4500 mm -15'0"	kg lb			*21 750 *46,400	*21 750 *46,400	*16 700	*16 700					*15 900 *34,600	*15 900 *34,600	6170 19'11"



ISO 10567:2007



*Indicates that the load is limited by hydraulic lifting capacity rather than tipping load. The above loads are in compliance with hydraulic excavator lift capacity standard ISO 10567:2007. They do not exceed 87% of hydraulic lifting capacity or 75% of tipping load. Weight of all lifting accessories must be deducted from the above lifting capacities. Lifting capacities are based on the machine standing on a firm, uniform supporting surface. The use of a work tool attachment point to handle/lift objects, could affect the machine lift performance.

Lift capacity stays with ±5% for all available track shoes.

Always refer to the appropriate Operation and Maintenance Manual for specific product information.

374 Hydraulic Excavator Specifications

Mass Boom Lift Capacities – Standard Counterweight – without Bucket, Heavy Lift: On

Long Variable Gauge Undercarriage

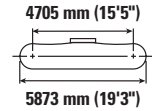
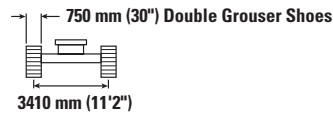
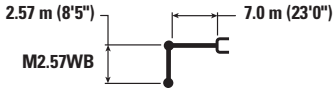

Boom Length	Unit	3000 mm/10'0"		4500 mm/15'0"		6000 mm/20'0"		7500 mm/25'0"		9000 mm/30'0"		mm ft/in		
		kg lb	kg lb	kg lb	kg lb	kg lb	kg lb	kg lb	kg lb	kg lb	kg lb	kg lb	kg lb	
9000 mm 30'0"	kg lb											*18 150 *40,350	*18 150 *40,350	6820 21'10"
7500 mm 25'0"	kg lb							*18 850 *41,450	*18 850 *41,450			*17 100 *37,750	*17 100 *37,750	8000 25'11"
6000 mm 20'0"	kg lb					*22 600 *48,900	*22 600 *48,900	*19 550 *42,600	19 000 40,850			*16 850 *37,100	14 600 32,450	8770 28'7"
4500 mm 15'0"	kg lb					*25 450 *54,950	*25 450 *54,950	*20 900 *45,300	18 200 39,250	*18 400 *40,100	13 700 29,400	*17 150 *37,750	13 150 29,000	9230 30'2"
3000 mm 10'0"	kg lb					*28 100 *60,650	24 150 52,050	*22 250 *48,150	17 450 37,550	18 450 39,700	13 300 28,600	17 200 37,900	12 400 27,350	9430 30'10"
1500 mm 5'0"	kg lb					*29 450 *63,750	23 150 49,850	*23 100 *50,100	16 800 36,200	18 100 39,000	12 950 27,950	17 050 37,550	12 250 26,950	9380 30'9"
0 mm 0'0"	kg lb			*29 500 *69,100	*29 500 *69,100	*29 300 *63,500	22 700 48,850	*23 150 *50,100	16 450 35,450	17 950	12 800	17 750 39,050	12 650 27,900	9080 29'9"
-1500 mm -5'0"	kg lb		*60,300	*34 600 *75,450	*34 600 *75,450	*27 600 *59,850	22 700 48,800	*21 900 *47,300	16 400 35,350			*18 450 *40,650	13 900 30,650	8500 27'10"
-3000 mm -10'0"	kg lb	*34 200 *74,750	*34 200 *74,750	*29 800 *64,700	*29 800 *64,700	*24 100 *51,950	23 050 49,600	*18 350	16 750			*17 950 *39,500	16 550 36,700	7590 24'9"
-4500 mm -15'0"	kg lb			*21 750 *46,400	*21 750 *46,400	*16 700	*16 700					*15 900 *34,600	*15 900 *34,600	6170 19'11"



ISO 10567:2007



*Indicates that the load is limited by hydraulic lifting capacity rather than tipping load. The above loads are in compliance with hydraulic excavator lift capacity standard ISO 10567:2007. They do not exceed 87% of hydraulic lifting capacity or 75% of tipping load. Weight of all lifting accessories must be deducted from the above lifting capacities. Lifting capacities are based on the machine standing on a firm, uniform supporting surface. The use of a work tool attachment point to handle/lift objects, could affect the machine lift performance.

Lift capacity stays with ±5% for all available track shoes.

Always refer to the appropriate Operation and Maintenance Manual for specific product information.

374 Hydraulic Excavator Specifications

Mass Boom Lift Capacities – Standard Counterweight – without Bucket, Heavy Lift: On

Long Variable Gauge Undercarriage

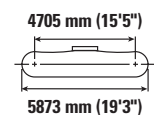
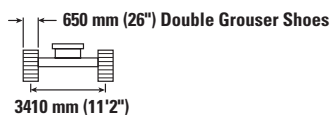

Boom Length	Unit	3000 mm/10'0"		4500 mm/15'0"		6000 mm/20'0"		7500 mm/25'0"		9000 mm/30'0"		mm ft/in		
		kg lb	kg lb	kg lb	kg lb	kg lb	kg lb	kg lb	kg lb	kg lb	kg lb	kg lb	kg lb	
9000 mm 30'0"	kg lb											*18 150 *40,350	*18 150 *40,350	6820 21'10"
7500 mm 25'0"	kg lb							*18 850 *41,450	*18 850 *41,450			*17 100 *37,750	*17 100 *37,750	8000 25'11"
6000 mm 20'0"	kg lb					*22 600 *48,900	*22 600 *48,900	*19 550 *42,600	18 850 40,500			*16 850 *37,100	14 500 32,150	8770 28'7"
4500 mm 15'0"	kg lb					*25 450 *54,950	25 450 54,850	*20 900 *45,300	18 050 38,900	*18 400 *40,100	13 550 29,100	*17 150 *37,750	13 000 28,750	9230 30'2"
3000 mm 10'0"	kg lb					*28 100 *60,650	23 900 51,550	*22 250 *48,150	17 250 37,200	18 300 39,350	13 150 28,350	17 000 37,550	12 250 27,050	9430 30'10"
1500 mm 5'0"	kg lb					*29 450 *63,750	22 900 49,350	*23 100 *50,100	16 650 35,850	17 950 38,600	12 850 27,650	16 900 37,200	12 100 26,700	9380 30'9"
0 mm 0'0"	kg lb			*29 500 *69,100	*29 500 *69,100	*29 300 *63,500	22 500 48,400	*23 150 49,900	16 300 35,100	17 750	12 700	17 550 38,700	12 550 27,600	9080 29'9"
-1500 mm -5'0"	kg lb		*60,300	*34 600 *75,450	*34 600 *75,450	*27 600 *59,850	22 450 48,300	*21 900 *47,300	16 250 35,000			*18 450 *40,650	13 750 30,350	8500 27'10"
-3000 mm -10'0"	kg lb	*34 200 *74,750	*34 200 *74,750	*29 800 *64,700	*29 800 *64,700	*24 100 *51,950	22 800 49,100	*18 350	16 600			*17 950 *39,500	16 400 36,350	7590 24'9"
-4500 mm -15'0"	kg lb			*21 750 *46,400	*21 750 *46,400	*16 700	*16 700					*15 900 *34,600	*15 900 *34,600	6170 19'11"



ISO 10567:2007



*Indicates that the load is limited by hydraulic lifting capacity rather than tipping load. The above loads are in compliance with hydraulic excavator lift capacity standard ISO 10567:2007. They do not exceed 87% of hydraulic lifting capacity or 75% of tipping load. Weight of all lifting accessories must be deducted from the above lifting capacities. Lifting capacities are based on the machine standing on a firm, uniform supporting surface. The use of a work tool attachment point to handle/lift objects, could affect the machine lift performance.

Lift capacity stays with ±5% for all available track shoes.

Always refer to the appropriate Operation and Maintenance Manual for specific product information.

374 Hydraulic Excavator Specifications

Bucket Specifications and Compatibility – Africa, Middle East and Eurasia

	Undercarriage Counterweight							Long Variable Gauge			
	Width		Capacity		Weight		Fill	11.24 mt (24,770 lb)			
	mm	in	m ³	yd ³	kg	lb	%	7.8 m (25'7") Reach		7.0 m (23'0") Mass	
								R3.6 m (11'10")	R4.67 m (15'4")	M2.57 m (8'5")	M3.0 m (9'10")
No Coupler											
General Duty	2000	79	3.80	4.97	3649	8,045	100	⊖	○		
Heavy Duty	2000	79	3.80	4.97	3810	8,400	100	⊖	○		
General Duty	2150	85	5.00	6.54	4164	9,180	100			⊙	⊖
Heavy Duty	2150	85	5.00	6.54	4340	9,569	100			⊙	⊖
Severe Duty Spade	1950	77	4.10	5.36	4821	10,629	90			●	●
	2050	81	4.40	5.75	4977	10,973	90			●	⊙
	2150	85	4.60	6.02	5134	11,319	90			●	⊙
	2250	89	5.00	6.54	5291	11,665	90			⊙	⊖
Extreme Duty Spade	2050	81	4.40	5.75	5768	12,717	90			⊙	⊖
	2150	85	4.60	6.02	5955	13,129	90			⊙	⊖
	2250	89	5.00	6.54	6139	13,535	90			⊖	○
							kg	9891	8282	13 611	12 502
Maximum load with pin-on (payload + bucket)							lb	21,804	18,254	30,005	27,558
With CW-70											
Severe Duty Spade	1950	77	4.00	5.23	4795	10,572	90			●	⊙
	2050	81	4.40	5.75	4950	10,913	90			⊙	⊖
Extreme Duty Spade	2050	81	4.40	5.75	5551	12,238	90			⊙	⊖
							kg			12 331	11 222
Maximum load with coupler (payload + bucket)							lb			27,185	24,740

Maximum Material Density:

- 2100 kg/m³ (3,500 lb/yd³)
- ⊙ 1800 kg/m³ (3,000 lb/yd³)
- ⊖ 1500 kg/m³ (2,500 lb/yd³)
- 1200 kg/m³ (2,000 lb/yd³)

The above loads are in compliance with hydraulic excavator standard EN474-5:2006 + A3:2013, they do not exceed 87% of hydraulic lifting capacity or 75% of tipping capacity with front linkage fully extended at ground line with bucket curled.

Capacity based on ISO 7451:2007.

Bucket weight with General Duty tips.

Caterpillar recommends using appropriate work tools to maximize the value customers receive from our products. Use of work tools, including buckets, which are outside of Caterpillar's recommendations or specifications for weight, dimensions, flows, pressures, etc. may result in less-than-optimal performance, including but not limited to reductions in production, stability, reliability, and component durability. Improper use of a work tool resulting in sweeping, prying, twisting and/or catching of heavy loads will reduce the life of the boom and stick.

374 Hydraulic Excavator Specifications

Bucket Specifications and Compatibility – Australia and New Zealand

	Undercarriage Counterweight							Long Variable Gauge			
	Width		Capacity		Weight		Fill	7.8 m (25'7") Reach			7.0 m (23'0") Mass
	mm	in	m ³	yd ³	kg	lb		%	R2.84 m (9'4")	R3.6 m (11'10")	
No Coupler											
Severe Duty	1600	64	2.90	3.79	3455	7,617	90	●	●	⊙	
	1750	70	3.30	4.32	3651	8,050	90	●	●	⊖	
	2000	79	3.80	4.97	4015	8,851	90	●	⊙	○	
Severe Duty Spade	2150	85	4.60	6.02	5134	11,319	90				●
	2200	87	4.60	6.02	5166	11,390	90				●
Extreme Duty Spade	2050	81	4.40	5.75	5768	12,717	90				●
	2150	85	4.60	6.02	5955	13,129	90				⊙
Maximum load with pin-on (payload + bucket)							kg	11 170	10 035	8410	13 795
							lb	24,626	22,123	18,541	30,413
With Cat Pin Grabber Coupler											
Severe Duty	1600	64	2.90	3.79	3455	7,617	90	●	⊙	○	
	1750	70	3.30	4.32	3651	8,050	90	●	⊖	◇	
	2000	79	3.80	4.97	4015	8,851	90	⊖	○	◇	
Maximum load with coupler (payload + bucket)							kg	9778	8640	7014	
							lb	21,557	19,048	15,463	

Maximum Material Density:

- 2100 kg/m³ (3,500 lb/yd³)
- ⊙ 1800 kg/m³ (3,000 lb/yd³)
- ⊖ 1500 kg/m³ (2,500 lb/yd³)
- 1200 kg/m³ (2,000 lb/yd³)
- ◇ 900 kg/m³ (1,500 lb/yd³)

The above loads are in compliance with hydraulic excavator standard EN474-5:2006 + A3:2013, they do not exceed 87% of hydraulic lifting capacity or 75% of tipping capacity with front linkage fully extended at ground line with bucket curled.

Capacity based on ISO 7451:2007.

Bucket weight with General Duty tips.

Caterpillar recommends using appropriate work tools to maximize the value customers receive from our products. Use of work tools, including buckets, which are outside of Caterpillar's recommendations or specifications for weight, dimensions, flows, pressures, etc. may result in less-than-optimal performance, including but not limited to reductions in production, stability, reliability, and component durability. Improper use of a work tool resulting in sweeping, prying, twisting and/or catching of heavy loads will reduce the life of the boom and stick.

374 Hydraulic Excavator Specifications

Bucket Specifications and Compatibility – Hong Kong, Taiwan

								Undercarriage	Long Variable Gauge	
								Counterweight	11.24 mt (24,770 lb)	
	Width		Capacity		Weight		Fill	7.8 m (25'7") Reach	7.0 m (23'0") Mass	
	mm	in	m ³	yd ³	kg	lb	%	R3.6 m (11'10")	M3.0 m (9'10")	
No Coupler										
Severe Duty	1950	77	3.00	3.92	3660	8,068	90	●		
Severe Duty Spade	2200	87	4.60	6.02	5166	11,390	90		⊙	
	2250	89	5.00	6.54	5291	11,665	90		⊖	
Extreme Duty Spade	2200	87	4.40	5.75	5790	12,765	90		⊖	
							kg	9890	12 500	
Maximum load with pin-on (payload + bucket)							lb	21,804	27,558	

The above loads are in compliance with hydraulic excavator standard EN474-5:2006 + A3:2013, they do not exceed 87% of hydraulic lifting capacity or 75% of tipping capacity with front linkage fully extended at ground line with bucket curled.

Capacity based on ISO 7451:2007.

Bucket weight with General Duty tips.

Maximum Material Density:

● 2100 kg/m³ (3,500 lb/yd³)

⊙ 1800 kg/m³ (3,000 lb/yd³)

⊖ 1500 kg/m³ (2,500 lb/yd³)

Caterpillar recommends using appropriate work tools to maximize the value customers receive from our products. Use of work tools, including buckets, which are outside of Caterpillar's recommendations or specifications for weight, dimensions, flows, pressures, etc. may result in less-than-optimal performance, including but not limited to reductions in production, stability, reliability, and component durability. Improper use of a work tool resulting in sweeping, prying, twisting and/or catching of heavy loads will reduce the life of the boom and stick.

374 Hydraulic Excavator Specifications

Bucket Specifications and Compatibility – South America

							Undercarriage	Long Variable Gauge	
							Counterweight	11.24 mt (24,770 lb)	
	Width		Capacity		Weight		Fill	7.0 m (23'0") Mass	
	mm	in	m ³	yd ³	kg	lb	%	M2.57 m (8'5")	M3.0 m (9'10")
No Coupler									
Severe Duty Spade	1950	77	4.10	5.36	4821	10,629	90	●	●
	2050	81	4.40	5.75	4977	10,973	90	●	⊙
	2150	85	4.60	6.02	5134	11,319	90	●	⊙
Extreme Duty Spade	2150	85	4.60	6.02	6234	13,744	90	⊙	⊖
Maximum load with pin-on (payload + bucket)							kg	13 611	12 502
							lb	30,005	27,558
With CW-70									
Severe Duty Spade	1950	77	4.00	5.23	4795	10,572	90	●	⊙
	2050	81	4.40	5.75	4950	10,913	90	⊙	⊖
Extreme Duty Spade	2050	81	4.40	5.75	5551	12,238	90	⊙	⊖
Maximum load with coupler (payload + bucket)							kg	12 331	11 222
							lb	27,185	24,740

The above loads are in compliance with hydraulic excavator standard EN474-5:2006 + A3:2013, they do not exceed 87% of hydraulic lifting capacity or 75% of tipping capacity with front linkage fully extended at ground line with bucket curled.

Capacity based on ISO 7451:2007.

Bucket weight with General Duty tips.

Maximum Material Density:

- 2100 kg/m³ (3,500 lb/yd³)
- ⊙ 1800 kg/m³ (3,000 lb/yd³)
- ⊖ 1500 kg/m³ (2,500 lb/yd³)

Caterpillar recommends using appropriate work tools to maximize the value customers receive from our products. Use of work tools, including buckets, which are outside of Caterpillar's recommendations or specifications for weight, dimensions, flows, pressures, etc. may result in less-than-optimal performance, including but not limited to reductions in production, stability, reliability, and component durability. Improper use of a work tool resulting in sweeping, prying, twisting and/or catching of heavy loads will reduce the life of the boom and stick.

Bucket Specifications and Compatibility – Southeast Asia

							Undercarriage	Long Variable Gauge	
							Counterweight	11.24 mt (24,770 lb)	
	Width		Capacity		Weight		Fill	7.8 m (25'7") Reach	7.0 m (23'0") Mass
	mm	in	m ³	yd ³	kg	lb	%	R2.84 m (9'4")	M2.57 m (8'5")
No Coupler									
Severe Duty	1950	77	3.00	3.92	3660	8,068	90	●	
Severe Duty Spade	2200	87	4.60	6.02	5166	11,390	90		●
	2250	89	5.00	6.54	5291	11,665	90		⊙
Extreme Duty Spade	2200	87	4.40	5.75	5790	12,765	90		⊙
Maximum load with pin-on (payload + bucket)							kg	11 120	13 610
							lb	24,515	30,005

The above loads are in compliance with hydraulic excavator standard EN474-5:2006 + A3:2013, they do not exceed 87% of hydraulic lifting capacity or 75% of tipping capacity with front linkage fully extended at ground line with bucket curled.

Capacity based on ISO 7451:2007.

Bucket weight with General Duty tips.

Maximum Material Density:

- 2100 kg/m³ (3,500 lb/yd³)
- ⊙ 1800 kg/m³ (3,000 lb/yd³)

Caterpillar recommends using appropriate work tools to maximize the value customers receive from our products. Use of work tools, including buckets, which are outside of Caterpillar's recommendations or specifications for weight, dimensions, flows, pressures, etc. may result in less-than-optimal performance, including but not limited to reductions in production, stability, reliability, and component durability. Improper use of a work tool resulting in sweeping, prying, twisting and/or catching of heavy loads will reduce the life of the boom and stick.

374 Hydraulic Excavator Specifications

Typical Pass Match Guide

For maximum production and efficiency, we recommend that loading and hauling machines are matched to achieve optimal performance.

Configuration*:

Long Variable Gauge undercarriage, Mass boom, R2.57WB (8'5") stick, SD 4.60 m³ (6.02 yd³) bucket, 650 mm (26") HD double grouser shoes and standard counterweight.

Passes Required to Fill Trucks to Rated Capacity

Material Type	Material Density	Fill Factor	Cat Articulated Trucks							Cat Off-Highway Trucks			
			725	730 EJ	730	735	740 GC	740 EJ	745	770G	772G	773E	773G
Earth	1600 kg/m ³ (2,700 lb/yd ³)	100%		3-4	3-4	4-5	5	5	5-6	5	6-7	7-8	7-8
Limestone	1540 kg/m ³ (2,600 lb/yd ³)	90%	3-4	4-5	4-5	5	5-6	6	6-7	6	7		

*The indicated pass match reflects the machine configuration, fill factor, and typical material density shown. Changes to machine configurations, fill factors, or material density as well as jobsite-specific factors may influence exact pass match recommendations for your application. Consult your Cat dealer for more information.

374 Hydraulic Excavator Specifications

Attachments Offering Guide – Africa, Middle East and Eurasia

Not all attachments are available in all regions. Consult your Cat dealer for configurations available in your region.

Match
 Working range front only
 No Match
 1800 kg/m³ (3,000 lb/yd³)
 1200 kg/m³ (2,000 lb/yd³)

PIN-ON ATTACHMENTS

Undercarriage		Long Variable Gauge			
Counterweight		11.24 mt (24,770 lb)			
Boom Type		Reach HD		ME	
Stick Length		3.60 m HD (11'10")	4.67 m HD (15'4")	2.57 m (8'5")	3.0 m (9'10")
Hydraulic Hammers	H180 S	✓	✓	✓	✓
	H190 S	✓	✓	✓	✓
	H215 S	✓	✓*	✓	✓
Multi-Processors	MP365 Concrete Cutter Jaw	✓	✓	✓	✓
	MP365 Demolition Jaw	✓	✓	✓	✓
	MP365 Pulverizer Jaw	✓	✓	✓	✓
	MP365 Shear Jaw	✓	✓	✓	✓
Mobile Scrap and Demolition Shears	S3070 Flat Top	✓		✓	✓
Pulverizers	P245 Secondary Pulverizer	✓	✓		
	P365 Primary Pulverizer	✓	✓	✓	✓
	P365 Primary Pulverizer-Flat Top	✓	✓*		
Orange Peel Grapples	GSM-60-3750			○	○
Clamshell Grapples	CTV40-3500	○		●	●
	CTV40-4000	○		●	○
	CTV40-4500			○	○
	CTV40-5000			○	○

CAT PIN GRABBER COUPLER ATTACHMENTS

Undercarriage		Long Variable Gauge	
Counterweight		11.24 mt (24,770 lb)	
Boom Type		Reach	
Stick Length		3.60 m (11'10")	4.67 m (15'4")
Hydraulic Hammers	H180 S	✓	✓
	H190 S	✓	✓
	H215 S	✓*	
Multi-Processors	MP365 Concrete Cutter Jaw	✓	✓*
	MP365 Demolition Jaw	✓	
	MP365 Pulverizer Jaw	✓	
	MP365 Shear Jaw	✓	✓*
Pulverizers	P245 Secondary Pulverizer	✓	✓
	P365 Primary Pulverizer	✓	

(continued on next page)

374 Hydraulic Excavator Specifications

Attachments Offering Guide – Africa, Middle East and Eurasia (continued)

Not all attachments are available in all regions. Consult your Cat dealer for configurations available in your region.

Match
 Working range front only
 No Match

CW-70 DEDICATED COUPLER ATTACHMENTS

Undercarriage		Long Variable Gauge			
Counterweight		11.24 mt (24,770 lb)			
Boom Type		Reach HD		ME	
Stick Length		3.60 m HD (11'10")	4.67 m HD (15'4")	2.57 m (8'5")	3.0 m (9'10")
Hydraulic Hammers	H180 S	✓	✓	✓	✓
	H190 S	✓	✓	✓	✓
	H215 S	✓*		✓	✓
Multi-Processors	MP365 Concrete Cutter Jaw	✓	✓*	✓	✓
	MP365 Demolition Jaw	✓		✓	✓
	MP365 Pulverizer Jaw	✓		✓	✓
	MP365 Shear Jaw	✓	✓*	✓	✓
	MP365 Concrete Cutter Jaw-Flat Top				
	MP365 Demolition Jaw-Flat Top				
	MP365 Pulverizer Jaw-Flat Top				
	MP365 Shear Jaw-Flat Top				
Mobile Scrap and Demolition Shears	S3070 Flat Top			✓	✓
Pulverizers	P365 Primary Pulverizer	✓		✓	✓
	P365 Primary Pulverizer-Flat Top	✓*		✓	✓

BOOM-MOUNT ATTACHMENTS

Undercarriage		Long Variable Gauge	
Counterweight		11.24 mt (24,770 lb)	
Boom Type		Reach HD	ME
Mobile Scrap and Demolition Shears	S2090	✓	✓

374 Hydraulic Excavator Specifications

Attachments Offering Guide – Australia and New Zealand

Not all attachments are available in all regions. Consult your Cat dealer for configurations available in your region.

Match Working range front only No Match

PIN-ON ATTACHMENTS

Undercarriage		Long Variable Gauge			
Counterweight		11.24 mt (24,770 lb)			
Boom Type		Reach		Mass	
Stick Length		2.84 m (9'4")	3.60 m (11'10")	2.57 m (8'5")	3.0 m (9'10")
Hydraulic Hammers	H180 S	✓	✓	✓	✓
	H190 S	✓	✓	✓	✓
	H215 S	✓	✓	✓	✓
Mobile Scrap and Demolition Shears	S3070 Flat Top	✓	✓	✓	✓

CAT PIN GRABBER COUPLER ATTACHMENTS

Undercarriage		Long Variable Gauge	
Counterweight		11.24 mt (24,770 lb)	
Boom Type		Reach	
Stick Length		2.84 m (9'4")	3.60 m (11'10")
Hydraulic Hammers	H180 S	✓	✓
	H190 S	✓	✓
	H215 S	✓	✓*
Mobile Scrap and Demolition Shears	S3070 Flat Top	✓*	

374 Hydraulic Excavator Specifications

Attachments Offering Guide – South America

Not all attachments are available in all regions. Consult your Cat dealer for configurations available in your region.

Match

PIN-ON ATTACHMENTS

Undercarriage		Long Variable Gauge	
Counterweight		11.24 mt (24,770 lb)	
Boom Type		Mass	
Stick Length		2.57 m (8'5")	3.0 m (9'10")
Hydraulic Hammers	H180 S	✓	✓
	H190 S	✓	✓
	H215 S	✓	✓
Multi-Processors	MP365 Concrete Cutter Jaw	✓	✓
	MP365 Demolition Jaw	✓	✓
	MP365 Pulverizer Jaw	✓	✓
	MP365 Shear Jaw	✓	✓
Mobile Scrap and Demolition Shears	S3070 Flat Top	✓	✓
Pulverizers	P365 Primary Pulverizer	✓	✓

CW-70 DEDICATED COUPLER ATTACHMENTS

Undercarriage		Long Variable Gauge	
Counterweight		11.24 mt (24,770 lb)	
Boom Type		Mass	
Stick Length		2.57 m (8'5")	3.0 m (9'10")
Hydraulic Hammers	H180 S	✓	✓
	H190 S	✓	✓
	H215 S	✓	✓
Multi-Processors	MP365 Concrete Cutter Jaw	✓	✓
	MP365 Demolition Jaw	✓	✓
	MP365 Pulverizer Jaw	✓	✓
	MP365 Shear Jaw	✓	✓
Mobile Scrap and Demolition Shears	S3070 Flat Top	✓	✓
Pulverizers	P365 Primary Pulverizer	✓	✓
	P365 Primary Pulverizer-Flat Top	✓	✓

BOOM-MOUNT ATTACHMENTS

Undercarriage		Long Variable Gauge	
Counterweight		11.24 mt (24,770 lb)	
Boom Type		Mass	
Mobile Scrap and Demolition Shears	S2090	✓	

374 Hydraulic Excavator Specifications

Attachments Offering Guide – Southeast Asia, India, Indonesia

Not all attachments are available in all regions. Consult your Cat dealer for configurations available in your region.

Match

PIN-ON ATTACHMENTS

Undercarriage		Long Variable Gauge	
Counterweight		11.24 mt (24,770 lb)	
Boom Type		Reach	Mass
Stick Length		2.84 m (9'4")	2.57 m (8'5")
Hydraulic Hammers	H180 S	✓	✓
	H190 S	✓	✓
	H1215 S	✓	✓

374 Standard and Optional Equipment

Standard and Optional Equipment

Standard and optional equipment may vary. Consult your Cat dealer for details.

	Standard	Optional		Standard	Optional
BOOMS, STICKS AND LINKAGES			CAT TECHNOLOGY (continued)		
7.0 m (23") Mass boom		✓	Cat Assist:	✓	
7.8 m (25'7") Reach boom ¹		✓	– Grade Assist		
2.57 m (8'5") Mass stick ²		✓	– Boom Assist		
2.84 (9'4") Reach stick ³		✓	– Bucket Assist		
3.0 m (9'10") Mass stick ⁴		✓	– Swing Assist		
3.60 (11'10") Reach stick ⁵		✓	– Lift Assist		
4.67 (15'4") Reach stick ⁶		✓	Cat Payload:	✓	
Bucket Linkage, VB family with lifting eye, Cat Grade ⁷		✓	– Static weigh		
Bucket Linkage, VB family without lifting eye, Cat Grade ⁸		✓	– Semiautomatic calibration		
Bucket Linkage, WB family with lifting eye, Cat Grade ⁹		✓	– Payload/cycle information		
Bucket Linkage, WB family without lifting eye, Cat Grade		✓	– USB reporting capability		
CAT TECHNOLOGY			Work tool recognition (PL161)	✓	
VisionLink [®]	✓*		Work tool tracking (PL161)	✓	
VisionLink Productivity		✓	Cat Tilt Rotator (TRS) Integration		✓
Remote Flash	✓		ELECTRICAL SYSTEM		
Remote Troubleshoot	✓		Maintenance-free 1,400 CCA batteries (×2)	✓	
Operator Coaching	✓		Centralized electrical disconnect switch	✓	
Cat Grade Connectivity		✓	Chassis light	✓	
Compatibility with radios and base stations from Trimble, Topcon, and Leica	✓		LED boom and cab lights		✓
Capability to install 3D grade systems from Trimble, Topcon, and Leica	✓		Exterior lights (integrated into storage box)	✓	
Cat Grade 2D	✓		ENGINE		
Cat Grade 2D with Attachment Ready Option (ARO)		✓	Cold start block heater ¹²		✓
Cat Grade 3D single GNSS		✓	Three selectable modes: Power, Smart, Eco	✓	
Cat Grade 3D dual GNSS		✓	Automatic engine speed control	✓	
Laser catcher		✓	Up to 4500 m (14,764 ft) altitude capability	✓	
			52° C (126° F) high-ambient cooling capacity	✓	
			–18° C (0° F) cold start capability	✓	
			–32° C (–25° F) cold start capability		✓
			Hydraulic reverse fan	✓	
			Double element filter with integrated pre-cleaner air filter	✓	
			Three vertical side-by-side cooling system	✓	
			95 Amp alternator	✓	

(continued on next page)

¹All regions except South America

²All regions except Hong Kong and Taiwan

³Southeast Asia only

⁴All regions except Southeast Asia

⁵All regions except South America, Southeast Asia

⁶Africa, Middle East and Eurasia only

⁷Africa, Middle East and Southeast Asia only

⁸Hong Kong, Taiwan, Africa, Middle East, Eurasia, Southeast Asia only

⁹South America, Africa and Middle East only

¹⁰South America, Hong Kong and Taiwan only

¹¹Hong Kong and Taiwan only

¹²All regions except Southeast Asia, Hong Kong and Taiwan

Standard and Optional Equipment (continued)

Standard and optional equipment may vary. Consult your Cat dealer for details.

	Standard	Optional		Standard	Optional
HYDRAULIC SYSTEM			SERVICE AND MAINTENANCE		
Boom and stick regeneration circuit	✓		Integrated vehicle health management system	✓	
Electronic main control valve	✓		Auto lube ready	✓	
Auto heavy lift	✓		Grouped location for engine oil and fuel filters	✓	
Dedicated closed loop swing circuit	✓		Scheduled Oil Sampling (S·O·S SM) ports	✓	
Automatic hydraulic oil warmup	✓		QuickEvac™ maintenance ready		✓
Automatic swing parking brake	✓		Electric refueling pump with auto shutoff		✓
High performance hydraulic return filter	✓		UNDERCARRIAGE AND STRUCTURES		
Two speed travel	✓		Long variable gauge undercarriage	✓	
Bio hydraulic oil and filter	✓		Towing eye on base frame	✓	
Advanced tool control		✓	Three-piece segmented track guiding guards		✓
Medium-pressure auxiliary circuit		✓	Two-piece full-length track guiding guards		✓
Quick coupler circuit		✓	Swivel guard	✓	
Hydraulic efficiency monitoring		✓	Grease lubricated track	✓	
SAFETY AND SECURITY			Standard counterweight	✓	
Line of Sight/Non Line of Sight (LOS/NLOS) (remote control)	✓		650 mm (26") HD double grouser track shoes		✓
2D E-Fence:	✓		750 mm (30") HD double grouser track shoes ¹⁵		✓
– E-ceiling			900 mm (35") HD double grouser track shoes ¹⁶		✓
– E-floor			HD bottom guard	✓	
– E-swing			HD travel motor guard	✓	
– E-wall			*Connect subscription only. Additional subscriptions are available. Contact your Cat dealer for availability.		
– E-cab avoidance			**Requires PL161 attachment locator on work tool and Bluetooth® receiver on machine.		
Auto hammer stop	✓		¹³ All regions except Hong Kong and Taiwan		
Lockable external tool/storage box	✓		¹⁴ Hong Kong and Taiwan only		
Lockable door, fuel, and hydraulic tank locks	✓		¹⁵ All regions except Hong Kong and Taiwan		
Lockable fuel drain compartment	✓		¹⁶ South America and Eurasia only		
Service platforms with anti-skid plate	✓				
Lockable disconnect switch	✓				
Right-hand handrail and handhold	✓				
Standard visibility mirror package	✓				
Signaling/warning horn	✓				
Travel alarm		✓			
Swing alarm		✓			
Ground-level secondary engine shutoff switch	✓				
Rearview camera ¹³	✓				
Rear and right-hand-sideview cameras ¹⁴	✓				
360° visibility		✓			
Boom lowering check valve		✓			
Stick lowering check valve		✓			
Walkway	✓				
Tilt-up walkway		✓			
Inspection lighting		✓			

374 Dealer Installed Kits and Attachments

Dealer Installed Kits and Attachments

Attachments may vary. Consult your Cat dealer for details.

CAB

- Radial lower wiper
- Joystick with horizontal sliders
- Left Hand (LH)/Right Hand (RH) electrical pedal for tool control
- Dual exit rear window kit
- Front windshield laminated glass (P5A glass, EU demolition regulation)

ELECTRICAL

- 1,800 lumen LED premium surround lights

SAFETY AND SECURITY

- Bluetooth key fob
- 76 mm (3") retractable seat belt
- Cat Detect – People Detection
- Remote control LOS/NLOS

GUARDS

- OPG (not compatible with cab light cover, rain protector)
- Mesh guard full front (not compatible with cab light cover, rain protector)
- Mesh guard lower half front
- Full protecting vandalism guard
- Rain protector for front windshield plus cab light cover

OTHER ATTACHMENTS

- GNSS antennae

Cab Options

	Deluxe	Premium
Sound suppressed cab with viscous mounts	●	●
Cab/Operator Protective Guards (OPG)	○	○
High-resolution 203 mm (8") LCD touchscreen monitor	●	X
High-resolution 254 mm (10") LCD touchscreen monitor*	○	●
Additional high-resolution LCD touchscreen monitor for Cat Grade 2D and 3D	○	○
Automatic bi-level air conditioner	●	●
Jog dial and shortcut keys for monitor control	●	●
Keyless push-to-start engine control	●	●
Height-adjustable console, infinite with no tool	●	●
Tilt-up left-side console	●	●
Cat Stick Steer	○	○
Auxiliary relay	○	○
Heated seat with air-adjustable suspension	●	X
Heated and cooled seat with automatic adjustable suspension	X	●
51 mm (2") orange seat belt	●	●
Bluetooth integrated radio (including USB, auxiliary port and microphone)	●	●
2 × 12V DC outlets	●	●
Document storage	●	●
Rear head storage net and lunchbox storage net	●	●
Cup and bottle holders	●	●
Fixed one-piece windshield	X	○
Openable two-piece front window	●	○
Upper radial wiper with washer	●	X
Parallel wiper with washer	X	●
Openable polycarbonate skylight hatch	●	○
Fixed glass laminated skylight	X	○
LED dome light	●	●
Floor welcome light	●	●
Roller front sunscreen	●	●
Roller rear sunscreen	○	●
Rear window emergency exit	●	●
Washable floor mat	●	●
Beacon ready	●	●

● Standard

○ Optional

X Not available

*Only for use with 360° visibility on deluxe cab.

374 Environmental Declaration

The following information applies to the machine at the time of final manufacture as configured for sale in the regions covered in this document. The content of this declaration is valid as of the date issued; however, content related to machine features and specifications are subject to change without notice. For additional information, please see the machine's Operation and Maintenance Manual.

For more information on sustainability in action and our progress, please visit <https://www.caterpillar.com/en/company/sustainability>.

Engine

- The 374 meets Brazil MAR-1 emission standards, equivalent to U.S. EPA Tier 3 and EU Stage IIIA.
- Cat engines are compatible with diesel fuel blended with the following lower-carbon intensity fuels** up to:
 - ✓ 100% biodiesel FAME (fatty acid methyl ester)*
 - ✓ 100% renewable diesel, HVO (hydrotreated vegetable oil) and GTL (gas-to-liquid) fuelsRefer to guidelines for successful application. Please consult your Cat dealer or "Caterpillar Machine Fluids Recommendations" (SEBU6250) for details.
**For use of blends higher than 20% biodiesel, consult your Cat dealer.*
***Tailpipe greenhouse gas emissions from lower-carbon intensity fuels are essentially the same as traditional fuels.*

Air Conditioning System

- The air conditioning system on this machine contains the fluorinated greenhouse gas refrigerant R134a (Global Warming Potential = 1430). The system contains 1.0 kg (2.2 lb) of refrigerant which has a CO₂ equivalent of 1.430 metric tonnes (1.576 tons).

Paint

- Based on best available knowledge, the maximum allowable concentration, measured in parts per million (PPM), of the following heavy metals in paint are:
 - Barium < 0.01%
 - Cadmium < 0.01%
 - Chromium < 0.01%
 - Lead < 0.01%

Sound Performance

ISO 6395:2008 (external)	108 dB(A)
ISO 6396:2008 (inside cab)	73 dB(A)

- Hearing protection may be needed when operating with an open operator station and cab (when not properly maintained or doors/windows open) for extended periods or in a noisy environment.

Oils and Fluids

- Caterpillar factory fills with ethylene glycol coolants. Cat Diesel Engine Antifreeze/Coolant (DEAC) and Cat Extended Life Coolant (ELC) can be recycled. Consult your Cat dealer for more information.
- Cat Bio HYDO™ Advanced is an EU Ecolabel approved biodegradable hydraulic oil.
- Additional fluids are likely to be present, please consult the Operations and Maintenance Manual or the Application and Installation guide for complete fluid recommendations and maintenance intervals.

Features and Technology

- The following features and technology may contribute to fuel savings and/or carbon reduction. Features may vary. Consult your Cat dealer for details.
 - Advanced Hydraulic Systems Balance Power and Efficiency.
 - Smart Mode Matches Machine Power to Digging Requirements Automatically.
 - Eco Mode Minimizes Fuel Consumption for Light Application.
 - Remotely Monitor Fuel Consumption, Machine Health, Location, and Hours On-Demand through Product Link and VisionLink.
 - Cuts Maintenance Costs with Extended Service Intervals and Longer Life Fuel, Oil and Air Filters.



For more complete information on Cat products, dealer services, and industry solutions, visit us on the web at www.cat.com

© 2023 Caterpillar
All rights reserved

Materials and specifications are subject to change without notice. Featured machines in photos may include additional equipment. See your Cat dealer for available options.

CAT, CATERPILLAR, LET'S DO THE WORK, their respective logos, "Caterpillar Corporate Yellow," the "Power Edge" and Cat "Modern Hex" trade dress as well as corporate and product identity used herein, are trademarks of Caterpillar and may not be used without permission. VisionLink is a trademark of Caterpillar Inc., registered in the United States and in other countries.

AEXQ2897-06 (11-2023)
Replaces AEXQ2897-05
Build Number: 07D
(Aus-NZ, Afr-ME, Eurasia,
S Am, SE Asia, HK, Taiwan)

