



313 GC

Hydraulic Excavator

Technical Specifications

Configurations and features may vary by region. Please consult your Cat® dealer for availability in your area.

Table of Contents

Specifications	2
Engine	2
Swing Mechanism	2
Weights	2
Track	2
Drive	2
Air Conditioning System	2
Hydraulic System	2
Service Refill Capacities	2
Standards	2
Sound Performance	2
Operating Weights and Ground Pressures	3
Major Component Weights	4
Dimensions	5
Working Ranges and Forces	6
Blade Working Ranges	7
Reach Boom Lift Capacities	8
Reach Boom Lift Capacities – Blade Up	14
Bucket Specifications and Compatibility	20
Attachments Offering Guide	22
Thumb Specifications	24
Standard and Optional Equipment	25
Dealer Installed Kits and Attachments	27
313 GC Environmental Declaration	28

313 GC Hydraulic Excavator Specifications

Engine

Engine Model	Cat® C3.6	
Net Power		
ISO 9249	54.3 kW	73 hp
ISO 9249 (DIN)	74 hp (metric)	
Engine Power		
ISO 14396	55.4 kW	74 hp
ISO 14396 (DIN)	75 hp (metric)	
Bore	98 mm	4 in
Stroke	120 mm	5 in
Displacement	3.6 L	220 in ³
Biodiesel Capability	Up to B20 ⁽¹⁾	

- Meets U.S. EPA Tier 4 Final, EU Stage V, and Japan 2014 emission standards.
- No engine power derating required below 3000 m (9,840 ft) altitude.
- Advertised power is tested per the specified standard in effect at the time of manufacture.
- Net power advertised is the power available at the flywheel when the engine is equipped with fan, air intake system, exhaust system and alternator.
- Engine speed at 2,400 rpm.

⁽¹⁾Cat diesel engines are required to use ULSD (ultra-low sulfur diesel fuel with 15 ppm of sulfur or less) or ULSD blended with the following lower-carbon intensity fuels** up to:

- ✓ 20% biodiesel FAME (fatty acid methyl ester)*
- ✓ 100% renewable diesel, HVO (hydrogenated vegetable oil) and GTL (gas-to-liquid) fuels

Refer to guidelines for successful application. Please consult your Cat dealer or “Caterpillar Machine Fluids Recommendations” (SEBU6250) for details.

**Engines with no aftertreatment devices can use higher blends, up to 100% biodiesel (for use of blends higher than 20% biodiesel, consult your Cat dealer).*

***Tailpipe greenhouse gas emissions from lower-carbon intensity fuels are essentially the same as traditional fuels.*

Swing Mechanism

Swing Speed	11.5 rpm	
Maximum Swing Torque	35 kN·m	25,888 lbf·ft

Weights

Operating Weight	13 800 kg	30,400 lb
------------------	-----------	-----------

- Long undercarriage, Reach boom, R3.0 (9'10") stick, GD 0.53 m³ (0.69 yd³) bucket, 700 mm (28") triple grouser shoes and 2470 kg (5,445 lb) counterweight.

Track

Optional Track Shoes Width	700 mm	28 in
Optional Track Shoes Width	600 mm	24 in
Optional Track Shoes Width	500 mm	20 in
Number of Shoes (each side)	46	
Number of Track Rollers (each side)	7	
Number of Carrier Rollers (each side)	1	

Drive

Gradeability	35°/70%	
Maximum Travel Speed	5.4 km/h	3.4 mph
Maximum Drawbar Pull	117 kN	26,303 lbf

Air Conditioning System

The air conditioning system on this machine contains the fluorinated greenhouse gas refrigerant R134a (Global Warming Potential = 1430). The system contains 0.85 kg of refrigerant which has a CO₂ equivalent 1.216 metric tonne.

Hydraulic System

Main System – Maximum Flow – Implement	247 L/min	65 gal/min
Maximum Pressure – Equipment – Normal	35 000 kPa	5,075 psi
Maximum Pressure – Travel	35 000 kPa	5,075 psi
Maximum Pressure – Swing	26 000 kPa	3,770 psi
Boom Cylinder – Bore	105 mm	4 in
Boom Cylinder – Stroke	1026 mm	40 in
Stick Cylinder – Bore	115 mm	5 in
Stick Cylinder – Stroke	1147 mm	45 in
Bucket Cylinder – Bore	95 mm	4 in
Bucket Cylinder – Stroke	939 mm	37 in

Service Refill Capacities

Fuel Tank Capacity	258 L	68.2 gal
Cooling System	15 L	4.0 gal
Engine Oil	8 L	2.1 gal
Final Drive (each)	3 L	0.8 gal
Hydraulic System (including tank)	85 L	22.5 gal
Hydraulic Tank	70 L	18.5 gal

Standards

Brakes	ISO 10265:2008
Cab/Rollover Protective Structure (ROPS)	ISO 12117-2:2008
Cab	ISO 10262:1998 Level I
Operator Protective Guards (OPG) (optional)	ISO 10262:1998 Level II

Sound Performance

ISO 6395:2008 (external)	99 dB(A)
ISO 6396:2008 (inside cab)	68 dB(A)

- Hearing protection may be needed when operating with an open operator station and cab (when not properly maintained or doors/windows open) for extended periods or in a noisy environment.

313 GC Hydraulic Excavator Specifications

Operating Weights and Ground Pressures

Base Machine Configurations	500 mm (20") Triple Grouser Shoes		500 mm (20") TG Shoe with Rubber Pad		500 mm (20") Rubber Track Shoes	
	Weight	Ground Pressure	Weight	Ground Pressure	Weight	Ground Pressure
	kg (lb)	kPa (psi)	kg (lb)	kPa (psi)	kg (lb)	kPa (psi)
Base Frame with Track Rollers and Carrier Rollers						
2470 kg (5,445 lb) Counterweight and Long Undercarriage Base Machine						
Reach Boom + R3.0 (9'10") Stick + 0.53 m ³ (0.69 yd ³) GD Bucket	13 300 (29,300)	39.7 (5.8)	13 700 (30,200)	40.9 (5.9)	13 400 (29,500)	40.0 (5.8)
Reach Boom + R3.0 (9'10") Stick + 0.53 m ³ (0.69 yd ³) GD Bucket + Blade	14 000 (30,900)	41.7 (6.1)	14 400 (31,700)	42.9 (6.2)	14 200 (31,300)	42.3 (6.1)

All operating weights include a 90% fuel tank with 75 kg (165 lb) operator.

Base Machine Configurations	600 mm (24") Triple Grouser Shoes		600 mm (24") Rubber Track Shoes		700 mm (28") Triple Grouser Shoes	
	Weight	Ground Pressure	Weight	Ground Pressure	Weight	Ground Pressure
	kg (lb)	kPa (psi)	kg (lb)	kPa (psi)	kg (lb)	kPa (psi)
Base Frame with Track Rollers and Carrier Rollers						
2470 kg (5,445 lb) Counterweight and Long Undercarriage Base Machine						
Reach Boom + R3.0 (9'10") Stick + 0.53 m ³ (0.69 yd ³) GD Bucket	13 600 (30,000)	33.8 (4.9)	13 700 (30,200)	34.0 (4.9)	13 800 (30,400)	29.4 (4.3)
Reach Boom + R3.0 (9'10") Stick + 0.53 m ³ (0.69 yd ³) GD Bucket + Blade	14 300 (31,500)	35.5 (5.2)	14 500 (32,000)	36.0 (5.2)	14 600 (32,200)	31.1 (4.5)

All operating weights include a 90% fuel tank with 75 kg (165 lb) operator.

313 GC Hydraulic Excavator Specifications

Major Component Weights

	kg	lb
Base Machine Weight: including upper frame, undercarriage, counterweight, without boom, stick, bucket, boom cylinders, stick cylinder, bucket cylinders, tracks, blade, without 90% fuel tank, operator		
With Long Undercarriage	9080	20,000
With Long Undercarriage (blade compatible)	9390	20,700
Track Shoes:		
500 mm (20") Triple Grouser Track Shoes	1540	3,390
500 mm (20") Triple Grouser Track Shoes with Rubber Pad	1950	4,310
500 mm (20") Rubber Track Shoes	1670	3,680
600 mm (24") Triple Grouser Track Shoes	1810	4,000
600 mm (24") Rubber Track Shoes	1970	4,340
700 mm (28") Triple Grouser Track Shoes with Additional Steps	2020	4,440
Two Boom Cylinders	240	530
Weight of 90% Fuel Tank and 75 kg (165 lb) Operator	270	600
Blades (without lines, cylinders, frame modifications):		
2500 mm (8'2") Blade for use with 500 mm (20") Track Shoes	440	960
2600 mm (8'6") Blade for use with 600 mm (24") Track Shoes	490	1,080
2700 mm (8'10") Blade for use with 700 mm (28") Track Shoes	500	1,110
Counterweight:		
2470 kg (5,445 lb) Counterweight	2470	5,450
Swing Frame	1240	2,730
Undercarriages:		
Base Frame with GD Track Rollers and One Carrier Rollers	2620	5,770
Base Frame with GD Track Rollers and One Carrier Rollers (blade compatible)	2900	6,400
Boom (including lines, pins, stick cylinder):		
Reach Boom 4.65 m (15'3")	1030	2,270
Sticks (including lines, pins, bucket cylinder, bucket linkage):		
Reach Stick R2.8 (9'2")	650	1,420
Thumb Ready Stick 2.8 m (9'2")	720	1,590
Reach Stick R3.0 (9'10")	650	1,440
Buckets (without linkage, with tips and side cutters):		
0.53 m ³ (0.69 yd ³) GD Bucket	440	970
0.53 m ³ (0.69 yd ³) SD Bucket	500	1,100
0.65 m ³ (0.85 yd ³) GD Bucket	470	1,030
0.65 m ³ (0.85 yd ³) SD Bucket	540	1,200
0.76 m ³ (0.99 yd ³) GD Bucket	510	1,120
Two Bucket Pins	20	50
Quick Coupler:		
Pin Grabber Quick Coupler	210	470

313 GC Hydraulic Excavator Specifications

Dimensions

All dimensions are approximate and may vary depending on bucket selection.

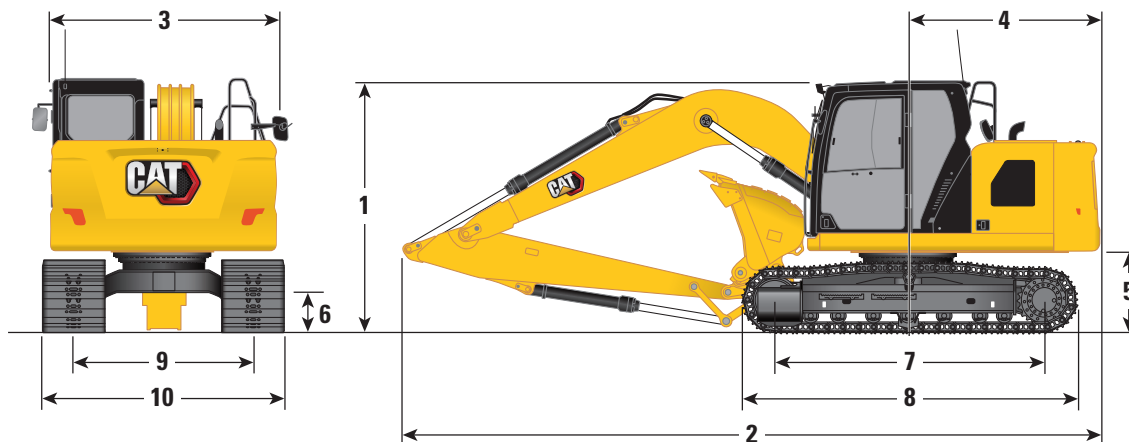

Boom Option

Reach Boom
4.65 m (15'3")

Stick Options

Thumb Ready/Reach Stick
R2.8 (9'2")

Reach Stick
R3.0 (9'10")

1 Machine Height:*

	Thumb Ready/Reach Stick R2.8 (9'2")	Reach Stick R3.0 (9'10")
Top of Cab Height	2810 mm	2810 mm
Top of OPG Height	2950 mm	2950 mm
Handrails Height	2810 mm	2810 mm
With Boom/Stick/Bucket Installed (with stick cylinder lines)	3070 mm	3190 mm
With Boom/Stick Installed (with stick cylinder lines)	3070 mm	3190 mm
With Boom Installed (with stick cylinder lines)	2370 mm	2370 mm

2 Machine Length (without blade):

With Boom/Stick/Bucket Installed (with stick cylinder lines)	7790 mm	7780 mm
With Boom/Stick Installed (with stick cylinder lines)	7790 mm	7780 mm
With Boom Installed (with stick cylinder lines)	6890 mm	6890 mm

Machine Length (with blade, blade rear):

With Boom/Stick/Bucket Installed (with stick cylinder lines)	8070 mm	8050 mm
With Boom/Stick Installed (with stick cylinder lines)	8070 mm	8050 mm
With Boom Installed (with stick cylinder lines)	7170 mm	7170 mm

3 Upperframe Width

	2480 mm	2480 mm
--	---------	---------

4 Tail Swing Radius – 2470 kg (5,445 lb) Counterweight

	2190 mm	2190 mm
--	---------	---------

5 Counterweight Clearance

	916 mm	916 mm
--	--------	--------

6 Ground Clearance

	446 mm	446 mm
--	--------	--------

7 Length to Center of Rollers

	3040 mm	3040 mm
--	---------	---------

8 Track Length

	3750 mm	3750 mm
--	---------	---------

9 Track Gauge

	1990 mm	1990 mm
--	---------	---------

10 Track Width/Undercarriage Width:

500 mm (20") Shoes	2490 mm	2490 mm
600 mm (24") Shoes	2590 mm	2590 mm
700 mm (28") Shoes (with steps)	2690 mm	2690 mm

Bucket Type

GD

GD

Bucket Capacity	0.65 m ³	0.85 yd ³	0.53 m ³	0.69 yd ³
Bucket Tip Radius	1240 mm	4'1"	1240 mm	4'1"

*For models with rubber track shoes or rubber pad add 40 mm (1.6") to machine height dimensions

313 GC Hydraulic Excavator Specifications

Working Ranges and Forces

All dimensions are approximate and may vary depending on bucket selection.

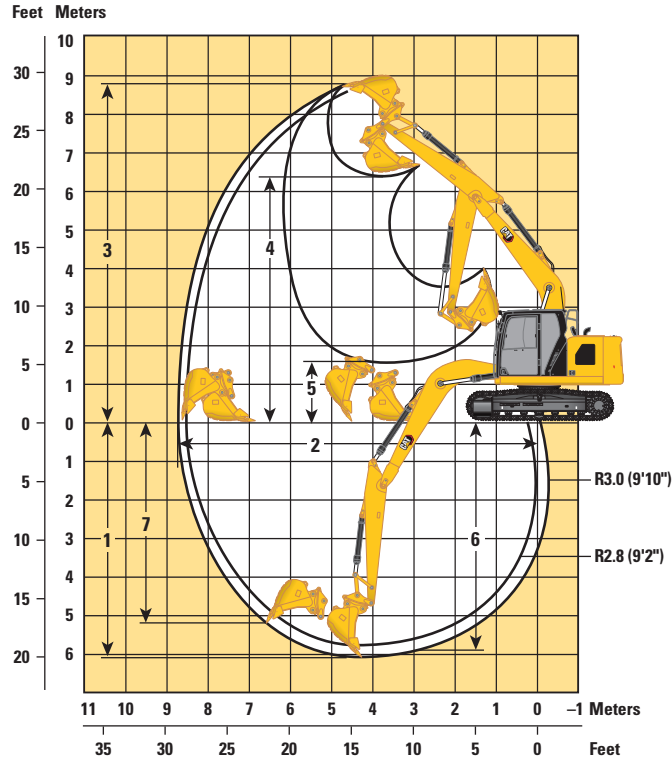

Boom Option

Reach Boom
4.65 m (15'3")

Stick Options

Thumb Ready/Reach Stick

Reach Stick

R2.8 (9'2")

R3.0 (9'10")

	Thumb Ready/Reach Stick		Reach Stick	
	R2.8 (9'2")		R3.0 (9'10")	
1 Maximum Digging Depth	5840 mm	19'2"	6040 mm	19'10"
2 Maximum Reach at Ground Line	8470 mm	27'9"	8660 mm	28'5"
3 Maximum Cutting Height	8710 mm	28'7"	8830 mm	29'0"
4 Maximum Loading Height	6300 mm	20'8"	6420 mm	21'1"
5 Minimum Loading Height	1800 mm	5'11"	1600 mm	5'3"
6 Maximum Depth Cut for 2440 mm (8'0") Level Bottom	5650 mm	18'6"	5860 mm	19'3"
7 Maximum Vertical Wall Digging Depth	5000 mm	16'5"	5190 mm	17'0"
Minimum Working Equipment Radius	2540 mm	8'4"	2570 mm	8'5"
Bucket Digging Force (ISO)	98.67 kN	22,180 lbf	98.67 kN	22,180 lbf
Stick Digging Force (ISO)	62.34 kN	14,010 lbf	59.29 kN	13,330 lbf
Bucket Type	GD		GD	
Bucket Capacity	0.65 m ³	0.85 yd ³	0.53 m ³	0.69 yd ³
Bucket Tip Radius	1240 mm	4'1"	1240 mm	4'1"

313 GC Hydraulic Excavator Specifications

Blade Working Ranges

All dimensions are approximate and may vary depending on bucket selection.

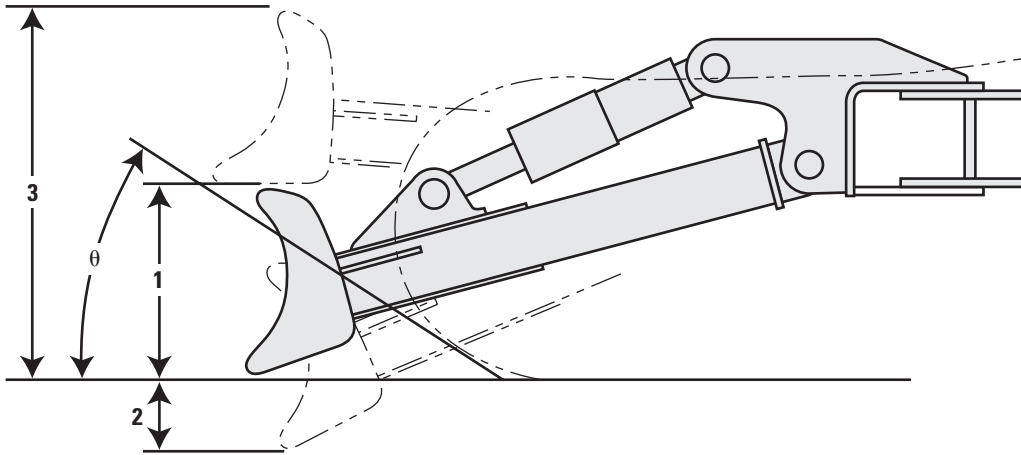

Blade Options	2500 mm (8'2")		2600 mm (8'6")		2700 mm (8'10")	
	1 Blade Height	616 mm	2'0"	616 mm	2'0"	616 mm
2 Maximum Lowering Depth from Ground	550 mm	1'10"	550 mm	1'10"	550 mm	1'10"
3 Maximum Raising Height above Ground	1018 mm	3'4"	1018 mm	3'4"	1018 mm	3'4"
θ Approach Angle	26°		26°		26°	

313 GC Hydraulic Excavator Specifications

Reach Boom Lift Capacities – Counterweight: 2470 kg (5,445 lb) – without Bucket

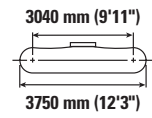
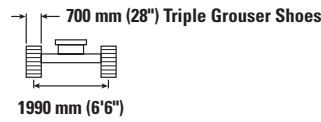
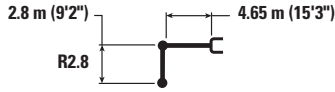

Reach (m/ft)	Unit	1.5 m/5.0 ft		3.0 m/10.0 ft		4.5 m/15.0 ft		6.0 m/20.0 ft		Diagram		m ft/in
7.5 m 25.0 ft	kg lb									*2900	*2900	4.16
6.0 m 20.0 ft	kg lb									*2400 *5,250	*2400 *5,250	5.79 18'8"
4.5 m 15.0 ft	kg lb					*3500 *7,650	*3500 *7,650	*3500 *7,550	2550 5,400	*2250 *4,900	2100 4,600	6.71 21'10"
3.0 m 10.0 ft	kg lb			*5750 *12,350	*5750 *12,350	*4350 *9,450	3800 8,150	3750 8,100	2450 5,250	*2250 *4,900	1800 4,000	7.21 23'7"
1.5 m 5.0 ft	kg lb			*8550 *18,400	6400 13,750	*5450 *11,750	3550 7,600	3650 7,800	2350 5,000	*2350 *5,150	1700 3,750	7.36 24'1"
0 m 0 ft	kg lb			*6950 *16,050	6000 12,850	5450 11,700	3350 7,150	3550 7,600	2250 4,800	*2600 *5,750	1750 3,800	7.20 23'7"
-1.5 m -5.0 ft	kg lb	*4500 *10,100	*4500 *10,100	*9450 *21,000	5900 12,650	5350 11,450	3250 6,950	3500 7,500	2200 4,700	3000 6,600	1900 4,150	6.71 21'11"
-3.0 m -10.0 ft	kg lb	*8000 *18,000	*8000 *18,000	*8600 *18,500	5950 12,800	5350 11,500	3250 7,000			3700 8,250	2350 5,150	5.78 18'9"
-4.5 m -15.0 ft	kg lb			*5900 *5900						*4050 *10,050	3850 9,900	4.13 12'1"

Reach Boom Lift Capacities – Counterweight: 2470 kg (5,445 lb) – without Bucket

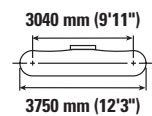
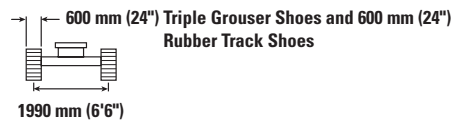
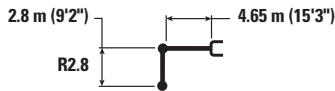

Reach (m/ft)	Unit	1.5 m/5.0 ft		3.0 m/10.0 ft		4.5 m/15.0 ft		6.0 m/20.0 ft		Diagram		m ft/in
7.5 m 25.0 ft	kg lb									*2900	*2900	4.16
6.0 m 20.0 ft	kg lb									*2400 *5,250	*2400 *5,250	5.79 18'8"
4.5 m 15.0 ft	kg lb					*3500 *7,650	*3500 *7,650	*3500 *7,550	2500 5,350	*2250 *4,900	2050 4,550	6.71 21'10"
3.0 m 10.0 ft	kg lb			*5750 *12,350	*5750 *12,350	*4350 *9,450	3750 8,050	3700 8,000	2400 5,200	*2250 *4,900	1800 3,950	7.21 23'7"
1.5 m 5.0 ft	kg lb			*8550 *18,400	6300 13,550	*5450 *11,750	3500 7,500	3600 7,700	2300 4,950	*2350 *5,150	1700 3,700	7.36 24'1"
0 m 0 ft	kg lb			*6950 *16,050	5900 12,650	5350 11,550	3300 7,050	3500 7,500	2200 4,700	*2600 *5,750	1700 3,750	7.20 23'7"
-1.5 m -5.0 ft	kg lb	*4500 *10,100	*4500 *10,100	*9450 *21,000	5800 12,450	5250 11,300	3200 6,850	3450 7,350	2150 4,600	2950 6,500	1850 4,100	6.71 21'11"
-3.0 m -10.0 ft	kg lb	*8000 *18,000	*8000 *18,000	*8600 *18,500	5900 12,600	5300 11,350	3200 6,900			3650 8,150	2300 5,100	5.78 18'9"
-4.5 m -15.0 ft	kg lb			*5900 *5900						*4050 *10,050	3800 9,800	4.13 12'1"



ISO 10567:2007



* Indicates that the load is limited by hydraulic lifting capacity rather than tipping load. The above loads are in compliance with hydraulic excavator lift capacity standard ISO 10567:2007. They do not exceed 87% of hydraulic lifting capacity or 75% of tipping load. Weight of all lifting accessories must be deducted from the above lifting capacities. Lifting capacities are based on the machine standing on a firm, uniform supporting surface. The use of a work tool attachment point to handle/lift objects, could affect the machine lift performance.

Lift capacity stays with ±5% for all available track shoes.

Always refer to the appropriate Operation and Maintenance Manual for specific product information.

313 GC Hydraulic Excavator Specifications

Reach Boom Lift Capacities – Counterweight: 2470 kg (5,445 lb) – without Bucket

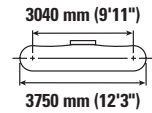
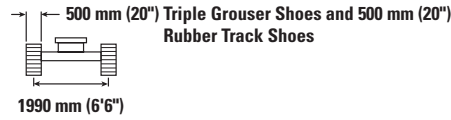
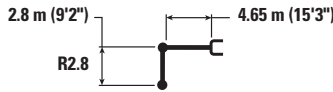

Reach m ft/in	kg lb	1.5 m/5.0 ft		3.0 m/10.0 ft		4.5 m/15.0 ft		6.0 m/20.0 ft		m ft/in		
7.5 m 25.0 ft	kg lb									*2900	*2900	4.16
6.0 m 20.0 ft	kg lb									*2400 *5,250	*2400 *5,250	5.79 18'8"
4.5 m 15.0 ft	kg lb					*3500 *7,650	*3500 *7,650	*3500 *7,550	2450 5,250	*2250 *4,900	2000 4,450	6.71 21'10"
3.0 m 10.0 ft	kg lb			*5750 *12,350	*5750 *12,350	*4350 *9,450	3700 7,950	3650 7,850	2350 5,100	*2250 *4,900	1750 3,850	7.21 23'7"
1.5 m 5.0 ft	kg lb			*8550 *18,400	6200 13,300	*5450 *11,750	3400 7,350	3550 7,550	2250 4,850	*2350 *5,150	1650 3,600	7.36 24'1"
0 m 0 ft	kg lb			*6950 *16,050	5800 12,400	5250 11,300	3200 6,900	3400 7,350	2150 4,650	*2600 *5,750	1650 3,650	7.20 23'7"
-1.5 m -5.0 ft	kg lb	*4500 *10,100	*4500 *10,100	*9450 *21,000	5700 12,200	5150 11,050	3100 6,700	3350 7,200	2100 4,550	2900 6,350	1850 4,000	6.71 21'11"
-3.0 m -10.0 ft	kg lb	*8000 *18,000	*8000 *18,000	*8600 *18,500	5750 12,350	5200 11,100	3150 6,750			3600 7,950	2250 5,000	5.78 18'9"
-4.5 m -15.0 ft	kg lb			*5900 *5900						*4050 *10,050	3750 9,600	4.13 12'1"

Reach Boom Lift Capacities – Counterweight: 2470 kg (5,445 lb) – without Bucket

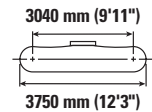
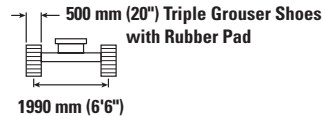
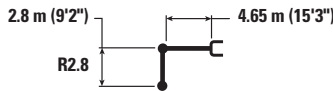

Reach m ft/in	kg lb	1.5 m/5.0 ft		3.0 m/10.0 ft		4.5 m/15.0 ft		6.0 m/20.0 ft		m ft/in		
7.5 m 25.0 ft	kg lb									*2900	*2900	4.16
6.0 m 20.0 ft	kg lb									*2400 *5,250	*2400 *5,250	5.79 18'8"
4.5 m 15.0 ft	kg lb					*3500 *7,650	*3500 *7,650	*3500 *7,550	2500 5,400	*2250 *4,900	2100 4,600	6.71 21'10"
3.0 m 10.0 ft	kg lb			*5750 *12,350	*5750 *12,350	*4350 *9,450	3800 8,150	3750 8,050	2450 5,200	*2250 *4,900	1800 4,000	7.21 23'7"
1.5 m 5.0 ft	kg lb			*8550 *18,400	6350 13,650	*5450 *11,750	3500 7,550	3650 7,800	2300 5,000	*2350 *5,150	1700 3,750	7.36 24'1"
0 m 0 ft	kg lb			*6950 *16,050	5950 12,750	5450 11,650	3300 7,100	3500 7,550	2250 4,750	*2600 *5,750	1700 3,750	7.20 23'7"
-1.5 m -5.0 ft	kg lb	*4500 *10,100	*4500 *10,100	*9450 *21,000	5850 12,600	5300 11,400	3200 6,900	3450 7,450	2200 4,650	3000 6,550	1900 4,150	6.71 21'11"
-3.0 m -10.0 ft	kg lb	*8000 *18,000	*8000 *18,000	*8600 *18,500	5950 12,750	5350 11,450	3250 6,950			3700 8,200	2350 5,150	5.78 18'9"
-4.5 m -15.0 ft	kg lb			*5900 *5900						*4050 *10,050	3850 9,900	4.13 12'1"



ISO 10567:2007



* Indicates that the load is limited by hydraulic lifting capacity rather than tipping load. The above loads are in compliance with hydraulic excavator lift capacity standard ISO 10567:2007. They do not exceed 87% of hydraulic lifting capacity or 75% of tipping load. Weight of all lifting accessories must be deducted from the above lifting capacities. Lifting capacities are based on the machine standing on a firm, uniform supporting surface. The use of a work tool attachment point to handle/lift objects, could affect the machine lift performance.









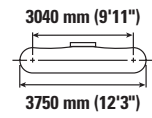
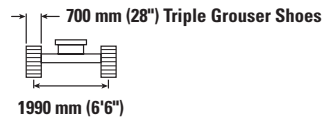
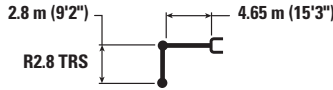

Lift capacity stays with ±5% for all available track shoes.

Always refer to the appropriate Operation and Maintenance Manual for specific product information.

313 GC Hydraulic Excavator Specifications









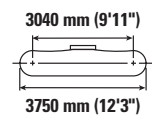
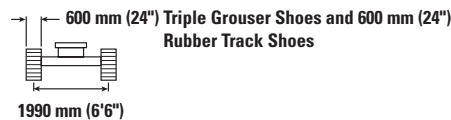

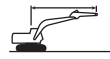
Reach Boom Lift Capacities – Counterweight: 2470 kg (5,445 lb) – without Bucket



		1.5 m/5.0 ft		3.0 m/10.0 ft		4.5 m/15.0 ft		6.0 m/20.0 ft				m ft/in
												
7.5 m 25.0 ft	kg lb									*2850	*2850	4.16
6.0 m 20.0 ft	kg lb									*2350 *5,200	*2350 *5,200	5.79 18'8"
4.5 m 15.0 ft	kg lb					*3500 *7,550	*3500 *7,550	*3450 *7,500	2550 5,400	*2200 *4,850	2100 4,600	6.71 21'10"
3.0 m 10.0 ft	kg lb			*5700 *12,200	*5700 *12,200	*4300 *9,350	3800 8,200	*3750 8,100	2450 5,250	*2200 *4,850	1800 4,000	7.21 23'7"
1.5 m 5.0 ft	kg lb			*8500 *18,250	6400 13,800	*5400 *11,600	3550 7,600	3650 7,850	2350 5,000	*2350 *5,100	1700 3,750	7.36 24'1"
0 m 0 ft	kg lb			*6900 *16,000	6000 12,850	5450 11,700	3350 7,150	3550 7,600	2250 4,750	*2600 *5,650	1700 3,750	7.20 23'7"
-1.5 m -5.0 ft	kg lb	*4500 *10,050	*4500 *10,050	*9400 *20,850	5900 12,650	5350 11,500	3250 6,950	3500 7,500	2200 4,650	3000 6,550	1900 4,150	6.71 21'11"
-3.0 m -10.0 ft	kg lb	*7950 *17,950	*7950 *17,950	*8500 *18,350	6000 12,850	5400 11,550	3250 7,000			3700 8,250	2350 5,150	5.78 18'9"
-4.5 m -15.0 ft	kg lb			*5850 *5850	*5850					*4000 *9,900	3900 *9,900	4.13 12'1"

Reach Boom Lift Capacities – Counterweight: 2470 kg (5,445 lb) – without Bucket



		1.5 m/5.0 ft		3.0 m/10.0 ft		4.5 m/15.0 ft		6.0 m/20.0 ft				m ft/in
												
7.5 m 25.0 ft	kg lb									*2850	*2850	4.16
6.0 m 20.0 ft	kg lb									*2350 *5,200	*2350 *5,200	5.79 18'8"
4.5 m 15.0 ft	kg lb					*3500 *7,550	*3500 *7,550	*3450 *7,500	2500 5,350	*2200 *4,850	2050 4,550	6.71 21'10"
3.0 m 10.0 ft	kg lb			*5700 *12,200	*5700 *12,200	*4300 *9,350	3750 8,100	3750 8,000	2400 5,150	*2200 *4,850	1800 3,900	7.21 23'7"
1.5 m 5.0 ft	kg lb			*8500 *18,250	6350 13,600	*5400 *11,600	3500 7,500	3600 7,700	2300 4,900	*2350 *5,100	1700 3,650	7.36 24'1"
0 m 0 ft	kg lb			*6900 *16,000	5900 12,700	5400 11,550	3300 7,050	3500 7,500	2200 4,700	*2600 *5,650	1700 3,700	7.20 23'7"
-1.5 m -5.0 ft	kg lb	*4500 *10,050	*4500 *10,050	*9400 *20,850	5800 12,500	5300 11,300	3200 6,850	3450 7,350	2150 4,600	2950 6,450	1850 4,050	6.71 21'11"
-3.0 m -10.0 ft	kg lb	*7950 *17,950	*7950 *17,950	*8500 *18,350	5900 12,650	5300 11,400	3200 6,900			3650 8,150	2300 5,100	5.78 18'9"
-4.5 m -15.0 ft	kg lb			*5850 *5850	*5850					*4000 *9,900	3850 9,850	4.13 12'1"



ISO 10567:2007



* Indicates that the load is limited by hydraulic lifting capacity rather than tipping load. The above loads are in compliance with hydraulic excavator lift capacity standard ISO 10567:2007. They do not exceed 87% of hydraulic lifting capacity or 75% of tipping load. Weight of all lifting accessories must be deducted from the above lifting capacities. Lifting capacities are based on the machine standing on a firm, uniform supporting surface. The use of a work tool attachment point to handle/lift objects, could affect the machine lift performance.

Lift capacity stays with ±5% for all available track shoes.

Always refer to the appropriate Operation and Maintenance Manual for specific product information.

313 GC Hydraulic Excavator Specifications

Reach Boom Lift Capacities – Counterweight: 2470 kg (5,445 lb) – without Bucket

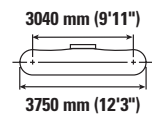
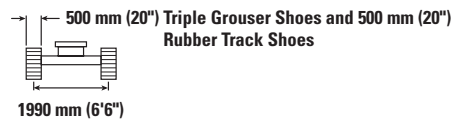
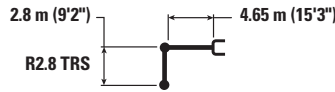

Reach	Unit	1.5 m/5.0 ft		3.0 m/10.0 ft		4.5 m/15.0 ft		6.0 m/20.0 ft		m ft/in		
		kg lb	kg lb	kg lb	kg lb	kg lb	kg lb	kg lb	kg lb	kg lb	kg lb	
7.5 m 25.0 ft	kg lb									*2850	*2850	4.16
6.0 m 20.0 ft	kg lb									*2350 *5,200	*2350 *5,200	5.79 18'8"
4.5 m 15.0 ft	kg lb					*3500 *7,550	*3500 *7,550	*3450 *7,500	2450 5,250	*2200 *4,850	2000 4,450	6.71 21'10"
3.0 m 10.0 ft	kg lb			*5700 *12,200	*5700 *12,200	*4300 *9,350	3700 7,950	3650 7,850	2350 5,100	*2200 *4,850	1750 3,850	7.21 23'7"
1.5 m 5.0 ft	kg lb			*8500 *18,250	6200 13,350	*5400 *11,600	3450 7,350	3550 7,550	2250 4,850	*2350 *5,100	1650 3,600	7.36 24'1"
0 m 0 ft	kg lb			*6900 *16,000	5800 12,450	5300 11,350	3200 6,900	3400 7,350	2150 4,600	*2600 *5,650	1650 3,650	7.20 23'7"
-1.5 m -5.0 ft	kg lb	*4500 *10,050	*4500 *10,050	*9400 *20,850	5700 12,250	5150 11,100	3100 6,700	3350 7,200	2100 4,500	2900 6,350	1800 4,000	6.71 21'11"
-3.0 m -10.0 ft	kg lb	*7950 *17,950	*7950 *17,950	*8500 *18,350	5800 12,400	5200 11,150	3150 6,750			3600 8,000	2250 5,000	5.78 18'9"
-4.5 m -15.0 ft	kg lb			*5850 *5850						*4000 *9,900	3750 9,650	4.13 12'1"

Reach Boom Lift Capacities – Counterweight: 2470 kg (5,445 lb) – without Bucket

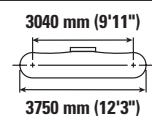
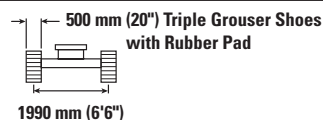

Reach	Unit	1.5 m/5.0 ft		3.0 m/10.0 ft		4.5 m/15.0 ft		6.0 m/20.0 ft		m ft/in		
		kg lb	kg lb	kg lb	kg lb	kg lb	kg lb	kg lb	kg lb	kg lb	kg lb	
7.5 m 25.0 ft	kg lb									*2850	*2850	4.16
6.0 m 20.0 ft	kg lb									*2350 *5,200	*2350 *5,200	5.79 18'8"
4.5 m 15.0 ft	kg lb					*3500 *7,550	*3500 *7,550	*3450 *7,500	2500 5,400	*2200 *4,850	2050 4,600	6.71 21'10"
3.0 m 10.0 ft	kg lb			*5700 *12,200	*5700 *12,200	*4300 *9,350	3800 8,150	*3750 8,100	2450 5,200	*2200 *4,850	1800 3,950	7.21 23'7"
1.5 m 5.0 ft	kg lb			*8500 *18,250	6400 13,750	*5400 *11,600	3500 7,550	3650 7,800	2300 4,950	*2350 *5,100	1700 3,700	7.36 24'1"
0 m 0 ft	kg lb			*6900 *16,000	5950 12,800	5450 11,700	3300 7,100	3500 7,550	2200 4,750	*2600 *5,650	1700 3,750	7.20 23'7"
-1.5 m -5.0 ft	kg lb	*4500 *10,050	*4500 *10,050	*9400 *20,850	5900 12,600	5350 11,450	3200 6,900	3450 7,450	2150 4,650	2950 6,550	1900 4,100	6.71 21'11"
-3.0 m -10.0 ft	kg lb	*7950 *17,950	*7950 *17,950	*8500 *18,350	5950 12,800	5350 11,500	3250 6,950			3700 8,250	2300 5,150	5.78 18'9"
-4.5 m -15.0 ft	kg lb			*5850 *5850						*4000 *9,900	3850 *9,900	4.13 12'1"



ISO 10567:2007



* Indicates that the load is limited by hydraulic lifting capacity rather than tipping load. The above loads are in compliance with hydraulic excavator lift capacity standard ISO 10567:2007. They do not exceed 87% of hydraulic lifting capacity or 75% of tipping load. Weight of all lifting accessories must be deducted from the above lifting capacities. Lifting capacities are based on the machine standing on a firm, uniform supporting surface. The use of a work tool attachment point to handle/lift objects, could affect the machine lift performance.

Lift capacity stays with ±5% for all available track shoes.

Always refer to the appropriate Operation and Maintenance Manual for specific product information.

313 GC Hydraulic Excavator Specifications

Reach Boom Lift Capacities – Counterweight: 2470 kg (5,445 lb) – without Bucket

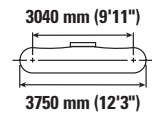
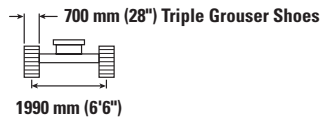
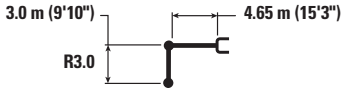

		1.5 m/5.0 ft		3.0 m/10.0 ft		4.5 m/15.0 ft		6.0 m/20.0 ft		7.5 m/25.0 ft		m ft/in		
7.5 m 25.0 ft	kg lb											*2600 *5,850	*2600 *5,850	4.49 14'1"
6.0 m 20.0 ft	kg lb							*2250	*2250			*2200 *4,850	*2200 *4,850	6.03 19'6"
4.5 m 15.0 ft	kg lb							*3350 *7,300	2550 5,450			*2050 *4,500	2000 4,400	6.92 22'6"
3.0 m 10.0 ft	kg lb			*5350 *11,450	*5350 *11,450	*4200 *9,050	3850 8,250	*3700 *8,000	2450 5,300			*2050 *4,500	1750 3,850	7.40 24'2"
1.5 m 5.0 ft	kg lb			*8200 *17,650	6450 13,900	*5300 *11,400	3550 7,650	3650 7,850	2350 5,050	*2400	1650	*2150 *4,750	1650 3,600	7.55 24'9"
0 m 0 ft	kg lb			*7250 *16,750	6000 12,900	5450 11,750	3350 7,150	3550 7,600	2250 4,800			*2400 *5,250	1650 3,650	7.40 24'3"
-1.5 m -5.0 ft	kg lb	*4350 *9,700	*4350 *9,700	*9200 *21,000	5900 12,600	5350 11,450	3250 6,950	3500 7,450	2200 4,700			*2850 *6,250	1800 3,950	6.91 22'7"
-3.0 m -10.0 ft	kg lb	*7450 *16,800	*7450 *16,800	*8800 *19,050	5950 12,750	5350 11,450	3250 6,950	3500	2200			3500 7,750	2200 4,850	6.02 19'7"
-4.5 m -15.0 ft	kg lb			*6400 *13,550	6150 13,250							*4000 *8,800	3400 7,750	4.48 14'4"

Reach Boom Lift Capacities – Counterweight: 2470 kg (5,445 lb) – without Bucket

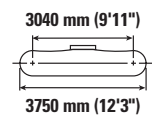
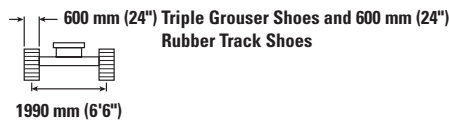
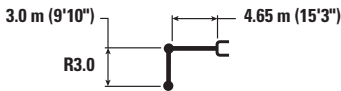

		1.5 m/5.0 ft		3.0 m/10.0 ft		4.5 m/15.0 ft		6.0 m/20.0 ft		7.5 m/25.0 ft		m ft/in		
7.5 m 25.0 ft	kg lb											*2600 *5,850	*2600 *5,850	4.49 14'1"
6.0 m 20.0 ft	kg lb							*2250	*2250			*2200 *4,850	*2200 *4,850	6.03 19'6"
4.5 m 15.0 ft	kg lb							*3350 *7,300	2500 5,400			*2050 *4,500	1950 4,350	6.92 22'6"
3.0 m 10.0 ft	kg lb			*5350 *11,450	*5350 *11,450	*4200 *9,050	3800 8,150	*3700 *8,000	2450 5,200			*2050 *4,500	1700 3,800	7.40 24'2"
1.5 m 5.0 ft	kg lb			*8200 *17,650	6400 13,750	*5300 *11,400	3500 7,550	3600 7,750	2300 4,950	*2400	1650	*2150 *4,750	1650 3,550	7.55 24'9"
0 m 0 ft	kg lb			*7250 *16,750	5900 12,700	5400 11,500	3300 7,050	3500 7,500	2200 4,750			*2400 *5,250	1650 3,600	7.40 24'3"
-1.5 m -5.0 ft	kg lb	*4350 *9,700	*4350 *9,700	*9200 *21,000	5800 12,450	5250 11,300	3200 6,850	3450 7,350	2150 4,600			2800 6,200	1800 3,900	6.91 22'7"
-3.0 m -10.0 ft	kg lb	*7450 *16,800	*7450 *16,800	*8800 *19,050	5850 12,550	5250 11,300	3200 6,850	3450	2200			3450 7,650	2150 4,800	6.02 19'7"
-4.5 m -15.0 ft	kg lb			*6400 *13,550	6050 13,050							*4000 *8,800	3350 7,650	4.48 14'4"



ISO 10567:2007



* Indicates that the load is limited by hydraulic lifting capacity rather than tipping load. The above loads are in compliance with hydraulic excavator lift capacity standard ISO 10567:2007. They do not exceed 87% of hydraulic lifting capacity or 75% of tipping load. Weight of all lifting accessories must be deducted from the above lifting capacities. Lifting capacities are based on the machine standing on a firm, uniform supporting surface. The use of a work tool attachment point to handle/lift objects, could affect the machine lift performance.

Lift capacity stays with ±5% for all available track shoes.

Always refer to the appropriate Operation and Maintenance Manual for specific product information.

313 GC Hydraulic Excavator Specifications

Reach Boom Lift Capacities – Counterweight: 2470 kg (5,445 lb) – without Bucket

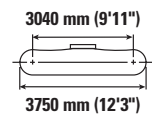
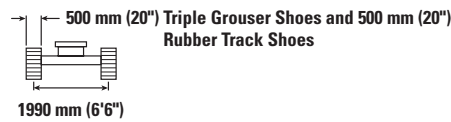
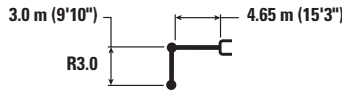

		1.5 m/5.0 ft		3.0 m/10.0 ft		4.5 m/15.0 ft		6.0 m/20.0 ft		7.5 m/25.0 ft		m ft/in		
7.5 m 25.0 ft	kg lb											*2600 *5,850	*2600 *5,850	4.49 14'1"
6.0 m 20.0 ft	kg lb							*2250	*2250			*2200 *4,850	*2200 *4,850	6.03 19'6"
4.5 m 15.0 ft	kg lb							*3350 *7,300	2500 5,300			*2050 *4,500	1950 4,250	6.92 22'6"
3.0 m 10.0 ft	kg lb			*5350 *11,450	*5350 *11,450	*4200 *9,050	3700 8,000	3650 7,850	2400 5,100			*2050 *4,500	1700 3,700	7.40 24'2"
1.5 m 5.0 ft	kg lb			*8200 *17,650	6250 13,500	*5300 *11,400	3450 7,400	3550 7,600	2250 4,850	*2400	1600	*2150 *4,750	1600 3,500	7.55 24'9"
0 m 0 ft	kg lb			*7250 *16,750	5800 12,450	5300 11,350	3250 6,950	3400 7,350	2150 4,650			*2400 *5,250	1600 3,500	7.40 24'3"
-1.5 m -5.0 ft	kg lb	*4350 *9,700	*4350 *9,700	*9200 *21,000	5700 12,200	5150 11,050	3100 6,700	3350 7,200	2100 4,500			2750 6,050	1750 3,850	6.91 22'7"
-3.0 m -10.0 ft	kg lb	*7450 *16,800	*7450 *16,800	*8800 *19,050	5750 12,300	5150 11,100	3100 6,700	3400	2150			3350 7,500	2100 4,700	6.02 19'7"
-4.5 m -15.0 ft	kg lb			*6400 *13,550	5950 12,800							*4000 *8,800	3300 7,500	4.48 14'4"

Reach Boom Lift Capacities – Counterweight: 2470 kg (5,445 lb) – without Bucket

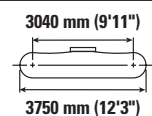
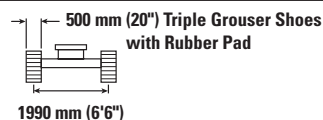
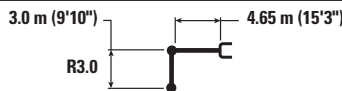

		1.5 m/5.0 ft		3.0 m/10.0 ft		4.5 m/15.0 ft		6.0 m/20.0 ft		7.5 m/25.0 ft		m ft/in		
7.5 m 25.0 ft	kg lb											*2600 *5,850	*2600 *5,850	4.49 14'1"
6.0 m 20.0 ft	kg lb							*2250	*2250			*2200 *4,850	*2200 *4,850	6.03 19'6"
4.5 m 15.0 ft	kg lb							*3350 *7,300	2550 5,450			*2050 *4,500	2000 4,400	6.92 22'6"
3.0 m 10.0 ft	kg lb			*5350 *11,450	*5350 *11,450	*4200 *9,050	3800 8,200	*3700 *8,000	2450 5,250			*2050 *4,500	1750 3,800	7.40 24'2"
1.5 m 5.0 ft	kg lb			*8200 *17,650	6450 13,850	*5300 *11,400	3550 7,600	3650 7,800	2350 5,000	*2400	1650	*2150 *4,750	1650 3,600	7.55 24'9"
0 m 0 ft	kg lb			*7250 *16,750	6000 12,850	5450 11,700	3300 7,150	3550 7,550	2250 4,800			*2400 *5,250	1650 3,600	7.40 24'3"
-1.5 m -5.0 ft	kg lb	*4350 *9,700	*4350 *9,700	*9200 *21,000	5850 12,550	5300 11,400	3200 6,900	3450 7,450	2150 4,650			*2850 *6,250	1800 3,950	6.91 22'7"
-3.0 m -10.0 ft	kg lb	*7450 *16,800	*7450 *16,800	*8800 *19,050	5900 12,700	5300 11,400	3200 6,900	3500	2200			3500 7,700	2200 4,850	6.02 19'7"
-4.5 m -15.0 ft	kg lb			*6400 *13,550	6150 13,200							*4000 *8,800	3400 7,750	4.48 14'4"



ISO 10567:2007



* Indicates that the load is limited by hydraulic lifting capacity rather than tipping load. The above loads are in compliance with hydraulic excavator lift capacity standard ISO 10567:2007. They do not exceed 87% of hydraulic lifting capacity or 75% of tipping load. Weight of all lifting accessories must be deducted from the above lifting capacities. Lifting capacities are based on the machine standing on a firm, uniform supporting surface. The use of a work tool attachment point to handle/lift objects, could affect the machine lift performance.

Lift capacity stays with ±5% for all available track shoes.

Always refer to the appropriate Operation and Maintenance Manual for specific product information.

313 GC Hydraulic Excavator Specifications

Reach Boom Lift Capacities – Counterweight: 2470 kg (5,445 lb) – without Bucket – Blade Up

2700 mm (8'10") Blade

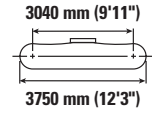
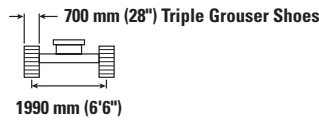
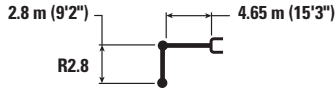

Reach Boom Length	Unit	1.5 m/5.0 ft		3.0 m/10.0 ft		4.5 m/15.0 ft		6.0 m/20.0 ft		Blade		m ft/in
		kg lb	kg lb	kg lb	kg lb	kg lb	kg lb	kg lb	kg lb	kg lb	kg lb	
7.5 m 25.0 ft	kg lb									*2900	*2900	4.16
6.0 m 20.0 ft	kg lb									*2400 *5,250	*2400 *5,250	5.79 18'8"
4.5 m 15.0 ft	kg lb					*3500 *7,650	*3500 *7,650	*3500 *7,550	2650 5,700	*2250 *4,900	2200 4,850	6.71 21'10"
3.0 m 10.0 ft	kg lb			*5750 *12,350	*5750 *12,350	*4350 *9,450	4000 8,550	3750 8,050	2600 5,500	*2250 *4,900	1900 4,200	7.21 23'7"
1.5 m 5.0 ft	kg lb			*8550 *18,400	6700 14,400	*5450 *11,750	3700 8,000	3650 7,800	2450 5,300	*2350 *5,150	1800 3,950	7.36 24'1"
0 m 0 ft	kg lb			*6950 *16,050	6300 13,500	5400 11,650	3500 7,550	3500 7,550	2350 5,050	*2600 *5,750	1850 4,000	7.20 23'7"
-1.5 m -5.0 ft	kg lb	*4500 *10,100	*4500 *10,100	*9450 *21,000	6200 13,350	5300 11,400	3400 7,350	3450 7,450	2300 4,950	2950 6,550	2000 4,400	6.71 21'11"
-3.0 m -10.0 ft	kg lb	*8000 *18,000	*8000 *18,000	*8600 *18,500	6300 13,500	5350 11,450	3450 7,400			3700 8,200	2450 5,450	5.78 18'9"
-4.5 m -15.0 ft	kg lb			*5900 *13,000	*5900 *13,000					*4050 *10,050	*4050 *10,050	4.13 12'1"

Reach Boom Lift Capacities – Counterweight: 2470 kg (5,445 lb) – without Bucket – Blade Up

2600 mm (8'6") Blade

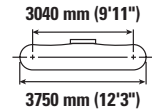
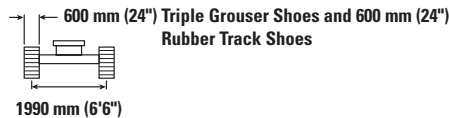
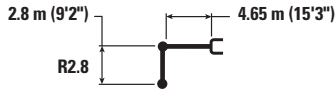

Reach Boom Length	Unit	1.5 m/5.0 ft		3.0 m/10.0 ft		4.5 m/15.0 ft		6.0 m/20.0 ft		Blade		m ft/in
		kg lb	kg lb	kg lb	kg lb	kg lb	kg lb	kg lb	kg lb	kg lb	kg lb	
7.5 m 25.0 ft	kg lb									*2900	*2900	4.16
6.0 m 20.0 ft	kg lb									*2400 *5,250	*2400 *5,250	5.79 18'8"
4.5 m 15.0 ft	kg lb					*3500 *7,650	*3500 *7,650	*3500 *7,550	2600 5,600	*2250 *4,900	2150 4,800	6.71 21'10"
3.0 m 10.0 ft	kg lb			*5750 *12,350	*5750 *12,350	*4350 *9,450	3950 8,450	3700 7,950	2550 5,450	*2250 *4,900	1900 4,150	7.21 23'7"
1.5 m 5.0 ft	kg lb			*8550 *18,400	6600 14,250	*5450 *11,750	3650 7,900	3600 7,700	2450 5,200	*2350 *5,150	1800 3,900	7.36 24'1"
0 m 0 ft	kg lb			*6950 *16,050	6200 13,350	5350 11,450	3450 7,450	3450 7,450	2350 5,000	*2600 *5,750	1800 3,950	7.20 23'7"
-1.5 m -5.0 ft	kg lb	*4500 *10,100	*4500 *10,100	*9450 *21,000	6150 13,150	5250 11,250	3350 7,250	3400 7,350	2300 4,900	2950 6,450	1950 4,350	6.71 21'11"
-3.0 m -10.0 ft	kg lb	*8000 *18,000	*8000 *18,000	*8600 *18,500	6200 13,300	5250 11,300	3400 7,250			3650 8,100	2450 5,400	5.78 18'9"
-4.5 m -15.0 ft	kg lb			*5900 *13,000	*5900 *13,000					*4050 *10,050	4000 *10,050	4.13 12'1"



ISO 10567:2007



* Indicates that the load is limited by hydraulic lifting capacity rather than tipping load. The above loads are in compliance with hydraulic excavator lift capacity standard ISO 10567:2007. They do not exceed 87% of hydraulic lifting capacity or 75% of tipping load. Weight of all lifting accessories must be deducted from the above lifting capacities. Lifting capacities are based on the machine standing on a firm, uniform supporting surface. The use of a work tool attachment point to handle/lift objects, could affect the machine lift performance.

Lift capacity stays with ±5% for all available track shoes.

Always refer to the appropriate Operation and Maintenance Manual for specific product information.

313 GC Hydraulic Excavator Specifications

Reach Boom Lift Capacities – Counterweight: 2470 kg (5,445 lb) – without Bucket – Blade Up

2500 mm (8'2") Blade

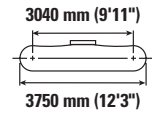
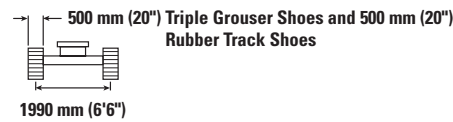
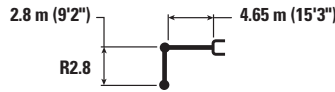

Reach Boom Length	Unit	1.5 m/5.0 ft		3.0 m/10.0 ft		4.5 m/15.0 ft		6.0 m/20.0 ft		Blade Width		m ft/in
		kg lb	kg lb	kg lb	kg lb	kg lb	kg lb	kg lb	kg lb	kg lb	kg lb	
7.5 m 25.0 ft	kg lb									*2900	*2900	4.16
6.0 m 20.0 ft	kg lb									*2400 *5,250	*2400 *5,250	5.79 18'8"
4.5 m 15.0 ft	kg lb					*3500 *7,650	*3500 *7,650	*3500 *7,550	2550 5,500	*2250 *4,900	2100 4,700	6.71 21'10"
3.0 m 10.0 ft	kg lb			*5750 *12,350	*5750 *12,350	*4350 *9,450	3850 8,300	3650 7,800	2500 5,350	*2250 *4,900	1850 4,050	7.21 23'7"
1.5 m 5.0 ft	kg lb			*8550 *18,400	6500 13,950	*5450 *11,750	3600 7,700	3500 7,550	2350 5,100	*2350 *5,150	1750 3,800	7.36 24'1"
0 m 0 ft	kg lb			*6950 *16,050	6100 13,050	5250 11,250	3400 7,250	3400 7,300	2250 4,900	*2600 *5,750	1750 3,850	7.20 23'7"
-1.5 m -5.0 ft	kg lb	*4500 *10,100	*4500 *10,100	*9450 *21,000	6000 12,850	5150 11,050	3300 7,050	3350 7,200	2250 4,800	2850 6,300	1950 4,250	6.71 21'11"
-3.0 m -10.0 ft	kg lb	*8000 *18,000	*8000 *18,000	*8600 *18,500	6050 13,000	5150 11,100	3300 7,100			3600 7,950	2400 5,250	5.78 18'9"
-4.5 m -15.0 ft	kg lb			*5900 *5900						*4050 *10,050	3950 *10,050	4.13 12'1"

Reach Boom Lift Capacities – Counterweight: 2470 kg (5,445 lb) – without Bucket – Blade Up

2500 mm (8'2") Blade

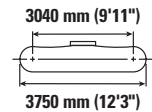
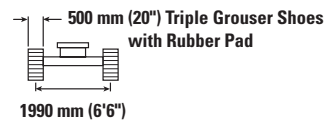
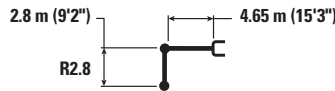

Reach Boom Length	Unit	1.5 m/5.0 ft		3.0 m/10.0 ft		4.5 m/15.0 ft		6.0 m/20.0 ft		Blade Width		m ft/in
		kg lb	kg lb	kg lb	kg lb	kg lb	kg lb	kg lb	kg lb	kg lb	kg lb	
7.5 m 25.0 ft	kg lb									*2900	*2900	4.16
6.0 m 20.0 ft	kg lb									*2400 *5,250	*2400 *5,250	5.79 18'8"
4.5 m 15.0 ft	kg lb					*3500 *7,650	*3500 *7,650	*3500 *7,550	2650 5,650	*2250 *4,900	2200 4,800	6.71 21'10"
3.0 m 10.0 ft	kg lb			*5750 *12,350	*5750 *12,350	*4350 *9,450	3950 8,500	3750 8,050	2550 5,500	*2250 *4,900	1900 4,200	7.21 23'7"
1.5 m 5.0 ft	kg lb			*8550 *18,400	6650 14,300	*5450 *11,750	3700 7,900	3600 7,750	2450 5,250	*2350 *5,150	1800 3,950	7.36 24'1"
0 m 0 ft	kg lb			*6950 *16,050	6250 13,400	5400 11,600	3500 7,450	3500 7,550	2350 5,000	*2600 *5,750	1800 4,000	7.20 23'7"
-1.5 m -5.0 ft	kg lb	*4500 *10,100	*4500 *10,100	*9450 *21,000	6150 13,200	5300 11,350	3400 7,250	3450 7,400	2300 4,900	2950 6,500	2000 4,350	6.71 21'11"
-3.0 m -10.0 ft	kg lb	*8000 *18,000	*8000 *18,000	*8600 *18,500	6250 13,400	5300 11,400	3400 7,300			3700 8,200	2450 5,400	5.78 18'9"
-4.5 m -15.0 ft	kg lb			*5900 *5900						*4050 *10,050	4050 *10,050	4.13 12'1"



ISO 10567:2007



* Indicates that the load is limited by hydraulic lifting capacity rather than tipping load. The above loads are in compliance with hydraulic excavator lift capacity standard ISO 10567:2007. They do not exceed 87% of hydraulic lifting capacity or 75% of tipping load. Weight of all lifting accessories must be deducted from the above lifting capacities. Lifting capacities are based on the machine standing on a firm, uniform supporting surface. The use of a work tool attachment point to handle/lift objects, could affect the machine lift performance.

Lift capacity stays with ±5% for all available track shoes.

Always refer to the appropriate Operation and Maintenance Manual for specific product information.

313 GC Hydraulic Excavator Specifications

Reach Boom Lift Capacities – Counterweight: 2470 kg (5,445 lb) – without Bucket – Blade Up

2700 mm (8'10") Blade

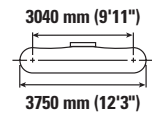
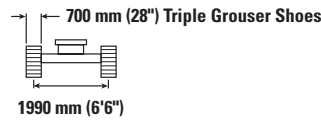
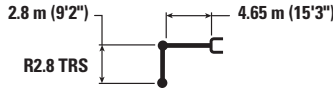

Reach Boom	Unit	1.5 m/5.0 ft		3.0 m/10.0 ft		4.5 m/15.0 ft		6.0 m/20.0 ft		Blade		m ft/in
		Hydraulic	Tipping	Hydraulic	Tipping	Hydraulic	Tipping	Hydraulic	Tipping	Hydraulic	Tipping	
7.5 m 25.0 ft	kg lb									*2850	*2850	4.16
6.0 m 20.0 ft	kg lb									*2350 *5,200	*2350 *5,200	5.79 18'8"
4.5 m 15.0 ft	kg lb					*3500 *7,550	*3500 *7,550	*3450 *7,500	2650 5,700	*2200 *4,850	2200 4,850	6.71 21'10"
3.0 m 10.0 ft	kg lb			*5700 *12,200	*5700 *12,200	*4300 *9,350	4000 8,600	*3750 8,050	2600 5,500	*2200 *4,850	1900 4,200	7.21 23'7"
1.5 m 5.0 ft	kg lb			*8500 *18,250	*6750 14,500	*5400 *11,600	3700 8,000	3650 7,800	2450 5,250	*2350 *5,100	1800 3,950	7.36 24'1"
0 m 0 ft	kg lb			*6900 *16,000	6300 13,550	5450 11,650	3500 7,550	3500 7,550	2350 5,050	*2600 *5,650	1800 4,000	7.20 23'7"
-1.5 m -5.0 ft	kg lb	*4500 *10,050	*4500 *10,050	*9400 *20,850	6250 13,350	5350 11,450	3400 7,350	3450 7,450	2300 4,950	2950 6,550	2000 4,400	6.71 21'11"
-3.0 m -10.0 ft	kg lb	*7950 *17,950	*7950 *17,950	*8500 *18,350	6300 13,550	5350 11,500	3450 7,400			3700 8,250	2450 5,450	5.78 18'9"
-4.5 m -15.0 ft	kg lb			*5850 *5850						*4000 *9,900	*4000 *9,900	4.13 12'1"

Reach Boom Lift Capacities – Counterweight: 2470 kg (5,445 lb) – without Bucket – Blade Up

2600 mm (8'6") Blade

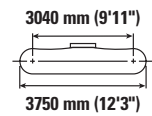
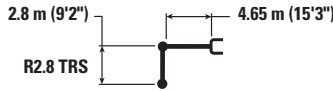

Reach Boom	Unit	1.5 m/5.0 ft		3.0 m/10.0 ft		4.5 m/15.0 ft		6.0 m/20.0 ft		Blade		m ft/in
		Hydraulic	Tipping	Hydraulic	Tipping	Hydraulic	Tipping	Hydraulic	Tipping	Hydraulic	Tipping	
7.5 m 25.0 ft	kg lb									*2850	*2850	4.16
6.0 m 20.0 ft	kg lb									*2350 *5,200	*2350 *5,200	5.79 18'8"
4.5 m 15.0 ft	kg lb					*3500 *7,550	*3500 *7,550	*3450 *7,500	2650 5,600	*2200 *4,850	2150 4,800	6.71 21'10"
3.0 m 10.0 ft	kg lb			*5700 *12,200	*5700 *12,200	*4300 *9,350	3950 8,500	3700 7,950	2550 5,450	*2200 *4,850	1900 4,150	7.21 23'7"
1.5 m 5.0 ft	kg lb			*8500 *18,250	6650 14,300	*5400 *11,600	3650 7,900	3600 7,700	2400 5,200	*2350 *5,100	1800 3,900	7.36 24'1"
0 m 0 ft	kg lb			*6900 *16,000	6250 13,350	5350 11,500	3450 7,450	3450 7,450	2300 4,950	*2600 *5,650	1800 3,950	7.20 23'7"
-1.5 m -5.0 ft	kg lb	*4500 *10,050	*4500 *10,050	*9400 *20,850	6150 13,150	5250 11,250	3350 7,200	3400 7,350	2250 4,850	2950 6,450	1950 4,300	6.71 21'11"
-3.0 m -10.0 ft	kg lb	*7950 *17,950	*7950 *17,950	*8500 *18,350	6200 13,350	5300 11,350	3400 7,250			3650 8,100	2450 5,400	5.78 18'9"
-4.5 m -15.0 ft	kg lb			*5850 *5850						*4000 *9,900	*4000 *9,900	4.13 12'1"



ISO 10567:2007



* Indicates that the load is limited by hydraulic lifting capacity rather than tipping load. The above loads are in compliance with hydraulic excavator lift capacity standard ISO 10567:2007. They do not exceed 87% of hydraulic lifting capacity or 75% of tipping load. Weight of all lifting accessories must be deducted from the above lifting capacities. Lifting capacities are based on the machine standing on a firm, uniform supporting surface. The use of a work tool attachment point to handle/lift objects, could affect the machine lift performance.

Lift capacity stays with ±5% for all available track shoes.

Always refer to the appropriate Operation and Maintenance Manual for specific product information.

313 GC Hydraulic Excavator Specifications

Reach Boom Lift Capacities – Counterweight: 2470 kg (5,445 lb) – without Bucket – Blade Up

2500 mm (8'2") Blade

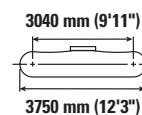
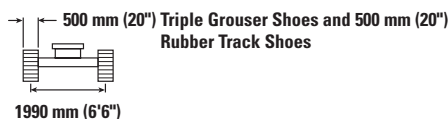
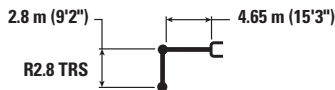

Reach Boom	Unit	1.5 m/5.0 ft		3.0 m/10.0 ft		4.5 m/15.0 ft		6.0 m/20.0 ft		Blade		m ft/in
		Hydraulic	Tipping	Hydraulic	Tipping	Hydraulic	Tipping	Hydraulic	Tipping	Hydraulic	Tipping	
7.5 m 25.0 ft	kg lb									*2850	*2850	4.16
6.0 m 20.0 ft	kg lb									*2350 *5,200	*2350 *5,200	5.79 18'8"
4.5 m 15.0 ft	kg lb					*3500 *7,550	*3500 *7,550	*3450 *7,500	2550 5,500	*2200 *4,850	2100 4,700	6.71 21'10"
3.0 m 10.0 ft	kg lb			*5700 *12,200	*5700 *12,200	*4300 *9,350	3850 8,300	3650 7,800	2500 5,350	*2200 *4,850	1850 4,050	7.21 23'7"
1.5 m 5.0 ft	kg lb			*8500 *18,250	6500 14,000	*5400 *11,600	3600 7,750	3500 7,550	2350 5,100	*2350 *5,100	1750 3,800	7.36 24'1"
0 m 0 ft	kg lb			*6900 *16,000	6100 13,050	5250 11,300	3400 7,250	3400 7,300	2250 4,850	*2600 *5,650	1750 3,850	7.20 23'7"
-1.5 m -5.0 ft	kg lb	*4500 *10,050	*4500 *10,050	*9400 *20,850	6000 12,900	5150 11,050	3300 7,050	3350 7,200	2200 4,750	2850 6,300	1900 4,200	6.71 21'11"
-3.0 m -10.0 ft	kg lb	*7950 *17,950	*7950 *17,950	*8500 *18,350	6100 13,050	5200 11,100	3300 7,100			3600 7,950	2350 5,250	5.78 18'9"
-4.5 m -15.0 ft	kg lb			*5850 *5850	*5850 *5850					*4000 *9,900	3950 *9,900	4.13 12'1"

Reach Boom Lift Capacities – Counterweight: 2470 kg (5,445 lb) – without Bucket – Blade Up

2500 mm (8'2") Blade

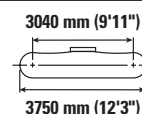
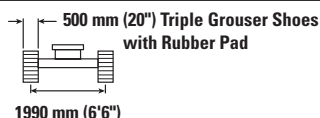
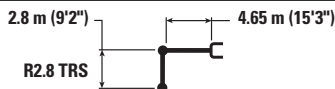

Reach Boom	Unit	1.5 m/5.0 ft		3.0 m/10.0 ft		4.5 m/15.0 ft		6.0 m/20.0 ft		Blade		m ft/in
		Hydraulic	Tipping	Hydraulic	Tipping	Hydraulic	Tipping	Hydraulic	Tipping	Hydraulic	Tipping	
7.5 m 25.0 ft	kg lb									*2850	*2850	4.16
6.0 m 20.0 ft	kg lb									*2350 *5,200	*2350 *5,200	5.79 18'8"
4.5 m 15.0 ft	kg lb					*3500 *7,550	*3500 *7,550	*3450 *7,500	2650 5,650	*2200 *4,850	2150 4,800	6.71 21'10"
3.0 m 10.0 ft	kg lb			*5700 *12,200	*5700 *12,200	*4300 *9,350	3950 8,550	*3750 8,050	2550 5,450	*2200 *4,850	1900 4,150	7.21 23'7"
1.5 m 5.0 ft	kg lb			*8500 *18,250	6700 14,350	*5400 *11,600	3700 7,950	3650 7,800	2450 5,200	*2350 *5,100	1800 3,900	7.36 24'1"
0 m 0 ft	kg lb			*6900 *16,000	6250 13,450	5400 11,650	3500 7,450	3500 7,550	2350 5,000	*2600 *5,650	1800 3,950	7.20 23'7"
-1.5 m -5.0 ft	kg lb	*4500 *10,050	*4500 *10,050	*9400 *20,850	6200 13,250	5300 11,400	3400 7,250	3450 7,450	2300 4,900	2950 6,500	2000 4,350	6.71 21'11"
-3.0 m -10.0 ft	kg lb	*7950 *17,950	*7950 *17,950	*8500 *18,350	6250 13,400	5350 11,450	3400 7,300			3700 8,200	2450 5,400	5.78 18'9"
-4.5 m -15.0 ft	kg lb			*5850 *5850	*5850 *5850					*4000 *9,900	*4000 *9,900	4.13 12'1"



ISO 10567:2007



* Indicates that the load is limited by hydraulic lifting capacity rather than tipping load. The above loads are in compliance with hydraulic excavator lift capacity standard ISO 10567:2007. They do not exceed 87% of hydraulic lifting capacity or 75% of tipping load. Weight of all lifting accessories must be deducted from the above lifting capacities. Lifting capacities are based on the machine standing on a firm, uniform supporting surface. The use of a work tool attachment point to handle/lift objects, could affect the machine lift performance.

Lift capacity stays with ±5% for all available track shoes.

Always refer to the appropriate Operation and Maintenance Manual for specific product information.

313 GC Hydraulic Excavator Specifications

Reach Boom Lift Capacities – Counterweight: 2470 kg (5,445 lb) – without Bucket – Blade Up

2700 mm (8'8") Blade

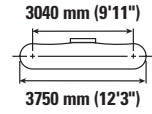
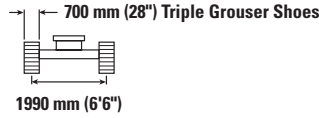
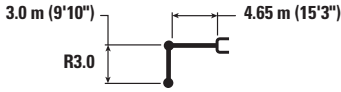

		1.5 m/5.0 ft		3.0 m/10.0 ft		4.5 m/15.0 ft		6.0 m/20.0 ft		7.5 m/25.0 ft		m ft/in		
7.5 m 25.0 ft	kg lb											*2600 *5,850	*2600 *5,850	4.49 14'1"
6.0 m 20.0 ft	kg lb							*2250	*2250			*2200 *4,850	*2200 *4,850	6.03 19'6"
4.5 m 15.0 ft	kg lb							*3350 *7,300	2700 5,750			*2050 *4,500	*2050 *4,500	6.92 22'6"
3.0 m 10.0 ft	kg lb			*5350 *11,450	*5350 *11,450	*4200 *9,050	4000 8,650	*3700 *8,000	2600 5,550			*2050 *4,500	1850 4,050	7.40 24'2"
1.5 m 5.0 ft	kg lb			*8200 *17,650	6800 14,600	*5300 *11,400	3750 8,050	3650 7,800	2450 5,300	*2400	1750	*2150 *4,750	1750 3,850	7.55 24'9"
0 m 0 ft	kg lb			*7250 *16,750	6350 13,600	5450 11,650	3500 7,550	3500 7,550	2350 5,050			*2400 *5,250	1750 3,850	7.40 24'3"
-1.5 m -5.0 ft	kg lb	*4350 *9,700	*4350 *9,700	*9200 *21,000	6200 13,300	5300 11,400	3400 7,350	3450 7,450	2300 4,950			*2850 *6,250	1900 4,200	6.91 22'7"
-3.0 m -10.0 ft	kg lb	*7450 *16,800	*7450 *16,800	*8800 *19,050	6250 13,450	5300 11,400	3400 7,350	3500	2350			3500 7,700	2350 5,150	6.02 19'7"
-4.5 m -15.0 ft	kg lb			*6400 *13,550	*6400 *13,550							*4000 *8,800	3600 8,200	4.48 14'4"

Reach Boom Lift Capacities – Counterweight: 2470 kg (5,445 lb) – without Bucket – Blade Up

2600 mm (8'6") Blade

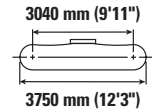
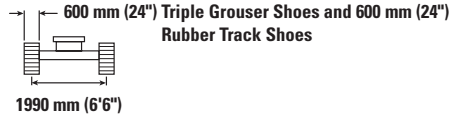
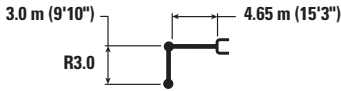

		1.5 m/5.0 ft		3.0 m/10.0 ft		4.5 m/15.0 ft		6.0 m/20.0 ft		7.5 m/25.0 ft		m ft/in		
7.5 m 25.0 ft	kg lb											*2600 *5,850	*2600 *5,850	4.49 14'1"
6.0 m 20.0 ft	kg lb							*2250	*2250			*2200 *4,850	*2200 *4,850	6.03 19'6"
4.5 m 15.0 ft	kg lb							*3350 *7,300	2650 5,650			*2050 *4,500	*2050 *4,500	6.92 22'6"
3.0 m 10.0 ft	kg lb			*5350 *11,450	*5350 *11,450	*4200 *9,050	3950 8,500	*3700 *8,000	2550 5,500			*2050 *4,500	1800 4,000	7.40 24'2"
1.5 m 5.0 ft	kg lb			*8200 *17,650	6700 14,400	*5300 *11,400	3700 7,950	3600 7,700	2450 5,250	*2400	1750	*2150 *4,750	1700 3,750	7.55 24'9"
0 m 0 ft	kg lb			*7250 *16,750	6250 13,400	5350 11,500	3450 7,450	3450 7,450	2350 5,000			*2400 *5,250	1750 3,800	7.40 24'3"
-1.5 m -5.0 ft	kg lb	*4350 *9,700	*4350 *9,700	*9200 *21,000	6100 13,100	5250 11,250	3350 7,200	3400 7,300	2250 4,900			2800 6,150	1900 4,150	6.91 22'7"
-3.0 m -10.0 ft	kg lb	*7450 *16,800	*7450 *16,800	*8800 *19,050	6150 13,250	5250 11,250	3350 7,250	3450	2300			3450 7,600	2300 5,050	6.02 19'7"
-4.5 m -15.0 ft	kg lb			*6400 *13,550	*6400 *13,550							*4000 *8,800	3550 8,100	4.48 14'4"



ISO 10567:2007



* Indicates that the load is limited by hydraulic lifting capacity rather than tipping load. The above loads are in compliance with hydraulic excavator lift capacity standard ISO 10567:2007. They do not exceed 87% of hydraulic lifting capacity or 75% of tipping load. Weight of all lifting accessories must be deducted from the above lifting capacities. Lifting capacities are based on the machine standing on a firm, uniform supporting surface. The use of a work tool attachment point to handle/lift objects, could affect the machine lift performance.

Lift capacity stays with ±5% for all available track shoes.

Always refer to the appropriate Operation and Maintenance Manual for specific product information.

313 GC Hydraulic Excavator Specifications

Reach Boom Lift Capacities – Counterweight: 2470 kg (5,445 lb) – without Bucket – Blade Up

2500 mm (8'2") Blade

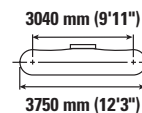

		1.5 m/5.0 ft		3.0 m/10.0 ft		4.5 m/15.0 ft		6.0 m/20.0 ft		7.5 m/25.0 ft		m ft/in		
7.5 m 25.0 ft	kg lb											*2600 *5,850	*2600 *5,850	4.49 14'1"
6.0 m 20.0 ft	kg lb							*2250	*2250			*2200 *4,850	*2200 *4,850	6.03 19'6"
4.5 m 15.0 ft	kg lb							*3350 *7,300	2600 5,550			*2050 *4,500	2050 4,500	6.92 22'6"
3.0 m 10.0 ft	kg lb			*5350 *11,450	*5350 *11,450	*4200 *9,050	3900 8,350	3650 7,850	2500 5,350			*2050 *4,500	1800 3,900	7.40 24'2"
1.5 m 5.0 ft	kg lb			*8200 *17,650	6550 14,150	*5300 *11,400	3600 7,750	3550 7,550	2400 5,100	*2400	1700	*2150 *4,750	1700 3,700	7.55 24'9"
0 m 0 ft	kg lb			*7250 *16,750	6100 13,100	5250 11,300	3400 7,300	3400 7,300	2300 4,900			*2400 *5,250	1700 3,700	7.40 24'3"
-1.5 m -5.0 ft	kg lb	*4350 *9,700	*4350 *9,700	*9200 *21,000	6000 12,850	5150 11,050	3300 7,050	3350 7,200	2200 4,750			2750 6,050	1850 4,050	6.91 22'7"
-3.0 m -10.0 ft	kg lb	*7450 *16,800	*7450 *16,800	*8800 *19,050	6050 12,950	5150 11,050	3300 7,050	3350	2250			3350 7,450	2250 4,950	6.02 19'7"
-4.5 m -15.0 ft	kg lb			*6400 *13,550	6250 13,450							*4000 *8,800	3450 7,900	4.48 14'4"

Reach Boom Lift Capacities – Counterweight: 2470 kg (5,445 lb) – without Bucket – Blade Up

2500 mm (8'2") Blade

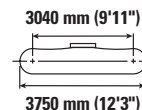
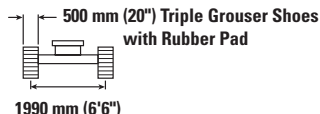

		1.5 m/5.0 ft		3.0 m/10.0 ft		4.5 m/15.0 ft		6.0 m/20.0 ft		7.5 m/25.0 ft		m ft/in		
7.5 m 25.0 ft	kg lb											*2600 *5,850	*2600 *5,850	4.49 14'1"
6.0 m 20.0 ft	kg lb							*2250	*2250			*2200 *4,850	*2200 *4,850	6.03 19'6"
4.5 m 15.0 ft	kg lb							*3350 *7,300	2650 5,700			*2050 *4,500	*2050 *4,500	6.92 22'6"
3.0 m 10.0 ft	kg lb			*5350 *11,450	*5350 *11,450	*4200 *9,050	4000 8,550	*3700 *8,000	2550 5,500			*2050 *4,500	1850 4,000	7.40 24'2"
1.5 m 5.0 ft	kg lb			*8200 *17,650	6750 14,500	*5300 *11,400	3700 8,000	3650 7,800	2450 5,250	*2400	1750	*2150 *4,750	1750 3,800	7.55 24'9"
0 m 0 ft	kg lb			*7250 *16,750	6300 13,450	5400 11,650	3500 7,500	3500 7,550	2350 5050			*2400 *5,250	1750 3,800	7.40 24'3"
-1.5 m -5.0 ft	kg lb	*4350 *9,700	*4350 *9,700	*9200 *21,000	6150 13,200	5300 11,350	3400 7,250	3450 7,400	2300 4,900			*2850 *6,250	1900 4,150	6.91 22'7"
-3.0 m -10.0 ft	kg lb	*7450 *16,800	*7450 *16,800	*8800 *19,050	6200 13,300	5300 11,400	3400 7,300	3500	2300			3450 7,700	2300 5,100	6.02 19'7"
-4.5 m -15.0 ft	kg lb			*6400 *13,550	*6400 *13,550							*4000 *8,800	3550 8,100	4.48 14'4"



ISO 10567:2007



* Indicates that the load is limited by hydraulic lifting capacity rather than tipping load. The above loads are in compliance with hydraulic excavator lift capacity standard ISO 10567:2007. They do not exceed 87% of hydraulic lifting capacity or 75% of tipping load. Weight of all lifting accessories must be deducted from the above lifting capacities. Lifting capacities are based on the machine standing on a firm, uniform supporting surface. The use of a work tool attachment point to handle/lift objects, could affect the machine lift performance.

Lift capacity stays with ±5% for all available track shoes.

Always refer to the appropriate Operation and Maintenance Manual for specific product information.

313 GC Hydraulic Excavator Specifications

Bucket Specifications and Compatibility

										2470 kg (5,445 lb) Counterweight		
		mm	in	m ³	yd ³	kg	lb	%	Reach Boom			
									R2.8 (9'2")	R2.8 TR (9'2")	R3.0 (9'10")	
Pin-On (No Quick Coupler)												
General Duty	312	450	18	0.20	0.27	268	591	100	●	●	●	
	312	600	24	0.31	0.40	320	706	100	●	●	●	
	312	750	30	0.41	0.54	369	814	100	●	●	●	
	312	900	36	0.53	0.69	420	927	100	●	●	●	
	312	1050	42	0.65	0.84	468	1,031	100	⊙	⊙	⊙	
General Duty – Wide Tip	312	450	18	0.27	0.36	317	700	100	●	●	●	
	312	600	24	0.41	0.53	372	821	100	●	●	●	
	312	750	30	0.55	0.72	425	936	101	●	●	●	
	312	900	36	0.71	0.92	478	1,053	100	⊙	⊙	⊖	
	312	1050	42	0.86	1.13	530	1,168	100	○	○	○	
Severe Duty	312	600	24	0.31	0.40	372	820	90	●	●	●	
	312	750	30	0.41	0.54	433	954	90	●	●	●	
	312	900	36	0.53	0.69	495	1,090	90	●	●	●	
	314	1050	42	0.65	0.84	540	1,190	90	●	●	⊙	
Clean Up	312	1500	60	1.02	1.33	630	1,389	100	◇	◇	◇	
Ditch Cleaning	312	1200	48	0.57	0.74	388	855	100	●	●	●	
	312	1500	60	0.74	0.97	455	1,003	100	⊖	⊖	⊖	
Ditch Cleaning Tilt	312	1200	48	0.48	0.63	563	1,240	100	●	●	●	
	312	1500	60	0.57	0.75	646	1,424	100	⊙	⊙	⊙	
Maximum load pin-on (payload + bucket)									kg	1710	1680	1640
									lb	3,774	3,704	3,612

The above loads are in compliance with hydraulic excavator standard EN474-5:2006 + A3:2013, they do not exceed 87% of hydraulic lifting capacity or 75% of tipping capacity with front linkage fully extended at ground line with bucket curled. Capacity based on ISO 7451:2007. Bucket weight with General Duty tips.

Maximum Material Density:

- 2100 kg/m³ (3,500 lb/yd³)
- ⊙ 1800 kg/m³ (3,000 lb/yd³)
- ⊖ 1500 kg/m³ (2,500 lb/yd³)
- 1200 kg/m³ (2,000 lb/yd³)
- ◇ 900 kg/m³ (1,500 lb/yd³)

Caterpillar recommends using appropriate work tools to maximize the value customers receive from our products. Use of work tools, including buckets, which are outside of Caterpillar's recommendations or specifications for weight, dimensions, flows, pressures, etc. may result in less-than-optimal performance, including but not limited to reductions in production, stability, reliability, and component durability. Improper use of a work tool resulting in sweeping, prying, twisting and/or catching of heavy loads will reduce the life of the boom and stick.

(continued on next page)

313 GC Hydraulic Excavator Specifications

Bucket Specifications and Compatibility (continued)

										2470 kg (5,445 lb) Counterweight		
		mm	in	m ³	yd ³	kg	lb	%	Reach Boom			
									R2.8 (9'2")	R2.8 TR (9'2")	R3.0 (9'10")	
With Cat Pin Grabber Coupler												
General Duty	312	450	18	0.20	0.27	268	591	100	●	●	●	
	312	600	24	0.31	0.40	320	706	100	●	●	●	
	312	750	30	0.41	0.54	369	814	100	●	●	●	
	312	900	36	0.53	0.69	420	927	100	●	●	⊙	
	312	1050	42	0.65	0.84	468	1,031	100	⊖	⊖	⊖	
	312	1200	48	0.76	1.00	508	1,119	100	○	○	○	
General Duty – Wide Tip	312	450	18	0.27	0.36	317	700	100	●	●	●	
	312	600	24	0.41	0.53	372	821	100	●	●	●	
	312	750	30	0.55	0.72	425	936	101	⊙	⊙	⊙	
	312	900	36	0.71	0.92	478	1,053	100	⊖	⊖	○	
	312	1050	42	0.86	1.13	530	1,168	100	○	○	◇	
Severe Duty	312	600	24	0.31	0.40	372	820	90	●	●	●	
	312	750	30	0.41	0.54	433	954	90	●	●	●	
	312	900	36	0.53	0.69	495	1,090	90	●	●	⊙	
	312	1050	42	0.65	0.84	540	1,190	90	⊖	⊖	⊖	
Clean Up	312	1500	60	1.02	1.33	630	1,389	100	◇	◇	X	
Ditch Cleaning	312	1200	48	0.57	0.74	388	855	100	⊙	⊙	⊙	
	312	1500	60	0.74	0.97	455	1,003	100	⊖	⊖	○	
Ditch Cleaning Tilt	312	1200	48	0.48	0.63	563	1,240	100	⊙	⊙	⊙	
	312	1500	60	0.57	0.75	646	1,424	100	⊖	⊖	○	
Maximum load with coupler (payload + bucket)								kg	1512	1482	1439	
								lb	3,334	3,267	3,172	

The above loads are in compliance with hydraulic excavator standard EN474-5:2006 + A3:2013, they do not exceed 87% of hydraulic lifting capacity or 75% of tipping capacity with front linkage fully extended at ground line with bucket curled.

Capacity based on ISO 7451:2007.

Bucket weight with General Duty tips.

Maximum Material Density:

- 2100 kg/m³ (3,500 lb/yd³)
- ⊙ 1800 kg/m³ (3,000 lb/yd³)
- ⊖ 1500 kg/m³ (2,500 lb/yd³)
- 1200 kg/m³ (2,000 lb/yd³)
- ◇ 900 kg/m³ (1,500 lb/yd³)
- X Not Recommended

Caterpillar recommends using appropriate work tools to maximize the value customers receive from our products. Use of work tools, including buckets, which are outside of Caterpillar's recommendations or specifications for weight, dimensions, flows, pressures, etc. may result in less-than-optimal performance, including but not limited to reductions in production, stability, reliability, and component durability. Improper use of a work tool resulting in sweeping, prying, twisting and/or catching of heavy loads will reduce the life of the boom and stick.

313 GC Hydraulic Excavator Specifications

Attachments Offering Guide

Not all Attachments are available in all regions. Consult your Cat dealer for configurations available in your region.

Match

Working range front only

No Match

PIN-ON ATTACHMENTS

Counterweight		2470 kg (5,445 lb)	
Boom Type		Reach	
Stick Length		2.80 m (9'2")	3.00 m (9'10")
Hydraulic Hammers	H110 GC	✓	✓
	H110 GC S	✓	✓
	H110 S	✓	✓
	H115 GC	✓	✓
	H115 GC S	✓	✓
	H115 S	✓	✓
Demolition and Sorting Grapples	G314	✓*	
Mobile Scrap and Demolition Shears	S3015 Flat Top	✓*	
Compactors (Vibratory Plate)	CVP75	✓	✓

CAT PIN GRABBER COUPLER ATTACHMENTS

Counterweight		2470 kg (5,445 lb)	
Boom Type		Reach	
Stick Length		2.80 m (9'2")	3.00 m (9'10")
Hydraulic Hammers	H110 GC	✓	✓
	H110 GC S	✓	✓
	H110 S	✓	✓
	H115 GC	✓*	
	H115 GC S	✓*	✓*
	H115 S	✓	✓
Compactors (Vibratory Plate)	CVP75	✓	✓

S60 DEDICATED COUPLER ATTACHMENTS

Counterweight		2470 kg (5,445 lb)	
Boom Type		Reach	
Stick Length		2.80 m (9'2")	3.00 m (9'10")
Hydraulic Hammers	H110 GC	✓	✓
	H110 GC S	✓	✓
	H110 S	✓	✓
	H115 GC	✓*	✓*
	H115 GC S	✓	✓
	H115 S	✓	✓
Compactors (Vibratory Plate)	CVP75	✓	✓

(continued on next page)

313 GC Hydraulic Excavator Specifications

Attachments Offering Guide *(continued)*

Not all Attachments are available in all regions. Consult your Cat dealer for configurations available in your region.

Match

HCS60 DEDICATED COUPLER ATTACHMENTS

Counterweight		2470 kg (5,445 lb)	
Boom Type		Reach	
Stick Length		2.80 m (9'2")	3.00 m (9'10")
Hydraulic Hammers	H110 S	✓	✓
	H115 S	✓	✓
Compactors (Vibratory Plate)	CVP75	✓	✓

HCS65 DEDICATED COUPLER ATTACHMENTS

Counterweight		2470 kg (5,445 lb)	
Boom Type		Reach	
Stick Length		2.80 m (9'2")	3.00 m (9'10")
Hydraulic Hammers	H110 S	✓	✓
	H115 S	✓	✓
Compactors (Vibratory Plate)	CVP75	✓	✓

BOOM-MOUNT ATTACHMENTS

Counterweight		2470 kg (5,445 lb)	
Boom Type		Reach	
Mobile Scrap and Demolition Shears	S3025 Flat Top	✓	

313 GC Hydraulic Excavator Specifications

Thumb Specifications

Match

No Match

Bucket Type	Tooth Quantity	Width		Pro Plus		Pro		Stiff Link		Utility	
		mm	in	Pin-on	Cat Pin Grabber	Pin-on	Cat Pin Grabber	Pin-on	Cat Pin Grabber	Pin-on	Cat Pin Grabber
General Duty	3	450	18					✓	✓	✓	✓
	4	600	24		✓		✓	✓	✓	✓	✓
	5	750	30	✓	✓	✓	✓	✓	✓	✓	✓
	6	900	36	✓	✓	✓	✓	✓	✓	✓	✓
	7	1050	42	✓	✓	✓	✓	✓	✓	✓	✓
	7	1200	48	✓	✓	✓	✓	✓	✓	✓	✓
General Duty – Wide Tip	4	450	18					✓	✓	✓	✓
	5	600	24					✓	✓	✓	✓
	7	900	36					✓	✓	✓	✓
	8	1074	42					✓	✓	✓	✓
	9	1226	48					✓	✓	✓	✓
Severe Duty	3	600	24		✓		✓	✓	✓	✓	✓
	4	750	30	✓	✓	✓	✓	✓	✓	✓	✓
	5	900	36	✓	✓	✓	✓	✓	✓	✓	✓
	5	1050	42	✓	✓	✓	✓	✓	✓	✓	✓

Standard and Optional Equipment

Standard and optional equipment may vary. Consult your Cat dealer for details.

	Standard	Optional		Standard	Optional
BOOMS, STICKS AND LINKAGES			CAT TECHNOLOGY		
4.65 m (15'3") Reach boom	✓		VisionLink®	✓*	
2.8 m (9'2") Reach stick		✓	VisionLink Productivity		✓
2.8 m (9'2") Thumb Ready stick		✓	Remote Flash	✓	
3.0 m (9'10") Reach stick		✓	ELECTRICAL SYSTEM		
Bucket linkage, without lifting eye	✓		Maintenance free battery	✓	
CAB			Centralized electrical disconnect switch	✓	
ROPS	✓		LED chassis light, left-side boom light, cab lights	✓	
High-resolution 203 mm (8") LCD touchscreen monitor	✓		LED right-side boom light		✓
Auto bi-level air conditioner	✓		Programmable time-delay LED working lights	✓	
Jog dial and shortcut keys for monitor control	✓		360° lighting		✓
Keyless push-to-start engine control	✓		ENGINE		
Height-adjustable console, three steps with tool	✓		Cat® C3.6 single turbo diesel engine	✓	
Fixed left-side console	✓		Two selectable modes: Power, Smart	✓	
Mechanical-suspension seat	✓		Automatic engine speed control	✓	
51 mm (2") seat belt	✓		Auto engine shutdown	✓	
Bluetooth® radio with USB/Auxiliary ports	✓		52° C (125° F) high-ambient cooling capacity without de-rate	✓	
12V DC outlets	✓		-18° C (0° F) cold start capability	✓	
Document storage	✓		Electric fuel priming pump	✓	
Beverage holder	✓		Variable speed fan	✓	
Cup holder	✓		Single fuel filtration system	✓	
Openable two-piece front window	✓		Double element air filter with integrated pre-cleaner	✓	
Rear window emergency exit	✓				
Radial wiper with washer	✓				
Openable steel hatch	✓				
LED dome light	✓				
Roller front sunscreen	✓				
Roller rear sunscreen		✓			
Washable floor mat	✓				
Beacon ready	✓				

(continued on next page)

*Connect subscription only. Additional subscriptions are available. Contact your Cat dealer for availability.

313 GC Standard and Optional Equipment

Standard and Optional Equipment *(continued)*

Standard and optional equipment may vary. Consult your Cat dealer for details.

	Standard	Optional		Standard	Optional
HYDRAULIC SYSTEM			SERVICE AND MAINTENANCE		
Boom and stick regeneration circuits	✓		Grouped engine oil and fuel filters	✓	
Automatic hydraulic oil warm up	✓		Side entry to service platform	✓	
Automatic two-speed travel	✓		Ground level engine oil dipstick	✓	
Electric main control valve	✓		Lockable disconnect switch	✓	
Boom and stick drift reduction valve	✓		Scheduled Oil Sampling (S·O·S SM) ports	✓	
Swing drive, with fine swing control function	✓		Integrated vehicle health management system	✓	
Boom and stick lowering check valves		✓	UNDERCARRIAGE AND STRUCTURES		
Medium-pressure line		✓	Grease lubricated track link	✓	
High-pressure line		✓	500 mm (20") triple grouser track shoes with rubber pad		✓
Quick coupler line		✓	500 mm (20") rubber track shoes		✓
SAFETY AND SECURITY			500 mm (20") triple grouser track shoes		✓
Rear and right-side-view cameras	✓		600 mm (24") triple grouser track shoes		✓
Hydraulic lock out lever	✓		600 mm (24") rubber track shoes		✓
Ground level engine shutoff switch	✓		700 mm (28") triple grouser track shoes		✓
Service platform with anti-skid plate and countersunk bolts	✓		2500 mm (8'2") blade		✓
Signaling/warning horn	✓		2600 mm (8'6") blade		✓
Swing alarm		✓	2700 mm (8'10") blade		✓
Inspection lighting		✓	2470 kg (5,445 lb) counterweight	✓	
Auto Hammer Stop	✓		Center track guiding guards	✓	
			Bottom guards	✓	
			Travel motor guards	✓	
			Swivel guard		✓
			Tie-down points on base frame	✓	

Dealer Installed Kits and Attachments

Attachments may vary. Consult your Cat dealer for details.

CAB

- Radial lower wiper
- Left-hand and right-hand electrical pedal (two-way) for tool control
- Dual exit rear window kit
- Rain protector plus cab light cover
- Polycarbonate roof hatch
- Front windshield laminated glass (P5A glass, EU demolition regulation)
- Key fob (for use with Bluetooth receiver)

GUARDS

- Operator Protective Guards (OPG) (not compatible with cab light cover, rain protector)
- Mesh guard full front (not compatible with cab light cover, rain protector)
- Mesh guard lower half front
- Full protecting vandalism guard

SAFETY AND SECURITY

- 76 mm (3") retractable seat belt
- Bluetooth receiver

313 GC Environmental Declaration

The following information applies to the machine at the time of final manufacture as configured for sale in the regions covered in this document. The content of this declaration is valid as of the date issued; however, content related to machine features and specifications are subject to change without notice. For additional information, please see the machine's Operation and Maintenance Manual.

For more information on sustainability in action and our progress, please visit <https://www.caterpillar.com/en/company/sustainability>.

Engine

- The Cat® C3.6 engine meets U.S. EPA Tier 4 Final, EU Stage V, and Japan 2014 emission standards.
- Cat diesel engines are required to use ULSD (ultra-low sulfur diesel fuel with 15 ppm of sulfur or less) or ULSD blended with the following lower-carbon intensity fuels** up to:
 - ✓ 20% biodiesel FAME (fatty acid methyl ester)*
 - ✓ 100% renewable diesel, HVO (hydrogenated vegetable oil) and GTL (gas-to-liquid) fuels

Refer to guidelines for successful application. Please consult your Cat dealer or “Caterpillar Machine Fluids Recommendations” (SEBU6250) for details.

**Engines with no aftertreatment devices can use higher blends, up to 100% biodiesel (for use of blends higher than 20% biodiesel, consult your Cat dealer).*

***Tailpipe greenhouse gas emissions from lower-carbon intensity fuels are essentially the same as traditional fuels.*

Air Conditioning System

- The air conditioning system on this machine contains the fluorinated greenhouse gas refrigerant R134a (Global Warming Potential = 1430). The system contains 0.85 kg (1.9 lb) of refrigerant which has a CO₂ equivalent of 1.216 metric tonnes (1.340 tons).

Paint

- Based on best available knowledge, the maximum allowable concentration, measured in parts per million (PPM), of the following heavy metals in paint are:
 - Barium < 0.01%
 - Cadmium < 0.01%
 - Chromium < 0.01%
 - Lead < 0.01%

Sound Performance

ISO 6395:2008 (external) 99 dB(A)

ISO 6396:2008 (inside cab) 68 dB(A)

- Hearing protection may be needed when operating with an open operator station and cab (when not properly maintained or doors/windows open) for extended periods or in a noisy environment.

Oils and Fluids

- Caterpillar factory fills with ethylene glycol coolants. Cat Diesel Engine Antifreeze/Coolant (DEAC) and Cat Extended Life Coolant (ELC) can be recycled. Consult your Cat dealer for more information.
- Cat Bio HYDO™ Advanced is an EU Ecolabel approved biodegradable hydraulic oil.
- Additional fluids are likely to be present, please consult the Operations and Maintenance Manual or the Application and Installation guide for complete fluid recommendations and maintenance intervals.

Features and Technology

- The following features and technology may contribute to fuel savings and/or carbon reduction. Features may vary. Consult your Cat dealer for details.
 - Advanced hydraulic systems balance power and efficiency
 - Smart mode matches machine power to digging requirements automatically
 - Eco mode minimizes fuel consumption for light applications
 - One-touch low idle with automatic engine speed control
 - Cat Grade with 2D improves operator efficiency by up to 45%
 - Cut maintenance costs up to 25% with extended and synchronized intervals
 - Remote Flash and Remote Troubleshoot

Recycling

- The materials included in machines are categorized as below with approximate weight percentage. Because of variations of product configurations, the following values in the table may vary.

Material Type	Weight Percentage
Steel	82.77%
Iron	4.18%
Nonferrous Metal	1.88%
Mixed Metal	0.30%
Mixed-Metal and Nonmetal	2.50%
Plastic	0.16%
Rubber	3.30%
Mixed Nonmetallic	0.85%
Fluid	2.47%
Other	1.59%
Uncategorized	0.00%
Total	100%

- A machine with higher recyclability rate will ensure more efficient usage of valuable natural resources and enhance End-of-Life value of the product. According to ISO 16714:2008 (Earthmoving machinery – Recyclability and recoverability – Terminology and calculation method), recyclability rate is defined as percentage by mass (mass fraction in percent) of the new machine potentially able to be recycled, reused, or both.

All parts in the bill of material are first evaluated by component type based on a list of components defined by the ISO 16714:2008 and Japan CEMA (Construction Equipment Manufacturers Association) standards. Remaining parts are further evaluated for recyclability based on material type.

Because of variations of product configurations, the following value in the table may vary.

Recyclability – 95%

For more complete information on Cat products, dealer services, and industry solutions, visit us on the web at www.cat.com

© 2023 Caterpillar
All rights reserved

Materials and specifications are subject to change without notice. Featured machines in photos may include additional equipment. See your Cat dealer for available options.

CAT, CATERPILLAR, LET'S DO THE WORK, their respective logos, "Caterpillar Corporate Yellow," the "Power Edge" and Cat "Modern Hex" trade dress as well as corporate and product identity used herein, are trademarks of Caterpillar and may not be used without permission. VisionLink is a trademark of Caterpillar Inc., registered in the United States and in other countries.

AEXQ2863-04 (12-2023)
Replaces AEXQ2863-03
Build Number: 07E
(N Am)

