



# 315

## Hydraulic Excavator

# Technical Specifications

Configurations and features may vary by region. Please consult your Cat® dealer for availability in your area.

## Table of Contents

<b>Specifications</b> .....	<b>2</b>
Engine .....	2
Swing Mechanism .....	2
Weights .....	2
Track .....	2
Drive .....	2
Hydraulic System .....	2
Service Refill Capacities .....	2
Standards .....	2
Sound Performance .....	2
Weights and Ground Pressures .....	3
Major Component Weights .....	4
Dimensions .....	5
Working Ranges and Forces .....	6
Blade Working Ranges .....	7
Reach Boom Lift Capacities .....	8
Reach Boom Lift Capacities – Blade Up .....	14
Power Offset Boom Lift Capacities – Blade Up .....	20
Bucket Specifications and Compatibility .....	21
Attachments Offering Guide .....	23
Thumb Specifications .....	24
<b>Standard and Optional Equipment</b> .....	<b>25</b>
<b>Dealer Installed Kits and Attachments</b> .....	<b>27</b>
<b>315 Environmental Declaration</b> .....	<b>28</b>

# 315 Hydraulic Excavator Specifications

## Engine

Engine Model	Cat® C3.6	
Net Power		
ISO 9249	80.9 kW	108 hp
ISO 9249 (DIN)	110 hp (metric)	
Engine Power		
ISO 14396	82 kW	110 hp
ISO 14396 (DIN)	111 hp (metric)	
Bore	98 mm	4 in
Stroke	120 mm	5 in
Displacement	3.6 L	220 in <sup>3</sup>
Biodiesel Capability	Up to B20 <sup>(1)</sup>	

- Meets U.S. EPA Tier 4 Final, EU Stage V, and Japan 2014 emission standards.
- No engine power derating required below 3000 m (9,840 ft) altitude.
- Advertised power is tested per the specified standard in effect at the time of manufacture.
- Net power advertised is the power available at the flywheel when the engine is equipped with fan, air intake system, exhaust system and alternator.
- Engine speed at 2,400 rpm.

<sup>(1)</sup>Cat diesel engines are required to use ULSD (ultra-low sulfur diesel fuel with 15 ppm of sulfur or less) or ULSD blended with the following lower-carbon intensity fuels up to:

- ✓ 20% biodiesel FAME (fatty acid methyl ester)\*
- ✓ 100% renewable diesel, HVO (hydrogenated vegetable oil) and GTL (gas-to-liquid) fuels

Refer to guidelines for successful application. Please consult your Cat dealer or “Caterpillar Machine Fluids Recommendations” (SEBU6250) for details.

\*Engines with no aftertreatment devices can use higher blends, up to 100% biodiesel.

## Swing Mechanism

Swing Speed	12.0 rpm	
Maximum Swing Torque	35 kN·m	25,815 lbf·ft

## Weights

Operating Weight	15 400 kg	34,000 lb
------------------	-----------	-----------

- Long undercarriage, Reach boom, R3.0 (9'10") stick, GD 0.53 m<sup>3</sup> (0.69 yd<sup>3</sup>) bucket, 700 mm (28") triple grouser shoes and 3.83 mt (8,440 lb) counterweight.

## Track

Optional Track Shoes Width	500 mm	20 in
Optional Track Shoes Width	600 mm	24 in
Optional Track Shoes Width	700 mm	28 in
Number of Shoes (each side)	46	
Number of Track Rollers (each side)	7	
Number of Carrier Rollers (each side)	2	

## Drive

Gradeability	35°/70%	
Maximum Travel Speed	5.6 km/h	3.5 mph
Maximum Drawbar Pull	129 kN	29,000 lbf

## Hydraulic System

Main System – Maximum Flow – Implement	276 L/min	73 gal/min
Maximum Pressure – Equipment – Normal	35 000 kPa	5,075 psi
Maximum Pressure – Travel	35 000 kPa	5,075 psi
Maximum Pressure – Swing	26 000 kPa	3,770 psi
Boom Cylinder – Bore	105 mm	4 in
Boom Cylinder – Stroke	1023 mm	40 in
Stick Cylinder – Bore	115 mm	5 in
Stick Cylinder – Stroke	1147 mm	45 in
Bucket Cylinder – Bore	95 mm	4 in
Bucket Cylinder – Stroke	939 mm	37 in

## Service Refill Capacities

Fuel Tank Capacity	187 L	49 gal
Cooling System	15 L	4 gal
Engine Oil	8 L	2 gal
Final Drive (each)	3 L	1 gal
Hydraulic System (including tank)	85 L	22.5 gal
Hydraulic Tank	72 L	19 gal
Diesel Exhaust Fluid (DEF) Tank	21 L	6 gal

## Standards

Brakes	ISO 10265:2008
Cab/ROPS	ISO 12117-2:2008
Cab/FOGS	ISO 10262:1998

## Sound Performance

ISO 6395 (external)	101 dB(A)
ISO 6396 (inside cab)	71 dB(A)

- When properly installed and maintained, the cab offered by Caterpillar, when tested with doors and windows closed according to ANSI/SAE J1166 OCT98, meets OSHA and MSHA requirements for operator sound exposure limits in effect at time of manufacture.
- Hearing protection may be needed when operating with an open operator station and cab (when not properly maintained or doors/windows open) for extended periods or in a noisy environment.

# 315 Hydraulic Excavator Specifications

## Weights and Ground Pressures

Base Machine Configurations	500 mm (20") Triple Grouser Shoes		500 mm (20") Triple Grouser Shoes with Rubber Pad		500 mm (20") Rubber Track Shoes	
	Weight	Ground Pressure	Weight	Ground Pressure	Weight	Ground Pressure
	kg (lb)	kPa (psi)	kg (lb)	kPa (psi)	kg (lb)	kPa (psi)
<b>Base Frame with Track Rollers and Carrier Rollers</b>						
<b>3.83 mt (8,440 lb) Counterweight + Long Undercarriage Base Machine</b>						
Reach Boom + R3.0 (9'10") Stick + 0.53 m <sup>3</sup> (0.69 yd <sup>3</sup> ) GD Bucket	14 900 (32,800)	44.4 (6.4)	15 300 (33,700)	45.6 (6.6)	15 000 (33,100)	44.7 (6.5)
Reach Boom + R3.0 (9'10") Stick + 0.53 m <sup>3</sup> (0.69 yd <sup>3</sup> ) GD Bucket + Blade	15 600 (34,400)	46.5 (6.7)	16 000 (35,300)	47.7 (6.9)	15 800 (34,800)	47.1 (6.8)
Power Offset Boom + R2.2 (7'3") Stick + 0.53 m <sup>3</sup> (0.69 yd <sup>3</sup> ) GD Bucket + Blade	16 600 (36,600)	49.5 (7.2)	—	—	—	—

All operating weights include a 90% fuel tank with 75 kg (165 lb) operator.

Base Machine Configurations	600 mm (24") Triple Grouser Shoes		600 mm (24") Rubber Track Shoes		700 mm (28") Triple Grouser Shoes	
	Weight	Ground Pressure	Weight	Ground Pressure	Weight	Ground Pressure
	kg (lb)	kPa (psi)	kg (lb)	kPa (psi)	kg (lb)	kPa (psi)
<b>Base Frame with Track Rollers and Carrier Rollers</b>						
<b>3.83 mt (8,440 lb) Counterweight + Long Undercarriage Base Machine</b>						
Reach Boom + R3.0 (9'10") Stick + 0.53 m <sup>3</sup> (0.69 yd <sup>3</sup> ) GD Bucket	15 200 (33,500)	37.8 (5.5)	15 300 (33,700)	38.0 (5.5)	15 400 (34,000)	32.8 (4.8)
Reach Boom + R3.0 (9'10") Stick + 0.53 m <sup>3</sup> (0.69 yd <sup>3</sup> ) GD Bucket + Blade	16 000 (35,300)	39.8 (5.8)	16 100 (35,500)	40.0 (5.8)	16 200 (35,700)	34.5 (5.0)

All operating weights include a 90% fuel tank with 75 kg (165 lb) operator.

# 315 Hydraulic Excavator Specifications

## Major Component Weights

	kg	lb
Base Machine Weight: including upper frame, undercarriage, counterweight, without boom, stick, bucket, boom cylinders, stick cylinder, bucket cylinders, tracks, blade, without 90% fuel tank, operator		
With Long Undercarriage	10 770	23,700
With Long Undercarriage (Blade Compatible)	11 050	24,400
Track Shoes:		
500 mm (20") Triple Grouser Track Shoes	1540	3,390
500 mm (20") Triple Grouser Track Shoes with Rubber Pad	1950	4,310
500 mm (20") Rubber Track Shoes	1670	3,680
600 mm (24") Triple Grouser Track Shoes	1810	4,000
600 mm (24") Rubber Track Shoes	1970	4,340
700 mm (28") Triple Grouser Track Shoes with Additional Steps	2020	4,440
Two Boom Cylinders	240	530
Weight of 90% Fuel Tank and 75 kg (165 lb) Operator	210	460
Blades (without lines, cylinders, frame modifications):		
2500 mm (8'2") Blade for use with 500 mm (20") Track Shoes	440	960
2600 mm (8'6") Blade for use with 600 mm (24") Track Shoes	490	1,080
2700 mm (8'10") Blade for use with 700 mm (28") Track Shoes	500	1,110
Counterweight:		
3.83 mt (8,440 lb) Counterweight	3830	8,440
Swing Frame:	1420	3,140
Undercarriage:		
Base Frame with Standard Track Rollers and Two Carrier Rollers	2690	5,930
Base Frame with Standard Track Rollers and Two Carrier Rollers (Blade Compatible)	2980	6,560
Booms (including lines, pins, stick cylinder):		
Reach Boom 4.65 m (15'3")	1030	2,270
Power Offset Boom 4.37 m (14'4")	1920	4,232
Sticks (including lines, pins, bucket cylinder, bucket linkage):		
Reach Stick R2.8 (9'2")	650	1,400
Thumb Ready Stick R2.8 (9'2")	720	1,600
Reach Stick R3.0 (9'10")	650	1,440
Reach Stick R2.2 (7'3") for use with Power Offset Boom	790	1,741
Buckets (without linkage, with tips and side cutters):		
0.53 m <sup>3</sup> (0.69 yd <sup>3</sup> ) GD Bucket	440	970
0.53 m <sup>3</sup> (0.69 yd <sup>3</sup> ) SD Bucket	500	1,100
0.65 m <sup>3</sup> (0.85 yd <sup>3</sup> ) GD Bucket	470	1,030
0.65 m <sup>3</sup> (0.85 yd <sup>3</sup> ) SD Bucket	540	1,200
0.76 m <sup>3</sup> (0.99 yd <sup>3</sup> ) GD Bucket	510	1,120
Two Bucket Pins	20	50
Quick Coupler:		
Pin Grabber Quick Coupler	210	470

# 315 Hydraulic Excavator Specifications

## Dimensions

All dimensions are approximate and may vary depending on bucket selection.

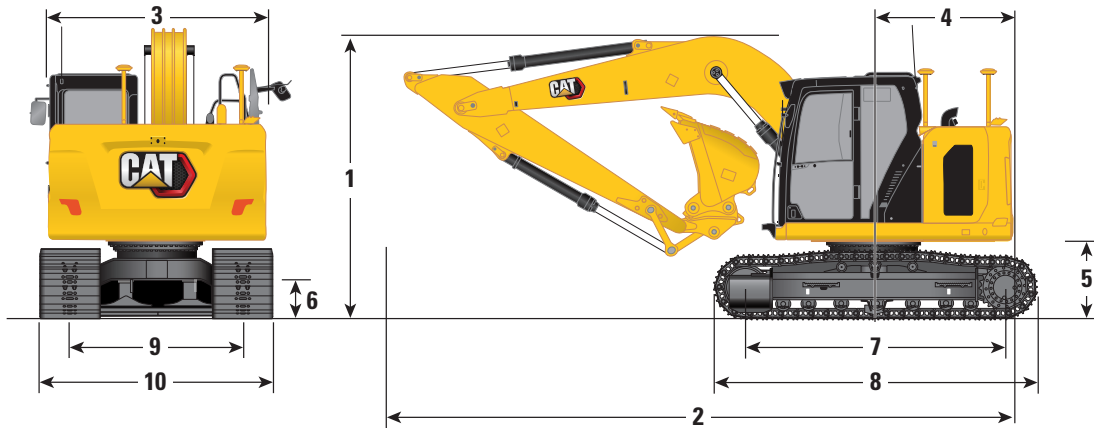

### Boom Options

**Reach Boom**  
4.65 m (15'3")

**Power Offset Boom**  
4.27 m (14'4")

### Stick Options

**Thumb Ready/  
Reach Stick**  
**R2.8 (9'2")**

**Reach Stick**  
**R3.0 (9'10")**

**Reach Stick**  
**R2.2 (7'3")**

### 1 Machine Height:\*

	Reach Boom 4.65 m (15'3")	Thumb Ready/ Reach Stick R2.8 (9'2")	Reach Boom 4.65 m (15'3")	Reach Stick R3.0 (9'10")	Power Offset Boom 4.27 m (14'4")	Reach Stick R2.2 (7'3")
Top of Cab Height	2810 mm	9'3"	2810 mm	9'3"	2810 mm	9'3"
Top of FOGS Height	2960 mm	9'9"	2960 mm	9'9"	2960 mm	9'9"
Handrail Height	2860 mm	9'5"	2860 mm	9'5"	2860 mm	9'5"
With Boom/Stick/Bucket Installed (with stick cylinder lines)	3070 mm	10'1"	3180 mm	10'5"	2890 mm	9'6"
With Boom/Stick Installed (with stick cylinder lines)	3070 mm	10'1"	3180 mm	10'5"	2890 mm	9'6"
With Boom Installed (with stick cylinder lines)	2410 mm	7'11"	2410 mm	7'11"	—	—

### 2 Machine Length (without blade):

With Boom/Stick/Bucket Installed (with stick cylinder lines)	7570 mm	24'10"	7530 mm	24'8"	—	—
With Boom/Stick Installed (with stick cylinder lines)	7570 mm	24'10"	7530 mm	24'8"	—	—
With Boom Installed (with stick cylinder lines)	6640 mm	21'9"	6640 mm	21'9"	—	—

### Machine Length (with blade, blade rear):

With Boom/Stick/Bucket Installed (with stick cylinder lines)	8130 mm	26'8"	8090 mm	26'7"	8005 mm	26'3"
With Boom/Stick Installed (with stick cylinder lines)	8130 mm	26'8"	8090 mm	26'7"	8005 mm	26'3"
With Boom Installed (with stick cylinder lines)	7200 mm	23'7"	7200 mm	23'7"	—	—

### 3 Upperframe Width

2480 mm	8'2"	2480 mm	8'2"	2480 mm	8'2"
---------	------	---------	------	---------	------

### 4 Tail Swing Radius 3.83 mt (8,440 lb) Counterweight

1570 mm	5'2"	1570 mm	5'2"	1570 mm	5'2"
---------	------	---------	------	---------	------

### 5 Counterweight Clearance

880 mm	2'11"	880 mm	2'11"	880 mm	2'11"
--------	-------	--------	-------	--------	-------

### 6 Ground Clearance

440 mm	1'5"	440 mm	1'5"	440 mm	1'5"
--------	------	--------	------	--------	------

### 7 Length to Center of Rollers

3040 mm	10'0"	3040 mm	10'0"	3040 mm	10'0"
---------	-------	---------	-------	---------	-------

### 8 Track Length

3750 mm	12'4"	3750 mm	12'4"	3750 mm	12'4"
---------	-------	---------	-------	---------	-------

### 9 Track Gauge

1990 mm	6'6"	1990 mm	6'6"	1990 mm	6'6"
---------	------	---------	------	---------	------

### 10 Track Width/Undercarriage Width:

500 mm (20") Shoes	2490 mm	8'2"	2490 mm	8'2"	2490 mm	8'2"
600 mm (24") Shoes	2590 mm	8'6"	2590 mm	8'6"	—	—
700 mm (28") Shoes (with steps)	2690 mm	8'10"	2690 mm	8'10"	—	—

### Bucket Type

GD

GD

GD

Bucket Capacity	0.65 m <sup>3</sup>	0.85 yd <sup>3</sup>	0.53 m <sup>3</sup>	0.69 yd <sup>3</sup>	0.53 m <sup>3</sup>	0.69 yd <sup>3</sup>
-----------------	---------------------	----------------------	---------------------	----------------------	---------------------	----------------------

Bucket Tip Radius	1240 mm	4'1"	1240 mm	4'1"	1240 mm	4'1"
-------------------	---------	------	---------	------	---------	------

\*For models with rubber track shoes or rubber pad add 40 mm (1.6") to machine height dimensions.

# 315 Hydraulic Excavator Specifications

## Working Ranges and Forces

All dimensions are approximate and may vary depending on bucket selection.

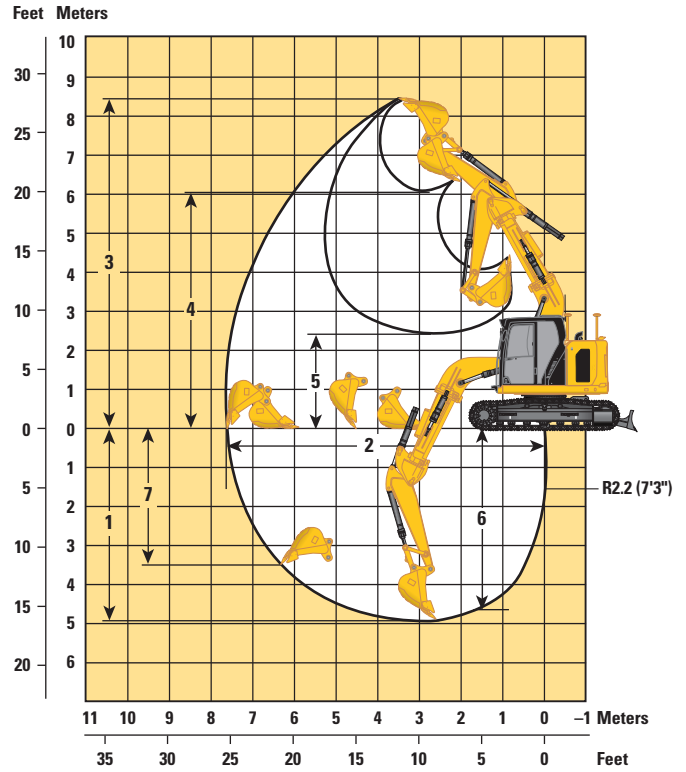
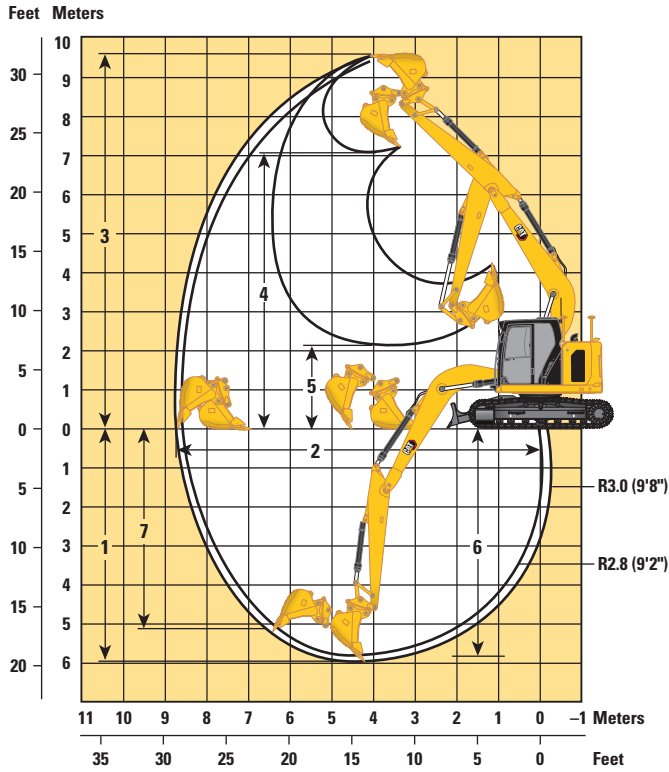

### Boom Options

Reach Boom  
4.65 m (15'3")

Power Offset Boom  
4.27 m (14'4")

### Stick Options

Thumb Ready/  
Reach Stick  
R2.8 (9'2")

Reach Stick  
R3.0 (9'10")

Reach Stick  
R2.2 (7'3")

	Thumb Ready/ Reach Stick R2.8 (9'2")		Reach Stick R3.0 (9'10")		Reach Stick R2.2 (7'3")	
	mm	ft/in	mm	ft/in	mm	ft/in
1 Maximum Digging Depth	5790	19'0"	5990	19'8"	4930	16'2"
2 Maximum Reach at Ground Line	8500	27'11"	8690	28'6"	7640	25'1"
3 Maximum Cutting Height	9540	31'4"	9690	31'9"	8430	27'8"
4 Maximum Loading Height	7060	23'2"	7220	23'8"	6020	19'9"
5 Minimum Loading Height	2260	7'5"	2080	6'10"	2470	8'1"
6 Maximum Depth Cut for 2440 mm (8'0") Level Bottom	5600	18'4"	5810	19'1"	4640	15'3"
7 Maximum Vertical Wall Digging Depth	4990	16'4"	5180	17'0"	3500	11'6"
Minimum Working Equipment Radius	2170	7'1"	2240	7'4"	1800	5'11"
Bucket Digging Force (ISO)	98.67 kN	22,180 lbf	98.67 kN	22,180 lbf	87.70 kN	19,720 lbf
Stick Digging Force (ISO)	62.34 kN	14,010 lbf	59.29 kN	13,330 lbf	59.50 kN	13,380 lbf
Bucket Type	GD		GD		GD	
Bucket Capacity	0.65 m <sup>3</sup>	0.85 yd <sup>3</sup>	0.53 m <sup>3</sup>	0.69 yd <sup>3</sup>	0.53 m <sup>3</sup>	0.69 yd <sup>3</sup>
Bucket Tip Radius	1240 mm	4'1"	1240 mm	4'1"	1240 mm	4'1"

# 315 Hydraulic Excavator Specifications

## Blade Working Ranges

All dimensions are approximate and may vary depending on bucket selection.

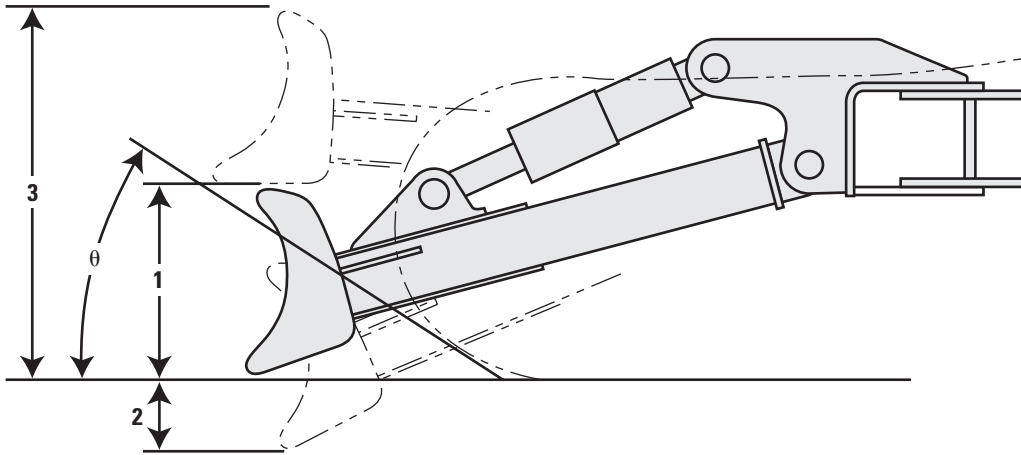







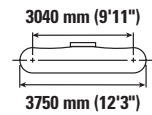
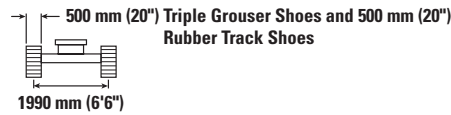
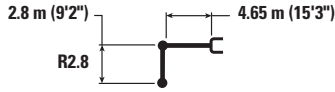



Blade Options	2500 mm (8'2")		2600 mm (8'6")		2700 mm (8'10")	
	<b>1</b> Blade Height	616 mm	2'0"	616 mm	2'0"	616 mm
<b>2</b> Maximum Lowering Depth from Ground	550 mm	1'10"	550 mm	1'10"	550 mm	1'10"
<b>3</b> Maximum Raising Height above Ground	1018 mm	3'4"	1018 mm	3'4"	1018 mm	3'4"
<b><math>\theta</math></b> Approach Angle	26°		26°		26°	

# 315 Hydraulic Excavator Specifications









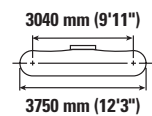
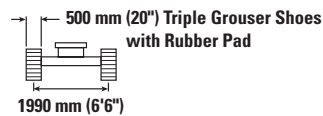
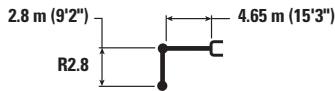

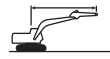
## Reach Boom Lift Capacities – Counterweight: 3.83 mt (8,440 lb) – without Bucket



		1.5 m/5.0 ft		3.0 m/10.0 ft		4.5 m/15.0 ft		6.0 m/20.0 ft				m ft/in
												
7.5 m 25.0 ft	kg lb									*2900 *6,500	*2900 *6,500	4.21 13'2"
6.0 m 20.0 ft	kg lb					*3700 *8,100	*3700 *8,100			*2400 *5,250	*2400 *5,250	5.83 18'10"
4.5 m 15.0 ft	kg lb					*4000 *8,700	*4000 *8,700	*3600 *7,650	2600 5,600	*2250 *4,900	2150 4,700	6.75 22'0"
3.0 m 10.0 ft	kg lb			*6850 *14,750	*6850 *14,750	*4900 *10,650	3900 8,400	3950 8,450	2550 5,400	*2250 *4,900	1850 4,100	7.24 23'8"
1.5 m 5.0 ft	kg lb			*8950 *19,250	6550 14,150	*5700 *12,250	3650 7,850	3800 8,200	2400 5,150	*2350 *5,150	1750 3,850	7.40 24'3"
0 m 0 ft	kg lb			*6700 *15,500	6150 13,250	5700 12,250	3450 7,400	3700 7,950	2300 4,950	*2600 *5,750	1800 3,900	7.24 23'8"
-1.5 m -5.0 ft	kg lb	*4500 *10,050	*4500 *10,050	*8250 *17,900	6100 13,050	5600 12,000	3350 7,200	3650 7,850	2250 4,850	3100 6,850	1950 4,300	6.74 22'0"
-3.0 m -10.0 ft	kg lb	*7950 *17,900	*7950 *17,900	*6300 *13,550	6150 13,250	*4450 *9,550	3350 7,250			*2950 *6,450	2400 5,350	5.81 18'10"
-4.5 m -15.0 ft	kg lb									*2100	*2100	3.93 12'9"

## Reach Boom Lift Capacities – Counterweight: 3.83 mt (8,440 lb) – without Bucket



		1.5 m/5.0 ft		3.0 m/10.0 ft		4.5 m/15.0 ft		6.0 m/20.0 ft				m ft/in
												
7.5 m 25.0 ft	kg lb									*2900 *6,500	*2900 *6,500	4.21 13'2"
6.0 m 20.0 ft	kg lb					*3700 *8,100	*3700 *8,100			*2400 *5,250	*2400 *5,250	5.83 18'10"
4.5 m 15.0 ft	kg lb					*4000 *8,700	*4000 *8,700	*3600 *7,650	2700 5,750	*2250 *4,900	2200 4,850	6.75 22'0"
3.0 m 10.0 ft	kg lb			*6850 *14,750	*6850 *14,750	*4900 *10,650	4000 8,600	*4050 8,700	2600 5,550	*2250 *4,900	1900 4,200	7.24 23'8"
1.5 m 5.0 ft	kg lb			*8950 *19,250	6750 14,500	*5700 *12,250	3750 8,050	3950 8,450	2500 5,300	*2350 *5,150	1800 4,000	7.40 24'3"
0 m 0 ft	kg lb			*6700 *15,500	6350 13,600	5850 12,600	3550 7,600	3800 8,200	2400 5,100	*2600 *5,750	1850 4,000	7.24 23'8"
-1.5 m -5.0 ft	kg lb	*4500 *10,050	*4500 *10,050	*8250 *17,900	6250 13,450	*5650 *12,200	3450 7,400	3750 8,100	2350 5,000	*3150 *6,900	2000 4,400	6.74 22'0"
-3.0 m -10.0 ft	kg lb	*7950 *17,900	*7950 *17,900	*6300 *13,550	6300 *13,550	*4450 *9,550	3450 7,450			*2950 *6,450	2500 5,500	5.81 18'10"
-4.5 m -15.0 ft	kg lb									*2100	*2100	3.93 12'9"



ISO 10567



\* Indicates that the load is limited by hydraulic lifting capacity rather than tipping load. The above loads are in compliance with hydraulic excavator lift capacity standard ISO 10567:2007. They do not exceed 87% of hydraulic lifting capacity or 75% of tipping load. Weight of all lifting accessories must be deducted from the above lifting capacities. Lifting capacities are based on the machine standing on a firm, uniform supporting surface. The use of a work tool attachment point to handle/lift objects, could affect the machine lift performance.

Lift capacity stays with ±5% for all available track shoes.









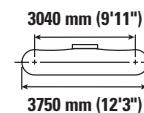
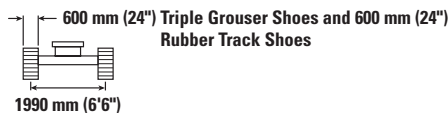
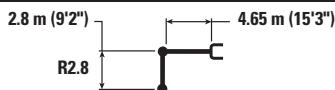

Always refer to the appropriate Operation and Maintenance Manual for specific product information.



# 315 Hydraulic Excavator Specifications









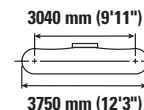
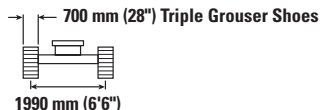
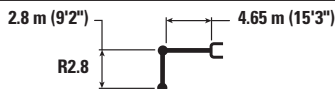

## Reach Boom Lift Capacities – Counterweight: 3.83 mt (8,440 lb) – without Bucket



		1.5 m/5.0 ft		3.0 m/10.0 ft		4.5 m/15.0 ft		6.0 m/20.0 ft				m ft/in
												
7.5 m 25.0 ft	kg lb									*2900 *6,500	*2900 *6,500	4.21 13'2"
6.0 m 20.0 ft	kg lb					*3700 *8,100	*3700 *8,100			*2400 *5,250	*2400 *5,250	5.83 18'10"
4.5 m 15.0 ft	kg lb					*4000 *8,700	*4000 *8,700	*3600 *7,650	2650 5,700	*2250 *4,900	2150 4,800	6.75 22'0"
3.0 m 10.0 ft	kg lb			*6850 *14,750	*6850 *14,750	*4900 *10,650	4000 8,550	4000 8,600	2550 5,500	*2250 *4,900	1900 4,200	7.24 23'8"
1.5 m 5.0 ft	kg lb			*8950 *19,250	6700 14,400	*5700 *12,250	3700 7,950	3900 8,350	2450 5,250	*2350 *5,150	1800 3,950	7.40 24'3"
0 m 0 ft	kg lb			*6700 *15,500	6300 13,500	5800 12,450	3500 7,500	3800 8,100	2350 5,050	*2600 *5,750	1800 4,000	7.24 23'8"
-1.5 m -5.0 ft	kg lb	*4500 *10,050	*4500 *10,050	*8250 *17,900	6200 13,300	*5650 *12,200	3400 7,300	3750 8,000	2300 4,950	*3150 *6,900	2000 4,350	6.74 22'0"
-3.0 m -10.0 ft	kg lb	*7950 *17,900	*7950 *17,900	*6300 *13,550	6300 13,450	*4450 *9,550	3450 7,350			*2950 *6,450	2450 5,450	5.81 18'10"
-4.5 m -15.0 ft	kg lb									*2100	*2100	3.93 12'9"

## Reach Boom Lift Capacities – Counterweight: 3.83 mt (8,440 lb) – without Bucket



		1.5 m/5.0 ft		3.0 m/10.0 ft		4.5 m/15.0 ft		6.0 m/20.0 ft				m ft/in
												
7.5 m 25.0 ft	kg lb									*2900 *6,500	*2900 *6,500	4.21 13'2"
6.0 m 20.0 ft	kg lb					*3700 *8,100	*3700 *8,100			*2400 *5,250	*2400 *5,250	5.83 18'10"
4.5 m 15.0 ft	kg lb					*4000 *8,700	*4000 *8,700	*3600 *7,650	2700 5,750	*2250 *4,900	2200 4,850	6.75 22'0"
3.0 m 10.0 ft	kg lb			*6850 *14,750	*6850 *14,750	*4900 *10,650	4000 8,650	*4050 8,750	2600 5,600	*2250 *4,900	1950 4,250	7.24 23'8"
1.5 m 5.0 ft	kg lb			*8950 *19,250	6750 14,550	*5700 *12,250	3750 8,050	3950 8,450	2500 5,350	*2350 *5,150	1800 4,000	7.40 24'3"
0 m 0 ft	kg lb			*6700 *15,500	6350 13,650	5900 12,650	3550 7,600	3850 8,200	2400 5,150	*2600 *5,750	1850 4,050	7.24 23'8"
-1.5 m -5.0 ft	kg lb	*4500 *10,050	*4500 *10,050	*8250 *17,900	6300 13,500	*5650 *12,200	3450 7,400	3800 8,100	2350 5,050	*3150 *6,900	2000 4,450	6.74 22'0"
-3.0 m -10.0 ft	kg lb	*7950 *17,900	*7950 *17,900	*6300 *13,550	6300 13,550	*4450 *9,550	3450 7,450			*2950 *6,450	2500 5,500	5.81 18'10"
-4.5 m -15.0 ft	kg lb									*2100	*2100	3.93 12'9"



ISO 10567



\* Indicates that the load is limited by hydraulic lifting capacity rather than tipping load. The above loads are in compliance with hydraulic excavator lift capacity standard ISO 10567:2007. They do not exceed 87% of hydraulic lifting capacity or 75% of tipping load. Weight of all lifting accessories must be deducted from the above lifting capacities. Lifting capacities are based on the machine standing on a firm, uniform supporting surface. The use of a work tool attachment point to handle/lift objects, could affect the machine lift performance.

Lift capacity stays with  $\pm 5\%$  for all available track shoes.

Always refer to the appropriate Operation and Maintenance Manual for specific product information.

# 315 Hydraulic Excavator Specifications

## Reach Boom Lift Capacities – Counterweight: 3.83 mt (8,440 lb) – without Bucket

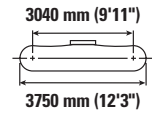
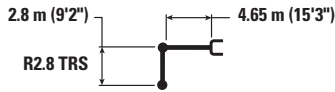

Reach Boom	Unit	1.5 m/5.0 ft		3.0 m/10.0 ft		4.5 m/15.0 ft		6.0 m/20.0 ft		Illustration		m ft/in
		Hydraulic	Tipping	Hydraulic	Tipping	Hydraulic	Tipping	Hydraulic	Tipping	Hydraulic	Tipping	
7.5 m 25.0 ft	kg lb									*2850 *6,400	*2850 *6,400	4.21 13'2"
6.0 m 20.0 ft	kg lb					*3700 *8,050	*3700 *8,050			*2350 *5,200	*2350 *5,200	5.83 18'10"
4.5 m 15.0 ft	kg lb					*3950 *8,650	*3950 *8,650	*3600 *7,600	2600 5,500	*2200 *4,850	2100 4,650	6.75 22'0"
3.0 m 10.0 ft	kg lb			*6800 *14,600	*6800 *14,600	*4850 *10,550	3900 8,350	3900 8,400	2500 5,350	*2200 *4,850	1850 4,000	7.24 23'8"
1.5 m 5.0 ft	kg lb			*8850 *19,100	6500 14,000	*5600 *12,150	3600 7,750	3800 8,100	2350 5,100	*2350 *5,100	1700 3,750	7.40 24'3"
0 m 0 ft	kg lb			*6,650 *15,450	6,100 13,050	5,650 12,150	3,400 7,250	3,650 7,850	2,250 4,850	*2,600 *5,700	1,750 3,800	7.24 23'8"
-1.5 m -5.0 ft	kg lb	*4450 *10,000	*4450 *10,000	*8150 *17,700	6000 12,900	5550 11,900	3300 7,050	3600 7,750	2200 4,750	3100 6,750	1900 4,200	6.74 22'0"
-3.0 m -10.0 ft	kg lb	*7950 *17,850	*7950 *17,850	*6250 *13,400	6100 13,050	*4400 *9,400	3300 7,100			*2900 *6,300	2350 5,250	5.81 18'10"
-4.5 m -15.0 ft	kg lb									*2050	*2050	3.93 12'9"

## Reach Boom Lift Capacities – Counterweight: 3.83 mt (8,440 lb) – without Bucket

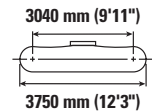
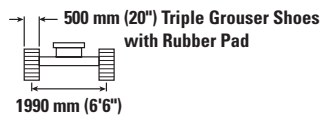
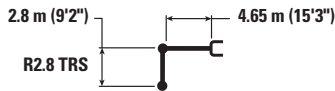

Reach Boom	Unit	1.5 m/5.0 ft		3.0 m/10.0 ft		4.5 m/15.0 ft		6.0 m/20.0 ft		Illustration		m ft/in
		Hydraulic	Tipping	Hydraulic	Tipping	Hydraulic	Tipping	Hydraulic	Tipping	Hydraulic	Tipping	
7.5 m 25.0 ft	kg lb									*2850 *6,400	*2850 *6,400	4.21 13'2"
6.0 m 20.0 ft	kg lb					*3700 *8,050	*3700 *8,050			*2350 *5,200	*2350 *5,200	5.83 18'10"
4.5 m 15.0 ft	kg lb					*3950 *8,650	*3950 *8,650	*3600 *7,600	2650 5,650	*2200 *4,850	2150 4,750	6.75 22'0"
3.0 m 10.0 ft	kg lb			*6800 *14,600	*6800 *14,600	*4850 *10,550	3950 8,550	*4000 8,600	2550 5,500	*2200 *4,850	1900 4,150	7.24 23'8"
1.5 m 5.0 ft	kg lb			*8850 *19,100	6650 14,350	*5600 *12,150	3700 7,950	3900 8,350	2450 5,250	*2350 *5,100	1800 3,900	7.40 24'3"
0 m 0 ft	kg lb			*6650 *15,450	6250 13,450	5800 12,450	3500 7,450	3750 8,100	2350 5,000	*2600 *5,700	1800 3,950	7.24 23'8"
-1.5 m -5.0 ft	kg lb	*4450 *10,000	*4450 *10,000	*8150 *17,700	6200 13,250	*5600 *12,100	3400 7,250	3700 8,000	2300 4,900	*3100 *6,850	1950 4,300	6.74 22'0"
-3.0 m -10.0 ft	kg lb	*7950 *17,850	*7950 *17,850	*6250 *13,400	6250 *13,400	*4400 *9,400	3400 7,300			*2900 *6,300	2450 5,400	5.81 18'10"
-4.5 m -15.0 ft	kg lb									*2050	*2050	3.93 12'9"



ISO 10567



\* Indicates that the load is limited by hydraulic lifting capacity rather than tipping load. The above loads are in compliance with hydraulic excavator lift capacity standard ISO 10567:2007. They do not exceed 87% of hydraulic lifting capacity or 75% of tipping load. Weight of all lifting accessories must be deducted from the above lifting capacities. Lifting capacities are based on the machine standing on a firm, uniform supporting surface. The use of a work tool attachment point to handle/lift objects, could affect the machine lift performance.









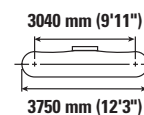
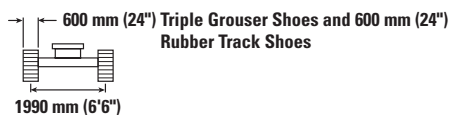
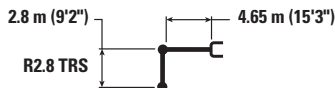

Lift capacity stays with ±5% for all available track shoes.

Always refer to the appropriate Operation and Maintenance Manual for specific product information.

# 315 Hydraulic Excavator Specifications









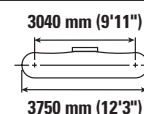
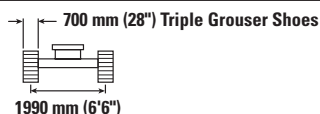
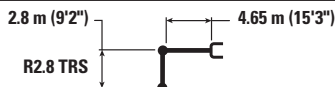

## Reach Boom Lift Capacities – Counterweight: 3.83 mt (8,440 lb) – without Bucket



		1.5 m/5.0 ft		3.0 m/10.0 ft		4.5 m/15.0 ft		6.0 m/20.0 ft				m ft/in
												
7.5 m 25.0 ft	kg lb									*2850 *6,400	*2850 *6,400	4.21 13'2"
6.0 m 20.0 ft	kg lb					*3700 *8,050	*3700 *8,050			*2350 *5,200	*2350 *5,200	5.83 18'10"
4.5 m 15.0 ft	kg lb					*3950 *8,650	*3950 *8,650	*3600 *7,600	2600 5,600	*2200 *4,850	2150 4,700	6.75 22'0"
3.0 m 10.0 ft	kg lb			*6800 *14,600	*6800 *14,600	*4850 *10,550	3950 8,450	4000 8,550	2550 5,450	*2200 *4,850	1850 4,100	7.24 23'8"
1.5 m 5.0 ft	kg lb			*8850 *19,100	6600 14,250	*5600 *12,150	3650 7,850	3850 8,250	2400 5,200	*2350 *5,100	1750 3,850	7.40 24'3"
0 m 0 ft	kg lb			*6650 *15,450	6200 13,300	5750 12,350	3450 7,400	3750 8,000	2300 4,950	*2600 *5,700	1800 3,900	7.24 23'8"
-1.5 m -5.0 ft	kg lb	*4450 *10,000	*4450 *10,000	*8150 *17,700	6100 13,150	*5600 *12,100	3350 7,200	3700 7,900	2250 4,850	*3100 *6,850	1950 4,250	6.74 22'0"
-3.0 m -10.0 ft	kg lb	*7950 *17,850	*7950 *17,850	*6250 *13,400	6200 13,300	*4400 *9,400	3350 7,250			*2900 *6,300	2400 5,350	5.81 18'10"
-4.5 m -15.0 ft	kg lb									*2050	*2050	3.93 12'9"

## Reach Boom Lift Capacities – Counterweight: 3.83 mt (8,440 lb) – without Bucket



		1.5 m/5.0 ft		3.0 m/10.0 ft		4.5 m/15.0 ft		6.0 m/20.0 ft				m ft/in
												
7.5 m 25.0 ft	kg lb									*2850 *6,400	*2850 *6,400	4.21 13'2"
6.0 m 20.0 ft	kg lb					*3700 *8,050	*3700 *8,050			*2350 *5,200	*2350 *5,200	5.83 18'10"
4.5 m 15.0 ft	kg lb					*3950 *8,650	*3950 *8,650	*3600 *7,600	2650 5,700	*2200 *4,850	2150 4,800	6.75 22'0"
3.0 m 10.0 ft	kg lb			*6800 *14,600	*6800 *14,600	*4850 *10,550	4000 8,550	*4000 *8,650	2550 5,500	*2200 *4,850	1900 4,150	7.24 23'8"
1.5 m 5.0 ft	kg lb			*8850 *19,100	6700 14,400	*5600 *12,150	3700 7,950	3900 8,350	2450 5,250	*2350 *5,100	1800 3,900	7.40 24'3"
0 m 0 ft	kg lb			*6650 *15,450	6300 13,500	5850 12,500	3500 7,500	3800 8,150	2350 5,050	*2600 *5,700	1800 3,950	7.24 23'8"
-1.5 m -5.0 ft	kg lb	*4450 *10,000	*4450 *10,000	*8150 *17,700	6200 13,300	*5600 *12,100	3400 7,300	3750 8,000	2300 4,950	*3100 *6,850	2000 4,350	6.74 22'0"
-3.0 m -10.0 ft	kg lb	*7950 *17,850	*7950 *17,850	*6250 *13,400	*6250 *13,400	*4400 *9,400	3400 7,350			*2900 *6,300	2450 5,400	5.81 18'10"
-4.5 m -15.0 ft	kg lb									*2050	*2050	3.93 12'9"



ISO 10567



\* Indicates that the load is limited by hydraulic lifting capacity rather than tipping load. The above loads are in compliance with hydraulic excavator lift capacity standard ISO 10567:2007. They do not exceed 87% of hydraulic lifting capacity or 75% of tipping load. Weight of all lifting accessories must be deducted from the above lifting capacities. Lifting capacities are based on the machine standing on a firm, uniform supporting surface. The use of a work tool attachment point to handle/lift objects, could affect the machine lift performance.

Lift capacity stays with ±5% for all available track shoes.

Always refer to the appropriate Operation and Maintenance Manual for specific product information.

# 315 Hydraulic Excavator Specifications

## Reach Boom Lift Capacities – Counterweight: 3.83 mt (8,440 lb) – without Bucket

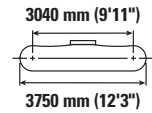
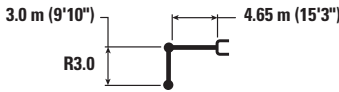

		1.5 m/5.0 ft		3.0 m/10.0 ft		4.5 m/15.0 ft		6.0 m/20.0 ft		7.5 m/25.0 ft		m ft/in		
7.5 m 25.0 ft	kg lb					*2700	*2700					*2600 *5,850	*2600 *5,850	4.54 14'3"
6.0 m 20.0 ft	kg lb					*3450 *7,550	*3450 *7,550	*2400	*2400			*2200 *4,850	*2200 *4,850	6.07 19'8"
4.5 m 15.0 ft	kg lb					*3650 *7,950	*3650 *7,950	*3450 *7,400	2650 5,650			*2050 *4,500	2050 4,500	6.96 22'8"
3.0 m 10.0 ft	kg lb			*5850 *12,100	*5850 *12,100	*4800 *10,350	3950 8,500	*3950 8,500	2550 5,450			*2050 *4,500	1800 3,950	7.44 24'4"
1.5 m 5.0 ft	kg lb			*8750 *18,800	6650 14,300	*5600 *12,050	3650 7,900	3850 8,200	2400 5,200	*2500	1750	*2150 *4,750	1700 3,700	7.59 24'10"
0 m 0 ft	kg lb			*7000 *16,150	6200 13,300	5700 12,300	3450 7,400	3700 7,950	2300 4,950			*2400 *5,250	1700 3,750	7.43 24'4"
-1.5 m -5.0 ft	kg lb	*4300 *9,650	*4300 *9,650	*8500 *18,350	6100 13,050	5600 12,000	3350 7,200	3650 7,850	2250 4,850			*2850 *6,250	1850 4,100	6.94 22'8"
-3.0 m -10.0 ft	kg lb	*7450 *16,700	*7450 *16,700	*6650 *14,350	6150 13,150	*4700 *10,000	3350 7,200	*3000	2300			*2950 *6,400	2250 5,000	6.05 19'8"
-4.5 m -15.0 ft	kg lb			*3450 *7,050	*3450 *7,050							*2050 *4,250	*2050 *4,250	4.49 14'4"

## Reach Boom Lift Capacities – Counterweight: 3.83 mt (8,440 lb) – without Bucket

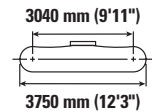
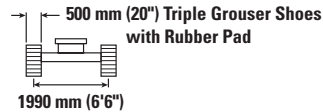
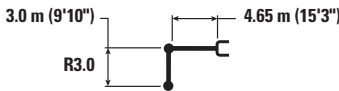

		1.5 m/5.0 ft		3.0 m/10.0 ft		4.5 m/15.0 ft		6.0 m/20.0 ft		7.5 m/25.0 ft		m ft/in		
7.5 m 25.0 ft	kg lb					*2700	*2700					*2600 *5,850	*2600 *5,850	4.54 14'3"
6.0 m 20.0 ft	kg lb					*3450 *7,550	*3450 *7,550	*2400	*2400			*2200 *4,850	*2200 *4,850	6.07 19'8"
4.5 m 15.0 ft	kg lb					*3650 *7,950	*3650 *7,950	*3450 *7,400	2700 5,800			*2050 *4,500	*2050 *4,500	6.96 22'8"
3.0 m 10.0 ft	kg lb			*5850 *12,100	*5850 *12,100	*4800 *10,350	4050 8,700	*3950 *8,550	2600 5,600			*2050 *4,500	1850 4,050	7.44 24'4"
1.5 m 5.0 ft	kg lb			*8750 *18,800	6850 14,700	*5600 *12,050	3750 8,100	3950 8,450	2500 5,350	*2500	1800	*2150 *4,750	1750 3,850	7.59 24'10"
0 m 0 ft	kg lb			*7000 *16,150	6350 13,650	5900 12,600	3500 7,600	3800 8,200	2400 5,100			*2400 *5,250	1750 3,850	7.43 24'4"
-1.5 m -5.0 ft	kg lb	*4300 *9,650	*4300 *9,650	*8500 *18,350	6250 13,400	*5750 12,350	3450 7,400	3750 8,050	2350 5,000			*2850 *6,250	1900 4,200	6.94 22'8"
-3.0 m -10.0 ft	kg lb	*7450 *16,700	*7450 *16,700	*6650 *14,350	6300 13,550	*4700 *10,000	3450 7,400	*3000	2350			*2950 *6,400	2350 5,150	6.05 19'8"
-4.5 m -15.0 ft	kg lb			*3450 *7,050	*3450 *7,050							*2050 *4,250	*2050 *4,250	4.49 14'4"



ISO 10567



\* Indicates that the load is limited by hydraulic lifting capacity rather than tipping load. The above loads are in compliance with hydraulic excavator lift capacity standard ISO 10567:2007. They do not exceed 87% of hydraulic lifting capacity or 75% of tipping load. Weight of all lifting accessories must be deducted from the above lifting capacities. Lifting capacities are based on the machine standing on a firm, uniform supporting surface. The use of a work tool attachment point to handle/lift objects, could affect the machine lift performance.

Lift capacity stays with ±5% for all available track shoes.

Always refer to the appropriate Operation and Maintenance Manual for specific product information.

# 315 Hydraulic Excavator Specifications

## Reach Boom Lift Capacities – Counterweight: 3.83 mt (8,440 lb) – without Bucket

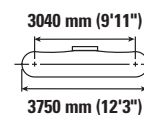
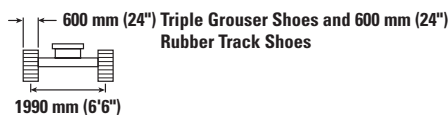
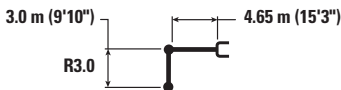

		1.5 m/5.0 ft		3.0 m/10.0 ft		4.5 m/15.0 ft		6.0 m/20.0 ft		7.5 m/25.0 ft		m ft/in		
7.5 m 25.0 ft	kg lb					*2700	*2700					*2600 *5,850	*2600 *5,850	4.54 14'3"
6.0 m 20.0 ft	kg lb					*3450 *7,550	*3450 *7,550	*2400	*2400			*2200 *4,850	*2200 *4,850	6.07 19'8"
4.5 m 15.0 ft	kg lb					*3650 *7,950	*3650 *7,950	*3450 *7,400	2700 5,750			*2050 *4,500	*2050 *4,500	6.96 22'8"
3.0 m 10.0 ft	kg lb			*5850 *12,100	*5850 *12,100	*4800 *10,350	4000 8,600	*3950 *8,550	2600 5,550			*2050 *4,500	1850 4,000	7.44 24'4"
1.5 m 5.0 ft	kg lb			*8750 *18,800	6750 14,550	*5600 *12,050	3750 8,050	3900 8,350	2450 5,300	*2500	1750	*2150 *4,750	1750 3,800	7.59 24'10"
0 m 0 ft	kg lb			*7000 *16,150	6300 13,550	5850 12,500	3500 7,550	3800 8,100	2350 5,050			*2400 *5,250	1750 3,850	7.43 24'4"
-1.5 m -5.0 ft	kg lb	*4300 *9,650	*4300 *9,650	*8500 *18,350	6200 13,300	5700 12,250	3400 7,300	3700 8,000	2300 4,950			*2850 *6,250	1900 4,200	6.94 22'8"
-3.0 m -10.0 ft	kg lb	*7450 *16,700	*7450 *16,700	*6650 *14,350	6250 13,400	*4700 *10,000	3400 7,350	*3000	2350			*2950 *6,400	2300 5,100	6.05 19'8"
-4.5 m -15.0 ft	kg lb			*3450 *7,050	*3450 *7,050							*2050 *4,250	*2050 *4,250	4.49 14'4"

## Reach Boom Lift Capacities – Counterweight: 3.83 mt (8,440 lb) – without Bucket

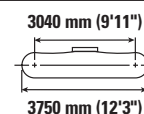
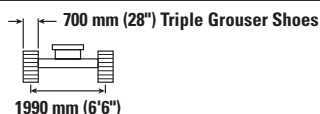
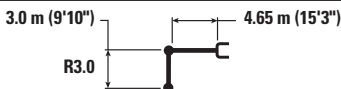

		1.5 m/5.0 ft		3.0 m/10.0 ft		4.5 m/15.0 ft		6.0 m/20.0 ft		7.5 m/25.0 ft		m ft/in		
7.5 m 25.0 ft	kg lb					*2700	*2700					*2600 *5,850	*2600 *5,850	4.54 14'3"
6.0 m 20.0 ft	kg lb					*3450 *7,550	*3450 *7,550	*2400	*2400			*2200 *4,850	*2200 *4,850	6.07 19'8"
4.5 m 15.0 ft	kg lb					*3650 *7,950	*3650 *7,950	*3450 *7,400	2700 5,800			*2050 *4,500	*2050 *4,500	6.96 22'8"
3.0 m 10.0 ft	kg lb			*5850 *12,100	*5850 *12,100	*4800 *10,350	4050 8,700	*3950 *8,550	2600 5,600			*2050 *4,500	1850 4,100	7.44 24'4"
1.5 m 5.0 ft	kg lb			*8750 *18,800	6850 14,750	*5600 *12,050	3800 8,150	3950 8,500	2500 5,350	*2500	1800	*2150 *4,750	1750 3,850	7.59 24'10"
0 m 0 ft	kg lb			*7000 *16,150	6400 13,750	5900 12,650	3550 7,650	3850 8,250	2400 5,150			*2400 *5,250	1800 3,900	7.43 24'4"
-1.5 m -5.0 ft	kg lb	*4300 *9,650	*4300 *9,650	*8500 *18,350	6300 13,450	*5750 *12,400	3450 7,400	3750 8,100	2350 5,000			*2850 *6,250	1950 4,250	6.94 22'8"
-3.0 m -10.0 ft	kg lb	*7450 *16,700	*7450 *16,700	*6650 *14,350	6350 13,600	*4700 *10,000	3450 7,450	*3000	2350			*2950 *6,400	2350 5,200	6.05 19'8"
-4.5 m -15.0 ft	kg lb			*3450 *7,050	*3450 *7,050							*2050 *4,250	*2050 *4,250	4.49 14'4"



ISO 10567



\* Indicates that the load is limited by hydraulic lifting capacity rather than tipping load. The above loads are in compliance with hydraulic excavator lift capacity standard ISO 10567:2007. They do not exceed 87% of hydraulic lifting capacity or 75% of tipping load. Weight of all lifting accessories must be deducted from the above lifting capacities. Lifting capacities are based on the machine standing on a firm, uniform supporting surface. The use of a work tool attachment point to handle/lift objects, could affect the machine lift performance.

Lift capacity stays with ±5% for all available track shoes.

Always refer to the appropriate Operation and Maintenance Manual for specific product information.

# 315 Hydraulic Excavator Specifications

## Reach Boom Lift Capacities – Counterweight: 3.83 mt (8,440 lb) – without Bucket – Blade Up

2500 mm (8'2") Blade

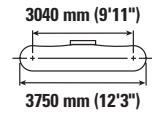
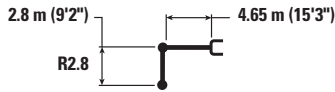

Reach Boom Length	Unit	1.5 m/5.0 ft		3.0 m/10.0 ft		4.5 m/15.0 ft		6.0 m/20.0 ft		Blade Width		m ft/in
		Hydraulic	Tipping	Hydraulic	Tipping	Hydraulic	Tipping	Hydraulic	Tipping	Hydraulic	Tipping	
7.5 m 25.0 ft	kg lb									*2900 *6,500	*2900 *6,500	4.21 13'2"
6.0 m 20.0 ft	kg lb					*3700 *8,100	*3700 *8,100			*2400 *5,250	*2400 *5,250	5.83 18'10"
4.5 m 15.0 ft	kg lb					*4000 *8,700	*4000 *8,700	*3600 *7,650	2750 5,850	*2250 *4,900	2250 *4,900	6.75 22'0"
3.0 m 10.0 ft	kg lb			*6850 *14,750	*6850 *14,750	*4900 *10,650	4100 8,750	3950 8,450	2650 5,650	*2250 *4,900	1950 4,300	7.24 23'8"
1.5 m 5.0 ft	kg lb			*8950 *19,250	6850 14,750	*5700 *12,250	3800 8,200	3800 8,150	2550 5,450	*2350 *5,150	1850 4,050	7.40 24'3"
0 m 0 ft	kg lb			*6700 *15,500	6450 13,900	5700 12,200	3600 7,750	3700 7,950	2450 5,200	*2600 *5,750	1900 4,100	7.24 23'8"
-1.5 m -5.0 ft	kg lb	*4500 *10,050	*4500 *10,050	*8250 *17,900	6400 13,700	5600 12,000	3500 7,550	3650 7,850	2400 5,100	3100 6,850	2050 4,500	6.74 22'0"
-3.0 m -10.0 ft	kg lb	*7950 *17,900	*7950 *17,900	*6300 *13,550	*6300 *13,550	*4450 *9,550	3550 7,600			*2950 *6,450	2550 5,600	5.81 18'10"
-4.5 m -15.0 ft	kg lb									*2100	*2100	3.93 12'9"

## Reach Boom Lift Capacities – Counterweight: 3.83 mt (8,440 lb) – without Bucket – Blade Up

2500 mm (8'2") Blade

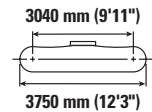
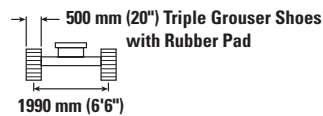
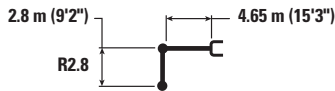

Reach Boom Length	Unit	1.5 m/5.0 ft		3.0 m/10.0 ft		4.5 m/15.0 ft		6.0 m/20.0 ft		Blade Width		m ft/in
		Hydraulic	Tipping	Hydraulic	Tipping	Hydraulic	Tipping	Hydraulic	Tipping	Hydraulic	Tipping	
7.5 m 25.0 ft	kg lb									*2900 *6,500	*2900 *6,500	4.21 13'2"
6.0 m 20.0 ft	kg lb					*3700 *8,100	*3700 *8,100			*2400 *5,250	*2400 *5,250	5.83 18'10"
4.5 m 15.0 ft	kg lb					*4000 *8,700	*4000 *8,700	*3600 *7,650	2800 6,000	*2250 *4,900	*2250 *4,900	6.75 22'0"
3.0 m 10.0 ft	kg lb			*6850 *14,750	*6850 *14,750	*4900 *10,650	4200 9,000	*4050 8,650	2700 5,800	*2250 *4,900	2000 4,450	7.24 23'8"
1.5 m 5.0 ft	kg lb			*8950 *19,250	7050 15,150	*5700 *12,250	3900 8,400	3900 8,400	2600 5,550	*2350 *5,150	1900 4,200	7.40 24'3"
0 m 0 ft	kg lb			*6700 *15,500	6650 14,250	5850 12,550	3700 7,950	3800 8,150	2500 5,350	*2600 *5,750	1950 4,250	7.24 23'8"
-1.5 m -5.0 ft	kg lb	*4500 *10,050	*4500 *10,050	*8250 *17,900	6550 14,050	*5650 *12,200	3600 7,750	3750 8,050	2450 5,250	*3150 *6,900	2100 4,650	6.74 22'0"
-3.0 m -10.0 ft	kg lb	*7950 *17,900	*7950 *17,900	*6300 *13,550	*6300 *13,550	*4450 *9,550	3650 7,800			*2950 *6,450	2600 5,750	5.81 18'10"
-4.5 m -15.0 ft	kg lb									*2100	*2100	3.93 12'9"



ISO 10567



\* Indicates that the load is limited by hydraulic lifting capacity rather than tipping load. The above loads are in compliance with hydraulic excavator lift capacity standard ISO 10567:2007. They do not exceed 87% of hydraulic lifting capacity or 75% of tipping load. Weight of all lifting accessories must be deducted from the above lifting capacities. Lifting capacities are based on the machine standing on a firm, uniform supporting surface. The use of a work tool attachment point to handle/lift objects, could affect the machine lift performance.

Lift capacity stays with ±5% for all available track shoes.

Always refer to the appropriate Operation and Maintenance Manual for specific product information.

# 315 Hydraulic Excavator Specifications

## Reach Boom Lift Capacities – Counterweight: 3.83 mt (8,440 lb) – without Bucket – Blade Up

2600 mm (8'6") Blade

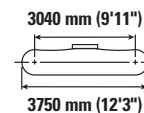
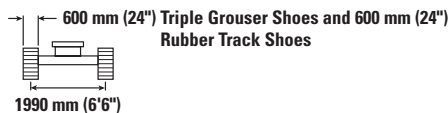

Reach Boom Length	Unit	1.5 m/5.0 ft		3.0 m/10.0 ft		4.5 m/15.0 ft		6.0 m/20.0 ft		Blade Diagram		m ft/in
		Hydraulic	Tipping	Hydraulic	Tipping	Hydraulic	Tipping	Hydraulic	Tipping	Hydraulic	Tipping	
7.5 m 25.0 ft	kg lb									*2900 *6,500	*2900 *6,500	4.21 13'2"
6.0 m 20.0 ft	kg lb					*3700 *8,100	*3700 *8,100			*2400 *5,250	*2400 *5,250	5.83 18'10"
4.5 m 15.0 ft	kg lb					*4000 *8,700	*4000 *8,700	*3600 *7,650	2800 5,950	*2250 *4,900	*2250 *4,900	6.75 22'0"
3.0 m 10.0 ft	kg lb			*6850 *14,750	*6850 *14,750	*4900 *10,650	4150 8,950	4000 8,600	2700 5,800	*2250 *4,900	2000 4,400	7.24 23'8"
1.5 m 5.0 ft	kg lb			*8950 *19,250	7000 15,050	*5700 *12,250	3900 8,350	3850 8,300	2600 5,550	*2350 *5,150	1900 4,150	7.40 24'3"
0 m 0 ft	kg lb			*6700 *15,500	6600 14,150	5800 12,400	3700 7,900	3750 8,100	2500 5,350	*2600 *5,750	1900 4,200	7.24 23'8"
-1.5 m -5.0 ft	kg lb	*4500 *10,050	*4500 *10,050	*8250 *17,900	6500 14,000	*5650 12,200	3600 7,700	3700 7,950	2450 5,250	*3150 *6,900	2100 4,600	6.74 22'0"
-3.0 m -10.0 ft	kg lb	*7950 *17,900	*7950 *17,900	*6300 *13,550	*6300 *13,550	*4450 *9,550	3600 7,750			*2950 *6,450	2600 5,700	5.81 18'10"
-4.5 m -15.0 ft	kg lb									*2100	*2100	3.93 12'9"

## Reach Boom Lift Capacities – Counterweight: 3.83 mt (8,440 lb) – without Bucket – Blade Up

2700 mm (8'10") Blade

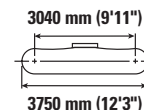
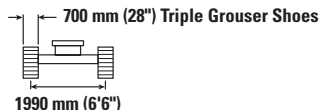

Reach Boom Length	Unit	1.5 m/5.0 ft		3.0 m/10.0 ft		4.5 m/15.0 ft		6.0 m/20.0 ft		Blade Diagram		m ft/in
		Hydraulic	Tipping	Hydraulic	Tipping	Hydraulic	Tipping	Hydraulic	Tipping	Hydraulic	Tipping	
7.5 m 25.0 ft	kg lb									*2900 *6,500	*2900 *6,500	4.21 13'2"
6.0 m 20.0 ft	kg lb					*3700 *8,100	*3700 *8,100			*2400 *5,250	*2400 *5,250	5.83 18'10"
4.5 m 15.0 ft	kg lb					*4000 *8,700	*4000 *8,700	*3600 *7,650	2800 6,050	*2250 *4,900	*2250 *4,900	6.75 22'0"
3.0 m 10.0 ft	kg lb			*6850 *14,750	*6850 *14,750	*4900 *10,650	4200 9,050	*4050 8,700	2750 5,850	*2250 *4,900	2050 4,450	7.24 23'8"
1.5 m 5.0 ft	kg lb			*8950 *19,250	7100 15,250	*5700 *12,250	3950 8,450	3900 8,400	2600 5,600	*2350 *5,150	1900 4,200	7.40 24'3"
0 m 0 ft	kg lb			*6700 *15,500	6700 14,350	5850 12,600	3750 8,000	3800 8,200	2500 5,400	*2600 *5,750	1950 4,250	7.24 23'8"
-1.5 m -5.0 ft	kg lb	*4500 *10,050	*4500 *10,050	*8250 *17,900	6600 14,200	*5650 12,200	3650 7,800	3750 8,100	2450 5,300	*3150 *6,900	2150 4,650	6.74 22'0"
-3.0 m -10.0 ft	kg lb	*7950 *17,900	*7950 *17,900	*6300 *13,550	*6300 *13,550	*4450 *9,550	3650 7,850			*2950 *6,450	2600 5,800	5.81 18'10"
-4.5 m -15.0 ft	kg lb									*2100	*2100	3.93 12'9"



ISO 10567



\* Indicates that the load is limited by hydraulic lifting capacity rather than tipping load. The above loads are in compliance with hydraulic excavator lift capacity standard ISO 10567:2007. They do not exceed 87% of hydraulic lifting capacity or 75% of tipping load. Weight of all lifting accessories must be deducted from the above lifting capacities. Lifting capacities are based on the machine standing on a firm, uniform supporting surface. The use of a work tool attachment point to handle/lift objects, could affect the machine lift performance.

Lift capacity stays with ±5% for all available track shoes.

Always refer to the appropriate Operation and Maintenance Manual for specific product information.

# 315 Hydraulic Excavator Specifications

## Reach Boom Lift Capacities – Counterweight: 3.83 mt (8,440 lb) – without Bucket – Blade Up

2500 mm (8'2") Blade

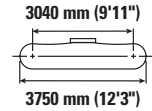
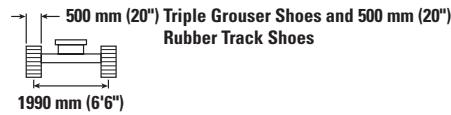
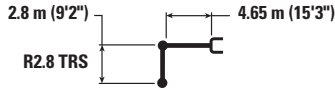

Reach	Unit	1.5 m/5.0 ft		3.0 m/10.0 ft		4.5 m/15.0 ft		6.0 m/20.0 ft		Blade		m ft/in
		Hydraulic	Tipping	Hydraulic	Tipping	Hydraulic	Tipping	Hydraulic	Tipping	Hydraulic	Tipping	
7.5 m 25.0 ft	kg lb									*2850 *6,400	*2850 *6,400	4.21 13'2"
6.0 m 20.0 ft	kg lb					*3700 *8,050	*3700 *8,050			*2350 *5,200	*2350 *5,200	5.83 18'10"
4.5 m 15.0 ft	kg lb					*3950 *8,650	*3950 *8,650	*3600 *7,600	2700 5,750	*2200 *4,850	*2200 *4,850	6.75 22'0"
3.0 m 10.0 ft	kg lb			*6800 *14,600	*6800 *14,600	*4850 *10,550	4050 8,700	3900 8,350	2600 5,600	*2200 *4,850	1900 4,200	7.24 23'8"
1.5 m 5.0 ft	kg lb			*8850 *19,100	6800 14,600	*5600 *12,150	3750 8,100	3750 8,100	2500 5,350	*2350 *5,100	1800 3,950	7.40 24'3"
0 m 0 ft	kg lb			*6650 *15,450	6400 13,700	5650 12,100	3550 7,600	3650 7,850	2400 5,100	*2600 *5,700	1850 4,000	7.24 23'8"
-1.5 m -5.0 ft	kg lb	*4450 *10,000	*4450 *10,000	*8150 *17,700	6300 13,500	5550 11,850	3450 7,400	3600 7,750	2350 5,000	3050 6,750	2000 4,400	6.74 22'0"
-3.0 m -10.0 ft	kg lb	*7950 *17,850	*7950 *17,850	*6250 *13,400	*6250 *13,400	*4400 *9,400	3500 7,450			*2900 *6,300	2500 5,500	5.81 18'10"
-4.5 m -15.0 ft	kg lb									*2050	*2050	3.93 12'9"

## Reach Boom Lift Capacities – Counterweight: 3.83 mt (8,440 lb) – without Bucket – Blade Up

2500 mm (8'2") Blade

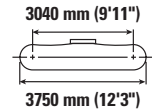
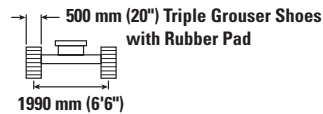
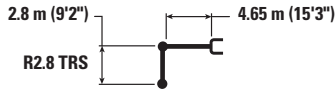

Reach	Unit	1.5 m/5.0 ft		3.0 m/10.0 ft		4.5 m/15.0 ft		6.0 m/20.0 ft		Blade		m ft/in
		Hydraulic	Tipping	Hydraulic	Tipping	Hydraulic	Tipping	Hydraulic	Tipping	Hydraulic	Tipping	
7.5 m 25.0 ft	kg lb									*2850 *6,400	*2850 *6,400	4.21 13'2"
6.0 m 20.0 ft	kg lb					*3700 *8,050	*3700 *8,050			*2350 *5,200	*2350 *5,200	5.83 18'10"
4.5 m 15.0 ft	kg lb					*3950 *8,650	*3950 *8,650	*3600 *7,600	2750 5,900	*2200 *4,850	*2200 *4,850	6.75 22'0"
3.0 m 10.0 ft	kg lb			*6800 *14,600	*6800 *14,600	*4850 *10,550	4150 8,900	*4000 8,600	2650 5,750	*2200 *4,850	2000 4,350	7.24 23'8"
1.5 m 5.0 ft	kg lb			*8850 *19,100	6950 15,000	*5600 *12,150	3850 8,300	3850 8,300	2550 5,500	*2350 *5,100	1850 4,100	7.40 24'3"
0 m 0 ft	kg lb			*6650 *15,450	6550 14,050	5800 12,450	3650 7,850	3750 8,050	2450 5,250	*2600 *5,700	1900 4,150	7.24 23'8"
-1.5 m -5.0 ft	kg lb	*4450 *10,000	*4450 *10,000	*8150 *17,700	6500 13,900	*5600 *12,100	3550 7,650	3700 7,950	2400 5,150	*3100 *6,850	2050 4,550	6.74 22'0"
-3.0 m -10.0 ft	kg lb	*7950 *17,850	*7950 *17,850	*6250 *13,400	*6250 *13,400	*4400 *9,400	3550 7,700			*2900 *6,300	2550 5,650	5.81 18'10"
-4.5 m -15.0 ft	kg lb									*2050	*2050	3.93 12'9"



ISO 10567



\* Indicates that the load is limited by hydraulic lifting capacity rather than tipping load. The above loads are in compliance with hydraulic excavator lift capacity standard ISO 10567:2007. They do not exceed 87% of hydraulic lifting capacity or 75% of tipping load. Weight of all lifting accessories must be deducted from the above lifting capacities. Lifting capacities are based on the machine standing on a firm, uniform supporting surface. The use of a work tool attachment point to handle/lift objects, could affect the machine lift performance.

Lift capacity stays with ±5% for all available track shoes.

Always refer to the appropriate Operation and Maintenance Manual for specific product information.



# 315 Hydraulic Excavator Specifications

## Reach Boom Lift Capacities – Counterweight: 3.83 mt (8,440 lb) – without Bucket – Blade Up

2600 mm (8'6") Blade

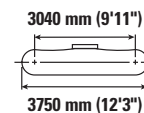
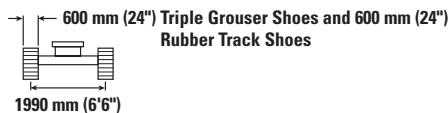
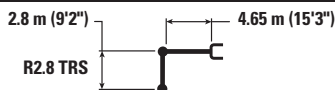

Reach Boom	Unit	1.5 m/5.0 ft		3.0 m/10.0 ft		4.5 m/15.0 ft		6.0 m/20.0 ft		Blade		m ft/in
		Hydraulic	Tipping	Hydraulic	Tipping	Hydraulic	Tipping	Hydraulic	Tipping	Hydraulic	Tipping	
7.5 m 25.0 ft	kg lb									*2850 *6,400	*2850 *6,400	4.21 13'2"
6.0 m 20.0 ft	kg lb					*3700 *8,050	*3700 *8,050			*2350 *5,200	*2350 *5,200	5.83 18'10"
4.5 m 15.0 ft	kg lb					*3950 *8,650	*3950 *8,650	*3600 *7,600	2750 5,900	*2200 *4,850	*2200 *4,850	6.75 22'0"
3.0 m 10.0 ft	kg lb			*6800 *14,600	*6800 *14,600	*4850 *10,550	4100 8,850	3950 8,500	2650 5,700	*2200 *4,850	1950 4,300	7.24 23'8"
1.5 m 5.0 ft	kg lb			*8850 *19,100	6950 14,900	*5600 *12,150	3850 8,250	3850 8,200	2550 5,450	*2350 *5,100	1850 4,050	7.40 24'3"
0 m 0 ft	kg lb			*6650 *15,450	6500 14,000	5750 12,300	3600 7,800	3700 8,000	2450 5,250	*2600 *5,700	1900 4,100	7.24 23'8"
-1.5 m -5.0 ft	kg lb	*4450 *10,000	*4450 *10,000	*8150 *17,700	6450 13,800	*5600 12,050	3550 7,600	3650 7,850	2400 5,150	*3100 *6,850	2050 4,500	6.74 22'0"
-3.0 m -10.0 ft	kg lb	*7950 *17,850	*7950 *17,850	*6250 *13,400	*6250 *13,400	*4400 *9,400	3550 7,650			*2900 *6,300	2550 5,600	5.81 18'10"
-4.5 m -15.0 ft	kg lb									*2050	*2050	3.93 12'9"

## Reach Boom Lift Capacities – Counterweight: 3.83 mt (8,440 lb) – without Bucket – Blade Up

2700 mm (8'10") Blade

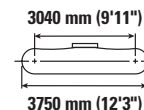
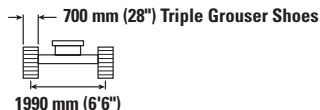
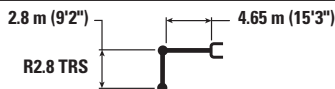

Reach Boom	Unit	1.5 m/5.0 ft		3.0 m/10.0 ft		4.5 m/15.0 ft		6.0 m/20.0 ft		Blade		m ft/in
		Hydraulic	Tipping	Hydraulic	Tipping	Hydraulic	Tipping	Hydraulic	Tipping	Hydraulic	Tipping	
7.5 m 25.0 ft	kg lb									*2850 *6,400	*2850 *6,400	4.21 13'2"
6.0 m 20.0 ft	kg lb					*3700 *8,050	*3700 *8,050			*2350 *5,200	*2350 *5,200	5.83 18'10"
4.5 m 15.0 ft	kg lb					*3950 *8,650	*3950 *8,650	*3600 *7,600	2800 5,950	*2200 *4,850	*2200 *4,850	6.75 22'0"
3.0 m 10.0 ft	kg lb			*6800 *14,600	*6800 *14,600	*4850 *10,550	4150 8,950	*4000 8,600	2700 5,800	*2200 *4,850	2000 4,400	7.24 23'8"
1.5 m 5.0 ft	kg lb			*8850 *19,100	7000 15,100	*5600 *12,150	3900 8,350	3900 8,350	2600 5,500	*2350 *5,100	1900 4,100	7.40 24'3"
0 m 0 ft	kg lb			*6650 *15,450	6600 14,200	5800 12,450	3650 7,900	3750 8,100	2450 5,300	*2600 *5,700	1900 4,150	7.24 23'8"
-1.5 m -5.0 ft	kg lb	*4450 *10,000	*4450 *10,000	*8150 *17,700	6550 14,000	*5600 *12,100	3600 7,700	3700 8,000	2400 5,200	*3100 *6,850	2100 4,600	6.74 22'0"
-3.0 m -10.0 ft	kg lb	*7950 *17,850	*7950 *17,850	*6250 *13,400	*6250 *13,400	*4400 *9,400	3600 7,750			*2900 *6,300	2600 5,700	5.81 18'10"
-4.5 m -15.0 ft	kg lb									*2050	*2050	3.93 12'9"



ISO 10567



\* Indicates that the load is limited by hydraulic lifting capacity rather than tipping load. The above loads are in compliance with hydraulic excavator lift capacity standard ISO 10567:2007. They do not exceed 87% of hydraulic lifting capacity or 75% of tipping load. Weight of all lifting accessories must be deducted from the above lifting capacities. Lifting capacities are based on the machine standing on a firm, uniform supporting surface. The use of a work tool attachment point to handle/lift objects, could affect the machine lift performance.

Lift capacity stays with ±5% for all available track shoes.

Always refer to the appropriate Operation and Maintenance Manual for specific product information.

# 315 Hydraulic Excavator Specifications

## Reach Boom Lift Capacities – Counterweight: 3.83 mt (8,440 lb) – without Bucket – Blade Up

2500 mm (8'2") Blade

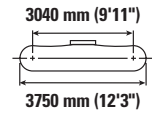
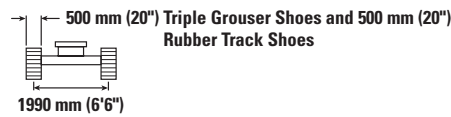
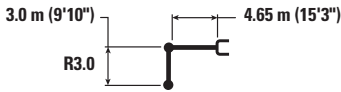

Reach Boom Length	Unit	1.5 m/5.0 ft		3.0 m/10.0 ft		4.5 m/15.0 ft		6.0 m/20.0 ft		7.5 m/25.0 ft		m ft/in		
		ISO	ISO	ISO	ISO	ISO	ISO	ISO	ISO	ISO	ISO			
7.5 m 25.0 ft	kg lb					*2700	*2700					*2600 *5,850	*2600 *5,850	4.54 14'3"
6.0 m 20.0 ft	kg lb					*3450 *7,550	*3450 *7,550	*2400	*2400			*2200 *4,850	*2200 *4,850	6.07 19'8"
4.5 m 15.0 ft	kg lb					*3650 *7,950	*3650 *7,950	*3450	2750			*2050 *4,500	*2050 *4,500	6.96 22'8"
3.0 m 10.0 ft	kg lb			*5850 *12,100	*5850 *12,100	*4800 *10,350	4100 8,850	*3950	2650			*2050 *4,500	1900 4,150	7.44 24'4"
1.5 m 5.0 ft	kg lb			*8750 *18,800	6950 14,950	*5600 *12,050	3850 8,250	3800	2550	*2500	1800	*2150 *4,750	1800 3,900	7.59 24'10"
0 m 0 ft	kg lb			*7000 *16,150	6500 13,950	5700 12,250	3600 7,750	3700	2450			*2400 *5,250	1800 3,950	7.43 24'4"
-1.5 m -5.0 ft	kg lb	*4300 *9,650	*4300 *9,650	*8500 *18,350	6400 13,700	5600 11,950	3500 7,550	3650	2400			*2850 *6,250	1950 4,300	6.94 22'8"
-3.0 m -10.0 ft	kg lb	*7450 *16,700	*7450 *16,700	*6650 *14,350	6450 13,800	*4700 *10,000	3500 7,550	*3000	2400			*2950 *6,400	2400 5,250	6.05 19'8"
-4.5 m -15.0 ft	kg lb			*3450 *7,050	*3450 *7,050							*2050 *4,250	*2050 *4,250	4.49 14'4"

## Reach Boom Lift Capacities – Counterweight: 3.83 mt (8,440 lb) – without Bucket – Blade Up

2500 mm (8'2") Blade

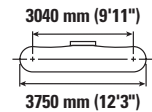
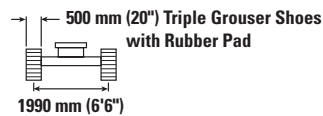
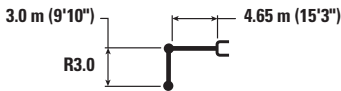

Reach Boom Length	Unit	1.5 m/5.0 ft		3.0 m/10.0 ft		4.5 m/15.0 ft		6.0 m/20.0 ft		7.5 m/25.0 ft		m ft/in		
		ISO	ISO	ISO	ISO	ISO	ISO	ISO	ISO	ISO	ISO			
7.5 m 25.0 ft	kg lb					*2700	*2700					*2600 *5,850	*2600 *5,850	4.54 14'3"
6.0 m 20.0 ft	kg lb					*3450 *7,550	*3450 *7,550	*2400	*2400			*2200 *4,850	*2200 *4,850	6.07 19'8"
4.5 m 15.0 ft	kg lb					*3650 *7,950	*3650 *7,950	*3450	2800			*2050 *4,500	*2050 *4,500	6.96 22'8"
3.0 m 10.0 ft	kg lb			*5850 *12,100	*5850 *12,100	*4800 *10,350	4200 9,050	*3950	2750			*2050 *4,500	1950 4,250	7.44 24'4"
1.5 m 5.0 ft	kg lb			*8750 *18,800	7100 15,300	*5600 *12,050	3950 8,450	3950	2600	*2500	1850	*2150 *4,750	1850 4,050	7.59 24'10"
0 m 0 ft	kg lb			*7000 *16,150	6650 14,300	5850 12,600	3700 8,000	3800	2500			*2400 *5,250	1850 4,050	7.43 24'4"
-1.5 m -5.0 ft	kg lb	*4300 *9,650	*4300 *9,650	*8500 *18,350	6550 14,050	*5750 12,300	3600 7,750	3750	2450			*2850 *6,250	2000 4,450	6.94 22'8"
-3.0 m -10.0 ft	kg lb	*7450 *16,700	*7450 *16,700	*6650 *14,350	6600 14,150	*4700 *10,000	3600 7,750	*3000	2450			*2950 *6,400	2450 5,400	6.05 19'8"
-4.5 m -15.0 ft	kg lb			*3450 *7,050	*3450 *7,050							*2050 *4,250	*2050 *4,250	4.49 14'4"



ISO 10567



\* Indicates that the load is limited by hydraulic lifting capacity rather than tipping load. The above loads are in compliance with hydraulic excavator lift capacity standard ISO 10567:2007. They do not exceed 87% of hydraulic lifting capacity or 75% of tipping load. Weight of all lifting accessories must be deducted from the above lifting capacities. Lifting capacities are based on the machine standing on a firm, uniform supporting surface. The use of a work tool attachment point to handle/lift objects, could affect the machine lift performance.

Lift capacity stays with ±5% for all available track shoes.

Always refer to the appropriate Operation and Maintenance Manual for specific product information.

# 315 Hydraulic Excavator Specifications

## Reach Boom Lift Capacities – Counterweight: 3.83 mt (8,440 lb) – without Bucket – Blade Up

2600 mm (8'6") Blade

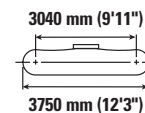
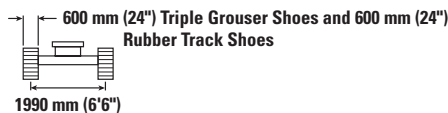

		1.5 m/5.0 ft		3.0 m/10.0 ft		4.5 m/15.0 ft		6.0 m/20.0 ft		7.5 m/25.0 ft		m ft/in		
7.5 m 25.0 ft	kg lb					*2700	*2700					*2600 *5,850	*2600 *5,850	4.54 14'3"
6.0 m 20.0 ft	kg lb					*3450 *7,550	*3450 *7,550	*2400	*2400			*2200 *4,850	*2200 *4,850	6.07 19'8"
4.5 m 15.0 ft	kg lb					*3650 *7,950	*3650 *7,950	*3450 *7,400	2800 6,000			*2050 *4,500	*2050 *4,500	6.96 22'8"
3.0 m 10.0 ft	kg lb			*5850 *12,100	*5850 *12,100	*4800 *10,350	4200 9,000	*3950 *8,550	2700 5,800			*2050 *4,500	1950 4,250	7.44 24'4"
1.5 m 5.0 ft	kg lb			*8750 *18,800	7100 15,250	*5600 *12,050	3900 8,400	3900 8,350	2600 5,550	*2500	1850	*2150 *4,750	1850 4,000	7.59 24'10"
0 m 0 ft	kg lb			*7000 *16,150	6650 14,250	5800 12,450	3700 7,950	3750 8,100	2500 5,350			*2400 *5,250	1850 4,050	7.43 24'4"
-1.5 m -5.0 ft	kg lb	*4300 *9,650	*4300 *9,650	*8500 *18,350	6500 13,950	5700 12,200	3600 7,700	3700 7,950	2450 5,200			*2850 *6,250	2000 4,400	6.94 22'8"
-3.0 m -10.0 ft	kg lb	*7450 *16,700	*7450 *16,700	*6650 *14,350	6550 14,100	*4700 *10,000	3600 7,700	*3000	2450			*2950 *6,400	2450 5,400	6.05 19'8"
-4.5 m -15.0 ft	kg lb			*3450 *7,050	*3450 *7,050							*2050 *4,250	*2050 *4,250	4.49 14'4"

## Reach Boom Lift Capacities – Counterweight: 3.83 mt (8,440 lb) – without Bucket – Blade Up

2700 mm (8'10") Blade

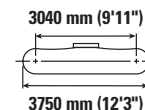
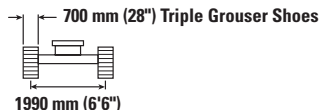

		1.5 m/5.0 ft		3.0 m/10.0 ft		4.5 m/15.0 ft		6.0 m/20.0 ft		7.5 m/25.0 ft		m ft/in		
7.5 m 25.0 ft	kg lb					*2700	*2700					*2600 *5,850	*2600 *5,850	4.54 14'3"
6.0 m 20.0 ft	kg lb					*3450 *7,550	*3450 *7,550	*2400	*2400			*2200 *4,850	*2200 *4,850	6.07 19'8"
4.5 m 15.0 ft	kg lb					*3650 *7,950	*3650 *7,950	*3450 *7,400	2850 6,100			*2050 *4,500	*2050 *4,500	6.96 22'8"
3.0 m 10.0 ft	kg lb			*5850 *12,100	*5850 *12,100	*4800 *10,350	4250 9,100	*3950 *8,550	2750 5,900			*2050 *4,500	1950 4,300	7.44 24'4"
1.5 m 5.0 ft	kg lb			*8750 *18,800	7200 15,450	*5600 *12,050	3950 8,500	3950 8,450	2650 5,650	*2500	1900	*2150 *4,750	1850 4,050	7.59 24'10"
0 m 0 ft	kg lb			*7000 *16,150	6700 14,400	5900 12,600	3750 8,050	3800 8,200	2500 5,400			*2400 *5,250	1850 4,100	7.43 24'4"
-1.5 m -5.0 ft	kg lb	*4300 *9,650	*4300 *9,650	*8500 *18,350	6600 14,150	*5750 12,350	3650 7,800	3750 8,050	2450 5,300			*2850 *6,250	2050 4,450	6.94 22'8"
-3.0 m -10.0 ft	kg lb	*7450 *16,700	*7450 *16,700	*6650 *14,350	6650 14,300	*4700 *10,000	3650 7,800	*3000	2500			*2950 *6,400	2450 5,450	6.05 19'8"
-4.5 m -15.0 ft	kg lb			*3450 *7,050	*3450 *7,050							*2050 *4,250	*2050 *4,250	4.49 14'4"



ISO 10567



\* Indicates that the load is limited by hydraulic lifting capacity rather than tipping load. The above loads are in compliance with hydraulic excavator lift capacity standard ISO 10567:2007. They do not exceed 87% of hydraulic lifting capacity or 75% of tipping load. Weight of all lifting accessories must be deducted from the above lifting capacities. Lifting capacities are based on the machine standing on a firm, uniform supporting surface. The use of a work tool attachment point to handle/lift objects, could affect the machine lift performance.

Lift capacity stays with ±5% for all available track shoes.









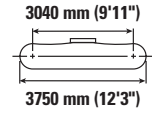
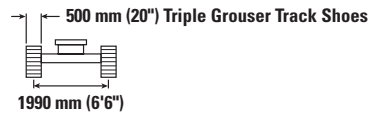
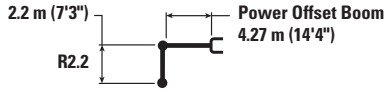

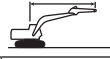
Always refer to the appropriate Operation and Maintenance Manual for specific product information.

# 315 Hydraulic Excavator Specifications

## Power Offset Boom Lift Capacities – Counterweight: 3.83 mt (8,440 lb) – without Bucket – Blade Up

2500 mm (8'2") Blade



		1.5 m/5.0 ft		3.0 m/10.0 ft		4.5 m/15.0 ft		6.0 m/20.0 ft				m ft/in
												
6.0 m 20.0 ft	kg lb			<b>*8,850</b>	<b>*8,850</b>					<b>*2650</b> <b>*5,850</b>	<b>*2650</b> <b>*5,850</b>	4.49 14'4"
4.5 m 15.0 ft	kg lb			<b>*4200</b> <b>*9,150</b>	<b>*4200</b> <b>*9,150</b>	<b>*4250</b> <b>*9,200</b>	<b>4250</b> <b>9,100</b>			<b>*2450</b> <b>*5,400</b>	<b>*2450</b> <b>*5,400</b>	5.64 18'4"
3.0 m 10.0 ft	kg lb			<b>*7350</b> <b>*15,800</b>	<b>*7350</b> <b>*15,800</b>	<b>*5100</b> <b>*11,050</b>	<b>3950</b> <b>8,500</b>	<b>*3650</b> <b>*7,050</b>	<b>2500</b> <b>5,300</b>	<b>*2500</b> <b>*5,500</b>	<b>2300</b> <b>5,100</b>	6.22 20'4"
1.5 m 5.0 ft	kg lb			<b>*8750</b> <b>*18,900</b>	<b>6400</b> <b>13,750</b>	<b>*5600</b> <b>*12,100</b>	<b>3600</b> <b>7,700</b>	<b>3650</b> <b>7,850</b>	<b>2350</b> <b>5,000</b>	<b>*2750</b> <b>*6,050</b>	<b>2100</b> <b>4,650</b>	6.40 20'4"
0 m 0 ft	kg lb			<b>*7800</b> <b>*18,000</b>	<b>5900</b> <b>12,650</b>	<b>5450</b> <b>11,700</b>	<b>3300</b> <b>7,100</b>	<b>3550</b> <b>7,600</b>	<b>2200</b> <b>4,750</b>	<b>*3250</b> <b>*7,200</b>	<b>2100</b> <b>4,650</b>	6.21 20'4"
-1.5 m -5.0 ft	kg lb	<b>*5700</b> <b>*12,700</b>	<b>*5700</b> <b>*12,700</b>	<b>*6850</b> <b>*14,900</b>	<b>5850</b> <b>12,550</b>	<b>*4850</b> <b>*10,450</b>	<b>3200</b> <b>6,900</b>			<b>*3550</b> <b>*7,750</b>	<b>2400</b> <b>5,250</b>	5.62 18'4"
-3.0 m -10.0 ft	kg lb			<b>*4250</b> <b>*9,000</b>	<b>*4250</b> <b>*9,000</b>					<b>*2850</b> <b>*6,150</b>	<b>*2850</b> <b>*6,150</b>	4.45 14'5"



ISO 10567



\* Indicates that the load is limited by hydraulic lifting capacity rather than tipping load. The above loads are in compliance with hydraulic excavator lift capacity standard ISO 10567:2007. They do not exceed 87% of hydraulic lifting capacity or 75% of tipping load. Weight of all lifting accessories must be deducted from the above lifting capacities. Lifting capacities are based on the machine standing on a firm, uniform supporting surface. The use of a work tool attachment point to handle/lift objects, could affect the machine lift performance.

Lift capacity stays with ±5% for all available track shoes.

Always refer to the appropriate Operation and Maintenance Manual for specific product information.

# 315 Hydraulic Excavator Specifications

## Bucket Specifications and Compatibility

	Linkage	Width		Capacity		Weight		Fill	3.83 mt (8,440 lb) Counterweight			
		mm	in	m <sup>3</sup>	yd <sup>3</sup>	kg	lb		Reach Boom			Power Offset Boom*
									R2.8 (9'2")	R2.8 (9'2") TR	R3.0 (9'10")	R2.2 (7'3")
<b>Pin-On (No Quick Coupler)</b>												
General Duty	312	450	18	0.20	0.27	268	591	100	●	●	●	●
	312	600	24	0.31	0.40	320	706	100	●	●	●	●
	312	750	30	0.41	0.54	369	814	100	●	●	●	●
	312	1050	42	0.65	0.84	468	1,031	100	●	●	⊙	●
	312	1200	48	0.76	1.00	508	1,119	100	X	X	X	●
General Duty – Wide Tip	312	450	18	0.27	0.36	317	700	100	●	●	●	●
	312	600	24	0.41	0.53	372	821	100	●	●	●	●
	312	750	30	0.55	0.72	425	936	101	●	●	●	●
	312	900	36	0.71	0.92	478	1,053	100	⊙	⊙	⊙	●
	312	1050	42	0.86	1.13	530	1,168	100	⊖	⊖	⊖	⊙
Severe Duty	312	600	24	0.31	0.40	372	820	90	●	●	●	●
	312	750	30	0.41	0.54	433	954	90	●	●	●	●
	312	900	36	0.53	0.69	495	1,090	90	●	●	●	●
Clean Up	312	1500	60	1.02	1.33	630	1,389	100	○	○	◇	⊖
Ditch Cleaning	312	1200	48	0.57	0.74	388	855	100	●	●	●	●
	312	1500	60	0.74	0.97	455	1,003	100	⊙	⊙	⊙	●
Ditch Cleaning Tilt	312	1200	48	0.48	0.63	563	1,240	100	●	●	●	●
	312	1500	60	0.57	0.75	646	1,424	100	●	●	⊙	●
Maximum load with pin-on (payload + bucket)								kg	1830	1800	1760	2210
								lb	4,041	3,971	3,872	4,873

The above loads are in compliance with hydraulic excavator standard EN474-5:2006 + A3:2013, they do not exceed 87% of hydraulic lifting capacity or 75% of tipping capacity with front linkage fully extended at ground line with bucket curled. Capacity based on ISO 7451:2007.

\*With blade

### Maximum Material Density:

- 2100 kg/m<sup>3</sup> (3,500 lb/yd<sup>3</sup>)
- ⊙ 1800 kg/m<sup>3</sup> (3,000 lb/yd<sup>3</sup>)
- ⊖ 1500 kg/m<sup>3</sup> (2,500 lb/yd<sup>3</sup>)
- 1200 kg/m<sup>3</sup> (2,000 lb/yd<sup>3</sup>)
- ◇ 900 kg/m<sup>3</sup> (1,500 lb/yd<sup>3</sup>)
- X Not Recommended

Caterpillar recommends using appropriate work tools to maximize the value customers receive from our products. Use of work tools, including buckets, which are outside of Caterpillar's recommendations or specifications for weight, dimensions, flows, pressures, etc. may result in less-than-optimal performance, including but not limited to reductions in production, stability, reliability, and component durability. Improper use of a work tool resulting in sweeping, prying, twisting and/or catching of heavy loads will reduce the life of the boom and stick.

(continued on next page)

# 315 Hydraulic Excavator Specifications

## Bucket Specifications and Compatibility (continued)

	Linkage	Width		Capacity		Weight		Fill %	3.83 mt (8,440 lb) Counterweight			
		mm	in	m <sup>3</sup>	yd <sup>3</sup>	kg	lb		Reach Boom			Power Offset Boom*
									R2.8 (9'2")	R2.8 (9'2") TR	R3.0 (9'10")	R3.0 (9'10")
<b>With Cat Pin Grabber Coupler</b>												
General Duty	312	450	18	0.20	0.27	268	591	100	●	●	●	●
	312	600	24	0.31	0.40	320	706	100	●	●	●	●
	312	750	30	0.41	0.54	369	814	100	●	●	●	●
	312	900	36	0.53	0.69	420	927	100	●	●	●	●
	312	1050	42	0.65	0.84	468	1,031	100	⊙	⊙	⊙	●
	312	1200	48	0.76	1.00	508	1,119	100	⊖	⊖	⊖	⊙
General Duty – Wide Tip	312	450	18	0.27	0.36	317	700	100	●	●	●	●
	312	600	24	0.41	0.53	372	821	100	●	●	●	●
	312	750	30	0.55	0.72	425	936	101	●	●	●	●
	312	900	36	0.71	0.92	478	1,053	100	⊖	⊖	⊖	●
	312	1050	42	0.86	1.13	530	1,168	100	○	○	○	⊖
	312	1200	48	1.02	1.33	582	1,283	100	◇	◇	◇	○
Severe Duty	312	600	24	0.31	0.40	372	820	90	●	●	●	●
	312	750	30	0.41	0.54	433	954	90	●	●	●	●
	312	900	36	0.53	0.69	495	1,090	90	●	●	●	●
Clean Up	312	1500	60	1.02	1.33	630	1,389	100	◇	◇	◇	○
Ditch Cleaning	312	1200	48	0.57	0.74	388	855	100	●	●	●	●
	312	1500	60	0.74	0.97	455	1,003	100	⊖	⊖	⊖	●
Ditch Cleaning Tilt	312	1200	48	0.48	0.63	563	1,240	100	●	●	●	●
	312	1500	60	0.57	0.75	646	1,424	100	⊙	⊖	⊖	●
Maximum load with coupler (payload + bucket)								kg	1633	1602	1556	2011
								lb	3,601	3,531	3,431	4,433

The above loads are in compliance with hydraulic excavator standard EN474-5:2006 + A3:2013, they do not exceed 87% of hydraulic lifting capacity or 75% of tipping capacity with front linkage fully extended at ground line with bucket curled. Capacity based on ISO 7451:2007.

\*With blade

### Maximum Material Density:

- 2100 kg/m<sup>3</sup> (3,500 lb/yd<sup>3</sup>)
- ⊙ 1800 kg/m<sup>3</sup> (3,000 lb/yd<sup>3</sup>)
- ⊖ 1500 kg/m<sup>3</sup> (2,500 lb/yd<sup>3</sup>)
- 1200 kg/m<sup>3</sup> (2,000 lb/yd<sup>3</sup>)
- ◇ 900 kg/m<sup>3</sup> (1,500 lb/yd<sup>3</sup>)

Caterpillar recommends using appropriate work tools to maximize the value customers receive from our products. Use of work tools, including buckets, which are outside of Caterpillar's recommendations or specifications for weight, dimensions, flows, pressures, etc. may result in less-than-optimal performance, including but not limited to reductions in production, stability, reliability, and component durability. Improper use of a work tool resulting in sweeping, prying, twisting and/or catching of heavy loads will reduce the life of the boom and stick.

# 315 Hydraulic Excavator Specifications

## Attachments Offering Guide

Not all Attachments are available in all regions. Consult your Cat dealer for configurations available in your region.

Match

Working range front only

### PIN-ON ATTACHMENTS

Counterweight		3.83 mt (8,440 lb)		
Boom Type		Reach		
Stick Length		R2.8 (9'2")	R2.8 TR (9'2")	R3.0 (9'10")
Hydraulic Hammers	H110 GC	✓	✓	✓
	H110 GC S	✓	✓	✓
	H110 S	✓	✓	✓
	H115 GC	✓	✓	✓
	H115 GC S	✓	✓	✓
	H115 S	✓	✓	✓
Compactors (Vibratory Plate)	CVP75	✓	✓	✓
Mulchers	HM2615	✓	✓	✓
	HM3013	✓	✓	✓

### CAT PIN GRABBER COUPLER ATTACHMENTS

Hydraulic Hammers	H110 GC	✓	✓	✓
	H110 GC S	✓	✓	✓
	H110 S	✓	✓	✓
	H115 GC	✓	✓*	✓*
	H115 GC S	✓	✓	✓
	H115 S	✓	✓	✓
Compactors (Vibratory Plate)	CVP75	✓	✓	✓

### TRS10-S60 ATTACHMENTS

Hydraulic Hammers	H110 GC S	✓	✓	✓
	H110 S	✓	✓	✓
Compactors (Vibratory Plate)	CVP75	✓	✓	✓
Mulchers	HM2615	✓	✓	✓

### BOOM-MOUNT ATTACHMENTS

Counterweight		3.83 mt (8,440 lb)		
Boom Type		Reach		
Mobile Scrap and Demolition Shears	S3025 Flat Top	✓		

# 315 Hydraulic Excavator Specifications

## Thumb Specifications

Match

No Match

	Tooth Quantity	Width		Pro Plus		Pro		Stiff Link		Utility	
		mm	in	Pin-on	Cat Pin Grabber	Pin-on	Cat Pin Grabber	Pin-on	Cat Pin Grabber	Pin-on	Cat Pin Grabber
<b>Bucket Type</b>											
General Duty	3	450	18					✓	✓	✓	✓
	4	600	24		✓		✓	✓	✓	✓	✓
	5	750	30	✓	✓	✓	✓	✓	✓	✓	✓
	6	900	36	✓	✓	✓	✓	✓	✓	✓	✓
	7	1050	42	✓	✓	✓	✓	✓	✓	✓	✓
	7	1200	48	✓	✓	✓	✓	✓	✓	✓	✓
General Duty – Wide Tip	4	450	18					✓	✓	✓	✓
	5	600	24					✓	✓	✓	✓
	7	900	36					✓	✓	✓	✓
	8	1074	42					✓	✓	✓	✓
	9	1226	48					✓	✓	✓	✓
Severe Duty	3	600	24		✓		✓	✓	✓	✓	✓
	4	750	30	✓	✓	✓	✓	✓	✓	✓	✓
	5	900	36	✓	✓	✓	✓	✓	✓	✓	✓
	5	1050	42	✓	✓	✓	✓	✓	✓	✓	✓



## Standard and Optional Equipment

Standard and optional equipment may vary. Consult your Cat dealer for details.

	Standard	Optional		Standard	Optional
<b>BOOMS, STICKS AND LINKAGES</b>			<b>CAT TECHNOLOGY</b>		
4.65 m (15'3") Reach boom		✓	Cat Product Link™	✓	
4.27 m (14'4") Power Offset boom		✓	Remote Flash	✓	
3.0 m (9'10") Reach stick		✓	Remote Troubleshoot	✓	
2.8 m (9'2") Reach stick		✓	Cat Grade Connectivity:*		✓
2.8 m (9'2") Thumb Ready stick		✓	– Compatibility with radios and base stations from Trimble, Topcon, and Leica	✓	
2.2 m (7'3") Reach stick		✓	– Capability to install 3D grade systems from Trimble, Topcon, and Leica	✓	
Bucket linkage, without lifting eye, Cat Grade	✓		Cat Grade with 2D and offset memory*	✓	
<b>CAB</b>			Cat Grade with Advanced 2D*		✓
ROPS	✓		Cat Grade with 3D single GNSS*		✓
High-resolution 254 mm (10") LCD touchscreen monitor	✓		Cat Grade with 3D dual GNSS*		✓
Auto bi-level air conditioner	✓		Cat Assist:*	✓	
Jog dial and shortcut keys for monitor control	✓		– Boom Assist		
Keyless push-to-start engine control	✓		– Bucket Assist		
Height-adjustable console	✓		– Swing Assist		
Tilt-up left-side console	✓		– Grade Assist		
Heated air-suspension seat	✓		– Lift Assist		
51 mm (2") seat belt	✓		Cat Payload:*	✓	
Monitor integrated Bluetooth® radio with USB/Aux ports	✓		– Static weigh		
12V DC outlets	✓		– Semiautomatic calibration		
Document storage	✓		– Payload/cycle information		
Overhead storage and rear storage with nets	✓		– USB reporting capability		
Beverage holder	✓		2D E-Fence:	✓	
Cup holder	✓		– E-ceiling		
Openable two-piece front window	✓		– E-floor		
Rear window emergency exit	✓		– E-swing		
Radial wiper with washer	✓		– E-wall		
Openable polycarbonate skylight hatch	✓		– E-cab avoidance		
LED dome light	✓		Auto hammer stop*	✓	
Floor welcome light	✓		Laser catcher*		✓
Roof sunscreen	✓		Work tool recognition	✓	
Roller front sunscreen	✓		Work tool tracking**	✓	
Roller rear sunscreen		✓	<b>ELECTRICAL SYSTEM</b>		
Washable floor mat	✓		Maintenance free battery	✓	
Beacon ready	✓		Centralized electrical disconnect switch	✓	
Auxiliary relay		✓	LED chassis light, left-hand/right-hand boom lights, cab lights	✓	
			Programmable time-delay LED working lights	✓	
			360° lighting		✓

\*Not available for machines equipped with a Power Offset boom.

\*\*Requires PL161 attachment locator on work tool and Bluetooth receiver on machine.

(continued on next page)

# 315 Standard and Optional Equipment

## Standard and Optional Equipment (continued)

Standard and optional equipment may vary. Consult your Cat dealer for details.

	Standard	Optional		Standard	Optional
<b>ENGINE</b>			<b>SERVICE AND MAINTENANCE</b>		
Cat® C3.6 single turbo diesel engine	✓		Grouped engine oil and fuel filters	✓	
Three selectable modes: Power, Smart, Eco	✓		Ground level engine oil dipstick	✓	
One-touch low idle with automatic engine speed control	✓		Scheduled Oil Sampling (S·O·S <sup>SM</sup> ) ports	✓	
Auto engine shutdown	✓		Integrated vehicle health management system		✓
52° C (125° F) high-ambient cooling capacity without de-rate	✓		<b>UNDERCARRIAGE AND STRUCTURES</b>		
-25° C (-13° F) cold start capability	✓		Grease lubricated track link	✓	
Electric fuel priming pump	✓		Center track guiding guards	✓	
Variable speed fan	✓		Bottom guards	✓	
Single fuel filtration system	✓		HD travel motor guards		✓
Sealed double element air filter with integrated pre-cleaner	✓		Travel motor guards		✓
<b>HYDRAULIC SYSTEM</b>			Swivel guard	✓	
Boom and stick regeneration circuits	✓		500 mm (20") triple grouser track shoes		✓
Automatic hydraulic oil warm up	✓		500 mm (20") triple grouser track shoes with rubber pad		✓
Automatic two-speed travel	✓		500 mm (20") rubber track shoes		✓
Electric main control valve	✓		600 mm (24") triple grouser track shoes		✓
Boom and stick drift reduction valve	✓		600 mm (24") rubber track shoes		✓
Swing drive, with fine swing control function	✓		700 mm (28") triple grouser track shoes		✓
Electric boom snubber	✓		2500 mm (8'2") blade		✓
Boom and stick lowering check valves		✓	2600 mm (8'6") blade		✓
Medium-pressure line		✓	2700 mm (8'10") blade		✓
High-pressure line		✓	3.83 mt (8,440 lb) counterweight		✓
Quick coupler line		✓	ISO 15818 tie-down points on base frame	✓	
<b>SAFETY AND SECURITY</b>					
Cat Detect – People Detection		✓			
Cat Command remote control		✓			
Rear and right-side-view cameras		✓			
360° visibility		✓			
Right-hand handrail and hand hold (ISO 2867 compliant)	✓				
Ground level engine shutoff switch	✓				
Swing alarm		✓			
Service platform with anti-skid plate and countersunk bolts	✓				
Signaling/warning horn	✓				
Inspection lighting		✓			

## Dealer Installed Kits and Attachments

Attachments may vary. Consult your Cat dealer for details.

---

### CAB

- Left-hand and right-hand electrical pedal (two-way) for tool control
- Dual exit rear window kit
- Rain protector plus cab light cover
- Front windshield laminated glass (P5A glass, EU demolition regulation)
- Key fob (for use with Bluetooth receiver)

### SAFETY AND SECURITY

- 76 mm (3") retractable seat belt

### GUARDS

- FOGS (not compatible with cab light cover, rain protector)
- Mesh guard full front (not compatible with cab light cover, rain protector)
- Mesh guard lower half front
- Full protecting vandalism guard

# 315 Environmental Declaration

The following information applies to the machine at the time of final manufacture as configured for sale in the regions covered in this document. The content of this declaration is valid as of the date issued; however, content related to machine features and specifications are subject to change without notice. For additional information, please see the machine's Operation and Maintenance Manual.

For more information on sustainability in action and our progress, please visit <https://www.caterpillar.com/en/company/sustainability>.

## Engine

- The Cat® C3.6 engine meets U.S. EPA Tier 4 Final, EU Stage V, and Japan 2014 emission standards.
- Cat diesel engines are required to use ULSD (ultra-low sulfur diesel fuel with 15 ppm of sulfur or less) or ULSD blended with the following lower-carbon intensity fuels up to:
  - ✓ 20% biodiesel FAME (fatty acid methyl ester)\*
  - ✓ 100% renewable diesel, HVO (hydrogenated vegetable oil) and GTL (gas-to-liquid) fuels

Refer to guidelines for successful application. Please consult your Cat dealer or “Caterpillar Machine Fluids Recommendations” (SEBU6250) for details.

\*Engines with no aftertreatment devices can use higher blends, up to 100% biodiesel.

## Air Conditioning System

- The air conditioning system on this machine contains the fluorinated greenhouse gas refrigerant R134a (Global Warming Potential = 1430). The system contains 0.8 kg (1.8 lb) of refrigerant, which has a CO<sub>2</sub> equivalent of 1.144 metric tonnes (1.261 tons).

## Paint

- Based on best available knowledge, the maximum allowable concentration, measured in parts per million (PPM), of the following heavy metals in paint are:
  - Barium < 0.01%
  - Cadmium < 0.01%
  - Chromium < 0.01%
  - Lead < 0.01%

## Sound Performance

ISO 6395:2008 (external) 101 dB(A)

ISO 6396:2008 (inside cab) 71 dB(A)

- When properly installed and maintained, the cab offered by Caterpillar, when tested with doors and windows closed according to ANSI/SAE J1166 OCT98, meets OSHA and MSHA requirements for operator sound exposure limits in effect at time of manufacture.
- Hearing protection may be needed when operating with an open operator station and cab (when not properly maintained or doors/windows open) for extended periods or in a noisy environment.

## Oils and Fluids

- Caterpillar factory fills with ethylene glycol coolants. Cat Diesel Engine Antifreeze/Coolant (DEAC) and Cat Extended Life Coolant (ELC) can be recycled. Consult your Cat dealer for more information.
- Cat Bio HYDO™ Advanced is an EU Ecolabel approved biodegradable hydraulic oil.
- Additional fluids are likely to be present, please consult the Operations and Maintenance Manual or the Application and Installation guide for complete fluid recommendations and maintenance intervals.

## Features and Technology

- The following features and technology may contribute to fuel savings and/or carbon reduction. Features may vary. Consult your Cat dealer for details.
  - Advanced hydraulic systems balance power and efficiency
  - Smart mode matches machine power to digging requirements automatically
  - Eco mode minimizes fuel consumption for light applications
  - One-touch low idle with automatic engine speed control
  - Cat Grade with 2D improves operator efficiency by up to 45%
  - Extended maintenance intervals reduce fluid and filter consumption
  - Remote Flash and Remote Troubleshoot

## Recycling

- The materials included in machines are categorized as below with approximate weight percentage. Because of variations of product configurations, the following values in the table may vary.

Material Type	Weight Percentage
Steel	84.65%
Iron	4.60%
Nonferrous Metal	1.71%
Mixed Metal	0.33%
Mixed-Metal and Nonmetal	2.20%
Plastic	0.07%
Rubber	1.54%
Mixed Nonmetallic	1.33%
Fluid	2.20%
Other	1.37%
Uncategorized	0.00%
Total	100%

- A machine with higher recyclability rate will ensure more efficient usage of valuable natural resources and enhance End-of-Life value of the product. According to ISO 16714 (Earthmoving machinery – Recyclability and recoverability – Terminology and calculation method), recyclability rate is defined as percentage by mass (mass fraction in percent) of the new machine potentially able to be recycled, reused, or both.

All parts in the bill of material are first evaluated by component type based on a list of components defined by the ISO 16714 and Japan CEMA (Construction Equipment Manufacturers Association) standards. Remaining parts are further evaluated for recyclability based on material type.

Because of variations of product configurations, the following value in the table may vary.

Recyclability – 95%

For more complete information on Cat products, dealer services, and industry solutions, visit us on the web at [www.cat.com](http://www.cat.com)

© 2022 Caterpillar  
All rights reserved

Materials and specifications are subject to change without notice. Featured machines in photos may include additional equipment. See your Cat dealer for available options.

CAT, CATERPILLAR, LET'S DO THE WORK, their respective logos, "Caterpillar Corporate Yellow," the "Power Edge" and Cat "Modern Hex" trade dress as well as corporate and product identity used herein, are trademarks of Caterpillar and may not be used without permission.

AEXQ2861-04 (09-2022)  
Replaces AEXQ2861-03  
Build Number: 07D  
(N Am)

