



325

Hydraulic Excavator

Technical Specifications

Configurations and features may vary by region. Please consult your Cat® dealer for availability in your area.

Table of Contents

Specifications	2
Engine	2
Air Conditioning System	2
Swing Mechanism	2
Weights	2
Track	2
Drive	2
Hydraulic System	2
Service Refill Capacities	2
Standards	3
Sound Performance	3
Operating Weights and Ground Pressures	3
Major Component Weights	4
Dimensions	5
Blade Dimensions	6
Working Ranges and Forces	7
Reach Boom Lift Capacities:	
Counterweight: 4.9 mt (10,800 lb)	8
Counterweight: 6.7 mt (14,800 lb)	20
Counterweight: 8.3 mt (18,300 lb)	23
Variable Angle Boom Lift Capacities:	
Counterweight: 4.9 mt (10,800 lb)	29
Counterweight: 6.7 mt (14,800 lb)	35
Attachments Offering Guide	41
Standard and Optional Equipment	77
Dealer Installed Kits and Attachments	79
Cab Options	80
325 Environmental Declaration	81

325 Hydraulic Excavator Specifications

Engine

Engine Model	Cat® C4.4	
Net Power		
ISO 9249	128.5 kW	172 hp
ISO 9249 (DIN)	175 hp (metric)	
Engine Power		
ISO 14396	129.4 kW	174 hp
ISO 14396 (DIN)	176 hp (metric)	
Bore	105 mm	4 in
Stroke	127 mm	5 in
Displacement	4.4 L	269 in ³
Biodiesel capability	Up to B20 ⁽¹⁾	

- Meets U.S. EPA Tier 4 Final, EU Stage V, and Japan 2014 emission standards.
- Recommended for use up to 4500 m (14,760 ft) altitude with engine power derate above 3000 m (9,840 ft).
- Advertised power is tested per the specified standard in effect at the time of manufacture.
- Net power advertised is the power available at the flywheel when the engine is equipped with fan, air intake system, exhaust system and alternator.
- Engine speed at 2,200 rpm.

⁽¹⁾Cat diesel engines are required to use ULSD (ultra-low sulfur diesel fuel with 15 ppm of sulfur or less) or ULSD blended with the following lower-carbon intensity fuels** up to:

- ✓ 20% biodiesel FAME (fatty acid methyl ester)*
- ✓ 100% renewable diesel, HVO (hydrotreated vegetable oil) and GTL (gas-to-liquid) fuels

Refer to guidelines for successful application. Please consult your Cat dealer or “Caterpillar Machine Fluids Recommendations” (SEBU6250) for details.

*Engines with no aftertreatment devices can use higher blends, up to 100% biodiesel (for use of blends higher than 20% biodiesel, consult your Cat dealer).

**Tailpipe greenhouse gas emissions from lower-carbon intensity fuels are essentially the same as traditional fuels.

Air Conditioning System

The air conditioning system on this machine contains the fluorinated greenhouse gas refrigerant R134a (Global Warming Potential = 1430). The system contains 0.8 kg of refrigerant which has a CO₂ equivalent of 1.144 metric tonnes.

Swing Mechanism

Swing Speed	11.12 rpm	
Maximum Swing Torque	82 kN·m	60,300 lbf·ft

Weights

Operating Weight	26 200 kg	57,800 lb
• Long undercarriage, Reach boom, R2.9B1 (9'6") stick, Heavy Duty (HD) 1.19 m ³ (1.56 yd ³) bucket, 600 mm (24") HD triple grouser shoes, 4.9 mt (10,800 lb) counterweight and blade.		
Operating Weight	27 800 kg	61,300 lb
• Long undercarriage, Reach boom, HD R2.9B1 (9'6") stick, HD 1.19 m ³ (1.56 yd ³) bucket, 600 mm (24") HD triple grouser shoes, 8.3 mt (18,300 lb) counterweight.		
Operating Weight	27 000 kg	59,500 lb
• Variable Angle Boom, R2.9 (9'6") stick, General Duty (GD) 1.30 m ³ (1.70 yd ³) bucket, 600 mm (24") HD triple grouser shoes, 6.7 mt (14,800 lb) counterweight.		

Track

Optional Track Shoes Width	600 mm	24 in
Optional Track Shoes Width	700 mm	28 in
Optional Track Shoes Width	790 mm	31 in
Number of Shoes (each side)	49	
Number of Track Rollers (each side)	8	
Number of Carrier Rollers (each side)	2	

Drive

Gradeability	35°/70%	
Maximum Travel Speed	5.7 km/h	3.5 mph
Maximum Drawbar Pull	201 kN	45,232 lbf

Hydraulic System

Main System – Maximum Flow – Implement	429 L/min	113 gal/min
Maximum Pressure – Equipment – Normal	35 000 kPa	5,075 psi
Maximum Pressure – Equipment – Heavy Lift Mode/Auto Dig Boost	38 000 kPa	5,510 psi
Maximum Pressure – Travel	35 000 kPa	5,075 psi
Maximum Pressure – Swing	27 500 kPa	3,988 psi
Auxiliary Pump (optional) – Maximum Flow	50.5 L/min	13 gal/min
Auxiliary Pump for Blade (optional) – Maximum Flow	92.4 L/min	24 gal/min
Maximum Pressure – Auxiliary circuit (optional)	14 000 kPa	2,031 psi
Maximum Pressure – Blade (optional)	24 500 kPa	3,553 psi
Boom Cylinder – Bore	125 mm	5 in
Boom Cylinder – Stroke	1410 mm	56 in
Stick Cylinder – Bore	140 mm	6 in
Stick Cylinder – Stroke	1504 mm	59 in
Bucket Cylinder – Bore	120 mm	5 in
Bucket Cylinder – Stroke	1104 mm	43 in

Service Refill Capacities

Fuel Tank Capacity	313 L	82.7 gal
Cooling System	11.8 L	3.1 gal
Engine Oil (with filter)	15 L	4.0 gal
Swing Drive	5.5 L	1.5 gal
Final Drive (each)	4.5 L	1.1 gal
Hydraulic System (including tank)	230 L	60.8 gal
Hydraulic Tank (including suction pipe)	111 L	29.3 gal
Diesel Exhaust Fluid (DEF) Tank	26 L	6.9 gal

325 Hydraulic Excavator Specifications

Standards

Brakes	ISO 10265:2008
Cab/Rollover Protective Structure (ROPS)	ISO 12117-2:2008
Cab/Operator Protective Guards (OPG) (Optional)	ISO 10262:1998 Level II

Sound Performance

ISO 6395:2008 (external)	97 dB(A)
ISO 6396:2008 (inside cab)	70 dB(A)

- Hearing protection may be needed when operating with an open operator station and cab (when not properly maintained or doors/windows open) for extended periods or in a noisy environment.

Operating Weights and Ground Pressures

	600 mm (24 in) HD Triple Grouser Shoes		700 mm (28 in) HD Triple Grouser Shoes		790 mm (31 in) HD Triple Grouser Shoes	
	Weight	Ground Pressure	Weight	Ground Pressure	Weight	Ground Pressure
	kg (lb)	kPa (psi)	kg (lb)	kPa (psi)	kg (lb)	kPa (psi)
Base Machine Configurations						
Base Frame with Track Rollers and Carrier Rollers						
4.9 mt (10,800 lb) Counterweight + Long Undercarriage Base Machine						
Reach Boom + R2.9B1 (9'6") Stick + 1.19 m ³ (1.56 yd ³) HD Bucket + Blade + AUX lines	26 200 (57,800)	54.3 (8.0)	26 500 (58,400)	47.2 (6.9)	26 900 (59,300)	42.5 (6.2)
Variable Angle Boom + R2.9B1 (9'6") Stick + 1.19 m ³ (1.56 yd ³) HD Bucket + Blade + AUX Lines for Stick	27 500 (60,600)	57.2 (8.3)	27 900 (61,500)	49.7 (7.2)	28 200 (62,200)	44.5 (6.5)
6.7 mt (14,800 lb) Counterweight + Long Undercarriage Base Machine						
Reach Boom + R2.9B1 (9'6") Stick + 1.19 m ³ (1.56 yd ³) HD Bucket + AUX lines	26 200 (57,800)	54.5 (7.9)	26 500 (58,400)	47.2 (6.9)	26 900 (59,300)	42.5 (6.2)
Variable Angle Boom + R2.9B1 (9'6") Stick + 1.30 m ³ (1.70 yd ³) GD Bucket + AUX lines for stick	27 000 (59,500)	56.2 (8.1)	27 300 (60,200)	48.7 (7.1)	27 600 (60,800)	43.6 (6.3)
8.3 mt (18,300 lb) Counterweight + Long Undercarriage Base Machine						
Reach Boom + R2.9B1 (9'6") Stick + 1.19 m ³ (1.56 yd ³) HD Bucket AUX lines	27 800 (61,300)	57.8 (8.4)	28 100 (61,900)	50.1 (7.3)	28 500 (62,800)	45.0 (6.5)

All operating weights include a 90% fuel tank with 75 kg (165 lb) operator.

325 Hydraulic Excavator Specifications

Major Component Weights

	kg	lb
Base Machine Weight (with upper frame, long undercarriage, counterweight, two boom cylinders – does not include boom, stick, bucket, blade, stick cylinder, bucket cylinder, tracks, fuel tank and operator).		
With 4.9 mt (10,800 lb) Counterweight (for use with Reach boom and blade)	17 490 kg	38,540 lb
With 4.9 mt (10,800 lb) Counterweight (for use with Variable Angle boom and blade)	17 850 kg	39,340 lb
With 6.7 mt (14,800 lb) Counterweight (for use with Reach boom)	18 650 kg	41,110 lb
With 6.7 mt (14,800 lb) Counterweight (for use with Variable Angle boom)	18 580 kg	40,960 lb
With 8.3 mt (18,300 lb) Counterweight (for use with Reach boom)	20 250 kg	44,640 lb
Track Shoes:		
600 mm (24") Width, 12.5 mm (0.49") Thick, HD Triple Grouser Track Shoes	3190	7,040
700 mm (28") Width, 12.5 mm (0.49") Thick, HD Triple Grouser Track Shoes	3520	7,770
790 mm (31") Width, 12.5 mm (0.49") Thick, HD Triple Grouser Track Shoes with Step Extension	3860	8,500
For Reach Boom	420	940
For Variable Angle Boom	360	790
Weight of 90% Fuel Tank and 75 kg (165 lb) Operator	310	690
Blades (including lines, cylinders, frame modifications):		
2980 mm (9'9") Blade (for use with 4.9 mt [10,800 lb] counterweight and 600 mm [24"] track shoes)	1150	2,540
3170 mm (10'5") Blade (for use with 4.9 mt [10,800 lb] counterweight and 700 mm [28"] or 790 mm [31"] track shoes)	1190	2,620
Counterweights:		
4.9 mt (10,800 lb) Counterweight	4900	10,800
6.7 mt (14,800 lb) Counterweight	6700	14,800
8.3 mt (18,300 lb) Counterweight	8300	18,300
Swing Frames:		
Swing Frame with Standard Base Frame and SD Track Rollers for 4.9 mt (10,800 lb) Counterweight – for use with Blade	7050	15,530
Swing Frame with Standard Base Frame and SD Track Rollers for 6.7 mt (14,800 lb) Counterweight – without Blade	6960	15,350
Swing Frame with Standard Base Frame and SD Track Rollers for 8.3 mt (18,300 lb) Counterweight – without Blade	6960	15,350
Undercarriages:		
Long Undercarriage without Blade	4560	10,050
Long Undercarriage for use with Blade	5120	11,290
Booms (including lines, pins, stick cylinder):		
Reach Boom 5.7 m (18'8")	1740	3,830
HD Reach Boom 5.7 m (18'8")	1910	4,220
AUX lines (HP + QC)	130	290
Variable Angle Boom (2.7 m [8'10"] Stub + 3.3 m [10'10"] Fore)	2870	6,320
Sticks (including lines, pins, bucket cylinder, bucket linkage):		
Reach Stick R2.9B1 (9'6")	1030	2,270
HD Reach Stick R2.9B1 (9'6")	1140	2,520
AUX lines (HP + QC)	60	130
Buckets (without linkage, with tips and side cutters):		
1.19 m ³ (1.56 yd ³) HD	1040	2,290
1.30 m ³ (1.70 yd ³) GD	880	1,940
Quick Couplers:		
Pin Grabber QC B without Pins	430	940
CW QC B without Pins	250	550

Refer to pages 31-32 for a complete list of bucket options.

325 Hydraulic Excavator Specifications

Dimensions

All dimensions are approximate and may vary depending on bucket selection.

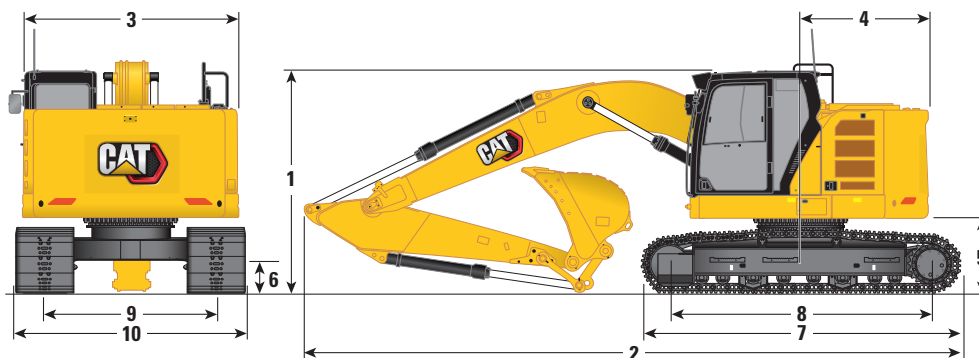

Boom Options	Reach Boom 5.7 m (18'8")		Variable Angle Boom 2.7 m/3.3 m (8'10"/10'10")	
Stick Option	Reach Stick R2.9B1 (9'6")		Reach Stick R2.9B1 (9'6")	
1 Machine Height:				
Cab Height	3080 mm	10'1"	3080 mm	10'1"
Top of GNSS Antenna Height (if installed)	2620 mm	8'7"	2620 mm	8'7"
OPG Height	3220 mm	10'7"	3220 mm	10'7"
Shipping Height without OPG	3210 mm	10'6"	3210 mm	10'6"
Handrail Height	3190 mm	10'5"	3190 mm	10'5"
With Boom/Stick/Bucket Installed	3210 mm	10'6"	3210 mm	10'6"
With Boom/Stick Installed	2980 mm	9'9"	3040 mm	10'0"
With Boom Installed	2530 mm	8'3"	2600 mm	8'6"
With Boom/Stick/Bucket Installed (with auxiliary lines)	3210 mm	10'6"	3209 mm	10'6"
With Boom/Stick Installed (with auxiliary lines)	3210 mm	10'6"	3209 mm	10'6"
With Boom Installed (with auxiliary lines)	2980 mm	9'9"	3040 mm	10'10"
2 Machine Length:				
With Boom/Stick/Bucket Installed (with/without auxiliary lines)	8910 mm	29'3"	9180 mm	30'1"
With Boom/Stick Installed (with/without auxiliary lines)	8850 mm	29'0"	8910 mm	29'3"
With Boom Installed (with/without auxiliary lines)	7780 mm	25'5"	8060 mm	26'5"
With Blade Installed (with auxiliary lines)	9600 mm	31'6"	9870 mm	32'5"
3 Upperframe Width	2990 mm	9'10"	2990 mm	9'10"
4 Tail Swing Radius:				
With 4.9 mt (10,800 lb) Counterweight	1780 mm	5'8"	1780 mm	5'8"
With 6.7 mt (14,800 lb) Counterweight	—	—	1810 mm	5'11"
With 8.3 mt (18,300 lb) Counterweight	1810 mm	5'11"	—	—
5 Counterweight Clearance	980 mm	3'2"	1020 mm	3'4"
6 Ground Clearance	440 mm	1'5"	440 mm	1'5"
7 Track Length	4460 mm	14'7"	4460 mm	14'7"
8 Length to Center of Rollers	3650 mm	12'0"	3650 mm	12'0"
9 Track Gauge	2380 mm	7'10"	2380 mm	7'10"
10 Undercarriage Width:				
600 mm (24") Shoes	2980 mm	9'8"	2980 mm	9'8"
700 mm (28") Shoes	3080 mm	10'1"	3080 mm	10'1"
790 mm (31") Shoes	3170 mm	10'4"	3170 mm	10'4"
Bucket Type	GD		GD	
Bucket Capacity	1.30 m ³	1.70 yd ³	1.30 m ³	1.70 yd ³
Bucket Tip Radius	1700 mm	5'7"	1700 mm	5'7"

325 Hydraulic Excavator Specifications

Blade Dimensions

All dimensions are approximate.

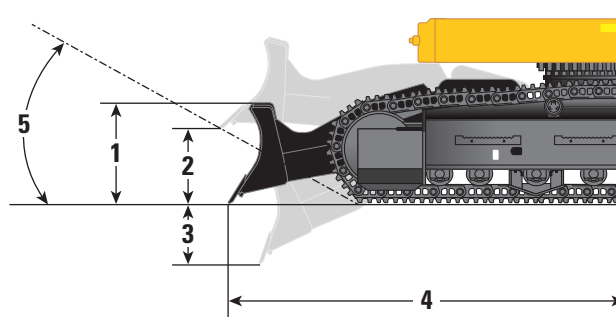

Blade Options	2980 mm (9'8")		3170 mm (10'4")	
Recommended Track Shoe Width	600 mm (24")		700 mm (28")/790 mm (31")	
1 Blade Moldboard Height	696 mm	2'3"	696 mm	2'3"
2 Blade Maximum Cutting Edge Rise	585 mm	1'11"	585 mm	1'11"
3 Blade Minimum Cutting Edge Depth	467 mm	1'6"	467 mm	1'6"
4 Blade Edge from Machine Center	2930 mm	9'7"	2930 mm	9'7"
5 Ramp Angle	28.8°		28.8°	
Blade Down Force (ground level)	151.4 kN	34.0 klbf	151.4 kN	34.0 klbf
Blade Down Force (max)	170.6 kN	38.4 kLbf	170.6 kN	38.4 kLbf

325 Hydraulic Excavator Specifications

Working Ranges and Forces

All dimensions are approximate and may vary depending on bucket selection.

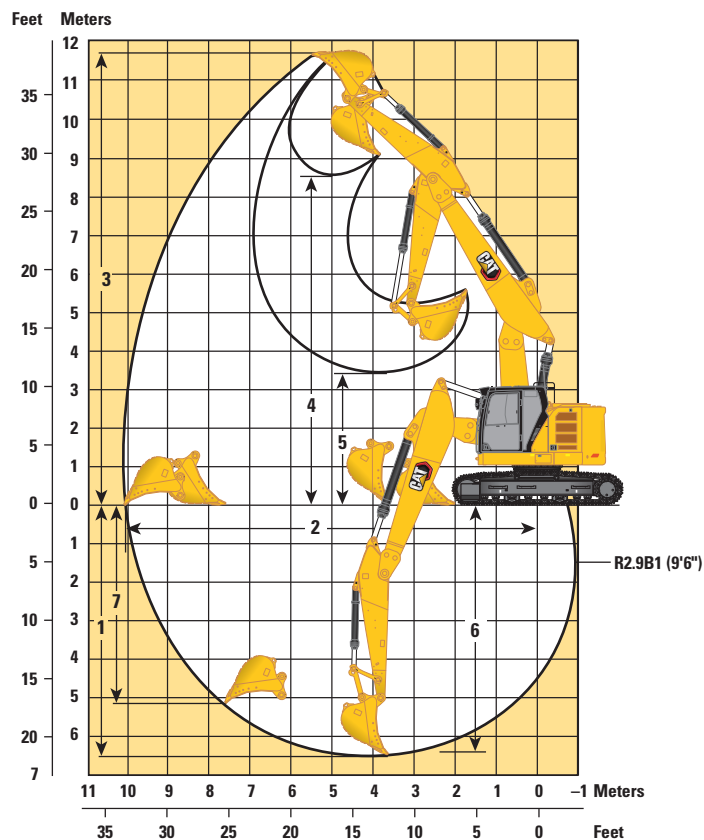
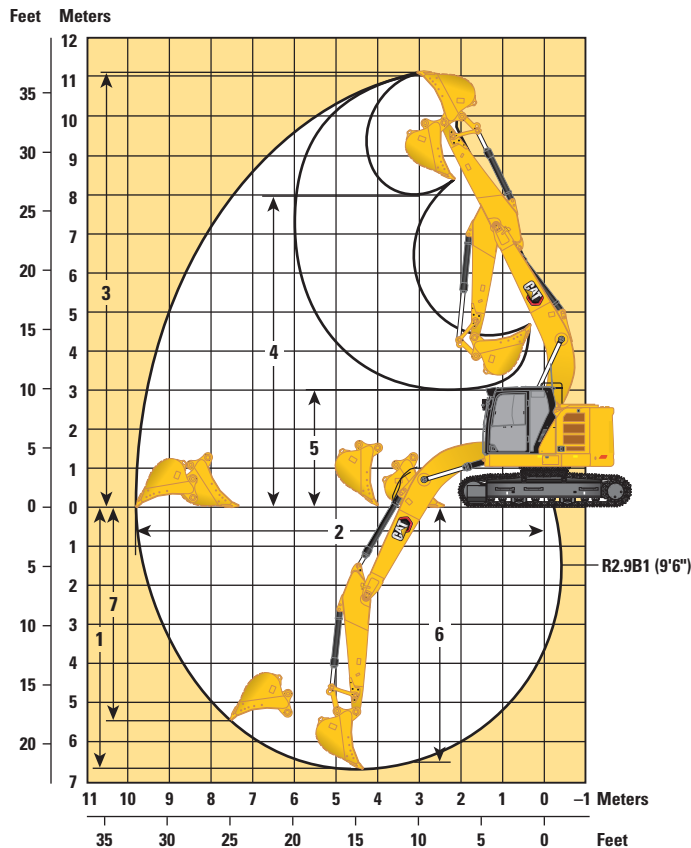

Boom Options

**Reach Boom
5.7 m (18'8")**

**Variable Angle Boom
2.7 m/3.3 m (8'10"/10'10")**

Stick Option

**Reach Stick
R2.9B1 (9'6")**

**Reach Stick
R2.9B1 (9'6")**









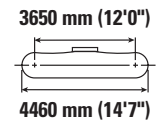
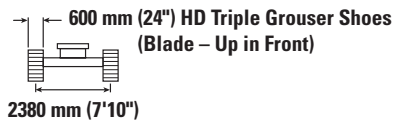
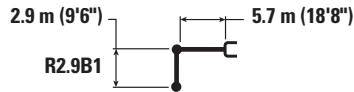



	Reach Boom 5.7 m (18'8")	Variable Angle Boom 2.7 m/3.3 m (8'10"/10'10")
1 Maximum Digging Depth	6700 mm	6520 mm
2 Maximum Reach at Ground Line	9670 mm	9780 mm
3 Maximum Cutting Height	11 090 mm	11 680 mm
4 Maximum Loading Height	7970 mm	8540 mm
5 Minimum Loading Height	3010 mm	3420 mm
6 Maximum Depth Cut for 2440 mm (8'0") Level Bottom	6530 mm	6420 mm
7 Maximum Vertical Wall Digging Depth	5470 mm	5150 mm
Bucket Digging Force (ISO)	141 kN	150 kN
Stick Digging Force (ISO)	107 kN	108 kN
Bucket Digging Force (ISO) – Auto Dig Boost	153 kN	163 kN
Stick Digging Force (ISO) – Auto Dig Boost	116 kN	117 kN
Bucket Type	GD	GD
Bucket Capacity	1.30 m ³	1.30 m ³
Bucket Tip Radius	1698 mm	1698 mm

325 Hydraulic Excavator Specifications

Reach Boom Lift Capacities – Counterweight: 4.9 mt (10,800 lb) – without Bucket, Heavy Lift: On

2980 mm (9'9") Blade



		1500 mm/5'0"		3000 mm/10'0"		4500 mm/15'0"		6000 mm/20'0"		7500 mm/25'0"					
														mm ft/in	
9000 mm 30'0"	kg lb												*5000 *11,350	*5000 *11,350	4500 13'11"
7500 mm 25'0"	kg lb					*6200 *13,650	*6200 *13,650	*5350 *10,150	5350 *10,150				*4200 *9,350	*4200 *9,350	6280 20'2"
6000 mm 20'0"	kg lb					*6650 *14,500	*6650 *14,500	*6400 *14,050	5350 11,450				*3950 *8,700	3800 8,500	7350 23'11"
4500 mm 15'0"	kg lb			*10 650 *22,700	*10 650 *22,700	*8150 *17,600	8000 17,250	*7050 *15,300	5150 11,100	5450 11,700	3650 7,800	*3900 *8,550	3300 7,250	8000 26'1"	
3000 mm 10'0"	kg lb					*10 250 *22,100	7500 16,100	7550 16,250	4900 10,600	5350 11,500	3550 7,600	*4000 *8,800	3000 6,650	8330 27'3"	
1500 mm 5'0"	kg lb					11 550 24,750	7000 15,100	7300 15,700	4700 10,100	5250 11,250	3450 7,400	*4250 *9,350	2950 6,450	8390 27'6"	
0 mm 0'0"	kg lb			*7450 *17,000	*7450 *17,000	11 250 24,100	6750 14,500	7100 15,300	4550 9,750	5150 11,050	3350 7,200	4550 10,050	3000 6,600	8170 26'9"	
-1500 mm -5'0"	kg lb	*7750 *17,300	*7750 *17,300	*12 400 *28,100	*12 400 *27,500	11 150 23,900	6700 14,350	7050 15,150	4500 9,650	5150 11,050	3350 7,200	5000 11,000	3250 7,200	7650 25'0"	
-3000 mm -10'0"	kg lb	*12 900 *28,950	*12 900 *28,950	*15 750 *34,150	13 050 27,950	11 250 24,100	6750 14,550	7100 15,300	4500 9,750			6000 13,350	3900 8,600	6760 22'0"	
-4500 mm -15'0"	kg lb			*11 800 *25,100	*11 800 *25,100	*8600 *18,100	7000 15,050					*6850 *14,950	5550 12,550	5320 17'1"	



ISO 10567:2007



*Indicates that the load is limited by hydraulic lifting capacity rather than tipping load. The above loads are in compliance with hydraulic excavator lift capacity standard ISO 10567:2007. They do not exceed 87% of hydraulic lifting capacity or 75% of tipping load. Weight of all lifting accessories must be deducted from the above lifting capacities. Lifting capacities are based on the machine standing on a firm, uniform supporting surface. The use of a work tool attachment point to handle/lift objects, could affect the machine lift performance.

Lift capacity stays with ±5% for all available track shoes.

Always refer to the appropriate Operation and Maintenance Manual for specific product information.

325 Hydraulic Excavator Specifications

Reach Boom Lift Capacities – Counterweight: 4.9 mt (10,800 lb) – without Bucket, Heavy Lift: On

2980 mm (9'9") Blade

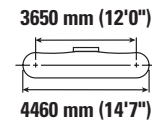
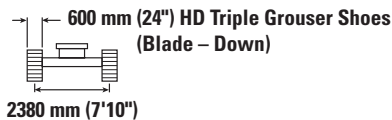

		1500 mm/5'0"		3000 mm/10'0"		4500 mm/15'0"		6000 mm/20'0"		7500 mm/25'0"		mm ft/in		
9000 mm 30'0"	kg lb											*5000 *11,350	*5000 *11,350	4500 13'11"
7500 mm 25'0"	kg lb					*6200 *13,650	*6200 *13,650	*5350 *10,150	*5350 *10,150			*4200 *9,350	*4200 *9,350	6280 20'2"
6000 mm 20'0"	kg lb					*6650 *14,500	*6650 *14,500	*6400 *14,050	5800 12,450			*3950 *8,700	*3950 *8,700	7350 23'11"
4500 mm 15'0"	kg lb			*10 650 *22,700	*10 650 *22,700	*8150 *17,600	*8150 *17,600	*7050 *15,300	5600 12,100	*6300 *12,700	4000 8,500	*3900 *8,550	3600 7,900	8000 26'1"
3000 mm 10'0"	kg lb					*10 250 *22,100	8200 17,700	*8000 *17,350	5400 11,550	*6900 *15,000	3850 8,300	*4000 *8,800	3300 7,250	8330 27'3"
1500 mm 5'0"	kg lb					*12 050 *26,050	7750 16,650	*8900 *19,300	5150 11,050	*7300 *15,900	3750 8,100	*4250 *9,350	3200 7,050	8390 27'6"
0 mm 0'0"	kg lb			*7450 *17,000	*7450 *17,000	*12 850 *27,800	7450 16,050	*9450 *20,500	5000 10,700	*7550 *16,300	3700 7,900	*4750 *10,450	3300 7,200	8170 26'9"
-1500 mm -5'0"	kg lb	*7750 *17,300	*7750 *17,300	*12 400 *28,100	*12 400 *28,100	*12 600 *27,350	7400 15,900	*9400 *20,350	4900 10,600	*7250 *12,700	3650 7,900	*5650 *12,400	3600 7,900	7650 25'0"
-3000 mm -10'0"	kg lb	*12 900 *28,950	*12 900 *28,950	*15 750 *34,150	14 750 31,550	*11 400 *24,600	7500 16,100	*8450 *18,150	4950 10,700			*7100 *15,650	4250 9,450	6760 22'0"
-4500 mm -15'0"	kg lb			*11 800 *25,100	*11 800 *25,100	*8600 *18,100	7700 16,650					*6850 *14,950	6100 13,800	5320 17'1"



ISO 10567:2007



*Indicates that the load is limited by hydraulic lifting capacity rather than tipping load. The above loads are in compliance with hydraulic excavator lift capacity standard ISO 10567:2007. They do not exceed 87% of hydraulic lifting capacity or 75% of tipping load. Weight of all lifting accessories must be deducted from the above lifting capacities. Lifting capacities are based on the machine standing on a firm, uniform supporting surface. The use of a work tool attachment point to handle/lift objects, could affect the machine lift performance.

Lift capacity stays with ±5% for all available track shoes.









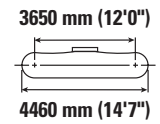
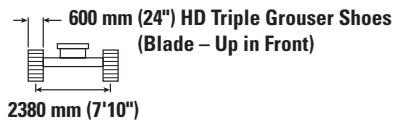
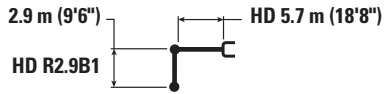



Always refer to the appropriate Operation and Maintenance Manual for specific product information.

325 Hydraulic Excavator Specifications

Reach Boom Lift Capacities – Counterweight: 4.9 mt (10,800 lb) – without Bucket, Heavy Lift: On

2980 mm (9'9") Blade



		1500 mm/5'0"		3000 mm/10'0"		4500 mm/15'0"		6000 mm/20'0"		7500 mm/25'0"					
														mm ft/in	
9000 mm 30'0"	kg lb												*5000 *11,300	*5000 *11,300	4500 13'11"
7500 mm 25'0"	kg lb					*6150 *13,500	*6150 *13,500	*5350 *10,100	5300 *10,100				*4200 *9,300	*4200 *9,300	6280 20'2"
6000 mm 20'0"	kg lb					*6600 *14,350	*6600 *14,350	*6300 *13,850	5300 11,350				*3900 *8,650	3750 8,350	7350 23'11"
4500 mm 15'0"	kg lb			*10 600 *22,500	*10 600 *22,500	*8050 *17,400	8000 17,200	*6950 *15,100	5100 10,950	5400 11,600	3600 7,650	*3850 *8,500	3200 7,100	8000 26'1"	
3000 mm 10'0"	kg lb					*10 100 *21,800	7400 15,900	7500 16,100	4850 10,400	5300 11,350	3450 7,450	*4000 *8,750	2950 6,450	8330 27'3"	
1500 mm 5'0"	kg lb					11 400 24,450	6850 14,750	7200 15,500	4600 9,850	5150 11,050	3350 7,200	*4250 *9,300	2850 6,250	8390 27'6"	
0 mm 0'0"	kg lb			*7400 *16,950	*7400 *16,950	11 050 23,750	6600 14,150	7000 15,050	4400 9,500	5050 10,850	3250 7,000	4500 9,850	2900 6,350	8170 26'9"	
-1500 mm -5'0"	kg lb	*7700 *17,250	*7700 *17,250	*12 350 *28,050	*12 350 *26,800	11 000 23,550	6500 14,000	6950 14,900	4350 9,350	5050 10,850	3250 6,950	4900 10,800	3150 6,950	7650 25'0"	
-3000 mm -10'0"	kg lb	*12 900 *28,900	*12 900 *28,900	*15 450 *33,500	12 750 27,300	11 100 23,750	6600 14,150	7000 15,050	4400 9,450			5900 13,100	3800 8,400	6760 22'0"	
-4500 mm -15'0"	kg lb			*11 500 *24,550	*11 500 *24,550	*8400 *17,700	6850 14,750					*6650 *14,600	5450 12,300	5320 17'1"	



ISO 10567:2007



*Indicates that the load is limited by hydraulic lifting capacity rather than tipping load. The above loads are in compliance with hydraulic excavator lift capacity standard ISO 10567:2007. They do not exceed 87% of hydraulic lifting capacity or 75% of tipping load. Weight of all lifting accessories must be deducted from the above lifting capacities. Lifting capacities are based on the machine standing on a firm, uniform supporting surface. The use of a work tool attachment point to handle/lift objects, could affect the machine lift performance.

Lift capacity stays with ±5% for all available track shoes.

Always refer to the appropriate Operation and Maintenance Manual for specific product information.

325 Hydraulic Excavator Specifications

Reach Boom Lift Capacities – Counterweight: 4.9 mt (10,800 lb) – without Bucket, Heavy Lift: On

2980 mm (9'9") Blade

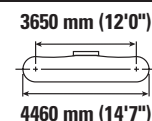
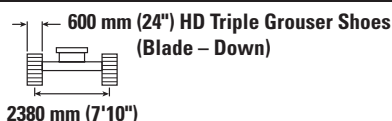

		1500 mm/5'0"		3000 mm/10'0"		4500 mm/15'0"		6000 mm/20'0"		7500 mm/25'0"		mm ft/in		
9000 mm 30'0"	kg lb											*5000 *11,300	*5000 *11,300	4500 13'11"
7500 mm 25'0"	kg lb					*6150 *13,500	*6150 *13,500	*5350 *10,100	*5350 *10,100			*4200 *9,300	*4200 *9,300	6280 20'2"
6000 mm 20'0"	kg lb					*6600 *14,350	*6600 *14,350	*6300 *13,850	5750 12,350			*3900 *8,650	*3900 *8,650	7350 23'11"
4500 mm 15'0"	kg lb			*10 600 *22,500	*10 600 *22,500	*8050 *17,400	*8050 *17,400	*6950 *15,100	5550 11,950	*6300 *12,650	3900 8,350	*3850 *8,500	3500 7,750	8000 26'1"
3000 mm 10'0"	kg lb					*10 100 *21,800	8100 17,500	*7900 *17,050	5300 11,400	*6800 *14,750	3800 8,150	*4000 *8,750	3200 7,050	8330 27'3"
1500 mm 5'0"	kg lb					*11 850 *25,650	7600 16,350	*8750 *19,000	5050 10,850	*7200 *15,600	3650 7,900	*4250 *9,300	3100 6,850	8390 27'6"
0 mm 0'0"	kg lb			*7400 *16,950	*7400 *16,950	*12 650 *27,350	7300 15,700	*9300 *20,150	4850 10,450	*7400 *16,000	3600 7,700	*4700 *10,400	3200 7,000	8170 26'9"
-1500 mm -5'0"	kg lb	*7700 *17,250	*7700 *17,250	*12 350 *28,050	*12 350 *28,050	*12 400 *26,850	7200 15,500	*9250 *20,000	4800 10,300	*7100 *12,650	3550 7,650	*5600 *12,350	3500 7,650	7650 25'0"
-3000 mm -10'0"	kg lb	*12 900 *28,900	*12 900 *28,900	*15 450 *33,500	14 450 30,900	*11 200 *24,150	7300 15,700	*8300 *17,800	4850 10,450			*6950 *15,300	4150 9,200	6760 22'0"
-4500 mm -15'0"	kg lb			*11 500 *24,550	*11 500 *24,550	*8400 *17,700	7550 16,300					*6650 *14,600	6000 13,550	5320 17'1"



ISO 10567:2007



*Indicates that the load is limited by hydraulic lifting capacity rather than tipping load. The above loads are in compliance with hydraulic excavator lift capacity standard ISO 10567:2007. They do not exceed 87% of hydraulic lifting capacity or 75% of tipping load. Weight of all lifting accessories must be deducted from the above lifting capacities. Lifting capacities are based on the machine standing on a firm, uniform supporting surface. The use of a work tool attachment point to handle/lift objects, could affect the machine lift performance.

Lift capacity stays with ±5% for all available track shoes.









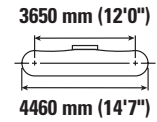
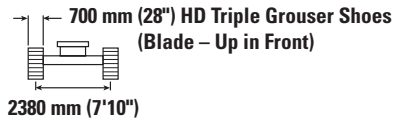
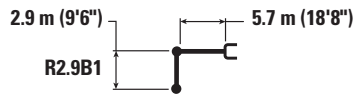



Always refer to the appropriate Operation and Maintenance Manual for specific product information.

325 Hydraulic Excavator Specifications

Reach Boom Lift Capacities – Counterweight: 4.9 mt (10,800 lb) – without Bucket, Heavy Lift: On

3170 mm (10'5") Blade



		1500 mm/5'0"		3000 mm/10'0"		4500 mm/15'0"		6000 mm/20'0"		7500 mm/25'0"					
														mm ft/in	
9000 mm 30'0"	kg lb												*5000 *11,350	*5000 *11,350	4500 13'11"
7500 mm 25'0"	kg lb					*6200 *13,650	*6200 *13,650	*5350 *10,150	*5350 *10,150				*4200 *9,350	*4200 *9,350	6280 20'2"
6000 mm 20'0"	kg lb					*6650 *14,500	*6650 *14,500	*6400 *14,050	5400 11,600				*3950 *8,700	3850 8,600	7350 23'11"
4500 mm 15'0"	kg lb			*10 650 *22,700	*10 650 *22,700	*8150 *17,600	8150 17,500	*7050 *15,300	5250 11,250	5550 11,900	3700 7,950		*3900 *8,550	3350 7,350	8000 26'1"
3000 mm 10'0"	kg lb					*10 250 *22,100	7600 16,350	7650 16,450	5000 10,750	5450 11,650	3600 7,750		*4000 *8,800	3050 6,750	8330 27'3"
1500 mm 5'0"	kg lb					11 700 25,100	7100 15,300	7400 15,900	4750 10,250	5300 11,400	3500 7,500		*4250 *9,350	3000 6,550	8390 27'6"
0 mm 0'0"	kg lb			*7450 *17,000	*7450 *17,000	11 400 24,450	6850 14,750	7200 15,500	4600 9,900	5200 11,200	3400 7,350		4650 10,200	3050 6,700	8170 26'9"
-1500 mm -5'0"	kg lb	*7750 *17,300	*7750 *17,300	*12 400 *28,100	*12 400 *27,950	11 300 24,250	6800 14,600	7150 15,350	4550 9,800	5200 11,200	3400 7,300		5050 11,200	3300 7,300	7650 25'0"
-3000 mm -10'0"	kg lb	*12 900 *28,950	*12 900 *28,950	*15 750 *34,150	13 250 28,350	*11 400 24,450	6850 14,750	7200 15,500	4600 9,900				6100 13,500	3950 8,750	6760 22'0"
-4500 mm -15'0"	kg lb			*11 800 *25,100	*11 800 *25,100	*8600 *18,100	7100 15,300						*6850 *14,950	5650 12,750	5320 17'1"



ISO 10567:2007



*Indicates that the load is limited by hydraulic lifting capacity rather than tipping load. The above loads are in compliance with hydraulic excavator lift capacity standard ISO 10567:2007. They do not exceed 87% of hydraulic lifting capacity or 75% of tipping load. Weight of all lifting accessories must be deducted from the above lifting capacities. Lifting capacities are based on the machine standing on a firm, uniform supporting surface. The use of a work tool attachment point to handle/lift objects, could affect the machine lift performance.

Lift capacity stays with ±5% for all available track shoes.

Always refer to the appropriate Operation and Maintenance Manual for specific product information.

325 Hydraulic Excavator Specifications

Reach Boom Lift Capacities – Counterweight: 4.9 mt (10,800 lb) – without Bucket, Heavy Lift: On

3170 mm (10'5") Blade

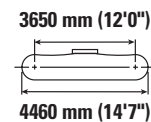
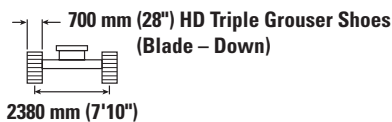
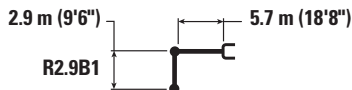

		1500 mm/5'0"		3000 mm/10'0"		4500 mm/15'0"		6000 mm/20'0"		7500 mm/25'0"		mm ft/in		
9000 mm 30'0"	kg lb											*5000 *11,350	*5000 *11,350	4500 13'11"
7500 mm 25'0"	kg lb					*6200 *13,650	*6200 *13,650	*5350 *10,150	*5350 *10,150			*4200 *9,350	*4200 *9,350	6280 20'2"
6000 mm 20'0"	kg lb					*6650 *14,500	*6650 *14,500	*6400 *14,050	6100 13,050			*3950 *8,700	*3950 *8,700	7350 23'11"
4500 mm 15'0"	kg lb			*10 650 *22,700	*10 650 *22,700	*8150 *17,600	*8150 *17,600	*7050 *15,300	5900 12,700	*6300 *12,700	4200 8,950	*3900 *8,550	3750 8,300	8000 26'1"
3000 mm 10'0"	kg lb					*10 250 *22,100	8650 18,700	*8000 *17,350	5650 12,200	*6900 *15,000	4100 8,750	*4000 *8,800	3500 7,650	8330 27'3"
1500 mm 5'0"	kg lb					*12 050 *26,050	8200 17,600	*8900 *19,300	5450 11,700	*7300 *15,900	3950 8,500	*4250 *9,350	3400 7,450	8390 27'6"
0 mm 0'0"	kg lb			*7450 *17,000	*7450 *17,000	*12 850 *27,800	7900 17,050	*9450 *20,500	5250 11,350	*7550 *16,300	3900 8,350	*4750 *10,450	3450 7,600	8170 26'9"
-1500 mm -5'0"	kg lb	*7750 *17,300	*7750 *17,300	*12 400 *28,100	*12 400 *28,100	*12 600 *27,350	7850 16,850	*9400 *20,350	5200 11,200	*7250 *12,700	3850 8,350	*5650 *12,400	3800 8,300	7650 25'0"
-3000 mm -10'0"	kg lb	*12 900 *28,950	*12 900 *28,950	*15 750 *34,150	*15 750 *33,700	*11 400 *24,600	7900 17,050	*8450 *18,150	5250 11,300			*7100 *15,650	4500 10,000	6760 22'0"
-4500 mm -15'0"	kg lb			*11 800 *25,100	*11 800 *25,100	*8600 *18,100	8150 17,600					*6850 *14,950	6450 14,550	5320 17'1"



ISO 10567:2007



*Indicates that the load is limited by hydraulic lifting capacity rather than tipping load. The above loads are in compliance with hydraulic excavator lift capacity standard ISO 10567:2007. They do not exceed 87% of hydraulic lifting capacity or 75% of tipping load. Weight of all lifting accessories must be deducted from the above lifting capacities. Lifting capacities are based on the machine standing on a firm, uniform supporting surface. The use of a work tool attachment point to handle/lift objects, could affect the machine lift performance.

Lift capacity stays with ±5% for all available track shoes.

Always refer to the appropriate Operation and Maintenance Manual for specific product information.

325 Hydraulic Excavator Specifications

Reach Boom Lift Capacities – Counterweight: 4.9 mt (10,800 lb) – without Bucket, Heavy Lift: On

3170 mm (10'5") Blade

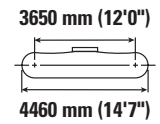
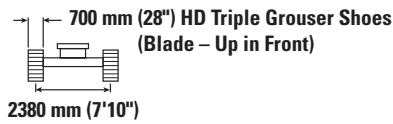
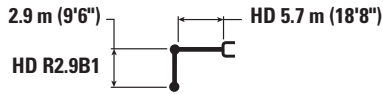

		1500 mm/5'0"		3000 mm/10'0"		4500 mm/15'0"		6000 mm/20'0"		7500 mm/25'0"		mm ft/in		
9000 mm 30'0"	kg lb											*5000 *11,300	*5000 *11,300	4500 13'11"
7500 mm 25'0"	kg lb					*6150 *13,500	*6150 *13,500	*5350 *10,100	*5350 *10,100			*4200 *9,300	*4200 *9,300	6280 20'2"
6000 mm 20'0"	kg lb					*6600 *14,350	*6600 *14,350	*6300 *13,850	5350 11,500			*3900 *8,650	3800 8,450	7350 23'11"
4500 mm 15'0"	kg lb			*10 600 *22,500	*10 600 *22,500	*8050 *17,400	*8050 *17,400	*6950 *15,100	5200 11,150	5500 11,750	3650 7,800	*3850 *8,500	3250 7,200	8000 26'1"
3000 mm 10'0"	kg lb					*10 100 *21,800	7500 16,150	7600 16,300	4900 10,600	5350 11,500	3500 7,550	*4000 *8,750	3000 6,550	8330 27'3"
1500 mm 5'0"	kg lb					11 550 24,800	6950 15,000	7300 15,700	4650 10,050	5200 11,200	3400 7,300	*4250 *9,300	2900 6,350	8390 27'6"
0 mm 0'0"	kg lb			*7400 *16,950	*7400 *16,950	11 250 24,050	6700 14,400	7100 15,250	4500 9,650	5150 11,000	3300 7,100	4550 10,000	2950 6,500	8170 26'9"
-1500 mm -5'0"	kg lb	*7700 *17,250	*7700 *17,250	*12 350 *28,050	*12 350 *27,250	11 150 23,850	6600 14,200	7050 15,100	4400 9,500	5100 11,000	3300 7,100	5000 10,950	3200 7,100	7650 25'0"
-3000 mm -10'0"	kg lb	*12 900 *28,900	*12 900 *28,900	*15 450 *33,500	12 950 27,750	*11 200 24,100	6700 14,400	7100 15,250	4450 9,650			6000 13,300	3850 8,500	6760 22'0"
-4500 mm -15'0"	kg lb			*11 500 *24,550	*11 500 *24,550	*8400 *17,700	6950 15,000					*6650 *14,600	5550 12,500	5320 17'1"



ISO 10567:2007



*Indicates that the load is limited by hydraulic lifting capacity rather than tipping load. The above loads are in compliance with hydraulic excavator lift capacity standard ISO 10567:2007. They do not exceed 87% of hydraulic lifting capacity or 75% of tipping load. Weight of all lifting accessories must be deducted from the above lifting capacities. Lifting capacities are based on the machine standing on a firm, uniform supporting surface. The use of a work tool attachment point to handle/lift objects, could affect the machine lift performance.

Lift capacity stays with ±5% for all available track shoes.

Always refer to the appropriate Operation and Maintenance Manual for specific product information.

325 Hydraulic Excavator Specifications

Reach Boom Lift Capacities – Counterweight: 4.9 mt (10,800 lb) – without Bucket, Heavy Lift: On

3170 mm (10'5") Blade

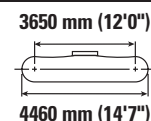

		1500 mm/5'0"		3000 mm/10'0"		4500 mm/15'0"		6000 mm/20'0"		7500 mm/25'0"		mm ft/in		
9000 mm 30'0"	kg lb											*5000 *11,300	*5000 *11,300	4500 13'11"
7500 mm 25'0"	kg lb					*6150 *13,500	*6150 *13,500	*5350 *10,100	*5350 *10,100			*4200 *9,300	*4200 *9,300	6280 20'2"
6000 mm 20'0"	kg lb					*6600 *14,350	*6600 *14,350	*6300 *13,850	6050 12,950			*3900 *8,650	*3900 *8,650	7350 23'11"
4500 mm 15'0"	kg lb			*10 600 *22,500	*10 600 *22,500	*8050 *17,400	*8050 *17,400	*6950 *15,100	5850 12,600	*6300 *12,650	4100 8,800	*3850 *8,500	3700 8,150	8000 26'1"
3000 mm 10'0"	kg lb					*10 100 *21,800	8600 18,500	*7900 *17,050	5600 12,000	*6800 *14,750	4000 8,600	*4000 *8,750	3400 7,450	8330 27'3"
1500 mm 5'0"	kg lb					*11 850 *25,650	8050 17,300	*8750 *19,000	5300 11,450	*7200 *15,600	3900 8,350	*4250 *9,300	3300 7,250	8390 27'6"
0 mm 0'0"	kg lb			*7400 *16,950	*7400 *16,950	*12 650 *27,350	7750 16,650	*9300 *20,150	5150 11,050	*7400 *16,000	3800 8,150	*4700 *10,400	3350 7,400	8170 26'9"
-1500 mm -5'0"	kg lb	*7700 *17,250	*7700 *17,250	*12 350 *28,050	*12 350 *28,050	*12 400 *26,850	7650 16,500	*9250 *20,000	5050 10,900	*7100 *12,650	3750 8,100	*5600 *12,350	3700 8,100	7650 25'0"
-3000 mm -10'0"	kg lb	*12 900 *28,900	*12 900 *28,900	*15 450 *33,500	*15 450 *33,100	*11 200 *24,150	7750 16,650	*8300 *17,800	5150 11,050			*6950 *15,300	4400 9,750	6760 22'0"
-4500 mm -15'0"	kg lb			*11 500 *24,550	*11 500 *24,550	*8400 *17,700	8000 17,300					*6650 *14,600	6350 14,300	5320 17'1"



ISO 10567:2007



*Indicates that the load is limited by hydraulic lifting capacity rather than tipping load. The above loads are in compliance with hydraulic excavator lift capacity standard ISO 10567:2007. They do not exceed 87% of hydraulic lifting capacity or 75% of tipping load. Weight of all lifting accessories must be deducted from the above lifting capacities. Lifting capacities are based on the machine standing on a firm, uniform supporting surface. The use of a work tool attachment point to handle/lift objects, could affect the machine lift performance.

Lift capacity stays with ±5% for all available track shoes.

Always refer to the appropriate Operation and Maintenance Manual for specific product information.

325 Hydraulic Excavator Specifications

Reach Boom Lift Capacities – Counterweight: 4.9 mt (10,800 lb) – without Bucket, Heavy Lift: On

3170 mm (10'5") Blade

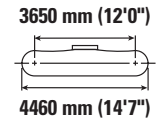
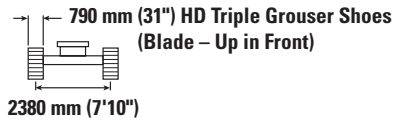
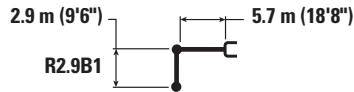

		1500 mm/5'0"		3000 mm/10'0"		4500 mm/15'0"		6000 mm/20'0"		7500 mm/25'0"		mm ft/in		
9000 mm 30'0"	kg lb											*5000 *11,350	*5000 *11,350	4500 13'11"
7500 mm 25'0"	kg lb					*6200 *13,650	*6200 *13,650	*5350 *10,150	*5350 *10,150			*4200 *9,350	*4200 *9,350	6280 20'2"
6000 mm 20'0"	kg lb					*6650 *14,500	*6650 *14,500	*6400 *14,050	5450 11,750			*3950 *8,700	3950 *8,700	7350 23'11"
4500 mm 15'0"	kg lb			*10 650 *22,700	*10 650 *22,700	*8150 *17,600	*8150 *17,600	*7050 *15,300	5300 11,400	5600 12,050	3750 8,050	*3900 *8,550	3400 7,450	8000 26'1"
3000 mm 10'0"	kg lb					*10 250 *22,100	7700 16,550	7750 16,700	5050 10,900	5500 11,850	3650 7,850	*4000 *8,800	3100 6,850	8330 27'3"
1500 mm 5'0"	kg lb					11 850 25,450	7200 15,550	7500 16,150	4850 10,400	5400 11,550	3550 7,600	*4250 *9,350	3000 6,650	8390 27'6"
0 mm 0'0"	kg lb			*7450 *17,000	*7450 *17,000	11 550 24,800	6950 14,950	7350 15,750	4700 10,050	5300 11,400	3450 7,450	4700 10,350	3100 6,800	8170 26'9"
-1500 mm -5'0"	kg lb	*7750 *17,300	*7750 *17,300	*12 400 *28,100	*12 400 *28,100	11 500 24,600	6900 14,800	7250 15,600	4600 9,950	5300 11,350	3450 7,450	5150 11,350	3350 7,400	7650 25'0"
-3000 mm -10'0"	kg lb	*12 900 *28,950	*12 900 *28,950	*15 750 *34,150	13 450 28,750	*11 400 *24,600	6950 15,000	7300 15,750	4650 10,050			6200 13,750	4000 8,900	6760 22'0"
-4500 mm -15'0"	kg lb			*11 800 *25,100	*11 800 *25,100	*8600 *18,100	7200 15,500					*6850 *14,950	5750 12,950	5320 17'1"



ISO 10567:2007



*Indicates that the load is limited by hydraulic lifting capacity rather than tipping load. The above loads are in compliance with hydraulic excavator lift capacity standard ISO 10567:2007. They do not exceed 87% of hydraulic lifting capacity or 75% of tipping load. Weight of all lifting accessories must be deducted from the above lifting capacities. Lifting capacities are based on the machine standing on a firm, uniform supporting surface. The use of a work tool attachment point to handle/lift objects, could affect the machine lift performance.

Lift capacity stays with ±5% for all available track shoes.

Always refer to the appropriate Operation and Maintenance Manual for specific product information.

325 Hydraulic Excavator Specifications

Reach Boom Lift Capacities – Counterweight: 4.9 mt (10,800 lb) – without Bucket, Heavy Lift: On

3170 mm (10'5") Blade

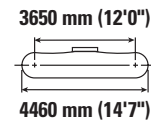
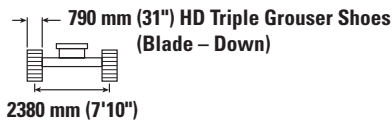

		1500 mm/5'0"		3000 mm/10'0"		4500 mm/15'0"		6000 mm/20'0"		7500 mm/25'0"		3170 mm (10'5") Blade		
		kg	lb	kg	lb	kg	lb	kg	lb	kg	lb	kg	lb	mm ft/in
9000 mm 30'0"	kg											*5000	*5000	4500
	lb											*11,350	*11,350	13'11"
7500 mm 25'0"	kg					*6200	*6200	*5350	*5350			*4200	*4200	6280
	lb					*13,650	*13,650	*10,150	*10,150			*9,350	*9,350	20'2"
6000 mm 20'0"	kg					*6650	*6650	*6400	6150			*3950	*3950	7350
	lb					*14,500	*14,500	*14,050	13,200			*8,700	*8,700	23'11"
4500 mm 15'0"	kg			*10 650	*10 650	*8150	*8150	*7050	6000	*6300	4250	*3900	3800	8000
	lb			*22,700	*22,700	*17,600	*17,600	*15,300	12,850	*12,700	9,100	*8,550	8,450	26'1"
3000 mm 10'0"	kg					*10 250	8800	*8000	5750	*6900	4150	*4000	3550	8330
	lb					*22,100	18,900	*17,350	12,350	*15,000	8,900	*8,800	7,750	27'3"
1500 mm 5'0"	kg					*12 050	8300	*8900	5500	*7300	4000	*4250	3450	8390
	lb					*26,050	17,850	*19,300	11,850	*15,900	8,650	*9,350	7,550	27'6"
0 mm 0'0"	kg			*7450	*7450	*12 850	8050	*9450	5350	*7550	3950	*4750	3500	8170
	lb			*17,000	*17,000	*27,800	17,250	*20,500	11,500	*16,300	8,500	*10,450	7,750	26'9"
-1500 mm -5'0"	kg	*7750	*7750	*12 400	*12 400	*12 600	7950	*9400	5300	*7250	3950	*5650	3850	7650
	lb	*17,300	*17,300	*28,100	*28,100	*27,350	17,100	*20,350	11,350	*12,700	8,450	*12,400	8,450	25'0"
-3000 mm -10'0"	kg	*12 900	*12 900	*15 750	*15 750	*11 400	8050	*8450	5350			*7100	4550	6760
	lb	*28,950	*28,950	*34,150	*34,150	*24,600	17,300	*18,150	11500			*15,650	10,150	22'0"
-4500 mm -15'0"	kg			*11 800	*11 800	*8600	8300					*6850	6550	5320
	lb			*25,100	*25,100	*18,100	17,850					*14,950	14,750	17'1"



ISO 10567:2007



*Indicates that the load is limited by hydraulic lifting capacity rather than tipping load. The above loads are in compliance with hydraulic excavator lift capacity standard ISO 10567:2007. They do not exceed 87% of hydraulic lifting capacity or 75% of tipping load. Weight of all lifting accessories must be deducted from the above lifting capacities. Lifting capacities are based on the machine standing on a firm, uniform supporting surface. The use of a work tool attachment point to handle/lift objects, could affect the machine lift performance.

Lift capacity stays with ±5% for all available track shoes.









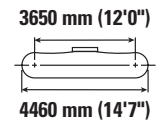
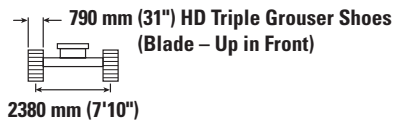
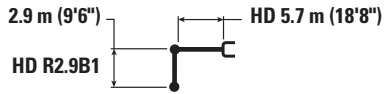



Always refer to the appropriate Operation and Maintenance Manual for specific product information.

325 Hydraulic Excavator Specifications

Reach Boom Lift Capacities – Counterweight: 4.9 mt (10,800 lb) – without Bucket, Heavy Lift: On

3170 mm (10'5") Blade



		1500 mm/5'0"		3000 mm/10'0"		4500 mm/15'0"		6000 mm/20'0"		7500 mm/25'0"						
														mm ft/in		
9000 mm 30'0"	kg lb													*5000 *11,300	*5000 *11,300	4500 13'11"
7500 mm 25'0"	kg lb					*6150 *13,500	*6150 *13,500	*5350 *10,100	*5350 *10,100					*4200 *9,300	*4200 *9,300	6280 20'2"
6000 mm 20'0"	kg lb					*6600 *14,350	*6600 *14,350	*6300 *13,850	5450 11,650					*3900 *8,650	3850 8,600	7350 23'11"
4500 mm 15'0"	kg lb			*10 600 *22,500	*10 600 *22,500	*8050 *17,400	*8050 *17,400	*6950 *15,100	5250 11,250	5550 11,900	3700 7,900			*3850 *8,500	3300 7,300	8000 26'1"
3000 mm 10'0"	kg lb					*10 100 *21,800	7600 16,350	7700 16,550	5000 10,700	5450 11,650	3550 7,650			*4000 *8,750	3050 6,650	8330 27'3"
1500 mm 5'0"	kg lb					11 750 25,200	7050 15,200	7400 15,950	4750 10,200	5300 11,400	3450 7,400			*4250 *9,300	2950 6,450	8390 27'6"
0 mm 0'0"	kg lb			*7400 *16,950	*7400 *16,950	11 400 24,450	6800 14,600	7200 15,500	4550 9,800	5200 11,200	3350 7,250			4600 10,150	3000 6,600	8170 26'9"
-1500 mm -5'0"	kg lb	*7700 *17,250	*7700 *17,250	*12 350 *28,050	*12 350 *27,650	11 300 24,250	6700 14,450	7150 15,350	4500 9,650	5200 11,150	3350 7,200			5050 11,150	3250 7,200	7650 25'0"
-3000 mm -10'0"	kg lb	*12 900 *28,900	*12 900 *28,900	*15 450 *33,500	13 150 28,150	*11 200 *24,150	6800 14,600	7200 15,500	4550 9,800					6100 13,500	3900 8,650	6760 22'0"
-4500 mm -15'0"	kg lb			*11 500 *24,550	*11 500 *24,550	*8400 *17,700	7050 15,200							*6650 *14,600	5600 12,650	5320 17'1"



ISO 10567:2007



*Indicates that the load is limited by hydraulic lifting capacity rather than tipping load. The above loads are in compliance with hydraulic excavator lift capacity standard ISO 10567:2007. They do not exceed 87% of hydraulic lifting capacity or 75% of tipping load. Weight of all lifting accessories must be deducted from the above lifting capacities. Lifting capacities are based on the machine standing on a firm, uniform supporting surface. The use of a work tool attachment point to handle/lift objects, could affect the machine lift performance.

Lift capacity stays with ±5% for all available track shoes.

Always refer to the appropriate Operation and Maintenance Manual for specific product information.

325 Hydraulic Excavator Specifications

Reach Boom Lift Capacities – Counterweight: 4.9 mt (10,800 lb) – without Bucket, Heavy Lift: On

3170 mm (10'5") Blade

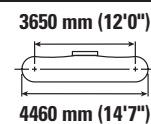
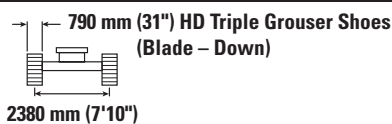

		1500 mm/5'0"		3000 mm/10'0"		4500 mm/15'0"		6000 mm/20'0"		7500 mm/25'0"		mm ft/in		
9000 mm 30'0"	kg lb											*5000 *11,300	*5000 *11,300	4500 13'11"
7500 mm 25'0"	kg lb					*6150 *13,500	*6150 *13,500	*5350 *10,100	*5350 *10,100			*4200 *9,300	*4200 *9,300	6280 20'2"
6000 mm 20'0"	kg lb					*6600 *14,350	*6600 *14,350	*6300 *13,850	6100 13,100			*3900 *8,650	*3900 *8,650	7350 23'11"
4500 mm 15'0"	kg lb			*10 600 *22,500	*10 600 *22,500	*8050 *17,400	*8050 *17,400	*6950 *15,100	5950 12,750	*6300 *12,650	4150 8,950	*3850 *8,500	3750 8,300	8000 26'1"
3000 mm 10'0"	kg lb					*10 100 *21,800	8700 18,700	*7900 *17,050	5650 12,200	*6800 *14,750	4050 8,700	*4000 *8,750	3450 7,600	8330 27'3"
1500 mm 5'0"	kg lb					*11 850 *25,650	8150 17,550	*8750 *19,000	5400 11,600	*7200 *15,600	3950 8,450	*4250 *9,300	3350 7,350	8390 27'6"
0 mm 0'0"	kg lb			*7400 *16,950	*7400 *16,950	*12 650 *27,350	7850 16,900	*9300 *20,150	5200 11,250	*7400 *16,000	3850 8,250	*4700 *10,400	3450 7,500	8170 26'9"
-1500 mm -5'0"	kg lb	*7700 *17,250	*7700 *17,250	*12 350 *28,050	*12 350 *28,050	*12 400 *26,850	7800 16,700	*9250 *20,000	5150 11,100	*7100 *12,650	3800 8,250	*5600 *12,350	3750 8,200	7650 25'0"
-3000 mm -10'0"	kg lb	*12 900 *28,900	*12 900 *28,900	*15 450 *33,500	*15 450 *33,500	*11 200 *24,150	7850 16,900	*8300 *17,800	5200 11,200			*6950 *15,300	4450 9,900	6760 22'0"
-4500 mm -15'0"	kg lb			*11 500 *24,550	*11 500 *24,550	*8400 *17,700	8150					*6650 *14,600	6400 14,500	5320 17'1"



ISO 10567:2007



*Indicates that the load is limited by hydraulic lifting capacity rather than tipping load. The above loads are in compliance with hydraulic excavator lift capacity standard ISO 10567:2007. They do not exceed 87% of hydraulic lifting capacity or 75% of tipping load. Weight of all lifting accessories must be deducted from the above lifting capacities. Lifting capacities are based on the machine standing on a firm, uniform supporting surface. The use of a work tool attachment point to handle/lift objects, could affect the machine lift performance.

Lift capacity stays with ±5% for all available track shoes.

Always refer to the appropriate Operation and Maintenance Manual for specific product information.

325 Hydraulic Excavator Specifications

Reach Boom Lift Capacities – Counterweight: 6.7 mt (14,800 lb) – without Bucket, Heavy Lift: On

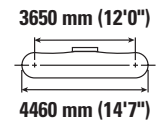
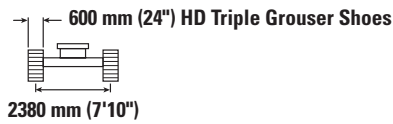
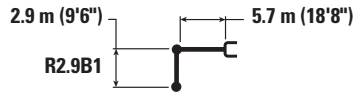

		1500 mm/5'0"		3000 mm/10'0"		4500 mm/15'0"		6000 mm/20'0"		7500 mm/25'0"		mm ft/in		
9000 mm 30'0"	kg lb											*5000 *11,300	*5000 *11,300	4500 13'11"
7500 mm 25'0"	kg lb					*6150 *13,600	*6150 *13,600	*5350 *10,100	*5350 *10,100			*4200 *9,300	*4200 *9,300	6280 20'2"
6000 mm 20'0"	kg lb					*6650 *14,500	*6650 *14,500	*6400 *14,000	5700 12,300			*3900 *8,650	*3900 *8,650	7350 23'11"
4500 mm 15'0"	kg lb			*10 650 *22,700	*10 650 *22,700	*8150 *17,600	*8150 *17,600	*7050 *15,300	5550 11,950	6250 *12,650	3950 8,450	*3900 *8,500	3550 7,850	8000 26'1"
3000 mm 10'0"	kg lb					*10 300 *22,150	8050 17,400	*8000 *17,350	5350 11,450	6100 13,150	3850 8,300	*4000 *8,750	3300 7,250	8330 27'3"
1500 mm 5'0"	kg lb					*12 100 *26,100	7600 16,400	8350 17,950	5100 11,000	6000 12,900	3750 8,050	*4250 *9,300	3200 7,000	8390 27'6"
0 mm 0'0"	kg lb			*7400 *16,950	*7400 *16,950	*12 850 27,650	7350 15,850	8200 17,600	4950 10,650	5900 12,750	3650 7,900	*4750 *10,400	3300 7,200	8170 26'9"
-1500 mm -5'0"	kg lb	*7750 *17,250	*7750 *17,250	*12 350 *28,050	*12 350 *28,050	*12 650 *27,400	7300 15,700	8100 17,450	4900 10,500	5900 *12,700	3650 7,850	*5600 *12,350	3550 7,850	7650 25'0"
-3000 mm -10'0"	kg lb	*12 900 *28,900	*12 900 *28,900	*15 800 *34,250	14 200 30,400	*11 400 *24,650	7350 15,850	8150 17,550	4950 10,650			6900 15,300	4250 9,400	6760 22'0"
-4500 mm -15'0"	kg lb			*11 800 *25,200	*11 800 *25,200	*8600 *18,150	7600 16,350					*6850 *15,000	6050 13,650	5320 17'1"



ISO 10567:2007



*Indicates that the load is limited by hydraulic lifting capacity rather than tipping load. The above loads are in compliance with hydraulic excavator lift capacity standard ISO 10567:2007. They do not exceed 87% of hydraulic lifting capacity or 75% of tipping load. Weight of all lifting accessories must be deducted from the above lifting capacities. Lifting capacities are based on the machine standing on a firm, uniform supporting surface. The use of a work tool attachment point to handle/lift objects, could affect the machine lift performance.

Lift capacity stays with ±5% for all available track shoes.

Always refer to the appropriate Operation and Maintenance Manual for specific product information.

325 Hydraulic Excavator Specifications

Reach Boom Lift Capacities – Counterweight: 6.7 mt (14,800 lb) – without Bucket, Heavy Lift: On

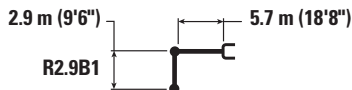

R2.9B1

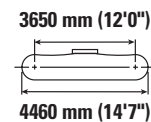
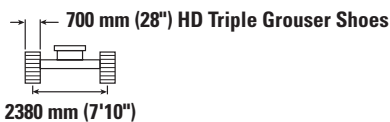

		1500 mm/5'0"		3000 mm/10'0"		4500 mm/15'0"		6000 mm/20'0"		7500 mm/25'0"		mm ft/in		
9000 mm 30'0"	kg lb											*5000 *11,300	*5000 *11,300	4500 13'11"
7500 mm 25'0"	kg lb					*6150 *13,600	*6150 *13,600	*5350 *10,100	*5350 *10,100			*4200 *9,300	*4200 *9,300	6280 20'2"
6000 mm 20'0"	kg lb					*6650 *14,500	*6650 *14,500	*6400 *14,000	5800 12,450			*3900 *8,650	*3900 *8,650	7350 23'11"
4500 mm 15'0"	kg lb			*10 650 *22,700	*10 650 *22,700	*8150 *17,600	*8150 *17,600	*7050 *15,300	5600 12,100	*6300 *12,650	4000 8,600	*3900 *8,500	3600 7,950	8000 26'1"
3000 mm 10'0"	kg lb					*10 300 *22,150	8150 17,600	*8000 *17,350	5400 11,600	6200 13,350	3900 8,400	*4000 *8,750	3350 7,350	8330 27'3"
1500 mm 5'0"	kg lb					*12 100 *26,100	7700 16,600	8450 18,200	5150 11,150	6100 13,100	3800 8,150	*4250 *9,300	3250 7,100	8390 27'6"
0 mm 0'0"	kg lb			*7400 *16,950	*7400 *16,950	*12 850 *27,850	7450 16,050	8300 17,800	5000 10,800	6000 12,900	3700 8,000	*4750 *10,400	3300 7,300	8170 26'9"
-1500 mm -5'0"	kg lb	*7750 *17,250	*7750 *17,250	*12 350 *28,050	*12 350 *28,050	*12 650 *27,400	7400 15,900	8200 17,650	4950 10,650	6000 *12,700	3700 7,950	*5600 *12,350	3600 7,950	7650 25'0"
-3000 mm -10'0"	kg lb	*12 900 *28,900	*12 900 *28,900	*15 800 *34,250	14 400 30,800	*11 400 *24,650	7450 16,050	8250 17,800	5000 10,800			7000 15,500	4300 9,550	6760 22'0"
-4500 mm -15'0"	kg lb			*11 800 *25,200	*11 800 *25,200	*8600 *18,150	7700 16,600					*6850 *15,000	6100 13,800	5320 17'1"



ISO 10567:2007



*Indicates that the load is limited by hydraulic lifting capacity rather than tipping load. The above loads are in compliance with hydraulic excavator lift capacity standard ISO 10567:2007. They do not exceed 87% of hydraulic lifting capacity or 75% of tipping load. Weight of all lifting accessories must be deducted from the above lifting capacities. Lifting capacities are based on the machine standing on a firm, uniform supporting surface. The use of a work tool attachment point to handle/lift objects, could affect the machine lift performance.

Lift capacity stays with ±5% for all available track shoes.

Always refer to the appropriate Operation and Maintenance Manual for specific product information.

325 Hydraulic Excavator Specifications

Reach Boom Lift Capacities – Counterweight: 6.7 mt (14,800 lb) – without Bucket, Heavy Lift: On

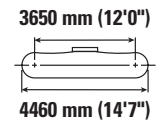
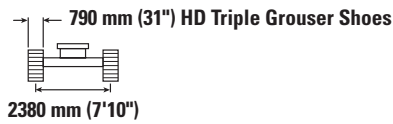
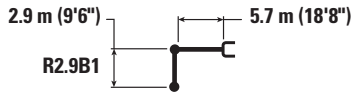

Reach mm ft/in	kg lb	1500 mm/5'0"		3000 mm/10'0"		4500 mm/15'0"		6000 mm/20'0"		7500 mm/25'0"		mm ft/in		
		kg lb	kg lb	kg lb	kg lb	kg lb	kg lb	kg lb	kg lb	kg lb	kg lb	kg lb	kg lb	
9000 mm 30'0"												*5000 *11,300	*5000 *11,300	4500 13'11"
7500 mm 25'0"						*6150 *13,600	*6150 *13,600	*5350 *10,100	*5350 *10,100			*4200 *9,300	*4200 *9,300	6280 20'2"
6000 mm 20'0"						*6650 *14,500	*6650 *14,500	*6400 *14,000	5850 12,550			*3900 *8,650	*3900 *8,650	7350 23'11"
4500 mm 15'0"				*10 650 *22,700	*10 650 *22,700	*8150 *17,600	*8150 *17,600	*7050 *15,300	5700 12,250	*6300 *12,650	4050 8,700	*3900 *8,500	3650 8,050	8000 26'1"
3000 mm 10'0"						*10 300 *22,150	8250 17,800	*8000 *17,350	5450 11,750	6300 13,500	3950 8,500	*4000 *8,750	3400 7,450	8330 27'3"
1500 mm 5'0"						*12 100 *26,100	7800 16,800	8550 18,450	5250 11,300	6150 13,250	3850 8,250	*4250 *9,300	3300 7,200	8390 27'6"
0 mm 0'0"				*7400 *16,950	*7400 *16,950	*12 850 *27,850	7550 16,250	8400 18,050	5100 10,950	6100 13,050	3750 8,100	*4750 *10,400	3350 7,400	8170 26'9"
-1500 mm -5'0"		*7750 *17,250	*7750 *17,250	*12 350 *28,050	*12 350 *28,050	*12 650 *27,400	7500 16,100	8350 17,900	5000 10,800	6050 *12,700	3750 8,100	*5600 *12,350	3650 8,050	7650 25'0"
-3000 mm -10'0"		*12 900 *28,900	*12 900 *28,900	*15 800 *34,250	14 550 31,200	*11 400 *24,650	7550 16,250	8400 18,050	5050 10,900			7100 *15,650	4350 9,650	6760 22'0"
-4500 mm -15'0"				*11 800 *25,200	*11 800 *25,200	*8600 *18,150	7800 16,800					*6850 *15,000	6200 14,000	5320 17'1"



ISO 10567:2007



*Indicates that the load is limited by hydraulic lifting capacity rather than tipping load. The above loads are in compliance with hydraulic excavator lift capacity standard ISO 10567:2007. They do not exceed 87% of hydraulic lifting capacity or 75% of tipping load. Weight of all lifting accessories must be deducted from the above lifting capacities. Lifting capacities are based on the machine standing on a firm, uniform supporting surface. The use of a work tool attachment point to handle/lift objects, could affect the machine lift performance.

Lift capacity stays with ±5% for all available track shoes.

Always refer to the appropriate Operation and Maintenance Manual for specific product information.

325 Hydraulic Excavator Specifications

Reach Boom Lift Capacities – Counterweight: 8.3 mt (18,300 lb) – without Bucket, Heavy Lift: On

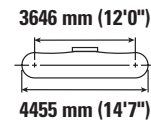
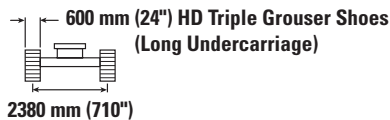

		1500 mm/5'0"		3000 mm/10'0"		4500 mm/15'0"		6000 mm/20'0"		7500 mm/25'0"		mm ft/in		
9000 mm 30'0"	kg lb											*5000 *11,350	*5000 *11,350	4500 13'11"
7500 mm 25'0"	kg lb				*6200 *13,650	*6200 *13,650	*5350 *10,150	*5350 *10,150				*4200 *9,350	*4200 *9,350	6280 20'2"
6000 mm 20'0"	kg lb				*6650 *14,500	*6650 *14,500	*6400 *14,050	*6400 *13,800				*3950 *8,700	*3950 *8,700	7350 23'11"
4500 mm 15'0"	kg lb			*10 650 *22,700	*10 650 *22,700	*8150 *17,600	*8150 *17,600	*7050 *15,300	6250 13,450	*6300 *12,700	4500 9,600	*3900 *8,550	*3900 *8,550	8000 26'1"
3000 mm 10'0"	kg lb				*10 250 *22,100	9050 19,550	*8000 *17,350	6000 12,950	6800 14,650	4350 9,400	3750 8,250	*4000 *8,800	3750 8,250	8330 27'3"
1500 mm 5'0"	kg lb				*12 050 *26,050	8600 18,500	*8900 *19,300	5800 12,450	6700 14,400	4250 9,150	3650 8,050	*4250 *9,350	3650 8,050	8390 27'6"
0 mm 0'0"	kg lb			*7450 *17,000	*7450 *17,000	*12 850 *27,800	8350 17,950	9100 19,600	5650 12,100	6600 14,200	4200 9,000	*4750 *10,450	3750 8,250	8170 26'9"
-1500 mm -5'0"	kg lb	*7750 *17,300	*7750 *17,300	*12 400 *28,100	*12 400 *28,100	*12 600 *27,350	8300 17,800	9050 19,450	5550 12,000	6600 *12,700	4150 9,000	*5650 *12,400	4050 8,950	7650 25'0"
-3000 mm -10'0"	kg lb	*12 900 *28,950	*12 900 *28,950	*15 750 *34,150	*15 750 *34,150	*11 400 *24,600	8350 17,950	*8450 *18,150	5600 12,100			*7100 *15,650	4850 10,700	6760 22'0"
-4500 mm -15'0"	kg lb			*11 800 *25,100	*11 800 *25,100	*8600 *18,100	*8600 *18,100					*6850 *14,950	*6850 *14,950	5320 17'1"



ISO 10567:2007



*Indicates that the load is limited by hydraulic lifting capacity rather than tipping load. The above loads are in compliance with hydraulic excavator lift capacity standard ISO 10567:2007. They do not exceed 87% of hydraulic lifting capacity or 75% of tipping load. Weight of all lifting accessories must be deducted from the above lifting capacities. Lifting capacities are based on the machine standing on a firm, uniform supporting surface. The use of a work tool attachment point to handle/lift objects, could affect the machine lift performance.

Lift capacity stays with ±5% for all available track shoes.

Always refer to the appropriate Operation and Maintenance Manual for specific product information.

325 Hydraulic Excavator Specifications

Reach Boom Lift Capacities – Counterweight: 8.3 mt (18,300 lb) – without Bucket, Heavy Lift: On

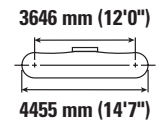
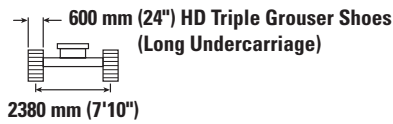
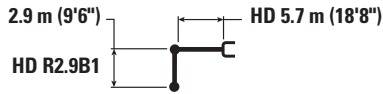

		1500 mm/5'0"		3000 mm/10'0"		4500 mm/15'0"		6000 mm/20'0"		7500 mm/25'0"		mm ft/in		
9000 mm 30'0"	kg lb											*5000 *11,300	*5000 *11,300	4500 13'11"
7500 mm 25'0"	kg lb					*6150 *13,500	*6150 *13,500	*5350 *10,100	*5350 *10,100			*4200 *9,300	*4200 *9,300	6280 20'2"
6000 mm 20'0"	kg lb					*6600 *14,350	*6600 *14,350	*6300 *13,850	*6300 *13,700			*3900 *8,650	*3900 *8,650	7350 23'11"
4500 mm 15'0"	kg lb			*10 600 *22,500	*10 600 *22,500	*8050 *17,400	*8050 *17,400	*6950 *15,100	6200 13,300	*6300 *12,650	4400 9,450	*3850 *8,500	*3850 *8,500	8000 26'1"
3000 mm 10'0"	kg lb					*10 100 *21,800	8950 19,350	*7900 *17,050	5950 12,750	6750 14,500	4300 9,250	*4000 *8,750	3650 8,050	8330 27'3"
1500 mm 5'0"	kg lb					*11 850 *25,650	8450 18,200	*8750 *19,000	5700 12,200	6600 14,200	4150 8,950	*4250 *9,300	3550 7,850	8390 27'6"
0 mm 0'0"	kg lb			*7400 *16,950	*7400 *16,950	*12 650 *27,350	8150 17,600	9000 19,350	5500 11,850	6500 14,000	4100 8,800	*4700 *10,400	3650 8,000	8170 26'9"
-1500 mm -5'0"	kg lb	*7700 *17,250	*7700 *17,250	*12 350 *28,050	*12 350 *28,050	*12 400 *26,850	8100 17,400	8900 19,150	5450 11,700	6500 *12,650	4050 8,750	*5600 *12,350	3950 8,750	7650 25'0"
-3000 mm -10'0"	kg lb	*12 900 *28,900	*12 900 *28,900	*15 450 *33,500	*15 450 *33,500	*11 200 *24,150	8200 17,600	*8300 *17,800	5500 11,800			*6950 *15,300	4700 10,450	6760 22'0"
-4500 mm -15'0"	kg lb			*11 500 *24,550	*11 500 *24,550	*8400 *17,700	*8400 *17,700					*6650 *14,600	*6650 *14,600	5320 17'1"



ISO 10567:2007



*Indicates that the load is limited by hydraulic lifting capacity rather than tipping load. The above loads are in compliance with hydraulic excavator lift capacity standard ISO 10567:2007. They do not exceed 87% of hydraulic lifting capacity or 75% of tipping load. Weight of all lifting accessories must be deducted from the above lifting capacities. Lifting capacities are based on the machine standing on a firm, uniform supporting surface. The use of a work tool attachment point to handle/lift objects, could affect the machine lift performance.

Lift capacity stays with ±5% for all available track shoes.

Always refer to the appropriate Operation and Maintenance Manual for specific product information.

325 Hydraulic Excavator Specifications

Reach Boom Lift Capacities – Counterweight: 8.3 mt (18,300 lb) – without Bucket, Heavy Lift: On

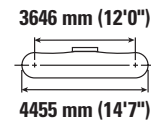
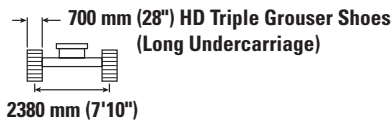

		1500 mm/5'0"		3000 mm/10'0"		4500 mm/15'0"		6000 mm/20'0"		7500 mm/25'0"		mm ft/in		
9000 mm 30'0"	kg lb											*5000 *11,350	*5000 *11,350	4500 13'11"
7500 mm 25'0"	kg lb				*6200 *13,650	*6200 *13,650	*5350 *10,150	*5350 *10,150				*4200 *9,350	*4200 *9,350	6280 20'2"
6000 mm 20'0"	kg lb				*6650 *14,500	*6650 *14,500	*6400 *14,050	*6400 *13,950				*3950 *8,700	*3950 *8,700	7350 23'11"
4500 mm 15'0"	kg lb			*10 650 *22,700	*10 650 *22,700	*8150 *17,600	*8150 *17,600	*7050 *15,300	6300 13,600	*6300 *12,700	4550 9,700	*3900 *8,550	*3900 *8,550	8000 26'1"
3000 mm 10'0"	kg lb				*10 250 *22,100	9150 19,750	*8000 *17,350	6100 13,100	6900 14,800	6900 14,800	4450 9,500	*4000 *8,800	3800 8,350	8330 27'3"
1500 mm 5'0"	kg lb				*12 050 *26,050	8700 18,750	*8900 *19,300	5850 12,600	6750 14,550	6750 14,550	4300 9,300	*4250 *9,350	3700 8,100	8390 27'6"
0 mm 0'0"	kg lb			*7450 *17,000	*7450 *17,000	*12 850 *27,800	8450 18,150	9200 19,800	5700 12,250	6700 14,400	4250 9,100	*4750 *10,450	3800 8,350	8170 26'9"
-1500 mm -5'0"	kg lb	*7750 *17,300	*7750 *17,300	*12 400 *28,100	*12 400 *28,100	*12 600 *27,350	8400 18,000	9150 19,650	5650 12,100	6650 *12,700	4200 9,100	*5650 *12,400	4100 9,100	7650 25'0"
-3000 mm -10'0"	kg lb	*12 900 *28,950	*12 900 *28,950	*15 750 *34,150	*15 750 *34,150	*11 400 *24,600	8450 18,200	*8450 *18,150	5700 12,250			*7100 *15,650	4900 10,850	6760 22'0"
-4500 mm -15'0"	kg lb			*11 800 *25,100	*11 800 *25,100	*8600 *18,100	*8600 *18,100					*6850 *14,950	*6850 *14,950	5320 17'1"



ISO 10567:2007



*Indicates that the load is limited by hydraulic lifting capacity rather than tipping load. The above loads are in compliance with hydraulic excavator lift capacity standard ISO 10567:2007. They do not exceed 87% of hydraulic lifting capacity or 75% of tipping load. Weight of all lifting accessories must be deducted from the above lifting capacities. Lifting capacities are based on the machine standing on a firm, uniform supporting surface. The use of a work tool attachment point to handle/lift objects, could affect the machine lift performance.

Lift capacity stays with ±5% for all available track shoes.

Always refer to the appropriate Operation and Maintenance Manual for specific product information.

325 Hydraulic Excavator Specifications

Reach Boom Lift Capacities – Counterweight: 8.3 mt (18,300 lb) – without Bucket, Heavy Lift: On

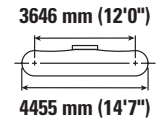
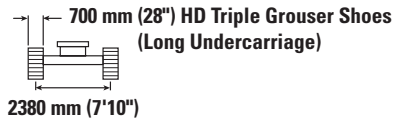
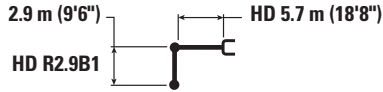

		1500 mm/5'0"		3000 mm/10'0"		4500 mm/15'0"		6000 mm/20'0"		7500 mm/25'0"		mm ft/in		
9000 mm 30'0"	kg lb											*5000 *11,300	*5000 *11,300	4500 13'11"
7500 mm 25'0"	kg lb					*6150 *13,500	*6150 *13,500	*5350 *10,100	*5350 *10,100			*4200 *9,300	*4200 *9,300	6280 20'2"
6000 mm 20'0"	kg lb					*6600 *14,350	*6600 *14,350	*6300 *13,850	*6300 *13,850			*3900 *8,650	*3900 *8,650	7350 23'11"
4500 mm 15'0"	kg lb			*10 600 *22,500	*10 600 *22,500	*8050 *17,400	*8050 *17,400	*6950 *15,100	6250 13,450	*6300 *12,650	4450 9,550	*3850 *8,500	*3850 *8,500	8000 26'1"
3000 mm 10'0"	kg lb					*10 100 *21,800	9050 19,550	*7900 *17,050	6000 12,900	*6800 *14,650	4350 9,350	*4000 *8,750	3700 8,150	8330 27'3"
1500 mm 5'0"	kg lb					*11 850 *25,650	8550 18,400	*8750 *19,000	5750 12,350	6700 14,400	4200 9,100	*4250 *9,300	3600 7,950	8390 27'6"
0 mm 0'0"	kg lb			*7400 *16,950	*7400 *16,950	*12 650 *27,350	8250 17,800	9100 19,550	5550 12,000	6600 14,200	4150 8,900	*4700 *10,400	3700 8,100	8170 26'9"
-1500 mm -5'0"	kg lb	*7700 *17,250	*7700 *17,250	*12 350 *28,050	*12 350 *28,050	*12 400 *26,850	8200 17,650	9000 19,400	5500 11,850	6550 *12,650	4100 8,850	*5600 *12,350	4000 8,850	7650 25'0"
-3000 mm -10'0"	kg lb	*12 900 *28,900	*12 900 *28,900	*15 450 *33,500	*15 450 *33,500	*11 200 *24,150	8250 17,800	*8300 *17,800	5550 11,950			*6950 *15,300	4800 10,600	6760 22'0"
-4500 mm -15'0"	kg lb			*11 500 *24,550	*11 500 *24,550	*8400 *17,700	*8400 *17,700					*6650 *14,600	*6650 *14,600	5320 17'1"



ISO 10567:2007



*Indicates that the load is limited by hydraulic lifting capacity rather than tipping load. The above loads are in compliance with hydraulic excavator lift capacity standard ISO 10567:2007. They do not exceed 87% of hydraulic lifting capacity or 75% of tipping load. Weight of all lifting accessories must be deducted from the above lifting capacities. Lifting capacities are based on the machine standing on a firm, uniform supporting surface. The use of a work tool attachment point to handle/lift objects, could affect the machine lift performance.

Lift capacity stays with ±5% for all available track shoes.

Always refer to the appropriate Operation and Maintenance Manual for specific product information.

325 Hydraulic Excavator Specifications

Reach Boom Lift Capacities – Counterweight: 8.3 mt (18,300 lb) – without Bucket, Heavy Lift: On

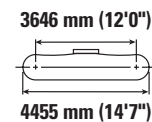
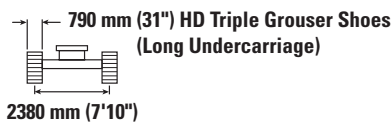
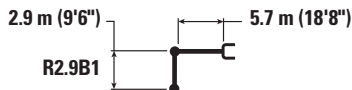

		1500 mm/5'0"		3000 mm/10'0"		4500 mm/15'0"		6000 mm/20'0"		7500 mm/25'0"		mm ft/in		
9000 mm 30'0"	kg lb											*5000 *11,350	*5000 *11,350	4500 13'11"
7500 mm 25'0"	kg lb					*6200 *13,650	*6200 *13,650	*5350 *10,150	*5350 *10,150			*4200 *9,350	*4200 *9,350	6280 20'2"
6000 mm 20'0"	kg lb					*6650 *14,500	*6650 *14,500	*6400 *14,050	*6400 *14,050			*3950 *8,700	*3950 *8,700	7350 23'11"
4500 mm 15'0"	kg lb			*10 650 *22,700	*10 650 *22,700	*8150 *17,600	*8150 *17,600	*7050 *15,300	6400 13,750	*6300 *12,700	4600 9,850	*3900 *8,550	*3900 *8,550	8000 26'1"
3000 mm 10'0"	kg lb					*10 250 *22,100	9250 19,950	*8000 *17,350	6150 13,250	*6900 *15,000	4500 9,600	*4000 *8,800	3850 8,450	8330 27'3"
1500 mm 5'0"	kg lb					*12 050 *26,050	8800 18,950	*8900 *19,300	5900 12,750	6850 14,750	4350 9,400	*4250 *9,350	3750 8,200	8390 27'6"
0 mm 0'0"	kg lb			*7450 *17,000	*7450 *17,000	*12 850 *27,800	8550 18,400	9300 20,050	5750 12,400	6750 14,550	4300 9,200	*4750 *10,450	3850 8,450	8170 26'9"
-1500 mm -5'0"	kg lb	*7750 *17,300	*7750 *17,300	*12 400 *28,100	*12 400 *28,100	*12 600 *27,350	8450 18,250	9250 19,900	5700 12,250	6750 *12,700	4250 9,200	*5650 *12,400	4150 9,200	7650 25'0"
-3000 mm -10'0"	kg lb	*12 900 *28,950	*12 900 *28,950	*15 750 *34,150	*15 750 *34,150	*11 400 *24,600	8550 18,400	*8450 *18,150	5750 12,400			*7100 *15,650	4950 10,950	6760 22'0"
-4500 mm -15'0"	kg lb			*11 800 *25,100	*11 800 *25,100	*8600 *18,100	*8600 *18,100					*6850 *14,950	*6850 *14,950	5320 17'1"



ISO 10567:2007



*Indicates that the load is limited by hydraulic lifting capacity rather than tipping load. The above loads are in compliance with hydraulic excavator lift capacity standard ISO 10567:2007. They do not exceed 87% of hydraulic lifting capacity or 75% of tipping load. Weight of all lifting accessories must be deducted from the above lifting capacities. Lifting capacities are based on the machine standing on a firm, uniform supporting surface. The use of a work tool attachment point to handle/lift objects, could affect the machine lift performance.

Lift capacity stays with ±5% for all available track shoes.

Always refer to the appropriate Operation and Maintenance Manual for specific product information.

325 Hydraulic Excavator Specifications

Reach Boom Lift Capacities – Counterweight: 8.3 mt (18,300 lb) – without Bucket, Heavy Lift: On

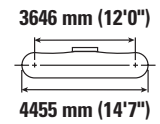
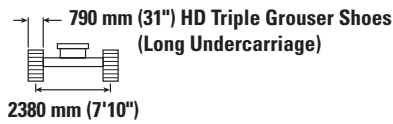
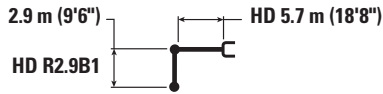

		1500 mm/5'0"		3000 mm/10'0"		4500 mm/15'0"		6000 mm/20'0"		7500 mm/25'0"		mm ft/in		
9000 mm 30'0"	kg lb											*5000 *11,300	*5000 *11,300	4500 13'11"
7500 mm 25'0"	kg lb					*6150 *13,500	*6150 *13,500	*5350 *10,100	*5350 *10,100			*4200 *9,300	*4200 *9,300	6280 20'2"
6000 mm 20'0"	kg lb					*6600 *14,350	*6600 *14,350	*6300 *13,850	*6300 *13,850			*3900 *8,650	*3900 *8,650	7350 23'11"
4500 mm 15'0"	kg lb			*10 600 *22,500	*10 600 *22,500	*8050 *17,400	*8050 *17,400	*6950 *15,100	6300 13,600	*6300 *12,650	4500 9,650	*3850 *8,500	*3850 *8,500	8000 26'1"
3000 mm 10'0"	kg lb					*10 100 *21,800	9150 19,750	*7900 *17,050	6050 13,050	*6800 *14,750	4400 9,450	*4000 *8,750	3750 8,250	8330 27'3"
1500 mm 5'0"	kg lb					*11 850 *25,650	8650 18,600	*8750 *19,000	5800 12,500	6750 14,550	4250 9,200	*4250 *9,300	3650 8,000	8390 27'6"
0 mm 0'0"	kg lb			*7400 *16,950	*7400 *16,950	*12 650 *27,350	8350 18,000	9200 19,800	5650 12,150	6650 14,350	4200 9,000	*4700 *10,400	3750 8,200	8170 26'9"
-1500 mm -5'0"	kg lb	*7700 *17,250	*7700 *17,250	*12 350 *28,050	*12 350 *28,050	*12 400 *26,850	8300 17,850	9150 19,650	5550 12,000	6650 *12,650	4150 9,000	*5600 *12,350	4050 8,950	7650 25'0"
-3000 mm -10'0"	kg lb	*12 900 *28,900	*12 900 *28,900	*15 450 *33,500	*15 450 *33,500	*11 200 *24,150	8350 18,000	*8300 *17,800	5600 12,100			*6950 *15,300	4850 10,700	6760 22'0"
-4500 mm -15'0"	kg lb			*11 500 *24,550	*11 500 *24,550	*8400 *17,700	*8400 *17,700					*6650 *14,600	*6650 *14,600	5320 17'1"



ISO 10567:2007



*Indicates that the load is limited by hydraulic lifting capacity rather than tipping load. The above loads are in compliance with hydraulic excavator lift capacity standard ISO 10567:2007. They do not exceed 87% of hydraulic lifting capacity or 75% of tipping load. Weight of all lifting accessories must be deducted from the above lifting capacities. Lifting capacities are based on the machine standing on a firm, uniform supporting surface. The use of a work tool attachment point to handle/lift objects, could affect the machine lift performance.

Lift capacity stays with ±5% for all available track shoes.









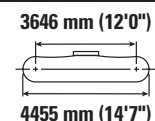
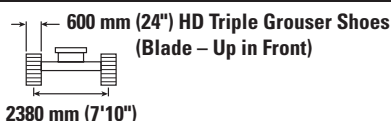
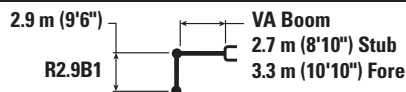

Always refer to the appropriate Operation and Maintenance Manual for specific product information.

325 Hydraulic Excavator Specifications

Variable Angle Boom Lift Capacities – Counterweight: 4.9 mt (10,800 lb) – without Bucket, Heavy Lift: On

2980 mm (9'9") Blade



		3000 mm/10'0"		4500 mm/15'0"		6000 mm/20'0"		7500 mm/25'0"				mm ft/in
												
9000 mm 30'0"	kg lb			*6700 *13,750	*6700 *13,750					*4950 *11,200	*4950 *11,200	5120 16'1"
7500 mm 25'0"	kg lb			*7000 *15,450	*7000 *15,450	*6450 *13,500	5350 11,400			*4250 *9,400	*4250 *9,400	6740 21'9"
6000 mm 20'0"	kg lb			*7350 *16,150	*7350 *16,150	*7050 *15,200	5300 11,350	*5250 *9,700	3600 7,650	*3950 *8,700	3350 7,500	7740 25'2"
4500 mm 15'0"	kg lb	*13 800 *29,500	*13 800 *29,500	*9550 *20,600	7900 17,050	*7400 *16,000	5050 10,800	5400 11,600	3500 7,500	*3850 *8,500	2900 6,400	8360 27'4"
3000 mm 10'0"	kg lb			*10 700 *23,150	7150 15,450	7450 16,000	4700 10,150	5250 11,300	3350 7,200	*3950 *8,650	2650 5,850	8680 28'5"
1500 mm 5'0"	kg lb			*11 250 24,100	6550 14,150	7100 15,300	4400 9,500	5100 10,950	3200 6,900	4050 8,900	2550 5,650	8730 28'7"
0 mm 0'0"	kg lb			*10 650 *23,150	6300 13,500	6900 14,850	4200 9,100	5000 10,700	3100 6,700	4150 9,150	2600 5,750	8520 27'11"
-1500 mm -5'0"	kg lb	*9900 *22,450	*9900 *22,450	*9200 *20,000	6250 13,400	6800 14,650	4150 8,950	4950 10,650	3100 6,650	*4450 *9,750	2850 6,250	8020 26'3"
-3000 mm -10'0"	kg lb			*6850 *14,700	6350 13,650	*5300 *11,250	4200 9,100			*3950 *8,800	3500 7,750	6980 22'7"



ISO 10567:2007



*Indicates that the load is limited by hydraulic lifting capacity rather than tipping load. The above loads are in compliance with hydraulic excavator lift capacity standard ISO 10567:2007. They do not exceed 87% of hydraulic lifting capacity or 75% of tipping load. Weight of all lifting accessories must be deducted from the above lifting capacities. Lifting capacities are based on the machine standing on a firm, uniform supporting surface. The use of a work tool attachment point to handle/lift objects, could affect the machine lift performance.

Max Length of VAB.

Lift capacity stays with ±5% for all available track shoes.









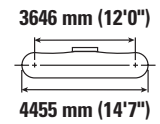
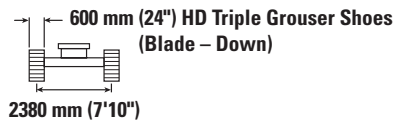
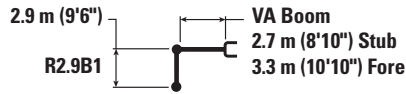

Always refer to the appropriate Operation and Maintenance Manual for specific product information.

325 Hydraulic Excavator Specifications

Variable Angle Boom Lift Capacities – Counterweight: 4.9 mt (10,800 lb) – without Bucket, Heavy Lift: On

2980 mm (9'9") Blade



		3000 mm/10'0"		4500 mm/15'0"		6000 mm/20'0"		7500 mm/25'0"				mm ft/in	
													
9000 mm 30'0"	kg lb			*6700 *13,750	*6700 *13,750					*4950 *11,200	*4950 *11,200	5120 16'1"	
7500 mm 25'0"	kg lb			*7000 *15,450	*7000 *15,450	*6450 *13,500	5850 12,450			*4250 *9,400	*4250 *9,400	6740 21'9"	
6000 mm 20'0"	kg lb			*7350 *16,150	*7350 *16,150	*7050 *15,200	5750 12,350	*5250 *9,700	3950 8,350	*3950 *8,700	3700 8,200	7740 25'2"	
4500 mm 15'0"	kg lb	*13 800 *29,500	*13 800 *29,500	*9550 *20,600	8700 18,700	*7400 *16,000	5500 11,850	*5900 *12,700	3850 8,250	*3850 *8,500	3200 7,050	8360 27'4"	
3000 mm 10'0"	kg lb			*10 700 *23,150	7900 17,100	*8050 *17,400	5200 11,150	*6100 *13,150	3700 7,950	*3950 *8,650	2950 6,450	8680 28'5"	
1500 mm 5'0"	kg lb			*11 250 *24,300	7300 15,750	*8300 *17,950	4900 10,500	*6400 *13,750	3550 7,650	*4150 *9,100	2850 6,250	8730 28'7"	
0 mm 0'0"	kg lb			*10 650 *23,150	7000 15,100	*8050 *17,400	4700 10,050	*6200 *13,350	3450 7,400	*4500 *9,950	2900 6,350	8520 27'11"	
-1500 mm -5'0"	kg lb	*9900 *22,450	*9900 *22,450	*9200 *20,000	6950 15,000	*7150 *15,400	4600 9,950	*5300 *11,200	3450 7,350	*4450 *9,750	3150 6,950	8020 26'3"	
-3000 mm -10'0"	kg lb			*6850 *14,700	*6850 *14,700	*5300 *11,250	4700 10,100			*3950 *8,800	3850 8,600	6980 22'7"	



ISO 10567:2007



*Indicates that the load is limited by hydraulic lifting capacity rather than tipping load. The above loads are in compliance with hydraulic excavator lift capacity standard ISO 10567:2007. They do not exceed 87% of hydraulic lifting capacity or 75% of tipping load. Weight of all lifting accessories must be deducted from the above lifting capacities. Lifting capacities are based on the machine standing on a firm, uniform supporting surface. The use of a work tool attachment point to handle/lift objects, could affect the machine lift performance.

Max Length of VAB.

Lift capacity stays with ±5% for all available track shoes.

Always refer to the appropriate Operation and Maintenance Manual for specific product information.

325 Hydraulic Excavator Specifications

Variable Angle Boom Lift Capacities – Counterweight: 4.9 mt (10,800 lb) – without Bucket, Heavy Lift: On

3170 mm (10'5") Blade

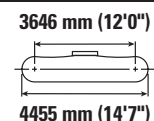
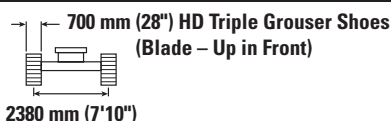
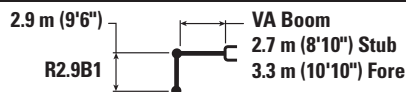

		3000 mm/10'0"		4500 mm/15'0"		6000 mm/20'0"		7500 mm/25'0"		3170 mm/10'5"		mm ft/in
9000 mm 30'0"	kg lb			*6700 *13,750	*6700 *13,750					*4950 *11,200	*4950 *11,200	5120 16'1"
7500 mm 25'0"	kg lb			*7000 *15,450	*7000 *15,450	*6450 *13,500	5400 11,600			*4250 *9,400	*4250 *9,400	6740 21'9"
6000 mm 20'0"	kg lb			*7350 *16,150	*7350 *16,150	*7050 *15,200	5350 11,500	*5250 *9,700	3650 7,750	*3950 *8,700	3450 7,600	7740 25'2"
4500 mm 15'0"	kg lb	*13 800 *29,500	*13 800 *29,500	*9550 *20,600	8000 17,250	*7400 *16,000	5100 11,000	5500 11,750	3550 7,650	*3850 *8,500	2950 6,500	8360 27'4"
3000 mm 10'0"	kg lb			*10 700 *23,150	7250 15,700	7550 16,250	4800 10,300	5350 11,450	3400 7,350	*3950 *8,650	2700 5,950	8680 28'5"
1500 mm 5'0"	kg lb			*11 250 *24,300	6650 14,400	7200 15,500	4500 9,650	5150 11,100	3300 7,050	4100 9,050	2600 5,750	8730 28'7"
0 mm 0'0"	kg lb			*10 650 *23,150	6400 13,750	7000 15,050	4300 9,250	5050 10,850	3150 6,800	4250 9,300	2650 5,850	8520 27'11"
-1500 mm -5'0"	kg lb	*9900 *22,450	*9900 *22,450	*9200 *20,000	6350 13,650	6950 14,900	4250 9,100	5050 10,800	3150 6,800	*4450 *9,750	2900 6,400	8020 26'3"
-3000 mm -10'0"	kg lb			*6850 *14,700	6450 13,900	*5300 *11,250	4300 9,250			*3950 *8,800	3550 7,900	6980 22'7"



ISO 10567:2007



*Indicates that the load is limited by hydraulic lifting capacity rather than tipping load. The above loads are in compliance with hydraulic excavator lift capacity standard ISO 10567:2007. They do not exceed 87% of hydraulic lifting capacity or 75% of tipping load. Weight of all lifting accessories must be deducted from the above lifting capacities. Lifting capacities are based on the machine standing on a firm, uniform supporting surface. The use of a work tool attachment point to handle/lift objects, could affect the machine lift performance.

Max Length of VAB.

Lift capacity stays with ±5% for all available track shoes.

Always refer to the appropriate Operation and Maintenance Manual for specific product information.

325 Hydraulic Excavator Specifications

Variable Angle Boom Lift Capacities – Counterweight: 4.9 mt (10,800 lb) – without Bucket, Heavy Lift: On

3170 mm (10'5") Blade

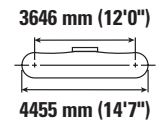
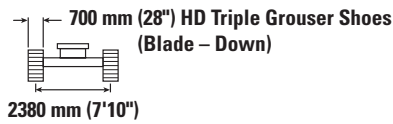
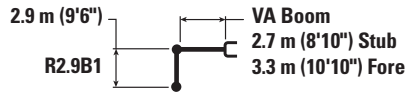

		3000 mm/10'0"		4500 mm/15'0"		6000 mm/20'0"		7500 mm/25'0"		3170 mm/10'5"		mm ft/in
9000 mm 30'0"	kg lb			*6700 *13,750	*6700 *13,750					*4950 *11,200	*4950 *11,200	5120 16'1"
7500 mm 25'0"	kg lb			*7000 *15,450	*7000 *15,450	*6450 *13,500	6150 13,100			*4250 *9,400	*4250 *9,400	6740 21'9"
6000 mm 20'0"	kg lb			*7350 *16,150	*7350 *16,150	*7050 *15,200	6050 13,000	*5250 *9,700	4150 8,850	*3950 *8,700	3900 8,650	7740 25'2"
4500 mm 15'0"	kg lb	*13 800 *29,500	*13 800 *29,500	*9550 *20,600	9150 19,700	*7400 *16,000	5800 12,500	*5900 *12,700	4050 8,700	*3850 *8,500	3350 7,450	8360 27'4"
3000 mm 10'0"	kg lb			*10 700 *23,150	8400 18,100	*8050 *17,400	5500 11,800	*6100 *13,150	3900 8,400	*3950 *8,650	3100 6,850	8680 28'5"
1500 mm 5'0"	kg lb			*11 250 *24,300	7750 16,750	*8300 *17,950	5150 11,150	*6400 *13,750	3750 8,100	*4150 *9,100	3000 6,600	8730 28'7"
0 mm 0'0"	kg lb			*10 650 *23,150	7500 16,100	*8050 *17,400	4950 10,700	*6200 *13,350	3650 7,850	*4500 *9,950	3100 6,750	8520 27'11"
-1500 mm -5'0"	kg lb	*9900 *22,450	*9900 *22,450	*9200 *20,000	7450 15,950	*7150 *15,400	4900 10,550	*5300 *11,200	3650 7,850	*4450 *9,750	3350 7,350	8020 26'3"
-3000 mm -10'0"	kg lb			*6850 *14,700	*6850 *14,700	*5300 *11,250	4950 10,700			*3950 *8,800	*3950 *8,800	6980 22'7"



ISO 10567:2007



*Indicates that the load is limited by hydraulic lifting capacity rather than tipping load. The above loads are in compliance with hydraulic excavator lift capacity standard ISO 10567:2007. They do not exceed 87% of hydraulic lifting capacity or 75% of tipping load. Weight of all lifting accessories must be deducted from the above lifting capacities. Lifting capacities are based on the machine standing on a firm, uniform supporting surface. The use of a work tool attachment point to handle/lift objects, could affect the machine lift performance.

Max Length of VAB.

Lift capacity stays with ±5% for all available track shoes.

Always refer to the appropriate Operation and Maintenance Manual for specific product information.

325 Hydraulic Excavator Specifications

Variable Angle Boom Lift Capacities – Counterweight: 4.9 mt (10,800 lb) – without Bucket, Heavy Lift: On

3170 mm (10'5") Blade

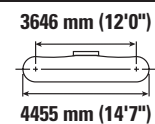
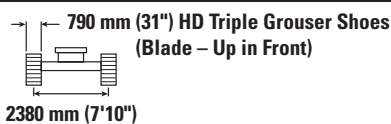
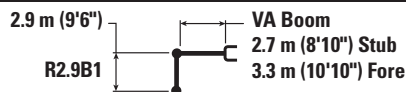

		3000 mm/10'0"		4500 mm/15'0"		6000 mm/20'0"		7500 mm/25'0"		3170 mm/10'5"		mm ft/in
9000 mm 30'0"	kg lb			*6700 *13,750	*6700 *13,750					*4950 *11,200	*4950 *11,200	5120 16'1"
7500 mm 25'0"	kg lb			*7000 *15,450	*7000 *15,450	*6450 *13,500	5500 11,750			*4250 *9,400	*4250 *9,400	6740 21'9"
6000 mm 20'0"	kg lb			*7350 *16,150	*7350 *16,150	*7050 *15,200	5400 11,650	*5250 *9,700	3700 7,850	*3950 *8,700	3450 7,750	7740 25'2"
4500 mm 15'0"	kg lb	*13 800 *29,500	*13 800 *29,500	*9550 *20,600	8100 17,450	*7400 *16,000	5200 11,150	5550 11,950	3600 7,750	*3850 *8,500	3000 6,600	8360 27'4"
3000 mm 10'0"	kg lb			*10 700 *23,150	7350 15,900	7650 16,500	4850 10,450	5400 11,600	3450 7,450	*3950 *8,650	2750 6,050	8680 28'5"
1500 mm 5'0"	kg lb			*11 250 *24,300	6750 14,600	7350 15,750	4550 9,800	5250 11,250	3350 7,150	*4150 *9,100	2650 5,850	8730 28'7"
0 mm 0'0"	kg lb			*10 650 *23,150	6500 13,950	7100 15,300	4350 9,400	5150 11,050	3200 6,900	4300 9,450	2700 5,950	8520 27'11"
-1500 mm -5'0"	kg lb	*9900 *22,450	*9900 *22,450	*9200 *20,000	6450 13,850	7050 15,100	4300 9,250	5100 11,000	3200 6,900	*4450 *9,750	2950 6,500	8020 26'3"
-3000 mm -10'0"	kg lb			*6850 *14,700	6550 14,100	*5300 *11,250	4350 9,400			*3950 *8,800	3600 8,050	6980 22'7"



ISO 10567:2007



*Indicates that the load is limited by hydraulic lifting capacity rather than tipping load. The above loads are in compliance with hydraulic excavator lift capacity standard ISO 10567:2007. They do not exceed 87% of hydraulic lifting capacity or 75% of tipping load. Weight of all lifting accessories must be deducted from the above lifting capacities. Lifting capacities are based on the machine standing on a firm, uniform supporting surface. The use of a work tool attachment point to handle/lift objects, could affect the machine lift performance.

Max Length of VAB.

Lift capacity stays with ±5% for all available track shoes.

Always refer to the appropriate Operation and Maintenance Manual for specific product information.

325 Hydraulic Excavator Specifications

Variable Angle Boom Lift Capacities – Counterweight: 4.9 mt (10,800 lb) – without Bucket, Heavy Lift: On

3170 mm (10'5") Blade

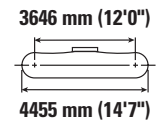
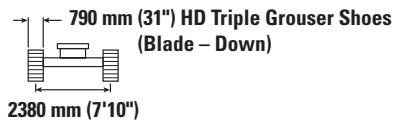
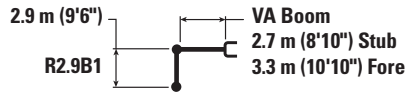

		3000 mm/10'0"		4500 mm/15'0"		6000 mm/20'0"		7500 mm/25'0"		3170 mm/10'5"		mm ft/in
9000 mm 30'0"	kg lb			*6700 *13,750	*6700 *13,750					*4950 *11,200	*4950 *11,200	5120 16'1"
7500 mm 25'0"	kg lb			*7000 *15,450	*7000 *15,450	*6450 *13,500	6200 13,250			*4250 *9,400	*4250 *9,400	6740 21'9"
6000 mm 20'0"	kg lb			*7350 *16,150	*7350 *16,150	*7050 *15,200	6150 13,150	*5250 *9,700	4200 8,950	*3950 *8,700	*3950 *8,700	7740 25'2"
4500 mm 15'0"	kg lb	*13 800 *29,500	*13 800 *29,500	*9550 *20,600	9250 19,950	*7400 *16,000	*5900 12,650	*5900 *12,700	4100 8,850	*3850 *8,500	3400 7,550	8360 27'4"
3000 mm 10'0"	kg lb			*10 700 *23,150	8500 18,300	*8050 *17,400	5550 11,950	*6100 *13,150	3950 8,550	*3950 *8,650	3150 6,950	8680 28'5"
1500 mm 5'0"	kg lb			*11 250 *24,300	7900 16,950	*8300 *17,950	5250 11,300	*6400 *13,750	3800 8,200	*4150 *9,100	3050 6,700	8730 28'7"
0 mm 0'0"	kg lb			*10 650 *23,150	7600 16,300	*8050 *17,400	5050 10,850	*6200 *13,350	3700 8,000	*4500 *9,950	3150 6,850	8520 27'11"
-1500 mm -5'0"	kg lb	*9900 *22,450	*9900 *22,450	*9200 *20,000	7550 16,200	*7150 *15,400	5000 10,700	*5300 *11,200	3700 7,950	*4450 *9,750	3400 7,500	8020 26'3"
-3000 mm -10'0"	kg lb			*6850 *14,700	*6850 *14,700	*5300 *11,250	5050 10,850			*3950 *8,800	*3950 *8,800	6980 22'7"



ISO 10567:2007



*Indicates that the load is limited by hydraulic lifting capacity rather than tipping load. The above loads are in compliance with hydraulic excavator lift capacity standard ISO 10567:2007. They do not exceed 87% of hydraulic lifting capacity or 75% of tipping load. Weight of all lifting accessories must be deducted from the above lifting capacities. Lifting capacities are based on the machine standing on a firm, uniform supporting surface. The use of a work tool attachment point to handle/lift objects, could affect the machine lift performance.

Max Length of VAB.









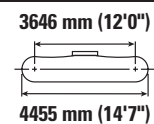
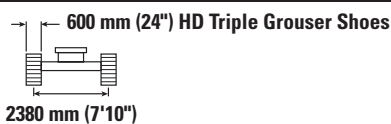
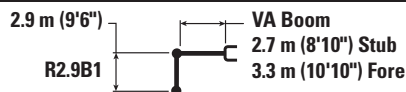

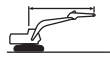
Lift capacity stays with ±5% for all available track shoes.

Always refer to the appropriate Operation and Maintenance Manual for specific product information.

325 Hydraulic Excavator Specifications

Variable Angle Boom Lift Capacities – Counterweight: 6.7 mt (14,800 lb) – without Bucket, Heavy Lift: On



		3000 mm/10'0"		4500 mm/15'0"		6000 mm/20'0"		7500 mm/25'0"				mm ft/in
												
9000 mm 30'0"	kg lb			*6650 *13,700	*6650 *13,700					*4950 *11,150	*4950 *11,150	5120 16'1"
7500 mm 25'0"	kg lb			*7000 *15,400	*7000 *15,400	*6400 *13,450	5750 12,250			*4200 *9,350	*4200 *9,350	6740 21'9"
6000 mm 20'0"	kg lb			*7350 *16,100	*7350 *16,100	*7150 *15,550	5650 12,200	*5250 *9,650	3900 8,300	*3950 *8,650	3650 8,150	7740 25'2"
4500 mm 15'0"	kg lb	*13 750 *29,500	*13 750 *29,500	*9550 *20,600	8500 18,300	*7550 *16,350	5450 11,700	*6050 *13,100	3800 8,150	*3850 *8,450	3150 7,000	8360 27'4"
3000 mm 10'0"	kg lb			*10 700 *23,150	7750 16,700	*8050 *17,400	5100 11,000	6000 12,950	3650 7,900	*3900 *8,600	2900 6,400	8680 28'5"
1500 mm 5'0"	kg lb			*11 250 *24,350	7150 15,450	8150 17,550	4800 10,350	5850 12,600	3500 7,550	*4100 *9,050	2800 6,200	8730 28'7"
0 mm 0'0"	kg lb			*10 700 *23,200	6900 14,800	7950 17,100	4650 9,950	5750 12,350	3400 7,350	*4500 *9,900	2900 6,350	8520 27'11"
-1500 mm -5'0"	kg lb	*10 150 *23,000	*10 150 *23,000	*9200 *20,000	6850 14,700	*7150 *15,400	4550 9,800	*5300 *11,200	3400 7,300	*4450 *9,750	3150 6,900	8020 26'3"
-3000 mm -10'0"	kg lb			*6850 *14,700	*6850 *14,700	*5300 *11,250	4650 9,950			*3950 *8,800	3800 8,500	6980 22'7"



ISO 10567:2007



*Indicates that the load is limited by hydraulic lifting capacity rather than tipping load. The above loads are in compliance with hydraulic excavator lift capacity standard ISO 10567:2007. They do not exceed 87% of hydraulic lifting capacity or 75% of tipping load. Weight of all lifting accessories must be deducted from the above lifting capacities. Lifting capacities are based on the machine standing on a firm, uniform supporting surface. The use of a work tool attachment point to handle/lift objects, could affect the machine lift performance.

Max Length of VAB.









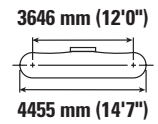
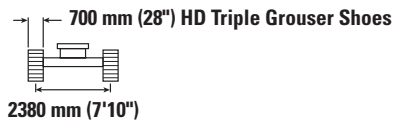
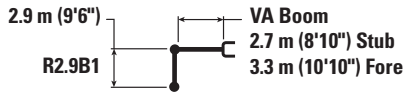

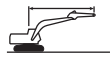
Lift capacity stays with ±5% for all available track shoes.

Always refer to the appropriate Operation and Maintenance Manual for specific product information.

325 Hydraulic Excavator Specifications

Variable Angle Boom Lift Capacities – Counterweight: 6.7 mt (14,800 lb) – without Bucket, Heavy Lift: On



		3000 mm/10'0"		4500 mm/15'0"		6000 mm/20'0"		7500 mm/25'0"				mm ft/in
												
9000 mm 30'0"	kg lb			*6650 *13,700	*6650 *13,700					*4950 *11,150	*4950 *11,150	5120 16'1"
7500 mm 25'0"	kg lb			*7000 *15,400	*7000 *15,400	*6400 *13,450	5800 12,400			*4200 *9,350	*4200 *9,350	6740 21'9"
6000 mm 20'0"	kg lb			*7350 *16,100	*7350 *16,100	*7150 *15,550	5750 12,300	*5250 *9,650	3950 8,400	*3950 *8,650	3700 8,250	7740 25'2"
4500 mm 15'0"	kg lb	*13 750 *29,500	*13 750 *29,500	*9550 *20,600	8600 18,500	*7550 *16,350	5500 11,850	*6050 *13,100	3850 8,300	*3850 *8,450	3200 7,050	8360 27'4"
3000 mm 10'0"	kg lb			*10 700 *23,150	7850 16,950	*8050 *17,400	5200 11,150	6100 13,100	3700 8,000	*3900 *8,600	2950 6,500	8680 28'5"
1500 mm 5'0"	kg lb			*11 250 *24,350	7250 15,650	8150 17,550	4900 10,500	5950 12,750	3550 7,700	*4100 *9,050	2850 6,300	8730 28'7"
0 mm 0'0"	kg lb			*10 700 *23,200	7000 15,050	7950 17,100	4700 10,100	5850 12,550	3450 7,450	*4500 *9,900	2950 6,400	8520 27'11"
-1500 mm -5'0"	kg lb	*10 150 *23,000	*10 150 *23,000	*9200 *20,000	6950 14,900	*7150 *15,400	4650 9,950	*5300 *11,200	3450 7,400	*4450 *9,750	3200 7,000	8020 26'3"
-3000 mm -10'0"	kg lb			*6850 *14,700	*6850 *14,700	*5300 *11,250	4700 10,100			*3950 *8,800	3850 8,650	6980 22'7"



ISO 10567:2007



*Indicates that the load is limited by hydraulic lifting capacity rather than tipping load. The above loads are in compliance with hydraulic excavator lift capacity standard ISO 10567:2007. They do not exceed 87% of hydraulic lifting capacity or 75% of tipping load. Weight of all lifting accessories must be deducted from the above lifting capacities. Lifting capacities are based on the machine standing on a firm, uniform supporting surface. The use of a work tool attachment point to handle/lift objects, could affect the machine lift performance.

Max Length of VAB.









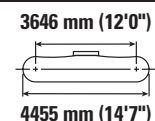
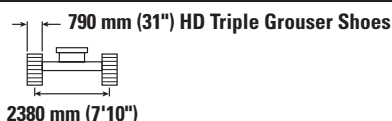
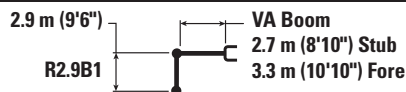

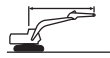
Lift capacity stays with ±5% for all available track shoes.

Always refer to the appropriate Operation and Maintenance Manual for specific product information.

325 Hydraulic Excavator Specifications

Variable Angle Boom Lift Capacities – Counterweight: 6.7 mt (14,800 lb) – without Bucket, Heavy Lift: On



		3000 mm/10'0"		4500 mm/15'0"		6000 mm/20'0"		7500 mm/25'0"				mm ft/in
												
9000 mm 30'0"	kg lb			*6650 *13,700	*6650 *13,700					*4950 *11,150	*4950 *11,150	5120 16'1"
7500 mm 25'0"	kg lb			*7000 *15,400	*7000 *15,400	*6400 *13,450	5900 12,550			*4200 *9,350	*4200 *9,350	6740 21'9"
6000 mm 20'0"	kg lb			*7350 *16,100	*7350 *16,100	*7150 *15,550	5800 12,450	*5250 *9,650	4000 8,500	*3950 *8,650	3750 8,350	7740 25'2"
4500 mm 15'0"	kg lb	*13 750 *29,500	*13 750 *29,500	*9550 *20,600	8700 18,700	*7550 *16,350	5550 11,950	*6050 *13,100	3900 8,400	*3850 *8,450	3250 7,150	8360 27'4"
3000 mm 10'0"	kg lb			*10 700 *23,150	7950 17,150	*8050 *17,400	5250 11,300	6200 13,300	3750 8,100	*3900 *8,600	3000 6,600	8680 28'5"
1500 mm 5'0"	kg lb			*11 250 *24,350	7350 15,850	*8300 *17,950	4950 10,650	6000 12,950	3600 7,800	*4100 *9,050	2900 6,400	8730 28'7"
0 mm 0'0"	kg lb			*10 700 *23,200	7100 15,250	*8050 *17,400	4750 10,250	5900 12,700	3500 7,550	*4500 *9,900	2950 6,500	8520 27'11"
-1500 mm -5'0"	kg lb	*10 150 *23,000	*10 150 *23,000	*9200 *20,000	7050 15,150	*7150 *15,400	4700 10,100	*5300 *11,200	3500 7,550	*4450 *9,750	3250 7,100	8020 26'3"
-3000 mm -10'0"	kg lb			*6850 *14,700	*6850 *14,700	*5300 *11,250	4750 10,250			*3950 *8,800	3950 8,750	6980 22'7"



ISO 10567:2007



*Indicates that the load is limited by hydraulic lifting capacity rather than tipping load. The above loads are in compliance with hydraulic excavator lift capacity standard ISO 10567:2007. They do not exceed 87% of hydraulic lifting capacity or 75% of tipping load. Weight of all lifting accessories must be deducted from the above lifting capacities. Lifting capacities are based on the machine standing on a firm, uniform supporting surface. The use of a work tool attachment point to handle/lift objects, could affect the machine lift performance.

Max Length of VAB.

Lift capacity stays with ±5% for all available track shoes.

Always refer to the appropriate Operation and Maintenance Manual for specific product information.

325 Hydraulic Excavator Specifications

Bucket Specifications and Compatibility

	Linkage	Width		Capacity		Weight		Fill	4.9 mt (10,800 lb) Counterweight				6.7 mt (14,800 lb) Counterweight		8.3 mt (18,300 lb) Counterweight			
		mm	in	m³	yd³	kg	lb		%	With Blade Up in Front				No Blade		No Blade		
										Reach Boom	HD Reach Boom		VA Boom	Reach Boom	VA Boom	Reach Boom	HD Reach Boom	
											R2.9 (9'6")	R2.9 (9'6")						HD R2.9 (9'6")
Pin-On (No Quick Coupler)																		
General Duty	B	600	24	0.46	0.61	555	1,223	100	●	●	●	●	●	●	●	●	●	●
	B	750	30	0.64	0.84	626	1,380	100	●	●	●	●	●	●	●	●	●	●
	B	1300	51	1.30	1.70	835	1,841	100	⊖	⊖	⊖	○	⊙	⊖	●	●	●	
	B	1400	55	1.43	1.87	879	1,937	100	X	X	X	X	X	X	X	X	X	X
General Duty (No Bucket Adjuster)	B	600	24	0.46	0.60	550	1,212	100	●	●	●	●	●	●	●	●	●	●
	B	750	30	0.64	0.84	621	1,368	100	●	●	●	●	●	●	●	●	●	●
	B	1000	39	0.93	1.22	717	1,580	100	●	●	●	⊙	●	●	●	●	●	●
	B	1200	48	1.19	1.56	807	1,778	100	⊙	⊙	⊙	⊖	●	⊙	●	●	●	●
	B	1400	55	1.43	1.87	874	1,926	100	X	X	X	X	X	X	X	X	X	X
Heavy Duty	B	1050	42	1.00	1.31	892	1,967	100	●	●	⊙	⊖	●	⊙	●	●	●	●
	B	1200	48	1.19	1.56	917	2,022	100	⊖	⊖	⊖	○	●	⊖	●	●	●	●
	B	1300	52	1.30	1.70	974	2,148	100	⊖	⊖	⊖	○	⊙	⊖	●	●	●	
Severe Duty	B	1050	42	1.00	1.31	948	2,091	90	●	●	●	⊙	●	●	●	●	●	●
	B	1200	48	1.20	1.57	1011	2,229	90	⊙	⊙	⊖	⊖	●	⊖	●	●	●	●
Ditch Cleaning	B	2000	78	1.22	1.60	869	1,916	100	⊖	⊖	⊖	○	●	⊖	●	●	●	●
Ditch Cleaning Tilt	B	2000	79	1.23	1.61	1096	2,417	100	⊖	⊖	○	○	⊙	⊖	●	●	●	●
Maximum load with pin-on (payload + bucket)									kg	2900	2940	2845	2600	3285	2865	3780	3830	3730
									lb	6,393	6,482	6,272	5,732	7,242	6,316	8,333	8,444	8,223
With Pin Grabber Coupler																		
General Duty	B	600	24	0.46	0.61	555	1,223	100	●	●	●	●	●	●	●	●	●	●
	B	750	30	0.64	0.84	626	1,380	100	●	●	●	●	●	●	●	●	●	●
	B	1300	51	1.30	1.70	835	1,841	100	○	○	○	◇	⊖	○	⊙	⊙	⊙	⊙
	B	1400	55	1.43	1.87	879	1,937	100	◇	○	◇	◇	⊖	◇	⊙	⊙	⊙	⊖
General Duty	B	600	24	0.46	0.60	550	1,212	100	●	●	●	●	●	●	●	●	●	●
	B	750	30	0.64	0.84	621	1,368	100	●	●	●	●	●	●	●	●	●	●
	B	1000	39	0.93	1.22	717	1,580	100	⊙	⊙	⊙	⊖	●	⊙	●	●	●	●
	B	1200	48	1.19	1.56	807	1,778	100	○	⊖	○	○	⊙	○	●	●	●	●
	B	1400	55	1.43	1.87	874	1,926	100	◇	○	◇	◇	⊖	◇	⊙	⊙	⊙	⊖
Heavy Duty	B	1050	42	1.00	1.31	892	1,967	100	⊖	⊖	⊖	○	●	⊖	●	●	●	●
	B	1200	48	1.19	1.56	917	2,022	100	○	○	○	◇	⊖	○	●	●	●	●
	B	1300	52	1.30	1.70	974	2,148	100	○	○	◇	◇	⊖	◇	⊙	⊙	⊙	⊙
Severe Duty	B	1050	42	1.00	1.31	948	2,091	90	⊖	⊙	⊖	○	●	⊖	●	●	●	●
	B	1200	48	1.20	1.57	1011	2,229	90	○	○	○	◇	⊙	○	●	●	●	●
Ditch Cleaning	B	2000	78	1.22	1.60	869	1,916	100	○	○	○	◇	⊖	○	●	●	●	●
Ditch Cleaning Tilt	B	2000	79	1.23	1.61	1096	2,417	100	◇	○	◇	◇	⊖	◇	⊙	⊙	⊙	⊙
Maximum load with coupler (payload + bucket)									kg	2478	2518	2423	2178	2863	2443	3358	3408	3308
									lb	5,463	5,552	5,343	4,802	6,313	5,387	7,404	7,514	7,294

The above loads are in compliance with hydraulic excavator standard EN474-5:2006 + A3:2013, they do not exceed 87% of hydraulic lifting capacity or 75% of tipping capacity with front linkage fully extended at ground line with bucket curled. Capacity based on ISO 7451:2007. Bucket weight with General Duty tips.

Maximum Material Density:

- 2100 kg/m³ (3,500 lb/yd³)
- ⊙ 1800 kg/m³ (3,000 lb/yd³)
- ⊖ 1500 kg/m³ (2,500 lb/yd³)
- 1200 kg/m³ (2,000 lb/yd³)
- ◇ 900 kg/m³ (1,500 lb/yd³)
- X Not Recommended

Caterpillar recommends using appropriate work tools to maximize the value customers receive from our products. Use of work tools, including buckets, which are outside of Caterpillar's recommendations or specifications for weight, dimensions, flows, pressures, etc. may result in less-than-optimal performance, including but not limited to reductions in production, stability, reliability, and component durability. Improper use of a work tool resulting in sweeping, prying, twisting and/or catching of heavy loads will reduce the life of the boom and stick.

(continued on next page)

325 Hydraulic Excavator Specifications

Bucket Specifications and Compatibility (continued)

	Linkage	Width		Capacity		Weight		Fill	4.9 mt (10,800 lb) Counterweight				6.7 mt (14,800 lb) Counterweight		8.3 mt (18,300 lb) Counterweight			
		mm	in	m ³	yd ³	kg	lb		%	With Blade Up in Front				No Blade		No Blade		
										Reach Boom	HD Reach Boom		VA Boom	Reach Boom	VA Boom	Reach Boom	HD Reach Boom	
											R2.9 (9'6")	R2.9 (9'6")						HD R2.9 (9'6")
With CW40 Coupler																		
General Duty	B	900	36	0.81	1.06	664	1,463	100	●	●	●	●	●	●	●	●	●	
	B	1050	42	1.00	1.31	711	1,567	100	⊙	⊙	⊙	⊖	●	⊙	●	●	●	
	B	1200	48	1.19	1.56	781	1,721	100	⊖	⊖	⊖	○	⊙	⊖	●	●	●	
	B	1300	51	1.30	1.70	813	1,791	100	○	⊖	○	○	⊙	○	●	●	●	
General Duty with Leveling Edge	B	650	26	0.70	0.92	567	1,249	100	●	●	●	●	●	●	●	●	●	
	B	800	31	0.68	0.89	614	1,353	100	●	●	●	●	●	●	●	●	●	
	B	1200	47	1.19	1.56	787	1,734	100	⊖	⊖	⊖	○	⊙	⊖	●	●	●	
	B	1400	55	1.43	1.87	855	1,884	100	○	○	○	◇	⊖	○	⊙	⊙	⊙	
Heavy Duty	B	600	24	0.46	0.61	618	1,363	100	●	●	●	●	●	●	●	●	●	
	B	1200	48	1.19	1.56	886	1,953	100	⊖	⊖	⊖	○	⊙	⊖	●	●	●	
	B	1300	52	1.30	1.71	944	2,081	100	X	X	X	X	X	X	X	X	X	
Ditch Cleaning	B	2100	83	1.29	1.69	792	1,746	100	⊖	⊖	○	○	⊙	○	●	●	●	
	B	2100	83	1.46	1.91	809	1,784	100	○	○	○	◇	⊖	○	⊙	⊙	⊙	
	B	1800	72	1.50	1.96	775	1,709	100	○	○	○	◇	⊖	○	⊙	⊙	⊙	
	B	1800	72	1.50	1.96	737	1,624	100	○	○	○	◇	⊖	○	⊙	⊙	⊙	
	B	2100	83	1.76	2.31	864	1,905	100	◇	◇	◇	X	○	◇	⊖	⊖	⊖	
Ditch Cleaning Tilt	B	2000	79	1.23	1.61	1161	2,560	100	○	○	○	◇	⊖	○	⊙	⊙	⊙	
Maximum load with coupler (payload + bucket)									kg	2650	2690	2595	2350	3035	2615	3530	3580	3480
									lb	5,842	5,930	5,721	5,181	6,691	5,765	7,782	7,893	7,672
With CW40S Coupler																		
General Duty	B	600	24	0.46	0.61	508	1,119	100	●	●	●	●	●	●	●	●	●	
	B	750	30	0.64	0.84	592	1,305	100	●	●	●	●	●	●	●	●	●	
	B	900	36	0.81	1.06	661	1,457	100	●	●	●	●	●	●	●	●	●	
	B	1300	51	1.30	1.70	810	1,785	100	⊖	⊖	○	○	⊙	○	●	●	●	
	B	1400	55	1.43	1.87	845	1,862	100	○	○	○	◇	⊖	○	⊙	⊙	⊙	
Heavy Duty	B	600	24	0.46	0.61	585	1,289	100	●	●	●	●	●	●	●	●	●	
	B	1200	48	1.19	1.56	875	1,928	100	⊖	⊖	⊖	○	⊙	⊖	●	●	●	
	B	1300	52	1.30	1.70	931	2,052	100	X	X	X	X	X	X	X	X	X	
Ditch Cleaning	B	2000	78	1.22	1.60	815	1,797	100	⊖	⊖	⊖	○	⊙	⊖	●	●	●	
	B	2200	87	1.36	1.78	880	1,940	100	○	○	○	◇	⊖	○	⊙	●	⊙	
Ditch Cleaning Tilt	B	2000	79	1.23	1.61	1142	2,518	100	○	○	○	◇	⊖	○	⊙	●	⊙	
Maximum load with coupler (payload + bucket)									kg	2669	2709	2614	2369	3054	2634	3549	3599	3499
									lb	5,884	5,972	5,763	5,223	6,733	5,807	7,824	7,934	7,714

The above loads are in compliance with hydraulic excavator standard EN474-5:2006 + A3:2013, they do not exceed 87% of hydraulic lifting capacity or 75% of tipping capacity with front linkage fully extended at ground line with bucket curled.

Capacity based on ISO 7451:2007.

Bucket weight with General Duty tips.

Maximum Material Density:

- 2100 kg/m³ (3,500 lb/yd³)
- ⊙ 1800 kg/m³ (3,000 lb/yd³)
- ⊖ 1500 kg/m³ (2,500 lb/yd³)
- 1200 kg/m³ (2,000 lb/yd³)
- ◇ 900 kg/m³ (1,500 lb/yd³)
- X Not Recommended

Caterpillar recommends using appropriate work tools to maximize the value customers receive from our products. Use of work tools, including buckets, which are outside of Caterpillar's recommendations or specifications for weight, dimensions, flows, pressures, etc. may result in less-than-optimal performance, including but not limited to reductions in production, stability, reliability, and component durability. Improper use of a work tool resulting in sweeping, prying, twisting and/or catching of heavy loads will reduce the life of the boom and stick.

(continued on next page)

325 Hydraulic Excavator Specifications

Bucket Specifications and Compatibility (continued)

	Linkage	Width		Capacity		Weight		Fill	4.9 mt (10,800 lb) Counterweight				6.7 mt (14,800 lb) Counterweight		8.3 mt (18,300 lb) Counterweight			
		mm	in	m ³	yd ³	kg	lb		%	With Blade Up in Front				No Blade		No Blade		
										Reach Boom	HD Reach Boom		VA Boom	Reach Boom	VA Boom	Reach Boom	HD Reach Boom	
											R2.9 (9'6")	R2.9 (9'6")						HD R2.9 (9'6")
PIN-ON, TRS18 S70																		
Heavy Duty – Grading	B	1600	63	1.00	1.31	691	1,523	100	⊖	⊖	⊖	○	⊙	⊖	●	●	●	
	B	1800	71	1.10	1.44	758	1,671	100	○	○	○	◇	⊖	○	●	●	●	
Heavy Duty – Digging	B	1150	45	0.90	1.18	778	1,715	100	⊖	⊖	⊖	○	●	⊖	●	●	●	
	B	1250	49	1.10	1.44	850	1,874	100	○	○	○	◇	⊖	○	●	●	●	
Heavy Duty – Trenching	B	600	24	0.55	0.72	460	1,014	100	●	●	●	●	●	●	●	●	●	
Maximum load with pin-on (payload + bucket)									kg	2218	2258	2163	1918	2603	2183	3098	3148	3048
									lb	4,889	4,978	4,769	4,228	5,739	4,813	6,830	6,940	6,720
With S70, TRS18 S70																		
Heavy Duty – Grading	B	1600	63	1.00	1.31	691	1,523	100	○	○	○	◇	⊖	○	●	●	●	
	B	1800	71	1.10	1.44	758	1,671	100	◇	◇	◇	X	⊖	◇	⊙	⊙	⊙	
Heavy Duty – Digging	B	1150	45	0.90	1.18	778	1,715	100	○	○	○	◇	⊙	○	●	●	●	
	B	1250	49	1.10	1.44	850	1,874	100	◇	◇	◇	X	○	◇	⊙	⊙	⊙	
Heavy Duty – Trenching	B	600	24	0.55	0.72	460	1,014	100	●	●	●	●	●	●	●	●	●	
Maximum load with pin-on (payload + bucket)									kg	1963	2003	1908	1663	2348	1928	2843	2893	2793
									lb	4,327	4,416	4,206	3,666	5,176	4,251	6,268	6,378	6,158
PIN-ON, TRS18 HCS70/55																		
Heavy Duty – Grading	B	1600	63	1.00	1.31	694	1,530	100	⊖	⊖	○	◇	⊙	○	●	●	●	
	B	1800	71	1.10	1.44	761	1,678	100	○	○	○	◇	⊖	○	●	●	⊙	
Heavy Duty – Digging	B	1150	45	0.90	1.18	774	1,706	100	⊖	⊖	⊖	◇	⊙	⊖	●	●	●	
	B	1250	49	1.10	1.44	846	1,865	100	○	○	◇	X	⊖	◇	⊙	●	⊙	
Heavy Duty – Trenching	B	600	24	0.55	0.72	482	1,063	100	●	●	●	●	●	●	●	●	●	
Maximum load with pin-on (payload + bucket)									kg	2122	2162	2067	1822	2507	2087	3002	3052	2952
									lb	4,678	4,766	4,557	4,017	5,527	4,601	6,618	6,729	6,508
HCS70/55, TRS18 HCS70/55																		
Grading	B	1600	63	1.00	1.31	694	1,530	100	◇	◇	◇	X	○	◇	⊙	⊙	⊙	
	B	1800	71	1.10	1.44	761	1,678	100	◇	◇	X	X	○	X	⊖	⊙	⊖	
Digging	B	1150	45	0.90	1.18	774	1,706	100	◇	◇	◇	X	⊖	◇	●	●	⊙	
	B	1250	49	1.10	1.44	846	1,865	100	X	X	X	X	○	X	⊖	⊖	⊖	
Trenching	B	600	24	0.55	0.72	482	1,063	100	●	●	●	⊖	●	●	●	●	●	
Maximum load with pin-on (payload + bucket)									kg	1715	1755	1660	1415	2100	1680	2595	2645	2545
									lb	3,780	3,869	3,660	3,120	4,630	3,704	5,721	5,831	5,611

The above loads are in compliance with hydraulic excavator standard EN474-5:2006 + A3:2013, they do not exceed 87% of hydraulic lifting capacity or 75% of tipping capacity with front linkage fully extended at ground line with bucket curled.

Capacity based on ISO 7451:2007.

Bucket weight with General Duty tips.

Maximum Material Density:

- 2100 kg/m³ (3,500 lb/yd³)
- ⊙ 1800 kg/m³ (3,000 lb/yd³)
- ⊖ 1500 kg/m³ (2,500 lb/yd³)
- 1200 kg/m³ (2,000 lb/yd³)
- ◇ 900 kg/m³ (1,500 lb/yd³)
- X Not Recommended

Caterpillar recommends using appropriate work tools to maximize the value customers receive from our products. Use of work tools, including buckets, which are outside of Caterpillar's recommendations or specifications for weight, dimensions, flows, pressures, etc. may result in less-than-optimal performance, including but not limited to reductions in production, stability, reliability, and component durability. Improper use of a work tool resulting in sweeping, prying, twisting and/or catching of heavy loads will reduce the life of the boom and stick.

325 Hydraulic Excavator Specifications

Attachments Offering Guide

Not all Attachments are available in all regions. Consult your Cat dealer for configurations available in your region.

Match
 * Working range front only
 † Allowed usage on machine less than 50%
 No Match

PIN-ON ATTACHMENTS

Counterweight		4.9 mt (10,800 lb)				
Blade		With Blade Up in Front				
Boom Type		Reach		HD Reach		VA
Stick Size		R2.9 (9'6")	HD R2.9 (9'6")	R2.9 (9'6")	HD R2.9 (9'6")	R2.9 (9'6")
Hydraulic Hammers	H120 GC S	✓	✓	✓	✓	✓
	H120 S	✓	✓	✓	✓	✓
	H130 GC S		✓		✓	
	H130 S	✓†	✓	✓†	✓	✓†
Multi-Processors	MP318 Concrete Cutter Jaw	✓	✓	✓	✓	✓
	MP318 Demolition Jaw	✓	✓	✓	✓	✓
	MP318 Pulverizer Jaw	✓	✓	✓	✓	✓*
	MP318 Shear Jaw	✓	✓	✓	✓	✓
	MP318 Universal Jaw	✓	✓	✓	✓	✓
	MP324 Concrete Cutters					
	MP324 Demolition Jaw					
	MP324 Shear Jaw					
	MP324 Tank Shear Jaw					
	MP324 Universal Jaw					
Demolition and Sorting Grapples	G317 GC	✓	✓	✓	✓	✓
	G318	✓	✓	✓	✓	✓
	G318 WH-800	✓	✓	✓	✓	✓
	G318 WH-1100	✓	✓	✓	✓	✓*
Mobile Scrap and Demolition Shears	S3025 Flat Top	✓	✓	✓	✓	
Pulverizers	P218 Secondary Pulverizer	✓	✓	✓	✓	✓*
	P318 Primary Pulverizer	✓	✓	✓	✓	✓*
Compactors (Vibratory Plate)	CVP110	✓	✓	✓	✓	✓
Rotary Cutters	RC20	✓	✓	✓	✓	✓

(continued on next page)

325 Hydraulic Excavator Specifications

Attachments Offering Guide *(continued)*

Not all Attachments are available in all regions. Consult your Cat dealer for configurations available in your region.

1800 kg/m³ (3,000 lb/yd³)
 1200 kg/m³ (2,000 lb/yd³)
 600 kg/m³ (1,000 lb/yd³)
 No Match

PIN-ON ATTACHMENTS *(continued)*

Counterweight		4.9 mt (10,800 lb)				
Blade		With Blade Up in Front				
Boom Type		Reach		HD Reach		VA
Stick Size		R2.9 (9'6")	HD R2.9 (9'6")	R2.9 (9'6")	HD R2.9 (9'6")	R2.9 (9'6")
Orange Peel Grapples	GSH420-500	●	●	●	●	●
	GSH420-600	●	●	●	●	●
	GSH420-750	●	●	●	●	○
	GSH425-750	○	○	○	○	○
	GSH425-950	○		○		
	GSH520-500	●	●	●	●	●
	GSH520-600	●	●	●	●	●
	GSH520-750	●	○	●	○	○
	GSH525-750	○				
	GSV420-400	●	●	●	●	●
	GSV420-500	●	●	●	●	●
	GSV420-600	●	●	●	●	●
	GSV420-750	●	●	●	●	●
	GSV420-1250	◇	◇	◇	◇	◇
	GSV425-600	●	●	●	●	○
	GSV425-750	○	○	○	○	○
	GSV425-950	○	○	○		
	GSV425-1550	◇	◇	◇	◇	
	GSV520-400	●	●	●	●	●
	GSV520-500	●	●	●	●	●
GSV520-600	●	●	●	●	●	
GSV520-750	●	●	●	●	○	
GSV525-600	○	○	○	○	○	
GSV525-750	○	○	○	○		
Clamshell Grapples	CTV15-1000	○	○	○	○	○
	CTV15-1200	○				

(continued on next page)

325 Hydraulic Excavator Specifications

Attachments Offering Guide *(continued)*

Not all Attachments are available in all regions. Consult your Cat dealer for configurations available in your region.

Match
 * Working range front only
 † Allowed usage on machine less than 50%
 No Match

CAT PIN GRABBER COUPLER ATTACHMENTS

Counterweight		4.9 mt (10,800 lb)				
Blade		With Blade Up in Front				
Boom Type		Reach		HD Reach		VA
Stick Size		R2.9 (9'6")	HD R2.9 (9'6")	R2.9 (9'6")	HD R2.9 (9'6")	R2.9 (9'6")
Hydraulic Hammers	H120 GC S	✓†	✓	✓†	✓	✓†
	H120 S	✓†	✓	✓†	✓	✓†
	H130 GC S	✓†*				
	H130 S	✓†	✓	✓†	✓	✓†*
Multi-Processors	MP318 Concrete Cutter Jaw	✓	✓*	✓*	✓*	
	MP318 Demolition Jaw	✓	✓*	✓*	✓*	
	MP318 Pulverizer Jaw	✓*				
	MP318 Shear Jaw	✓	✓	✓	✓*	
	MP318 Universal Jaw	✓*	✓*	✓*	✓*	
Demolition and Sorting Grapples	G317 GC	✓	✓	✓	✓	✓*
	G318	✓	✓*	✓*	✓*	
	G318 WH-800	✓	✓	✓	✓	
Pulverizers	P218 Secondary Pulverizer	✓*				
	P318 Primary Pulverizer	✓*				
Compactors (Vibratory Plate)	CVP110	✓	✓	✓	✓	✓
Rotary Cutters	RC20	✓	✓	✓	✓	✓

(continued on next page)

325 Hydraulic Excavator Specifications

Attachments Offering Guide *(continued)*

Not all Attachments are available in all regions. Consult your Cat dealer for configurations available in your region.

Match
 * Working range front only
 † Allowed usage on machine less than 50%
 No Match

CW-40s DEDICATED COUPLER ATTACHMENTS

Counterweight		4.9 mt (10,800 lb)				
Blade		With Blade Up in Front				
Boom Type		Reach		HD Reach		VA
Stick Size		R2.9 (9'6")	HD R2.9 (9'6")	R2.9 (9'6")	HD R2.9 (9'6")	R2.9 (9'6")
Hydraulic Hammers	H120 GC S	✓†	✓	✓†	✓	✓†
	H120 S	✓†	✓	✓†	✓	✓†
	H130 S	✓†	✓	✓†	✓	✓†
Multi-Processors	MP318 Concrete Cutter Jaw	✓	✓	✓	✓	✓*
	MP318 Demolition Jaw	✓	✓	✓	✓	✓*
	MP318 Pulverizer Jaw	✓	✓*	✓	✓*	
	MP318 Shear Jaw	✓	✓	✓	✓	✓*
	MP318 Universal Jaw	✓	✓	✓	✓	✓*
Demolition and Sorting Grapples	G317 GC	✓	✓	✓	✓	✓
	G318	✓	✓	✓	✓	✓*
	G318 WH-800	✓	✓	✓	✓	✓
	G318 WH-1100	✓	✓*	✓	✓*	
Mobile Scrap and Demolition Shears	S3025 Flat Top	✓*				
Pulverizers	P218 Secondary Pulverizer	✓	✓*	✓	✓*	
	P318 Primary Pulverizer	✓	✓*	✓	✓*	
Compactors (Vibratory Plate)	CVP110	✓	✓	✓	✓	✓
Rotary Cutters	RC20	✓	✓	✓	✓	✓

(continued on next page)

325 Hydraulic Excavator Specifications

Attachments Offering Guide *(continued)*

Not all Attachments are available in all regions. Consult your Cat dealer for configurations available in your region.

Match
 * Working range front only
 † Allowed usage on machine less than 50%
 No Match

CW-40 DEDICATED COUPLER ATTACHMENTS

Counterweight		4.9 mt (10,800 lb)				
Blade		With Blade Up in Front				
Boom Type		Reach		HD Reach		VA
Stick Size		R2.9 (9'6")	HD R2.9 (9'6")	R2.9 (9'6")	HD R2.9 (9'6")	R2.9 (9'6")
Hydraulic Hammers	H120 GC S	✓†	✓	✓†	✓	✓†
	H120 S	✓†	✓	✓†	✓	✓†
	H130 GC S	✓†*		✓†*		
	H130 S	✓†	✓	✓†	✓	✓†
Multi-Processors	MP318 Concrete Cutter Jaw	✓	✓	✓	✓	✓*
	MP318 Demolition Jaw	✓	✓	✓	✓	✓*
	MP318 Pulverizer Jaw	✓	✓*	✓	✓*	
	MP318 Shear Jaw	✓	✓	✓	✓	✓*
	MP318 Universal Jaw	✓	✓	✓	✓	✓*
Demolition and Sorting Grapples	G317 GC	✓	✓	✓	✓	✓
	G317 GC fixed CAN	✓	✓	✓	✓	✓
	G318	✓	✓	✓	✓	✓*
	G318 fixed CAN	✓	✓	✓	✓	✓
	G318 WH-800	✓	✓	✓	✓	✓
	G318 WH-1100	✓	✓*	✓*	✓*	
Mobile Scrap and Demolition Shears	S3025 Flat Top	✓*				
Pulverizers	P218 Secondary Pulverizer	✓	✓*	✓	✓*	
	P318 Primary Pulverizer	✓	✓*	✓	✓*	
Compactors (Vibratory Plate)	CVP110	✓	✓	✓	✓	✓
Rotary Cutters	RC20	✓	✓	✓	✓	✓

(continued on next page)

325 Hydraulic Excavator Specifications

Attachments Offering Guide *(continued)*

Not all Attachments are available in all regions. Consult your Cat dealer for configurations available in your region.

Match * Working range front only No Match

HCCW40 DEDICATED COUPLER ATTACHMENTS

Counterweight		4.9 mt (10,800 lb)				
Blade		With Blade Up in Front				
Boom Type		Reach		HD Reach		VA
Stick Size		R2.9 (9'6")	HD R2.9 (9'6")	R2.9 (9'6")	HD R2.9 (9'6")	R2.9 (9'6")
Hydraulic Hammers	H120 GC S	✓	✓	✓	✓	✓*
	H120 S	✓	✓	✓	✓	✓
	H130 GC S					
	H130 S	✓	✓	✓	✓	✓*
Multi-Processors	MP318 Concrete Cutter Jaw	✓*	✓*	✓*	✓*	
	MP318 Demolition Jaw	✓*	✓*	✓*	✓*	
	MP318 Pulverizer Jaw					
	MP318 Shear Jaw	✓	✓*	✓	✓*	
	MP318 Universal Jaw	✓*	✓*	✓*		
Demolition and Sorting Grapples	G317 GC	✓	✓	✓	✓	✓*
	G318	✓*	✓*	✓*	✓*	
	G318 WH-800	✓	✓*	✓	✓*	
	G318 WH-1100					
Pulverizers	P218 Secondary Pulverizer					
	P318 Primary Pulverizer					
Compactors (Vibratory Plate)	CVP110	✓	✓	✓	✓	✓
Rotary Cutters	RC20	✓	✓	✓	✓	✓

(continued on next page)

325 Hydraulic Excavator Specifications

Attachments Offering Guide *(continued)*

Not all Attachments are available in all regions. Consult your Cat dealer for configurations available in your region.

Match
 * Working range front only
 † Allowed usage on machine less than 50%
 No Match

S70 DEDICATED COUPLER ATTACHMENTS

Counterweight		4.9 mt (10,800 lb)				
Blade		With Blade Up in Front				
Boom Type		Reach		HD Reach		VA
Stick Size		R2.9 (9'6")	HD R2.9 (9'6")	R2.9 (9'6")	HD R2.9 (9'6")	R2.9 (9'6")
Hydraulic Hammers	H120 GC S	✓†	✓	✓†	✓	✓†
	H120 S	✓†	✓	✓†	✓	✓†
	H130 S	✓†	✓	✓†	✓	✓†
Multi-Processors	MP318 Concrete Cutter Jaw	✓	✓	✓	✓	
	MP318 Demolition Jaw	✓	✓	✓	✓	
	MP318 Pulverizer Jaw	✓*	✓*	✓*	✓*	
	MP318 Shear Jaw	✓	✓	✓	✓	✓*
	MP318 Universal Jaw	✓*	✓	✓	✓	
Demolition and Sorting Grapples	G317 GC	✓	✓	✓	✓	✓
	G318	✓	✓	✓	✓	
	G318 WH-800	✓	✓	✓	✓	✓*
	G318 WH-1100	✓*		✓*		
Pulverizers	P218 Secondary Pulverizer	✓	✓*	✓*	✓*	
	P318 Primary Pulverizer	✓*	✓*	✓*	✓*	
Compactors (Vibratory Plate)	CVP110	✓	✓	✓	✓	✓
Rotary Cutters	RC20	✓	✓	✓	✓	✓

(continued on next page)

325 Hydraulic Excavator Specifications

Attachments Offering Guide *(continued)*

Not all Attachments are available in all regions. Consult your Cat dealer for configurations available in your region.

Match
 * Working range front only
 † Allowed usage on machine less than 50%
 No Match

HCS70 COUPLER ATTACHMENTS

Counterweight		4.9 mt (10,800 lb)				
Blade		With Blade Up in Front				
Boom Type		Reach		HD Reach		VA
Stick Size		R2.9 (9'6")	HD R2.9 (9'6")	R2.9 (9'6")	HD R2.9 (9'6")	R2.9 (9'6")
Hydraulic Hammers	H120 S	✓†	✓	✓†	✓	✓†
	H130 S	✓†	✓	✓†	✓	✓†*
Multi-Processors	MP318 Concrete Cutter Jaw	✓*	✓*	✓*	✓*	
	MP318 Demolition Jaw	✓*	✓*	✓*	✓*	
	MP318 Shear Jaw	✓	✓*	✓	✓*	
	MP318 Universal Jaw	✓*	✓*	✓*	✓*	
Demolition and Sorting Grapples	G317 GC	✓	✓	✓	✓	✓*
	G318	✓*	✓*	✓*	✓*	
	G318 WH-800	✓	✓	✓	✓*	
Pulverizers	P218 Secondary Pulverizer	✓*				
Compactors (Vibratory Plate)	CVP110	✓	✓	✓	✓	✓
Rotary Cutters	RC20	✓	✓	✓	✓	✓

HCS70/55 ATTACHMENTS

Counterweight		4.9 mt (10,800 lb)				
Blade		With Blade Up in Front				
Boom Type		Reach		HD Reach		VA
Stick Size		R2.9 (9'6")	HD R2.9 (9'6")	R2.9 (9'6")	HD R2.9 (9'6")	R2.9 (9'6")
Hydraulic Hammers	H120 S	✓†	✓	✓†	✓	✓†
	H130 S	✓†	✓	✓†	✓	✓†*
Multi-Processors	MP318 Concrete Cutter Jaw	✓*	✓*	✓*	✓*	
	MP318 Demolition Jaw	✓*	✓*	✓*	✓*	
	MP318 Shear Jaw	✓	✓*	✓*	✓*	
	MP318 Universal Jaw	✓*		✓*		
Demolition and Sorting Grapples	G317 GC	✓	✓	✓	✓	✓*
	G318	✓*	✓*	✓*	✓*	
	G318 WH-800	✓	✓*	✓	✓*	
Compactors (Vibratory Plate)	CVP110	✓	✓	✓	✓	✓
Rotary Cutters	RC20	✓	✓	✓	✓	✓

(continued on next page)

325 Hydraulic Excavator Specifications

Attachments Offering Guide *(continued)*

Not all Attachments are available in all regions. Consult your Cat dealer for configurations available in your region.

Match
 * Working range front only
 † Allowed usage on machine less than 50%
 No Match

TRS18 (PIN-ON TOP/CW-30S BOTTOM) ATTACHMENTS

Some attachments require more hydraulic flow and are best suited with a machine that has HP2 circuits and a tiltrotator with a high flow swivel. Check the hydraulic capability of your machine and tiltrotator and the requirements of your attachment to ensure a proper match.

Counterweight

4.9 mt (10,800 lb)

Blade

With Blade Up in Front

Boom Type

Reach

HD Reach

VA

Stick Size

R2.9
(9'6")

HD R2.9
(9'6")

R2.9
(9'6")

HD R2.9
(9'6")

R2.9
(9'6")

Hydraulic Hammers

H115 S

✓

✓

✓

✓

✓

H120 GC S

✓†*

✓*

✓†*

✓*

H120 S

✓†

✓

✓†

✓

✓†*

Demolition and Sorting Grapples

G217 GC

✓

✓

✓

✓

✓*

G217 GC fixed CAN

✓

✓

✓

✓

✓

Compactors (Vibratory Plate)

CVP75

✓

✓

✓

✓

✓

CVP110

✓

✓

✓

✓

✓

NOTE: Use hammers on tiltrotators less than 10% of working hours per year or maximum 200 hours per year. Refer to your Operation and Maintenance Manual for recommended hydraulic flow requirements.

TRS18 (CW-30S TOP/CW-30S BOTTOM) ATTACHMENTS

Some attachments require more hydraulic flow and are best suited with a machine that has HP2 circuits and a tiltrotator with a high flow swivel. Check the hydraulic capability of your machine and tiltrotator and the requirements of your attachment to ensure a proper match.

Counterweight

4.9 mt (10,800 lb)

Blade

With Blade Up in Front

Boom Type

Reach

HD Reach

VA

Stick Size

R2.9
(9'6")

HD R2.9
(9'6")

R2.9
(9'6")

HD R2.9
(9'6")

R2.9
(9'6")

Hydraulic Hammers

H115 S

✓

✓

✓

✓

✓

H120 S

✓†*

✓*

✓†*

✓*

Demolition and Sorting Grapples

G217 GC

✓*

✓*

✓*

✓*

G217 GC fixed CAN

✓

✓

✓

✓*

Compactors (Vibratory Plate)

CVP75

✓

✓

✓

✓

✓

CVP110

✓

✓

✓

✓

✓

NOTE: Use hammers on tiltrotators less than 10% of working hours per year or maximum 200 hours per year. Refer to your Operation and Maintenance Manual for recommended hydraulic flow requirements.

(continued on next page)

325 Hydraulic Excavator Specifications

Attachments Offering Guide (continued)

Not all Attachments are available in all regions. Consult your Cat dealer for configurations available in your region.

Match
 * Working range front only
 † Allowed usage on machine less than 50%
 No Match

TRS18 (PIN-ON TOP/CW-30 BOTTOM) ATTACHMENTS

Some attachments require more hydraulic flow and are best suited with a machine that has HP2 circuits and a tiltrotator with a high flow swivel. Check the hydraulic capability of your machine and tiltrotator and the requirements of your attachment to ensure a proper match.

Counterweight

4.9 mt (10,800 lb)

		With Blade Up in Front				
Blade		Reach		HD Reach		VA
Boom Type		R2.9	HD R2.9	R2.9	HD R2.9	VA
Stick Size		(9'6")	(9'6")	(9'6")	(9'6")	(9'6")
Hydraulic Hammers	H115 S	✓	✓	✓	✓	✓
	H120 GC S	✓†	✓*	✓†*	✓*	
	H120 S	✓†	✓	✓†	✓*	
Demolition and Sorting Grapples	G217 GC	✓	✓	✓	✓	
	G217 GC fixed CAN	✓	✓	✓	✓	✓*
Compactors (Vibratory Plate)	CVP75	✓	✓	✓	✓	✓
	CVP110	✓	✓	✓	✓	✓

NOTE: Use hammers on tiltrotators less than 10% of working hours per year or maximum 200 hours per year. Refer to your Operation and Maintenance Manual for recommended hydraulic flow requirements.

TRS18 (CW-30 TOP/CW-30 BOTTOM) ATTACHMENTS

Some attachments require more hydraulic flow and are best suited with a machine that has HP2 circuits and a tiltrotator with a high flow swivel. Check the hydraulic capability of your machine and tiltrotator and the requirements of your attachment to ensure a proper match.

Counterweight

4.9 mt (10,800 lb)

		With Blade Up in Front				
Blade		Reach		HD Reach		VA
Boom Type		R2.9	HD R2.9	R2.9	HD R2.9	VA
Stick Size		(9'6")	(9'6")	(9'6")	(9'6")	(9'6")
Hydraulic Hammers	H115 S	✓	✓	✓	✓	✓*
Demolition and Sorting Grapples	G217 GC fixed CAN	✓*	✓*	✓*	✓*	
Compactors (Vibratory Plate)	CVP75	✓	✓	✓	✓	✓
	CVP110	✓	✓	✓	✓	✓

NOTE: Use hammers on tiltrotators less than 10% of working hours per year or maximum 200 hours per year. Refer to your Operation and Maintenance Manual for recommended hydraulic flow requirements.

TRS18 (PIN-ON TOP/S70 BOTTOM) ATTACHMENTS

Some attachments require more hydraulic flow and are best suited with a machine that has HP2 circuits and a tiltrotator with a high flow swivel. Check the hydraulic capability of your machine and tiltrotator and the requirements of your attachment to ensure a proper match.

Counterweight

4.9 mt (10,800 lb)

		With Blade Up in Front				
Blade		Reach		HD Reach		VA
Boom Type		R2.9	HD R2.9	R2.9	HD R2.9	VA
Stick Size		(9'6")	(9'6")	(9'6")	(9'6")	(9'6")
Hydraulic Hammers	H115 S	✓	✓	✓	✓	✓
	H120 GC S	✓†	✓	✓†	✓*	
	H120 S	✓†	✓	✓†	✓	✓†*
Demolition and Sorting Grapples	G217 GC	✓	✓	✓	✓	✓*
Compactors (Vibratory Plate)	CVP75	✓	✓	✓	✓	✓
	CVP110	✓	✓	✓	✓	✓

NOTE: Use hammers on tiltrotators less than 10% of working hours per year or maximum 200 hours per year. Refer to your Operation and Maintenance Manual for recommended hydraulic flow requirements.

(continued on next page)

325 Hydraulic Excavator Specifications

Attachments Offering Guide (continued)

Not all Attachments are available in all regions. Consult your Cat dealer for configurations available in your region.

Match
 * Working range front only
 † Allowed usage on machine less than 50%
 No Match

TRS18 (S70 TOP/S70 BOTTOM) ATTACHMENTS

Some attachments require more hydraulic flow and are best suited with a machine that has HP2 circuits and a tiltrotator with a high flow swivel. Check the hydraulic capability of your machine and tiltrotator and the requirements of your attachment to ensure a proper match.

Counterweight

4.9 mt (10,800 lb)

Blade		With Blade Up in Front				
Boom Type		Reach		HD Reach		VA
Stick Size		R2.9 (9'6")	HD R2.9 (9'6")	R2.9 (9'6")	HD R2.9 (9'6")	R2.9 (9'6")
Hydraulic Hammers	H115 S	✓	✓	✓	✓	✓
	H120 S	✓†*	✓*	✓†*		
Demolition and Sorting Grapples	G217 GC	✓*		✓*		
Compactors (Vibratory Plate)	CVP75	✓	✓	✓	✓	✓
	CVP110	✓	✓	✓	✓	✓

NOTE: Use hammers on tiltrotators less than 10% of working hours per year or maximum 200 hours per year. Refer to your Operation and Maintenance Manual for recommended hydraulic flow requirements.

TRS18 (CW-30 TOP/CW-30 BOTTOM) ATTACHMENTS

Some attachments require more hydraulic flow and are best suited with a machine that has HP2 circuits and a tiltrotator with a high flow swivel. Check the hydraulic capability of your machine and tiltrotator and the requirements of your attachment to ensure a proper match.

Counterweight

4.9 mt (10,800 lb)

Blade		With Blade Up in Front				
Boom Type		Reach		HD Reach		VA
Stick Size		R2.9 (9'6")	HD R2.9 (9'6")	R2.9 (9'6")	HD R2.9 (9'6")	R2.9 (9'6")
Hydraulic Hammers	H115 S	✓	✓	✓	✓	✓
	H120 S		✓		✓	
	H120 S	✓†		✓†		
Compactors (Vibratory Plate)	CVP75	✓	✓	✓	✓	✓
	CVP110	✓	✓	✓	✓	✓

NOTE: Use hammers on tiltrotators less than 10% of working hours per year or maximum 200 hours per year. Refer to your Operation and Maintenance Manual for recommended hydraulic flow requirements.

TRS18 (HCS70 TOP/HCS70 BOTTOM) ATTACHMENTS

Some attachments require more hydraulic flow and are best suited with a machine that has HP2 circuits and a tiltrotator with a high flow swivel. Check the hydraulic capability of your machine and tiltrotator and the requirements of your attachment to ensure a proper match.

Counterweight

4.9 mt (10,800 lb)

Blade		With Blade Up in Front				
Boom Type		Reach		HD Reach		VA
Stick Size		R2.9 (9'6")	HD R2.9 (9'6")	R2.9 (9'6")	HD R2.9 (9'6")	R2.9 (9'6")
Hydraulic Hammers	H115 S	✓	✓	✓	✓	✓*
Compactors (Vibratory Plate)	CVP75	✓	✓	✓	✓	✓
	CVP110	✓	✓	✓	✓	✓*

NOTE: Use hammers on tiltrotators less than 10% of working hours per year or maximum 200 hours per year. Refer to your Operation and Maintenance Manual for recommended hydraulic flow requirements.

(continued on next page)

325 Hydraulic Excavator Specifications

Attachments Offering Guide (continued)

Not all Attachments are available in all regions. Consult your Cat dealer for configurations available in your region.

Match
 * Working range front only
 † Allowed usage on machine less than 50%
 No Match

TRS18 (PIN-ON TOP/HCS70/55 BOTTOM) ATTACHMENTS

Some attachments require more hydraulic flow and are best suited with a machine that has HP2 circuits and a tiltrotator with a high flow swivel. Check the hydraulic capability of your machine and tiltrotator and the requirements of your attachment to ensure a proper match.

Counterweight		4.9 mt (10,800 lb)				
Blade		With Blade Up in Front				
Boom Type		Reach		HD Reach		VA
Stick Size		R2.9 (9'6")	HD R2.9 (9'6")	R2.9 (9'6")	HD R2.9 (9'6")	R2.9 (9'6")
Hydraulic Hammers	H115 S	✓	✓	✓	✓	✓
	H120 S	✓†	✓*	✓†	✓*	
Compactors (Vibratory Plate)	CVP75	✓	✓	✓	✓	✓
	CVP110	✓	✓	✓	✓	✓

NOTE: Use hammers on tiltrotators less than 10% of working hours per year or maximum 200 hours per year. Refer to your Operation and Maintenance Manual for recommended hydraulic flow requirements.

TRS18 (HCS70/55 TOP/HCS70/55 BOTTOM) ATTACHMENTS

Some attachments require more hydraulic flow and are best suited with a machine that has HP2 circuits and a tiltrotator with a high flow swivel. Check the hydraulic capability of your machine and tiltrotator and the requirements of your attachment to ensure a proper match.

Counterweight		4.9 mt (10,800 lb)				
Blade		With Blade Up in Front				
Boom Type		Reach		HD Reach		VA
Stick Size		R2.9 (9'6")	HD R2.9 (9'6")	R2.9 (9'6")	HD R2.9 (9'6")	R2.9 (9'6")
Hydraulic Hammers	H115 S	✓	✓	✓	✓*	
Compactors (Vibratory Plate)	CVP75	✓	✓	✓	✓	✓
	CVP110	✓	✓	✓	✓*	

NOTE: Use hammers on tiltrotators less than 10% of working hours per year or maximum 200 hours per year. Refer to your Operation and Maintenance Manual for recommended hydraulic flow requirements.

BOOM-MOUNT ATTACHMENTS

Counterweight		4.9 mt (10,800 lb)		
Blade		With Blade Up in Front		
Boom Type		Reach	HD Reach	VA
Mobile Scrap and Demolition Shears	S2050	✓	✓	✓
	S3035 Flat Top	✓	✓	✓

325 Hydraulic Excavator Specifications

Attachments Offering Guide *(continued)*

Not all Attachments are available in all regions. Consult your Cat dealer for configurations available in your region.

Match
 * Working range front only
 † Allowed usage on machine less than 50%
 No Match

PIN-ON ATTACHMENTS

Counterweight		6.7 mt (14,800 lb)				
		Reach		HD Reach		VA
Boom Type	Stick Size	R2.9 (9'6")	HD R2.9 (9'6")	R2.9 (9'6")	HD R2.9 (9'6")	R2.9 (9'6")
Hydraulic Hammers	H120 GC S	✓	✓	✓	✓	✓
	H120 S	✓	✓	✓	✓	✓
	H130 GC S		✓		✓	
	H130 S	✓†	✓	✓†	✓	✓†
Multi-Processors	MP318 Concrete Cutter Jaw	✓	✓	✓	✓	✓
	MP318 Demolition Jaw	✓	✓	✓	✓	✓
	MP318 Pulverizer Jaw	✓	✓	✓	✓	✓
	MP318 Shear Jaw	✓	✓	✓	✓	✓
	MP318 Universal Jaw	✓	✓	✓	✓	✓
	MP324 Concrete Cutters	✓*	✓*	✓*	✓*	
	MP324 Demolition Jaw	✓*	✓*	✓*	✓*	
	MP324 Shear Jaw	✓	✓	✓	✓*	
	MP324 Tank Shear Jaw	✓*		✓*		
	MP324 Universal Jaw	✓*	✓*	✓*		
Demolition and Sorting Grapples	G317 GC	✓	✓	✓	✓	✓
	G318	✓	✓	✓	✓	✓
	G318 WH-800	✓	✓	✓	✓	✓
	G318 WH-1100	✓	✓	✓	✓	✓
	G324	✓	✓*	✓*	✓*	
	G324 WH-1500	✓*		✓*		
Mobile Scrap and Demolition Shears	S3025 Flat Top	✓	✓	✓	✓	✓
Pulverizers	P218 Secondary Pulverizer	✓	✓	✓	✓	✓
	P318 Primary Pulverizer	✓	✓	✓	✓	✓
Compactors (Vibratory Plate)	CVP110	✓	✓	✓	✓	✓
Rotary Cutters	RC20	✓	✓	✓	✓	✓

(continued on next page)

325 Hydraulic Excavator Specifications

Attachments Offering Guide (continued)

Not all Attachments are available in all regions. Consult your Cat dealer for configurations available in your region.

1800 kg/m³ (3,000 lb/yd³)
 1200 kg/m³ (2,000 lb/yd³)
 600 kg/m³ (1,000 lb/yd³)
 No Match

PIN-ON ATTACHMENTS (continued)

Counterweight		6.7 mt (14,800 lb)					
		Reach		HD Reach		VA	
Boom Type	Stick Size	R2.9 (9'6")	HD R2.9 (9'6")	R2.9 (9'6")	HD R2.9 (9'6")	R2.9 (9'6")	
Orange Peel Grapples	GSH420-500	●	●	●	●	●	
	GSH420-600	●	●	●	●	●	
	GSH420-750	●	●	●	●	●	
	GSH425-750	●	●	●	●	○	
	GSH425-950	○	○	○	○	○	
	GSH425-1150	○		○			
	GSH520-500	●	●	●	●	●	
	GSH520-600	●	●	●	●	●	
	GSH520-750	●	●	●	●	●	
	GSH525-750	○	○	○	○	○	
	GSH525-950	○		○			
	GSV420-400	●	●	●	●	●	
	GSV420-500	●	●	●	●	●	
	GSV420-600	●	●	●	●	●	
	GSV420-750	●	●	●	●	●	
	GSV420-1250	◇	◇	◇	◇	◇	
	GSV425-600	●	●	●	●	●	
	GSV425-750	●	●	●	●	○	
	GSV425-950	○	○	○	○	○	
	GSV425-1150	○	○	○	○		
	GSV425-1550	◇	◇	◇	◇	◇	
	GSV520-400	●	●	●	●	●	
	GSV520-500	●	●	●	●	●	
	GSV520-600	●	●	●	●	●	
	GSV520-750	●	●	●	●	●	
	GSV525-600	●	●	●	●	○	
	GSV525-750	○	○	○	○	○	
	GSV525-950	○	○	○	○		
	Clamshell Grapples	CTV15-1000	●	○	●	○	○
		CTV15-1200	○	○	○	○	

(continued on next page)

325 Hydraulic Excavator Specifications

Attachments Offering Guide *(continued)*

Not all Attachments are available in all regions. Consult your Cat dealer for configurations available in your region.

Match
 * Working range front only
 † Allowed usage on machine less than 50%
 No Match

CAT PIN GRABBER COUPLER ATTACHMENTS

Counterweight		6.7 mt (14,800 lb)				
Boom Type		Reach		HD Reach		VA
Stick Size		R2.9 (9'6")	HD R2.9 (9'6")	R2.9 (9'6")	HD R2.9 (9'6")	R2.9 (9'6")
Hydraulic Hammers	H120 GC S	✓†	✓	✓†	✓	✓†
	H120 S	✓†	✓	✓†	✓	✓†
	H130 GC S	✓†	✓	✓†	✓	✓†*
	H130 S	✓†	✓	✓†	✓	✓†
Multi-Processors	MP318 Concrete Cutter Jaw	✓	✓	✓	✓	✓*
	MP318 Demolition Jaw	✓	✓	✓	✓	✓*
	MP318 Pulverizer Jaw	✓	✓	✓	✓	
	MP318 Shear Jaw	✓	✓	✓	✓	✓
	MP318 Universal Jaw	✓	✓	✓	✓	✓*
Demolition and Sorting Grapples	G317 GC	✓	✓	✓	✓	✓
	G318	✓	✓	✓	✓	✓*
	G318 WH-800	✓	✓	✓	✓	✓
	G318 WH-1100	✓	✓*	✓	✓*	
Pulverizers	P218 Secondary Pulverizer	✓	✓	✓	✓	✓*
	P318 Primary Pulverizer	✓	✓	✓	✓	
Compactors (Vibratory Plate)	CVP110	✓	✓	✓	✓	✓
Rotary Cutters	RC20	✓	✓	✓	✓	✓

(continued on next page)

325 Hydraulic Excavator Specifications

Attachments Offering Guide *(continued)*

Not all Attachments are available in all regions. Consult your Cat dealer for configurations available in your region.

Match * Working range front only

CW-40s DEDICATED COUPLER ATTACHMENTS

Counterweight		6.7 mt (14,800 lb)				
Boom Type		Reach		HD Reach		VA
Stick Size		R2.9 (9'6")	HD R2.9 (9'6")	R2.9 (9'6")	HD R2.9 (9'6")	R2.9 (9'6")
Hydraulic Hammers	H120 GC S	✓†	✓	✓†	✓	✓†
	H120 S	✓†	✓	✓†	✓	✓†
	H130 S	✓†	✓	✓†	✓	✓†
Multi-Processors	MP318 Concrete Cutter Jaw	✓	✓	✓	✓	✓
	MP318 Demolition Jaw	✓	✓	✓	✓	✓
	MP318 Pulverizer Jaw	✓	✓	✓	✓	✓
	MP318 Shear Jaw	✓	✓	✓	✓	✓
	MP318 Universal Jaw	✓	✓	✓	✓	✓
Demolition and Sorting Grapples	G317 GC	✓	✓	✓	✓	✓
	G318	✓	✓	✓	✓	✓
	G318 WH-800	✓	✓	✓	✓	✓
	G318 WH-1100	✓	✓	✓	✓	✓
Mobile Scrap and Demolition Shears	S3025 Flat Top	✓	✓	✓	✓	✓*
Pulverizers	P218 Secondary Pulverizer	✓	✓	✓	✓	✓
	P318 Primary Pulverizer	✓	✓	✓	✓	✓
Compactors (Vibratory Plate)	CVP110	✓	✓	✓	✓	✓
Rotary Cutters	RC20	✓	✓	✓	✓	✓

(continued on next page)

325 Hydraulic Excavator Specifications

Attachments Offering Guide *(continued)*

Not all Attachments are available in all regions. Consult your Cat dealer for configurations available in your region.

Match
 * Working range front only
 † Allowed usage on machine less than 50%

CW-40 DEDICATED COUPLER ATTACHMENTS

Counterweight		6.7 mt (14,800 lb)				
Boom Type		Reach		HD Reach		VA
Stick Size		R2.9 (9'6")	HD R2.9 (9'6")	R2.9 (9'6")	HD R2.9 (9'6")	R2.9 (9'6")
Hydraulic Hammers	H120 GC S	✓†	✓	✓†	✓	✓†
	H120 S	✓†	✓	✓†	✓	✓†
	H130 GC S	✓†	✓	✓†	✓	✓†*
	H130 S	✓†	✓	✓†	✓	✓†
Multi-Processors	MP318 Concrete Cutter Jaw	✓	✓	✓	✓	✓
	MP318 Demolition Jaw	✓	✓	✓	✓	✓
	MP318 Pulverizer Jaw	✓	✓	✓	✓	✓
	MP318 Shear Jaw	✓	✓	✓	✓	✓
	MP318 Universal Jaw	✓	✓	✓	✓	✓
Demolition and Sorting Grapples	G317 GC	✓	✓	✓	✓	✓
	G317 GC fixed CAN	✓	✓	✓	✓	✓
	G318	✓	✓	✓	✓	✓
	G318 fixed CAN	✓	✓	✓	✓	✓
	G318 WH-800	✓	✓	✓	✓	✓
	G318 WH-1100	✓	✓	✓	✓	✓*
Mobile Scrap and Demolition Shears	S3025 Flat Top	✓	✓	✓	✓	✓*
Pulverizers	P218 Secondary Pulverizer	✓	✓	✓	✓	✓
	P318 Primary Pulverizer	✓	✓	✓	✓	✓
Compactors (Vibratory Plate)	CVP110	✓	✓	✓	✓	✓
Rotary Cutters	RC20	✓	✓	✓	✓	✓

(continued on next page)

325 Hydraulic Excavator Specifications

Attachments Offering Guide *(continued)*

Not all Attachments are available in all regions. Consult your Cat dealer for configurations available in your region.

Match

* Working range front only

No Match

HCCW40 DEDICATED COUPLER ATTACHMENTS

Counterweight		6.7 mt (14,800 lb)				
		Reach		HD Reach		VA
Boom Type	Stick Size	R2.9 (9'6")	HD R2.9 (9'6")	R2.9 (9'6")	HD R2.9 (9'6")	R2.9 (9'6")
Hydraulic Hammers	H120 GC S	✓	✓	✓	✓	✓
	H120 S	✓	✓	✓	✓	✓
	H130 GC S	✓	✓*	✓*	✓*	
	H130 S	✓	✓	✓	✓	✓
Multi-Processors	MP318 Concrete Cutter Jaw	✓	✓	✓	✓	✓*
	MP318 Demolition Jaw	✓	✓	✓	✓	✓*
	MP318 Pulverizer Jaw	✓	✓	✓	✓*	
	MP318 Shear Jaw	✓	✓	✓	✓	✓
	MP318 Universal Jaw	✓	✓	✓	✓	✓*
Demolition and Sorting Grapples	G317 GC	✓	✓	✓	✓	✓
	G318	✓	✓	✓	✓	✓*
	G318 WH-800	✓	✓	✓	✓	✓
	G318 WH-1100	✓	✓*	✓*	✓*	
Pulverizers	P218 Secondary Pulverizer	✓	✓	✓	✓	
	P318 Primary Pulverizer	✓	✓	✓	✓*	
Compactors (Vibratory Plate)	CVP110	✓	✓	✓	✓	✓
Rotary Cutters	RC20	✓	✓	✓	✓	✓

(continued on next page)

325 Hydraulic Excavator Specifications

Attachments Offering Guide *(continued)*

Not all Attachments are available in all regions. Consult your Cat dealer for configurations available in your region.

Match
 * Working range front only
 † Allowed usage on machine less than 50%
 No Match

S70 DEDICATED COUPLER ATTACHMENTS

Counterweight		6.7 mt (14,800 lb)				
Boom Type		Reach		HD Reach		VA
Stick Size		R2.9 (9'6")	HD R2.9 (9'6")	R2.9 (9'6")	HD R2.9 (9'6")	R2.9 (9'6")
Hydraulic Hammers	H120 GC S	✓†	✓	✓†	✓	✓†
	H120 S	✓†	✓	✓†	✓	✓†
	H130 S	✓†	✓	✓†	✓	✓†
Multi-Processors	MP318 Concrete Cutter Jaw	✓	✓	✓	✓	✓
	MP318 Demolition Jaw	✓	✓	✓	✓	✓
	MP318 Pulverizer Jaw	✓	✓	✓	✓	✓*
	MP318 Shear Jaw	✓	✓	✓	✓	✓
	MP318 Universal Jaw	✓	✓	✓	✓	✓
Demolition and Sorting Grapples	G317 GC	✓	✓	✓	✓	✓
	G318	✓	✓	✓	✓	✓
	G318 WH-800	✓	✓	✓	✓	✓
	G318 WH-1100	✓	✓	✓	✓	✓*
Mobile Scrap and Demolition Shears	S3025 Flat Top	✓	✓	✓	✓	
Pulverizers	P218 Secondary Pulverizer	✓	✓	✓	✓	✓*
	P318 Primary Pulverizer	✓	✓	✓	✓	✓*
Compactors (Vibratory Plate)	CVP110	✓	✓	✓	✓	✓
Rotary Cutters	RC20	✓	✓	✓	✓	✓

(continued on next page)

325 Hydraulic Excavator Specifications

Attachments Offering Guide (continued)

Not all Attachments are available in all regions. Consult your Cat dealer for configurations available in your region.

Match
 * Working range front only
 † Allowed usage on machine less than 50%
 No Match

HCS70 COUPLER ATTACHMENTS

Counterweight		6.7 mt (14,800 lb)				
Boom Type		Reach		HD Reach		VA
Stick Size		R2.9 (9'6")	HD R2.9 (9'6")	R2.9 (9'6")	HD R2.9 (9'6")	R2.9 (9'6")
Hydraulic Hammers	H120 S	✓†	✓	✓†	✓	✓†
	H130 S	✓†	✓	✓†	✓	✓†
Multi-Processors	MP318 Concrete Cutter Jaw	✓	✓	✓	✓	✓*
	MP318 Demolition Jaw	✓	✓	✓	✓	✓*
	MP318 Pulverizer Jaw	✓	✓	✓	✓	✓
	MP318 Shear Jaw	✓	✓	✓	✓	✓
	MP318 Universal Jaw	✓	✓	✓	✓	✓*
Demolition and Sorting Grapples	G317 GC	✓	✓	✓	✓	✓
	G318	✓	✓	✓	✓	✓*
	G318 WH-800	✓	✓	✓	✓	✓
	G318 WH-1100	✓	✓*	✓	✓*	✓
Pulverizers	P218 Secondary Pulverizer	✓	✓	✓	✓	✓*
	P318 Primary Pulverizer	✓	✓	✓	✓	✓
Compactors (Vibratory Plate)	CVP110	✓	✓	✓	✓	✓
Rotary Cutters	RC20	✓	✓	✓	✓	✓

HCS70/55 ATTACHMENTS

Counterweight		6.7 mt (14,800 lb)				
Boom Type		Reach		HD Reach		VA
Stick Size		R2.9 (9'6")	HD R2.9 (9'6")	R2.9 (9'6")	HD R2.9 (9'6")	R2.9 (9'6")
Hydraulic Hammers	H120 S	✓†	✓	✓†	✓	✓†
	H130 S	✓†	✓	✓†	✓	✓†
Multi-Processors	MP318 Concrete Cutter Jaw	✓	✓	✓	✓	✓*
	MP318 Demolition Jaw	✓	✓	✓	✓	✓*
	MP318 Pulverizer Jaw	✓	✓	✓	✓*	✓
	MP318 Shear Jaw	✓	✓	✓	✓	✓
	MP318 Universal Jaw	✓	✓	✓	✓	✓*
Demolition and Sorting Grapples	G317 GC	✓	✓	✓	✓	✓
	G318	✓	✓	✓	✓	✓*
	G318 WH-800	✓	✓	✓	✓	✓
	G318 WH-1100	✓*	✓*	✓*	✓*	✓
Pulverizers	P218 Secondary Pulverizer	✓	✓	✓	✓	✓
	P318 Primary Pulverizer	✓	✓	✓	✓*	✓
Compactors (Vibratory Plate)	CVP110	✓	✓	✓	✓	✓
Rotary Cutters	RC20	✓	✓	✓	✓	✓

(continued on next page)

325 Hydraulic Excavator Specifications

Attachments Offering Guide (continued)

Not all Attachments are available in all regions. Consult your Cat dealer for configurations available in your region.

Match
 * Working range front only
 † Allowed usage on machine less than 50%
 No Match

TRS18 (PIN-ON TOP/CW-30S BOTTOM) ATTACHMENTS

Some attachments require more hydraulic flow and are best suited with a machine that has HP2 circuits and a tiltrotator with a high flow swivel. Check the hydraulic capability of your machine and tiltrotator and the requirements of your attachment to ensure a proper match.

Counterweight

6.7 mt (14,800 lb)

Boom Type	Stick Length	Reach		HD Reach		VA
		R2.9 (9'6")	HD R2.9 (9'6")	R2.9 (9'6")	HD R2.9 (9'6")	R2.9 (9'6")
Hydraulic Hammers	H115 S	✓	✓	✓	✓	✓
	H120 GC S	✓†	✓	✓†	✓	✓†*
	H120 S	✓†	✓	✓†	✓	✓†
Demolition and Sorting Grapples	G217 GC	✓	✓	✓	✓	✓
	G217 GC fixed CAN	✓	✓	✓	✓	✓
Compactors (Vibratory Plate)	CVP75	✓	✓	✓	✓	✓
	CVP110	✓	✓	✓	✓	✓

NOTE: Use hammers on tiltrotators less than 10% of working hours per year or maximum 200 hours per year. Refer to your Operation and Maintenance Manual for recommended hydraulic flow requirements.

TRS18 (CW-30S TOP/CW-30S BOTTOM) ATTACHMENTS

Some attachments require more hydraulic flow and are best suited with a machine that has HP2 circuits and a tiltrotator with a high flow swivel. Check the hydraulic capability of your machine and tiltrotator and the requirements of your attachment to ensure a proper match.

Counterweight

6.7 mt (14,800 lb)

Boom Type	Stick Length	Reach		HD Reach		VA
		R2.9 (9'6")	HD R2.9 (9'6")	R2.9 (9'6")	HD R2.9 (9'6")	R2.9 (9'6")
Hydraulic Hammers	H115 S	✓	✓	✓	✓	✓
	H120 GC S	✓†	✓*	✓†	✓*	
	H120 S	✓†	✓	✓†	✓	✓†*
Demolition and Sorting Grapples	G217 GC	✓	✓	✓	✓	✓*
	G217 GC fixed CAN	✓	✓	✓	✓	✓
Compactors (Vibratory Plate)	CVP75	✓	✓	✓	✓	✓
	CVP110	✓	✓	✓	✓	✓

NOTE: Use hammers on tiltrotators less than 10% of working hours per year or maximum 200 hours per year. Refer to your Operation and Maintenance Manual for recommended hydraulic flow requirements.

TRS18 (PIN-ON TOP/CW-30 BOTTOM) ATTACHMENTS

Some attachments require more hydraulic flow and are best suited with a machine that has HP2 circuits and a tiltrotator with a high flow swivel. Check the hydraulic capability of your machine and tiltrotator and the requirements of your attachment to ensure a proper match.

Counterweight

6.7 mt (14,800 lb)

Boom Type	Stick Length	Reach		HD Reach		VA
		R2.9 (9'6")	HD R2.9 (9'6")	R2.9 (9'6")	HD R2.9 (9'6")	R2.9 (9'6")
Hydraulic Hammers	H115 S	✓	✓	✓	✓	✓
	H120 GC S	✓†	✓	✓†	✓	✓†*
	H120 S	✓†	✓	✓†	✓	✓†
Demolition and Sorting Grapples	G217 GC	✓	✓	✓	✓	✓
	G217 GC fixed CAN	✓	✓	✓	✓	✓
Compactors (Vibratory Plate)	CVP75	✓	✓	✓	✓	✓
	CVP110	✓	✓	✓	✓	✓

NOTE: Use hammers on tiltrotators less than 10% of working hours per year or maximum 200 hours per year. Refer to your Operation and Maintenance Manual for recommended hydraulic flow requirements.

(continued on next page)

325 Hydraulic Excavator Specifications

Attachments Offering Guide (continued)

Not all Attachments are available in all regions. Consult your Cat dealer for configurations available in your region.

Match
 * Working range front only
 † Allowed usage on machine less than 50%
 No Match

TRS18 (CW-30 TOP/CW-30 BOTTOM) ATTACHMENTS

Some attachments require more hydraulic flow and are best suited with a machine that has HP2 circuits and a tiltrotator with a high flow swivel. Check the hydraulic capability of your machine and tiltrotator and the requirements of your attachment to ensure a proper match.

Counterweight

6.7 mt (14,800 lb)

Boom Type	Stick Length	Reach		HD Reach		VA
		R2.9 (9'6")	HD R2.9 (9'6")	R2.9 (9'6")	HD R2.9 (9'6")	R2.9 (9'6")
Hydraulic Hammers	H115 S	✓	✓	✓	✓	✓
	H120 GC S	✓†	✓*	✓†*	✓*	
	H120 S	✓†	✓	✓†	✓	
Demolition and Sorting Grapples	G217 GC	✓	✓	✓	✓	
	G217 GC fixed CAN	✓	✓	✓	✓	✓*
Compactors (Vibratory Plate)	CVP75	✓	✓	✓	✓	✓
	CVP110	✓	✓	✓	✓	✓

NOTE: Use hammers on tiltrotators less than 10% of working hours per year or maximum 200 hours per year. Refer to your Operation and Maintenance Manual for recommended hydraulic flow requirements.

TRS18 (PIN-ON TOP/S70 BOTTOM) ATTACHMENTS

Some attachments require more hydraulic flow and are best suited with a machine that has HP2 circuits and a tiltrotator with a high flow swivel. Check the hydraulic capability of your machine and tiltrotator and the requirements of your attachment to ensure a proper match.

Counterweight

6.7 mt (14,800 lb)

Boom Type	Stick Length	Reach		HD Reach		VA
		R2.9 (9'6")	HD R2.9 (9'6")	R2.9 (9'6")	HD R2.9 (9'6")	R2.9 (9'6")
Hydraulic Hammers	H115 S	✓	✓	✓	✓	✓
	H120 GC S	✓†	✓	✓†	✓	✓†
	H120 S	✓†	✓	✓†	✓	✓†
Demolition and Sorting Grapples	G217 GC	✓	✓	✓	✓	✓
Compactors (Vibratory Plate)	CVP75	✓	✓	✓	✓	✓
	CVP110	✓	✓	✓	✓	✓

NOTE: Use hammers on tiltrotators less than 10% of working hours per year or maximum 200 hours per year. Refer to your Operation and Maintenance Manual for recommended hydraulic flow requirements.

TRS18 (S70 TOP/S70 BOTTOM) ATTACHMENTS

Some attachments require more hydraulic flow and are best suited with a machine that has HP2 circuits and a tiltrotator with a high flow swivel. Check the hydraulic capability of your machine and tiltrotator and the requirements of your attachment to ensure a proper match.

Counterweight

6.7 mt (14,800 lb)

Boom Type	Stick Length	Reach		HD Reach		VA
		R2.9 (9'6")	HD R2.9 (9'6")	R2.9 (9'6")	HD R2.9 (9'6")	R2.9 (9'6")
Hydraulic Hammers	H115 S	✓	✓	✓	✓	✓
	H120 GC S	✓†	✓	✓†	✓*	
	H120 S	✓†	✓	✓†	✓	✓†*
Demolition and Sorting Grapples	G217 GC	✓	✓	✓	✓	✓*
Compactors (Vibratory Plate)	CVP75	✓	✓	✓	✓	✓
	CVP110	✓	✓	✓	✓	✓

NOTE: Use hammers on tiltrotators less than 10% of working hours per year or maximum 200 hours per year. Refer to your Operation and Maintenance Manual for recommended hydraulic flow requirements.

(continued on next page)

325 Hydraulic Excavator Specifications

Attachments Offering Guide *(continued)*

Not all Attachments are available in all regions. Consult your Cat dealer for configurations available in your region.

Match
 * Working range front only
 † Allowed usage on machine less than 50%
 No Match

TRS18 (PIN-ON TOP/HCS70 BOTTOM) ATTACHMENTS

Some attachments require more hydraulic flow and are best suited with a machine that has HP2 circuits and a tiltrotator with a high flow swivel. Check the hydraulic capability of your machine and tiltrotator and the requirements of your attachment to ensure a proper match.

Counterweight

6.7 mt (14,800 lb)

Boom Type	Stick Length	Reach		HD Reach		VA
		R2.9 (9'6")	HD R2.9 (9'6")	R2.9 (9'6")	HD R2.9 (9'6")	R2.9 (9'6")
Hydraulic Hammers	H115 S	✓	✓	✓	✓	✓
	H120 S		✓		✓	
	H120 S	✓†		✓†		✓†
Compactors (Vibratory Plate)	CVP75	✓	✓	✓	✓	✓
	CVP110	✓	✓	✓	✓	✓

NOTE: Use hammers on tiltrotators less than 10% of working hours per year or maximum 200 hours per year. Refer to your Operation and Maintenance Manual for recommended hydraulic flow requirements.

TRS18 (HCS70 TOP/HCS70 BOTTOM) ATTACHMENTS

Some attachments require more hydraulic flow and are best suited with a machine that has HP2 circuits and a tiltrotator with a high flow swivel. Check the hydraulic capability of your machine and tiltrotator and the requirements of your attachment to ensure a proper match.

Counterweight

6.7 mt (14,800 lb)

Boom Type	Stick Length	Reach		HD Reach		VA
		R2.9 (9'6")	HD R2.9 (9'6")	R2.9 (9'6")	HD R2.9 (9'6")	R2.9 (9'6")
Hydraulic Hammers	H115 S	✓	✓	✓	✓	✓
	H120 S	✓†	✓*	✓†	✓*	
Compactors (Vibratory Plate)	CVP75	✓	✓	✓	✓	✓
	CVP110	✓	✓	✓	✓	✓

NOTE: Use hammers on tiltrotators less than 10% of working hours per year or maximum 200 hours per year. Refer to your Operation and Maintenance Manual for recommended hydraulic flow requirements.

TRS18 (PIN-ON TOP/HCS70/55 BOTTOM) ATTACHMENTS

Some attachments require more hydraulic flow and are best suited with a machine that has HP2 circuits and a tiltrotator with a high flow swivel. Check the hydraulic capability of your machine and tiltrotator and the requirements of your attachment to ensure a proper match.

Counterweight

6.7 mt (14,800 lb)

Boom Type	Stick Length	Reach		HD Reach		VA
		R2.9 (9'6")	HD R2.9 (9'6")	R2.9 (9'6")	HD R2.9 (9'6")	R2.9 (9'6")
Hydraulic Hammers	H115 S	✓	✓	✓	✓	✓
	H120 S	✓†	✓	✓†	✓	✓†
Compactors (Vibratory Plate)	CVP75	✓	✓	✓	✓	✓
	CVP110	✓	✓	✓	✓	✓

NOTE: Use hammers on tiltrotators less than 10% of working hours per year or maximum 200 hours per year. Refer to your Operation and Maintenance Manual for recommended hydraulic flow requirements.

(continued on next page)

325 Hydraulic Excavator Specifications

Attachments Offering Guide *(continued)*

Not all Attachments are available in all regions. Consult your Cat dealer for configurations available in your region.

Match

TRS18 (HCS70/55 TOP/HCS70/55 BOTTOM) ATTACHMENTS

Some attachments require more hydraulic flow and are best suited with a machine that has HP2 circuits and a tiltrotator with a high flow swivel. Check the hydraulic capability of your machine and tiltrotator and the requirements of your attachment to ensure a proper match.

Counterweight

6.7 mt (14,800 lb)

Boom Type	Stick Length	Reach		HD Reach		VA
		R2.9 (9'6")	HD R2.9 (9'6")	R2.9 (9'6")	HD R2.9 (9'6")	R2.9 (9'6")
Hydraulic Hammers	H115 S	✓	✓	✓	✓	✓
Compactors (Vibratory Plate)	CVP75	✓	✓	✓	✓	✓
	CVP110	✓	✓	✓	✓	✓

NOTE: Use hammers on tiltrotators less than 10% of working hours per year or maximum 200 hours per year. Refer to your Operation and Maintenance Manual for recommended hydraulic flow requirements.

BOOM-MOUNT ATTACHMENTS

Counterweight

6.7 mt (14,800 lb)

Boom Type		VA
Mobile Scrap and Demolition Shears	S2050	✓
	S3035 Flat Top	✓

325 Hydraulic Excavator Specifications

Attachments Offering Guide *(continued)*

Not all Attachments are available in all regions. Consult your Cat dealer for configurations available in your region.

Match
 † Allowed usage on machine less than 50%
 No Match

PIN-ON ATTACHMENTS

Counterweight		8.3 mt (18,300 lb)				
		Reach		HD Reach		VA
Boom Type	Stick Size	R2.9 (9'6")	HD R2.9 (9'6")	R2.9 (9'6")	HD R2.9 (9'6")	R2.9 (9'6")
Hydraulic Hammers	H120 GC S	✓	✓	✓	✓	✓
	H120 S	✓	✓	✓	✓	✓
	H130 GC S		✓		✓	
	H130 S	✓†	✓	✓†	✓	✓†
Multi-Processors	MP318 Concrete Cutter Jaw	✓	✓	✓	✓	✓
	MP318 Demolition Jaw	✓	✓	✓	✓	✓
	MP318 Pulverizer Jaw	✓	✓	✓	✓	✓
	MP318 Shear Jaw	✓	✓	✓	✓	✓
	MP318 Universal Jaw	✓	✓	✓	✓	✓
	MP324 Concrete Cutters	✓	✓	✓	✓	✓
	MP324 Demolition Jaw	✓	✓	✓	✓	✓
	MP324 Shear Jaw	✓	✓	✓	✓	✓
	MP324 Tank Shear Jaw	✓		✓		✓
	MP324 Universal Jaw	✓	✓	✓	✓	✓
Demolition and Sorting Grapples	G317 GC	✓	✓	✓	✓	✓
	G318	✓	✓	✓	✓	✓
	G318 WH-800	✓	✓	✓	✓	✓
	G318 WH-1100	✓	✓	✓	✓	✓
	G324	✓	✓	✓	✓	✓
	G324 WH-1500	✓	✓	✓	✓	
Mobile Scrap and Demolition Shears	S3025 Flat Top	✓	✓	✓	✓	✓
Pulverizers	P218 Secondary Pulverizer	✓	✓	✓	✓	✓
	P318 Primary Pulverizer	✓	✓	✓	✓	✓
Compactors (Vibratory Plate)	CVP110	✓	✓	✓	✓	✓
Rotary Cutters	RC20	✓	✓	✓	✓	✓

(continued on next page)

325 Hydraulic Excavator Specifications

Attachments Offering Guide (continued)

Not all Attachments are available in all regions. Consult your Cat dealer for configurations available in your region.

1800 kg/m³ (3,000 lb/yd³)
 1200 kg/m³ (2,000 lb/yd³)
 600 kg/m³ (1,000 lb/yd³)
 No Match

PIN-ON ATTACHMENTS (continued)

Counterweight		8.3 mt (18,300 lb)					
		Reach		HD Reach		VA	
Boom Type	Stick Size	R2.9 (9'6")	HD R2.9 (9'6")	R2.9 (9'6")	HD R2.9 (9'6")	R2.9 (9'6")	
Orange Peel Grapples	GSH420-500	●	●	●	●	●	
	GSH420-600	●	●	●	●	●	
	GSH420-750	●	●	●	●	●	
	GSH425-750	●	●	●	●	●	
	GSH425-950	●	●	●	●	○	
	GSH425-1150	○	○	○	○	○	
	GSH520-500	●	●	●	●	●	
	GSH520-600	●	●	●	●	●	
	GSH520-750	●	●	●	●	●	
	GSH525-750	●	●	●	●	●	
	GSH525-950	○	○	○	○	○	
	GSH525-1150	○	○	○	○		
	GSV420-400	●	●	●	●	●	
	GSV420-500	●	●	●	●	●	
	GSV420-600	●	●	●	●	●	
	GSV420-750	●	●	●	●	●	
	GSV420-1250	◇	◇	◇	◇	◇	
	GSV425-600	●	●	●	●	●	
	GSV425-750	●	●	●	●	●	
	GSV425-950	●	●	●	●	○	
	GSV425-1150	○	○	○	○	○	
	GSV425-1550	◇	◇	◇	◇	◇	
	GSV520-400	●	●	●	●	●	
	GSV520-500	●	●	●	●	●	
	GSV520-600	●	●	●	●	●	
	GSV520-750	●	●	●	●	●	
	GSV525-600	●	●	●	●	●	
	GSV525-750	●	●	●	●	●	
	GSV525-950	●	○	○	○	○	
	GSV525-1150	○	○	○	○		
	Clamshell Grapples	CTV15-1000	●	●	●	●	●
		CTV15-1200	●	○	●	○	○
CTV15-1500		○	○	○	○		

(continued on next page)

325 Hydraulic Excavator Specifications

Attachments Offering Guide *(continued)*

Not all Attachments are available in all regions. Consult your Cat dealer for configurations available in your region.

Match † Allowed usage on machine less than 50%

CAT PIN GRABBER COUPLER ATTACHMENTS

Counterweight		8.3 mt (18,300 lb)				
Boom Type		Reach		HD Reach		VA
Stick Size		R2.9 (9'6")	HD R2.9 (9'6")	R2.9 (9'6")	HD R2.9 (9'6")	R2.9 (9'6")
Hydraulic Hammers	H120 GC S	✓†	✓	✓†	✓	✓†
	H120 S	✓†	✓	✓†	✓	✓†
	H130 GC S	✓†	✓	✓†	✓	✓†
	H130 S	✓†	✓	✓†	✓	✓†
Multi-Processors	MP318 Concrete Cutter Jaw	✓	✓	✓	✓	✓
	MP318 Demolition Jaw	✓	✓	✓	✓	✓
	MP318 Pulverizer Jaw	✓	✓	✓	✓	✓
	MP318 Shear Jaw	✓	✓	✓	✓	✓
	MP318 Universal Jaw	✓	✓	✓	✓	✓
Demolition and Sorting Grapples	G317 GC	✓	✓	✓	✓	✓
	G318	✓	✓	✓	✓	✓
	G318 WH-800	✓	✓	✓	✓	✓
	G318 WH-1100	✓	✓	✓	✓	✓
Pulverizers	P218 Secondary Pulverizer	✓	✓	✓	✓	✓
	P318 Primary Pulverizer	✓	✓	✓	✓	✓
Compactors (Vibratory Plate)	CVP110	✓	✓	✓	✓	✓
Rotary Cutters	RC20	✓	✓	✓	✓	✓

(continued on next page)

325 Hydraulic Excavator Specifications

Attachments Offering Guide *(continued)*

Not all Attachments are available in all regions. Consult your Cat dealer for configurations available in your region.

Match
 † Allowed usage on machine less than 50%
 No Match

CW-40s DEDICATED COUPLER ATTACHMENTS

Counterweight		8.3 mt (18,300 lb)				
Boom Type		Reach		HD Reach		VA
Stick Size		R2.9 (9'6")	HD R2.9 (9'6")	R2.9 (9'6")	HD R2.9 (9'6")	R2.9 (9'6")
Hydraulic Hammers	H120 GC S	✓†	✓	✓†	✓	✓†
	H120 S	✓†	✓	✓†	✓	✓†
	H130 S	✓†	✓	✓†	✓	✓†
Multi-Processors	MP318 Concrete Cutter Jaw	✓	✓	✓	✓	✓
	MP318 Demolition Jaw	✓	✓	✓	✓	✓
	MP318 Pulverizer Jaw	✓	✓	✓	✓	✓
	MP318 Shear Jaw	✓	✓	✓	✓	✓
	MP318 Universal Jaw	✓	✓	✓	✓	✓
Demolition and Sorting Grapples	G317 GC	✓	✓	✓	✓	✓
	G318	✓	✓	✓	✓	✓
	G318 WH-800	✓	✓	✓	✓	✓
	G318 WH-1100	✓	✓	✓	✓	✓
Mobile Scrap and Demolition Shears	S3025 Flat Top	✓	✓	✓	✓	
Pulverizers	P218 Secondary Pulverizer	✓	✓	✓	✓	✓
	P318 Primary Pulverizer	✓	✓	✓	✓	✓
Compactors (Vibratory Plate)	CVP110	✓	✓	✓	✓	✓
Rotary Cutters	RC20	✓	✓	✓	✓	✓

(continued on next page)

325 Hydraulic Excavator Specifications

Attachments Offering Guide *(continued)*

Not all Attachments are available in all regions. Consult your Cat dealer for configurations available in your region.

Match Allowed usage on machine less than 50% No Match

CW-40 DEDICATED COUPLER ATTACHMENTS

Counterweight		8.3 mt (18,300 lb)				
Boom Type		Reach		HD Reach		VA
Stick Size		R2.9 (9'6")	HD R2.9 (9'6")	R2.9 (9'6")	HD R2.9 (9'6")	R2.9 (9'6")
Hydraulic Hammers	H120 GC S	✓†	✓	✓†	✓	✓†
	H120 S	✓†	✓	✓†	✓	✓†
	H130 GC S	✓†	✓	✓†	✓	
	H130 S	✓†	✓	✓†	✓	✓†
Multi-Processors	MP318 Concrete Cutter Jaw	✓	✓	✓	✓	✓
	MP318 Demolition Jaw	✓	✓	✓	✓	✓
	MP318 Pulverizer Jaw	✓	✓	✓	✓	✓
	MP318 Shear Jaw	✓	✓	✓	✓	✓
	MP318 Universal Jaw	✓	✓	✓	✓	✓
Demolition and Sorting Grapples	G317 GC	✓	✓	✓	✓	✓
	G317 GC fixed CAN	✓	✓	✓	✓	✓
	G318	✓	✓	✓	✓	✓
	G318 fixed CAN	✓	✓	✓	✓	✓
	G318 WH-800	✓	✓	✓	✓	✓
	G318 WH-1100	✓	✓	✓	✓	✓
Mobile Scrap and Demolition Shears	S3025 Flat Top	✓	✓	✓	✓	
Pulverizers	P218 Secondary Pulverizer	✓	✓	✓	✓	✓
	P318 Primary Pulverizer	✓	✓	✓	✓	✓
Compactors (Vibratory Plate)	CVP110	✓	✓	✓	✓	✓
Rotary Cutters	RC20	✓	✓	✓	✓	✓

(continued on next page)

325 Hydraulic Excavator Specifications

Attachments Offering Guide *(continued)*

Not all Attachments are available in all regions. Consult your Cat dealer for configurations available in your region.

Match

HCCW40 DEDICATED COUPLER ATTACHMENTS

Counterweight		8.3 mt (18,300 lb)				
		Reach		HD Reach		VA
Boom Type	Stick Size	R2.9 (9'6")	HD R2.9 (9'6")	R2.9 (9'6")	HD R2.9 (9'6")	R2.9 (9'6")
Hydraulic Hammers	H120 GC S	✓	✓	✓	✓	✓
	H120 S	✓	✓	✓	✓	✓
	H130 GC S	✓	✓	✓	✓	✓
	H130 S	✓	✓	✓	✓	✓
Multi-Processors	MP318 Concrete Cutter Jaw	✓	✓	✓	✓	✓
	MP318 Demolition Jaw	✓	✓	✓	✓	✓
	MP318 Pulverizer Jaw	✓	✓	✓	✓	✓
	MP318 Shear Jaw	✓	✓	✓	✓	✓
	MP318 Universal Jaw	✓	✓	✓	✓	✓
Demolition and Sorting Grapples	G317 GC	✓	✓	✓	✓	✓
	G318	✓	✓	✓	✓	✓
	G318 WH-800	✓	✓	✓	✓	✓
	G318 WH-1100	✓	✓	✓	✓	✓
Pulverizers	P218 Secondary Pulverizer	✓	✓	✓	✓	✓
	P318 Primary Pulverizer	✓	✓	✓	✓	✓
Compactors (Vibratory Plate)	CVP110	✓	✓	✓	✓	✓
Rotary Cutters	RC20	✓	✓	✓	✓	✓

(continued on next page)

325 Hydraulic Excavator Specifications

Attachments Offering Guide *(continued)*

Not all Attachments are available in all regions. Consult your Cat dealer for configurations available in your region.

Match Allowed usage on machine less than 50% No Match

S70 DEDICATED COUPLER ATTACHMENTS

Counterweight		8.3 mt (18,300 lb)				
Boom Type		Reach		HD Reach		VA
Stick Size		R2.9 (9'6")	HD R2.9 (9'6")	R2.9 (9'6")	HD R2.9 (9'6")	R2.9 (9'6")
Hydraulic Hammers	H120 GC S	✓†	✓	✓†	✓	✓†
	H120 S	✓†	✓	✓†	✓	✓†
	H130 S	✓†	✓	✓†	✓	✓†
Multi-Processors	MP318 Concrete Cutter Jaw	✓	✓	✓	✓	✓
	MP318 Demolition Jaw	✓	✓	✓	✓	✓
	MP318 Pulverizer Jaw	✓	✓	✓	✓	✓
	MP318 Shear Jaw	✓	✓	✓	✓	✓
	MP318 Universal Jaw	✓	✓	✓	✓	✓
Demolition and Sorting Grapples	G317 GC	✓	✓	✓	✓	✓
	G318	✓	✓	✓	✓	✓
	G318 WH-800	✓	✓	✓	✓	✓
	G318 WH-1100	✓	✓	✓	✓	✓
Mobile Scrap and Demolition Shears	S3025 Flat Top	✓	✓	✓	✓	
Pulverizers	P218 Secondary Pulverizer	✓	✓	✓	✓	✓
	P318 Primary Pulverizer	✓	✓	✓	✓	✓
Compactors (Vibratory Plate)	CVP110	✓	✓	✓	✓	✓
Rotary Cutters	RC20	✓	✓	✓	✓	✓

(continued on next page)

325 Hydraulic Excavator Specifications

Attachments Offering Guide *(continued)*

Not all Attachments are available in all regions. Consult your Cat dealer for configurations available in your region.

Match † Allowed usage on machine less than 50%

HCS70 COUPLER ATTACHMENTS

Counterweight		8.3 mt (18,300 lb)				
Boom Type		Reach		HD Reach		VA
Stick Size		R2.9 (9'6")	HD R2.9 (9'6")	R2.9 (9'6")	HD R2.9 (9'6")	R2.9 (9'6")
Hydraulic Hammers	H120 S	✓†	✓	✓†	✓	✓†
	H130 S	✓†	✓	✓†	✓	✓†
Multi-Processors	MP318 Concrete Cutter Jaw	✓	✓	✓	✓	✓
	MP318 Demolition Jaw	✓	✓	✓	✓	✓
	MP318 Pulverizer Jaw	✓	✓	✓	✓	✓
	MP318 Shear Jaw	✓	✓	✓	✓	✓
	MP318 Universal Jaw	✓	✓	✓	✓	✓
Demolition and Sorting Grapples	G317 GC	✓	✓	✓	✓	✓
	G318	✓	✓	✓	✓	✓
	G318 WH-800	✓	✓	✓	✓	✓
	G318 WH-1100	✓	✓	✓	✓	✓
Pulverizers	P218 Secondary Pulverizer	✓	✓	✓	✓	✓
	P318 Primary Pulverizer	✓	✓	✓	✓	✓
Compactors (Vibratory Plate)	CVP110	✓	✓	✓	✓	✓
Rotary Cutters	RC20	✓	✓	✓	✓	✓

HCS70/55 DEDICATED COUPLER ATTACHMENTS

Counterweight		8.3 mt (18,300 lb)				
Boom Type		Reach		HD Reach		VA
Stick Size		R2.9 (9'6")	HD R2.9 (9'6")	R2.9 (9'6")	HD R2.9 (9'6")	R2.9 (9'6")
Hydraulic Hammers	H120 S	✓†	✓	✓†	✓	✓†
	H130 S	✓†	✓	✓†	✓	✓†
Multi-Processors	MP318 Concrete Cutter Jaw	✓	✓	✓	✓	✓
	MP318 Demolition Jaw	✓	✓	✓	✓	✓
	MP318 Pulverizer Jaw	✓	✓	✓	✓	✓
	MP318 Shear Jaw	✓	✓	✓	✓	✓
	MP318 Universal Jaw	✓	✓	✓	✓	✓
Demolition and Sorting Grapples	G317 GC	✓	✓	✓	✓	✓
	G318	✓	✓	✓	✓	✓
	G318 WH-800	✓	✓	✓	✓	✓
	G318 WH-1100	✓	✓	✓	✓	✓
Pulverizers	P218 Secondary Pulverizer	✓	✓	✓	✓	✓
	P318 Primary Pulverizer	✓	✓	✓	✓	✓
Compactors (Vibratory Plate)	CVP110	✓	✓	✓	✓	✓
Rotary Cutters	RC20	✓	✓	✓	✓	✓

(continued on next page)

325 Hydraulic Excavator Specifications

Attachments Offering Guide *(continued)*

Not all Attachments are available in all regions. Consult your Cat dealer for configurations available in your region.

Match

† Allowed usage on machine less than 50%

No Match

TRS18 (PIN-ON TOP/CW-30S BOTTOM) ATTACHMENTS

Some attachments require more hydraulic flow and are best suited with a machine that has HP2 circuits and a tiltrotator with a high flow swivel. Check the hydraulic capability of your machine and tiltrotator and the requirements of your attachment to ensure a proper match.

Counterweight

8.3 mt (18,300 lb)

Boom Type		Reach		HD Reach		VA
		R2.9 (9'6")	HD R2.9 (9'6")	R2.9 (9'6")	HD R2.9 (9'6")	R2.9 (9'6")
Hydraulic Hammers	H115 S	✓	✓	✓	✓	✓
	H120 GC S	✓†	✓	✓†	✓	
	H120 S	✓†	✓	✓†	✓	✓†
Demolition and Sorting Grapples	G217 GC	✓	✓	✓	✓	✓
	G217 GC fixed CAN	✓	✓	✓	✓	✓
Compactors (Vibratory Plate)	CVP75	✓	✓	✓	✓	✓
	CVP110	✓	✓	✓	✓	✓

NOTE: Use hammers on tiltrotators less than 10% of working hours per year or maximum 200 hours per year. Refer to your Operation and Maintenance Manual for recommended hydraulic flow requirements.

TRS18 (CW-30S TOP/CW-30S BOTTOM) ATTACHMENTS

Some attachments require more hydraulic flow and are best suited with a machine that has HP2 circuits and a tiltrotator with a high flow swivel. Check the hydraulic capability of your machine and tiltrotator and the requirements of your attachment to ensure a proper match.

Counterweight

8.3 mt (18,300 lb)

Boom Type		Reach		HD Reach		VA
		R2.9 (9'6")	HD R2.9 (9'6")	R2.9 (9'6")	HD R2.9 (9'6")	R2.9 (9'6")
Hydraulic Hammers	H115 S	✓	✓	✓	✓	✓
	H120 GC S	✓†	✓	✓†	✓	✓†
	H120 S	✓†	✓	✓†	✓	✓†
Demolition and Sorting Grapples	G217 GC	✓	✓	✓	✓	✓
	G217 GC fixed CAN	✓	✓	✓	✓	✓
Compactors (Vibratory Plate)	CVP75	✓	✓	✓	✓	✓
	CVP110	✓	✓	✓	✓	✓

NOTE: Use hammers on tiltrotators less than 10% of working hours per year or maximum 200 hours per year. Refer to your Operation and Maintenance Manual for recommended hydraulic flow requirements.

(continued on next page)

325 Hydraulic Excavator Specifications

Attachments Offering Guide (continued)

Not all Attachments are available in all regions. Consult your Cat dealer for configurations available in your region.

Match

† Allowed usage on machine less than 50%

TRS18 (PIN-ON TOP/CW-30 BOTTOM) ATTACHMENTS

Some attachments require more hydraulic flow and are best suited with a machine that has HP2 circuits and a tiltrotator with a high flow swivel. Check the hydraulic capability of your machine and tiltrotator and the requirements of your attachment to ensure a proper match.

Counterweight

8.3 mt (18,300 lb)

Boom Type		Reach		HD Reach		VA
Stick Size		R2.9 (9'6")	HD R2.9 (9'6")	R2.9 (9'6")	HD R2.9 (9'6")	R2.9 (9'6")
Hydraulic Hammers	H115 S	✓	✓	✓	✓	✓
	H120 GC S	✓†	✓	✓†	✓	✓†
	H120 S	✓†	✓	✓†	✓	✓†
Demolition and Sorting Grapples	G217 GC	✓	✓	✓	✓	✓
	G217 GC fixed CAN	✓	✓	✓	✓	✓
Compactors (Vibratory Plate)	CVP75	✓	✓	✓	✓	✓
	CVP110	✓	✓	✓	✓	✓

NOTE: Use hammers on tiltrotators less than 10% of working hours per year or maximum 200 hours per year. Refer to your Operation and Maintenance Manual for recommended hydraulic flow requirements.

TRS18 (CW-30 TOP/CW-30 BOTTOM) ATTACHMENTS

Some attachments require more hydraulic flow and are best suited with a machine that has HP2 circuits and a tiltrotator with a high flow swivel. Check the hydraulic capability of your machine and tiltrotator and the requirements of your attachment to ensure a proper match.

Counterweight

8.3 mt (18,300 lb)

Boom Type		Reach		HD Reach		VA
Stick Size		R2.9 (9'6")	HD R2.9 (9'6")	R2.9 (9'6")	HD R2.9 (9'6")	R2.9 (9'6")
Hydraulic Hammers	H115 S	✓	✓	✓	✓	✓
	H120 GC S	✓†	✓	✓†	✓	✓†
	H120 S	✓†	✓	✓†	✓	✓†
Demolition and Sorting Grapples	G217 GC	✓	✓	✓	✓	✓
	G217 GC fixed CAN	✓	✓	✓	✓	✓
Compactors (Vibratory Plate)	CVP75	✓	✓	✓	✓	✓
	CVP110	✓	✓	✓	✓	✓

NOTE: Use hammers on tiltrotators less than 10% of working hours per year or maximum 200 hours per year. Refer to your Operation and Maintenance Manual for recommended hydraulic flow requirements.

TRS18 (PIN-ON TOP/S70 BOTTOM) ATTACHMENTS

Some attachments require more hydraulic flow and are best suited with a machine that has HP2 circuits and a tiltrotator with a high flow swivel. Check the hydraulic capability of your machine and tiltrotator and the requirements of your attachment to ensure a proper match.

Counterweight

8.3 mt (18,300 lb)

Boom Type		Reach		HD Reach		VA
Stick Size		R2.9 (9'6")	HD R2.9 (9'6")	R2.9 (9'6")	HD R2.9 (9'6")	R2.9 (9'6")
Hydraulic Hammers	H115 S	✓	✓	✓	✓	✓
	H120 GC S	✓†	✓	✓†	✓	✓†
	H120 S	✓†	✓	✓†	✓	✓†
Demolition and Sorting Grapples	G217 GC	✓	✓	✓	✓	✓
Compactors (Vibratory Plate)	CVP75	✓	✓	✓	✓	✓
	CVP110	✓	✓	✓	✓	✓

NOTE: Use hammers on tiltrotators less than 10% of working hours per year or maximum 200 hours per year. Refer to your Operation and Maintenance Manual for recommended hydraulic flow requirements.

(continued on next page)

325 Hydraulic Excavator Specifications

Attachments Offering Guide (continued)

Not all Attachments are available in all regions. Consult your Cat dealer for configurations available in your region.

Match

† Allowed usage on machine less than 50%

No Match

TRS18 (S70 TOP/S70 BOTTOM) ATTACHMENTS

Some attachments require more hydraulic flow and are best suited with a machine that has HP2 circuits and a tiltrotator with a high flow swivel. Check the hydraulic capability of your machine and tiltrotator and the requirements of your attachment to ensure a proper match.

Counterweight

8.3 mt (18,300 lb)

Boom Type		Reach		HD Reach		VA
Stick Size		R2.9 (9'6")	HD R2.9 (9'6")	R2.9 (9'6")	HD R2.9 (9'6")	R2.9 (9'6")
Hydraulic Hammers	H115 S	✓	✓	✓	✓	✓
	H120 GC S	✓†	✓	✓†	✓	✓†
	H120 S	✓†	✓	✓†	✓	✓†
Demolition and Sorting Grapples	G217 GC	✓	✓	✓	✓	✓
Compactors (Vibratory Plate)	CVP75	✓	✓	✓	✓	✓
	CVP110	✓	✓	✓	✓	✓

NOTE: Use hammers on tiltrotators less than 10% of working hours per year or maximum 200 hours per year. Refer to your Operation and Maintenance Manual for recommended hydraulic flow requirements.

TRS18 (PIN-ON TOP/HCS70 BOTTOM) ATTACHMENTS

Some attachments require more hydraulic flow and are best suited with a machine that has HP2 circuits and a tiltrotator with a high flow swivel. Check the hydraulic capability of your machine and tiltrotator and the requirements of your attachment to ensure a proper match.

Counterweight

8.3 mt (18,300 lb)

Boom Type		Reach		HD Reach		VA
Stick Size		R2.9 (9'6")	HD R2.9 (9'6")	R2.9 (9'6")	HD R2.9 (9'6")	R2.9 (9'6")
Hydraulic Hammers	H115 S	✓	✓	✓	✓	✓
	H120 S		✓		✓	
	H120 S	✓†		✓†		✓†
Compactors (Vibratory Plate)	CVP75	✓	✓	✓	✓	✓
	CVP110	✓	✓	✓	✓	✓

NOTE: Use hammers on tiltrotators less than 10% of working hours per year or maximum 200 hours per year. Refer to your Operation and Maintenance Manual for recommended hydraulic flow requirements.

TRS18 (HCS70 TOP/HCS70 BOTTOM) ATTACHMENTS

Some attachments require more hydraulic flow and are best suited with a machine that has HP2 circuits and a tiltrotator with a high flow swivel. Check the hydraulic capability of your machine and tiltrotator and the requirements of your attachment to ensure a proper match.

Counterweight

8.3 mt (18,300 lb)

Boom Type		Reach		HD Reach		VA
Stick Size		R2.9 (9'6")	HD R2.9 (9'6")	R2.9 (9'6")	HD R2.9 (9'6")	R2.9 (9'6")
Hydraulic Hammers	H115 S	✓	✓	✓	✓	✓
	H120 S	✓†	✓	✓†	✓	✓†
Compactors (Vibratory Plate)	CVP75	✓	✓	✓	✓	✓
	CVP110	✓	✓	✓	✓	✓

NOTE: Use hammers on tiltrotators less than 10% of working hours per year or maximum 200 hours per year. Refer to your Operation and Maintenance Manual for recommended hydraulic flow requirements.

(continued on next page)

325 Hydraulic Excavator Specifications

Attachments Offering Guide (continued)

Not all Attachments are available in all regions. Consult your Cat dealer for configurations available in your region.

Match

† Allowed usage on machine less than 50%

TRS18 (PIN-ON TOP/HCS70/55 BOTTOM) ATTACHMENTS

Some attachments require more hydraulic flow and are best suited with a machine that has HP2 circuits and a tiltrotator with a high flow swivel. Check the hydraulic capability of your machine and tiltrotator and the requirements of your attachment to ensure a proper match.

Counterweight 8.3 mt (18,300 lb)

Boom Type	Stick Size	Reach		HD Reach		VA
		R2.9 (9'6")	HD R2.9 (9'6")	R2.9 (9'6")	HD R2.9 (9'6")	R2.9 (9'6")
Hydraulic Hammers	H115 S	✓	✓	✓	✓	✓
	H120 S	✓†	✓	✓†	✓	✓†
Compactors (Vibratory Plate)	CVP75	✓	✓	✓	✓	✓
	CVP110	✓	✓	✓	✓	✓

NOTE: Use hammers on tiltrotators less than 10% of working hours per year or maximum 200 hours per year. Refer to your Operation and Maintenance Manual for recommended hydraulic flow requirements.

TRS18 (HCS70/55 TOP/HCS70/55 BOTTOM) ATTACHMENTS

Some attachments require more hydraulic flow and are best suited with a machine that has HP2 circuits and a tiltrotator with a high flow swivel. Check the hydraulic capability of your machine and tiltrotator and the requirements of your attachment to ensure a proper match.

Counterweight 8.3 mt (18,300 lb)

Boom Type	Stick Size	Reach		HD Reach		VA
		R2.9 (9'6")	HD R2.9 (9'6")	R2.9 (9'6")	HD R2.9 (9'6")	R2.9 (9'6")
Hydraulic Hammers	H115 S	✓	✓	✓	✓	✓
Compactors (Vibratory Plate)	CVP75	✓	✓	✓	✓	✓
	CVP110	✓	✓	✓	✓	✓

NOTE: Use hammers on tiltrotators less than 10% of working hours per year or maximum 200 hours per year. Refer to your Operation and Maintenance Manual for recommended hydraulic flow requirements.

BOOM-MOUNT ATTACHMENTS

Undercarriage Long

Counterweight 8.3 mt (18,300 lb)

Boom Type		Reach	HD Reach	VA
Mobile Scrap and Demolition Shears	S2050	✓	✓	✓
	S3035 Flat Top	✓	✓	✓

Standard and Optional Equipment

Standard and optional equipment may vary. Consult your Cat dealer for details.

	Standard	Optional		Standard	Optional
BOOMS, STICKS AND LINKAGES			ELECTRICAL SYSTEM		
5.7 m (18'8") Reach boom		✓	LED chassis light, left-hand/right-hand boom lights, cab lights – 1,800 lumens	✓	
5.7 m (18'8") HD Reach boom		✓	Centralized electrical disconnect switch	✓	
2.7 m (8'10") Stub + 3.3 m (10'10") Fore Variable Angle boom		✓	Programmable time-delay working lights	✓	
2.9 m (9'6") Reach stick		✓	Premium surround lighting package		✓
2.9 m (9'6") HD Reach stick		✓	ENGINE		
Bucket linkage, B1 type with lifting eye, Cat Grade	✓		Cat® C4.4 single turbo diesel engine	✓	
CAT TECHNOLOGY			Three selectable modes: Power, Smart, Eco	✓	
VisionLink®	✓ ¹		Up to 4500 m (14,760 ft) altitude capability	✓	
VisionLink Productivity		✓	50° C (122° F) high-ambient cooling capacity without derate	✓	
Remote Flash	✓		-18° C (0° F) cold start capability	✓	
Remote Troubleshoot	✓		-32° C (-25° F) cold start capability		✓
Cat Grade Connectivity		✓	Sealed double element air filter with integrated pre-cleaner	✓	
Compatibility with radios and base stations from Trimble, Topcon, and Leica	✓		Electric fuel priming pump	✓	
Capability to install 3D grade systems from Trimble, Topcon, and Leica	✓		Reversible electric cooling fans	✓	
Cat Grade with 2D and offset memory	✓		Two-stage fuel filtration system with water separator and indicator	✓	
Cat Grade 2D	✓				
Cat Grade 2D with Attachment Ready Option (ARO)		✓			
Cat Grade 3D single GNSS		✓			
Cat Grade 3D dual GNSS		✓			
Laser catcher		✓			
Cat Assist:	✓				
– Grade Assist					
– Boom Assist					
– Bucket Assist					
– Swing Assist					
– Lift Assist ²					
Cat Payload:	✓				
– Static weigh					
– Semiautomatic calibration					
– Payload/cycle information					
– USB reporting capability					
Work tool recognition (PL161)	✓				
Work tool tracking (PL161)	✓				
Cat Tilt Rotator (TRS) Integration		✓			
Operator Coaching		✓			

¹Connect subscription only. Additional subscriptions are available. Contact your Cat dealer for availability.

²Not available for VA boom

325 Standard and Optional Equipment

Standard and Optional Equipment (continued)

Standard and optional equipment may vary. Consult your Cat dealer for details.

	Standard	Optional		Standard	Optional
HYDRAULIC SYSTEM			UNDERCARRIAGE AND STRUCTURES		
Electric main control valve	✓		Base frame with SD track rollers and standard carrier rollers		✓
Auto Dig Boost ³	✓		Base frame with SD track rollers and standard carrier rollers for use with blade		✓
Auto heavy lift	✓		Grease lubricated track	✓	
Boom and stick regeneration circuits	✓		Segmented track guiding guards	✓	
Automatic warm up	✓		HD bottom guards	✓	
Automatic two-speed travel	✓		HD travel motor guards	✓	
Boom and stick drift reduction valve	✓		Swivel guard		✓
Tandem type electronic main pump	✓		4.9 mt (10,800 lb) counterweight		✓
Element type main hydraulic filter	✓		6.7 mt (14,800 lb) counterweight ⁴		✓
Pump suction line for medium pressure or blade	✓		8.3 mt (18,300 lb) counterweight ⁴		✓
SmartBoom™		✓	600 mm (24") HD triple grouser track shoes		✓
Hydraulic efficiency monitoring		✓	700 mm (28") HD triple grouser track shoes		✓
SAFETY AND SECURITY			790 mm (31") HD triple grouser track shoes		✓
Cat Command (remote control)		✓	2980 mm (9'9") blade		✓
2D E-Fence:	✓		3170 mm (10'5") blade		✓
– E-ceiling			Tie-down points on base frame	✓	
– E-floor					
– E-swing					
– E-wall					
– E-cab avoidance					
Auto hammer stop	✓				
Rear and right-hand-sideview cameras	✓				
360° visibility		✓			
Right-hand handrail and hand hold	✓				
Service platform with anti-skid plate and countersunk bolts	✓				
Hydraulic lock out lever	✓				
Swing alarm		✓			
Ground-level accessible secondary engine shutoff switch in cab	✓				
Lockable disconnect switch	✓				
Signaling/warning horn	✓				
Operator Protective Guards		✓			
Inspection lighting		✓			
SERVICE AND MAINTENANCE					
Scheduled Oil Sampling (S·O·S SM) ports	✓				
Grouped location for engine oil and fuel filters	✓				
Ground-level second dipstick for engine oil	✓				
Integrated vehicle health management system	✓				

³Requires heavy lift valve; not available for VA Boom

⁴Not compatible with blade

Dealer Installed Kits and Attachments

Attachments may vary. Consult your Cat dealer for details.

CAB

- Rain protector plus cab light cover
- Laminated P5A glass front windshield
- LH/RH electrical pedal for tool control
- Armrest kit
- Seat with 4-point seatbelt capability
- Dual exit rear window kit
- 75 mm (3") retractable seat belt
- Auxiliary relay

GUARDS

- Operator Protective Guards
- Mesh guard full front
- Mesh guard half front
- Full protecting vandalism guard

MAINTENANCE

- Dust hose kit

SAFETY AND SECURITY

- Cat Detect – People Detection
- Cat Command – Remote control kit
- Seat belt indicator
- Bluetooth® key fob

OTHER ATTACHMENTS

- Delayed engine shutdown kit
- Power clam kit

325 Cab Options

Cab Options

	Deluxe	Premium (2 piece windshield)	Premium (1 piece windshield)
ROPS	●	●	●
High-resolution 254 mm (10") LCD touchscreen monitor	●	●	●
Auto bi-level air conditioner	●	●	●
Jog dial and shortcut keys for monitor control	●	●	●
Keyless push-to-start engine control	●	●	●
Height-adjustable console	●	●	●
Tilt-up left-side console	●	●	●
Heated air-suspension seat	●	X	X
Heated and ventilated air-suspension seat	X	●	●
51 mm (2") seat belt	●	●	●
DAB/DAB+ radio with Bluetooth (includes USB/Auxiliary ports)	●	●	●
12V DC outlets	●	●	●
Document storage	●	●	●
Overhead storage and rear storage with nets	●	●	●
Beverage holder	●	●	●
Cup holder	●	●	●
Openable two-piece front window	●	●	○
One piece front windshield	X	○	●
Rear window emergency exit	●	●	●
Radial wiper with washer	●	X	X
Parallel wiper	X	●	●
Openable polycarbonate skylight hatch	●	●	X
Laminated roof glass	X	X	●
Dome and lower LED interior lights	●	●	●
Floor welcome light	●	●	●
Roof sunscreen	●	●	●
Roller front sunscreen	●	●	●
Roller rear sunscreen	○	●	●
Washable floor mat	●	●	●
Beacon ready	●	●	●
Cat Stick Steer	○	○	○
Auxiliary relay	○	○	○

- Standard
- Optional
- X Not available

The following information applies to the machine at the time of final manufacture as configured for sale in the regions covered in this document. The content of this declaration is valid as of the date issued; however, content related to machine features and specifications are subject to change without notice. For additional information, please see the machine's Operation and Maintenance Manual.

For more information on sustainability in action and our progress, please visit <https://www.caterpillar.com/en/company/sustainability>.

Engine

- The Cat® C4.4 engine meets U.S. EPA Tier 4 Final, EU Stage V, and Japan 2014 emission standards.

Cat diesel engines are required to use ULSD (ultra-low sulfur diesel fuel with 15 ppm of sulfur or less) or ULSD blended with the following lower-carbon intensity fuels** up to:

- ✓ 20% biodiesel FAME (fatty acid methyl ester)*
- ✓ 100% renewable diesel, HVO (hydrotreated vegetable oil) and GTL (gas-to-liquid) fuels

Refer to guidelines for successful application. Please consult your Cat dealer or “Caterpillar Machine Fluids Recommendations” (SEBU6250) for details.

**Engines with no aftertreatment devices can use higher blends, up to 100% biodiesel (for use of blends higher than 20% biodiesel, consult your Cat dealer).*

***Tailpipe greenhouse gas emissions from lower-carbon intensity fuels are essentially the same as traditional fuels.*

Air Conditioning System

- The air conditioning system on this machine contains the fluorinated greenhouse gas refrigerant R134a (Global Warming Potential = 1430). The system contains 0.8 kg (1.8 lb) of refrigerant which has a CO₂ equivalent of 1.144 metric tonnes (1.261 tons).

Paint

- Based on best available knowledge, the maximum allowable concentration, measured in parts per million (PPM), of the following heavy metals in paint are:
 - Barium < 0.01%
 - Cadmium < 0.01%
 - Chromium < 0.01%
 - Lead < 0.01%

Sound Performance

ISO 6395:2008 (external) 97 dB(A)

ISO 6396:2008 (inside cab) 70 dB(A)

- Hearing protection may be needed when operating with an open operator station and cab (when not properly maintained or doors/windows open) for extended periods or in a noisy environment.

Oils and Fluids

- Caterpillar factory fills with ethylene glycol coolants. Cat Diesel Engine Antifreeze/Coolant (DEAC) and Cat Extended Life Coolant (ELC) can be recycled. Consult your Cat dealer for more information.
- Cat Bio HYDO™ Advanced is an EU Ecolabel approved biodegradable hydraulic oil.
- Additional fluids are likely to be present, please consult the Operations and Maintenance Manual or the Application and Installation guide for complete fluid recommendations and maintenance intervals.

Features and Technology

- The following features and technology may contribute to fuel savings and/or carbon reduction. Features may vary. Consult your Cat dealer for details.
 - Advanced hydraulic systems balance power and efficiency
 - Smart mode matches machine power to digging requirements automatically
 - Eco mode minimizes fuel consumption for light applications
 - Increase operating efficiency up to 45% with standard Cat technologies that lower operator fatigue and operating costs
 - Expect up to 25% less maintenance cost than the 325F
 - The latest hydraulic oil filter provides longer life with a 3,000-hour replacement interval – 50% longer than previous filter designs
 - One-touch low idle with automatic engine speed control

Recycling

- The materials included in machines are categorized as below with approximate weight percentage. Because of variations of product configurations, the following values in the table may vary.

Material Type	Weight Percentage
Steel	82.67%
Iron	5.61%
Nonferrous Metal	2.68%
Mixed Metal	1.28%
Mixed-Metal and Nonmetal	1.07%
Plastic	1.35%
Rubber	0.08%
Mixed Nonmetallic	0.23%
Fluid	3.33%
Other	1.70%
Uncategorized	0.00%
Total	100%

- A machine with higher recyclability rate will ensure more efficient usage of valuable natural resources and enhance End-of-Life value of the product. According to ISO 16714:2008 (Earthmoving machinery – Recyclability and recoverability – Terminology and calculation method), recyclability rate is defined as percentage by mass (mass fraction in percent) of the new machine potentially able to be recycled, reused, or both.

All parts in the bill of material are first evaluated by component type based on a list of components defined by the ISO 16714:2008 and Japan CEMA (Construction Equipment Manufacturers Association) standards. Remaining parts are further evaluated for recyclability based on material type.

Because of variations of product configurations, the following value in the table may vary.

Recyclability – 98%

For more complete information on Cat products, dealer services, and industry solutions, visit us on the web at www.cat.com

© 2023 Caterpillar
All rights reserved

Materials and specifications are subject to change without notice. Featured machines in photos may include additional equipment. See your Cat dealer for available options.

CAT, CATERPILLAR, LET'S DO THE WORK, their respective logos, "Caterpillar Corporate Yellow," the "Power Edge" and Cat "Modern Hex" trade dress as well as corporate and product identity used herein, are trademarks of Caterpillar and may not be used without permission. VisionLink is a trademark of Caterpillar Inc., registered in the United States and in other countries.

AEXQ2730-06 (10-2023)
Replaces AEXQ2730-05
Build Number: 07E
(Europe)

