

Cat® Ground Engaging Tools

CONSTRUCTION PARTS CATALOG

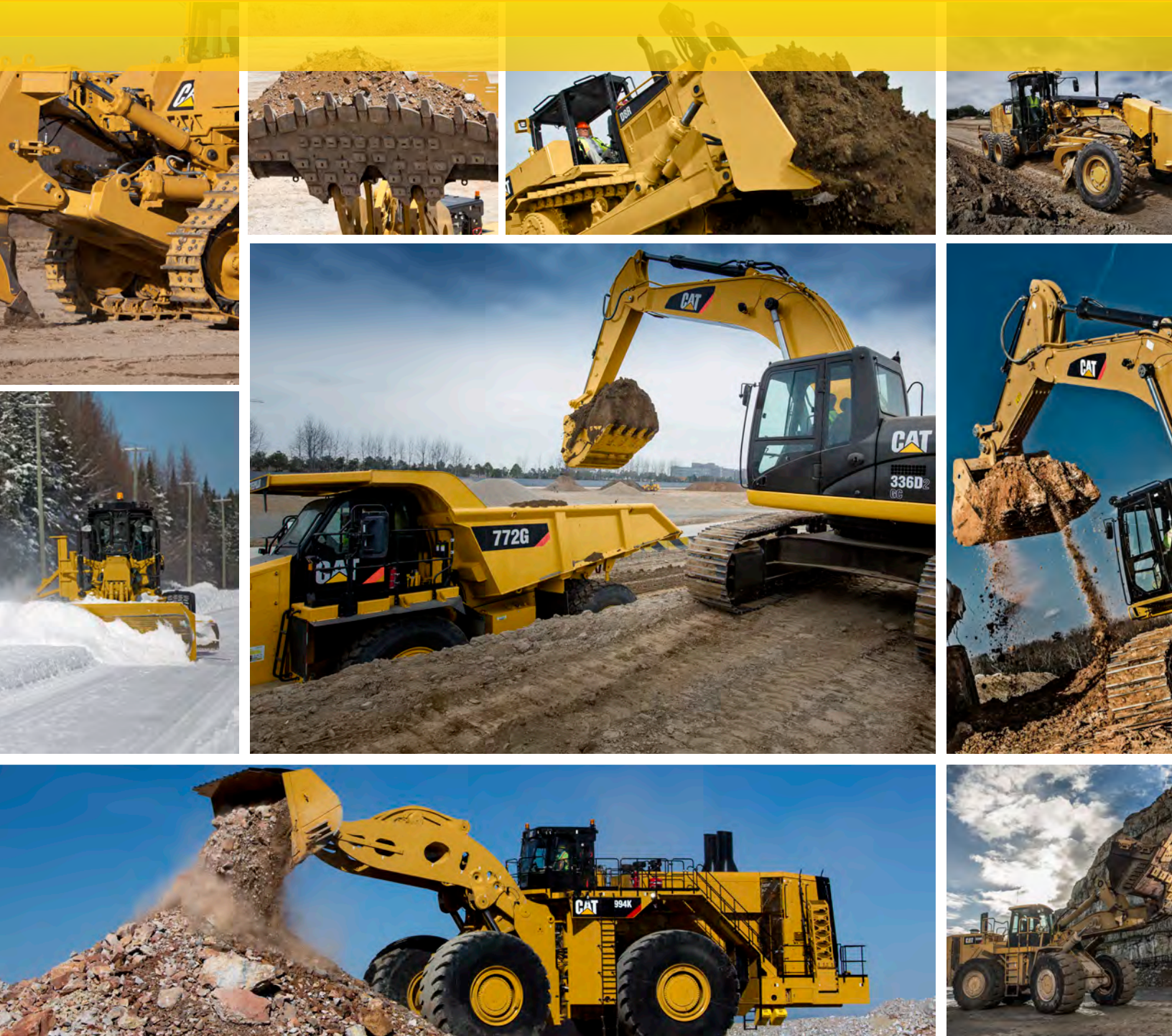



UPDATES FOUND IN THIS VERSION:

- Added XAR Tip information
- Added in the Hole to Bevel dimension on top covers



WHEEL LOADERS	5
Cross Reference Tables	6
Cat Advansys Tip™ and Adapter System	32
K Series Tip and Adapter System	52
CapSure J-Tip and Adapter System	67
J Series Tip and Adapter System	76
HYDRAULIC EXCAVATORS	91
Cross Reference Tables	94
Cat® Advansys™ Tip and Adapter System	152
K Series Tip and Adapter System	162
CapSure J Tip and Adapter System	170
J Series Tip and Adapter System	179
DOZERS	195
Cutting Edge & Blade Protection	196
Ripper Systems	296
MOTOR GRADERS	301
System Options	303
Cross Reference Tables	321
WHEEL TRACTOR SCRAPERS	331
BUILDING CONSTRUCTION PRODUCTS	343
WEAR PROTECTION	349

*Note: Please send all feedback to <https://dealer.cat.com/en/ps/parts/parts-mktg/get/c/form.html>

Cat Ground Engaging Tools

MAKING THE MOST OUT OF GET RESOURCES

PEBJ0079 groups GET options together for HEX WHL TTT WTS MG.

Search by Part #, Model #, Blade Prefix

- Ctrl F (Find) your Part #, Model #, Blade Prefix (Dozer)
- Dozer & MG parts confirmed to fit blade
- Tip/Adapter grouped by edge thickness/series size

PEBJ0079 sorts GET parts by Machine type & Adapter/Tip size class with basic part dimensions and images for HEX WHL TTT WTS MG.

Dozer and MG tables confirm fit.

Bucket edge protection confirmed fit in PEBJ0128 or PEBJ0140 (below)

- Segments/Half Arrow
- Shrouds
- Sidebar Protection
- Liner Kits

Need professional marketing content you can print and give a customer?

[See PEBJ0078](#)



Looking for GET part # sorted by Machine type & Adapter/Tip size class with basic part dimensions and images?

[See PEBJ0128 & PEBJ0140](#)



D6 XL Semi U-Blades

Blade Serial Numbers: 1TP, 3FP, 1WP, 3RP, 4AP, 8SP, 8HM, 6DC, 6GA, D2S, MGH, D4S, C4N, C4L, JNE, KTL, GWH, EGE, RTE, RTE, RTF
Applies to: D6L, D6R2, D6T

End Bits and Cutting Edges 48"											
Type	Thickness	End Bit	Hardware	Position	Thickness	Edges	Quantity	Hardware	Notes		
Level Cut	.25	9V5-0814 9V5-0815	6 6	RH LH	15	8V9-1019	2	8	Equipments from Factory BT: WW-2162		
Utility	.25	122-0817 122-0818	6 6	RH LH	25	8V9-1043	2	8	BT: 907-2868		
GD	.30	8V-4411 8V-4410	6 6	RH LH	25	8V9-1043	2	8	BT: 907-2868		
Performance	.25	479-8132 479-8138	6 6	RH LH	25	479-8139 479-8140 479-8141	1 1 1	8	BT: 479-8150		
EWL	.30	8V9-1875 8V9-1876	6 6	RH LH	25	8V9-1043	2	8	BT: 907-2867		
Openings											
Level Cut A.R.M.	.25	433-0637 433-0639	6 6	RH LH							
EWL A.R.M.	.30	385-1027 385-1028	6 6	RH LH							
Hardware, Repair Parts and Wear Protection											
Type	Description	Part Number	Quantity	Notes							
Hardware	Bolts	3/8"-10 x 2-1/2	5J-4773	28	Ensure Base Edge is flat and not excessively worn. Clean and remove any paint or coating surfaces: Torque, Bang, Torque						
	Nuts	3/4"-10	2J-3506	28							
	Washers	3/4"	5P-0240	28							
Blade Repair	Edge Support	85-5205 85-1260	2 1								

Fit Checked to Blade SN Prefix

End Bit / Edge Options

Cutting Edge Support Replacement

70mm Bucket Edge Thickness

Machine Models: 352F, 349E/F, 336E/F-ME, 345D-ME, 346F-ME

Advantage 18 Adapters											
Type	Part Number	Open Thickness	A (mm)	B (mm)	C (mm)	D (mm)	E (mm)	F (mm)	Weight (kg)	Notes	
Center 2-Strap	988-2780	18	217	240	225	190	26	26	81.0		
HL2 2-Strap Center 2-Strap	988-2781	18	245	265	225	190	26	84.2			
HL2 2-Strap Center 2-Strap	988-2782	18	245	265	225	190	26	84.2			
Advantage 18 Tips											
Type	Part Number	Dimensions (mm)			Weight (kg)	Notes					
		A	B	C							
Heavy Duty	381-4391	208	150	120	57.0						
Standard Duty	381-4388	208	128	120	44.2						
WMA	381-4391	208	205	120	69.9						
Performance Plus	381-4389	204	150	120	51.3						
Performance	381-4392	208	90	120	40.0						
Light	381-4400	202	94	120	41.1						
Double Light	381-4393	204	200	120	66.2						
Openings											
Heavy Duty (208mm)	388-2852	200	150	120	52.7	The black areas in the pictures of the tips indicate the holes and the applied.					
Performance Plus (204mm)	388-2853	208	90	120	41.0						
Wear Protection											
Type	Material	Part Number	Width	Height	Radius / R1	Qty	Notes				
HEX Bucket Protector	N/A	320-2391	320	510	N/A	120-0960275-0081	2	New Sidebar Protector uses what fits the 381-2374.			
HEX Bucket Protector	N/A	340-2391	340	510	N/A	120-0960275-0081	2				
GP Sidecutter, RH	EP	1Y-0257	N/A	N/A	N/A	N/A	8				
GP Sidecutter, LH	EP	1Y-0258	6-8071	21-0207	N/A	N/A	8				
HD Sidecutter, RH	EP	207-2058	6-8071	21-0207	34-0204	N/A	8				
HD Sidecutter, LH	EP	207-2059	6-8071	21-0207	34-0204	N/A	8				
HD Sidecutter, RH	EP	208-2058	10-4827	21-0207	34-0204	N/A	10				
HD Sidecutter, LH	EP	208-2059	10-4827	21-0207	34-0204	N/A	10				
Welded Edge Shields											
Material	Shield Height	Shield Angle	Part Number	Width (mm)	Weight (kg)	Notes					
316, 304	70mm	22.5°	404-9023	55	15.9						
			404-9022	68	18.7						

Adapters

Tips

Sidebar & Edge Protection

Wheel Loaders



Cat Wheel Loaders

TIP CROSS REFERENCE TABLE

Size	Recommended Machine	Style	Cat® Advansys™ Series	K Series	CapSure J Series	J Series	
70 & 250	Excavator	WIDE	539-5670	N/A	N/A	208-5254	
	Excavator	PENETRATION	539-5677	N/A	N/A	9J-4259	
	Excavator	PENETRATION PLUS	539-5673	N/A	N/A	N/A	
	Excavator	SPIKE	N/A	N/A	N/A	9W-8259	
	Excavator	DOUBLE SPIKE	539-5675	N/A	N/A	135-8258	
	Excavator	GENERAL DUTY	539-5678	N/A	N/A	1U-3252	
	Wheel Loader	HEAVY ABRASION	539-5771	N/A	N/A	9N-4253	
	Wheel Loader	HEAVY DUTY	N/A	N/A	N/A	9N-4252	
	Wheel Loader	AGGREGATE	539-5776	N/A	N/A	N/A	
	Wheel Loader	GENERAL DUTY	539-5678	N/A	N/A	1U-3252	
	Wheel Loader	SHORT	N/A	N/A	N/A	1U-3251	
	SPECIALTY						
	Wheel Loader	HEAVY DUTY LONG LIFE (ARM)	N/A	N/A	N/A	N/A	135-8252
Wheel Loader	AGGREGATE LONG LIFE (ARM)	539-5777	N/A	N/A	N/A	N/A	
80 & 300	Excavators	WIDE	505-4080	475-5474	N/A	107-3300	
	Excavators	PENETRATION	505-4081	475-5469	N/A	9J-4309	
	Excavators	PENETRATION PLUS	505-4083	475-5470	N/A	183-5300	
	Excavators	SPIKE	505-4084	475-5471	N/A	168-1300	
	Excavators	DOUBLE SPIKE	505-4085	475-5472	N/A	135-9308	
	Excavators	GENERAL PURPOSE	505-4086	475-5473	N/A	1U-3302	
	Wheel Loader	HEAVY ABRASION	505-3981	475-5476	N/A	9N-4303	
	Wheel Loader	HEAVY PENETRATION	505-3980	475-5475	N/A	135-9300	
	Wheel Loader / Excavator	HEAVY DUTY	505-3982	475-5468	N/A	9N-4302	
	Wheel Loader	GENERAL PURPOSE	505-3984	475-5473	N/A	1U-3302	
	SPECIALTY						
	Excavators	PENETRATION LONG LIFE (ARM)	505-4082	N/A	N/A	N/A	125-8309
	Wheel Loader	HEAVY DUTY LONG LIFE (ARM)	505-3983	475-5477	N/A	N/A	125-8302
90 & 350	Excavators	WIDE	505-4096	475-5485	N/A	107-3350	
	Excavators	PENETRATION	505-4091	475-5481	N/A	9J-4359	
	Excavators	PENETRATION PLUS	505-4097	475-5482	N/A	168-1359	
	Excavators	SPIKE	505-4098	475-5483	N/A	168-1350	
	Excavators	DOUBLE SPIKE	505-4095	475-5491	N/A	135-9357	
	Excavators	GENERAL PURPOSE	505-4096	475-5484	N/A	1U-3352	
	Wheel Loader	HEAVY ABRASION	505-3991	475-5487	N/A	9N-4353	
	Wheel Loader	HEAVY PENETRATION	505-3990	475-5486	N/A	144-1358	
	Wheel Loader / Excavator	HEAVY DUTY	505-3996	475-5480	N/A	9N-4352	
	Wheel Loader	GENERAL PURPOSE	505-3994	475-5484	N/A	1U-3352	
	SPECIALTY						
	Excavators	PENETRATION LONG LIFE (ARM)	505-4092	475-5489	N/A	N/A	119-9359
	Wheel Loader	HEAVY DUTY LONG LIFE (ARM)	505-3993	475-5501	N/A	N/A	135-9352
100 & 400	Excavators	PENETRATION PLUS	505-4103	475-5494	N/A	168-1409	
	Excavators	WIDE	505-4100	475-5498	N/A	107-3400	
	Excavators	PENETRATION	505-4101	475-5493	N/A	6Y-7409	
	Excavators	SPIKE	505-4104	475-5495	N/A	159-0400	
	Excavators	DOUBLE SPIKE	505-4105	475-5496	N/A	135-9408	
	Excavators	GENERAL PURPOSE	505-4106	475-5497	N/A	7T-3402	
	Wheel Loader	HEAVY ABRASION	505-4001	475-5500	N/A	7T-3403	
	Wheel Loader	HEAVY PENETRATION	505-4000	475-5499	N/A	135-9400	
	Wheel Loader / Excavator	HEAVY DUTY	505-4002	475-5492	N/A	8E-4402	
	Wheel Loader	GENERAL PURPOSE	505-4004	475-5497	N/A	7T-3401	
	SPECIALTY						
	Excavators	PENETRATION LONG LIFE (ARM)	505-4102	475-5502	N/A	N/A	124-7409
	Wheel Loader	HEAVY DUTY LONG LIFE (ARM)	505-4003	475-5501	N/A	N/A	116-7402
110 & 450	Excavators	PENETRATION PLUS	505-4113	467-9823	N/A	159-0459	
	Excavators	WIDE	505-4110	470-7986	N/A	107-3450	
	Excavators	PENETRATION	505-4111	467-9822	N/A	9W-8459	
	Excavators	SPIKE	505-4114	470-7972	N/A	159-0450	
	Excavators	DOUBLE SPIKE	505-4115	470-7973	N/A	138-6458	
	Excavators	GENERAL PURPOSE	505-4116	467-9824	N/A	9W-8452	
	Wheel Loader	HEAVY ABRASION	505-4011	470-7974	N/A	9N-4453	
	Wheel Loader	HEAVY PENETRATION	505-4010	467-9825	N/A	138-6451	
	Wheel Loader / Excavator	HEAVY DUTY	5054012	467-9821	N/A	9N-4452	
	Wheel Loader	GENERAL PURPOSE	5054014	467-9824	N/A	9W-8452	
	SPECIALTY						
	Excavators	PENETRATION LONG LIFE (ARM)	505-4112	472-7763	N/A	N/A	116-7458
	Wheel Loader	HEAVY DUTY LONG LIFE (ARM)	505-4013	472-7763	N/A	N/A	101-9054

Cat Wheel Loaders

TIP CROSS REFERENCE TABLE

Size	Recommended Machine	Style	Cat® Advansys™ Series	K Series	CapSure J Series	J Series	
130 & 550	Excavators	WIDE	381-4091	470-7979	N/A	107-3550	
	Excavators	PENETRATION	381-4093	470-7975	N/A	9W-8559	
	Excavators	PENETRATION PLUS	381-4089	467-9813	460-8048	159-0559	
	Excavators	SPIKE	381-4090	470-7976	N/A	159-0550	
	Excavators	DOUBLE SPIKE	381-4092	470-7977	N/A	222-7553	
	Excavators	GENERAL PURPOSE	381-4088	470-7978	460-8044	9W-8552	
	Wheel Loader	EXTREME ABRASION ROCK (XAR)	539-5720	N/A	N/A	N/A	
	Wheel Loader	HEAVY ABRASION	381-4096	467-9814	460-8042	6Y-2553	
	Wheel Loader	HEAVY PENETRATION	381-4095	467-9816	460-8046	138-6552	
	Wheel Loader / Excavator	HEAVY DUTY	368-3791	467-9815	460-8050	9N-4552	
	Wheel Loader	GENERAL PURPOSE	381-4094	470-9798	460-8044	9W-8552	
	Wheel Loader	COAL	368-3860	N/A	N/A	N/A	
	SPECIALTY						
	Excavators	PENETRATION LONG LIFE (ARM)	368-3858	472-7766	N/A	113-0559	
	Wheel Loader	HEAVY ABRASION (ARM)	486-6524	N/A	N/A	N/A	
	Wheel Loader	HEAVY PEN LONG LIFE (ARM)	N/A	472-7767	N/A	N/A	
Wheel Loader	HEAVY DUTY LONG LIFE (ARM)	368-3857	472-7765	N/A	101-9055		
150 & 600	Excavators	WIDE	368-3790	470-7981	N/A	N/A	
	Excavators	PENETRATION	368-3785	470-7982	N/A	7I-7609	
	Excavators	PENETRATION PLUS	368-3783	467-9817	459-2180	159-0607	
	Excavators	SPIKE	368-3787	470-7983	N/A	159-0600	
	Excavators	DOUBLE SPIKE	368-3788	470-7984	N/A	222-7603	
	Excavators	GENERAL PURPOSE	368-3789	470-7985	N/A	6I-6602	
	Wheel Loader	EXTREME ABRASION ROCK (XAR)	539-5730	N/A	N/A	N/A	
	Wheel Loader	HEAVY ABRASION	368-3863	467-9818	459-2186	6I-6603	
	Wheel Loader	HEAVY PENETRATION	368-3862	467-9820	459-2184	135-9600	
	Wheel Loader / Excavator	HEAVY DUTY	368-3786	467-9819	459-2182	7Y-0602	
	Wheel Loader	GENERAL PURPOSE	368-3879	470-7985	N/A	N/A	
	Wheel Loader	COAL	368-3865	N/A	N/A	N/A	
	SPECIALTY						
	Excavators	PENETRATION LONG LIFE (ARM)	368-3874	472-7769	N/A	119-9609	
	Wheel Loader	HEAVY ABRASION (ARM)	486-6520	N/A	N/A	N/A	
	Wheel Loader	HEAVY PEN LONG LIFE (ARM)	N/A	472-7770	N/A	N/A	
Wheel Loader	HEAVY DUTY LONG LIFE (ARM)	368-3861	472-7768	N/A	107-8602		
170 & 700	Excavators	WIDE	368-3866	223-8170	N/A	N/A	
	Excavators	PENETRATION	368-3868	232-0172	N/A	4T-4709	
	Excavators	PENETRATION PLUS	368-3869	232-0173	455-1024	171-1709	
	Excavators	SPIKE	368-3870	232-0177	N/A	136-8700	
	Excavators	DOUBLE SPIKE	368-3871	232-0178	N/A	N/A	
	Excavators	GENERAL PURPOSE	368-3872	232-0179	N/A	4T-4702	
	Wheel Loader	HEAVY ABRASION	368-3864	232-2178	459-2186	9U-9703	
	Wheel Loader	HEAVY PENETRATION	368-3873	264-2172	459-2184	135-9700	
	Wheel Loader / Excavator	HEAVY DUTY	368-3867	264-2171	459-2182	9U-9702	
	Wheel Loader	GENERAL PURPOSE	368-3880	232-0179	N/A	4T-4702	
	Wheel Loader	COAL	368-3875	N/A	N/A	N/A	
	SPECIALTY						
	Excavators	PENETRATION LONG LIFE (ARM)	387-6866	233-7171	N/A	N/A	
	Wheel Loader	HEAVY ABRASION (ARM)	486-6522	N/A	N/A	N/A	
	Wheel Loader	HEAVY DUTY LONG LIFE (ARM)	387-6856	233-7170	N/A	107-2001	
	200 & 800	Excavators	PENETRATION	368-3877	N/A	N/A	117-6809
Excavators		PENETRATION PLUS	368-3878	N/A	453-3646	N/A	
Excavators		GENERAL PURPOSE	385-4811	N/A	N/A	N/A	
Wheel Loader		HEAVY ABRASION	385-4813	N/A	444-7594	6I-8803	
Wheel Loader		HEAVY PENETRATION	385-4812	N/A	444-7577	135-9800	
Wheel Loader / Excavator		HEAVY DUTY	385-4814	N/A	453-3648	6I-8802	
Wheel Loader		GENERAL PURPOSE	368-3876	N/A	N/A	N/A	
Wheel Loader		COAL	387-6869	N/A	N/A	N/A	
SPECIALTY							
Excavators		PENETRATION LONG LIFE (ARM)	378-6868	N/A	N/A	N/A	
Wheel Loader	HEAVY ABRASION (ARM)	486-6526	N/A	N/A	N/A		
Wheel Loader	HEAVY DUTY LONG LIFE (ARM)	387-6867	N/A	N/A	117-6802*		

Cat Wheel Loaders

TIP CROSS REFERENCE TABLE

Size	Recommended Machine	Style	Cat® Advansys™ Series	K Series	CapSure J Series	J Series
220	Wheel Loader	HEAVY ABRASION	431-0065	N/A	N/A	N/A
	Wheel Loader	EXTREME ABRASION ROCK	544-0456	N/A	N/A	N/A
	Wheel Loader	HEAVY PENETRATION	431-0062	N/A	N/A	N/A
	Wheel Loader	GENERAL PURPOSE	431-0064	N/A	N/A	N/A
	Wheel Loader	COAL	431-0069	N/A	N/A	N/A
	SPECIALTY					
	Wheel Loader	HEAVY ABRASION (ARM)	431-0066	N/A	N/A	N/A
230	Wheel Loader	HEAVY ABRASION	532-7015	N/A	N/A	N/A
	Wheel Loader	EXTREME ABRASION ROCK (XAR)	539-5642	N/A	N/A	N/A

General Duty Tips Options		
General Duty Tip Sizes	Shape	Part #
250	Long	449-2156
	Long	449-2159
300	Heavy Duty Long	449-2160
	Penetration Plus	450-7556
350	Long	449-2161
	Heavy Duty Long	449-2162
	Penetration Plus	389-5743
400	Long	449-2164
	Heavy Duty Long	389-5744
	Penetration Plus	389-5745
460	Long	449-2167
	Heavy Duty Long	389-5746
	Penetration Plus	389-5747

*General Duty tips are for low impact applications only.

Cat Wheel Loaders

ADAPTERS CROSS REFERENCE TABLE

Size	Style	Cat Advansys™ Series	K Series	
70	LDR Flushmount – CTR	539-5610	N/A	
	LDR Bottom Strap – CTR	539-5611	N/A	
	LDR Bolt-On – CRT	539-5600	N/A	
	LDR Bolt-On Corner -RH	539-5601	N/A	
	LDR Bolt-On Corner – LH	539-5602	N/A	
80	LDR FLUSHMOUNT - CTR (25-38mm)	505-4030	229-7084	
	LDR FLUSHMOUNT - CNR / RH,LH (25-38mm)	N/A	N/A	
	LDR FLUSHMOUNT - CTR (25-38mm)	N/A	N/A	
	LDR BOLT-ON - CTR (32mm)	505-4029	222-1087	
	LDR BOLT-ON CORNER - RH (32/25)	505-4032	222-1088	
	LDR BOLT-ON CORNER - LH (32/25)	505-4033	222-1089	
	LDR BOLT-ON - CTR (25mm)	505-4034	229-7087	
	LDR BOLT-ON CORNER - RH (32/25)	505-4032	222-1088	
	LDR BOLT-ON CORNER - LH (32/25)	505-4033	222-1089	
	90	LDR TWO STRAP - CTR (40mm)	505-4040	222-1094
LDR TWO STRAP - RH (40mm)		505-4041	222-1095	
LDR TWO STRAP - LH (40mm)		505-4042	222-1096	
LDR FLUSHMOUNT - CTR (32-45mm)		505-4043	229-7094	
LDR FLUSHMOUNT - CNR / RH,LH (32-45mm)		N/A	N/A	
LDR FLUSHMOUNT - CTR (32-45mm)		N/A	N/A	
LDR BOLT-ON - CTR (40mm)		505-4044	222-1097	
LDR BOLT-ON CORNER - RH (40/32mm)		505-4045	229-7098	
LDR BOLT-ON CORNER - LH (40/32mm)		505-4046	229-7099	
LDR BOLT-ON - CTR (32mm)		505-4047	223-8097	
LDR BOLT-ON CORNER - RH (40/32mm)		505-4045	229-7098	
LDR BOLT-ON CORNER - LH (40/32mm)		505-4046	229-7099	
100		LDR TWO STRAP - CTR (45mm)	505-4050	223-8104
		LDR TWO STRAP - RH (45mm)	505-4153	223-8105
	LDR TWO STRAP - LH (45mm)	505-4154	223-8106	
	LDR TWO STRAP LONG LIFE - CTR (ARM) (45mm)	505-4155	229-7100	
	LDR TWO STRAP LONG LIFE - RH (ARM) (45mm)	505-4156	229-7101	
	LDR TWO STRAP LONG LIFE - LH (ARM) (45mm)	505-4157	229-7102	
	LDR FLUSHMOUNT - CTR (38-51mm)	505-4056	229-7104	
	LDR FLUSHMOUNT - CNR / RH,LH (38-51mm)	N/A	N/A	
	LDR FLUSHMOUNT - CTR (38-51mm)	N/A	N/A	
	LDR BOLT-ON - CTR (45mm)	505-4057	223-8107	
	LDR BOLT-ON CORNER - RH (45mm)	505-4058	223-8108	
	LDR BOLT-ON CORNER - LH (45mm)	505-4059	223-8109	

Cat Wheel Loaders

ADAPTERS CROSS REFERENCE TABLE

Size	Style	Cat Advansys™ Series	K Series
110	LDR TWO STRAP - CTR (51mm)	505-4060	472-0811
	LDR TWO STRAP - CTR (51mm)	505-4061	472-0812
	LDR TWO STRAP - CTR (51mm)	505-4062	472-0813
	LDR TWO STRAP LONG LIFE - CTR (ARM) (51mm)	505-4063	472-7747
	LDR TWO STRAP LONG LIFE - RH (ARM) (51mm)	505-4064	472-7748
	LDR TWO STRAP LONG LIFE - LH (ARM) (51mm)	505-4065	472-7749
	LDR FLUSHMOUNT - CTR (45-51mm)	505-4066	472-0826
	LDR FLUSHMOUNT - CNR / RH, LH (45-51mm)	N/A	N/A
	LDR FLUSHMOUNT - CTR (45-51mm)	N/A	N/A
	LDR BOLT-ON - CTR (50mm)	505-4067	472-0814
LDR BOLT-ON CORNER - RH (50mm)	505-4068	472-0815	
LDR BOLT-ON CORNER - LH (50mm)	505-4069	472-0816	
130	LDR TWO STRAP - CTR (63.5mm)	368-3764	472-0790
	LDR TWO STRAP - RH (63.5mm)	368-3765	472-0791
	LDR TWO STRAP - LH (63.5mm)	368-3766	472-0792
	LDR TWO STRAP - CTR (51mm)	387-6842	472-0794
	LDR TWO STRAP - RH (51mm)	387-6843	472-0795
	LDR TWO STRAP - LH (51mm)	387-6844	472-0796
	LDR TWO STRAP LONG LIFE - CTR (ARM) (63.5mm)	387-7240	472-7750
	LDR TWO STRAP LONG LIFE - RH (ARM) (63.5mm)	387-7241	472-7751
	LDR TWO STRAP LONG LIFE - LH (ARM) (63.5mm)	387-7242	472-7752
	LDR TWO STRAP LONG LIFE - CTR (ARM) (51mm)	387-7243	472-7753
	LDR TWO STRAP LONG LIFE - RH (ARM) (51mm)	387-7244	472-7754
	LDR TWO STRAP LONG LIFE - LH (ARM) (51mm)	387-7245	472-7755
	LDR FLUSHMOUNT - CTR (51-64mm)	368-3784	472-0797
	LDR FLUSHMOUNT - CNR / RH, LH (51-64mm)	368-3775	472-0798
	LDR FLUSHMOUNT - CTR (51-64mm)	N/A	472-0793
	FLUSHMOUNT ADAPTER COVER - CTR	491-4054	251-2180
FLUSHMOUNT ADAPTER COVER - CORNER	491-4053	251-2461	

Cat Wheel Loaders

ADAPTERS CROSS REFERENCE TABLE

Size	Style	Cat Advansys™ Series	K Series
150	LDR TWO STRAP - CTR (70mm)	368-3803	472-0799
	LDR TWO STRAP - RH (70mm)	368-3804	472-0800
	LDR TWO STRAP - LH (70mm)	368-3805	472-0801
	LDR TWO STRAP - CTR (63.5mm)	368-3794	472-0805
	LDR TWO STRAP - RH (63.5mm)	368-3804	472-0806
	LDR TWO STRAP - LH (63.5mm)	368-3805	472-0807
	LDR TWO STRAP LONG LIFE - CTR (ARM) (70mm)	368-3806	472-7756
	LDR TWO STRAP LONG LIFE - RH (ARM) (70mm)	368-3807	472-7757
	LDR TWO STRAP LONG LIFE - LH (ARM) (70mm)	368-3808	472-7758
	LDR TWO STRAP LONG LIFE - CTR (ARM) (63.5mm)	433-8223	472-7759
	LDR TWO STRAP LONG LIFE - RH (ARM) (63.5mm)	433-8224	472-7760
	LDR TWO STRAP LONG LIFE - LH (ARM) (63.5mm)	433-8225	472-7761
	LDR FLUSHMOUNT - CTR (64-76mm)	465-0460	471-9579
	LDR FLUSHMOUNT - CNR / RH, LH (64-76mm)	465-0461	471-9578
LDR FLUSHMOUNT - CTR (64-76mm)(22.5deg)	N/A	472-0808	
FLUSHMOUNT ADAPTER COVER - CTR	491-4056	232-0152	
FLUSHMOUNT ADAPTER COVER - CORNER	491-4055	232-0153	
170	LDR TWO STRAP - CTR (90mm)	368-3831	478-2540
	LDR TWO STRAP - RH (90mm)	368-3832	478-2541
	LDR TWO STRAP - LH (90mm)	368-3833	478-2542
	LDR TWO STRAP - CTR (76mm)	368-3825	478-2535
	LDR TWO STRAP - RH (76mm)	368-3826	478-2536
	LDR TWO STRAP - LH (76mm)	368-3827	478-2537
	LDR TWO STRAP LONG LIFE - CTR (ARM) (90mm)	368-3834 (90mm)	395-3303 (90mm)
	LDR TWO STRAP LONG LIFE - RH (ARM) (90mm)	368-3835 (90mm)	395-3304 (90mm)
	LDR TWO STRAP LONG LIFE - LH (ARM) (90mm)	368-3836 (90mm)	395-3305 (90mm)
	LDR TWO STRAP LONG LIFE - CTR (ARM) (76mm)	368-3837 (76mm)	478-7591* (76mm)
	LDR TWO STRAP LONG LIFE - RH (ARM) (76mm)	368-3838 (76mm)	478-7592* (76mm)
	LDR TWO STRAP LONG LIFE - LH (ARM) (76mm)	368-3839 (76mm)	478-7593* (76mm)
	LDR TWO STRAP LONG LIFE - CTR (ARM) (70mm)	N/A	478-7594* (70mm)
	LDR TWO STRAP LONG LIFE - RH (ARM) (70mm)	N/A	478-7595* (70mm)
	LDR TWO STRAP LONG LIFE - LH (ARM) (70mm)	N/A	478-7596* (70mm)
	LDR FLUSHMOUNT - CTR (76-90mm)	368-3828	478-2543
LDR FLUSHMOUNT - CNR / RH, LH (76-90mm)	368-3830	478-2544	
FLUSHMOUNT ADAPTER COVER - CTR	491-4058	264-2060	
FLUSHMOUNT ADAPTER COVER - CORNER	491-4057	264-2061	
200	LDR TWO STRAP - CTR (100mm/22.5)	368-3852	N/A
220	LDR TWO STRAP - CTR (100mm)	506-2548	N/A
230	LDR TWO STRAP - CTR (100mm)	525-6541	N/A

Cat Wheel Loaders

BASE EDGE TABLE

Base Edge Assembly Dimensional Reference

Adapter Size Class	Adapter Series	Part Number					Edge Style	Adapter Quantity Welded on Edge
			A	B	C	D		
80	K Series	(485-1784)	400	270	35	270	Straight	2
80	K Series	(485-1784)	400	270	35	270	Straight	2
80	K Series	478-1476	618	300	35	488	Straight	3
80	K Series	478-1476	618	300	35	488	Straight	3
80	K Series	463-0681	618	270	35	488	Straight	3
80	K Series	463-0681	618	270	35	488	Straight	3
80	Advansys	(558-7856)	618	270	35	488	Straight	3
80	K Series	492-3712	690	270	35	560	Straight	3
80	K Series	492-3712	690	270	35	560	Straight	3
80	Advansys	(558-7857)	690	270	35	560	Straight	3
80	K Series	482-2658	690	300	35	560	Straight	3
80	K Series	482-2658	690	300	35	560	Straight	3
80	Advansys	561-2647	690	300	35	560	Straight	3
80	K Series	463-2081	790	300	35	660	Straight	3
80	K Series	463-2081	790	300	35	660	Straight	3
80	Advansys	561-2648	790	300	35	660	Straight	3
80	K Series	456-0430	790	270	35	660	Straight	3
80	K Series	456-0430	790	270	35	660	Straight	3
80	Advansys	558-7858	790	270	35	660	Straight	3
80	K Series	543-2957	890	270	35	760	Straight	4
80	K Series	543-2957	890	270	35	760	Straight	4
80	K Series	482-2676	900	300	35	768	Straight	4
80	K Series	482-2676	900	300	35	768	Straight	4
80	K Series	456-2294	996	300	35	866	Straight	4
80	K Series	456-2294	996	300	35	866	Straight	4
80	Advansys	561-2653	996	300	35	866	Straight	4
80	K Series	456-0421	996	270	35	866	Straight	4
80	K Series	456-0421	996	270	35	866	Straight	4
80	Advansys	558-7859	996	270	35	866	Straight	4
80	K Series	485-2497	1184	270	35	1054	Straight	5
80	K Series	485-2497	1184	270	35	1054	Straight	5
80	K Series	442-6133	1184	300	35	1054	Straight	5
80	K Series	442-6133	1184	300	35	1054	Straight	5
80	Advansys	561-2650	1184	300	35	1054	Straight	5
80	K Series	457-1968	1290	300	35	1160	Straight	5
80	K Series	457-1968	1290	300	35	1160	Straight	5
80	K Series	469-3248	1390	300	35	1260	Straight	5
80	K Series	469-3248	1390	300	35	1260	Straight	5
80	Advansys	561-2651	1390	300	35	1260	Straight	5
80	K Series	469-1253	1504	300	35	1374	Straight	5
80	K Series	469-1253	1504	300	35	1374	Straight	5
80	Advansys	561-2652	1504	300	35	1374	Straight	5
80	K Series	489-0590	1604	300	35	1474	Straight	5
80	K Series	489-0590	1604	300	35	1474	Straight	5
80	K Series	257-1749*	2370	245	25	2386.2	Straight	8
80	K Series	257-1749*	2370	245	25	2386.2	Straight	8
80	K Series	(257-1747)	2370	245	25	2387.6	Straight	8
80	K Series	(257-1747)	2370	245	25	2387.6	Straight	8
80	K Series	(257-1748)	2370	245	25	2386.2	Straight	8
80	K Series	(257-1748)	2370	245	25	2386.2	Straight	8
80	K Series	258-6901	2438.5	228.6	25	2321	Straight	8
80	K Series	258-6901	2438.5	228.6	25	2321	Straight	8
80	K Series	264-1914	2438.5	228.6	25	2321	Straight	8
80	K Series	264-1914	2438.5	228.6	25	2321	Straight	8
80	K Series	276-1635*	2438.5	228.6	25	2321	Straight	8
80	K Series	276-1635*	2438.5	228.6	25	2321	Straight	8

Cat Wheel Loaders

BASE EDGE TABLE

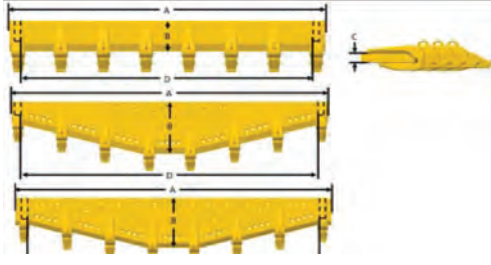
Base Edge Assembly Dimensional Reference								
Adapter Size Class	Adapter Series	Part Number					Edge Style	Adapter Quantity Welded on Edge
			A	B	C	D		
80	K Series	276-1636*	2438.5	228.6	25	2321	Straight	8
80	K Series	276-1636*	2438.5	228.6	25	2321	Straight	8
80	K Series	257-1826*	2825	282	32	2723	Straight	8
80	K Series	257-1826*	2825	282	32	2723	Straight	8
80	K Series	(257-1766)	2886	282	32	2879.3	Straight	8
80	K Series	(257-1766)	2886	282	32	2879.3	Straight	8
80	K Series	(355-0093)	2994	300	35	2884.1	Straight	8
80	K Series	(355-0093)	2994	300	35	2884.1	Straight	8
80	K Series	(316-7906)	2994	282	32	2884	Straight	8
80	K Series	(316-7906)	2994	282	32	2884	Straight	8
80	K Series	485-7019	2994	300	35	2884	Straight	8
80	K Series	485-7019	2994	300	35	2884	Straight	8
80	Advansys	573-8153	2994	300	35	2884	Straight	8
80	K Series	(355-0092)	2994	300	35	2884	Straight	8
80	K Series	(355-0092)	2994	300	35	2884	Straight	8
80	Advansys	548-6933	2994	300	35	2884	Straight	8
80	K Series	498-4838	3200	300	35	3090	Straight	8
80	K Series	498-4838	3200	300	35	3090	Straight	8
90	K Series	506-2974	805	304.8	44.45	674	Straight	3
90	K Series	475-3563	905	304.8	44.45	774	Straight	3
90	K Series	463-3409	1205	304.8	44.45	1074	Straight	4
90	K Series	463-3410	1305	304.8	44.45	1176	Straight	5
90	K Series	463-3411	1405	304.8	44.45	1276	Straight	5
90	Advansys	576-8178	1405	304.8	44.45	1276	Straight	5
90	K Series	463-3412	1505	304.8	44.45	1378	Straight	5
90	K Series	463-3413	1605	304.8	44.45	1480	Straight	6
90	K Series	483-7992	1659	304.8	44.45	1530	Straight	6
90	Advansys	555-7559	2000	392.4	40	1880	Stepped	5
90	Advansys	553-4122	2060	396.5	40	1940	Stepped	5
90	Advansys	553-4125	2250	407.2	40	2130	Stepped	5
90	Advansys	553-4149	2450	393.8	40	2330	Stepped	6
90	K Series	(367-4145)	2489.2	300	40	2353.2	Straight	7
90	K Series	253-0092*	2498	283.6	32	2466.4	Straight	8
90	K Series	(253-0091)	2498	283.6	32	2466.4	Straight	8
90	K Series	(233-7151)	2498	283.6	32	2466.4	Straight	8
90	K Series	256-4723	2583	282	32	2457 / 2458	Straight	8
90	Advansys	559-1174	2583	282	32	2457 / 2458	Straight	8
90	K Series	(466-7091)	2598	282	32	2466.4	Straight	8
90	K Series	(365-7459)	2692.4	300	40	2556.4	Straight	7
90	K Series	257-1827*	2815	493	35	2716	Spade	8
90	K Series	(257-1775)	2846	300	40	2819.4	Straight	8
90	K Series	(257-1750)	2846	300	40	2819.4	Straight	8
90	K Series	279-8743*	2846	300	40	2791.5	Straight	8
90	K Series	257-1751*	2846	300	40	2791.5	Straight	8
90	K Series	258-8638*	2934	289.5	40	2803.5	Straight	8
90	K Series	257-1828*	2969	493	35	2870	Spade	8
90	K Series	279-8174*	2969	493	35	2848	Spade	8
90	K Series	273-3765	2969	493	35	2850	Spade	8
90	Advansys	559-1173	2969	493	35	2850	Spade	8
90	K Series	238-9684*	2969	493	35	2850	Spade	8
90	K Series	(371-3969)	2969	487	40	2856	Stepped	8
90	Advansys	549-4682	2969	543	35	2847.5	Spade	8
90	K Series	(309-1457)	2990	290	40	2859.5	Straight	8
90	K Series	516-9272	2994	300	45	2871	Straight	8
90	K Series	(505-6193)	2994	300	40	2871	Straight	8

Cat Wheel Loaders

BASE EDGE TABLE

Base Edge Assembly Dimensional Reference

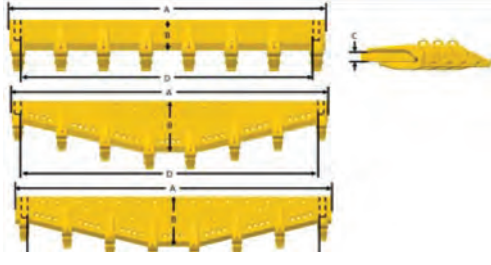
Adapter Size Class	Adapter Series	Part Number					Edge Style	Adapter Quantity Welded on Edge
			A	B	C	D		
90	K Series	375-3145	2994	300	40	2781	Straight	8
90	Advansys	553-7430	2994	300	40	2781	Straight	8
90	K Series	479-7329	2994	300	40	2871	Straight	8
90	K Series	472-2266	2994	300	45	2871	Straight	8
90	K Series	316-7923*	3000	300	40	2882.3	Straight	8
90	K Series	257-1825*	3085	577	40	2986	Spade	8
90	K Series	(229-6942)	3193	300	40	3159.4	Straight	8
90	K Series	393-9390	3200	300	45	3072	Straight	8
90	K Series	395-0689	3252	300	40	3141	Straight	8
90	K Series	545-5823	3252	300	40	3141	Straight	8
90	K Series	512-0561	3294	300	45	3166	Straight	8
90	K Series	(355-0022)	3294	300	45	3166	Straight	8
90	Advansys	557-9613	3294	300	45	3166	Straight	8
90	K Series	(355-0023)	3294	300	50	3166	Straight	8
100	K Series	304-8216	3252	626	45	3133	Spade	8
100	K Series	270-4122	3350	645	45	3204	Spade	8
100	Advansys	570-3830	3350	645	45	3204	Spade	8
100	K Series	257-1824*	3378	647	45	3230	Spade	8
100	K Series	(257-1770)	3405	304.8	45	3295	Straight	8
100	K Series	261-8714	3492	645	45	3373.6	Spade	8
100	Advansys	563-0181	3492	645	45	3373.6	Spade	8
100	K Series	359-0002	3492	537	50.8	3380	Stepped	8
100	K Series	261-8713	3492	304.8	44.5	3370	Straight	8
100	K Series	261-8715	3518	645	45	3373.6	Spade	8
100	Advansys	525-1134	3518	645	45	3373.6	Spade	8
100	K Series	(456-5269)	3520	300	50	3390	Straight	8
100	K Series	487-7422	3520	300	50	3390	Straight	8
100	K Series	(456-5362)	3520	300	50	3390	Straight	8
100	K Series	513-6714	3538	645	45	3400.2	Spade	8
100	K Series	277-1830*	3580	305	45	3450	Straight	8
100	K Series	(345-9778)	3580	305	45	3450	Straight	10
100	K Series	(356-4595)	3580	300	50	3450	Straight	8
100	K Series	(356-4596)	3580	300	50	3450	Straight	8
100	K Series	525-2224	3580	305	44.5	3390	Straight	8
100	K Series	453-4986	3630	300	50	3495	Straight	8
100	K Series	492-4199	3682	305	44.5	3537.8	Straight	8
100	K Series	481-1635	3688	300	50	3553	Straight	8
110	K Series	285-3342*	1300	502.9	50	1136	Spade	5
110	K Series	289-0771	1589.4	471.4	50	1442	Spade	6
110	K Series	273-3951*	1812	380	60	1610	Straight	7
110	K Series	353-0052*	1978	507.6	50.8	1832	Spade	8
110	Advansys	555-7562	2510	447.6	50	2370	Stepped	5
110	K Series	513-2233	2640	618	50.8	2480	Spade	6
110	Advansys	553-4128	2650	518.6	50	2530	Stepped	6
110	K Series	464-7258	2760	651.7	50	2620	Spade	6
110	Advansys	568-8852	2844	330	50	2680	Straight	6
110	Advansys	568-8856	2844	330	50	2680	Straight	6
110	K Series	363-1581*	2845	381	50.8	2709	Straight	7
110	K Series	482-9630	2845	381	50.8	2709	Straight	7
110	Advansys	553-4131	2950	428.4	50	2830	Stepped	6
110	Advansys	573-9465	3072	325	50	2910	Straight	6
110	K Series	343-8971*	3250	381	50.8	3114	Straight	7
110	K Series	482-9479	3250	381	50.8	3114	Straight	7
110	K Series	312-0190*	3390	5 330	50.8	3254.5	Straight	7
110	K Series	260-1385	3492	645	50.8	3360	Spade	8

Cat Wheel Loaders

BASE EDGE TABLE

Base Edge Assembly Dimensional Reference

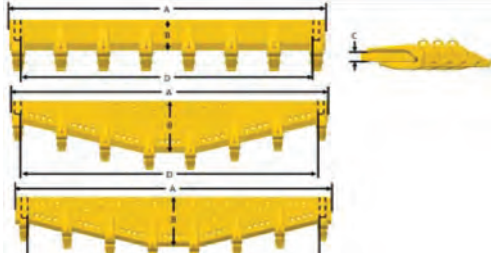
Adapter Size Class	Adapter Series	Part Number					Edge Style	Adapter Quantity Welded on Edge
			A	B	C	D		
110	Advansys	558-6720	3492	645	50.8	3360	Spade	8
110	K Series	370-1805	3544	560	50.8	3380	Stepped	8
110	K Series	260-1384	3568	280	50	3388	Straight	6
110	K Series	272-1407	3644	706	50	3490	Spade	6
110	K Series	394-0351	3644	708	50	3490	Spade	8
110	Advansys	525-1135	3644	708	50	3490	Spade	8
110	K Series	256-2931*	3645	330	50.8	3480	Straight	8
110	K Series	256-2934	3645	706	50.8	3490	Spade	8
110	Advansys	547-5079	3645	706	50.8	3490	Spade	8
110	K Series	232-0167	3695	400	50	3684.4	Straight	8
110	K Series	257-1829*	3772	349	50.8	3627	Straight	8
110	K Series	476-5458	3800	318	50.8	3640	Straight	8
110	K Series	476-5458	3800	318	50.8	3640	Straight	8
110	K Series	476-5455	3800	318	50.8	3640	Straight	8
110	K Series	476-5455	3800	318	50.8	3640	Straight	8
110	K Series	294-8794*	3800	525	50.8	3640	Straight	8
110	K Series	246-2743	3800	708	50.8	3646	Spade	8
110	Advansys	563-0182	3800	708	50.8	3646	Spade	8
110	K Series	292-9453*	3800	708	50.8	3660	Spade	8
110	Advansys	(563-0183)	3800	708	50.8	3660	Spade	8
110	K Series	476-5459	3810	700	50.8	3660	Stepped	8
110	K Series	476-5459	3810	700	50.8	3660	Stepped	8
110	Advansys	538-2272	3810	700	50.8	3660	Stepped	8
110	K Series	434-2922	3812	655	50	3664	Spade	8
110	K Series	476-2133	3812	655	50	3664	Spade	8
110	K Series	498-1719	3812	729.8	50.8	3662	Spade	8
110	Advansys	518-8721	3812	729.8	50.8	3662	Spade	8
110	K Series	257-1831*	3900	705	50.8	3750	Stepped	8
110	K Series	257-1832*	3900	510	50.8	3760	Straight	8
110	K Series	264-2212*	3960	510	50.8	3752	Straight	8
110	Advansys	563-0184	3964	706	50	3776	Spade	8
110	K Series	246-2746	3980	705	50.8	3830	Stepped	8
110	Advansys	538-8049	3980	705	50.8	3830	Stepped	8
110	K Series	236-4693*	3980	785	50.8	3850	Stepped	8
110	K Series	468-4927	4020	430	50	3829	Straight	8
110	K Series	(476-5453)	4020	430	50	3829	Straight	8
110	K Series	366-1577	4020	670	50.8	3830	Spade	8
110	K Series	476-5454	4020	670	50.8	3830	Spade	8
110	K Series	476-2217	4020	785	50.8	3836	Stepped	8
110	K Series	476-2217	4020	785	50.8	3836	Stepped	8
110	Advansys	538-8047	4020	785	50.8	3836	Stepped	8
130	K Series	464-7292	2760	651.7	50	2620	Spade	6
130	Advansys	555-7565	2790	495	50	2622	Stepped	6
130	Advansys	553-4137	2874	498.3	50	2722	Stepped	6
130	Advansys	555-7568	2951	475.7	50	2790	Stepped	6
130	Advansys	574-3471	3006.8	678.1	548.7	2694	Stepped	5
130	Advansys	552-3311	3032	718	50	2882	Spade	6
130	Advansys	552-9409	3032	632.9	50	2882	Stepped	6
130	Advansys	553-4134	3084	506.4	50	2932	Stepped	6
130	K Series	(340-8914)*	3207	785.1	63.5	3001	Stepped	6
130	Advansys	(550-6189)	3207	785.1	63.5	3001	Stepped	6
130	K Series	(340-8914)*	3207	785.1	50	3001	Stepped	6
130	Advansys	555-7571	3365	516	50	3204	Stepped	6
130	K Series	351-0527	3390.5	399	26.5	3219.4	Straight	7
130	Advansys	(550-8879)	3390.5	399	26.5	3219.4	Straight	7

Cat Wheel Loaders

BASE EDGE TABLE

Base Edge Assembly Dimensional Reference

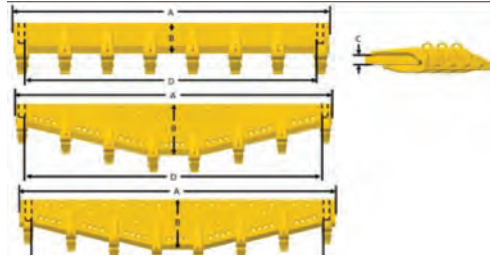

Adapter Size Class	Adapter Series	Part Number					Edge Style	Adapter Quantity Welded on Edge
			A	B	C	D		
130	K Series	335-7230*	3600	771	63.5	3394	Stepped	7
130	K Series	479-0544	3600	771	63.5	3394	Stepped	7
130	K Series	273-0102	3600	539	50	3394	Straight	7
130	Advansys	550-8889	3600	539	50	3394	Straight	7
130	K Series	(296-4316)	3600	770.8	50	3394	Stepped	7
130	K Series	358-8089	3610	399	63.5	2444	Straight	6
130	K Series	(478-5416)	3610	399	63.5	2444	Straight	6
130	K Series	319-3529*	3760	603	50.8	3535	Spade	7
130	Advansys	550-6191	3760	603	50.8	3535	Spade	7
130	K Series	256-2938*	3772	655	50.8	3614	Spade	8
130	Advansys	545-8959	3772	655	50.8	3614	Spade	8
130	Advansys	573-9483	3772	655	50	3614	Spade	8
130	K Series	257-1834*	3822	655	50.8	3629.4	Spade	8
130	Advansys	545-8955	3822	655	50.8	3629.4	Spade	8
130	K Series	314-6409	3830	700	50.8	3660	Stepped	8
130	K Series	478-5427	3830	700	50.8	3660	Stepped	8
130	Advansys	550-8884	3830	700	50.8	3660	Stepped	8
130	K Series	446-1961	3840	730.7	50.8	3662	Spade	8
130	K Series	478-2730	3840	730.7	50.8	3662	Spade	8
130	Advansys	528-5072	3840	730.7	50.8	3662	Spade	8
130	K Series	448-9552*	3850	700	50.8	3670	Stepped	8
130	K Series	478-2729	3850	700	50.8	3670	Stepped	8
130	Advansys	528-5076	3850	700	50.8	3682	Stepped	8
130	K Series	366-1611	3852	781.5	63.5	3678	Spade	8
130	K Series	478-5426	3852	781.5	63.5	3678	Spade	8
130	Advansys	540-3529	3852	781.5	63.5	2638	Spade	6
130	K Series	479-0538	3860	399	63.5	3680	Straight	8
130	K Series	479-0538	3860	399	63.5	3680	Straight	8
130	K Series	257-1833*	3862	696	63.5	3684	Spade	7
130	Advansys	536-7936	3862	696	63.5	3684	Spade	7
130	K Series	319-4034*	3862	719.3	63.5	3662	Stepped	7
130	K Series	(479-0534)	3862	719.3	63.5	3662	Stepped	7
130	K Series	478-5417	3862	719.3	63.5	3662	Stepped	7
130	K Series	478-5417	3862	719.3	63.5	3662	Stepped	7
130	Advansys	505-9462	3862	719.3	63.5	3662	Stepped	7
130	K Series	288-8349*	3900	510	50.8	3750	Straight	8
130	K Series	253-9582*	3926	600	63.5	3662	Stepped	7
130	Advansys	550-8886	3926	600	63.5	3662	Stepped	7
130	K Series	478-5423	3926	600	63.5	3662	Stepped	7
130	K Series	478-5423	3926	600	63.5	3662	Stepped	7
130	K Series	480-9093	3926	600	63.5	3662	Stepped	7
130	Advansys	550-8877	3926	600	63.5	3662	Stepped	7
130	K Series	478-5425	3926	600	63.5	3662	Stepped	7
130	K Series	478-5425	3926	600	63.5	3662	Stepped	7
130	Advansys	505-9454	3926	600	63.5	3662	Stepped	7
130	K Series	257-3695*	3926	600	63.5	3662	Stepped	7
130	Advansys	522-2033	3926	600	63.5	3662	Stepped	7
130	K Series	283-1794*	3940	760.8	63.5	3780	Stepped	7
130	K Series	479-0533	3940	760.8	63.5	3780	Stepped	7
130	Advansys	538-2273	3940	760.8	63.5	3780	Stepped	7
130	K Series	478-5420	3980	785	63.5	3806	Stepped	8
130	K Series	478-5420	3980	785	63.5	3806	Stepped	8
130	Advansys	528-2886	3980	785	63.5	3806	Stepped	8
130	Advansys	528-2885	3980	785	63.5	3806	Stepped	8
130	Advansys	538-9161	3980	705	50.8	3830	Stepped	8
130	K Series	456-1314	3984	423	50	3826	Straight	8

Discontinued
Canceled
(Reference)

Part is discontinued. Please contact your service representative.
Part is canceled. Please contact your customer service representative.
Part number is not serviceable. For reference only.

Cat Wheel Loaders

BASE EDGE TABLE

Base Edge Assembly Dimensional Reference

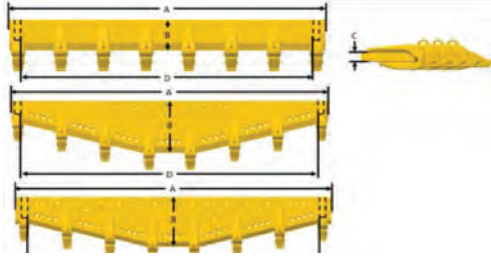
Adapter Size Class	Adapter Series	Part Number					Edge Style	Adapter Quantity Welded on Edge
			A	B	C	D		
130	K Series	479-0548	3984	423	50	3826	Straight	8
130	K Series	351-7879	4020	804	63.5	3846	Spade	8
130	K Series	478-5413	4020	804	63.5	3846	Spade	8
130	Advansys	388-6330	4020	804	63.5	3846	Spade	8
130	K Series	373-7451	4020	785	50.8	3846	Spade	8
130	K Series	(479-0545)	4020	785	50.8	3846	Spade	8
130	K Series	478-5421	4020	785	50.8	3846	Spade	8
130	K Series	478-5421	4020	785	50.8	3846	Spade	8
130	Advansys	457-1941	4020	785	50.8	3846	Spade	8
130	K Series	275-6048*	4020	708	63.5	3827	Stepped	6
130	K Series	(294-8921)	4020	785	50.8	3846	Stepped	8
130	K Series	(479-0549)	4020	785	50.8	3846	Stepped	8
130	Advansys	538-8048	4020	785	50.8	3846	Stepped	8
130	K Series	292-9482	4020	785	50.8	3846	Stepped	8
130	K Series	(478-5428)	4020	785	50.8	3846	Stepped	8
130	Advansys	538-8048	4020	785	50.8	3846	Stepped	8
130	K Series	462-8950	4020	804	60	3846	Spade	8
130	Advansys	550-9856	4020	804	63.5	3846	Spade	8
130	K Series	(366-1662)	4094	630	63.5	3830	Stepped	7
130	K Series	(479-0546)	4094	630	63.5	3830	Stepped	7
130	Advansys	547-3354	4094	630	63.5	3830	Stepped	7
130	K Series	361-6105	4094	630	63.5	3830	Stepped	7
130	K Series	478-5424	4094	630	63.5	3830	Stepped	7
130	K Series	(460-0651)	4200	375	50	4048.2	Straight	8
130	K Series	(479-0547)	4200	375	50	4048.2	Straight	8
130	K Series	(383-0093)	4450	801	63.5	4284	Spade	8
130	K Series	(479-0532)	4450	801	63.5	4284	Spade	8
130	K Series	373-7544	4450	801	63.5	4284	Spade	8
130	Advansys	460-7180	4450	801	63.5	4284	Spade	8
130	K Series	(283-1755)	4450	901	63.5	4284	Spade	8
130	K Series	(479-0537)	4450	901	63.5	4284	Spade	8
130	K Series	325-6642	4450	441	63.5	4298	Straight	8
130	K Series	(479-0542)	4450	441	63.5	4298	Straight	8
130	K Series	267-3683*	4450	379	63.5	4284	Straight	8
130	K Series	373-7544	4450	801	63.5	4284	Spade	8
130	K Series	303-3324*	4450	801	63.5	4284	Spade	8
130	K Series	255-3762*	4450	801	63.5	4286	Spade	8
130	Advansys	568-6944	4490	441	65	4298	Straight	8
130	K Series	294-8978	4500	405	65	4312	Straight	8
130	K Series	478-5414	4500	405	65	4312	Straight	8
130	Advansys	506-6654	4500	405	65	4312	Straight	8
130	K Series	257-8857*	4597.4	921	63.5	4394	Spade	8
130	K Series	398-9170*	4610	881	63.5	4446	Spade	8
130	K Series	478-2731	4610	881	63.5	4446	Spade	8
130	Advansys	506-6651	4610	881	63.5	4446	Spade	8
130	K Series	373-7578	4610	881	63.5	4446	Spade	8
130	K Series	478-5418	4610	881	63.5	4446	Spade	8
130	Advansys	506-6650	4610	881	63.5	4446	Spade	8
130	K Series	478-5415	4610	881	63.5	4446	Spade	8
130	K Series	478-5415	4610	881	63.5	4446	Spade	8
130	Advansys	519-8497	4610	881	63.5	4446	Spade	8
130	K Series	479-0536	4610	838	63.5	4446	Spade	8
130	K Series	479-0536	4610	838	63.5	4446	Spade	8
130	K Series	288-8216*	4610	931	63.5	4446	Spade	8
130	K Series	479-0543	4610	931	63.5	4446	Spade	8
130	K Series	257-8859*	4750	921	63.5	4594	Spade	8

Cat Wheel Loaders

BASE EDGE TABLE

Base Edge Assembly Dimensional Reference

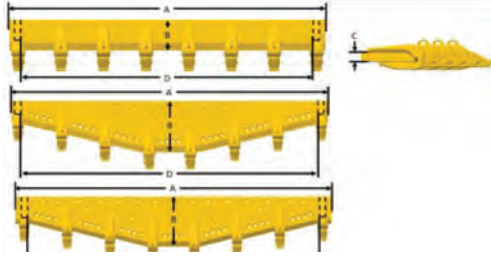
Adapter Size Class	Adapter Series	Part Number					Edge Style	Adapter Quantity Welded on Edge
			A	B	C	D		
130	Advansys	550-6188	4750	921	63.5	4594	Spade	8
130	K Series	257-1836*	4750	835	63.5	4548	Spade	8
130	Advansys	550-6187	4750	835	63.5	4548	Spade	8
130	K Series	275-2477*	4800	541	63.5	4578	Straight	8
130	K Series	294-8827*	4824	826	63.5	4620	Spade	12
130	K Series	479-0539	4824	826	63.5	4620	Spade	12
130	K Series	269-3509*	4824	826	63.5	4620	Spade	15
130	K Series	(479-0535)	4824	826	63.5	4620	Spade	15
130	K Series	269-3588*	4824	826	63.5	4612	Spade	8
130	K Series	479-0541	4824	826	63.5	4612	Spade	8
130	K Series	314-3109*	4824	826	63.5	4622	Spade	8
130	K Series	278-8173*	6200	700	63.5	5994	Straight	10
130	K Series	(479-0540)	6200	700	63.5	5994	Straight	10
150	K Series	474-4177*	1422	457	70	1156	Straight	5
150	K Series	297-5966*	2109.8	590	70	1870	Stepped	4
150	Advansys	569-4915	2109.8	590	70	1870	Stepped	4
150	K Series	324-5292*	2109.8	450	70	1851.2	Straight	5
150	Advansys	568-8846	2109.8	450	70	1851.2	Straight	5
150	K Series	311-1814*	2109.8	450	70	1851.2	Straight	5
150	Advansys	568-8843	2109.8	450	70	1851.2	Straight	5
150	K Series	257-1816*	2625	600	80	2396	Stepped	5
150	Advansys	553-4140	3156	556.6	65	3004	Stepped	6
150	Advansys	553-4143	3256	572.7	65	3104	Stepped	6
150	Advansys	553-4146	3456	586.1	65	3304	Stepped	6
150	Advansys	555-7574	3570	556	65	3399	Stepped	7
150	K Series	326-4266	3590.6	595.4	75	3387.2	Stepped	9
150	K Series	(517-4481)	3860	399	63.5	3680	Straight	8
150	K Series	343-2200	3900	399	70	3682	Straight	8
150	Advansys	550-8878	3900	399	70	3682	Straight	8
150	Advansys	510-1391	3900	399	70	3682	Straight	8
150	K Series	542-2271	3900	454	70	3682	Straight	8
150	K Series	(340-5105)	3922.2	595.4	75	3718.8	Stepped	9
150	K Series	288-8333	4450	801	63.5	4284.6	Spade	8
150	K Series	481-5035	4450	801	63.5	4284.6	Spade	8
150	Advansys	550-6190	4450	801	63.5	4284.6	Spade	8
150	K Series	335-7137*	4450	801	63.5	4284.6	Spade	8
150	K Series	303-3229*	4500	500	70	4313	Straight	8
150	K Series	420-2056	4574	738	70	4310	Stepped	7
150	K Series	479-1959	4574	738	70	4310	Stepped	7
150	Advansys	506-6652	4574	738	70	4310	Stepped	7
150	K Series	255-3765	4574	738	70	4310	Stepped	7
150	K Series	489-0462	4574	738	70	4310	Stepped	7
150	Advansys	550-8876	4574	738	70	4310	Stepped	7
150	K Series	319-4043	4574	738	70	4310	Stepped	7
150	K Series	481-5044	4574	738	70	4310	Stepped	7
150	Advansys	540-3530	4574	738	70	4310	Stepped	7
150	K Series	251-7776*	4574	738	70	4310	Stepped	7
150	Advansys	528-2865	4574	738	70	4310	Stepped	7
150	K Series	373-7546*	4574	738	70	4310	Stepped	7
150	Advansys	522-2051	4574	738	70	4310	Stepped	7
150	K Series	278-8183*	4574	847	70	4310	Stepped	7
150	Advansys	516-8736	4574	738	70	4310	Stepped	7
150	Advansys	528-2864	4574	738	70	4310	Stepped	7
150	K Series	453-5718	4610	881	63.5	4446	Spade	8
150	K Series	479-1951	4610	881	63.5	4446	Spade	8

Cat Wheel Loaders

BASE EDGE TABLE

Base Edge Assembly Dimensional Reference

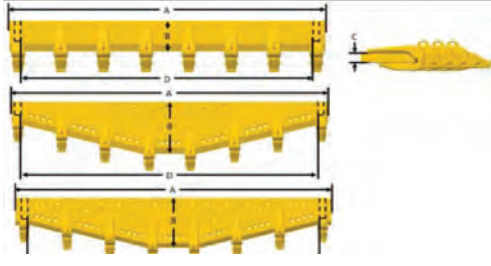
Adapter Size Class	Adapter Series	Part Number					Edge Style	Adapter Quantity Welded on Edge
			A	B	C	D		
150	Advansys	506-6653	4610	881	63.5	4446	Spade	8
150	K Series	462-8969	4610	881	63.5	4446	Spade	8
150	K Series	481-5034	4610	881	63.5	4446	Spade	8
150	Advansys	557-7962	4610	881	63.5	4446	Spade	8
150	K Series	310-8893*	4630	881	63.5	4460	Spade	8
150	K Series	257-8870*	4750	921	70	4568	Spade	8
150	Advansys	547-3342	4750	921	70	4568	Spade	8
150	K Series	479-1948	4824	826	70	4622	Spade	8
150	K Series	479-1948	4824	826	70	4622	Spade	8
150	Advansys	519-8490	4824	826	70	4622	Spade	8
150	K Series	481-5031	4824	826	70	4622	Spade	8
150	K Series	481-5031	4824	826	70	4622	Spade	8
150	Advansys	462-8932	4824	826	70	4622	Spade	8
150	K Series	356-6244	4824	900	70	4622	Spade	8
150	K Series	481-5027	4824	900	70	4622	Spade	8
150	K Series	294-9013*	4824	889	70	4622	Spade	8
150	K Series	481-5029	4824	889	70	4622	Spade	8
150	Advansys	550-8890	4824	889	70	4622	Spade	8
150	K Series	359-0317	4824	826	70	4622	Spade	8
150	Advansys	547-3343	4824	826	70	4622	Spade	8
150	K Series	479-1949	4824	826	70	4622	Spade	8
150	K Series	479-1949	4824	826	70	4622	Spade	8
150	Advansys	491-9809	4824	826	70	4622	Spade	8
150	K Series	479-1950	4824	889	70	4622	Spade	8
150	K Series	479-1950	4824	889	70	4622	Spade	8
150	K Series	(481-5048)	4824	560	76.2	4620	Straight	8
150	K Series	(481-5048)	4824	560	76.2	4620	Straight	8
150	K Series	(356-6239)	4824	560	76.2	4620	Straight	15
150	K Series	(481-5046)	4824	560	76.2	4620	Straight	15
150	K Series	283-1779*	4824	921	70	4622	Spade	8
150	K Series	264-2207*	4840	826	70	4620	Stepped	8
150	K Series	479-1954	4840	740	76.2	4620	Stepped	8
150	K Series	479-1954	4840	740	76.2	4620	Stepped	8
150	Advansys	496-3020	4840	740	76.2	4620	Stepped	8
150	K Series	479-1952	4840	740	76.2	4620	Stepped	8
150	K Series	479-1952	4840	740	76.2	4620	Stepped	8
150	Advansys	491-9813	4840	740	76.2	4620	Stepped	8
150	K Series	250-7577*	4840	814	70	4620	Stepped	8
150	Advansys	550-6186	4840	814	70	4620	Stepped	8
150	K Series	479-1953	4840	740	70	4620	Stepped	8
150	K Series	479-1953	4840	740	70	4620	Stepped	8
150	Advansys	547-3345	4840	740	70	4620	Stepped	8
150	K Series	479-1958	4840	740	76.2	4620	Stepped	8
150	K Series	479-1958	4840	740	76.2	4620	Stepped	8
150	Advansys	496-3016	4840	740	76.2	4620	Stepped	8
150	K Series	314-6384	4840	740	70	4620	Stepped	8
150	Advansys	543-0327	4840	740	70	4620	Stepped	8
150	K Series	278-8205	4840	880	70	4620	Stepped	9
150	Advansys	513-2311	4840	880	70	4620	Stepped	9
150	K Series	310-9112*	4840	740	70	4620	Stepped	8
150	K Series	283-1056*	4840	888	70	4620	Stepped	8
150	K Series	265-8216*	4840	880	70	4620	Stepped	9
150	K Series	275-9586*	4840	790	70	4620	Stepped	8
150	K Series	283-1823*	4840	905	70	4620	Stepped	9
150	Advansys	513-2312	4840	880	70	4620	Spade	9
150	Advansys	528-2866	4840	826	70	4614	Stepped	8

Cat Wheel Loaders

BASE EDGE TABLE

Base Edge Assembly Dimensional Reference

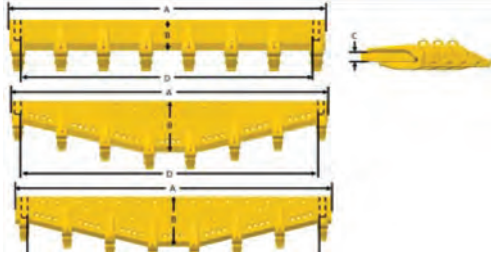
Adapter Size Class	Adapter Series	Part Number					Edge Style	Adapter Quantity Welded on Edge
			A	B	C	D		
150	Advansys	545-8956	4840	880	70	4620	Stepped	9
150	K Series	321-6018*	4900	450	63.5	4612	Straight	9
150	K Series	(319-4071)	4973	650	70	4780	Straight	8
150	K Series	481-5030	4973	650	70	4780	Straight	8
150	Advansys	522-2039	5010	738	70	4700	Stepped	7
150	Advansys	522-2026	5010	738	70	4700	Stepped	7
150	K Series	(417-4202)	5080	550	70	4899.2	Straight	8
150	K Series	(481-5024)	5080	550	70	4899.2	Straight	8
150	K Series	323-0117*	5080	650	70	4900	Straight	8
150	K Series	(481-5032)	5080	650	70	4900	Straight	8
150	K Series	278-8133*	5080	779.8	70	4800	Stepped	8
150	K Series	271-8350*	5080	848.8	70	4800	Stepped	8
150	K Series	265-8238*	5273.5	823	70	5072	Spade	9
150	K Series	(481-5028)	5273.5	823	70	5072	Spade	9
150	K Series	346-9241	5384	900	70	5184	Spade	12
150	K Series	481-5025	5384	900	70	5184	Spade	12
150	K Series	288-8365	5452	793.8	70	5250	Spade	9
150	K Series	(481-5026)	5452	793.8	70	5250	Spade	9
150	K Series	(389-1552)	6270	560	76.2	5994	Straight	10
150	K Series	(481-5047)	6270	560	76.2	5994	Straight	10
170	Advansys	539-5612	2450	530.4	90	-	Stepped	3
170	K Series	438-5841*	2630	775	80	2394	Spade	5
170	K Series	343-2180	4500	500	76	4312	Straight	8
170	Advansys	550-8888	4500	500	76	4312	Straight	8
170	K Series	512-1172	4824	826	76.2	4628	Spade	8
170	K Series	343-2227	4824	889	76.2	4624	Spade	8
170	K Series	506-0102	4824	889	76.2	4624	Spade	8
170	Advansys	491-9811	4824	889	76.2	4624	Spade	8
170	K Series	343-2229	4824	826	76.2	4624	Spade	8
170	K Series	506-0103	4824	826	76.2	4624	Spade	8
170	Advansys	484-6622	4824	826	76.2	4624	Spade	8
170	K Series	247-7232	4824	826	70	4622	Spade	8
170	Advansys	511-5194	4824	830	76.2	4624.8	Spade	8
170	K Series	247-7241	4824	826	76.2	4624.8	Spade	8
170	Advansys	523-9781	4824	826	76.2	4624.8	Spade	8
170	K Series	294-8882	4824	826	76.2	4624.8	Spade	8
170	Advansys	550-8880	4824	826	76.2	4624.8	Spade	8
170	K Series	310-8977*	4824	889	76.2	4624	Spade	8
170	K Series	333-0909*	4824	878	76.2	4624.8	Spade	8
170	K Series	(378-8779)	4824	826	76.2	4624.8	Spade	8
170	Advansys	543-4782	4824	826	76.2	4624.8	Spade	8
170	K Series	(440-0249)	4824	889	90	4624	Spade	8
170	Advansys	535-8257	4824	830	76.2	4624.8	Spade	8
170	Advansys	556-7870	4840	820	90	4620	Stepped	8
170	K Series	(453-5513)	4902.2	780.1	90	4648	Stepped	9
170	K Series	377-1702	5080	908.2	90	4800	Spade	8
170	K Series	479-1971	5080	908.2	90	4800	Spade	8
170	K Series	3-2256, 395-18	5080	908.2	90	4800	Spade	8
170	K Series	479-1968	5080	908.2	90	4800	Spade	8
170	Advansys	457-4811	5080	908.2	90	4800	Spade	8
170	K Series	479-1970	5080	780.1	90	4800	Stepped	8
170	K Series	479-1970	5080	780.1	90	4800	Stepped	8
170	Advansys	498-1746	5080	780.1	90	4800	Stepped	8
170	K Series	479-1972	5080	908.2	90	4800	Spade	8
170	K Series	479-1972	5080	908.2	90	4800	Spade	8

Cat Wheel Loaders

BASE EDGE TABLE

Base Edge Assembly Dimensional Reference

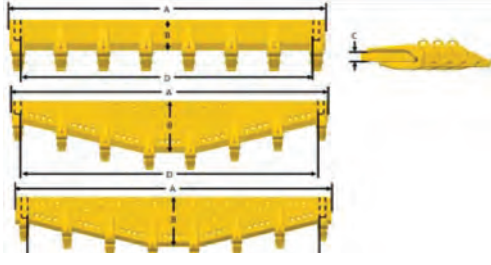
Adapter Size Class	Adapter Series	Part Number					Edge Style	Adapter Quantity Welded on Edge
			A	B	C	D		
170	Advansys	498-1753	5080	908.2	90	4800	Spade	8
170	K Series	479-1982	5080	848.8	90	4800	Stepped	8
170	K Series	479-1982	5080	848.8	90	4800	Stepped	8
170	Advansys	502-0491	5080	848.8	90	4800	Stepped	8
170	K Series	479-1978	5080	848.8	90	4800	Stepped	8
170	K Series	479-1978	5080	848.8	90	4800	Stepped	8
170	Advansys	502-0505	5080	848.8	90	4800	Stepped	8
170	K Series	479-1983	5080	779.8	90	4800	Stepped	8
170	K Series	479-1983	5080	779.8	90	4800	Stepped	8
170	Advansys	502-0501	5080	779.8	90	4800	Stepped	8
170	K Series	303-3248*	5080	779.8	90	4800	Stepped	8
170	K Series	303-3246*	5080	848.8	90	4800	Stepped	8
170	Advansys	518-4590	5080	848.8	90	4800	Stepped	8
170	Advansys	523-9801	5080	908.6	90	4800	Spade	8
170	K Series	(242-8452)	5080	880	76	4800	Stepped	9
170	K Series	271-8340*	5080	908.2	76.2	4800	Spade	8
170	Advansys	543-4785	5080	908.2	76.2	4800	Spade	8
170	K Series	278-8123*	5080	780.1	76.2	4800	Stepped	8
170	K Series	303-3245*	5080	908.2	90	4800	Spade	8
170	Advansys	550-6192	5080	908.2	90	4800	Spade	8
170	K Series	(324-1711)	5080	908.2	90	4800	Spade	8
170	K Series	343-2207*	5080	780.1	90	4800	Stepped	8
170	Advansys	539-5609	5080	908.2	90	4800	Spade	8
170	K Series	518-4588	5105	1016	76.2	4860	Spade	8
170	K Series	329-1296	5275	882.3	90	5050	Stepped	8
170	K Series	(361-6202)	5634	700	90	5328	Straight	9
170	K Series	335-7166	5750	909.8	90	5466	Stepped	9
170	K Series	(329-1546)	5800	994	90	5498	Spade	8
170	K Series	479-1967	5800	994	90	5498	Spade	8
170	K Series	294-4346*	5800	994	76.2	5498	Spade	8
170	K Series	(329-1596)	5800	994	76.2	5498	Spade	8
170	K Series	(369-2032)	5800	994	76.2	5498	Spade	8
170	K Series	455-3464	6300	500	90	5994	Straight	10
170	K Series	479-1973	6300	500	90	5994	Straight	10
170	Advansys	502-0495	6300	500	90	5994	Straight	10
170	K Series	319-4137*	6300	700	90	5994	Straight	10
170	Advansys	522-2042	6406	1000	90	6216	Stepped	9
170	Advansys	522-2045	6406	1000	90	6216	Stepped	9
170	Advansys	524-8282	6458	1092.8	90	6178	Spade	10
170	K Series	(324-1619)	7460	700	90	7180	Straight	12
200	Advansys	563-0189	6220	1000	101.6	5952	Stepped	9
200	Advansys	566-9352	6400	1245	720	6112	Stepped	9
J800/200	J Series	200-8805*	1380	605	100	1100	Stepped	3
J800/200	J Series	329-3946*	2330	600	100	2016	Stepped	4
J800/200	J Series	226-2408*	2360	464	100	2170	Straight	5
J800/200	J Series	227-4040*	2360	684	100	2170	Stepped	5
J800/200	J Series	222-7591*	2612	615	100	2344	Stepped	5
J800/200	J Series	330-6505*	2936	700	100	2622	Stepped	5
J800/200	J Series	124-8776*	2952	600	101.6	-	Stepped	5
J800/200	J Series	360-5711	3332	635	100	3017.6	Straight	6
J800/200	J Series	345-6955*	3332	635	100	0	Straight	4
J800/200	J Series	322-5039*	3370	875	100	3070	Stepped	6
J800/200	Advansys	548-9459	4890	1000	101.6	4622.2	Stepped	7
J800/200	J Series	(264-2860)	4920	520	101.6	4620	Straight	7
J800/200	Advansys	518-4592	5162.1	1000	101.6	4794.4	Stepped	7

Cat Wheel Loaders

BASE EDGE TABLE

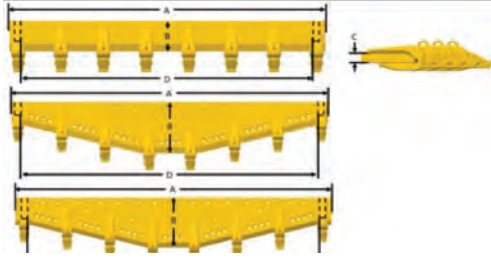
Base Edge Assembly Dimensional Reference								
Adapter Size Class	Adapter Series	Part Number					Edge Style	Adapter Quantity Welded on Edge
			A	B	C	D		
J800/200	Advansys	536-3324	5650	1000	101.6	5922	Stepped	8
J800/200	J Series	121-2104	5650	1000	101.6	5922	Stepped	8
J800/200	Advansys	540-3528	5650	1000	101.6	5922	Stepped	8
J800/200	J Series	(275-9574)	5650	1000	100	5382	Stepped	8
J800/200	J Series	346-9135*	6220	1000	101.6	5952	Stepped	9
J800/200	Advansys	518-4589	6220	1000	101.6	5952	Stepped	9
J800/200	J Series	121-6659	6220	1000	101.6	5952	Stepped	9
J800/200	Advansys	419-7394	6220	1000	101.6	5952	Stepped	9
J800/200	J Series	101-5856*	6220	825.9	101.6	5952.4	Stepped	9
J800/200	J Series	373-7538	6220	537	101.6	5952	Straight	9
J800/200	Advansys	556-7881	6220	829.9	101.6	5952	Stepped	9
J800/200	J Series	(219-0483)	6400	1069.7	100	6132	Stepped	9
J800/200	J Series	177-9481*	6400	1000	101.6	6132	Stepped	9
J800/200	J Series	117-6800*	-	-	-	-	-	9
220	Advansys	520-7391	5650	1050	101.6	5335	Stepped	8
220	Advansys	535-8304	5650	1125	100	5343	Stepped	8
220	Advansys	539-5607	5650	1050	100	5382	Stepped	8
220	Advansys	528-2871	6220	1000	101.6	5952	Stepped	9
220	Advansys	563-0185	6220	1000	101.6	5952	Stepped	9
220	Advansys	515-3277	6240	1125	101.6	5918	Stepped	9
220	Advansys	515-3275	6240	1125	100	5918	Stepped	9
220	Advansys	419-0131	6240	1125	100	5918	Stepped	9
220	Advansys	487-0638	6240	1125	101.6	5918	Stepped	9
220	Advansys	566-9374	6400	1245	100	6112	Stepped	9
220	Advansys	515-3279	6964	619	100	6660	Straight	10
220	Advansys	528-5084	7708	619	100	7414	Straight	9
230	Advansys	566-9368	5650	1134	120	5386	Stepped	8
230	Advansys	538-8033	6240	1125	120	6016	Stepped	9
230	Advansys	565-5544	6240	1125	120	5960	Stepped	9

Cat Wheel Loaders

PART NUMBER REFERENCE TABLE

Base Edge Part Number Reference			
Adapter Size	K Base Edge As	Advansys Edge As	Adapter Qty
80	485-2497	-	5
80	258-6901	-	8
80	456-2294	561-2653	4
80	257-1826*	-	8
80	(355-0093)	-	8
80	492-3712	(558-7857)	3
80	482-2658	561-2647	3
80	482-2676	-	4
80	456-0421	558-7859	4
80	264-1914	-	8
80	478-1476	-	3
80	(485-1784)	-	2
80	463-0681	(558-7856)	3
80	463-2081	561-2648	3
80	489-0590	-	5
80	(316-7906)	-	8
80	498-4838	-	8
80	457-1968	-	5
80	469-3248	561-2651	5
80	485-7019	573-8153	8
80	442-6133	561-2650	5
80	456-0430	558-7858	3
80	469-1253	561-2652	5
80	(355-0092)	548-6933	8
80	257-1749*	-	8
80	(257-1747)	-	8
80	(257-1748)	-	8
80	(257-1766)	-	8
80	543-2957	-	4
80	276-1635*	-	8
80	276-1636*	-	8
90	257-1828*	-	8
90	279-8174*	-	8
90	273-3765	559-1173	8
90	257-1825*	-	8
90	238-9684*	-	8
90	257-1827*	-	8
90	(365-7459)	-	7
90	(367-4145)	-	7
90	395-0689	-	8
90	516-9272	-	8
90	512-0561	-	8
90	(505-6193)	-	8
90	506-2974	-	3
90	375-3145	553-7430	8

Cat Wheel Loaders

PART NUMBER REFERENCE TABLE

Base Edge Part Number Reference			
Adapter Size	K Base Edge As	Advansys Edge As	Adapter Qty
90	316-7923*	-	8
90	463-3410	-	5
90	258-8638*	-	8
90	463-3409	-	4
90	(355-0022)	557-9613	8
90	(371-3969)	-	8
90	(309-1457)	-	8
90	479-7329	-	8
90	475-3563	-	3
90	472-2266	-	8
90	256-4723	559-1174	8
90	463-3413	-	6
90	463-3412	-	5
90	483-7992	-	6
90	463-3411	576-8178	5
90	(355-0023)	-	8
90	393-9390	-	8
90	253-0092*	-	8
90	(253-0091)	-	8
90	(233-7151)	-	8
90	(466-7091)	-	8
90	(257-1775)	-	8
90	(257-1750)	-	8
90	(229-6942)	-	8
90	545-5823	-	8
90	279-8743*	-	8
90	257-1751*	-	8
90	-	553-4122	5
90	-	553-4125	5
90	-	553-4149	6
90	-	555-7559	5
90	-	549-4682	8
100	261-8714	563-0181	8
100	261-8715	525-1134	8
100	304-8216	-	8
100	257-1824*	-	8
100	492-4199	-	8
100	270-4122	570-3830	8
100	453-4986	-	8
100	277-1830*	-	8
100	359-0002	-	8
100	(345-9778)	-	10
100	(356-4595)	-	8
100	(456-5269)	-	8
100	487-7422	-	8

Base Edge Part Number Reference

Adapter Size	K Base Edge As	Advansys Edge As	Adapter Qty
100	261-8713	-	8
100	(456-5362)	-	8
100	(356-4596)	-	8
100	481-1635	-	8
100	(257-1770)	-	8
100	525-2224	-	8
100	513-6714	-	8
110	285-3342*	-	5
110	289-0771	-	6
110	273-3951*	-	7
110	353-0052*	-	8
110	-	-	6
110	464-7258	-	6
110	363-1581*	-	7
110	343-8971*	-	7
110	312-0190*	-	7
110	-	558-6720	8
110	370-1805	-	8
110	260-1384	-	6
110	-	-	8
110	-	547-5079	8
110	272-1407	-	6
110	-	-	8
110	476-5458	-	8
110	476-5455	-	8
110	294-8794*	-	8
110	-	563-0182	8
110	476-5459	538-2272	8
110	292-9453*	(563-0183)	8
110	434-2922	-	8
110	-	-	8
110	-	-	8
110	-	-	8
110	-	-	8
110	468-4927	-	8
110	366-1577	-	8
110	246-2746	538-8049	8
110	476-2217	538-8047	8
110	236-4693*	-	8
110	394-0351	525-1135	8
110	-	518-8721	8
110	-	553-4128	6
110	-	553-4131	6
110	-	555-7562	5
110	-	563-0184	8

Cat Wheel Loaders

PART NUMBER REFERENCE TABLE

Base Edge Part Number Reference			
Adapter Size	K Base Edge As	Advansys Edge As	Adapter Qty
110	-	568-8852	6
110	-	568-8856	6
110	-	573-9465	6
130	(383-0093)	-	8
130	373-7544	460-7180	8
130	351-7879	388-6330	8
130	398-9170*	506-6651	8
130	(283-1755)	-	8
130	373-7578	506-6650	8
130	294-8827*	-	12
130	366-1611	-	8
130	-	550-6188	8
130	-	550-6187	8
130	-	536-7936	7
130	269-3509*	-	15
130	-	-	8
130	478-5415	519-8497	8
130	373-7451	-	8
130	-	550-6191	7
130	-	545-8959	8
130	478-5421	457-1941	8
130	446-1961	528-5072	8
130	-	545-8955	8
130	-	550-8886	7
130	(366-1662)	547-3354	7
130	478-5423	-	7
130	-	550-8877	7
130	478-5425	505-9454	7
130	361-6105	-	7
130	-	-	6
130	479-0536	-	8
130	288-8216*	-	8
130	269-3588*	-	8
130	335-7230*	-	7
130	278-8173*	-	10
130	294-8978	506-6654	8
130	358-8089	-	6
130	319-4034*	-	7
130	283-1794*	538-2273	7
130	478-5417	505-9462	7
130	325-6642	-	8
130	479-0538	-	8
130	478-5420	528-2886	8
130	314-6409	550-8884	8
130	448-9552*	-	8

Base Edge Part Number Reference

Adapter Size	K Base Edge As	Advansys Edge As	Adapter Qty
130	(294-8921)	538-8048	8
130	(460-0651)	-	8
130	456-1314	-	8
130	292-9482	538-8048	8
130	-	(550-8879)	7
130	-	-	8
130	462-8950	-	8
130	(340-8914)*	(550-6189)	6
130	267-3683*	-	8
130	373-7544	-	8
130	314-3109*	-	8
130	303-3324*	-	8
130	288-8349*	-	8
130	464-7292	-	6
130	273-0102	550-8889	7
130	(296-4316)	-	7
130	(340-8914)*	-	6
130	257-3695*	522-2033	7
130	-	528-5076	8
130	-	528-2885	8
130	-	538-9161	8
130	-	540-3529	6
130	255-3762*	-	8
130	-	552-3311	6
130	-	553-4134	6
130	-	553-4137	6
130	-	552-9409	6
130	-	555-7565	6
130	-	555-7568	6
130	-	555-7571	6
130	-	550-9856	8
130	-	568-6944	8
130	-	574-3471	5
130	-	573-9483	8
150	479-1948	519-8490	8
150	-	547-3342	8
150	-	-	5
150	481-5031	462-8932	8
150	356-6244	-	8
150	(319-4071)	-	8
150	294-9013*	550-8890	8
150	(417-4202)	-	8
150	265-8238*	-	9
150	288-8365	-	9
150	-	547-3343	8

Cat Wheel Loaders

PART NUMBER REFERENCE TABLE

Base Edge Part Number Reference			
Adapter Size	K Base Edge As	Advansys Edge As	Adapter Qty
150	346-9241	-	12
150	479-1949	491-9809	8
150	479-1950	-	8
150	323-0117*	-	8
150	-	-	8
150	-	-	8
150	453-5718	506-6653	8
150	462-8969	-	8
150	288-8333	550-6190	8
150	297-5966*	569-4915	4
150	-	568-8846	5
150	-	568-8843	5
150	420-2056	506-6652	7
150	479-1954	496-3020	8
150	479-1952	491-9813	8
150	-	550-6186	8
150	479-1953	547-3345	8
150	255-3765	550-8876	7
150	319-4043	540-3530	7
150	-	528-2865	7
150	479-1958	496-3016	8
150	(481-5048)	-	8
150	(389-1552)	-	10
150	(356-6239)	-	15
150	-	-	9
150	343-2200	550-8878	8
150	283-1779*	-	8
150	-	-	8
150	310-8893*	-	8
150	373-7546*	522-2051	7
150	314-6384	543-0327	8
150	278-8205	513-2311	9
150	310-9112*	-	8
150	278-8133*	-	8
150	-	-	8
150	265-8216*	-	9
150	278-8183*	-	7
150	271-8350*	-	8
150	275-9586*	-	8
150	303-3229*	-	8
150	257-1816*	-	5
150	283-1823*	-	9
150	(340-5105)	-	9
150	326-4266	-	9
150	-	522-2039	7
150	-	513-2312	9

Base Edge Part Number Reference

Adapter Size	K Base Edge As	Advansys Edge As	Adapter Qty
150	-	510-1391	8
150	-	522-2026	7
150	-	516-8736	7
150	-	528-2864	7
150	-	528-2866	8
150	-	545-8956	9
150	-	-	8
150	-	553-4140	6
150	-	553-4143	6
150	-	553-4146	6
150	-	555-7574	7
150	-	557-7962	8
170	455-3464	502-0495	10
170	377-1702	-	8
170	479-1968, (395-1831)	457-4811	8
170	479-1970	498-1746	8
170	479-1972	498-1753	8
170	(329-1546)	-	8
170	-	-	8
170	-	-	8
170	343-2227	491-9811	8
170	343-2229	484-6622	8
170	-	-	5
170	247-7232	-	8
170	479-1982	502-0491	8
170	479-1978	502-0505	8
170	479-1983	502-0501	8
170	303-3248*	-	8
170	303-3246*	-	8
170	335-7166	-	9
170	329-1296	-	8
170	-	522-2042	9
170	-	511-5194	8
170	-	522-2045	9
170	-	518-4590	8
170	247-7241	523-9781	8
170	-	523-9801	8
170	-	524-8282	10
170	(242-8452)	-	9
170	271-8340*	543-4785	8
170	278-8123*	-	8
170	294-4346*	-	8
170	294-8882	550-8880	8
170	310-8977*	-	8
170	(329-1596)	-	8

Cat Wheel Loaders

PART NUMBER REFERENCE TABLE

Base Edge Part Number Reference			
Adapter Size	K Base Edge As	Advansys Edge As	Adapter Qty
170	333-0909*	-	8
170	343-2180	550-8888	8
170	(369-2032)	-	8
170	(378-8779)	543-4782	8
170	303-3245*	550-6192	8
170	(324-1711)	-	8
170	319-4137*	-	10
170	343-2207*	-	8
170	(361-6202)	-	9
170	(440-0249)	-	8
170	(453-5513)	-	9
170	(324-1619)	-	12
170	-	535-8257	8
170	-	556-7870	8
170	-	539-5609	8
170	-	539-5612	3
J800/200	-	518-4592	7
J800/200	346-9135*	518-4589	9
J800/200	121-6659	419-7394	9
J800/200	-	536-3324	8
J800/200	121-2104	540-3528	8
J800/200	330-6505*	-	5
J800/200	(264-2860)	-	7
J800/200	322-5039*	-	6
J800/200	117-6800*	-	9
J800/200	226-2408*	-	5
J800/200	(219-0483)	-	9
J800/200	101-5856*	-	9
J800/200	373-7538	-	9
J800/200	(275-9574)	-	8
J800/200	177-9481*	-	9
J800/200	200-8805*	-	3
J800/200	360-5711	-	6
J800/200	222-7591*	-	5
J800/200	329-3946*	-	4
J800/200	345-6955*	-	4
J800/200	227-4040*	-	5
J800/200	124-8776*	-	5
J800/200	-	548-9459	7
J800/200	-	556-7881	9
200	-	563-0189	9
200	-	566-9352	9
220	-	515-3277	9
220	-	515-3279	10

Base Edge Part Number Reference

Adapter Size	K Base Edge As	Advansys Edge As	Adapter Qty
220	-	515-3275	9
220	-	520-7391	8
220	-	528-5084	9
220	-	535-8304	8
220	-	528-2871	9
220	-	539-5607	8
220	-	419-0131	9
220	-	487-0638	9
220	-	563-0185	9
220	-	566-9374	9
230	-	538-8033	9
230	-	565-5544	9
230	-	566-9368	8

Cat Wheel Loaders

OPTIONS

CAT ADVANSYS TIP OPTIONS

Below are the tip shapes best suited for the wide range of jobsite conditions performed by large wheel loaders. We also offer additional Cat Advansys tips more commonly used with excavators. Your Cat dealer can help you choose the one that offers the right balance of penetration and wear life for your application.

ABRASION

EXTREME ABRASION ROCK (XAR)

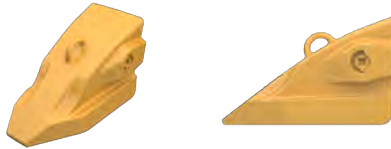

Extreme Abrasion Rock (XAR) Tip is the tip to choose for the most demanding applications. The XAR tip features a 30 degree narrower leading edge and significantly more wear material when compared to the Heavy Abrasion Tip. This leads to better penetrating, longer lasting tip. These tips are the most robust, longest lasting tip in the Cat® Advansys™ line up. The XAR tip has truly earned the title of Extreme!

HEAVY ABRASION

A.R.M. OPTION AVAILABLE



Heavy Abrasion tips feature a redesign for the Cat Advansys system that results in 11 percent more usable wear material than K Series and a tip shape that stays sharp through the life of the tip. These tips are available with Abrasion Resistant Material (A.R.M)*.

HEAVY PENETRATION



Heavy Penetration tips feature a redesign for the Cat Advansys system that results in 6 percent more usable wear material than K Series and a tip shape that stays sharp through the life of the tip in the most severe applications.

HEAVY DUTY

A.R.M. OPTION AVAILABLE



Heavy Duty and Heavy Duty A.R.M.* tips include approximately 60 percent more wear material in the tip body. The A.R.M. wears around the profile to increase penetration.

GENERAL PURPOSE



General Purpose tips are symmetrical and the baseline for other tip styles. All wear comparisons are to the General Purpose tip unless otherwise noted.

GENERAL PURPOSE



General Purpose Excavator for 110 size and down have been designed to maintain wear material and support material where it is needed, while wearing sharp for better penetration.

GENERAL PURPOSE



General Purpose Wheel Loader for 110 size and down have been designed to maintain wear material and support material where it is needed, while wearing sharp for better penetration.

COAL











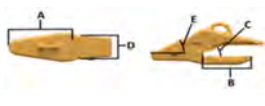

Coal tips have a reduced amount of wear material to maximize bucket payload and a smooth underside to maintain a flat floor.

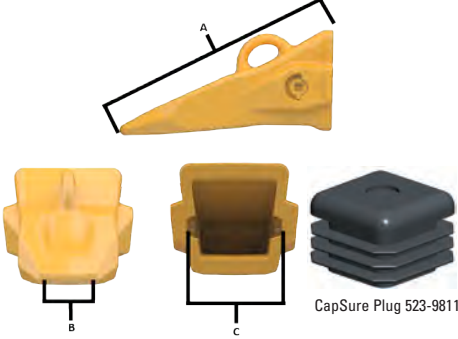
IMPACT

* Abrasion Resistant Material (A.R.M.) is a welding process that bonds very hard tungsten carbide particles to Cat G.E.T. to create a protective shield over the component. Typically, the A.R.M. process doubles wear life—and can last even longer in some applications.

Cat® Advansys™ 70 Series - Base Edge Thickness: 19-32mm

Machine Model: 924 - 938

Adapters									
Type	Part Number	Edge Thickness	*A (mm)	B (mm)	C (deg)	D (mm)	E (deg)	Weight (kg)	Notes
LDR Flushmount - CTR	539-5610	19-32	229	-	22.5	64	15	6.1	
LDR Bottom Strap - CTR	539-5611	25-32	50	191	22.5	64	15	5.4	
LDR Bolt-On - CTR	539-5600	25	236	236	22.5	94	15	9.0	
LDR Bolt-On Corner - RH	539-5601	25	-	195	22.5	87	15	13.5	
LDR Bolt-On Corner - LH	539-5602	25	-	195	22.5	87	15	13.5	
Tips									
Type	Part Number	Dimensions (mm)			Weight (kg)	Retainer and Sleeve	Notes		
		A	B	C					
	Aggregate 539-5776	229.3	41.4	71.2	4.92	Retainer: 516-9166 Sleeve: 516-9165	 <p>*Overall Width 165 mm</p>		
	General Duty 539-5678	215.9	37.6	71.2	4.09				
	Wide 539-5670	213.8	113.2	71.2	4.36				
	Penetration Plus 539-5673	228.6	49.7	71.2	4.18				
	Penetration 539-5677	217.1	13.3	71.2	3.43				
	Double Spike 539-5675	220.4	103.2	71.2	4.26				
	Heavy Abrasion 539-5771	222.4	109.7	71.2	5.28				
Specialty									
	Aggregate Long Life (ARM) 539-5777	229.8	41.2	71.2	5.03	Retainer: 516-9166 Sleeve: 516-9165	The black areas in the pictures of the tips is where the ARM will be applied.		
Hardware									
Type	Quantity				Part Number				
LH/RH Rear Bolts	2 Per Adapter				4F-4042				
LH/RH Front Bolts	2 Per Adapter				4J-9058				
LH/RH Nuts	4 Per Adapter				2J-3507				
CTR Bolts	2 Per Adapter				8J-2928				
CTR Nuts	2 Per Adapter				8J-2933				

*Note Some of the 70 Series tip options have been redesigned vs their J-Series counterparts. Some profiles have been combined to improve performance for machines in this class. The reference below illustrates the length and weight differences to help with tip selection.



Cat Advansys™ 80 Series - Base Edge Thickness: 25-38mm

Machine Model: 950

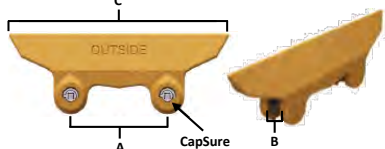
Adapters										
Type	Part Number	Edge Thickness	A (mm)	B (mm)	C (deg)	D (mm)	E (deg)	Weight (kg)	Notes	
Flushmount	505-4030	25-38	235.5	N/A	22.5	92	15	10.11		
Center Bolt-on	505-4029	32	290	290	22.5	108	15	15.1		
Center Bolt-on	505-4034	25	236.1	236.1	22.5	108	15	14.25		
RH Bolt-On	505-4032	32/25	N/A	N/A	22.5	-	15	20.53		
LH Bolt-On	505-4033	32/25	N/A	N/A	22.5	-	15	20.53		
Tips										
Type	Weight (kg)	Dimensions (mm)			Weight (kg)	Retainer and Sleeve	Notes			
		A	B	C						
	Heavy Abrasion	505-3981	284	110	91.5	9.795	Retainer: 516-9166 Sleeve: 516-9165	 *Overall Width 113.4 mm		
	Heavy Penetration	505-3980	301	49	91.5	9.837				
	Heavy Duty	505-3982	288	55	91.5	7.89				
	General Purpose	505-3984	266	49	91.5	6.744				
Specialty										
	Heavy Duty Long Life (ARM)	505-3983	288	55	91.5	8.19	Retainer: 516-9166 Sleeve: 516-9165	The black areas in the pictures of the tips is where the ARM will be applied.		
	Leveling Edge Conversion	505-3985	169	83.2	91.5	5.77				
Wear Protection										
Type	Machine	Part Number	A (mm)	B (mm)	C (mm)	Weight (kg)	Pin	Retainer	Base Plate	Notes
Straight MAWPS Sidebar Protector	980-982	498-3443	588	25	N/A	18.7	N/A	138-0006	463-1401	
Curved MAWPS Sidebar Protector		433-9831	602	25	N/A	18.3	N/A	138-0006	463-1401	
Curved MAWPS Sidebar Protector		433-9832	610	30	N/A	19.4	N/A	138-0006	463-1401	
Straight MAWPS Sidebar Protector		486-9066	512	30	N/A	15.7	N/A	138-0006	463-1401	
Straight MAWPS Sidebar Protector		486-9068	660	30	N/A	19.5	N/A	138-0006	463-1401	
Sidebar Protector Center	980-982	135-8246	238	25	466.4	10.8	135-9292	114-0359	N/A	
Sidebar Protector Center		329-5958	200	30	466.7	17.4	132-0999	132-0999	N/A	
Sidebar Protector Center		9J-9600	254	30	578.0	16.7	114-0359	114-0359	N/A	

Wear Protection Segments											
Description	Part Number	A (mm)	B (mm)	C (mm)	H (mm)	E (mm)	Number of Holes	Weight (kg)	Qty.	Nuts and Bolts	Notes
25mm Segments	4T-6694	225	280	25	155	139	2	10.8	5	Nut: 2J-3507 Bolt: 4F-4042	
	264-6233	220	280	25	155	139	2	10.2	2		
30mm Segments	140-7601	291	360	30	208	179	2	21.8	5		
	263-7545	268	360	30	208	179	2	19.9	2		
35mm Segments	132-4715	278	305	35	208	152	2	21.9	5		
	257-1726	258	305	35	208	152	2	17.5	2		

Cat Advansys™ 90 Series - Base Edge Thickness: 32-45mm

Machine Model: 966-972

Adapters									
Type	Part Number	Edge Thickness	"A (mm)	B (mm)	C (deg)	D (mm)	E (deg)	Weight (kg)	Notes
Center 2 Strap	505-4040	40	245.5	170.5	22.5	104	15	15.31	
RH 2 Strap	505-4041	40	245.5	170.5	22.5	104	15	15.32	
LH 2 Strap	505-4042	40	245.5	170.5	22.5	104	15	15.32	
Flushmount	505-4043	32-45	269.7	N/A	22.5	102	15	15.89	
Center Bolt-on	505-4044	40	298	298	22.5	130	15	19.61	
RH Bolt-on	505-4045	40/32	N/A	N/A	22.5	-	15	28.06	
LH Bolt-on	505-4046	40/32	N/A <td N/A	22.5	130	15	28.06		
Center Bolt-on	505-4047	32	285.2	285.2	22.5	122	15	22.1	

Tips										
Type		Weight (kg)	Dimensions (mm)			Weight (kg)	Retainer and Sleeve	Notes		
			A	B	C					
	Heavy Abrasion	505-3991	311	128	104	13.48	Retainer: 516-9168 Sleeve: 516-9167	 *Overall Width 113.4 mm		
	Heavy Penetration	505-3990	311	60	104	12.94				
	Heavy Duty	505-3996	307	68	104	10.23				
	General Purpose	505-3994	295	50	104	8.811				
Specialty										
	Heavy Duty Long Life (ARM)	505-3993	307	68	104	10.6	Retainer: 516-9168 Sleeve: 516-9167	The black areas in the pictures of the tips is where the ARM will be applied.		
	Leveling Edge Conversion	505-3995	182	91	104	7.23				
Wear Protection										
Type	Machine	Part Number	A (mm)	B (mm)	C (mm)	Weight (kg)	Pin	Retainer	Base Plate	Notes
Straight MAWPS Sidebar Protector	980-982	498-3443	588	25	N/A	18.7	N/A	138-0006	463-1401	
Curved MAWPS Sidebar Protector		433-9831	602	25	N/A	18.3	N/A	138-0006	463-1401	
Curved MAWPS Sidebar Protector		433-9832	610	30	N/A	19.4	N/A	138-0006	463-1401	
Straight MAWPS Sidebar Protector		486-9066	512	30	N/A	15.7	N/A	138-0006	463-1401	
Straight MAWPS Sidebar Protector		486-9068	660	30	N/A	19.5	N/A	138-0006	463-1401	
Sidebar Protector Center	980-982	135-8246	238	25	466.4	10.8	135-9292	114-0359	N/A	
Sidebar Protector Center		329-5958	200	30	466.7	17.4	132-0999	132-0999	N/A	
Sidebar Protector Center		9J-9600	254	30	578.0	16.7	114-0359	114-0359	N/A	

Wear Protection											
Half Arrows											
Part Number	Description	A (mm)	B (mm)	C (mm)	H (mm)	E (mm)	Number of Holes	Angle of Half Arrow	Weight (kg)	Notes	
313-5550	Center	290	315	30	203	98	2	0	20		
313-5548	Center	270	315	30	180	98	2	0	20		
135-9544	Center	300	400	41	120	127	2	0	35		
135-9545	Right Hand	315	400	41	200	127	2	15	39		
135-9546	Left Hand	315	400	41	200	127	2	15	39		
Top Covers											
Part Number	Description	A (mm)	B (mm)	C (mm)	H (mm)	E (mm)	K (mm)	Number of Holes	Weight (kg)	Bevel	Notes
195-7230	Center	440	360	35	85	50	89	5	35	22.5	
195-7231	Right Hand	484	360	35	85	N/A	89	5	38	22.5	
195-7232	Left Hand	484	360	35	85	N/A	89	5	38	22.5	
229-6596	Center	644	348	35	85	152	89	5	54	22.5	
Segments											
Description	Part Number	A (mm)	B (mm)	C (mm)	H (mm)	E (mm)	Number of Holes	Weight (kg)	Qty.	Nuts and Bolts	Notes
30mm Segments	100-6666	293	360	30	203	179	2	21.2	5	Nut: 3K-9770 Bolt: 5P-8823	
	308-4322	283	360	30	203	179	2	20.6	2		
30mm Segments	4T-6699	270	360	30	180	179	2	20.0	5		
	308-3054	260	360	30	180	179	2	18.9	2		
30mm Segments	4T6698	240	360	30	140	179	2	17.8	5		
	308-4323	230	360	30	140	179	2	16.6	2		
30mm Segments	196-2894*	263	360	30	180	179	2	19.1	5		
	275-7647*	240	360	30	180	179	2	17.8	2		
35mm Segments	140-6870	293	360	35	203	179	2	25.0	5		
	310-4067	273	360	35	203	179	2	24.1	2		
35mm Segments	140-6868	270	360	35	180	179	2	23.0	5		
	310-4064*	255	360	35	180	179	2	22.0	2		
40mm Segments	135-9294	300	330	40	120	164	2	29.0	1	Nut: 3K-9770 Bolt: 8T-9079	
	RH-135-9295	315	330	40	201	164	2	30.4	3		
	LH-135-9296	315	330	40	201	164	2	30.4	3		

Cat Wheel Loaders

PART NUMBERS

Cat Advansys™ 100 Series - Base Edge Thickness: 38-51mm

Machine Models: 980-982

Adapters										
Type	Part Number	Edge Thickness	A (mm)	B (mm)	C (deg)	D (mm)	E (deg)	Weight (kg)	Notes	
Center 2 Strap	505-4050	45	261	181	22.5	108	15	17.2		
RH 2 Strap	505-4153	45	262	182	22.5	108	15	17.2		
LH 2 Strap	505-4154	45	262	182	22.5	108	15	17.2		
Center 2 Strap Long Life (ARM)	505-4155	45	261	181	22.5	108	15	17.3		
RH 2 Strap Long Life (ARM)	505-4156	45	262	182	22.5	108	15	17.3		
LH 2 Strap Long Life (ARM)	505-4157	45	262	182	22.5	108	15	17.3		
Flushmount	505-4056	38-51	288	N/A	22.5	99	15	17.1		
Center Bolt-on	505-4057	45	309	309	22.5	130	15	25.2		
RH Bolt-on	505-4058	45	N/A	N/A	22.5	N/A	15	40.4		
LH Bolt-on	505-4059	45	N/A	N/A	22.5	N/A	15	40.4		
Tips										
Type	Part Number	Dimensions (mm)			Weight (kg)	Retainer and Sleeve	Notes			
	Heavy Abrasion 505-4001	A	B	C	16.4	Retainer: 516-9168 Sleeve: 516-9167	    CapSure Plug 523-9811			
	Heavy Penetration 505-4000	339	151	109	16.6					
	Heavy Duty 505-4002	357	60	109	13.2					
	General Purpose 505-4004	335	74	109	11.5					
Specialty										
	Heavy Duty Long Life (ARM) 505-4003	A	B	C	13.6	Retainer: 516-9168 Sleeve: 516-9167	The black areas in the pictures of the tips is where the ARM will be applied.			
	Leveling Edge Conversion 505-4005	189	100	109	10.0	Retainer: 516-9168 Sleeve: 516-9167				
Wear Protection										
Type	Machine	Part Number	A (mm)	B (mm)	C (mm)	Weight (kg)	Pin	Retainer	Base Plate	Notes
Straight MAWPS Sidebar Protector	980-982	498-3443	588	25	N/A	18.7	N/A	138-0006	463-1401	
Curved MAWPS Sidebar Protector		433-9831	602	25	N/A	18.3	N/A	138-0006	463-1401	
Curved MAWPS Sidebar Protector		433-9832	610	30	N/A	19.4	N/A	138-0006	463-1401	
Straight MAWPS Sidebar Protector		486-9066	512	30	N/A	15.7	N/A	138-0006	463-1401	
Straight MAWPS Sidebar Protector		486-9068	660	30	N/A	19.5	N/A	138-0006	463-1401	
Sidebar Protector Center	980-982	135-8246	238	25	466.4	10.8	135-9292	114-0359	N/A	
Sidebar Protector Center		329-5958	200	30	466.7	17.4	275-5982	132-0999	N/A	
Sidebar Protector Center		9J-9600	254	30	578.0	16.7	135-9350	114-0359	N/A	







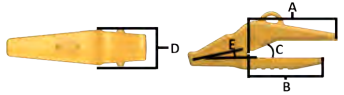

Wear Protection											
Half Arrows											
Part Number	Description	A (mm)	B (mm)	C (mm)	H (mm)	E (mm)	Number of Holes	Angle of Half Arrow	Weight (kg)	Notes	
174-4115	Center	315	315	30	185	102	2	0	21.6		
173-7447	Center	290	315	30	160	102	2	0	19.8		
116-7460	Center	312	435	45	85	140	3	0	43.8		
116-7461	Right	312	435	45	85	140	3	15	44.3		
116-7462	Left	312	435	45	85	140	3	15	44.3		
Top Covers											
Part Number	Description	A (mm)	B (mm)	C (mm)	H (mm)	E (mm)	K (mm)	Number of Holes	Weight (kg)	Bevel	Notes
286-2141	Right	323	203	12	85	86	66.5	3	5.7	22.5	
286-2142	Left	323	203	12	85	86	66.5	3	5.7	22.5	
286-2143	Center	323	203	12	85	86	66.5	3	5.7	22.5	
286-2051	Center	315	203	12	185	65	32	2	5.7	22.5	
Segments											
Description	Part Number	A (mm)	B (mm)	C (mm)	H (mm)	E (mm)	Number of Holes	Weight (kg)	Qty.	Nuts and Bolts	Notes
30mm Segments	109-9019	315	360	30	185	179	2	23.5	7	Nut: 3K-9770 Bolt: 5P-8823	
30mm Segments	4T-6700	290	360	30	160	179	2	21.5	5		
	308-4327	275	360	30	160	179	2	20.1	2		
35mm Segments	9W-5734	312	482.5	35	85	240.5	3	38.3	1	Nut: 3K-9770 Bolt: 8T-9079	
	RH - 9W-5737	323	482.5	35	85	240.5	3	38.3	3		
	LH - 9W-5730	323	482.5	35	85	240.5	3	38.3	3		
35mm ARM Segments	339-9800*	312	482.5	35	85	240.5	3	39.7	1	Nut: 3K-9770 Bolt: 6V-6535	
	RH - 138-6471	323	482.5	35	85	240.5	3	40.3	3		
	LH - 138-6472	323	482.5	35	85	240.5	3	40.3	3		
35mm ARM Segments	208-5284	312	482.5	35	85	240.5	3	39.5	1		
	RH - 138-6471	323	482.5	35	85	240.5	3	40.3	3		
	LH - 138-6472	323	482.5	35	85	240.5	3	40.3	3		
45mm Segments	107-8580	290	360	45	160	179	2	32.7	7	Nut: 3K-9770 Bolt: 5P-8823	
45mm Segments	135-8219	315	330	45	185	164	2	34.3	7		
45mm Segments	107-3490	312	482.5	45	85	240.5	3	50.4	1	Nut: 3K-9770 Bolt: 8T-9079	
	RH - 107-3491	323	482.5	45	85	240.5	3	52.2	3		
	LH - 107-3492	323	482.5	45	85	240.5	3	52.2	3		

Cat Wheel Loaders

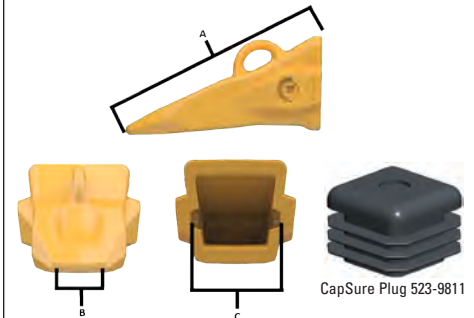
PART NUMBERS

Cat Advansys™ 110 Series - Base Edge Thickness: 45-51mm

Machine Models: 986-988

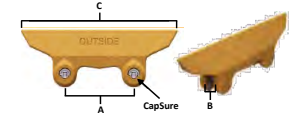
Adapters										
Type	Part Number	Edge Thickness	A (mm)	B (mm)	C (deg)	D (mm)	E (deg)	Weight (kg)	Notes	
Center 2-Strap	505-4060	51	270	150	22.5	124	15	20.7		
RH 2 Strap	505-4061	51	270	150	22.5	124	15	20.7		
LH 2 Strap	505-4062	51	270	150	22.5	124	15	20.7		
Center 2 Strap Long Life (ARM)	505-4063	51	270	150	22.5	124	15	21.0		
RH 2 Strap Long Life (ARM)	505-4064	51	270	150	22.5	124	15	21.0		
LH 2 Strap Long Life (ARM)	505-4065	51	270	150	22.5	124	15	21.0		
Flushmount	505-4066	45-51	296	N/A	22.5	124	15	23.9		
Center Bolt-on	505-4067	50	320.8	320.8	22.5	124	15	24.8		
RH Bolt-on	505-4068	50	N/A	N/A	22.5	N/A	15	47.9		
LH Bolt-on	505-4069	50	N/A	N/A	22.5	N/A	15	47.9		
Tips										
Type	Part Number	Dimensions (mm)			Weight (kg)	Retainer and Sleeve	Notes			
	Heavy Abrasion 505-4011	A	B	C	23.3	Retainer: 456-7043 Sleeve: 456-7042				
	Heavy Penetration 505-4010	375	170	123	21.1					
	Heavy Duty 505-4012	387	66	123	17.7					
	General Purpose 505-4014	372	78	123	14.1					
Specialty										
	Heavy Duty Long Life (ARM) 505-4013	372	78	123	18.1	Retainer: 456-7043 Sleeve: 456-7042	The black areas in the pictures of the tips is where the ARM will be applied.			
Wear Protection										
Type	Machine	Part Number	A (mm)	B (mm)	C (mm)	Weight (kg)	Pin	Retainer	Base Plate	Notes
Straight MAWPS Sidebar Protector	986-988	498-3443	588	25	N/A	18.7	N/A	138-0006	463-1401	
Straight MAWPS Sidebar Protector		486-9066	512	30	N/A	15.7	N/A	138-0006	463-1401	
Straight MAWPS Sidebar Protector		486-9068	660	30	N/A	19.5	N/A	138-0006	463-1401	
Sidebar Protector Center	986-989	329-5954	254	36	578.0	22.4	329-5953	N/A	N/A	
Sidebar Protector Center		329-5958	200	30	466.7	17.4	275-5982	132-0999	N/A	
Sidebar Protector Center		9J-9600	254	30	578.0	16.7	135-9350	114-0359	N/A	











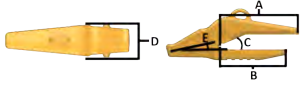

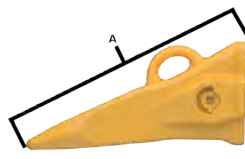

Wear Protection											
Half Arrows											
Part Number	Description	A (mm)	B (mm)	C (mm)	H (mm)	E (mm)	Number of Holes	Angle of Half Arrow	Weight (kg)	Notes	
288-8218*	Center	395	254	40	N/A	N/A	N/A	0	35.0		
292-9465*	Right	352	254	40	N/A	N/A	N/A	22	31.1		
292-9466*	Left	352	254	40	N/A	N/A	N/A	23	31.1		
116-7460	Center	312	435	45	85	140	3	0	43.8		
116-7461	Right	312	435	45	85	140	3	15	44.3		
116-7462	Left	312	435	45	85	140	3	15	44.3		
109-9080	Center	342	420	45	85	140	3	0	48.2		
109-9081	Right	342	420	45	85	140	3	15	48.8		
109-9082	Left	342	420	45	85	140	3	15	48.8		
257-1817	Center	342	432	60	85	140	3	0	64.7		
257-1818	Right	342	432	60	85	140	3	15	66.4		
257-1819	Left	342	432	60	85	140	3	15	66.4		
Top Covers											
Part Number	Description	A (mm)	B (mm)	C (mm)	H (mm)	E (mm)	K (mm)	Number of Holes	Weight (kg)	Bevel	Notes
195-7180	Center	342	200	25.4	85	86	53	3	11.9	22.5	Match dimensions A and H and the Number of Holes with the Half Arrows above to choose the correct Top Covers
195-7181	Right	354	200	25.4	85	92	53	3	12.4	22.5	
195-7182	Left	354	200	25.4	85	92	53	3	12.4	22.5	
Segments											
Description	Part Number	A (mm)	B (mm)	C (mm)	H (mm)	E (mm)	Number of Holes	Weight (kg)	Qty.	Nuts and Bolts	Notes
35mm Segments	9W-5734	312	482.5	35	85	240.5	3	38.3	1	Nut: 3K-9770 Bolt: 8T-9079	
	RH - 9W-5737	323	482.5	35	85	240.5	3	38.3	3		
	LH - 9W-5730	323	482.5	35	85	240.5	3	38.3	3		
40mm Segments	101-9435	342	482.5	40	85	240.5	3	48.5	1	Nut: 3K-9770 Bolt: 6V-6535	
	RH - 101-9436	354	482.5	40	85	240.5	3	50.4	3		
	LH - 101-9437	354	482.5	40	85	240.5	3	50.4	3		
40mm ARM Segments	138-0865	342	482.5	40	85	240.5	3	49.0	1	Nut: 3K-9770 Bolt: 6V-6535	
	RH - 138-0866	354	482.5	40	85	240.5	3	50.7	3		
	LH - 138-0867	354	482.5	40	85	240.5	3	50.7	3		
45mm Segments	208-5260	373	330	45	265	165	2	40.9	7	Nut: 3K-9770 Bolt: 6V-8360	
45mm Segments	107-3490	312	482.5	45	85	240.5	3	50.4	1		
	RH - 107-3491	323	482.5	45	85	240.5	3	52.2	3		
	LH - 107-3492	323	482.5	45	85	240.5	3	52.2	3		
45mm Segment	183-5324	350	330	45	241	165	2	38.2	7	Nut: 3K-9770 Bolt: 6V-8360	
45mm Segments	107-3536	312	482.5	45	85	240.5	3	50.4	1		
	RH - 107-3537	323	482.5	45	85	240.5	3	52.2	3		
	LH - 107-3538	323	482.5	45	85	240.5	3	52.2	3		

Cat Wheel Loaders

PART NUMBERS

Cat Advansys™ 130 Series - Base Edge Thickness: 51-64mm

Machine Models: 988-990

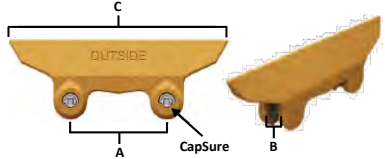
Adapters										
Type	Part Number	Edge Thickness	A (mm)	B (mm)	C (deg)	D (mm)	E (deg)	Weight (kg)	Notes	
Center 2 Strap	387-6842	51	263	213	22.5	162	15	41.3		
RH 2 Strap	387-6843	51	263	213	22.5	162	15	41.9		
LH 2 Strap	387-6844	51	263	213	22.5	162	15	41.9		
Center 2 Strap Long Life (ARM)	387-7243	51	263	213	22.5	162	15	41.6		
RH 2 Strap Long Life (ARM)	387-7244	51	263	213	22.5	162	15	42.2		
LH 2 Strap Long Life (ARM)	387-7245	51	263	213	22.5	162	15	42.2		
Center 2 Strap	368-3764	63.5	363	323	22.5	162	15	45.0		
RH 2 Strap	368-3765	63.5	363	323	22.5	162	15	44.7		
LH 2 Strap	368-3766	63.5	363	323	22.5	162	15	44.7		
Center 2 Strap Long Life (ARM)	387-7240	63.5	363	323	22.5	162	15	45.4		
RH 2 Strap Long Life (ARM)	387-7241	63.5	363	323	22.5	162	15	45.8		
LH 2 Strap Long Life (ARM)	387-7242	63.5	363	323	22.5	162	15	45.1		
Center Flushmount Adapter	368-3784	51-64	440	N/A	35	131	17	52.1		
RH/LF Corner Flushmount Adapter	368-3775	51-64	335	N/A	35	131	17	47.8		
Tips										
Type	Part Number	Dimensions (mm)			Weight (kg)	Retainer and Sleeve	Notes			
	Extreme Abrasion Rock (XAR)	539-5720	416.3	72.6	148	39.2	Retainer: 456-7043 Sleeve: 456-7042	   CapSure Plug 523-9811		
	Heavy Abrasion	381-4096	399	180	148	30.8				
	Heavy Penetration	381-4095	408	86	148	29.4				
	Heavy Duty	368-3791	400	92	148	25.8				
	General Purpose	381-4094	378	137	148	23.1				
	Coal	368-3860	366	122	148	20.1				
Specialty										
	Heavy Abrasion (A.R.M.)	486-6524	399	180	148	31.3	Retainer: 456-7043 Sleeve: 456-7042	The black areas in the pictures of the tips is where the ARM will be applied.		
	Heavy Duty Long Life (A.R.M.)	368-3857	400	92	148	26.6				
Wear Protection										
Type	Machine	Part Number	A (mm)	B (mm)	Weight (kg)	Pin	Retainer	Base Plate	Notes	
Flushmount Adapter Cover - Center	988-990	491-4054	N/A	N/A	N/A	N/A	N/A	N/A		
Flushmount Adapter Cover - Corner		491-4053	N/A	N/A	N/A	N/A	N/A	N/A		
Straight MAWPS Sidebar Protector	988-990	486-9066	512	30	15.8	N/A	138-0006	463-1401		
Straight MAWPS Sidebar Protector		486-9068	660	30	19.5	N/A	138-0006	463-1401		
Type	Machine	Part Number	A (mm)	B (mm)	C (mm)	Weight (kg)	Pin	Retainer	Shear Block	Notes
Capsure Sidebar Protector	988-990	329-5954	254	36	578.0	22.4	329-5953	N/A	356-6433	
Pin-On Sidebar Protector		9J-9600	254	33	578.0	16.8	135-9350	114-0359	331-7417	
Pin-On Sidebar Protector		166-2877	456	38	468.0	18.2	132-0998	132-0999	N/A	
Capsure Sidebar Protector		329-5946	294	53	598.0	23.9	329-5949	N/A	356-6432	
Pin-On Sidebar Protector		1U-0740	294	53	598.0	21.8	133-0738	107-8559	330-4456	
LH Weld On Sidebar Protector		454-8931	1385	N/A	1385.0	115.4	N/A	N/A	N/A	
RH Weld On Sidebar Protector		454-8932	1385	N/A	1385.0	115.4	N/A	N/A	N/A	
LH Weld On Sidebar Protector		453-5658	1677	N/A	1677.0	139	N/A	N/A	N/A	
RH Weld On Sidebar Protector		453-5659	1677	N/A	1677.0	139	N/A	N/A	N/A	

Wear Protection												
Shrouds												
Part Number	Description	A (mm)	B (mm)	C (mm)	D (mm)	E (deg)	Hole Spacing	Weight (kg)	Pins	Notes		
346-7779	Center	402	410	47	68	35	255	79.6	350-6751			
346-7780	Right	410	410	47	68	35	255	88.7	350-6751			
346-7781	Left	410	410	47	68	35	255	88.7	350-6751			
463-7871	Center	316	408	49	68	22.5	170	70.6	350-6751			
463-7872	Right	304	408	49	68	22.5	170	70.9	350-6751			
463-7873	Left	304	408	49	68	22.5	170	70.9	350-6751			
463-7862	Center	390	445	49.0	68	22.5	180	89.4	350-6751			
463-7863	Right	410	426	49.0	68	22.5	200	105	350-6751			
463-7864	Left	410	426	49.0	68	22.5	200	195	350-6751			
Half Arrows												
Part Number	Description	A (mm)	B (mm)	C (mm)	H (mm)	E (mm)	Number of Holes	Angle of Half Arrow	Weight (kg)	Notes		
257-1782	Center	402	400	45	85	140	4	0	56.4			
257-1783	Right	402	400	45	85	140	4	15	58.4			
257-1784	Left	402	400	45	85	140	4	15	58.4			
307-1636	Center ARM	402	400	45	85	140	4	0	60.2			
307-1638	Right ARM	402	400	45	85	140	4	15	60.2			
307-1639	Left ARM	402	400	45	85	140	4	15	60.2			
109-9080	Center	342	420	45	85	140	3	0	48.2			
109-9081	Right	342	420	45	85	140	3	15	48.8			
109-9082	Left	342	420	45	85	140	3	15	48.8			
257-1817	Center	342	420	60	85	140	3	0	64.7			
257-1818	Right	342	420	60	85	140	3	15	66.4			
257-1819	Left	342	420	60	85	140	3	15	66.4			
275-5460	Center	410	495	60	90	180	4	0	85.0			
275-5461	Right	436	480	60	100	180	4	15	90.6			
275-5462	Left	436	480	60	100	180	4	15	90.6			
275-5470	Center	410	536	75	90	180	4	0	100.5			
275-5471	Right	451	536	75	100	180	4	15	110.2			
275-5472	Left	451	536	75	100	180	4	15	110.2			
Top Covers												
Part Number	Description	A (mm)	B (mm)	C (mm)	H (mm)	E (mm)	K (mm)	Number of Holes	Weight (kg)	Bevel	Notes	
257-1778	Center	402	254	25	85	73.5	91.5	4	17.1	35		
257-1779	Right	402	254	25	85	73	91.5	4	17.1	35		
257-1781	Left	402	254	25	85	73	91.5	4	17.1	35		
233-7167	Center	342	254	25	85	86	91.5	3	14.8	35		
253-0191	Right	354	254	25	85	92	91.5	3	15.3	35		
253-0192	Left	354	254	25	85	92	91.5	3	15.3	35		
195-7180	Center	342	200	25.4	85	86	53	3	11.9	22.5		
195-7181	Right	354	200	25.4	85	92	53	3	12.4	22.5		
195-7182	Left	354	200	25.4	85	92	53	3	12.4	22.5		
195-7097	Right	451.4	254	25	100	75.7	78.5	4	19.3	22.5		
195-7098	Left	451.4	254	25	100	75.7	78.5	4	19.3	22.5		
307-5600	Center	410	330	29	90	70	104	4	26.7	35		
307-5601	Right	421	330	29	100	61	104	4	29.6	35		
307-5602	Left	421	330	29	100	61	104	4	29.6	35		
Segments												
Description	Part Number	A (mm)	B (mm)	C (mm)	H (mm)	E (mm)	Number of Holes	Weight (kg)	Qty.	Nuts and Bolts	Notes	
40mm Segments	4T-6760	410	590	40	90	295	4	68.0	1		Nut: 3K-9770 Bolt: 5P-8823	
	RH - 4T-6761	431	590	40	100	295	4	71.2	3			
	LH - 4T-6762	431	590	40	100	295	4	71.2	3			
40mm Segments	101-9435	342	482.5	40	85	240.5	3	48.5	1			
	RH - 101-9436	354	482.5	40	85	240.5	3	50.4	3			
	LH - 101-9437	354	482.5	40	85	240.5	3	50.4	3			
40mm ARM Segments	138-0865	342	482.5	40	85	240.5	3	49.0	1			Nut: 3K-9770 Bolt: 6V-6535
	RH - 138-0866	354	482.5	40	85	240.5	3	50.7	3			
	LH - 138-0867	354	482.5	40	85	240.5	3	50.7	3			
40mm Segments	315-0085	322	482.5	40	85	241.3	3	45.2	1			
	RH - 315-0086	334	482.5	40	85	241.3	3	47.9	3			
	LH - 315-0087	334	482.5	40	85	241.3	3	47.9	3			
40mm ARM Segments	138-0861*	410	590	40	90	295	4	70.0	1			
	RH - 138-0862*	431	590	40	100	295	4	74.8	3			
	LH - 138-0863*	431	590	40	100	295	4	74.8	3			
45mm Segments	315-0080	322	482.5	45	85	240.5	3	51.0	1	Nut: 3K-9770 Bolt: 6V-8360		
	RH - 315-0081	322	482.5	45	85	240.5	3	53.0	3			
	LH - 315-0082	322	482.5	45	85	240.5	3	53.0	3			
45mm Segments	107-3536	312	482.5	45	85	240.5	3	50.4	1		Nut: 3K-9770 Bolt: 6V-6535	
	RH - 107-3537	323	482.5	45	85	240.5	3	52.2	3			
	LH - 107-3538	323	482.5	45	85	240.5	3	52.2	3			







Cat Wheel Loaders

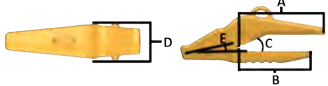

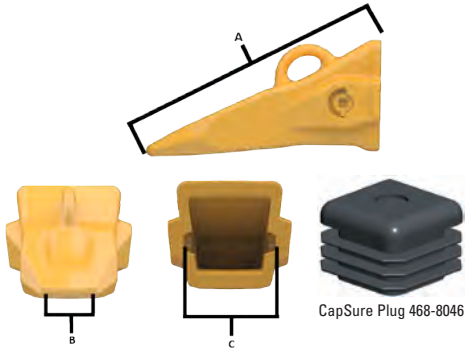
PART NUMBERS

Cat Advansys™ 150 Series - Base Edge Thickness: 63.5-76mm

Machine Models: 990-992

Adapters									
Type	Part Number	Edge Thickness	A (mm)	B (mm)	C (deg)	D (mm)	E (deg)	Weight (kg)	Notes
Center 2 Strap	368-3794	63.5	373	318	22.5	157	15	53.4	
RH 2 Strap	368-3795	63.5	373	318	22.5	157	15	53.6	
LH 2 Strap	368-3796	63.5	373	318	22.5	157	15	53.6	
Center 2 Strap Long Life (ARM)	433-8223	63.5	373	318	22.5	157	15	53.8	
RH 2 Strap Long Life (ARM)	433-8224	63.5	373	318	22.5	157	15	54.0	
LH 2 Strap Long Life (ARM)	433-8225	63.5	373	318	22.5	157	15	54.0	
Center 2 Strap	368-3803	70	366	307	22.5	170	17	67.0	
RH 2 Strap	368-3804	70	366	307	22.5	170	17	66.2	
LH 2 Strap	368-3805	70	366	307	22.5	170	17	66.3	
Center 2 Strap Long Life (ARM)	368-3806	70	366	307	22.5	170	17	67.5	
RH 2 Strap Long Life (ARM)	368-3807	70	366	307	22.5	170	17	66.8	
LH 2 Strap Long Life (ARM)	368-3808	70	366	307	22.5	170	17	66.8	
Center Flushmount Adapter	465-0460	64-76	476.5	N/A	35	150	14	66.7	
RH/LF Corner Flushmount Adapter	465-0461	64-76	404.5	N/A	35	150	14	64.1	

Tips										
Type		Part Number	Dimensions (mm)			Weight (kg)	Retainer and Sleeve	Notes		
			A	B	C					
	Extreme Abrasion Rock (XAR)	539-5730	491.2	80.7	166	65.8	Retainer: 456-1689 Sleeve: 454-9600 	CapSure Plug 468-8046		
	Heavy Abrasion	368-3863	467	241	166	48.9				
	Heavy Penetration	368-3862	485	78	166	45.0				
	Heavy Duty	368-3786	468	90	166	40.7				
	General Purpose	368-3879	443	170	166	37.6				
	Coal	368-3885	440	155	166	33.7				

Specialty										
	Heavy Abrasion (A.R.M.)	486-6520	467	241	166	49.6	Retainer: 456-1689 Sleeve: 454-9600	The black areas in the pictures of the tips are where the ARM will be applied.		
	Heavy Duty Long Life (A.R.M.)	368-3861	468	90	166	41.9				

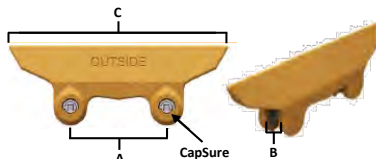
Wear Protection										
Type	Machine	Part Number	A (mm)	B (mm)	C (mm)	Weight (kg)	Pin	Retainer	Shear Block	Notes
Flushmount Adapter Cover - Center	990-992	491-4056	N/A	N/A	N/A	N/A	N/A	N/A	N/A	
Flushmount Adapter Cover - Corner		491-4055	N/A	N/A	N/A	N/A	N/A	N/A	N/A	
Pin-On Sidebar Protector	990-992	112-2492	300	52	649.0	14.4	132-1008	132-0999	N/A	
Capsure Sidebar Protector		329-5946	294	53	598.0	23.9	329-5949	N/A	356-6432	
Pin-On Sidebar Protector		1U-0740	300	53	598.0	21.8	133-0738	107-8559	330-4456	

Discontinued Canceled (Reference) Part is discontinued. Please contact your service representative. Part is canceled. Please contact your customer service representative. Part number is not serviceable. For reference only.

Wear Protection										
Shrouds										
Part Number	Description	A (mm)	B (mm)	C (mm)	D (mm)	E (deg)	Hole Spacing	Weight (kg)	Pins	Notes
348-8583	Center (Set of 6)	470	470	61	72	35	270	119.5	352-7950	
348-8584	Right (Set of 6)	496	455	61	72	35	300	126.0	352-7950	
348-8585	Left (Set of 6)	496	455	61	72	35	300	126.0	352-7950	
351-2425	Right (Set of 8)	342	447	61	72	35	170	86.0	352-7950	
351-2426	Left (Set of 8)	342	447	61	72	35	170	86.0	352-7950	
346-7772	Center (Set of 7)	410	481	61	79	35	270	108.3	352-7950	
346-7774	Right (Set of 7)	436	455	61	79	35	300	115.1	352-7950	
346-7775	Left (Set of 7)	436	455	61	79	35	300	115.1	352-7950	

Half Arrows										
Part Number	Description	A (mm)	B (mm)	C (mm)	H (mm)	E (mm)	Number of Holes	Angle of Half Arrow	Weight (kg)	Notes
109-9081	Right	342	420	45	85	140	3	15	48.8	
109-9082	Left	342	420	45	85	140	3	15	48.8	
264-2090	Center	470	495	60	90	180	4	0	91.7	
264-2091	Right	436	480	60	100	180	4	15	97.1	
264-2092	Left	436	480	60	100	180	4	15	97.1	
275-5460	Center	410	495	60	90	180	4	0	85.0	
275-5461	Right	436	480	60	100	180	4	15	90.6	
275-5462	Left	436	480	60	100	180	4	15	90.6	
275-6055	Center	390	536	75	90	180	4	0	96.0	
275-6056	Right	436	536	75	100	180	4	15	101.9	
275-6057	Left	436	536	75	100	180	4	15	101.9	
275-5470	Center	410	536	75	90	180	4	0	100.5	
275-5471	Right	451	536	75	100	180	4	15	110.2	
275-5472	Left	451	536	75	100	180	4	15	110.2	

Top Covers											
Part Number	Description	A (mm)	B (mm)	C (mm)	H (mm)	E (mm)	K (mm)	Number of Holes	Weight (kg)	Bevel	Notes
235-8777	Right	354	254	25	85	92	80.5	3	15	35	<p>Match dimensions A and H and the Number of Holes with the Half Arrows above to choose the correct Top Covers</p>
235-8778	Left	354	254	25	85	92	80.5	3	15	35	
253-0191	Left	354	254	25	85	92	91.5	3	15	22.5	
195-7096	Center	410	254	25	90	70	78.5	4	17.4	22.5	
195-7097	Right	451	254	25	100	75.7	78.5	4	19.3	22.5	
195-7098	Left	451	254	25	100	75.7	78.5	4	19.3	22.5	
335-7198*	Right	413	254	25	100	56.9	78.5	4	17.8	22.5	
335-7199*	Left	413	254	25	100	56.9	78.5	4	17.8	22.5	
208-5327	Center	410	330	35	90	70	128	4	32.8	35	
208-5328	Right	451	330	35	100	75.7	128	4	36.5	35	
208-5329	Left	451	330	35	100	75.7	128	4	36.5	35	
229-7045	Center	410	254	25	90	70	126.5	4	17.5	35	
229-7046	Right	451	254	25	100	75.7	126.5	4	19.5	35	
229-7047	Left	451	254	25	100	75.7	126.5	4	19.5	35	
195-7246	Center - ARM	410	254	25	90	70	126.5	4	17.4	35	
195-7247	Right - ARM	451	254	25	100	75.7	126.5	4	19.3	35	
195-7248	Left - ARM	451	254	25	100	75.7	126.5	4	19.3	35	
264-2096	Center	470	254	25	90	100		4	20.3	35	
264-2097	Right	513.5	254	25	100	106.8		4	22.4	35	
264-2098	Left	513.5	254	25	100	106.8		4	22.4	35	











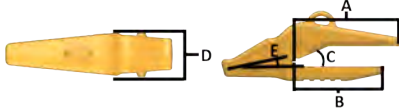

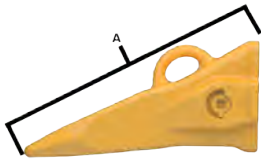
Segments											
Description	Part Number	A (mm)	B (mm)	C (mm)	H (mm)	E (mm)	Number of Holes	Weight (kg)	Qty.	Nuts and Bolts	Notes
40mm Segments	4T-6760	410	590	40	90	295	4	68.0	1	Nut: 3K-9770 Bolt: 5P-8823	
	RH - 4T-6761	431	590	40	100	295	4	71.2	3		
	LH - 4T-6762	431	590	40	100	295	4	71.2	3		
50mm Segments	107-3530	410	590	50	90	295	4	84.3	1		
	RH - 107-3531	431	590	50	100	295	4	90.4	3		
	LH - 107-3532	431	590	50	100	295	4	90.4	3		
60mm Segments	107-6294	410	590	60	90	295	4	102.2	1		
	RH - 107-6295	431	590	60	100	295	4	107.5	3		
	LH - 107-6296	431	590	60	100	295	4	107.5	3		

Cat Wheel Loaders

PART NUMBERS

Cat Advansys™ 170 Series - Base Edge Thickness: 76-90mm

Machine Models: 993

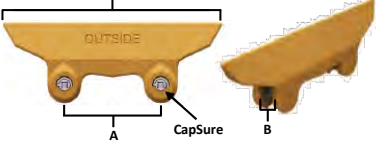
Adapters											
Type	Part Number	Edge Thickness	A (mm)	B (mm)	C (deg)	D (mm)	E (deg)	Weight (kg)	Notes		
Center 2 Strap	368-3825	76	436	336	22.5	160	17	73.1			
RH 2 Strap	368-3826	76	436	336	22.5	160	17	73.5			
LH 2 Strap	368-3827	76	436	336	22.5	160	17	73.5			
Center 2 Strap Long Life (ARM)	368-3837	76	436	336	22.5	160	17	73.7			
RH 2 Strap Long Life (ARM)	368-3838	76	436	336	22.5	160	17	74.4			
LH 2 Strap Long Life (ARM)	368-3839	76	436	336	22.5	160	17	74.4			
Center 2 Strap	368-3831	90	440	340	35	160	15	77.3			
RH 2 Strap	368-3832	90	440	340	35	160	15	77.4			
LH 2 Strap	368-3833	90	440	340	35	160	15	77.4			
Center 2 Strap Long Life (ARM)	368-3834	90	440	340	35	160	15	77.8			
RH 2 Strap Long Life (ARM)	368-3835	90	440	340	35	160	15	78.0			
LH 2 Strap Long Life (ARM)	368-3836	90	440	340	35	160	15	78.0			
Center Flushmount Adapter	368-3828	76-90	524	N/A	35	160	14	85.5			
RH/LF Corner Flushmount Adapter	368-3830	76-90	383	N/A	35	160	14	73.8			
Tips											
Type	Part Number	Dimensions (mm)			Weight (kg)	Retainer and Sleeve	Notes				
	Heavy Abrasion 368-3864	506	260	171	66.6	Retainer: 456-1689 Sleeve: 454-9600	   CapSure Plug 468-8046	The black areas in the pictures of the tips are where the ARM will be applied.			
	Heavy Penetration 368-3873	515	75	171	59.4						
	Heavy Duty 368-3867	499	89	171	52.9						
	General Purpose 368-3880	474	163	171	44.3						
	Coal 368-3875	474	187	171	43.4						
Specialty											
	Heavy Abrasion (A.R.M.) 486-6522	506	260	171	67.5	Retainer: 456-1689 Sleeve: 454-9600	The black areas in the pictures of the tips are where the ARM will be applied.				
	Heavy Duty Long Life (A.R.M.) 387-6856	499	89	171	54.0						
Wear Protection											
Type	Machine	Part Number	A (mm)	B (mm)	C (mm)	Weight (kg)	Pin	Retainer	Shear Block	Notes	
Flushmount Adapter Cover - Center	993	491-4058	N/A	N/A	N/A	N/A	N/A	N/A	N/A		
Flushmount Adapter Cover - Corner		491-4057	N/A	N/A	N/A	N/A	N/A	N/A	N/A		
Capsure Sidebar Protector	993	329-5946	294	53	598.0	23.9	329-5949	N/A	356-6432		
Pin-On Sidebar Protector		1U-0740	294	53	598.0	21.8	133-0738	107-8559	330-4456		
Capsure Sidebar Protector	329-5954	254	36	578.0	49.3	329-5953	N/A	356-6433			
Pin-On Sidebar Protector	988-990	9J-9600	254	33	578.0	36.9	135-9350	114-0359	331-7417		
Pin-On Sidebar Protector		166-2877	456	38	468.00	40.2	132-0998	132-0999	N/A		

Wear Protection										
Capsure Sidebar Protector	993	329-5946	294	53	598.0	23.9	329-5949	N/A	356-6432	
Pin-On Sidebar Protector		1U-0740	294	53	598.0	21.8	133-0738	107-8559	330-4456	
Capsure Sidebar Protector	988-990	329-5954	254	36	578.0	49.3	329-5953	N/A	356-6433	
Pin-On Sidebar Protector		9J-9600	254	33	578.0	36.9	135-9350	114-0359	331-7417	
Pin-On Sidebar Protector		166-2877	456	38	468.0	40.2	132-0998	132-0999	N/A	

Wear Protection										
Shrouds										
Part Number	Description	A (mm)	B (mm)	C (mm)	D (mm)	E (deg)	Hole Spacing	Weight (kg)	Pins	Notes
346-7776	Center	410	481	75	79	22.5	270	120.0	349-1160	
346-7777	Right	436	481	75	79	22.5	300	131.7	349-1160	
346-7778	Left	436	481	75	79	22.5	300	131.7	349-1160	
339-0310	Center	410	481	74	93	35	270	120.9	364-3032	
339-0311	Right	436	481	74	93	35	300	131.3	364-3032	
339-0312	Left	436	481	74	93	35	300	131.3	364-3032	

Half Arrows										
Part Number	Description	A (mm)	B (mm)	C (mm)	H (mm)	E (mm)	Number of Holes	Angle of Half Arrow	Weight (kg)	Notes
275-5460	Center	410	495	60	90	180	4	0	85.0	
275-5461	Right	436	480	60	100	180	4	15	90.6	
275-5462	Left	436	480	60	100	180	4	15	90.6	
275-6055	Center	390	536	75	90	180	4	0	96.0	
275-6056	Right	436	536	75	100	180	4	15	101.9	
275-6057	Left	436	536	75	100	180	4	15	101.9	
275-5470	Center	410	536	75	90	180	4	0	100.5	
275-5471	Right	451	536	75	100	180	4	15	110.2	
275-5472	Left	451	536	75	100	180	4	15	110.2	
275-5938	Center - ARM	410	536	75	90	180	4	0	102.2	
275-5936	Right - ARM	451	536	75	100	180	4	15	112.0	
275-5937	Left - ARM	451	536	75	100	180	4	15	112.0	
109-9033	Center	622	621	75	85	270	5	0	222.1	
109-9031	Right	440	598	75	85	270	5	15	139.0	
109-9032	Left	440	598	75	85	270	5	15	139.0	

Top Covers											
Part Number	Description	A (mm)	B (mm)	C (mm)	H (mm)	E (mm)	K (mm)	Number of Holes	Weight (kg)	Bevel	Notes
195-7096	Center	410	254	25	90	70	78.5	4	17.4	22.5	<p>Match dimensions A and H and the Number of Holes with the Half Arrows above to choose the correct Top Covers</p>
195-7097	Right	451	254	25	100	75.7	78.5	4	19.3	22.5	
195-7098	Left	451	254	25	100	75.7	78.5	4	19.3	22.5	
292-9462	Center	410	254	25	90	70	50	4	17.8	22.5	
292-9463	Right	451	254	25	100	75.7	50	4	19.4	22.5	
292-9464	Left	451	254	25	100	75.7	50	4	19.4	22.5	
294-8883	Center - ARM	410	254	25	90	70	50	4	19.2	22.5	
294-8884	Right - ARM	451	254	25	100	75.7	50	4	21.2	22.5	
294-8885	Left - ARM	451	254	25	100	75.7	50	4	21.2	22.5	
335-7198*	Right	413	254	25	100	56.9	78.5	4	17.8	22.5	
335-7199*	Left	413	254	25	100	56.9	78.5	4	17.8	22.5	
307-5600	Center	410	330	29	90	70	104	4	26.7	35	
307-5601	Right	421	330	29	100	61	104	4	29.6	35	
307-5602	Left	421	330	29	100	61	104	4	29.6	35	
395-3306	Center - ARM	410	330	29	90	70	104	4	27.8	35	
395-3307	Right - ARM	421	330	29	100	61	104	4	30.1	35	
395-3308	Left - ARM	421	330	29	100	61	104	4	30.1	35	
208-5327	Center	410	330	35	90	70	128	4	32.8	35	
208-5328	Right	451	330	35	100	75.7	128	4	36.5	35	
208-5329	Left	451	330	35	100	75.7	128	4	36.5	35	









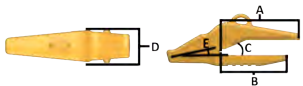

Segments											
Description	Part Number	A (mm)	B (mm)	C (mm)	H (mm)	E (mm)	Number of Holes	Weight (kg)	Qty.	Nuts and Bolts	Notes
40mm Segments	4T-6760	410	590	40	90	295	4	68.0	1	<p>Nut: 3K-9770 Bolt: 5P-8823</p>	
	RH - 4T-6761	431	590	40	100	295	4	71.2	3		
	LH - 4T-6762	431	590	40	100	295	4	71.2	3		
50mm Segments	107-3530	410	590	50	90	295	4	84.3	1		
	RH - 107-3531	431	590	50	100	295	4	90.4	3		
	LH - 107-3532	431	590	50	100	295	4	90.4	3		
60mm Segments	107-6294	410	590	60	90	295	4	102.2	1		
	RH - 107-6295	431	590	60	100	295	4	107.5	3		
	LH - 107-6296	431	590	60	100	295	4	107.5	3		

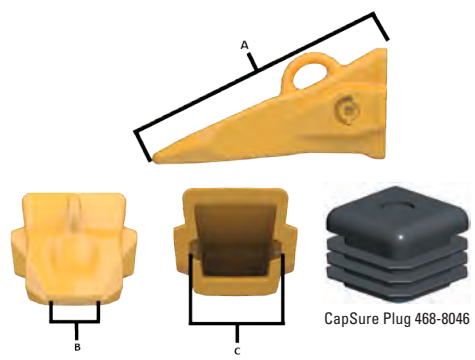
Cat Wheel Loaders

PART NUMBERS

Cat Advansys™ 200 Series - Base Edge Thickness: 100mm

Machine Models: 994

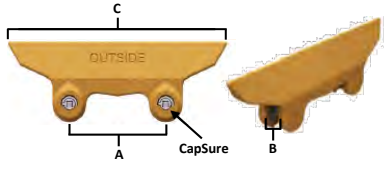
Adapters										
Type	Part Number	Edge Thickness	A (mm)	B (mm)	C (deg)	D (mm)	E (deg)	Weight (kg)	Notes	
Center 2-Strap	368-3852	100	444	344	22.5	220	16	105.5		
Center 2-Strap	368-3849	100	436.5	336.5	35	220	11.5	105.0		
Tips										
Type	Part Number	Dimensions (mm)			Weight (kg)	Retainer and Sleeve	Notes			
	Heavy Abrasion 385-4813	A	B	C	84.1	Retainer: 454-0278 Sleeve: 454-0277				
	Heavy Penetration 385-4812	520	296	196	80.5					
	Heavy Duty 385-4814	547	96	196	75.3					
	General Purpose 368-3876	513	144	196	73.9					
	Coal 387-6869	552	180	196	64.8					
Specialty										
	Heavy Abrasion (A.R.M.) 486-6526	A	B	C	85.3	Retainer: 454-0278 Sleeve: 454-0277	The black areas in the pictures of the tips is where the ARM will be applied.			
	Heavy Duty Long Life (A.R.M.) 387-6867	520	296	196	77.1					
Wear Protection										
Type	Machine	Part Number	A (mm)	B (mm)	Weight (kg)	Pin	Retainer	Shear Block	Notes	
Straight MAWPS Sidebar Protector	994	481-1104	567	67	37.63	N/A	138-0007	481-1105		
Type	Machine	Part Number	A (mm)	B (mm)	C (mm)	Weight (kg)	Pin	Retainer	Shear Block	Notes
Pin-On Sidebar Protector	994	125-0800	600	67	998.0	57.15	8E-4708	4T-4707	330-4455	
Capsure Sidebar Protector RH		304-5853	600	67	816.4	65.46	304-5849	N/A	356-6435	
Capsure Sidebar Protector LH		304-5854	600	67	816.4	65.46	304-5849	N/A	356-6435	

Wear Protection											
Shrouds											
Part Number	Description	A (mm)	B (mm)	C (mm)	D (mm)	E (deg)	Hole Spacing	Weight (kg)	Pins	Notes	
311-6933	Center	622	553	71	100	22.5	170	224	323-1842 2 needed per shroud		
324-6147	Right Hand	435	440	71	100	22.5	170	167			
324-6151	Left Hand	435	440	71	100	22.5	170	167			
326-5216	Center	440	553	71	100	22.5	170	160			
Half Arrows											
Part Number	Description	A (mm)	B (mm)	C (mm)	H (mm)	E (mm)	Number of Holes	Angle of Half Arrow	Weight (kg)	Notes	
109-9030	Center	440	593	75	85	270	5	0	151		
109-9031	Right Hand	440	593	75	85	270	5	15	139		
109-9302	Left Hand	440	593	75	85	270	5	15	139		
109-9033	Center	622	621	75	85	270	5	0	219		
117-6805	Right Hand	471	627	75	85	270	5	15	157		
117-6806	Left Hand	471	627	75	85	270	5	15	157		
Top Covers											
Part Number	Description	A (mm)	B (mm)	C (mm)	H (mm)	E (mm)	K (mm)	Number of Holes	Weight (kg)	Bevel	Notes
195-7230	Center	440	360	35	85	50	89	5	35	22.5	
195-7231	Right Hand	484	360	35	85	N/A	89	5	38	22.5	
195-7232	Left Hand	484	360	35	85	N/A	89	5	38	22.5	
229-6596	Center	644	348	35	85	152	89	5	54	22.5	
Segments											
Description	Part Number	A (mm)	B (mm)	C (mm)	H (mm)	E (mm)	Number of Holes	Weight (kg)	Qty.	Nuts and Bolts	Notes
103-1833	Center	440	445	75	50	85	5	132			
103-1834*	Right Hand	444	545	75	52	85	5	135			
103-1835*	Left Hand	444	545	75	520	85	5	135			

Cat Wheel Loaders

PART NUMBERS



Cat Advansys™ 220 Series - Base Edge Thickness: 100mm

Machine Models: 994K

Adapters										
Type	Part Number	Edge Thickness	A (mm)	B (mm)	C (deg)	D (mm)	E (deg)	Weight (kg)	Notes	
Center 2-Strap	506-2548	100	551	431	22.5	220	15	124.2		
Tips										
Type	Part Number	Dimensions (mm)			Weight (kg)	Retainer and Sleeve	Notes			
		A	B	C						
	Heavy Abrasion 431-0065	586	307	214	128.4	Retainer: 454-0278 Sleeve: 454-0277				
	Extreme Abrasion Rock 544-0456	604	104	214	147.7					
	Heavy Penetration 431-0062	608	122	214	110.3					
	General Purpose 431-0064	580	223	214	96.2					
	Coal 431-0069	580	223	214	92.0					
Specialty										
	Heavy Abrasion (A.R.M.) 431-0066	586	307	214	285.9	454-0278 454-0277	The black areas in the pictures of the tips are where the ARM will be applied.			
Wear Protection										
Type	Machine	Part Number	A (mm)	B (mm)	Weight (kg)	Pin	Retainer	Shear Block	Notes	
Straight MAWPS Sidebar Protector	994	481-1104	567	67	37.63	N/A	138-0007	481-1105		
Type	Machine	Part Number	A (mm)	B (mm)	C (mm)	Weight (kg)	Pin	Retainer	Shear Block	Notes
Adapter Cover	994K	441-0701	N/A	N/A	N/A	N/A	N/A	N/A	N/A	
Pin-On Sidebar Protector	994	125-0800	600	67	998.0	57.15	8E-4708	4T-4707	330-4455	
Capsure Sidebar Protector RH		304-5853	600	67	816.4	65.46	304-5849	N/A	356-6435	
Capsure Sidebar Protector LH		304-5854	600	67	816.4	65.46	304-5849	N/A	356-6435	
Shrouds										
Part Number	Description	A (mm)	B (mm)	C (mm)	D (mm)	E (deg)	Hole Spacing	Weight (kg)	Pins	Notes
311-6933	Center	622	553	70	100	22.5	85	224	323-1842 2 needed per shroud	
324-6147	Right Hand	220	440	70	100	22.5	85	167		
324-6151	Left Hand	220	440	70	100	22.5	85	167		
326-5216	Center	440	553	70	100	22.5	85	160		

Cat Advansys™ 230 Series - Base Edge Thickness: 120mm

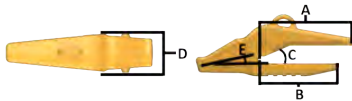
Machine Models: 994K

Adapters										
Type	Part Number	Edge Thickness	A (mm)	B (mm)	C (deg)	D (mm)	E (deg)	Weight (kg)	Notes	
Center 2-Strap	525-6541	120	559	439	22.5	219	15	141.8		
Tips										
Type	Part Number	Dimensions (mm)			Weight (kg)	Retainer and Sleeve	Notes			
	539-5642	A	B	C	172.2	Retainer: 454-0278 Sleeve: 454-0277				
	532-7015	597	436.8	214	129.9					
Wear Protection										
Type	Machine	Part Number	A (mm)	B (mm)	Weight (kg)	Pin	Retainer	Shear Block	Notes	
Straight MAWPS Sidebar Protector	994	481-1104	567	67	37.63	N/A	138-0007	481-1105		
Type	Machine	Part Number	A (mm)	B (mm)	C (mm)	Weight (kg)	Pin	Retainer	Shear Block	Notes
Adapter Cover	994K	441-0701	N/A	N/A	N/A	N/A	N/A	N/A	N/A	
Pin-On Sidebar Protector	994	125-0800	600	67	998.0	57.15	8E-4708	4T-4707	330-4455	
Capsure Sidebar Protector RH		304-5853	600	67	816.4	65.46	304-5849	N/A	356-6435	
Capsure Sidebar Protector LH		304-5854	600	67	816.4	65.46	304-5849	N/A	356-6435	
Shrouds										
Part Number	Description	A (mm)	B (mm)	C (mm)	D (mm)	E (deg)	Hole Spacing	Weight (kg)	Pins	Notes
525-6542	Center	440	593	70	120	22.5	170	195	323-1842 2 needed per shroud	
525-6543	Right Hand	463.1	615.1	70	120	22.5	170	207		
525-6544	Left Hand	463.1	615.1	70	120	22.5	170	207		

Cat Wheel Loaders

OPTIONS

K SERIES TIP OPTIONS

Below are the tip shapes best suited for the wide range of jobsite conditions performed by wheel loaders. We also offer additional K Series tips more commonly used with excavators. Your Cat dealer can help you choose the one that offers the right balance of penetration and wear life for your application.

↑
ABRASION
↓

HEAVY ABRASION



Heavy Abrasion tips are ideal for high-abrasion applications like sand, gravel and shot rock. They feature the maximum amount of wear material—approximately 145% more—and a tip base with 35% more surface area than Heavy Duty Penetration tips.

HEAVY PENETRATION



Heavy Penetration tips are ideal for high-impact, hard-to-penetrate materials. They feature approximately 120% more material in the high wear area as well as a spade design that has 60% less cross-sectional area on the leading edge than Heavy Abrasion tips.

HEAVY DUTY

A.R.M. OPTION AVAILABLE



Heavy Duty and Heavy Duty Abrasion Resistant Material (A.R.M.)* tips include approximately 60% more wear material in the tip body. The A.R.M. wears around the profile to increase penetration.

GENERAL PURPOSE



General Purpose tips are symmetrical and the baseline for other tip styles. All wear comparisons are to the General Purpose tip unless otherwise noted.

PENETRATION PLUS



Penetration Plus tips feature 25% more wear material and a leading edge with 25% less cross-sectional area. They self-sharpen as they wear.

PENETRATION

A.R.M. OPTION AVAILABLE



Penetration tips are ideal for densely compacted materials. They feature a leading edge with 60% less cross-sectional area—allowing for maximum penetration—and a single center rib that self-sharpens as it wears. These tips are available with A.R.M.*

↑
IMPACT
↓

*Abrasion Resistant Material (A.R.M.) is a welding process that bonds very hard tungsten carbide particles to Cat G.E.T. to create a protective shield over the component. Typically, the A.R.M. process doubles wear life—and can last even longer in some applications.

Cat Wheel Loaders

PART NUMBERS

K Series K80

Machine Models: 950, 962







Adapters											
Type	Part Number	Edge Thickness	A (mm)	B (mm)	C (deg)	D (mm)	E (deg)	Weight (kg)	Notes		
Center Bolt On Adapter	222-1087	32	291	291	22.5	107	14	14.4			
Center Bolt On Adapter	229-7087	25	228	228	22.5	108	14	12.9			
RH Bolt On Corner Adapter	222-1088	25/32	N/A	N/A	22.5	N/A	14	19.8			
LH Bolt On Corner Adapter	222-1089	25/32	N/A	N/A	22.5	N/A	14	19.8			
Flushmount Adapter	229-7084	25-38	236	N/A	22.5	92	14	9.3			
Tips											
Type	Part Number	Dimensions (mm)			Weight (kg)	Retainer	Notes				
		A	B	C							
	Heavy Abrasion 475-5476	263	100	84	7.9	220-9090					
	Heavy Penetration 475-5475	284	87	84	9.0						
	Heavy Duty 475-5468	268	92	84	5.9						
	General Purpose 475-5473	247	92	84	5.1						
Specialty											
	Heavy Duty Long Life (ARM) 475-5477	268	92	84	13.9	220-9090	The black areas in the pictures of the tips are where the ARM will be applied.				
Wear Protection											
Type	Machine	Part Number	A (mm)	B (mm)	Weight (kg)	Retainer	Base Plate	Notes			
Straight MAWPS Sidebar Protector	950, 962	498-3443	588	25	57.15	138-0006	463-1401				
Curved MAWPS Sidebar Protector		433-9831	602	25	65.46	138-0006	463-1401				
Curved MAWPS Sidebar Protector		433-9830	604	22	65.46	138-0006	463-1401				
Segments											
Description	Part Number	A (mm)	B (mm)	C (mm)	H (mm)	E (mm)	Number of Holes	Weight (kg)	Qty.	Nuts and Bolts	Notes
25mm Segments	4T-6694	225	280	25	155	139	2	10.8	5	Nut: 2J-3507 Bolt: 4F-4042	
	264-6233	220	280	25	155	139	2	10.2	2		
30mm Segments	140-7601	291	360	30	208	179	2	21.8	5		
	263-7545	268	360	30	208	179	2	19.9	2		
35mm Segments	132-4715	278	305	35	208	152	2	21.9	5		
	257-1726	258	305	35	208	152	2	17.5	2		

Cat Wheel Loaders

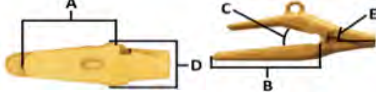
PART NUMBERS

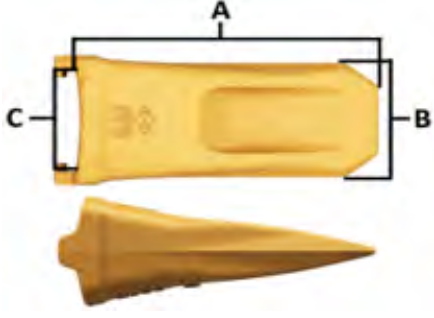
K Series K90

Machine Models: 966-972

Adapters									
Type	Part Number	Edge Thickness	A (mm)	B (mm)	C (deg)	D (mm)	E (deg)	Weight (kg)	Notes
Center 2 Strap	222-1094	40	240	165	22.5	99	14	14.6	
RH 2 Strap	222-1095	40	240	165	22.5	99	14	14.7	
LH 2 Strap	222-1096	40	240	165	22.5	99	14	14.7	
Center Bolt On Adapter	222-1097	40	288	288	22.5	130	14	17.6	
Center Bolt On Adapter	223-8097	32	262	262	22.5	122	14	20.1	
RH Bolt On Corner Adapter	229-7098	32/40	N/A	N/A	22.5	N/A	14	27.6	
LH Bolt On Corner Adapter	229-7099	32/40	N/A	N/A	22.5	N/A	14	27.6	
Flushmount Adapter	229-7094	32-45	229	N/A	22.5	99	14	14.6	
Tips									
Type	Part Number	Dimensions (mm)			Weight (kg)	Retainer	Notes		
		A	B	C					
	Heavy Abrasion 475-5487	279	128	90	10.8	220-9090			
	Heavy Penetration 475-5486	304	100	90	11.3				
	Heavy Duty 475-5480	279	99	90	8.1				
	General Purpose 475-5484	267	99	90	6.4				
Specialty									
	Heavy Duty Long Life (ARM) 475-5488	279	99	90	8.5	220-9090	The black areas in the pictures of the tips are where the ARM will be applied.		

Wear Protection												
Type	Machine	Part Number	A (mm)	B (mm)	C (mm)	Weight (kg)	Pin	Retainer	Base Plate	Notes		
Straight MAWPS Sidebar Protector	966-972	498-3443	588	25	N/A	57.15	N/A	138-0006	463-1401			
Curved MAWPS Sidebar Protector		433-9831	602	25	N/A	65.46	N/A	138-0006	463-1401			
Sidebar Protector Center	966-972	135-8246	238	28	466.4	10.86	135-9292	114-0359	N/A			
Half Arrows												
Part Number	Description	A (mm)	B (mm)	C (mm)	H (mm)	E (mm)	Number of Holes	Angle of Half Arrow	Weight (kg)	Notes		
313-5550	Center	290	315	30	203	98	2	0	20			
313-5548	Center	270	315	30	180	98	2	0	20			
135-9544	Center	300	400	41	120	127	2	0	35			
135-9545	Right Hand	315	400	41	200	127	2	15	39			
135-9546	Left Hand	315	400	41	200	127	2	15	39			
Top Covers												
Part Number	Description	A (mm)	B (mm)	C (mm)	H (mm)	E (mm)	K (mm)	Number of Holes	Weight (kg)	Bevel		
195-7230	Center	440	360	35	85	50	89	5	35	22.5		
195-7231	Right Hand	484	360	35	85	N/A	89	5	38	22.5		
195-7232	Left Hand	484	360	35	85	N/A	89	5	38	22.5		
229-6596	Center	644	348	35	85	152	89	5	54	22.5		
Segments												
Description	Part Number	A (mm)	B (mm)	C (mm)	H (mm)	E (mm)	Number of Holes	Weight (kg)	Qty.	Nuts and Bolts	Notes	
30mm Segments	100-6666	293	360	30	203	179	2	21.2	5	Nut: 3K-9770 Bolt: 5P-8823		
	308-4322	283	360	30	203	179	2	20.6	2			
30mm Segments	4T-6699	270	360	30	180	179	2	20.0	5			
	308-3054	260	360	30	180	179	2	18.9	2			
30mm Segments	4T6698	240	360	30	140	179	2	17.8	5			
	308-4323	230	360	30	140	179	2	16.6	2			
30mm Segments	196-2894*	263	360	30	180	179	2	19.1	5			
	275-7647*	240	360	30	180	179	2	17.8	2			
35mm Segments	140-6870	293	360	35	203	179	2	25.0	5			
	310-4067	273	360	35	203	179	2	24.1	2			
35mm Segments	140-6868	270	360	35	180	179	2	23.0	5			
	310-4064*	255	360	35	180	179	2	22.0	2			
40mm Segments	135-9294	300	330	40	120	164	2	29.0	1			Nut: 3K-9770 Bolt: 8T-9079
	RH-135-9295	315	330	40	201	164	2	30.4	3			
	LH-135-9296	315	330	40	201	164	2	30.4	3			

Cat Wheel Loaders

PART NUMBERS

K Series K100

Machine Models: 980-982

Adapters									
Type	Part Number	Edge Thickness	A (mm)	B (mm)	C (deg)	D (mm)	E (deg)	Weight (kg)	Notes
Center 2 Strap	223-8104	45	260	180	22.5	110	14	17.8	
RH 2 Strap	223-8105	45	256	177	22.5	110	14	18.0	
LH 2 Strap	223-8106	45	256	177	22.5	110	14	18.0	
Center 2 Strap Long Life (ARM)	229-7100	45	260	180	22.5	110	14	18.3	
RH 2 Strap Long Life (ARM)	229-7101	45	256	177	22.5	110	14	18.2	
LH 2 Strap Long Life (ARM)	229-7102	45	256	177	22.5	110	14	18.2	
Center Bolt On Adapter	223-8107	45	255	255	22.5	130	14	25.1	
RH Bolt On Corner Adapter	223-8108	45	N/A	N/A	22.5	N/A	14	39.4	
LH Bolt On Corner Adapter	223-8109	45	N/A	N/A	22.5	N/A	14	39.4	
Flushmount Adapter	229-7104	38-51	288	N/A	22.5	110	14	16.2	
Tips									
Type	Part Number	Dimensions (mm)			Weight (kg)	Retainer	Notes		
		A	B	C					
	Heavy Abrasion	475-5500	309	149	100	14.3			
	Heavy Penetration	475-5499	331	104	100	15.0			
	Heavy Duty	475-5492	309	110	100	11.2			
	General Purpose	475-5497	296	110	100	9.4			
Specialty									
	Heavy Duty Long Life (ARM)	475-5501	309	110	100	11.8	220-9090	The black areas in the pictures of the tips are where the ARM will be applied.	







Wear Protection											
Type	Machine	Part Number	A (mm)	B (mm)	C (mm)	Weight (kg)	Pin	Retainer	Base Plate	Notes	
Straight MAWPS Sidebar Protector	980-982	498-3443	588	25	N/A	18.7	N/A	138-0006	463-1401		
Curved MAWPS Sidebar Protector		433-9831	602	25	N/A	18.3	N/A	138-0006	463-1401		
Curved MAWPS Sidebar Protector		433-9832	610	30	N/A	19.4	N/A	138-0006	463-1401		
Straight MAWPS Sidebar Protector		486-9066	512	30	N/A	15.8	N/A	138-0006	463-1401		
Straight MAWPS Sidebar Protector		486-9068	660	30	N/A	19.5	N/A	138-0006	463-1401		
Sidebar Protector Center	980-982	135-8246	238	25	466.4	10.9	135-9292	114-0359	N/A		
Sidebar Protector Center		329-5958	200	30	466.7	17.4	275-5982	132-0999	N/A		
Sidebar Protector Center		9J-9600	254	30	578.0	16.8	135-9350	114-0359	N/A		
Half Arrows											
Part Number	Description	A (mm)	B (mm)	C (mm)	H (mm)	E (mm)	Number of Holes	Angle of Half Arrow	Weight (kg)	Notes	
174-4115	Center	315	315	30	185	102	2	0	21.6		
173-7447	Center	290	315	30	160	102	2	0	19.8		
116-7460	Center	312	435	45	85	140	3	0	43.8		
116-7461	Right	312	435	45	85	140	3	15	44.3		
116-7462	Left	312	435	45	85	140	3	15	44.3		
Top Covers											
Part Number	Description	A (mm)	B (mm)	C (mm)	H (mm)	E (mm)	K (mm)	Number of Holes	Weight (kg)	Bevel	Notes
286-2141	Right	323	203	12	85	86	66.5	3	5.7	22.5	
286-2142	Left	323	203	12	85	86	66.5	3	5.7	22.5	
286-2143	Center	323	203	12	85	86	66.5	3	5.7	22.5	
286-2051	Center	315	203	12	185	65	32	2	5.7	22.5	
Segments											
Description	Part Number	A (mm)	B (mm)	C (mm)	H (mm)	E (mm)	Number of Holes	Weight (kg)	Qty.	Nuts and Bolts	Notes
30mm Segments	109-9019	315	360	30	185	179	2	23.5	7		
30mm Segments	4T-6700	290	360	30	160	179	2	21.5	5		Nut: 3K-9770 Bolt: 5P-8823
	308-4327	275	360	30	160	179	2	20.1	2		
35mm Segments	9W-5734	312	482.5	35	85	240.5	3	38.3	1		Nut: 3K-9770 Bolt: 8T-9079
	RH - 9W-5737	323	482.5	35	85	240.5	3	38.3	3		
	LH - 9W-5730	323	482.5	35	85	240.5	3	38.3	3		
35mm ARM Segments	339-9800*	312	482.5	35	85	240.5	3	39.7	1		Nut: 3K-9770 Bolt: 6V-6535
	RH - 138-6471	323	482.5	35	85	240.5	3	40.3	3		
	LH - 138-6472	323	482.5	35	85	240.5	3	40.3	3		
35mm ARM Segments	208-5284	312	482.5	35	85	240.5	3	39.5	1		
	RH - 138-6471	323	482.5	35	85	240.5	3	40.3	3		
	LH - 138-6472	323	482.5	35	85	240.5	3	40.3	3		
45mm Segments	107-8580	290	360	45	160	179	2	32.7	7		Nut: 3K-9770 Bolt: 5P-8823
45mm Segments	135-8219	315	330	45	185	164	2	34.3	7		
45mm Segments	107-3490	312	482.5	45	85	240.5	3	50.4	1	Nut: 3K-9770 Bolt: 8T-9079	
	RH - 107-3491	323	482.5	45	85	240.5	3	52.2	3		
	LH - 107-3492	323	482.5	45	85	240.5	3	52.2	3		

Cat Wheel Loaders

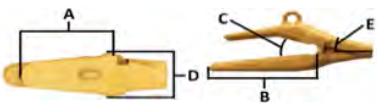
PART NUMBERS

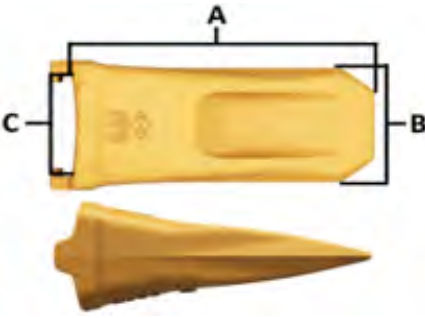
K Series K110

Machine Models: 986-988

Adapters									
Type	Part Number	Edge Thickness	A (mm)	B (mm)	C (deg)	D (mm)	E (deg)	Weight (kg)	Notes
Center 2 Strap	472-0811	51	269	149	22.5	157	14	21.1	
RH 2 Strap	472-0812	51	314	148	22.5	157	14	23.2	
LH 2 Strap	472-0813	51	314	148	22.5	157	14	23.2	
Center 2 Strap Long Life (ARM)	472-7747	51	269	149	22.5	157	14	21.3	
RH 2 Strap Long Life (ARM)	472-7748	51	314	148	22.5	157	14	23.0	
LH 2 Strap Long Life (ARM)	472-7749	51	314	148	22.5	157	14	23.0	
Center Bolt On Adapter	472-0814	50	319	319	22.5	159	14	24.5	
RH Bolt On Corner Adapter	472-0815	50	N/A	N/A	22.5	N/A	14	47.5	
LH Bolt On Corner Adapter	472-0816	50	N/A	N/A	22.5	N/A	14	47.5	
Flushmount Adapter	472-0826	45-51	286	N/A	22.5	160	14	23.0	
Tips									
Type	Part Number	Dimensions (mm)			Weight (kg)	Retainer	Notes		
		A	B	C					
	Heavy Abrasion 470-7974	346	170	110	21.1	Retainer: 286-2110 Slag Retainer: 309-1119			
	Heavy Penetration 467-9825	361	120	110	21.4				
	Heavy Duty 467-9821	346	126	110	17.1				
	General Purpose 467-9824	319	118	110	11.9				
Specialty									
	Heavy Duty Long Life (ARM) 472-7763	346	126	110	17.8	Retainer: 220-9130 Slag Retainer: 232-2139	The black areas in the pictures of the tips are where the ARM will be applied.		

Wear Protection										
Type	Machine	Part Number	A (mm)	B (mm)	C (mm)	Weight (kg)	Pin	Retainer	Base Plate	Notes
Straight MAWPS Sidebar Protector	986-988	498-3443	588	25	N/A	18.7	N/A	138-0006	463-1401	
Straight MAWPS Sidebar Protector		486-9066	512	30	N/A	15.8	N/A	138-0006	463-1401	
Straight MAWPS Sidebar Protector		486-9068	660	30	N/A	19.5	N/A	138-0006	463-1401	
Sidebar Protector Center	986-989	329-5954	254	36	578.0	22.4	329-5953	N/A	N/A	
Sidebar Protector Center		329-5958	200	30	466.7	17.4	275-5982	132-0999	N/A	
Sidebar Protector Center		9J-9600	254	30	578.0	16.8	135-9350	114-0359	N/A	

Half Arrows										
Part Number	Description	A (mm)	B (mm)	C (mm)	H (mm)	E (mm)	Number of Holes	Angle of Half Arrow	Weight (kg)	Notes
288-8218*	Center	395	254	40	N/A	N/A	N/A	0	35.0	
292-9465*	Right	352	254	40	N/A	N/A	N/A	22	31.1	
292-9466*	Left	352	254	40	N/A	N/A	N/A	23	31.1	
116-7460	Center	312	435	45	85	140	3	0	43.8	
116-7461	Right	312	435	45	85	140	3	15	44.3	
116-7462	Left	312	435	45	85	140	3	15	44.3	
109-9080	Center	342	420	45	85	140	3	0	48.2	
109-9081	Right	342	420	45	85	140	3	15	48.8	
109-9082	Left	342	420	45	85	140	3	15	48.8	
257-1817	Center	342	420	60	85	140	3	0	64.7	
257-1818	Right	342	420	60	85	140	3	15	66.4	
257-1819	Left	342	420	60	85	140	3	15	66.4	
257-1817	Center	342	435	60	85	140	3	0	64.7	
257-1818	Right	342	435	60	85	140	3	15	66.4	
257-1819	Left	342	435	60	85	140	3	15	66.4	

Top Covers											
Part Number	Description	A (mm)	B (mm)	C (mm)	H (mm)	E (mm)	K (mm)	Number of Holes	Weight (kg)	Bevel	Notes
195-7180	Center	342	200	25.4	85	86	53	3	11.9	22.5	
195-7181	Right	354	200	25.4	85	92	53	3	12.4	22.5	
195-7182	Left	354	200	25.4	85	92	53	3	12.4	22.5	









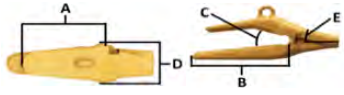

Segments													
Description	Part Number	A (mm)	B (mm)	C (mm)	H (mm)	E (mm)	Number of Holes	Weight (kg)	Qty.	Nuts and Bolts	Notes		
35mm Segments	9W-5734	312	482.5	35	85	240.5	3	38.3	1	Nut: 3K-9770 Bolt: 8T-9079			
	RH - 9W-5737	323	482.5	35	85	240.5	3	38.3	3				
	LH - 9W-5730	323	482.5	35	85	240.5	3	38.3	3				
40mm Segments	101-9435	342	482.5	40	85	240.5	3	48.5	1				
	RH - 101-9436	354	482.5	40	85	240.5	3	50.4	3				
	LH - 101-9437	354	482.5	40	85	240.5	3	50.4	3				
40mm ARM Segments	138-0865	342	482.5	40	85	240.5	3	49.0	1			Nut: 3K-9770 Bolt: 6V-6535	
	RH - 138-0866	354	482.5	40	85	240.5	3	50.7	3				
	LH - 138-0867	354	482.5	40	85	240.5	3	50.7	3				
45mm Segments	208-5260	373	330	45	265	165	2	40.9	7				
45mm Segments	107-3490	312	482.5	45	85	240.5	3	50.4	1				
	RH - 107-3491	323	482.5	45	85	240.5	3	52.2	3				
	LH - 107-3492	323	482.5	45	85	240.5	3	52.2	3				
45mm Segment	183-5324	350	330	45	241	165	2	38.2	7	Nut: 3K-9770 Bolt: 6V-8360			
45mm Segments	107-3536	312	482.5	45	85	240.5	3	50.4	1	Nut: 3K-9770 Bolt: 8T-9079			
	RH - 107-3537	323	482.5	45	85	240.5	3	52.2	3				
	LH - 107-3538	323	482.5	45	85	240.5	3	52.2	3				

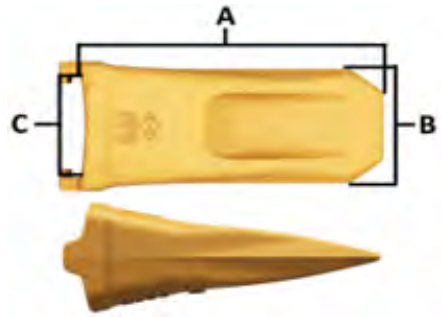
Cat Wheel Loaders

PART NUMBERS

K Series K130

Machine Models: 988-990

Adapters										
Type	Part Number	Edge Thickness	A (mm)	B (mm)	C (deg)	D (mm)	E (deg)	Weight (kg)	Notes	
Center 2 Strap	472-0794	51	268	218	22.5	178	15	40.6		
RH 2 Strap	472-0795	51	268	218	22.5	179	15	40.5		
LH 2 Strap	472-0796	51	268	218	22.5	179	15	40.5		
Center 2 Strap Long Life (ARM)	472-7753	51	268	218	22.5	178	15	41.4		
RH 2 Strap Long Life (ARM)	472-7754	51	268	218	22.5	179	15	41.4		
LH 2 Strap Long Life (ARM)	472-7755	51	268	218	22.5	179	15	41.4		
Center 2 Strap	472-0790	63.5	371	331	22.5	175	15	42.0		
RH 2 Strap	472-0791	63.5	371	331	22.5	175	15	42.1		
LH 2 Strap	472-0792	63.5	371	331	22.5	175	15	42.1		
Center 2 Strap Long Life (ARM)	472-7750	63.5	371	331	22.5	175	15	42.7		
RH 2 Strap Long Life (ARM)	472-7751	63.5	371	331	22.5	175	15	42.9		
LH 2 Strap Long Life (ARM)	472-7752	63.5	371	331	22.5	175	15	42.9		
Center Flushmount Adapter	472-0797	51-64	412	N/A	35	130	15	52.2		
RH/LF Corner Flushmount Adapter	472-0798	51-64	310	N/A	35	130	15	47.9		
Center Flushmount Adapter	472-0793	51-64	352	N/A	22.5	168	15	34.3		
Tips										
Type	Part Number	Dimensions (mm)			Weight (kg)	Retainer	Notes			
	Heavy Abrasion	467-9814	A	B	C	31.0	Retainer: 220-9130 Slag Retainer: 232-2139			
	Heavy Penetration	467-9816	386	190	130	30.7				
	Heavy Duty	467-9815	396	140	130	24.5				
	General Purpose	470-7978	386	140	130	18.8				
Specialty										
	Heavy Penetration Long Life (ARM)	472-7767	396	140	130	31.7	Retainer: 220-9130 Slag Retainer: 232-2139	The black areas in the pictures of the tips are where the ARM will be applied.		
	Heavy Duty Long Life (ARM)	472-7765	386	140	130	25.3				
Wear Protection										
Type	Machine	Part Number	A (mm)	B (mm)	Weight (kg)	Pin	Retainer	Base Plate	Notes	
Flushmount Adapter Cover - Center	988-990	251-2180	N/A	N/A	N/A	N/A	N/A	N/A		
Flushmount Adapter Cover - Corner		251-2461	N/A	N/A	N/A	N/A	N/A	N/A		
Straight MAWPS Sidebar Protector	988-990	486-9066	512	30	15.8	N/A	138-0006	463-1401		
Straight MAWPS Sidebar Protector		486-9068	660	30	19.5	N/A	138-0006	463-1401		
Type	Machine	Part Number	A (mm)	B (mm)	C (mm)	Weight (kg)	Pin	Retainer	Sheer Block	Notes
Capsure Sidebar Protector	988-990	329-5954	254	36	578.0	22.4	329-5953	N/A	356-6433	
Pin-On Sidebar Protector		9J-9600	254	33	578.0	16.8	135-9350	114-0359	331-7417	
Pin-On Sidebar Protector		166-2877	456	38	468.0	18.2	132-0998	132-0999	N/A	
Capsure Sidebar Protector		329-5946	294	53	598.0	23.9	329-5949	N/A	356-6432	
Pin-On Sidebar Protector		1U-0740	294	53	598.0	21.8	133-0738	107-8559	330-4456	
LH Weld On Sidebar Protector		454-8931	1385	N/A	1385.0	115.4	N/A	N/A	N/A	
RH Weld On Sidebar Protector		454-8932	1385	N/A	1385.0	115.4	N/A	N/A	N/A	
LH Weld On Sidebar Protector		453-5658	1677	N/A	1677.0	139	N/A	N/A	N/A	
RH Weld On Sidebar Protector		453-5659	1677	N/A	1677.1	139	N/A	N/A	N/A	

Wear Protection

Shrouds

Part Number	Description	A (mm)	B (mm)	C (mm)	D (mm)	E (deg)	Hole Spacing	Weight (kg)	Pins	Notes
346-7779	Center	402	410	47	68	35	255	79.6	350-6751	
346-7780	Right	410	410	47	68	35	255	88.7	350-6751	
346-7781	Left	410	410	47	68	35	255	88.7	350-6751	
463-7871	Center	316	408	49	68	22.5	170	70.6	350-6751	
463-7872	Right	304	408	49	68	22.5	170	70.9	350-6751	
463-7873	Left	304	408	49	68	22.5	170	70.9	350-6751	
463-7862	Center	390	445	49.0	68	22.5	180	89.4	350-6751	
463-7863	Right	410	426	49.0	68	22.5	200	105	350-6751	
463-7864	Left	410	426	49.0	68	22.5	200	105	350-6751	

Half Arrows

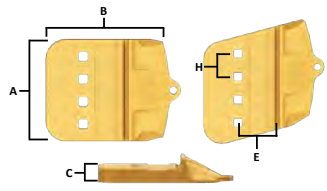
Part Number	Description	A (mm)	B (mm)	C (mm)	H (mm)	E (mm)	Number of Holes	Angle of Half Arrow	Weight (kg)	Notes
257-1782	Center	402	400	45	85	140	4	0	56.4	
257-1783	Right	402	400	45	85	140	4	15	58.4	
257-1784	Left	402	400	45	85	140	4	15	58.4	
307-1636	Center ARM	402	400	45	85	140	4	0	60.2	
307-1638	Right ARM	402	400	45	85	140	4	15	60.2	
307-1638	Left ARM	402	400	45	85	140	4	15	60.2	
109-9080	Center	342	420	45	85	140	3	0	48.2	
109-9081	Right	342	420	45	85	140	3	15	48.8	
109-9082	Left	342	420	45	85	140	3	15	48.8	
257-1817	Center	342	420	60	85	140	3	0	64.7	
257-1818	Right	342	420	60	85	140	3	15	66.4	
257-1819	Left	342	420	60	85	140	3	15	66.4	
275-5460	Center	410	495	60	90	180	4	0	85.0	
275-5461	Right	436	480	60	100	180	4	15	90.6	
275-5462	Left	436	480	60	100	180	4	15	90.6	
275-5470	Center	410	536	75	90	180	4	0	100.5	
275-5471	Right	451	536	75	100	180	4	15	110.2	
275-5472	Left	451	536	75	100	180	4	15	110.2	

Top Covers

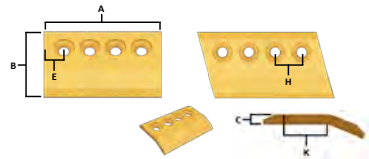
Part Number	Description	A (mm)	B (mm)	C (mm)	H (mm)	E (mm)	K (mm)	Number of Holes	Weight (kg)	Bevel	Notes
257-1778	Center	402	254	25	85	73.5	91.5	4	17.1	35	<p>Match dimensions A and H and the Number of Holes with the Half Arrows above to choose the correct Top Covers</p> 
257-1779	Right	402	254	25	85	73	91.5	4	17.1	35	
257-1781	Left	402	254	25	85	73	91.5	4	17.1	35	
233-7167	Center	342	254	25	85	86	91.5	3	14.8	35	
253-0191	Right	354	254	25	85	92	91.5	3	15.3	35	
253-0192	Left	354	254	25	85	92	91.5	3	15.3	35	
195-7180	Center	342	200	25.4	85	86	53	3	11.9	22.5	
195-7181	Right	354	200	25.4	85	92	53	3	12.4	22.5	
195-7182	Left	354	200	25.4	85	92	53	3	12.4	22.5	
195-7097	Right	451.4	254	25	100	75.7	78.5	4	19.3	22.5	
195-7098	Left	451.4	254	25	100	75.7	78.5	4	19.3	22.5	
307-5600	Center	410	330	29	90	70	104	4	26.7	35	
307-5601	Right	421	330	29	100	61	104	4	29.6	35	
307-5602	Left	421	330	29	100	61	104	4	29.6	35	

Segments

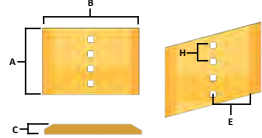





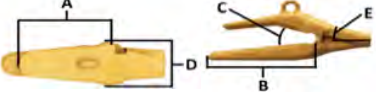

Description	Part Number	A (mm)	B (mm)	C (mm)	H (mm)	E (mm)	Number of Holes	Weight (kg)	Qty.	Nuts and Bolts	Notes
40mm Segments	4T-6760	410	590	40	90	295	4	68.0	1	Nut: 3K-9770 Bolt: 5P-8823	
	RH - 4T-6761	431	590	40	100	295	4	71.2	3		
	LH - 4T-6762	431	590	40	100	295	4	71.2	3		
40mm Segments	101-9435	342	482.5	40	85	240.5	3	48.5	1	Nut: 3K-9770 Bolt: 6V-6535	
	RH - 101-9436	354	482.5	40	85	240.5	3	50.4	3		
	LH - 101-9437	354	482.5	40	85	240.5	3	50.4	3		
40mm ARM Segments	138-0865	342	482.5	40	85	240.5	3	49.0	1	Nut: 3K-9770 Bolt: 6V-6535	
	RH - 138-0866	354	482.5	40	85	240.5	3	50.7	3		
	LH - 138-0867	354	482.5	40	85	240.5	3	50.7	3		
40mm Segments	315-0085	322	482.5	40	85	241.3	3	45.2	1	Nut: 3K-9770 Bolt: 6V-6535	
	RH - 315-0086	334	482.5	40	85	241.3	3	47.9	3		
	LH - 315-0087	334	482.5	40	85	241.3	3	47.9	3		
40mm ARM Segments	138-0861*	410	590	40	90	295	4	70.0	1	Nut: 3K-9770 Bolt: 6V-6535	
	RH - 138-0862*	431	590	40	100	295	4	74.8	3		
	LH - 138-0863*	431	590	40	100	295	4	74.8	3		
45mm Segments	315-0080	322	482.5	45	85	240.5	3	51.0	1	Nut: 3K-9770 Bolt: 6V-8360	
	RH - 315-0081	322	482.5	45	85	240.5	3	53.0	3		
	LH - 315-0082	322	482.5	45	85	240.5	3	53.0	3		
45mm Segments	107-3536	312	482.5	45	85	240.5	3	50.4	1	Nut: 3K-9770 Bolt: 6V-6535	
	RH - 107-3537	323	482.5	45	85	240.5	3	52.2	3		
	LH - 107-3538	323	482.5	45	85	240.5	3	52.2	3		

Cat Wheel Loaders

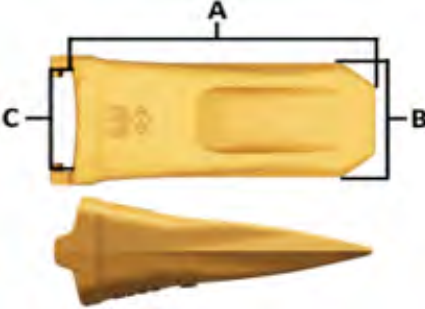
PART NUMBERS

K Series K150

Machine Models: 990-992

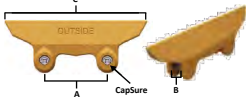
Adapters										
Type	Part Number	Edge Thickness	A (mm)	B (mm)	C (deg)	D (mm)	E (deg)	Weight (kg)	Notes	
Center 2 Strap	472-0805	63.5	371	316	22.5	200	15	52.9		
RH 2 Strap	472-0806	63.5	371	316	22.5	200	15	52.8		
LH 2 Strap	472-0807	63.5	371	316	22.5	200	15	52.8		
Center 2 Strap Long Life (ARM)	472-7759	63.5	371	316	22.5	200	15	53.5		
RH 2 Strap Long Life (ARM)	472-7760	63.5	371	316	22.5	200	15	53.5		
LH 2 Strap Long Life (ARM)	472-7761	63.5	371	316	22.5	200	15	53.5		
Center 2 Strap	472-0799	70	366	311	22.5	202	15	65.6		
RH 2 Strap	472-0800	70	366	311	22.5	202	15	65.3		
LH 2 Strap	472-0801	70	366	311	22.5	202	15	65.3		
Center 2 Strap Long Life (ARM)	472-7756	70	366	311	22.5	202	15	66.2		
RH 2 Strap Long Life (ARM)	472-7757	70	366	311	22.5	202	15	65.9		
LH 2 Strap Long Life (ARM)	472-7758	70	366	311	22.5	202	15	65.9		
Center Flushmount Adapter	471-9579	64-76	450	N/A	35	144	15	64.3		
RH/LF Corner Flushmount Adapter	471-9578	64-76	378	N/A	35	144	15	62.1		
Center Flushmount Adapter	472-0808	64-76	355	N/A	22.5	194	15	49.2		
Tips										
Type	Part Number	Dimensions (mm)			Weight (kg)	Retainer	Notes			
		A	B	C						
	Heavy Abrasion 467-9818	445	244	150	49.5	Retainer: 233-7150 Slag Retainer: 232-2159				
	Heavy Penetration 467-9820	462	180	150	50.9					
	Heavy Duty 467-9819	444	178	150	40.2					
	General Purpose 470-7985	421	168	150	30.5					
Specialty										
	Heavy Penetration Long Life (ARM) 472-7770	462	180	150	51.4	Retainer: 233-7150 Slag Retainer: 232-2159	The black areas in the pictures of the tips are where the ARM will be applied.			
	Heavy Duty Long Life (ARM) 472-7768	444	178	150	41.0					
Wear Protection										
Type	Machine	Part Number	A (mm)	B (mm)	C (mm)	Weight (kg)	Pin	Retainer	Sheer Block	Notes
Flushmount Adapter Cover - Center	990-992	232-0152	N/A	N/A	N/A	N/A	N/A	N/A	N/A	
Flushmount Adapter Cover - Corner		232-0153	N/A	N/A	N/A	N/A	N/A	N/A	N/A	
Pin-On Sidebar Protector	990-992	112-2492	300	52	649.0	31.6	132-1008	132-0999	N/A	
Capsure Sidebar Protector		329-5946	294	53	598.0	23.9	329-5949	N/A	356-6432	
Pin-On Sidebar Protector		1U-0740	300	53	598.0	21.8	133-0738	107-8559	330-4456	







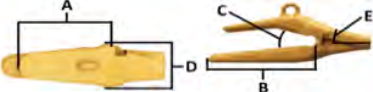

Wear Protection											
Shrouds											
Part Number	Description	A (mm)	B (mm)	C (mm)	D (mm)	E (deg)	Hole Spacing	Weight (kg)	Pins	Notes	
348-8583	Center (Set of 6)	470	470	61	72	35	270	119.5	352-7950		
348-8584	Right (Set of 6)	496	455	61	72	35	300	126.0	352-7950		
348-8585	Left (Set of 6)	496	455	61	72	35	300	126.0	352-7950		
351-2425	Right (Set of 8)	342	447	61	72	35	170	86.0	352-7950		
351-2426	Left (Set of 8)	342	447	61	72	35	170	86.0	352-7950		
346-7772	Center (Set of 7)	410	481	61	79	35	270	108.3	364-3750		
346-7774	Right (Set of 7)	436	455	61	79	35	300	115.1	364-3750		
346-7775	Left (Set of 7)	436	455	61	79	35	300	115.1	364-3750		
Half Arrows											
Part Number	Description	A (mm)	B (mm)	C (mm)	H (mm)	E (mm)	Number of Holes	Angle of Half Arrow	Weight (kg)	Notes	
109-9081	Right	342	420	45	85	140	3	15	48.8		
109-9082	Left	342	420	45	85	140	3	15	48.8		
264-2090	Center	470	495	60	90	180	4	0	91.7		
264-2091	Right	436	480	60	100	180	4	15	97.1		
264-2092	Left	436	480	60	100	180	4	15	97.1		
275-5460	Center	410	495	60	90	180	4	0	85.0		
275-5461	Right	436	480	60	100	180	4	15	90.6		
275-5462	Left	436	480	60	100	180	4	15	90.6		
275-6055	Center	390	536	75	90	180	4	0	96.0		
275-6056	Right	436	536	75	100	180	4	15	101.9		
275-6057	Left	436	536	75	100	180	4	15	101.9		
275-5470	Center	410	536	75	90	180	4	0	100.5		
275-5471	Right	451	536	75	100	180	4	15	110.2		
275-5472	Left	451	536	75	100	180	4	15	110.2		
Top Covers											
Part Number	Description	A (mm)	B (mm)	C (mm)	H (mm)	E (mm)	K (mm)	Number of Holes	Weight (kg)	Bevel	Notes
235-8777	Right	354	254	25	85	92	80.5	3	24.8	35	<p>Match dimensions A and H and the Number of Holes with the Half Arrows above to choose the correct Top Covers</p>
235-8778	Left	354	254	25	85	92	80.5	3	24.8	35	
253-0191	Left	354	254	25	85	92	91.5	3	24.8	22.5	
195-7096	Center	410	254	25	90	70	78.5	4	17.4	22.5	
195-7097	Right	451	254	25	100	75.7	78.5	4	19.3	22.5	
195-7098	Left	451	254	25	100	75.7	78.5	4	19.3	22.5	
335-7198*	Right	413	254	25	100	56.9	78.5	4	17.8	22.5	
335-7199*	Left	413	254	25	100	56.9	78.5	4	17.8	35	
208-5327	Center	410	330	35	90	70	128	4	32.8	35	
208-5328	Right	451	330	35	100	75.7	128	4	36.5	35	
208-5329	Left	451	330	35	100	75.7	128	4	36.5	35	
229-7045	Center	410	254	25	90	70	126.5	4	17.5	35	
229-7046	Right	451	254	25	100	75.7	126.5	4	19.5	35	
229-7047	Left	451	254	25	100	75.7	126.5	4	19.5	35	
195-7246	Center - ARM	410	254	25	90	70	126.5	4	17.4	35	
195-7247	Right - ARM	451	254	25	100	75.7	126.5	4	19.3	35	
195-7248	Left - ARM	451	254	25	100	75.7	126.5	4	19.3	35	
264-2096	Center	470	254	25	90	100		4	20.3	35	
264-2097	Right	513.5	254	25	100	106.8		4	22.4	35	
264-2098	Left	513.5	254	25	100	106.8		4	22.4	35	
Segments											
Description	Part Number	A (mm)	B (mm)	C (mm)	H (mm)	E (mm)	Number of Holes	Weight (kg)	Qty.	Nuts and Bolts	Notes
40mm Segments	4T-6760	410	590	40	90	295	4	68.0	1	<p>Nut: 3K-9770 Bolt: 5P-8823</p>	
	RH - 4T-6761	431	590	40	100	295	4	71.2	3		
	LH - 4T-6762	431	590	40	100	295	4	71.2	3		
50mm Segments	107-3530	410	590	50	90	295	4	84.3	1		
	RH - 107-3531	431	590	50	100	295	4	90.4	3		
	LH - 107-3532	431	590	50	100	295	4	90.4	3		
60mm Segments	107-6294	410	590	60	90	295	4	102.2	1		
	RH - 107-6295	431	590	60	100	295	4	107.5	3		
	LH - 107-6296	431	590	60	100	295	4	107.5	3		

Cat Wheel Loaders

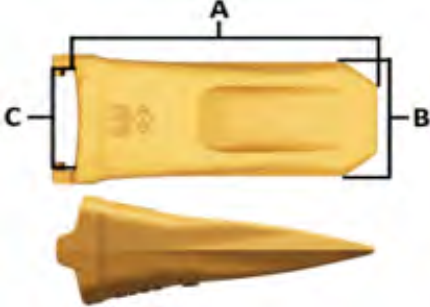
PART NUMBERS

K Series K170

Machine Models: 993

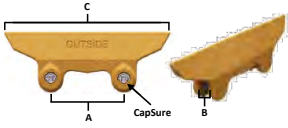
Adapters										
Type	Part Number	Edge Thickness	A (mm)	B (mm)	C (deg)	D (mm)	E (deg)	Weight (kg)	Notes	
Center 2 Strap	478-2529	70	365	290	22.5	225	15	66.9		
RH 2 Strap	478-2530	70	365	290	22.5	225	15	66.9		
LH 2 Strap	478-2531	70	365	290	22.5	225	15	66.9		
Center 2 Strap Long Life (ARM)	478-7594*	70	365	290	22.5	225	15	67.6		
RH 2 Strap Long Life (ARM)	478-7595*	70	365	290	22.5	225	15	67.7		
LH 2 Strap Long Life (ARM)	478-7596*	70	365	290	22.5	225	15	67.7		
Center 2 Strap	478-2535	76	435	335	22.5	214	15	72.2		
RH 2 Strap	478-2536	76	435	335	22.5	214	15	72.2		
LH 2 Strap	478-2537	76	435	335	22.5	214	15	72.2		
Center 2 Strap Long Life (ARM)	478-7591*	76	435	335	22.5	214	15	73.0		
RH 2 Strap Long Life (ARM)	478-7592*	76	435	335	22.5	214	15	73.0		
LH 2 Strap Long Life (ARM)	478-7593*	76	435	335	22.5	214	15	73.0		
Center 2 Strap	478-2540	90	435	335	22.5	214	15	76.2		
RH 2 Strap	478-2541	90	435	335	22.5	214	15	76.1		
LH 2 Strap	478-2542	90	435	335	22.5	214	15	76.1		
Center Flushmount Adapter	478-2543	76-90	500	N/A	35	160	15	80.6		
RH/LF Corner Flushmount Adapter	478-2544	76-90	360	N/A	35	160	15	71.5		
Tips										
Type	Part Number	Dimensions (mm)			Weight (kg)	Retainer	Notes			
	Heavy Abrasion	232-2178	A	B	C	73.6	Retainer: 232-0170 Slag Retainer: 232-2179			
	Heavy Penetration	264-2172	484	260	170	67.2				
	Heavy Duty	264-2171	494	188	170	57.1				
	General Purpose	232-0179	485	194	170	36.8				
Specialty										
	Heavy Duty Long Life (ARM)	233-7170	485	194	170	58.4	Retainer: 232-0170 Slag Retainer: 232-2179	The black areas in the pictures of the tips are where the ARM will be applied.		
Wear Protection										
Type	Machine	Part Number	A (mm)	B (mm)	C (mm)	Weight (kg)	Pin	Retainer	Sheer Block	Notes
Flushmount Adapter Cover - Center	993	264-2060	N/A	N/A	N/A	N/A	N/A	N/A	N/A	
Flushmount Adapter Cover - Corner		264-2061	N/A	N/A	N/A	N/A	N/A	N/A	N/A	
Capsure Sidebar Protector	993	329-5946	294	53	598.0	23.9	329-5949	N/A	356-6432	
Pin-On Sidebar Protector		1U-0740	294	53	598.0	21.8	133-0738	107-8559	330-4456	

Wear Protection											
Shrouds											
Part Number	Description	A (mm)	B (mm)	C (mm)	D (mm)	E (deg)	Hole Spacing	Weight (kg)	Pins	Notes	
346-7776	Center	410	481	75	79	22.5	270	120.0	349-1160		
346-7777	Right	436	481	75	79	22.5	300	131.7	349-1160		
346-7778	Left	436	481	75	79	22.5	300	131.7	349-1160		
339-0310	Center	410	481	74	93	35	270	120.9	364-3032		
339-0311	Right	436	481	74	93	35	300	131.3	364-3032		
339-0312	Left	436	481	74	93	35	300	131.3	364-3032		
Half Arrows											
Part Number	Description	A (mm)	B (mm)	C (mm)	H (mm)	E (mm)	Number of Holes	Angle of Half Arrow	Weight (kg)	Notes	
275-5460	Center	410	495	60	90	180	4	0	85.0		
275-5461	Right	436	480	60	100	180	4	15	90.6		
275-5462	Left	436	480	60	100	180	4	15	90.6		
275-6055	Center	390	536	75	90	180	4	0	96.0		
275-6056	Right	436	536	75	100	180	4	15	101.9		
275-6057	Left	436	536	75	100	180	4	15	101.9		
275-5470	Center	410	536	75	90	180	4	0	100.5		
275-5471	Right	451	536	75	100	180	4	15	110.2		
275-5472	Left	451	536	75	100	180	4	15	110.2		
275-5938	Center - ARM	410	536	75	90	180	4	0	102.2		
275-5936	Right - ARM	451	536	75	100	180	4	15	112.0		
275-5937	Left - ARM	451	536	75	100	180	4	15	112.0		
109-9033	Center	622	621	75	85	270	5	0	222.1		
109-9031	Right	440	598	75	85	270	5	15	139.0		
109-9032	Left	440	598	75	85	270	5	15	139.0		
Top Covers											
Part Number	Description	A (mm)	B (mm)	C (mm)	H (mm)	E (mm)	K (mm)	Number of Holes	Weight (kg)	Bevel	Notes
195-7096	Center	410	254	25	90	70	78.5	4	17.4	22.5	<p>Match dimensions A and H and the Number of Holes with the Half Arrows above to choose the correct Top Covers</p>
195-7097	Right	451	254	25	100	75.7	78.5	4	19.3	22.5	
195-7098	Left	451	254	25	100	75.7	78.5	4	19.3	22.5	
292-9462	Center	410	254	25	90	70	50	4	17.8	22.5	
292-9463	Right	451	254	25	100	75.7	50	4	19.4	22.5	
292-9464	Left	451	254	25	100	75.7	50	4	19.4	22.5	
294-8883	Center - ARM	410	254	25	90	70	50	4	19.2	22.5	
294-8884	Right - ARM	451	254	25	100	75.7	50	4	21.2	22.5	
294-8885	Left - ARM	451	254	25	100	75.7	50	4	21.2	22.5	
335-7198*	Right	413	254	25	100	56.9	78.5	4	17.8	22.5	
335-7199*	Left	413	254	25	100	56.9	78.5	4	17.8	22.5	
307-5600	Center	410	330	29	90	70	104	4	26.7	35	
307-5601	Right	421	330	29	100	61	104	4	29.6	35	
307-5602	Left	421	330	29	100	61	104	4	29.6	35	
395-3306	Center - ARM	410	330	29	90	70	104	4	27.8	35	
395-3307	Right - ARM	421	330	29	100	61	104	4	30.1	35	
395-3308	Left - ARM	421	330	29	100	61	104	4	30.1	35	
208-5327	Center	410	330	35	90	70	128	4	32.8	35	
208-5328	Right	451	330	35	100	75.7	128	4	36.5	35	
208-5329	Left	451	330	35	100	75.7	128	4	36.5	35	
Segments											
Description	Part Number	A (mm)	B (mm)	C (mm)	H (mm)	E (mm)	Number of Holes	Weight (kg)	Qty.	Nuts and Bolts	Notes
40mm Segments	4T-6760	410	590	40	90	295	4	68.0	1	<p>Nut: 3K-9770 Bolt: 5P-8823</p>	
	RH - 4T-6761	431	590	40	100	295	4	71.2	3		
	LH - 4T-6762	431	590	40	100	295	4	71.2	3		
50mm Segments	107-3530	410	590	50	90	295	4	84.3	1		
	RH - 107-3531	431	590	50	100	295	4	90.4	3		
	LH - 107-3532	431	590	50	100	295	4	90.4	3		
60mm Segments	107-6294	410	590	60	90	295	4	102.2	1		
	RH - 107-6295	431	590	60	100	295	4	107.5	3		
	LH - 107-6296	431	590	60	100	295	4	107.5	3		

Discontinued
Canceled
(Reference)

Part is discontinued. Please contact your service representative.
Part is canceled. Please contact your customer service representative.
Part number is not serviceable. For reference only.

Cat Wheel Loaders

OPTIONS

CAPSURE TIP OPTIONS

We offer four CapSure tip options designed for a range of jobsite conditions. Your Cat dealer can help you choose the one that offers the right balance of penetration and wear life for your application.

ABRASION
▲

HEAVY DUTY ABRASION



Heavy Duty Abrasion tips are ideal for high-abrasion applications like sand, gravel and shot rock. They have the maximum amount of wear material—approximately 145% more—and the tip base features 35% more surface area than Heavy Penetration tips.

HEAVY PENETRATION



Heavy Penetration tips are ideal for high-impact, hard-to-penetrate materials. They feature approximately 120% more material in the high wear area as well as a sharp spade design with 70% less cross-sectional area on the leading edge than Heavy Duty Abrasion tips.

HEAVY DUTY



Heavy Duty tips are the baseline for other tips. All wear comparisons are to the Heavy Duty tip unless otherwise noted.

PENETRATION PLUS



Penetration Plus tips feature 30% more wear material and 25% less cross-sectional area. They self-sharpen as they wear.

▼
IMPACT

Cat Wheel Loaders

PART NUMBERS

CapSure™ J550 Series

Machine Models: 988-990

Adapters									
Type	Part Number	Edge Thickness	A (mm)	B (mm)	C (deg)	D (mm)	E (deg)	Weight (kg)	Notes
Center 2 Strap	138-6554	51	258	198	22.5	174	15	40.5	
RH 2 Strap	138-6555	51	253	193	22.5	174	15	40.5	
LH 2 Strap	138-6556	51	253	193	22.5	174	15	40.5	
Center 2 Strap Long Life (ARM)	159-0554	51	258	198	22.5	174	15	40.8	
RH 2 Strap Long Life (ARM)	159-0555*	51	253	193	22.5	174	15	40.8	
LH 2 Strap Long Life (ARM)	159-0556*	51	253	193	22.5	174	15	40.8	
Center 2 Strap	107-3554	63.5	356	316	22.5	160	15	36.8	
RH 2 Strap	107-3555	63.5	356	316	22.5	160	15	37.9	
LH 2 Strap	107-3556	63.5	356	316	22.5	160	15	37.9	
Center 2 Strap Long Life (ARM)	112-2554	63.5	356	316	22.5	160	15	43.0	
RH 2 Strap Long Life (ARM)	112-2555	63.5	356	316	22.5	160	15	43.0	
LH 2 Strap Long Life (ARM)	112-2556	63.5	356	316	22.5	160	15	43.0	
Flushmount Center Adapter	3G-4554	51-64	378	N/A	22.5	118	15	34.0	
Flushmount Corner Adapter - RH	3G-4555	51-64	381	N/A	22.5	118	15	35.0	
Flushmount Corner Adapter - LH	3G-4556	51-64	381	N/A	22.5	118	15	35.0	
Flushmount Center Adapter	186-3294	63.5	412	N/A	35	120	15	51.8	
Bottom Strap Center Adapter	9J-3662*	51-64	N/A	381	22.5	160	15	51.5	
Bottom Strap Corner Adapter - RH	9J-3663*	51-64	N/A	381	22.5	160	15	51.8	
Bottom Strap Corner Adapter - LH	9J-3664*	51-64	N/A	381	22.5	160	15	51.8	

Tips									
Type	Part Number	Dimensions (mm)			Weight (kg)	Pin and Retainer	Notes		
		A	B	C					
	Heavy Abrasion	460-8042	343	192	118	34.4			
	Heavy Penetration	460-8046	380	134	118	32.8			
	Heavy Duty	460-8050	347	145	118	28.3			
	General Purpose	460-8044	330	150	118	21.4			

Wear Protection									
Type	Machine	Part Number	A (mm)	B (mm)	Weight (kg)	Pin	Retainer	Base Plate	Notes
Straight MAWPS Sidebar Protector	988-990	486-9066	512	30	15.8	N/A	138-0006	463-1401	
Straight MAWPS Sidebar Protector		486-9068	660	30	19.5	N/A	138-0006	463-1401	
Type	Machine	Part Number	A (mm)	B (mm)	C (mm)	Weight (kg)	Pin	Retainer	Shear Block
Capsure Sidebar Protector	988-990	329-5954	254	36	578.0	22.4	329-5953	N/A	356-6433
Pin-On Sidebar Protector		9J-9600	254	33	578.0	16.8	135-9350	114-0359	331-7417
Pin-On Sidebar Protector		166-2877	456	38	468.0	18.2	132-0998	132-0999	N/A
Capsure Sidebar Protector		329-5946	294	53	598.0	23.9	329-5949	N/A	356-6432
Pin-On Sidebar Protector		1U-0740	294	53	598.0	21.8	133-0738	107-8559	330-4456
LH Weld On Sidebar Protector		454-8931	1385	N/A	1385.0	115.4	N/A	N/A	N/A
RH Weld On Sidebar Protector		454-8932	1385	N/A	1385.0	115.4	N/A	N/A	N/A
LH Weld On Sidebar Protector		453-5658	1677	N/A	1677.0	139	N/A	N/A	N/A
RH Weld On Sidebar Protector		453-5659	1677	N/A	1677.1	139	N/A	N/A	N/A

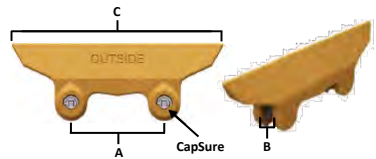

Wear Protection

Shrouds

Part Number	Description	A (mm)	B (mm)	C (mm)	D (mm)	E (deg)	Hole Spacing	Weight (kg)	Pins	Notes
346-7779	Center	402	410	47	68	35	255	79.6	350-6751	
346-7780	Right	410	410	47	68	35	255	88.7	350-6752	
346-7781	Left	410	410	47	68	35	255	88.7	350-6753	
463-7871	Center	316	408	49	68	22.5	170	70.6	350-6751	
463-7872	Right	304	408	49	68	22.5	170	70.9	350-6751	
463-7873	Left	304	408	49	68	22.5	170	70.9	350-6751	
463-7862	Center	390	445	49.0	68	22.5	180	89.4	350-6751	
463-7863	Right	410	426	49.0	68	22.5	200	105	350-6751	
463-7864	Left	410	426	49.0	68	22.5	200	105	350-6751	

Half Arrows

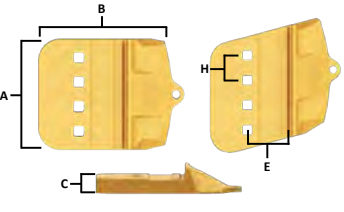
Part Number	Description	A (mm)	B (mm)	C (mm)	H (mm)	E (mm)	Number of Holes	Angle of Half Arrow	Weight (kg)	Notes
257-1782	Center	402	400	45	85	140	4	0	56.4	<p>Half Arrow Dimensions</p> 
257-1783	Right	402	400	45	85	140	4	15	58.4	
257-1784	Left	402	400	45	85	140	4	15	58.4	
307-1636	Center ARM	402	400	45	85	140	4	0	60.2	
307-1638	Right ARM	402	400	45	85	140	4	15	60.2	
307-1638	Left ARM	402	400	45	85	140	4	15	60.2	
109-9080	Center	342	420	45	85	140	3	0	48.2	
109-9081	Right	342	420	45	85	140	3	15	48.8	
109-9082	Left	342	420	45	85	140	3	15	48.8	
257-1817	Center	342	420	60	85	140	3	0	64.7	
257-1818	Right	342	420	60	85	140	3	15	66.4	
257-1819	Left	342	420	60	85	140	3	15	66.4	
275-5460	Center	410	495	60	90	180	4	0	85.0	
275-5461	Right	436	480	60	100	180	4	15	90.6	
275-5462	Left	436	480	60	100	180	4	15	90.6	
275-5470	Center	410	536	75	90	180	4	0	100.5	
275-5471	Right	451	536	75	100	180	4	15	110.2	
275-5472	Left	451	536	75	100	180	4	15	110.2	

Top Covers

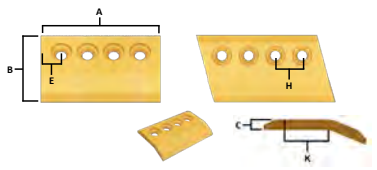
Part Number	Description	A (mm)	B (mm)	C (mm)	H (mm)	E (mm)	K (mm)	Number of Holes	Weight (kg)	Bevel	Notes
257-1778	Center	402	254	25	85	73.5	91.5	4	17.1	35	<p>Match dimensions A and H and the Number of Holes with the Half Arrows above to choose the correct Top Covers</p> 
257-1779	Right	402	254	25	85	73	91.5	4	17.1	35	
257-1781	Left	402	254	25	85	73	91.5	4	17.1	35	
233-7167	Center	342	254	25	85	86	91.5	3	14.8	35	
253-0191	Right	354	254	25	85	92	91.5	3	15.3	35	
253-0192	Left	354	254	25	85	92	91.5	3	15.3	35	
195-7180	Center	342	200	25.4	85	86	53	3	11.9	22.5	
195-7181	Right	354	200	25.4	85	92	53	3	12.4	22.5	
195-7182	Left	354	200	25.4	85	92	53	3	12.4	22.5	
195-7097	Right	451.4	254	25	100	75.7	78.5	4	19.3	22.5	
195-7098	Left	451.4	254	25	100	75.7	78.5	4	19.3	22.5	
307-5600	Center	410	330	29	90	70	104	4	26.7	35	
307-5601	Right	421	330	29	100	61	104	4	29.6	35	
307-5602	Left	421	330	29	100	61	104	4	29.6	35	

Segments

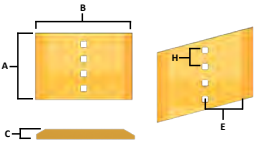
Description	Part Number	A (mm)	B (mm)	C (mm)	H (mm)	E (mm)	Number of Holes	Weight (kg)	Qty.	Nuts and Bolts	Notes
40mm Segments	4T-6760	410	590	40	90	295	4	68.0	1	Nut: 3K-9770 Bolt: 5P-8823	
	RH - 4T-6761	431	590	40	100	295	4	71.2	3		
	LH - 4T-6762	431	590	40	100	295	4	71.2	3		
40mm Segments	101-9435	342	482.5	40	85	240.5	3	48.5	1	Nut: 3K-9770 Bolt: 6V-6535	
	RH - 101-9436	354	482.5	40	85	240.5	3	50.4	3		
	LH - 101-9437	354	482.5	40	85	240.5	3	50.4	3		
40mm ARM Segments	138-0865	342	482.5	40	85	240.5	3	49.0	1	Nut: 3K-9770 Bolt: 6V-6535	
	RH - 138-0866	354	482.5	40	85	240.5	3	50.7	3		
	LH - 138-0867	354	482.5	40	85	240.5	3	50.7	3		
40mm Segments	315-0085	322	482.5	40	85	241.3	3	45.2	1	Nut: 3K-9770 Bolt: 6V-6535	
	RH - 315-0086	334	482.5	40	85	241.3	3	47.9	3		
	LH - 315-0087	334	482.5	40	85	241.3	3	47.9	3		
40mm ARM Segments	138-0861*	410	590	40	90	295	4	70.0	1	Nut: 3K-9770 Bolt: 6V-6535	
	RH - 138-0862*	431	590	40	100	295	4	74.8	3		
	LH - 138-0863*	431	590	40	100	295	4	74.8	3		
45mm Segments	315-0080	322	482.5	45	85	240.5	3	51.0	1	Nut: 3K-9770 Bolt: 6V-8360	
	RH - 315-0081	322	482.5	45	85	240.5	3	53.0	3		
	LH - 315-0082	322	482.5	45	85	240.5	3	53.0	3		
45mm Segments	107-3536	312	482.5	45	85	240.5	3	50.4	1	Nut: 3K-9770 Bolt: 6V-6535	
	RH - 107-3537	323	482.5	45	85	240.5	3	52.2	3		
	LH - 107-3538	323	482.5	45	85	240.5	3	52.2	3		





Cat Wheel Loaders

PART NUMBERS

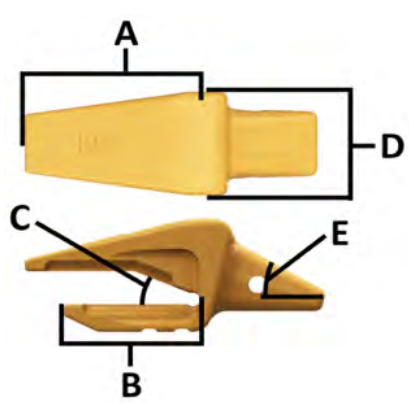
CapSure™ J600 Series

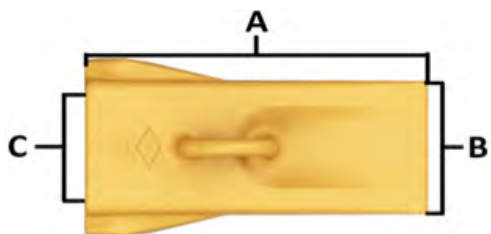
Machine Models: 990-992

Adapters										Notes 
Type	Part Number	Edge Thickness	A (mm)	B (mm)	C (deg)	D (mm)	E (deg)	Weight (kg)		
Center 2 Strap	143-3114	63.5	371	316	22.5	142	15	47.3		
RH 2 Strap	143-3115	63.5	371	316	22.5	142	15	47.4		
LH 2 Strap	143-3116	63.5	371	316	22.5	142	15	47.4		
Center 2 Strap Long Life (ARM)	186-5384*	63.5	371	316	22.5	142	15	47.6		
RH 2 Strap Long Life (ARM)	186-5385*	63.5	371	316	22.5	142	15	47.7		
LH 2 Strap Long Life (ARM)	186-5386*	63.5	371	316	22.5	142	15	47.7		
Center 2 Strap	119-8604	70	365	310	22.5	190	15	64.1		
RH 2 Strap	119-8605	70	365	310	22.5	190	15	64.1		
LH 2 Strap	119-8606	70	365	310	22.5	190	15	64.1		
Center 2 Strap Long Life (ARM)	119-8607	70	365	310	22.5	190	15	64.7		
RH 2 Strap Long Life (ARM)	119-8608	70	365	310	22.5	190	15	64.7		
LH 2 Strap Long Life (ARM)	119-8609	70	365	310	22.5	190	15	64.7		
Flushmount Center Adapter	119-9604	64-76	475	N/A	35	144	15	65.3		
Flushmount Corner Adapter	119-9605	64-76	403	N/A	35	144	15	63.5		

Tips							Notes 
Type	Part Number	Dimensions (mm)			Weight (kg)	Pin and Retainer	
		A	B	C			
	Heavy Abrasion 459-2186	408	230	143	56	Pin: 364-9751	
	Heavy Penetration 459-2184	445	44	143	57.7		
	Heavy Duty 459-2182	408	170	143	45.4		

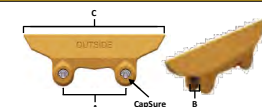
Wear Protection										Notes 
Type	Machine	Part Number	A (mm)	B (mm)	C (mm)	Weight (kg)	Pin	Retainer	Sheer Block	
Pin-On Sidebar Protector	990-992	112-2492	300	52	649.0	31.6	132-1008	132-0999	N/A	
Capsure Sidebar Protector		329-5946	294	53	598.0	23.9	329-5949	N/A	356-6432	
Pin-On Sidebar Protector		1U-0740	300	53	598.0	21.8	133-0738	107-8559	330-4456	

Shrouds										Notes 
Part Number	Description	A (mm)	B (mm)	C (mm)	D (mm)	E (deg)	Hole Spacing	Weight (kg)	Pins	
348-8583	Center (Set of 6)	470	470	61	72	35	270	119.5	352-7950	
348-8584	Right (Set of 6)	496	455	61	72	35	300	126.0	352-7950	
348-8585	Left (Set of 6)	496	455	61	72	35	300	126.0	352-7950	
351-2425	Right (Set of 8)	342	447	61	72	35	170	86.0	352-7950	
351-2426	Left (Set of 8)	342	447	61	72	35	170	86.0	352-7950	
346-7772	Center (Set of 7)	410	481	61	79	35	270	108.3	352-7950	
346-7774	Right (Set of 7)	436	455	61	79	35	300	115.1	352-7950	
346-7775	Left (Set of 7)	436	455	61	79	35	300	115.1	352-7950	

Wear Protection												
Half Arrows												
Part Number	Description	A (mm)	B (mm)	C (mm)	H (mm)	E (mm)	Number of Holes	Angle of Half Arrow	Weight (kg)	Notes		
109-9081	Right	342	420	45	85	140	3	15	48.8	<p>Half Arrow Dimensions</p>		
109-9082	Left	342	420	45	85	140	3	15	48.8			
264-2090	Center	470	495	60	90	180	4	0	91.7			
264-2091	Right	436	480	60	100	180	4	15	97.1			
264-2092	Left	436	480	60	100	180	4	15	97.1			
275-5460	Center	410	495	60	90	180	4	0	85.0			
275-5461	Right	436	480	60	100	180	4	15	90.6			
275-5462	Left	436	480	60	100	180	4	15	90.6			
275-6055	Center	390	536	75	90	180	4	0	96.0			
275-6056	Right	436	536	75	100	180	4	15	101.9			
275-6057	Left	436	536	75	100	180	4	15	101.9			
275-5470	Center	410	536	75	90	180	4	0	100.5			
275-5471	Right	451	536	75	100	180	4	15	110.2			
275-5472	Left	451	536	75	100	180	4	15	110.2			
Top Covers												
Part Number	Description	A (mm)	B (mm)	C (mm)	H (mm)	E (mm)	K (mm)	Number of Holes	Weight (kg)	Bevel	Notes	
235-8777	Right	354	254	25	85	92	80.5	3	24.8	35	<p>Match dimensions A and H and the Number of Holes with the Half Arrows above to choose the correct Top Covers</p>	
235-8778	Left	354	254	25	85	92	80.5	3	24.8	35		
253-0191	Left	354	254	25	85	92	91.5	3	24.8	35		
195-7096	Center	410	254	25	90	70	78.5	4	17.4	22.5		
195-7097	Right	451	254	25	100	75.7	78.5	4	19.3	22.5		
195-7098	Left	451	254	25	100	75.7	78.5	4	19.3	22.5		
335-7198*	Right	413	254	25	100	56.9	78.5	4	17.8	22.5		
335-7199*	Left	413	254	25	100	56.9	78.5	4	17.8	22.5		
208-5327	Center	410	330	35	90	70	128	4	32.8	35		
208-5328	Right	451	330	35	100	75.7	128	4	36.5	35		
208-5329	Left	451	330	35	100	75.7	128	4	36.5	35		
229-7045	Center	410	254	25	90	70	126.5	4	17.5	35		
229-7046	Right	451	254	25	100	75.7	126.5	4	19.5	35		
229-7047	Left	451	254	25	100	75.7	126.5	4	19.5	35		
195-7246	Center - ARM	410	254	25	90	70	126.5	4	17.4	35		
195-7247	Right - ARM	451	254	25	100	75.7	126.5	4	19.3	35		
195-7248	Left - ARM	451	254	25	100	75.7	126.5	4	19.3	35		
264-2096	Center	470	254	25	90	100		4	20.3	35		
264-2097	Right	513.5	254	25	100	106.8		4	22.4	35		
264-2098	Left	513.5	254	25	100	106.8		4	22.4	35		
Segments												
Description	Part Number	A (mm)	B (mm)	C (mm)	H (mm)	E (mm)	Number of Holes	Weight (kg)	Qty.	Nuts and Bolts		Notes
40mm Segments	4T-6760	410	590	40	90	295	4	68.0	1	Nut: 3K-9770 Bolt: 5P-8823		
	RH - 4T-6761	431	590	40	100	295	4	71.2	3			
	LH - 4T-6762	431	590	40	100	295	4	71.2	3			
50mm Segments	107-3530	410	590	50	90	295	4	84.3	1			
	RH - 107-3531	431	590	50	100	295	4	90.4	3			
	LH - 107-3532	431	590	50	100	295	4	90.4	3			
60mm Segments	107-6294	410	590	60	90	295	4	102.2	1			
	RH - 107-6295	431	590	60	100	295	4	107.5	3			
	LH - 107-6296	431	590	60	100	295	4	107.5	3			

Cat Wheel Loaders

PART NUMBERS

CapSure™ J700 Series

Machine Models: 993

Adapters									
Type	Part Number	Edge Thickness	A (mm)	B (mm)	C (deg)	D (mm)	E (deg)	Weight (kg)	Notes
Center 2 Strap	133-0704	70	365	310	22.5	190	15	68.0	
RH 2 Strap	133-0705	70	365	310	22.5	190	15	67.8	
LH 2 Strap	133-0706	70	365	310	22.5	190	15	67.8	
Center 2 Strap Long Life (ARM)	133-0707*	70	365	310	22.5	190	15	68.5	
RH 2 Strap Long Life (ARM)	133-0708*	70	365	310	22.5	190	15	68.5	
LH 2 Strap Long Life (ARM)	133-0709*	70	365	310	22.5	190	15	68.5	
Center 2 Strap	171-1704	76	435	335	22.5	154	15	73.2	
RH 2 Strap	171-1705	76	435	335	22.5	154	15	73.3	
LH 2 Strap	171-1706	76	435	335	22.5	154	15	73.3	
Center 2 Strap Long Life (ARM)	217-4706*	76	435	335	22.5	154	15	73.8	
RH 2 Strap Long Life (ARM)	217-4707*	76	435	335	22.5	154	15	73.9	
LH 2 Strap Long Life (ARM)	217-4708*	76	435	335	22.5	154	15	73.9	
Center 2 Strap	222-7700	90	464	314	35	190	8	84.1	

Tips							
Type	Part Number	Dimensions (mm)			Weight (kg)	Pin and Retainer	Notes
		A	B	C			
	Heavy Abrasion	455-1027	430	260	152	79.0	
	Heavy Penetration	455-1029	465	48	152	67.3	
	Heavy Duty	455-1031	430	188	152	60.3	

Wear Protection										
Type	Machine	Part Number	A (mm)	B (mm)	C (mm)	Weight (kg)	Pin	Retainer	Sheer Block	Notes
Capsure Sidebar Protector	993	329-5946	294	53	598.0	23.9	329-5949	N/A	356-6432	
Pin-On Sidebar Protector		1U-0740	294	53	598.0	21.8	133-0738	107-8559	330-4456	

Shrouds										
Part Number	Description	A (mm)	B (mm)	C (mm)	D (mm)	E (deg)	Hole Spacing	Weight (kg)	Pins	Notes
346-7776	Center	410	481	75	79	22.5	270	120.0	349-1160	
346-7777	Right	436	481	75	79	22.5	300	131.7	349-1160	
346-7778	Left	436	481	75	79	22.5	300	131.7	349-1160	
339-0310	Center	410	481	74	93	35	270	120.9	364-3032	
339-0311	Right	436	481	74	93	35	300	131.3	364-3032	
339-0312	Left	436	481	74	93	35	300	131.3	364-3032	







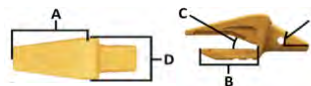

Wear Protection											
Half Arrows											
Part Number	Description	A (mm)	B (mm)	C (mm)	H (mm)	E (mm)	Number of Holes	Angle of Half Arrow	Weight (kg)	Notes	
275-5460	Center	410	495	60	90	180	4	0	85.0	<p>Half Arrow Dimensions</p>	
275-5461	Right	436	480	60	100	180	4	15	90.6		
275-5462	Left	436	480	60	100	180	4	15	90.6		
275-6055	Center	390	536	75	90	180	4	0	96.0		
275-6056	Right	436	536	75	100	180	4	15	101.9		
275-6057	Left	436	536	75	100	180	4	15	101.9		
275-5470	Center	410	536	75	90	180	4	0	100.5		
275-5471	Right	451	536	75	100	180	4	15	110.2		
275-5472	Left	451	536	75	100	180	4	15	110.2		
275-5938	Center - ARM	410	536	75	90	180	4	0	102.2		
275-5936	Right - ARM	451	536	75	100	180	4	15	112.0		
275-5937	Left - ARM	451	536	75	100	180	4	15	112.0		
109-9033	Center	622	621	75	85	270	5	0	222.1		
109-9031	Right	440	598	75	85	270	5	15	139.0		
109-9032	Left	440	598	75	85	270	5	15	139.0		
Top Covers											
Part Number	Description	A (mm)	B (mm)	C (mm)	H (mm)	E (mm)	K (mm)	Number of Holes	Weight (kg)	Bevel	Notes
195-7096	Center	410	254	25	90	70	78.5	4	17.4	22.5	<p>Match dimensions A and H and the Number of Holes with the Half Arrows above to choose the correct Top Covers</p>
195-7097	Right	451	254	25	100	75.7	78.5	4	19.3	22.5	
195-7098	Left	451	254	25	100	75.7	78.5	4	19.3	22.5	
292-9462	Center	410	254	25	90	70	50	4	17.8	22.5	
292-9463	Right	451	254	25	100	75.7	50	4	19.4	22.5	
292-9464	Left	451	254	25	100	75.7	50	4	19.4	22.5	
294-8883	Center - ARM	410	254	25	90	70	50	4	19.2	22.5	
294-8884	Right - ARM	451	254	25	100	75.7	50	4	21.2	22.5	
294-8885	Left - ARM	451	254	25	100	75.7	50	4	21.2	22.5	
335-7198*	Right	413	254	25	100	56.9	78.5	4	17.8	22.5	
335-7199*	Left	413	254	25	100	56.9	78.5	4	17.8	22.5	
307-5600	Center	410	330	29	90	70	104	4	26.7	35	
307-5601	Right	421	330	29	100	61	104	4	29.6	35	
307-5602	Left	421	330	29	100	61	104	4	29.6	35	
395-3306	Center - ARM	410	330	29	90	70	104	4	27.8	35	
395-3307	Right - ARM	421	330	29	100	61	104	4	30.1	35	
395-3308	Left - ARM	421	330	29	100	61	104	4	30.1	35	
208-5327	Center	410	330	35	90	70	128	4	32.8	35	
208-5328	Right	451	330	35	100	75.7	128	4	36.5	35	
208-5329	Left	451	330	35	100	75.7	128	4	36.5	35	
Segments											
Description	Part Number	A (mm)	B (mm)	C (mm)	H (mm)	E (mm)	Number of Holes	Weight (kg)	Qty.	Nuts and Bolts	Notes
40mm Segments	4T-6760	410	590	40	90	295	4	68.0	1	Nut: 3K-9770 Bolt: 5P-8823	
	RH - 4T-6761	431	590	40	100	295	4	71.2	3		
	LH - 4T-6762	431	590	40	100	295	4	71.2	3		
50mm Segments	107-3530	410	590	50	90	295	4	84.3	1		
	RH - 107-3531	431	590	50	100	295	4	90.4	3		
	LH - 107-3532	431	590	50	100	295	4	90.4	3		
60mm Segments	107-6294	410	590	60	90	295	4	102.2	1		
	RH - 107-6295	431	590	60	100	295	4	107.5	3		
	LH - 107-6296	431	590	60	100	295	4	107.5	3		

Cat Wheel Loaders

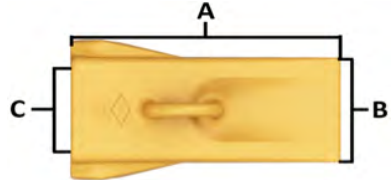
PART NUMBERS

CapSure™ J800 Series

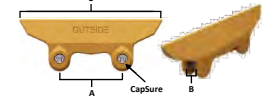
Machine Models: 994

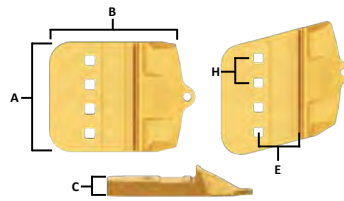
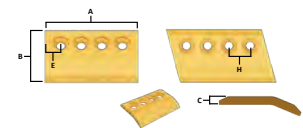
Adapters										
Type	Part Number	Edge Thickness	A (mm)	B (mm)	C (deg)	D (mm)	E (deg)	Weight (kg)	Notes	
Center 2 Strap	61-8804	100	435	335	22.5	220	16	110.2		
Tips										
Type	Part Number	Dimensions (mm)			Weight (kg)	Pin and Retainer	Notes			
		A	B	C						
	Heavy Abrasion 444-7594	475	296	180	111.1	Pin: 310-2788				
	Heavy Penetration 444-7577	505	196	180	96.4					
	Heavy Duty 453-3648	475	219	180	91.2					
Wear Protection										
Type	Machine	Part Number	A (mm)	B (mm)	Weight (kg)	Pin	Retainer	Shear Block	Notes	
Straight MAWPS Sidebar Protector	994	481-1104	567	67	37.63	N/A	138-0007	481-1105		
Type	Machine	Part Number	A (mm)	B (mm)	C (mm)	Weight (kg)	Pin	Retainer	Shear Block	Notes
Pin-On Sidebar Protector	994	125-0800	600	67	998.0	57.15	8E-4708	4T-4707	330-4455	
Capsure Sidebar Protector RH		304-5853	600	67	816.4	65.46	304-5849	N/A	356-6435	
Capsure Sidebar Protector LH		304-5854	600	67	816.4	65.46	304-5849	N/A	356-6435	
Shrouds										
Part Number	Description	A (mm)	B (mm)	C (mm)	D (mm)	E (deg)	Hole Spacing	Weight (kg)	Pins	Notes
326-5216	Center	440	553	71	100	22.5	170	224	323-1842	
311-6933	Center	622	553	71	100	22.5	170	160	323-1842	
324-6147	Right	435	440	71	100	22.5	170	167	321-1842	
323-3151	Left	435	440	71	100	22.5	170	167	321-1842	
Half Arrows										
Part Number	Description	A (mm)	B (mm)	C (mm)	H (mm)	E (mm)	Number of Holes	Angle of Half Arrow	Weight (kg)	Notes
347-7256	Center	330	593	75	85	270	3	0	113.6	
109-9030	Center	440	593	75	85	270	5	0	148.8	
109-9031	Right	440	598	75	85	270	5	15	153.5	
109-9032	Left	440	598	75	85	270	5	15	153.5	
117-6805	Right	442	627	75	85	260	5	15	157.3	
117-6806	Left	442	627	75	85	260	5	15	157.3	
109-9033	Center	622	621	75	85	270	5	0	222.1	
Top Covers										
Part Number	Description	A (mm)	B (mm)	C (mm)	H (mm)	E (mm)	Number of Holes	Weight (kg)	Bevel	Notes
195-7230	Center	440	336	35	85	50	5	36.6	22.5	<p>Match dimensions A and H and the Number of Holes with the Half Arrows above to choose the correct Top Covers</p> 
195-7231	Right	474.2	360	35	85	61	5	39.1	22.5	
195-7232	Left	474.2	360	35	85	61	5	39.1	22.5	
229-6596	Center	644	336	35	85	152	5	54.2	22.5	

Cat Wheel Loaders

OPTIONS

J SERIES TIP OPTIONS

Below are the tip shapes best suited for the wide range of jobsite conditions performed by wheel loaders. We offer additional J Series tips more commonly used with excavators. Your Cat dealer can help you choose the one that offers the right balance of penetration and wear life for your application.

<p style="writing-mode: vertical-rl; transform: rotate(180deg);">ABRASION ↑</p> <p style="writing-mode: vertical-rl; transform: rotate(180deg);">IMPACT ↓</p>	<p>HEAVY DUTY ABRASION</p> 	<p>Heavy Duty Abrasion tips are ideal for high-abrasion applications like sand, gravel and shot rock. They feature the maximum amount of wear material—approximately 145% more—and the tip base has 35% more surface area than Heavy Duty Penetration tips.</p>
	<p>HEAVY PENETRATION</p> 	<p>Heavy Penetration tips are ideal for high-impact, hard-to-penetrate materials. They feature approximately 120% more material in the high wear area, and the spade design has 70% less edge area than Heavy Duty Abrasion tips.</p>
	<p>HEAVY DUTY LONG A.R.M. OPTION AVAILABLE</p> 	<p>Heavy Duty Long and Heavy Duty Abrasion Resistant Material (A.R.M.)* tips include approximately 60% more wear material in the tip body. The A.R.M. wears around the profile to increase penetration.</p>
	<p>LONG (GENERAL PURPOSE)</p> 	<p>Long tips are symmetrical and the baseline for other tip styles. All wear comparisons are to the Long tip unless otherwise noted.</p>
	<p>PENETRATION PLUS</p> 	<p>Penetration Plus tips feature 30% more wear material and 25% less cross-sectional area. They self-sharpen as they wear.</p>
	<p>PENETRATION A.R.M. OPTION AVAILABLE</p> 	<p>Penetration and Penetration A.R.M.* tips are ideal for densely compacted materials. They feature a leading edge with approximately 50% less cross-sectional area and a single center rib for strength—allowing for maximum penetration.</p>
	<p>ROCK CHISEL</p> 	<p>Rock Chisel tips are Heavy Duty Long tips ideal for high-impact and high-abrasion applications, such as granite. Additional length and wear material in the body helps retain the chisel shape throughout tip life.</p>







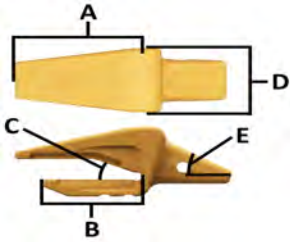

*Abrasion Resistant Material (A.R.M.) is a welding process that bonds very hard tungsten carbide particles to Cat G.E.T. to create a protective shield over the component. Typically, the A.R.M. process doubles wear life—and can last even longer in some applications.

Cat Wheel Loaders

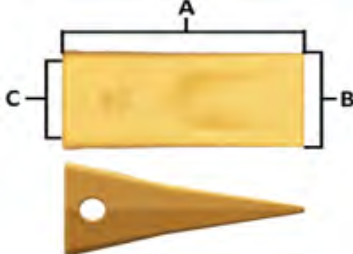
PART NUMBERS

J Series J300

Machine Models: 950

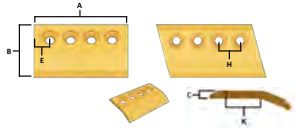
Adapters											
Type	Part Number	Edge Thickness	A (mm)	B (mm)	C (deg)	D (mm)	E (deg)	Weight (kg)	Notes		
Center Bolt On Adapter	1U-0307	25	230	230	22.5	100	14	11.8			
Center Bolt On Adapter	3G-5307	32	266	266	22.5	146	14	13.2			
Center Bolt On Adapter	3G-9307	32	295	295	22.5	112	14	13.2			
Center Bolt On Adapter	4T-4307	32	283	283	22.5	108	14	12.4			
RH Bolt On Corner Adapter	8E-5309	25-32	N/A	211	22.5	N/A	14	16.9			
LH Bolt On Corner Adapter	8E-5308	25-32	N/A	211	22.5	N/A	14	16.9			
Corner Guard Single Bolt - RH	3G-8309	32	N/A	206	22.5	N/A	14	15.9			
Corner Guard Single Bolt - LH	3G-8308	32	N/A	206	22.5	N/A	14	15.9			
Corner Guard Single Bolt - RH	3G-4309	25-32	N/A	211	22.5	N/A	14	15.3			
Corner Guard Single Bolt - LH	3G-4308	25-32	N/A	211	22.5	N/A	14	15.3			
Flushmount Adapter	1U-1304	25-38	238	N/A	22.5	70	14	8.2			
Bottom Strap Adapter	9J-8929	25-32	N/A	200	22.5	70	14	7.9			
Tips											
Type	Part Number	Dimensions (mm)			Weight (kg)	Pin and Retainer	Notes				
		A	B	C							
	Heavy Abrasion 9N-4303	223	110	65	6.8	Pin: 132-4766 Retainer: 149-5733					
	Heavy Penetration 135-9300	260	77	65	9.1						
	Heavy Duty 9N-4302	223	74	65	5.5						
	General Purpose 1U-3302	215	80	65	5.3						
Specialty											
	Heavy Duty Long Life (ARM) 125-8302	223	74	65	7.4	Pin: 132-4766 Retainer: 149-5733	The black areas in the pictures of the tips is where the ARM will be applied.				
Wear Protection											
Type	Machine	Part Number	A (mm)	B (mm)	Weight (kg)	Retainer	Base Plate	Notes			
Straight MAWPS Sidebar Protector	950, 962	498-3443	588	25	18.68	138-0006	463-1401				
Curved MAWPS Sidebar Protector		433-9831	602	25	18.28	138-0006	463-1401				
Curved MAWPS Sidebar Protector		433-9830	604	22	17.34	138-0006	463-1401				
Segments											
Description	Part Number	A (mm)	B (mm)	C (mm)	H (mm)	E (mm)	Number of Holes	Weight (kg)	Qty.	Nuts and Bolts	Notes
25mm Segments	4T-6694	225	280	25	155	139	2	10.8	5	Nut: 2J-3507 Bolt: 4F-4042	
	264-6233	220	280	25	155	139	2	10.2	2		
30mm Segments	140-7601	291	360	30	208	179	2	21.8	5		
	263-7545	268	360	30	208	179	2	19.9	2		
35mm Segments	132-4715	278	305	35	208	152	2	21.9	5		
	257-1726	258	305	35	208	152	2	17.5	2		

Cat Wheel Loaders

PART NUMBERS

J Series J350

Machine Models: 966-972

Adapters										
Type	Part Number	Edge Thickness	A (mm)	B (mm)	C (deg)	D (mm)	E (deg)	Weight (kg)	Notes	
Center 2 Strap	135-9354	40	235	170	22.5	104	14	14.8		
RH 2 Strap	135-9355	40	235	170	22.5	104	14	14.8		
LH 2 Strap	135-9356	40	235	170	22.5	104	14	14.8		
Center 2 Strap	113-0354	45	235	170	22.5	104	14	14.4		
RH 2 Strap	113-0355	45	235	170	22.5	104	14	14.4		
LH 2 Strap	113-0356	45	235	170	22.5	104	14	14.4		
Center Bolt On Adapter	3G-7357*	32	285	285	22.5	130	14	18.7		
Center Bolt On Adapter	170-0073	32	311	311	22.5	130	14	18.5		
Center Bolt On Adapter	3G-3357	40	302	302	22.5	130	14	18.5		
Center Bolt On Adapter	1U-1357	45	331	331	22.5	130	14	18.4		
Center Bolt On Adapter	3G-2357	45	296	296	22.5	154	14	20.4		
RH Bolt On Corner Adapter	8E-5359	32-40	N/A	245	22.5	115	14	20.9		
LH Bolt On Corner Adapter	8E-5358	32-40	N/A	245	22.5	115	14	20.9		
Corner Guard Single Bolt - RH	1U-1359	45	N/A	240	22.5	120	14	24.7		
Corner Guard Single Bolt - LH	1U-1358	45	N/A	240	22.5	120	14	24.7		
Corner Guard Single Bolt - RH	3G-5359	32-38	N/A	244	22.5	120	14	20.9		
Corner Guard Single Bolt - LH	3G-5358	32-38	N/A	244	22.5	120	14	20.9		
Flushmount Center Adapter	1U-1354	32-45	284	N/A	22.5	96	14	12.2		
Flushmount Corner Adapter - RH	1U-1355	32-45	285	N/A	22.5	96	14	16.8		
Flushmount Corner Adapter - LH	1U-1356	32-45	286	N/A	22.5	96	14	16.8		
Bottom Strap Center Adapter	1U-1350	32-45	N/A	247	22.5	78	14	12.2		
Bottom Strap Corner Adapter - RH	1U-1351	32-45	N/A	263	22.5	76	14	10.4		
Bottom Strap Corner Adapter - LH	1U-1352	32-45	N/A	263	22.5	76	14	10.4		
Tips										
Type	Part Number	Dimensions (mm)			Weight (kg)	Pin and Retainer	Notes			
	9N-4353	A	B	C	10.7	Pin: 114-0358 Retainer: 114-0359				
	144-1358	251	126	80	10.9					
	9N-4352	286	82	80	7.5					
	1U-3352	251	87	80	6.6					
	135-9352	251	87	80	16.7	Pin: 114-0358 Retainer: 114-0359	The black areas in the pictures of the tips is where the ARM will be applied.			
Wear Protection										
Type	Machine	Part Number	A (mm)	B (mm)	C (mm)	Weight (kg)	Pin	Retainer	Base Plate	Notes
Straight MAWPS Sidebar Protector	966-972	498-3443	588	25	N/A	18.68	N/A	138-0006	463-1401	
Curved MAWPS Sidebar Protector		433-9831	602	25	N/A	18.28	N/A	138-0006	463-1401	
Sidebar Protector Center	966-972	135-8246	238	28	466.4	10.43	135-9292	114-0359	N/A	

Wear Protection											
Half Arrows											
Part Number	Description	A (mm)	B (mm)	C (mm)	H (mm)	E (mm)	Number of Holes	Angle of Half Arrow	Weight (kg)	Notes	
313-5550	Center	290	315	30	203	98	2	0	20		
313-5548	Center	270	315	30	180	98	2	0	20		
135-9544	Center	300	400	41	120	127	2	0	35		
135-9545	Right Hand	315	400	41	200	127	2	15	39		
135-9546	Left Hand	315	400	41	200	127	2	15	39		
Top Covers											
Part Number	Description	A (mm)	B (mm)	C (mm)	H (mm)	E (mm)	K (mm)	Number of Holes	Weight (kg)	Bevel	Notes
195-7230	Center	440	360	35	85	50	89	5	35	22.5	
195-7231	Right Hand	484	360	35	85	N/A	89	5	38	22.5	
195-7232	Left Hand	484	360	35	85	N/A	89	5	38	22.5	
229-6596	Center	644	348	35	85	152	89	5	54	22.5	
Segments											
Description	Part Number	A (mm)	B (mm)	C (mm)	H (mm)	E (mm)	Number of Holes	Weight (kg)	Qty.	Nuts and Bolts	Notes
30mm Segments	100-6666	293	360	30	203	179	2	21.2	5	Nut: 3K-9770 Bolt: 5P-8823	
	308-4322	283	360	30	203	179	2	20.6	2		
30mm Segments	4T-6699	270	360	30	180	179	2	20.0	5		
	308-3054	260	360	30	180	179	2	18.9	2		
30mm Segments	4T6698	240	360	30	140	179	2	17.8	5		
	308-4323	230	360	30	140	179	2	16.6	2		
30mm Segments	196-2894*	263	360	30	180	179	2	19.1	5		
	275-7647*	240	360	30	180	179	2	17.8	2		
35mm Segments	140-6870	293	360	35	203	179	2	25.0	5		
	310-4067	273	360	35	203	179	2	24.1	2		
35mm Segments	140-6868	270	360	35	180	179	2	23.0	5		
	310-4064*	255	360	35	180	179	2	22.0	2		
40mm Segments	135-9294	300	330	40	120	164	2	29.0	1	Nut: 3K-9770 Bolt: 8T-9079	
	RH-135-9295	315	330	40	201	164	2	30.4	3		
	LH-135-9296	315	330	40	201	164	2	30.4	3		

Cat Wheel Loaders

PART NUMBERS

J Series J400

Machine Models: 980-982

Adapters											
Type	Part Number	Edge Thickness	A (mm)	B (mm)	C (deg)	D (mm)	E (deg)	Weight (kg)	Notes		
Center 2 Strap	125-8404	45	240	160	22.5	124	14	18.2			
RH 2 Strap	125-8405	45	240	160	22.5	124	14	18.5			
LH 2 Strap	125-8406	45	240	160	22.5	124	14	18.5			
Center 2 Strap Long Life (ARM)	125-8407	45	240	160	22.5	124	14	18.8			
RH 2 Strap Long Life (ARM)	125-8408	45	240	160	22.5	124	14	18.6			
LH 2 Strap Long Life (ARM)	125-8409	45	240	160	22.5	124	14	18.6			
Center Bolt On Adapter	61-9898	45	301	301	22.5	130	14	25.5			
RH Bolt On Corner Adapter	61-8243	45	N/A	229	22.5	N/A	14	25.0			
LH Bolt On Corner Adapter	61-8244	45	N/A	229	22.5	N/A	15	25.0			
Flushmount Center Adapter	107-3404	38-51	290	N/A	22.5	90	15	20.5			
Tips											
Type	Part Number	Dimensions (mm)			Weight (kg)	Pin and Retainer					
		A	B	C							
	Heavy Abrasion	7T-3403	270	144	86	14.5	Pin: 116-7408 Retainer: 116-7409				
	Heavy Penetration	135-9400	312	100	86	15.9					
	Heavy Duty	8E-4402	277	102	86	10.7					
	General Purpose	7T-3401	235	103	86	8.5					
Specialty											
	Heavy Duty Long Life (ARM)	116-7402	277	102	86	11.4	Pin: 116-7408 Retainer: 116-7409	The black areas in the pictures of the tips is where the ARM will be applied.			
Wear Protection											
Type	Machine	Part Number	A (mm)	B (mm)	C (mm)	Weight (kg)	Pin	Retainer	Base Plate	Notes	
Straight MAWPS Sidebar Protector	980-982	498-3443	588	25	N/A	18.7	N/A	138-0006	463-1401		
Curved MAWPS Sidebar Protector		433-9831	602	25	N/A	18.3	N/A	138-0006	463-1401		
Curved MAWPS Sidebar Protector		433-9832	610	30	N/A	19.4	N/A	138-0006	463-1401		
Straight MAWPS Sidebar Protector		486-9066	512	30	N/A	15.8	N/A	138-0006	463-1401		
Straight MAWPS Sidebar Protector		486-9068	660	30	N/A	19.5	N/A	138-0006	463-1401		
Sidebar Protector Center	980-982	135-8246	238	25	466.4	10.9	135-9292	114-0359	N/A		
Sidebar Protector Center		329-5958	200	30	466.7	17.4	275-5982	132-0999	N/A		
Sidebar Protector Center		9J-9600	254	30	578.0	16.8	135-9350	114-0359	N/A		







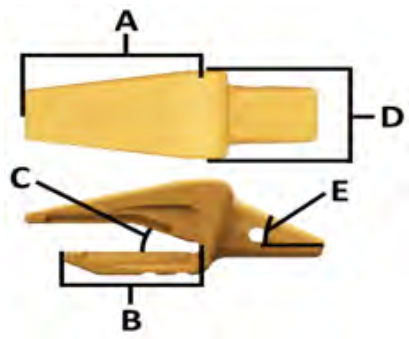

Wear Protection												
Half Arrows												
Part Number	Description	A (mm)	B (mm)	C (mm)	H (mm)	E (mm)	Number of Holes	Angle of Half Arrow	Weight (kg)	Notes		
174-4115	Center	315	315	30	185	102	2	0	21.6			
173-7447	Center	290	315	30	160	102	2	0	19.8			
116-7460	Center	312	435	45	85	140	3	0	43.8			
116-7461	Right	312	435	45	85	140	3	15	44.3			
116-7462	Left	312	435	45	85	140	3	15	44.3			
Top Covers												
Part Number	Description	A (mm)	B (mm)	C (mm)	H (mm)	E (mm)	K (mm)	Number of Holes	Weight (kg)	Bevel	Notes	
286-2141	Right	323	203	12	85	86	66.5	3	5.7	22.5		
286-2142	Left	323	203	12	85	86	66.5	3	5.7	22.5		
286-2143	Center	323	203	12	85	86	66.5	3	5.7	22.5		
286-2051	Center	315	203	12	185	65	32	2	5.7	22.5		
Segments												
Description	Part Number	A (mm)	B (mm)	C (mm)	H (mm)	E (mm)	Number of Holes	Weight (kg)	Qty.	Nuts and Bolts	Notes	
30mm Segments	109-9019	315	360	30	185	179	2	23.5	7		Nut: 3K-9770 Bolt: 5P-8823	
30mm Segments	4T-6700	290	360	30	160	179	2	21.5	5			
	308-4327	275	360	30	160	179	2	20.1	2			
35mm Segments	9W-5734	312	482.5	35	85	240.5	3	38.3	1			Nut: 3K-9770 Bolt: 8T-9079
	RH - 9W-5737	323	482.5	35	85	240.5	3	38.3	3			
	LH - 9W-5730	323	482.5	35	85	240.5	3	38.3	3			
35mm ARM Segments	339-9800*	312	482.5	35	85	240.5	3	39.7	1			Nut: 3K-9770 Bolt: 6V-6535
	RH - 138-6471	323	482.5	35	85	240.5	3	40.3	3			
	LH - 138-6472	323	482.5	35	85	240.5	3	40.3	3			
35mm ARM Segments	208-5284	312	482.5	35	85	240.5	3	39.5	1			
	RH - 138-6471	323	482.5	35	85	240.5	3	40.3	3			
	LH - 138-6472	323	482.5	35	85	240.5	3	40.3	3			
45mm Segments	107-8580	290	360	45	160	179	2	32.7	7	Nut: 3K-9770 Bolt: 5P-8823		
45mm Segments	135-8219	315	330	45	185	164	2	34.3	7			
45mm Segments	107-3490	312	482.5	45	85	240.5	3	50.4	1	Nut: 3K-9770 Bolt: 8T-9079		
	RH - 107-3491	323	482.5	45	85	240.5	3	52.2	3			
	LH - 107-3492	323	482.5	45	85	240.5	3	52.2	3			

Cat Wheel Loaders

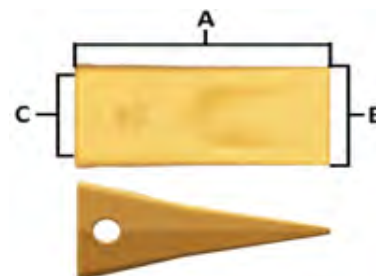
PART NUMBERS

J Series J450

Machine Models: 986-988

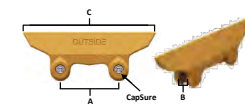
Adapters										
Type	Part Number	Edge Thickness	A (mm)	B (mm)	C (deg)	D (mm)	E (deg)	Weight (kg)	Notes	
Center 2 Strap	8E-2164	45	290	180	22.5	100	14	23.5		
RH 2 Strap	8E-2165	45	290	180	22.5	100	14	23.5		
LH 2 Strap	8E-2166	45	290	180	22.5	100	14	23.5		
Center 2 Strap	114-0464	51	273	163	22.5	123	14	20.0		
RH 2 Strap	114-0465	51	300	210	22.5	123	14	21.5		
LH 2 Strap	114-0466	51	300	210	22.5	123	14	21.5		
Center 2 Strap Long Life (ARM)	116-7464	51	273	163	22.5	123	14	20.0		
RH 2 Strap Long Life (ARM)	116-7465	51	300	210	22.5	123	14	21.5		
LH 2 Strap Long Life (ARM)	116-7466	51	300	210	22.5	123	14	21.5		
Center Bolt On Adapter	8E-3467*	38	290	290	22.5	130	14	23.1		
Corner Guard Single Bolt - RH	8E-3468*	38	N/A	244	22.5	N/A	14	30.1		
Corner Guard Single Bolt - LH	8E-3469	38	N/A	244	22.5	N/A	14	30.1		
Center Bolt On Adapter	8E-2467	45	301	301	22.5	130	14	25.3		
Corner Guard Single Bolt - RH	8E-2468	45	N/A	240	22.5	N/A	14	31.2		
Corner Guard Single Bolt - LH	8E-2469	45	N/A	240	22.5	N/A	14	31.2		
RH Bolt On Corner Adapter	6I-8299	50	N/A	244	22.5	N/A	14	38.7		
LH Bolt On Corner Adapter	6I-8298	50	N/A	244	22.5	N/A	14	38.7		
Flushmount Center Adapter	8E-0464	45-51	286	N/A	22.5	100	14	21.6		
Flushmount Corner Adapter - RH	8E-0465	45-51	300	N/A	22.5	100	14	21.2		
Flushmount Corner Adapter - LH	8E-0466	45-51	300	N/A	22.5	100	14	21.2		
Bottom Strap Center Adapter	8E-5464	45-57	N/A	301	22.5	130	14	29.5		
Bottom Strap Corner Adapter - RH	8E-5465*	45-57	N/A	301	22.5	130	14	29.5		
Bottom Strap Corner Adapter - LH	8E-5466*	45-57	N/A	301	22.5	130	14	29.5		
Tips										
Type	Part Number	Dimensions (mm)			Weight (kg)	Pin and Retainer	Notes			
	Heavy Abrasion	9N-4453	309	166	97	21.8	Pin: 114-0468 Retainer: 107-3469			
	Heavy Penetration	138-6451	341	120	97	22.4				
	Heavy Duty	9N-4452	306	115	97	16.3				
	General Purpose	9W-8452	291	124	97	12.7				
Specialty										
	Heavy Duty Long Life (ARM)	101-9054	306	115	97	16.4	Pin: 114-0468 Retainer: 107-3469	The black areas in the pictures of the tips is where the ARM will be applied.		
Wear Protection										
Type	Machine	Part Number	A (mm)	B (mm)	Weight (kg)	Pin	Retainer	Base Plate	Notes	
Straight MAWPS Sidebar Protector	986-988	498-3443	588	25	18.7	N/A	138-0006	463-1401		
Straight MAWPS Sidebar Protector		486-9066	512	30	15.8	N/A	138-0006	463-1401		
Straight MAWPS Sidebar Protector		486-9068	660	30	19.5	N/A	138-0006	463-1401		
Type	Machine	Part Number	A (mm)	B (mm)	C (mm)	Weight (kg)	Pin	Retainer	Shear Block	Notes
Sidebar Protector Center	986-989	329-5954	254	36	578.0	22.4	329-5953	N/A	356-6433	
Sidebar Protector Center		329-5958	200	30	466.7	17.4	275-5982	132-0999	N/A	
Sidebar Protector Center		9J-9600	254	30	578.0	16.8	135-9350	114-0359	N/A	

Wear Protection														
Half Arrows														
Part Number	Description	A (mm)	B (mm)	C (mm)	H (mm)	E (mm)	Number of Holes	Angle of Half Arrow	Weight (kg)	Notes				
288-8218*	Center	395	254	40	N/A	N/A	N/A	0	35.0					
292-9465*	Right	352	254	40	N/A	N/A	N/A	22	31.1					
292-9466*	Left	352	254	40	N/A	N/A	N/A	23	31.1					
116-7460	Center	312	435	45	85	140	3	0	43.8					
116-7461	Right	312	435	45	85	140	3	15	44.3					
116-7462	Left	312	435	45	85	140	3	15	44.3					
109-9080	Center	342	420	45	85	140	3	0	48.2					
109-9081	Right	342	420	45	85	140	3	15	48.8					
109-9082	Left	342	420	45	85	140	3	15	48.8					
257-1817	Center	342	420	60	85	140	3	0	64.7					
257-1818	Right	342	420	60	85	140	3	15	66.4					
257-1819	Left	342	420	60	85	140	3	15	66.4					
257-1817	Center	342	435	60	85	140	3	0	64.7					
257-1818	Right	342	435	60	85	140	3	15	66.4					
257-1819	Left	342	435	60	85	140	3	15	66.4					
Top Covers														
Part Number	Description	A (mm)	B (mm)	C (mm)	H (mm)	E (mm)	K (mm)	Number of Holes	Weight (kg)	Bevel	Notes			
195-7180	Center	342	200	25.4	85	86	53	3	11.9	22.5				
195-7181	Right	354	200	25.4	85	92	53	3	12.4	22.5				
195-7182	Left	354	200	25.4	85	92	53	3	12.4	22.5				
Segments														
Description	Part Number	A (mm)	B (mm)	C (mm)	H (mm)	E (mm)	Number of Holes	Weight (kg)	Qty.	Nuts and Bolts	Notes			
35mm Segments	9W-5734	312	482.5	35	85	240.5	3	38.3	1		Nut: 3K-9770 Bolt: 8T-9079			
	RH - 9W-5737	323	482.5	35	85	240.5	3	38.3	3					
	LH - 9W-5730	323	482.5	35	85	240.5	3	38.3	3					
40mm Segments	101-9435	342	482.5	40	85	240.5	3	48.5	1			Nut: 3K-9770 Bolt: 6V-6535		
	RH - 101-9436	354	482.5	40	85	240.5	3	50.4	3					
	LH - 101-9437	354	482.5	40	85	240.5	3	50.4	3					
40mm ARM Segments	138-0865	342	482.5	40	85	240.5	3	49.0	1				Nut: 3K-9770 Bolt: 6V-6535	
	RH - 138-0866	354	482.5	40	85	240.5	3	50.7	3					
	LH - 138-0867	354	482.5	40	85	240.5	3	50.7	3					
45mm Segments	208-5260	373	330	45	265	165	2	40.9	7					Nut: 3K-9770 Bolt: 6V-8360
45mm Segments	107-3490	312	482.5	45	85	240.5	3	50.4	1					
	RH - 107-3491	323	482.5	45	85	240.5	3	52.2	3					
	LH - 107-3492	323	482.5	45	85	240.5	3	52.2	3					
45mm Segment	183-5324	350	330	45	241	165	2	38.2	7					
45mm Segments	107-3536	312	482.5	45	85	240.5	3	50.4	1					
	RH - 107-3537	323	482.5	45	85	240.5	3	52.2	3					
	LH - 107-3538	323	482.5	45	85	240.5	3	52.2	3					

Cat Wheel Loaders

PART NUMBERS

J Series J550

Machine Models: 988-990

Adapters										
Type	Part Number	Edge Thickness	A (mm)	B (mm)	C (deg)	D (mm)	E (deg)	Weight (kg)	Notes	
Center 2 Strap	138-6554	51	258	198	22.5	174	15	40.5		
RH 2 Strap	138-6555	51	253	193	22.5	174	15	40.5		
LH 2 Strap	138-6556	51	253	193	22.5	174	15	40.5		
Center 2 Strap Long Life (ARM)	159-0554	51	258	198	22.5	174	15	40.8		
RH 2 Strap Long Life (ARM)	159-0555*	51	253	193	22.5	174	15	40.8		
LH 2 Strap Long Life (ARM)	159-0556*	51	253	193	22.5	174	15	40.8		
Center 2 Strap	107-3554	63.5	356	316	22.5	160	15	36.8		
RH 2 Strap	107-3555	63.5	356	316	22.5	160	15	37.9		
LH 2 Strap	107-3556	63.5	356	316	22.5	160	15	37.9		
Center 2 Strap Long Life (ARM)	112-2554	63.5	356	316	22.5	160	15	43.0		
RH 2 Strap Long Life (ARM)	112-2555	63.5	356	316	22.5	160	15	43.0		
LH 2 Strap Long Life (ARM)	112-2556	63.5	356	316	22.5	160	15	43.0		
Flushmount Center Adapter	3G-4554	51-64	378	N/A	22.5	118	15	34.0		
Flushmount Corner Adapter - RH	3G-4555	51-64	381	N/A	22.5	118	15	35.0		
Flushmount Corner Adapter - LH	3G-4556	51-64	381	N/A	22.5	118	15	35.0		
Flushmount Center Adapter	186-3294	63.5	412	N/A	35	120	15	51.8		
Bottom Strap Center Adapter	9J-3662*	51-64	N/A	381	22.5	160	15	51.5		
Bottom Strap Corner Adapter - RH	9J-3663*	51-64	N/A	381	22.5	160	15	51.8		
Bottom Strap Corner Adapter - LH	9J-3664*	51-64	N/A	381	22.5	160	15	51.8		
Tips										
Type	Part Number	Dimensions (mm)			Weight (kg)	Pin and Retainer	Notes			
	6Y-2553	A	B	C	32.3	Pin: 107-3378 Retainer: 107-8559				
	138-6552	347	192	118	29.4					
	9N-4552	380	130	118	25.4					
	9W-8552	347	145	118	16.6					
	101-9055	347	145	118	25.9	Pin: 107-3378 Retainer: 107-8559	The black areas in the pictures of the tips is where the ARM will be applied.			
Wear Protection										
Type	Machine	Part Number	A (mm)	B (mm)	Weight (kg)	Pin	Retainer	Base Plate	Notes	
Straight MAWPS Sidebar Protector	988-990	486-9066	512	30	15.8	N/A	138-0006	463-1401		
Straight MAWPS Sidebar Protector		486-9068	660	30	19.5	N/A	138-0006	463-1401		
Type	Machine	Part Number	A (mm)	B (mm)	C (mm)	Weight (kg)	Pin	Retainer	Shear Block	Notes
Capsure Sidebar Protector	988-990	329-5954	254	36	578.0	22.4	329-5953	N/A	356-6433	
Pin-On Sidebar Protector		9J-9600	254	33	578.0	16.8	135-9350	114-0359	331-7417	
Pin-On Sidebar Protector		166-2877	456	38	468.0	18.2	132-0998	132-0999	N/A	
Capsure Sidebar Protector		329-5946	294	53	598.0	23.9	329-5949	N/A	356-6432	
Pin-On Sidebar Protector		1U-0740	294	53	598.0	21.8	133-0738	107-8559	330-4456	
LH Weld On Sidebar Protector		454-8931	1385	N/A	1385.0	115.4	N/A	N/A	N/A	
RH Weld On Sidebar Protector		454-8932	1385	N/A	1385.0	115.4	N/A	N/A	N/A	
LH Weld On Sidebar Protector		453-5658	1677	N/A	1677.0	139	N/A	N/A	N/A	
RH Weld On Sidebar Protector		453-5659	1677	N/A	1677.1	139	N/A	N/A	N/A	

Wear Protection

Shrouds

Part Number	Description	A (mm)	B (mm)	C (mm)	D (mm)	E (deg)	Hole Spacing	Weight (kg)	Pins	Notes
346-7779	Center	402	410	45	68	35	255	79.6	350-6751	
346-7780	Right	410	410	45	68	35	255	88.7	350-6752	
346-7781	Left	410	410	45	68	35	255	88.7	350-6753	
463-7871	Center	316	408	49	68	22.5	170	70.6	350-6751	
463-7872	Right	304	408	49	68	22.5	170	70.9	350-6751	
463-7873	Left	304	408	49	68	22.5	170	70.9	350-6751	
463-7862	Center	390	445	49.0	68	22.5	180	89.4	350-6751	
463-7863	Right	410	426	49.0	68	22.5	200	105	350-6751	
463-7864	Left	410	426	49.0	68	22.5	200	105	350-6751	

Half Arrows

Part Number	Description	A (mm)	B (mm)	C (mm)	H (mm)	E (mm)	Number of Holes	Angle of Half Arrow	Weight (kg)	Notes
257-1782	Center	402	400	45	85	140	4	0	56.4	
257-1783	Right	402	400	45	85	140	4	15	58.4	
257-1784	Left	402	400	45	85	140	4	15	58.4	
307-1636	Center ARM	402	400	45	85	140	4	0	60.2	
307-1638	Right ARM	402	400	45	85	140	4	15	60.2	
307-1638	Left ARM	402	400	45	85	140	4	15	60.2	
109-9080	Center	342	420	45	85	140	3	0	48.2	
109-9081	Right	342	420	45	85	140	3	15	48.8	
109-9082	Left	342	420	45	85	140	3	15	48.8	
257-1817	Center	342	420	60	85	140	3	0	64.7	
257-1818	Right	342	420	60	85	140	3	15	66.4	
257-1819	Left	342	420	60	85	140	3	15	66.4	
275-5460	Center	410	495	60	90	180	4	0	85.0	
275-5461	Right	436	480	60	100	180	4	15	90.6	
275-5462	Left	436	480	60	100	180	4	15	90.6	
275-5470	Center	410	536	75	90	180	4	0	100.5	
275-5471	Right	451	536	75	100	180	4	15	110.2	
275-5472	Left	451	536	75	100	180	4	15	110.2	

Top Covers

Part Number	Description	A (mm)	B (mm)	C (mm)	H (mm)	E (mm)	K (mm)	Number of Holes	Weight (kg)	Bevel	Notes
257-1778	Center	402	254	25	85	73.5	91.5	4	17.1	35	<p>Match dimensions A and H and the Number of Holes with the Half Arrows above to choose the correct Top Covers</p>
257-1779	Right	402	254	25	85	73	91.5	4	17.1	35	
257-1781	Left	402	254	25	85	73	91.5	4	17.1	35	
233-7167	Center	342	254	25	85	86	91.5	3	14.8	35	
253-0191	Right	354	254	25	85	92	91.5	3	15.3	35	
253-0192	Left	354	254	25	85	92	91.5	3	15.3	35	
195-7180	Center	342	200	25.4	85	86	53	3	11.9	22.5	
195-7181	Right	354	200	25.4	85	92	53	3	12.4	22.5	
195-7182	Left	354	200	25.4	85	92	53	3	12.4	22.5	
195-7097	Right	451.4	254	25	100	75.7	78.5	4	19.3	22.5	
195-7098	Left	451.4	254	25	100	75.7	78.5	4	19.3	22.5	
307-5600	Center	410	330	29	90	70	104	4	26.7	35	
307-5601	Right	421	330	29	100	61	104	4	29.6	35	
307-5602	Left	421	330	29	100	61	104	4	29.6	35	

Segments

Description	Part Number	A (mm)	B (mm)	C (mm)	H (mm)	E (mm)	Number of Holes	Weight (kg)	Qty.	Nuts and Bolts	Notes
40mm Segments	4T-6760	410	590	40	90	295	4	68.0	1	Nut: 3K-9770 Bolt: 5P-8823	
	RH - 4T-6761	431	590	40	100	295	4	71.2	3		
	LH - 4T-6762	431	590	40	100	295	4	71.2	3		
40mm Segments	101-9435	342	482.5	40	85	240.5	3	48.5	1	Nut: 3K-9770 Bolt: 6V-8535	
	RH - 101-9436	354	482.5	40	85	240.5	3	50.4	3		
	LH - 101-9437	354	482.5	40	85	240.5	3	50.4	3		
40mm ARM Segments	138-0865	342	482.5	40	85	240.5	3	49.0	1	Nut: 3K-9770 Bolt: 6V-8535	
	RH - 138-0866	354	482.5	40	85	240.5	3	50.7	3		
	LH - 138-0867	354	482.5	40	85	240.5	3	50.7	3		
40mm Segments	315-0085	322	482.5	40	85	241.3	3	45.2	1	Nut: 3K-9770 Bolt: 6V-8535	
	RH - 315-0086	334	482.5	40	85	241.3	3	47.9	3		
	LH - 315-0087	334	482.5	40	85	241.3	3	47.9	3		
40mm ARM Segments	138-0861*	410	590	40	90	295	4	70.0	1	Nut: 3K-9770 Bolt: 6V-8535	
	RH - 138-0862*	431	590	40	100	295	4	74.8	3		
	LH - 138-0863*	431	590	40	100	295	4	74.8	3		
45mm Segments	315-0080	322	482.5	45	85	240.5	3	51.0	1	Nut: 3K-9770 Bolt: 6V-8360	
	RH - 315-0081	322	482.5	45	85	240.5	3	53.0	3		
	LH - 315-0082	322	482.5	45	85	240.5	3	53.0	3		
45mm Segments	107-3536	312	482.5	45	85	240.5	3	50.4	1	Nut: 3K-9770 Bolt: 6V-8535	
	RH - 107-3537	323	482.5	45	85	240.5	3	52.2	3		
	LH - 107-3538	323	482.5	45	85	240.5	3	52.2	3		

Cat Wheel Loaders

PART NUMBERS

J Series J600

Machine Models: 990-992

Adapters											
Type	Part Number	Edge Thickness	A (mm)	B (mm)	C (deg)	D (mm)	E (deg)	Weight (kg)	Notes		
Center 2 Strap	143-3114	63.5	371	316	22.5	142	15	47.3			
RH 2 Strap	143-3115	63.5	371	316	22.5	142	15	47.4			
LH 2 Strap	143-3116	63.5	371	316	22.5	142	15	47.4			
Center 2 Strap Long Life (ARM)	186-5384*	63.5	371	316	22.5	142	15	47.6			
RH 2 Strap Long Life (ARM)	186-5385*	63.5	371	316	22.5	142	15	47.7			
LH 2 Strap Long Life (ARM)	186-5386*	63.5	371	316	22.5	142	15	47.7			
Center 2 Strap	119-8604	70	365	310	22.5	190	15	64.1			
RH 2 Strap	119-8605	70	365	310	22.5	190	15	64.1			
LH 2 Strap	119-8606	70	365	310	22.5	190	15	64.1			
Center 2 Strap Long Life (ARM)	119-8607	70	365	310	22.5	190	15	64.7			
RH 2 Strap Long Life (ARM)	119-8608	70	365	310	22.5	190	15	64.7			
LH 2 Strap Long Life (ARM)	119-8609	70	365	310	22.5	190	15	64.7			
Flushmount Center Adapter	119-9604	64-76	475	N/A	35	144	15	65.3			
Flushmount Corner Adapter	119-9605	64-76	403	N/A	35	144	15	63.5			
Tips											
Type	Part Number	Dimensions (mm)			Weight (kg)	Pin and Retainer					
		A	B	C							
	Heavy Abrasion	6I-6603	408	230	140	53.5	Pin: 113-9608 Retainer: 113-9609				
	Heavy Penetration	135-9600	445	168	140	55.7					
	Heavy Duty	7Y-0602	408	170	140	41.4					
	General Purpose	6I-6602	388	170	140	27.8					
Specialty											
	Heavy Duty Long Life (ARM)	107-8602	408	168	140	40.4	Pin: 113-9608 Retainer: 113-9609	The black areas in the pictures of the tips is where the ARM will be applied.			
Wear Protection											
Type	Machine	Part Number	A (mm)	B (mm)	C (mm)	Weight (kg)	Pin	Retainer	Sheer Block	Notes	
Pin-On Sidebar Protector	990-992	112-2492	300	52	649.0	31.6	132-1008	132-0999	N/A		
Capsure Sidebar Protector		329-5946	294	53	598.0	23.9	329-5949	N/A	356-6432		
Pin-On Sidebar Protector		1U-0740	300	53	598.0	21.8	133-0738	107-8559	330-4456		
Shrouds											
Part Number	Description	A (mm)	B (mm)	C (mm)	D (mm)	E (deg)	Hole Spacing	Weight (kg)	Pins	Notes	
348-8583	Center (Set of 6)	470	470	60	72	35	270	119.5	352-7950		
348-8584	Right (Set of 6)	496	455	60	72	35	300	126.0	352-7950		
348-8585	Left (Set of 6)	496	455	60	72	35	300	126.0	352-7950		
351-2425	Right (Set of 8)	342	447	60	72	35	170	86.0	352-7950		
351-2426	Left (Set of 8)	342	447	60	72	35	170	86.0	352-7950		
346-7772	Center (Set of 7)	410	481	60	79	35	270	108.3	352-7950		
346-7774	Right (Set of 7)	436	455	60	79	35	300	115.1	352-7950		
346-7775	Left (Set of 7)	436	455	60	79	35	300	115.1	352-7950		

Wear Protection											
Half Arrows											
Part Number	Description	A (mm)	B (mm)	C (mm)	H (mm)	E (mm)	Number of Holes	Angle of Half Arrow	Weight (kg)	Notes	
109-9081	Right	342	420	45	85	140	3	15	48.8		
109-9082	Left	342	420	45	85	140	3	15	48.8		
264-2090	Center	470	495	60	90	180	4	0	91.7		
264-2091	Right	436	480	60	100	180	4	15	97.1		
264-2092	Left	436	480	60	100	180	4	15	97.1		
275-5460	Center	410	495	60	90	180	4	0	85.0		
275-5461	Right	436	480	60	100	180	4	15	90.6		
275-5462	Left	436	480	60	100	180	4	15	90.6		
275-6055	Center	390	536	75	90	180	4	0	96.0		
275-6056	Right	436	536	75	100	180	4	15	101.9		
275-6057	Left	436	536	75	100	180	4	15	101.9		
275-5470	Center	410	536	75	90	180	4	0	100.5		
275-5471	Right	451	536	75	100	180	4	15	110.2		
275-5472	Left	451	536	75	100	180	4	15	110.2		
Top Covers											
Part Number	Description	A (mm)	B (mm)	C (mm)	H (mm)	E (mm)	K (mm)	Number of Holes	Weight (kg)	Bevel	Notes
235-8777	Right	354	254	25	85	92	80.5	3	24.8	35	<p>Match dimensions A and H and the Number of Holes with the Half Arrows above to choose the correct Top Covers</p>
235-8778	Left	354	254	25	85	92	80.5	3	24.8	35	
253-0191	Left	354	254	25	85	92	91.5	3	24.8	35	
195-7096	Center	410	254	25	90	70	78.5	4	17.4	22.5	
195-7097	Right	451	254	25	100	75.7	78.5	4	19.3	22.5	
195-7098	Left	451	254	25	100	75.7	78.5	4	19.3	22.5	
335-7198*	Right	413	254	25	100	56.9	78.5	4	17.8	22.5	
335-7199*	Left	413	254	25	100	56.9	78.5	4	17.8	22.5	
208-5327	Center	410	330	35	90	70	128	4	32.8	35	
208-5328	Right	451	330	35	100	75.7	128	4	36.5	35	
208-5329	Left	451	330	35	100	75.7	128	4	36.5	35	
229-7045	Center	410	254	25	90	70	126.5	4	17.5	35	
229-7046	Right	451	254	25	100	75.7	126.5	4	19.5	35	
229-7047	Left	451	254	25	100	75.7	126.5	4	19.5	35	
195-7246	Center - ARM	410	254	25	90	70	126.5	4	17.4	35	
195-7247	Right - ARM	451	254	25	100	75.7	126.5	4	19.3	35	
195-7248	Left - ARM	451	254	25	100	75.7	126.5	4	19.3	35	
264-2096	Center	470	254	25	90	100		4	20.3	35	
264-2097	Right	513.5	254	25	100	106.8		4	22.4	35	
264-2098	Left	513.5	254	25	100	106.8		4	22.4	35	
Segments											
Description	Part Number	A (mm)	B (mm)	C (mm)	H (mm)	E (mm)	Number of Holes	Weight (kg)	Qty.	Nuts and Bolts	Notes
40mm Segments	4T-6760	410	590	40	90	295	4	68.0	1	Nut: 3K-9770 Bolt: 5P-8823	
	RH - 4T-6761	431	590	40	100	295	4	71.2	3		
	LH - 4T-6762	431	590	40	100	295	4	71.2	3		
50mm Segments	107-3530	410	590	50	90	295	4	84.3	1		
	RH - 107-3531	431	590	50	100	295	4	90.4	3		
	LH - 107-3532	431	590	50	100	295	4	90.4	3		
60mm Segments	107-6294	410	590	60	90	295	4	102.2	1		
	RH - 107-6295	431	590	60	100	295	4	107.5	3		
	LH - 107-6296	431	590	60	100	295	4	107.5	3		

Cat Wheel Loaders

PART NUMBERS

J Series J700

Machine Models: 993

Adapters										
Type	Part Number	Edge Thickness	A (mm)	B (mm)	C (deg)	D (mm)	E (deg)	Weight (kg)	Notes	
Center 2 Strap	133-0704	70	365	310	22.5	190	15	68.0		
RH 2 Strap	133-0705	70	365	310	22.5	190	15	67.8		
LH 2 Strap	133-0706	70	365	310	22.5	190	15	67.8		
Center 2 Strap Long Life (ARM)	133-0707*	70	365	310	22.5	190	15	68.5		
RH 2 Strap Long Life (ARM)	133-0708*	70	365	310	22.5	190	15	68.5		
LH 2 Strap Long Life (ARM)	133-0709*	70	365	310	22.5	190	15	68.5		
Center 2 Strap	171-1704	76	435	335	22.5	154	15	73.2		
RH 2 Strap	171-1705	76	435	335	22.5	154	15	73.3		
LH 2 Strap	171-1706	76	435	335	22.5	154	15	73.3		
Center 2 Strap Long Life (ARM)	217-4706*	76	435	335	22.5	154	15	73.8		
RH 2 Strap Long Life (ARM)	217-4707*	76	435	335	22.5	154	15	73.9		
LH 2 Strap Long Life (ARM)	217-4708*	76	435	335	22.5	154	15	73.9		
Center 2 Strap	222-7700	90	464	314	35	190	8	84.1		

Tips										
Type	Part Number	Dimensions (mm)			Weight (kg)	Pin and Retainer	Notes			
		A	B	C						
	Heavy Abrasion	9U-9703	430	260	150	77.2	Pin: 113-4708 Retainer: 113-4709			
	Heavy Penetration	135-9700	465	178	150	66.3				
	Heavy Duty	9U-9702	430	188	150	60.3				
	General Purpose	4T-4702	415	180	150	42.4				
	Heavy Duty Long Life (ARM)	107-2001	430	188	150	60.6	Pin: 113-4708 Retainer: 113-4709	The black areas in the pictures of the tips is where the ARM will be applied.		

Wear Protection										
Type	Machine	Part Number	A (mm)	B (mm)	C (mm)	Weight (kg)	Pin	Retainer	Sheer Block	Notes
Capsure Sidebar Protector	993	329-5946	294	53	598.0	23.9	329-5949	N/A	356-6432	
Pin-On Sidebar Protector		1U-0740	294	53	598.0	21.8	133-0738	107-8559	330-4456	

Shrouds										
Part Number	Description	A (mm)	B (mm)	C (mm)	D (mm)	E (deg)	Hole Spacing	Weight (kg)	Pins	Notes
346-7776	Center	410	481	75	79	22.5	270	120.0	349-1160	
346-7777	Right	436	481	75	79	22.5	300	131.7	349-1160	
346-7778	Left	436	481	75	79	22.5	300	131.7	349-1160	
339-0310	Center	410	481	75	93	22.5	270	120.9	364-3032	
339-0311	Right	436	481	75	93	22.5	300	131.3	364-3032	
339-0312	Left	436	481	75	93	22.5	300	131.3	364-3033	

Wear Protection											
Half Arrows											
Part Number	Description	A (mm)	B (mm)	C (mm)	H (mm)	E (mm)	Number of Holes	Angle of Half Arrow	Weight (kg)	Notes	
275-5460	Center	410	495	60	90	180	4	0	85.0		
275-5461	Right	436	480	60	100	180	4	15	90.6		
275-5462	Left	436	480	60	100	180	4	15	90.6		
275-6055	Center	390	536	75	90	180	4	0	96.0		
275-6056	Right	436	536	75	100	180	4	15	101.9		
275-6057	Left	436	536	75	100	180	4	15	101.9		
275-5470	Center	410	536	75	90	180	4	0	100.5		
275-5471	Right	451	536	75	100	180	4	15	110.2		
275-5472	Left	451	536	75	100	180	4	15	110.2		
275-5938	Center - ARM	410	536	75	90	180	4	0	102.2		
275-5936	Right - ARM	451	536	75	100	180	4	15	112.0		
275-5937	Left - ARM	451	536	75	100	180	4	15	112.0		
109-9033	Center	622	621	75	85	270	5	0	222.1		
109-9031	Right	440	598	75	85	270	5	15	139.0		
109-9032	Left	440	598	75	85	270	5	15	139.0		
Top Covers											
Part Number	Description	A (mm)	B (mm)	C (mm)	H (mm)	E (mm)	K (mm)	Number of Holes	Weight (kg)	Bevel	Notes
195-7096	Center	410	254	25	90	70	78.5	4	17.4	35	<p>Match dimensions A and H and the Number of Holes with the Half Arrows above to choose the correct Top Covers</p>
195-7097	Right	451	254	25	100	75.7	78.5	4	19.3	35	
195-7098	Left	451	254	25	100	75.7	78.5	4	19.3	35	
292-9462	Center	410	254	25	90	70	50	4	17.8	35	
292-9463	Right	451	254	25	100	75.7	50	4	19.4	22.5	
292-9464	Left	451	254	25	100	75.7	50	4	19.4	22.5	
294-8883	Center - ARM	410	254	25	90	70	50	4	19.2	22.5	
294-8884	Right - ARM	451	254	25	100	75.7	50	4	21.2	22.5	
294-8885	Left - ARM	451	254	25	100	75.7	50	4	21.2	22.5	
335-7198*	Right	413	254	25	100	56.9	78.5	4	17.8	35	
335-7199*	Left	413	254	25	100	56.9	78.5	4	17.8	35	
307-5600	Center	410	330	29	90	70	104	4	26.7	35	
307-5601	Right	421	330	29	100	61	104	4	29.6	35	
307-5602	Left	421	330	29	100	61	104	4	29.6	35	
395-3306	Center - ARM	410	330	29	90	70	104	4	27.8	35	
395-3307	Right - ARM	421	330	29	100	61	104	4	30.1	35	
395-3308	Left - ARM	421	330	29	100	61	104	4	30.1	35	
208-5327	Center	410	330	35	90	70	128	4	32.8	35	
208-5328	Right	451	330	35	100	75.7	128	4	36.5	35	
208-5329	Left	451	330	35	100	75.7	128	4	36.5	35	
Segments											
Description	Part Number	A (mm)	B (mm)	C (mm)	H (mm)	E (mm)	Number of Holes	Weight (kg)	Qty.	Nuts and Bolts	Notes
40mm Segments	4T-6760	410	590	40	90	295	4	68.0	1	Nut: 3K-9770 Bolt: 5P-8823	
	RH - 4T-6761	431	590	40	100	295	4	71.2	3		
	LH - 4T-6762	431	590	40	100	295	4	71.2	3		
50mm Segments	107-3530	410	590	50	90	295	4	84.3	1		
	RH - 107-3531	431	590	50	100	295	4	90.4	3		
	LH - 107-3532	431	590	50	100	295	4	90.4	3		
60mm Segments	107-6294	410	590	60	90	295	4	102.2	1		
	RH - 107-6295	431	590	60	100	295	4	107.5	3		
	LH - 107-6296	431	590	60	100	295	4	107.5	3		

Cat Wheel Loaders

PART NUMBERS

J Series J800

Machine Models: 994

Adapters										
Type	Part Number	Edge Thickness	A (mm)	B (mm)	C (deg)	D (mm)	E (deg)	Weight (kg)	Notes	
Center 2 Strap	61-8804	100	435	335	22.5	220	16	110.2		
Tips										
Type	Part Number	Dimensions (mm)			Weight (kg)	Pin and Retainer	Notes			
		A	B	C						
	Heavy Abrasion 61-8803	475	296	170	107.6	Pin: 134-1808 Retainer: 134-1809				
	Heavy Penetration 135-9800	505	196	170	93.8					
	Heavy Duty 61-8802	475	220	170	89.8					
Specialty										
	Heavy Duty Long Life (ARM) 117-6802*	475	220	170	89.9	Pin: 134-1808 Retainer: 134-1809	The black areas in the pictures of the tips is where the ARM will be applied.			
Wear Protection										
Type	Machine	Part Number	A (mm)	B (mm)	Weight (kg)	Pin	Retainer	Shear Block	Notes	
Straight MAWPS Sidebar Protector	994	481-1104	567	67	37.63	N/A	138-0007	481-1105		
Type	Machine	Part Number	A (mm)	B (mm)	C (mm)	Weight (kg)	Pin	Retainer	Shear Block	Notes
Pin-On Sidebar Protector	994	125-0800	600	67	998.0	57.15	8E-4708	4T-4707	330-4455	
Capsure Sidebar Protector RH		304-5853	600	67	816.4	65.46	304-5849	N/A	356-6435	
Capsure Sidebar Protector LH		304-5854	600	67	816.4	65.46	304-5849	N/A	356-6435	
Shrouds										
Part Number	Description	A (mm)	B (mm)	C (mm)	D (mm)	E (deg)	Hole Spacing	Weight (kg)	Pins	Notes
326-5216	Center	440	553	70	105	22.5	170	160.2	323-1842	
311-6933	Center	622	553	70	105	22.5	170	224.4	323-1843	
324-6147	Right	435	553	70	105	22.5	170	165.4	323-1844	
323-3151	Left	435	553	70	105	22.5	170	165.4	323-1845	
Half Arrows										
Part Number	Description	A (mm)	B (mm)	C (mm)	H (mm)	E (mm)	Number of Holes	Angle of Half Arrow	Weight (kg)	Notes
347-7256	Center	330	593	75	85	270	3	0	113.6	
109-9030	Center	440	593	75	85	270	5	0	148.8	
109-9031	Right	440	598	75	85	270	5	15	153.5	
109-9032	Left	440	598	75	85	270	5	15	153.5	
117-6805	Right	442	627	75	85	260	5	15	157.3	
117-6806	Left	442	627	75	85	260	5	15	157.3	
109-9033	Center	622	621	75	85	270	5	0	222.1	
Top Covers										
Part Number	Description	A (mm)	B (mm)	C (mm)	H (mm)	E (mm)	Number of Holes	Weight (kg)	Bevel	Notes
195-7230	Center	440	336	35	85	50	5	36.6	22.5	Match dimensions A and H and the Number of Holes with the Half Arrows above to choose the correct Top Covers
195-7231	Right	474.2	360	35	85	61	5	39.1	22.5	
195-7232	Left	474.2	360	35	85	61	5	39.1	22.5	
229-6596	Center	644	336	35	85	152	5	54.2	22.5	

Hydraulic Excavators



Discontinued
Canceled
(Reference)

Part is discontinued. Please contact your service representative.
Part is canceled. Please contact your customer service representative.
Part number is not serviceable. For reference only.

Cat Hydraulic Excavators

BASE EDGE DESIGN REFERENCES

Making the Most Out of GET Resources

Base Edge Design References

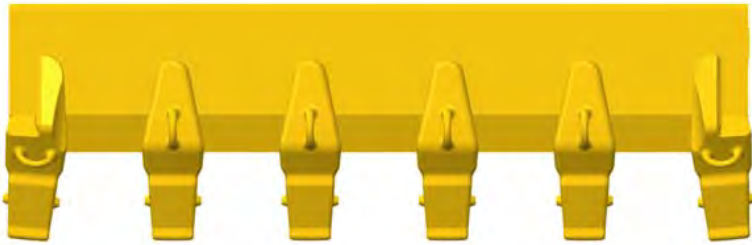

Base Edge Assembly –
Fixed corner locations



Stepped Base Edge Assembly -
Fixed corner locations

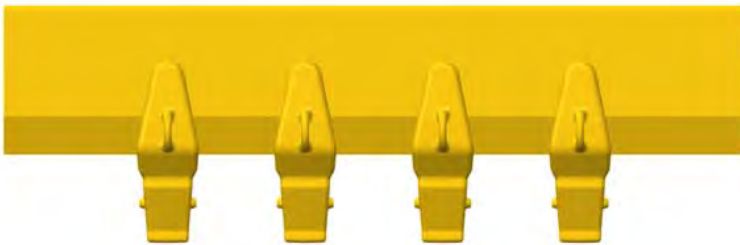

Conversion Assembly – no
corner locations. Order
corner adapters

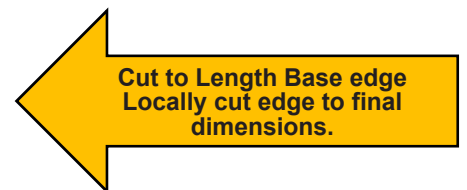

Cut to Length Base edge
Locally cut edge to final
dimensions.

Cat Hydraulic Excavators

TIP CROSS REFERENCE TABLE

Size	Recommended Machine	Style	Cat® Advansys™ Series	K Series	CapSure J Series	J Series	
70 & 250	Excavator	WIDE	539-5670	N/A	N/A	208-5254	
	Excavator	PENETRATION	539-5677	N/A	N/A	9J-4259	
	Excavator	PENETRATION PLUS	539-5673	N/A	N/A	N/A	
	Excavator	SPIKE	N/A	N/A	N/A	9W-8259	
	Excavator	DOUBLE SPIKE	539-5675	N/A	N/A	135-8258	
	Excavator	GENERAL DUTY	539-5678	N/A	N/A	1U-3252	
	Wheel Loader	HEAVY ABRASION	539-5771	N/A	N/A	9N-4253	
	Wheel Loader	HEAVY DUTY	N/A	N/A	N/A	9N-4252	
	Wheel Loader	AGGREGATE	539-5776	N/A	N/A	N/A	
	Wheel Loader	GENERAL DUTY	539-5678	N/A	N/A	1U-3252	
	Wheel Loader	SHORT	N/A	N/A	N/A	1U-3251	
	SPECIALTY						
	Wheel Loader	HEAVY DUTY LONG LIFE (ARM)	N/A	N/A	N/A	N/A	135-8252
Wheel Loader	AGGREGATE LONG LIFE (ARM)	539-5777	N/A	N/A	N/A	N/A	
80 & 300	Excavators	HEAVY DUTY	505-3982	N/A	N/A	N/A	
	Excavators	WIDE	505-4080	475-5474	N/A	107-3300	
	Excavators	PENETRATION	505-4081	475-5469	N/A	9J-4309	
	Excavators	PENETRATION PLUS	505-4083	475-5470	N/A	183-5300	
	Excavators	SPIKE	505-4084	475-5471	N/A	168-1300	
	Excavators	DOUBLE SPIKE	505-4085	475-5472	N/A	135-9308	
	Excavators	GENERAL PURPOSE	505-4086	475-5473	N/A	1U-3302	
	Wheel Loader	HEAVY ABRASION	505-3981	475-5476	N/A	9N-4303	
	Wheel Loader	HEAVY PENETRATION	505-3980	475-5475	N/A	135-9300	
	Wheel Loader	HEAVY DUTY	505-3982	475-5468	N/A	9N-4302	
	Wheel Loader	GENERAL PURPOSE	505-3984	475-5473	N/A	1U-3302	
	SPECIALTY						
	Excavators	PENETRATION LONG LIFE (ARM)	505-4082	N/A	N/A	N/A	125-8309
Wheel Loader	HEAVY DUTY LONG LIFE (ARM)	505-3983	475-5477	N/A	N/A	125-8302	
90 & 350	Excavators	HEAVY DUTY	505-3996	N/A	N/A	N/A	
	Excavators	WIDE	505-4096	475-5485	N/A	107-3350	
	Excavators	PENETRATION	505-4091	475-5481	N/A	9J-4359	
	Excavators	PENETRATION PLUS	505-4097	475-5482	N/A	168-1359	
	Excavators	SPIKE	505-4098	475-5483	N/A	168-1350	
	Excavators	DOUBLE SPIKE	505-4095	475-5491	N/A	135-9357	
	Excavators	GENERAL PURPOSE	505-4096	475-5484	N/A	1U-3352	
	Wheel Loader	HEAVY ABRASION	505-3991	475-5487	N/A	9N-4353	
	Wheel Loader	HEAVY PENETRATION	505-3990	475-5486	N/A	144-1358	
	Wheel Loader	HEAVY DUTY	505-3996	475-5480	N/A	9N-4352	
	Wheel Loader	GENERAL PURPOSE	505-3994	475-5484	N/A	1U-3352	
	SPECIALTY						
	Excavators	PENETRATION LONG LIFE (ARM)	505-4092	475-5489	N/A	N/A	119-9359
Wheel Loader	HEAVY DUTY LONG LIFE (ARM)	505-3993	475-5501	N/A	N/A	135-9352	
100 & 400	Excavators	HEAVY DUTY	505-4002	N/A	N/A	N/A	
	Excavators	PENETRATION PLUS	505-4103	475-5494	N/A	168-1409	
	Excavators	WIDE	505-4100	475-5498	N/A	107-3400	
	Excavators	PENETRATION	505-4101	475-5493	N/A	6Y-7409	
	Excavators	SPIKE	505-4104	475-5495	N/A	159-0400	
	Excavators	DOUBLE SPIKE	505-4105	475-5496	N/A	135-9408	
	Excavators	GENERAL PURPOSE	505-4106	475-5497	N/A	7T-3402	
	Wheel Loader	HEAVY ABRASION	505-4001	475-5500	N/A	7T-3403	
	Wheel Loader	HEAVY PENETRATION	505-4000	475-5499	N/A	135-9400	
	Wheel Loader	HEAVY DUTY	505-4002	475-5492	N/A	8E-4402	
	Wheel Loader	GENERAL PURPOSE	505-4004	475-5497	N/A	7T-3401	
	SPECIALTY						
	Excavators	PENETRATION LONG LIFE (ARM)	505-4102	475-5502	N/A	N/A	124-7409
Wheel Loader	HEAVY DUTY LONG LIFE (ARM)	505-4003	475-5501	N/A	N/A	116-7402	

Cat Hydraulic Excavators

TIP CROSS REFERENCE TABLE

Size	Recommended Machine	Style	Cat® Advansys™ Series	K Series	CapSure J Series	J Series	
110 & 450	Excavators	HEAVY DUTY	505-4012	N/A	N/A	N/A	
	Excavators	PENETRATION PLUS	505-4113	467-9823	N/A	159-0459	
	Excavators	WIDE	505-4110	470-7986	N/A	107-3450	
	Excavators	PENETRATION	505-4111	467-9822	N/A	9W-8459	
	Excavators	SPIKE	505-4114	470-7972	N/A	159-0450	
	Excavators	DOUBLE SPIKE	505-4115	470-7973	N/A	138-6458	
	Excavators	GENERAL PURPOSE	505-4116	467-9824	N/A	9W-8452	
	Wheel Loader	HEAVY ABRASION	505-4011	470-7974	N/A	9N-4453	
	Wheel Loader	HEAVY PENETRATION	505-4010	467-9825	N/A	138-6451	
	Wheel Loader	HEAVY DUTY	5054012	467-9821	N/A	9N-4452	
	Wheel Loader	GENERAL PURPOSE	5054014	467-9824	N/A	9W-8452	
	SPECIALTY						
	Excavators	PENETRATION LONG LIFE (ARM)	505-4112	472-7763	N/A	116-7458	
	Wheel Loader	HEAVY DUTY LONG LIFE (ARM)	505-4013	472-7763	N/A	101-9054	
130 & 550	Excavators	HEAVY DUTY	368-3791	N/A	N/A	N/A	
	Excavators	WIDE	381-4091	470-7979	N/A	107-3550	
	Excavators	PENETRATION	381-4093	470-7975	N/A	9W-8559	
	Excavators	PENETRATION PLUS	381-4089	467-9813	460-8048	159-0559	
	Excavators	SPIKE	381-4090	470-7976	N/A	159-0550	
	Excavators	DOUBLE SPIKE	381-4092	470-7977	N/A	222-7553	
	Excavators	GENERAL PURPOSE	381-4088	470-7978	460-8044	9W-8552	
	Wheel Loader	HEAVY ABRASION	381-4096	467-9814	460-8042	6Y-2553	
	Wheel Loader	HEAVY PENETRATION	381-4095	467-9816	460-8046	138-6552	
	Wheel Loader	HEAVY DUTY	368-3791	467-9815	460-8050	9N-4552	
	Wheel Loader	GENERAL PURPOSE	381-4094	470-9798	460-8044	9W-8552	
	Wheel Loader	COAL	368-3860	N/A	N/A	N/A	
	SPECIALTY						
	Excavators	PENETRATION LONG LIFE (ARM)	368-3858	472-7766	N/A	113-0559	
Wheel Loader	HEAVY ABRASION (ARM)	486-6524	N/A	N/A	N/A		
Wheel Loader	HEAVY PEN LONG LIFE (ARM)	N/A	472-7767	N/A	N/A		
Wheel Loader	HEAVY DUTY LONG LIFE (ARM)	368-3857	472-7765	N/A	101-9055		
150 & 600	Excavators	HEAVY DUTY	368-3786	N/A	N/A	N/A	
	Excavators	WIDE	368-3790	470-7981	N/A	N/A	
	Excavators	PENETRATION	368-3785	470-7982	N/A	71-7609	
	Excavators	PENETRATION PLUS	368-3783	467-9817	459-2180	159-0607	
	Excavators	SPIKE	368-3787	470-7983	N/A	159-0600	
	Excavators	DOUBLE SPIKE	368-3788	470-7984	N/A	222-7603	
	Excavators	GENERAL PURPOSE	368-3789	470-7985	N/A	61-6602	
	Wheel Loader	HEAVY ABRASION	368-3863	467-9818	459-2186	61-6603	
	Wheel Loader	HEAVY PENETRATION	368-3862	467-9820	459-2184	135-9600	
	Wheel Loader	HEAVY DUTY	368-3786	467-9819	459-2182	7Y-0602	
	Wheel Loader	GENERAL PURPOSE	368-3879	470-7985	N/A	N/A	
	Wheel Loader	COAL	368-3865	N/A	N/A	N/A	
	SPECIALTY						
	Excavators	PENETRATION LONG LIFE (ARM)	368-3874	472-7769	N/A	119-9609	
Wheel Loader	HEAVY ABRASION (ARM)	486-6520	N/A	N/A	N/A		
Wheel Loader	HEAVY PEN LONG LIFE (ARM)	N/A	472-7770	N/A	N/A		
Wheel Loader	HEAVY DUTY LONG LIFE (ARM)	368-3861	472-7768	N/A	107-8602		
170 & 700	Excavators	HEAVY DUTY	368-3867	N/A	N/A	N/A	
	Excavators	WIDE	368-3866	223-8170	N/A	N/A	
	Excavators	PENETRATION	368-3868	232-0172	N/A	4T-4709	
	Excavators	PENETRATION PLUS	368-3869	232-0173	455-1024	171-1709	
	Excavators	SPIKE	368-3870	232-0177	N/A	136-8700	
	Excavators	DOUBLE SPIKE	368-3871	232-0178	N/A	N/A	
	Excavators	GENERAL PURPOSE	368-3872	232-0179	N/A	4T-4702	
	Wheel Loader	HEAVY ABRASION	368-3864	232-2178	459-2186	9U-9703	
	Wheel Loader	HEAVY PENETRATION	368-3873	264-2172	459-2184	135-9700	
	Wheel Loader	HEAVY DUTY	368-3867	264-2171	459-2182	9U-9702	
	Wheel Loader	GENERAL PURPOSE	368-3880	232-0179	N/A	4T-4702	
	Wheel Loader	COAL	368-3875	N/A	N/A	N/A	
	SPECIALTY						
	Excavators	PENETRATION LONG LIFE (ARM)	387-6866	233-7171	N/A	N/A	
Wheel Loader	HEAVY ABRASION (ARM)	486-6522	N/A	N/A	N/A		
Wheel Loader	HEAVY DUTY LONG LIFE (ARM)	387-6856	233-7170	N/A	107-2001		

Cat Hydraulic Excavators

TIP CROSS REFERENCE TABLE

Size	Recommended Machine	Style	Cat® Advansys™ Series	K Series	CapSure J Series	J Series	
200 & 800	Excavators	HEAVY DUTY	385-4814	N/A	N/A	N/A	
	Excavators	PENETRATION	368-3877	N/A	N/A	117-6809	
	Excavators	PENETRATION PLUS	368-3878	N/A	453-3646	N/A	
	Excavators	GENERAL PURPOSE	385-4811	N/A	N/A	N/A	
	Wheel Loader	HEAVY ABRASION	385-4813	N/A	444-7594	6I-8803	
	Wheel Loader	HEAVY PENETRATION	385-4812	N/A	444-7577	135-9800	
	Wheel Loader	HEAVY DUTY	385-4814	N/A	453-3648	6I-8802	
	Wheel Loader	GENERAL PURPOSE	368-3876	N/A	N/A	N/A	
	Wheel Loader	COAL	387-6869	N/A	N/A	N/A	
	SPECIALTY						
	Excavators	PENETRATION LONG LIFE (ARM)	378-6868	N/A	N/A	N/A	
	Wheel Loader	HEAVY ABRASION (ARM)	486-6526	N/A	N/A	N/A	
	Wheel Loader	HEAVY DUTY LONG LIFE (ARM)	387-6867	N/A	N/A	117-6802*	
220	Wheel Loader	HEAVY ABRASION	431-0065	N/A	N/A	N/A	
	Wheel Loader	EXTREME ABRASION ROCK	544-0456	N/A	N/A	N/A	
	Wheel Loader	HEAVY PENETRATION	431-0062	N/A	N/A	N/A	
	Wheel Loader	GENERAL PURPOSE	431-0064	N/A	N/A	N/A	
	Wheel Loader	COAL	431-0069	N/A	N/A	N/A	
	SPECIALTY						
Wheel Loader	HEAVY ABRASION (ARM)	431-0066	N/A	N/A	N/A		
230	Wheel Loader	HEAVY ABRASION	532-7015	N/A	N/A	N/A	

General Duty Tips Options		
General Duty Tip Sizes	Shape	Part #
250	Long	449-2156
	Long	449-2159
300	Heavy Duty Long	449-2160
	Penetration Plus	450-7556
350	Long	449-2161
	Heavy Duty Long	449-2162
	Penetration Plus	389-5743
400	Long	449-2164
	Heavy Duty Long	389-5744
	Penetration Plus	389-5745
460	Long	449-2167
	Heavy Duty Long	389-5746
	Penetration Plus	389-5747

*General Duty tips are for low impact applications only.

Cat Hydraulic Excavators

ADAPTER CROSS REFERENCE TABLE

Excavator Conversion Adapters			
Size	Style	Cat Advansys™ Series	K Series
70	Center 2-Strap	539-5710	N/A
	RH 2 Strap Corner (5 degrees)	539-5711	N/A
	LH 2 Strap Corner (5 degrees)	539-5712	N/A
80	HEX TWO STRAP - CTR (36mm)	505-4130	220-9084
	HEX TWO STRAP CORNER - RH (36mm) 5 deg	505-4131	232-2085
	HEX TWO STRAP CORNER - LH (36mm) 5 deg	505-4132	232-2086
	HEX TWO STRAP CORNER - RH (36mm) 4 deg	N/A	220-9085
	HEX TWO STRAP CORNER - LH (36mm) 4 deg	N/A	220-9086
	HEX TWO STRAP CORNER - RH (36mm) 0 deg	N/A	229-7085
	HEX TWO STRAP CORNER - LH (36mm) 0 deg	N/A	229-7086
90	HEX TWO STRAP - CTR (40mm)	505-4140	220-9094
	HEX TWO STRAP CORNER - RH (40mm) 5 deg	505-4141	232-2095
	HEX TWO STRAP CORNER - LH (40mm) 5 deg	505-4142	232-2096
	HEX TWO STRAP CORNER - RH (40mm) 4 deg	N/A	220-9095
	HEX TWO STRAP CORNER - LH (40mm) 4 deg	N/A	220-9096
	HEX TWO STRAP CORNER - RH (40mm) 0 deg	N/A	223-8095
	HEX TWO STRAP CORNER - LH (40mm) 0 deg	N/A	223-8096
100	HEX TWO STRAP - CTR (45mm)	505-4150	220-9104
	HEX TWO STRAP CORNER - RH (45mm) 5 deg	505-4151	232-2105
	HEX TWO STRAP CORNER - LH (45mm) 5 deg	505-4152	232-2106
	HEX TWO STRAP CORNER - RH (45mm) 4 deg	N/A	220-9105
	HEX TWO STRAP CORNER - LH (45mm) 4 deg	N/A	220-9106
	HEX TWO STRAP CORNER - RH (45mm) 0 deg	N/A	232-0105
	HEX TWO STRAP CORNER - LH (45mm) 0 deg	N/A	232-0106
110	HEX TWO STRAP - CTR (60mm)	505-4160	469-4311
	HEX TWO STRAP CORNER - RH (60mm) 5 deg	505-4161	469-4312
	HEX TWO STRAP CORNER - LH (60mm) 5 deg	505-4162	469-4313
	HEX TWO STRAP CORNER - RH (60mm) 4 deg	N/A	469-4314
	HEX TWO STRAP CORNER - LH (60mm) 4 deg	N/A	469-4315

Excavator Conversion Adapters			
Size	Style	Cat Advansys™ Series	K Series
130	HEX TWO STRAP CTR	368-3780	469-4316
	HEX TWO STRAP CORNER - RH (70mm) 5 deg	368-3781	469-4319
	HEX TWO STRAP CORNER - LH (70mm) 5 deg	368-3782	469-4320
	HEX TWO STRAP - CTR (70mm)	N/A	469-4316
	HEX TWO STRAP CORNER - RH (70mm) 4 deg	N/A	469-4317
	HEX TWO STRAP CORNER - LH (70mm) 4 deg	N/A	469-4318
150	HEX TWO STRAP - CTR (80mm)	368-3800	472-0802
	HEX TWO STRAP CORNER - RH (80mm) 5 deg	368-3801	472-0809
	HEX TWO STRAP CORNER - LH (80mm) 5 deg	368-3802	472-0810
	HEX TWO STRAP - CTR (80mm)	N/A	472-0802
	HEX TWO STRAP CORNER - RH (80mm) 4 deg	N/A	472-0803
	HEX TWO STRAP CORNER - LH (80mm) 4 deg	N/A	472-0804
170	HEX TWO STRAP - CTR (90mm)	368-3822	478-2532
	HEX TWO STRAP CORNER - RH (90mm) 5 deg	368-3823	478-2538
	HEX TWO STRAP CORNER - LH (90mm) 5 deg	368-3824	478-2539
	HEX TWO STRAP - CTR (90mm)	N/A	478-2532
	HEX TWO STRAP CORNER - RH (90mm) 4 deg	N/A	478-2533
	HEX TWO STRAP CORNER - LH (90m) 4 deg	N/A	478-2534
200	HEX TWO STRAP - CTR (100mm)	368-3849	357-6516
	HEX TWO STRAP CORNER - RH (100mm) 5 deg	N/A	N/A
	HEX TWO STRAP CORNER - LH (100mm) 5 deg	N/A	N/A

Cat Hydraulic Excavators

CUT TO LENGTH REPLACEMENT BASE EDGE TABLE

Base Edge	L1 mm	L2 mm	W mm	T mm	Notes
211-2757	2490	2445	500	90.0	
119-3174	2363	2273	500	80.0	
6I-5303	1999	1905	380	70.0	
100-6198*	1185	1091	380	70.0	
108-1066	1954	1860	380	60.0	
264-2183	1422	1422	380	60.0	
264-2182	1270	1270	380	60.0	
264-2181	1118	1118	380	60.0	
137-4104	1784	1720	400	50.0	
9C-3955	1646	1582	325	50.0	
137-4101	1369	1305	400	50.0	
127-2317	1658	1614	305	44.5	
127-2290	1226	1182	305	44.5	
129-1540	1484	1453	300	40.0	
129-5715	1207	1176	300	40.0	
5V-0166	1575	1557	254	38.0	
8K-0668*	1045	1027	254	38.0	
7I-6713	1349	1308	290	36.0	
100-4150	1054	1014	290	36.0	

Cat Hydraulic Excavators

BASE EDGE TABLE

Base Edge Dimensional Reference												
Adapter Size Class	Adapter Series	Edge Type	Part Number								Edge Style	Adapter Quantity Welded on Edge
				A	B	C	D	E	F	G		
80	Blank Edge	Cut to Length	71-6713	1349	-	290	-	36	-	-	Straight	-
90	Blank Edge	Cut to Length	129-1540	1484	-	300	-	40	-	-	Straight	-
100	Blank Edge	Cut to Length	127-2317	1658	-	304.8	-	44.45	22.5	-	Straight	-
110	Blank Edge	Cut to Length	108-1066	1954	-	380	-	60	22.5	-	Straight	-
130	Blank Edge	Cut to Length	61-5303	1999	-	380	-	70	22.5	-	Straight	-
150	Blank Edge	Cut to Length	119-3174	2363	-	450	-	80	22.5	-	Straight	-
170	Blank Edge	Cut to Length	211-2757	2490	-	500	-	90	35	-	Straight	-
80	K Series	Conversion Edge	232-0022	595	-	250	250	36	-	-	Straight	1
80	K Series	Conversion Edge	232-0022	595	-	250	250	36	-	-	Straight	1
80	K Series	Conversion Edge	232-0023*	746	-	250	250	36	-	214	Straight	2
80	K Series	Conversion Edge	232-0023*	746	-	250	250	36	-	214	Straight	2
80	K Series	Conversion Edge	232-0024	900	-	250	250	36	-	398	Straight	3
80	K Series	Conversion Edge	232-0024	900	-	250	250	36	-	398	Straight	3
80	Advansys	Conversion Edge	547-5089	900	-	250	250	36	-	398	Straight	3
80	K Series	Conversion Edge	232-0025	1052	-	250	250	36	-	474	Straight	3
80	K Series	Conversion Edge	232-0025	1052	-	250	250	36	-	474	Straight	3
80	Advansys	Conversion Edge	547-5090	1052	-	250	250	36	-	474	Straight	3
80	K Series	Base Edge Assembly	239-2599*	1174.5	-	290	290	36	-	1027.6	Straight	5
80	K Series	Base Edge Assembly	239-2599*	1174.5	-	290	290	36	-	1027.6	Straight	5
80	K Series	Base Edge Assembly	239-2619	900	-	250	250	36	-	795.6	Straight	5
80	K Series	Base Edge Assembly	239-2619	900	-	250	250	36	-	795.6	Straight	5
80	K Series	Conversion Edge	232-0024	900	-	250	250	36	-	795.6	Straight	5
80	K Series	Base Edge Assembly	239-2659*	1054.5	-	290	290	36	-	907.6	Straight	5
80	K Series	Base Edge Assembly	239-2659*	1054.5	-	290	290	36	-	907.6	Straight	5
80	K Series	Base Edge Assembly	239-2764	1052	-	250	250	36	-	947.6	Straight	5
80	K Series	Base Edge Assembly	239-2764	1052	-	250	250	36	-	947.6	Straight	5
80	K Series	Conversion Edge	232-0025	1052	-	250	250	36	-	947.6	Straight	5
80	K Series	Base Edge Assembly	239-2774*	746	-	250	250	36	-	641.6	Straight	4
80	K Series	Base Edge Assembly	239-2774*	746	-	250	250	36	-	641.6	Straight	4
80	K Series	Conversion Edge	232-0023*	746	-	250	250	36	-	641.6	Straight	4
80	K Series	Base Edge Assembly	239-2784	1204	-	250	250	36	-	1099.6	Straight	6
80	K Series	Base Edge Assembly	239-2784	1204	-	250	250	36	-	1099.6	Straight	6
80	K Series	Conversion Edge	232-0026	1204	-	250	250	36	-	1099.6	Straight	6
80	K Series	Base Edge Assembly	239-2810*	595	-	250	250	36	-	490.6	Straight	3
80	K Series	Base Edge Assembly	239-2810*	595	-	250	250	36	-	490.6	Straight	3
80	K Series	Conversion Edge	232-0022	595	-	250	250	36	-	490.6	Straight	3
80	K Series	Base Edge Assembly	240-9602*	563	-	250	250	35	-	507	Straight	3
80	K Series	Base Edge Assembly	240-9602*	563	-	250	250	35	-	507	Straight	3
80	K Series	Base Edge Assembly	240-9604	879	-	250	250	35	-	823	Straight	5
80	K Series	Base Edge Assembly	240-9604	879	-	250	250	35	-	823	Straight	5
80	K Series	Base Edge Assembly	240-9605	1029.2	-	250	250	35	-	973.2	Straight	5
80	K Series	Base Edge Assembly	240-9605	1029.2	-	250	250	35	-	973.2	Straight	5
80	K Series	Base Edge Assembly	240-9606*	1177	-	250	250	35	-	1121	Straight	6
80	K Series	Base Edge Assembly	240-9606*	1177	-	250	250	35	-	1121	Straight	6
80	K Series	Base Edge Assembly	241-4214*	1177	-	250	250	35	-	1048.6	Straight	7
80	K Series	Base Edge Assembly	241-4214*	1177	-	250	250	35	-	1048.6	Straight	7
80	K Series	Base Edge Assembly	250-0541*	1201	-	300	300	35	-	1121	Straight	6
80	K Series	Base Edge Assembly	250-0541*	1201	-	300	300	35	-	1121	Straight	6
80	K Series	Base Edge Assembly	250-0542*	1348	-	300	300	35	-	1268	Straight	6
80	K Series	Base Edge Assembly	250-0542*	1348	-	300	300	35	-	1268	Straight	6
80	K Series	Base Edge Assembly	250-0562	1053	-	300	300	35	-	900.8/884	Straight	6
80	K Series	Base Edge Assembly	250-0562	1053	-	300	300	35	-	900.8/884	Straight	6
80	Advansys	Base Edge Assembly	541-1871	1053	-	300	300	35	-	900.8/884	Straight	6
80	K Series	Base Edge Assembly	251-8661*	750	-	290	290	36	-	654	Straight	3
80	K Series	Base Edge Assembly	251-8661*	750	-	290	290	36	-	654	Straight	3
80	K Series	Base Edge Assembly	251-8662*	1000	-	290	290	36	-	904	Straight	4
80	K Series	Base Edge Assembly	251-8662*	1000	-	290	290	36	-	904	Straight	4
80	K Series	Base Edge Assembly	251-8663	1200	-	290	290	36	-	1104	Straight	5
80	K Series	Base Edge Assembly	251-8663	1200	-	290	290	36	-	1104	Straight	5
80	K Series	Conversion Edge	253-9581*	1200	-	290	290	36	-	1104	Straight	5
80	K Series	Base Edge Assembly	251-8664	1250	-	290	290	36	-	1154	Straight	5
80	K Series	Base Edge Assembly	251-8664	1250	-	290	290	36	-	1154	Straight	5
80	K Series	Base Edge Assembly	251-8665	1300	-	290	290	36	-	1204	Straight	5
80	K Series	Base Edge Assembly	251-8665	1300	-	290	290	36	-	1204	Straight	5
80	K Series	Base Edge Assembly	251-8666	1400	-	290	290	36	-	1304	Straight	5
80	K Series	Base Edge Assembly	251-8666	1400	-	290	290	36	-	1304	Straight	5
80	Advansys	Base Edge Assembly	541-1866	1400	-	290	290	36	-	1304	Straight	5

Cat Hydraulic Excavators

BASE EDGE TABLE

Base Edge Dimensional Reference												
Adapter Size Class	Adapter Series	Edge Type	Part Number								Edge Style	Adapter Quantity Welded on Edge
				A	B	C	D	E	F	G		
80	K Series	Base Edge Assembly	251-8667	1500	-	290	290	36	-	1404	Straight	5
80	K Series	Base Edge Assembly	251-8667	1500	-	290	290	36	-	1404	Straight	5
80	K Series	Base Edge Assembly	252-1212*	900	-	290	290	36	-	804	Straight	4
80	K Series	Base Edge Assembly	252-1212*	900	-	290	290	36	-	804	Straight	4
80	K Series	Base Edge Assembly	252-1213	1100	-	290	290	36	-	1004	Straight	4
80	K Series	Base Edge Assembly	252-1213	1100	-	290	290	36	-	1004	Straight	4
80	K Series	Base Edge Assembly	(264-0275)	1201	-	300	300	35	-	1110	Straight	6
80	K Series	Base Edge Assembly	(264-0275)	1201	-	300	300	35	-	1110	Straight	6
80	K Series	Base Edge Assembly	270-1782*	914.4	-	279.4	279.4	35	-	282.6	Straight	2
80	K Series	Base Edge Assembly	270-1782*	914.4	-	279.4	279.4	35	-	282.6	Straight	2
80	K Series	Base Edge Assembly	271-5410*	1200	-	290	290	36	-	1104	Straight	5
80	K Series	Base Edge Assembly	271-5410*	1200	-	290	290	36	-	1104	Straight	5
80	K Series	Conversion Edge	253-9581*	1200	-	290	290	36	-	1104	Straight	5
80	K Series	Base Edge Assembly	276-5880*	549	-	300	300	35	-	465	Straight	3
80	K Series	Base Edge Assembly	276-5880*	549	-	300	300	35	-	465	Straight	3
80	K Series	Base Edge Assembly	276-5881*	704	-	300	300	35	-	620	Straight	4
80	K Series	Base Edge Assembly	276-5881*	704	-	300	300	35	-	620	Straight	4
80	K Series	Base Edge Assembly	276-5882*	852	-	300	300	35	-	768	Straight	5
80	K Series	Base Edge Assembly	276-5882*	852	-	300	300	35	-	768	Straight	5
80	K Series	Base Edge Assembly	276-5883*	1006	-	300	300	35	-	922	Straight	6
80	K Series	Base Edge Assembly	276-5883*	1006	-	300	300	35	-	922	Straight	6
80	K Series	Base Edge Assembly	276-5884	1158	-	300	300	35	-	1074	Straight	7
80	K Series	Base Edge Assembly	276-5884	1158	-	300	300	35	-	1074	Straight	7
80	K Series	Base Edge Assembly	276-5885	1310	-	300	300	35	-	1226	Straight	8
80	K Series	Base Edge Assembly	276-5885	1310	-	300	300	35	-	1226	Straight	8
80	K Series	Base Edge Assembly	279-3909*	600	-	290	290	36	-	504	Straight	3
80	K Series	Base Edge Assembly	279-3909*	600	-	290	290	36	-	504	Straight	3
80	K Series	Base Edge Assembly	279-4080*	599	-	300	300	35	-	465	Straight	3
80	K Series	Base Edge Assembly	279-4080*	599	-	300	300	35	-	465	Straight	3
80	K Series	Base Edge Assembly	279-4081*	754	-	300	300	35	-	620	Straight	4
80	K Series	Base Edge Assembly	279-4081*	754	-	300	300	35	-	620	Straight	4
80	K Series	Base Edge Assembly	279-4082*	902	-	300	300	35	-	768	Straight	5
80	K Series	Base Edge Assembly	279-4082*	902	-	300	300	35	-	768	Straight	5
80	K Series	Base Edge Assembly	279-4083	1056	-	300	300	35	-	922	Straight	5
80	K Series	Base Edge Assembly	279-4083	1056	-	300	300	35	-	922	Straight	5
80	K Series	Base Edge Assembly	279-4084	1208	-	300	300	35	-	1074	Straight	6
80	K Series	Base Edge Assembly	279-4084	1208	-	300	300	35	-	1074	Straight	6
80	K Series	Base Edge Assembly	279-4085*	1360	-	300	300	35	-	1226	Straight	7
80	K Series	Base Edge Assembly	279-4085*	1360	-	300	300	35	-	1226	Straight	7
80	K Series	Base Edge Assembly	292-8978*	1500	-	290	290	36	-	1404	Straight	5
80	K Series	Base Edge Assembly	292-8978*	1500	-	290	290	36	-	1404	Straight	5
80	K Series	Base Edge Assembly	298-0106*	599	-	250	250	36	-	465	Straight	3
80	K Series	Base Edge Assembly	298-0106*	599	-	250	250	36	-	465	Straight	3
80	Advansys	Base Edge Assembly	544-2692	599	-	250	250	36	-	465	Straight	3
80	K Series	Base Edge Assembly	298-0107*	754	-	250	250	36	-	620	Straight	4
80	K Series	Base Edge Assembly	298-0107*	754	-	250	250	36	-	620	Straight	4
80	K Series	Base Edge Assembly	298-0108	902	-	250	250	36	-	768	Straight	5
80	K Series	Base Edge Assembly	298-0108	902	-	250	250	36	-	768	Straight	5
80	K Series	Base Edge Assembly	298-0109	1056	-	250	250	36	-	922	Straight	5
80	K Series	Base Edge Assembly	298-0109	1056	-	250	250	36	-	922	Straight	5
80	K Series	Base Edge Assembly	298-0110	1208	-	250	250	36	-	1074	Straight	6
80	K Series	Base Edge Assembly	298-0110	1208	-	250	250	36	-	1074	Straight	6
80	K Series	Base Edge Assembly	(306-4048)	1230	-	230	230	35	-	1096	Straight	6
80	K Series	Base Edge Assembly	(306-4048)	1230	-	230	230	35	-	1096	Straight	6
80	K Series	Base Edge Assembly	306-5688	516.9	-	300	300	35	-	383	Straight	3
80	K Series	Base Edge Assembly	306-5688	516.9	-	300	300	35	-	383	Straight	3
80	K Series	Base Edge Assembly	(306-5702)	772	-	230	230	35	-	638	Straight	4
80	K Series	Base Edge Assembly	(306-5702)	772	-	230	230	35	-	638	Straight	4
80	K Series	Base Edge Assembly	(308-5748)	877	-	230	230	35	-	793	Straight	6
80	K Series	Base Edge Assembly	(308-5748)	877	-	230	230	35	-	793	Straight	6
80	K Series	Base Edge Assembly	313-1311*	650	-	290	290	36	-	554	Straight	3
80	K Series	Base Edge Assembly	313-1311*	650	-	290	290	36	-	554	Straight	3
80	K Series	Base Edge Assembly	317-0121	1234.4	-	300	300	35	-	1150.4	Straight	8
80	K Series	Base Edge Assembly	317-0121	1234.4	-	300	300	35	-	1150.4	Straight	8
80	K Series	Base Edge Assembly	320-1433	1206	-	250	250	35	-	1077.6	Straight	7
80	K Series	Base Edge Assembly	320-1433	1206	-	250	250	35	-	1077.6	Straight	7
80	K Series	Base Edge Assembly	323-1387*	1360	-	300	300	35	-	1226	Straight	6
80	K Series	Base Edge Assembly	323-1387*	1360	-	300	300	35	-	1226	Straight	6
80	K Series	Base Edge Assembly	327-3646*	1208	-	300	300	35	-	1074	Straight	5
80	K Series	Base Edge Assembly	327-3646*	1208	-	300	300	35	-	1074	Straight	5
80	K Series	Base Edge Assembly	(331-9368)	1300	-	290	290	36	-	1204	Straight	8

Base Edge Dimensional Reference

Adapter Size Class	Adapter Series	Edge Type	Part Number								Edge Style	Adapter Quantity Welded on Edge
				A	B	C	D	E	F	G		
80	K Series	Base Edge Assembly	(331-9368)	1300	-	290	290	36	-	1204	Straight	8
80	K Series	Base Edge Assembly	347-7466	754	-	290	290	36	-	620	Straight	3
80	K Series	Base Edge Assembly	347-7466	754	-	290	290	36	-	620	Straight	3
80	Advansys	Base Edge Assembly	557-1759	754	-	290	290	36	-	620	Straight	3
80	K Series	Base Edge Assembly	347-7467	902	-	290	290	36	-	768	Straight	4
80	K Series	Base Edge Assembly	347-7467	902	-	290	290	36	-	768	Straight	4
80	Advansys	Base Edge Assembly	560-3997	902	-	290	290	36	-	768	Straight	4
80	K Series	Base Edge Assembly	347-7468	1208	-	290	290	36	-	1074	Straight	5
80	K Series	Base Edge Assembly	347-7468	1208	-	290	290	36	-	1074	Straight	5
80	Advansys	Base Edge Assembly	544-2706	1208	-	290	290	36	-	1074	Straight	5
80	K Series	Base Edge Assembly	347-7580	599	-	290	290	36	-	465	Straight	3
80	K Series	Base Edge Assembly	347-7580	599	-	290	290	36	-	465	Straight	3
80	Advansys	Base Edge Assembly	544-2641	599	-	290	290	36	-	465	Straight	3
80	K Series	Base Edge Assembly	347-7581	754	-	290	290	36	-	620	Straight	4
80	K Series	Base Edge Assembly	347-7581	754	-	290	290	36	-	620	Straight	4
80	Advansys	Base Edge Assembly	556-0170	754	-	290	290	36	-	620	Straight	4
80	K Series	Base Edge Assembly	347-7582	902	-	290	290	36	-	768	Straight	5
80	K Series	Base Edge Assembly	347-7582	902	-	290	290	36	-	768	Straight	5
80	Advansys	Base Edge Assembly	552-6835	902	-	290	290	36	-	768	Straight	5
80	K Series	Base Edge Assembly	347-7583	1056	-	290	290	36	-	922	Straight	5
80	K Series	Base Edge Assembly	347-7583	1056	-	290	290	36	-	922	Straight	5
80	Advansys	Base Edge Assembly	552-6836	1056	-	290	290	36	-	922	Straight	5
80	K Series	Base Edge Assembly	347-7584	1158	-	290	290	36	-	1024	Straight	5
80	K Series	Base Edge Assembly	347-7584	1158	-	290	290	36	-	1024	Straight	5
80	K Series	Base Edge Assembly	347-7585	1208	-	290	290	36	-	1074	Straight	6
80	K Series	Base Edge Assembly	347-7585	1208	-	290	290	36	-	1074	Straight	6
80	Advansys	Base Edge Assembly	541-1869	1208	-	290	290	36	-	1074	Straight	6
80	K Series	Base Edge Assembly	347-7586	1258	-	290	290	36	-	1124	Straight	5
80	K Series	Base Edge Assembly	347-7586	1258	-	290	290	36	-	1124	Straight	5
80	Advansys	Base Edge Assembly	541-1865	1258	-	290	290	36	-	1124	Straight	5
80	K Series	Base Edge Assembly	347-7587	1298	-	290	290	36	-	1164	Straight	5
80	K Series	Base Edge Assembly	347-7587	1298	-	290	290	36	-	1164	Straight	5
80	Advansys	Base Edge Assembly	544-2670	1298	-	290	290	36	-	1164	Straight	5
80	K Series	Base Edge Assembly	347-7588	1360	-	290	290	36	-	1226	Straight	7
80	K Series	Base Edge Assembly	347-7588	1360	-	290	290	36	-	1226	Straight	7
80	Advansys	Base Edge Assembly	552-6868	1360	-	290	290	36	-	1226	Straight	7
80	K Series	Base Edge Assembly	347-7589	1398	-	290	290	36	-	1264	Straight	5
80	K Series	Base Edge Assembly	347-7589	1398	-	290	290	36	-	1264	Straight	5
80	Advansys	Base Edge Assembly	544-2703	1398	-	290	290	36	-	1264	Straight	5
80	K Series	Base Edge Assembly	(348-3088)	1258	-	290	290	36	-	1124	Straight	6
80	K Series	Base Edge Assembly	(348-3088)	1258	-	290	290	36	-	1124	Straight	6
80	K Series	Base Edge Assembly	(348-3203)	996	-	290	290	36	-	849.6	Straight	5
80	K Series	Base Edge Assembly	(348-3203)	996	-	290	290	36	-	849.6	Straight	5
80	K Series	Base Edge Assembly	357-9720*	1404	-	250	250	36	22.5	1270	Straight	5
80	K Series	Base Edge Assembly	357-9720*	1404	-	250	250	36	22.5	1270	Straight	5
80	Advansys	Base Edge Assembly	560-3388	1404	-	250	250	36	22.5	1270	Straight	5
80	K Series	Base Edge Assembly	358-8602*	1208	-	250	250	36	-	1074	Straight	5
80	K Series	Base Edge Assembly	358-8602*	1208	-	250	250	36	-	1074	Straight	5
80	Advansys	Base Edge Assembly	544-2678	1208	-	250	250	36	-	1074	Straight	5
80	K Series	Base Edge Assembly	361-0518	902	-	250	250	36	-	768	Straight	4
80	K Series	Base Edge Assembly	361-0518	902	-	250	250	36	-	768	Straight	4
80	Advansys	Base Edge Assembly	544-2633	902	-	250	250	36	-	768	Straight	4
80	K Series	Base Edge Assembly	362-9163	1306	-	250	250	36	-	1172	Straight	5
80	K Series	Base Edge Assembly	362-9163	1306	-	250	250	36	-	1172	Straight	5
80	Advansys	Base Edge Assembly	544-2684	1306	-	250	250	36	-	1172	Straight	5
80	K Series	Base Edge Assembly	365-2276	1056	-	290	290	36	-	922	Straight	4
80	K Series	Base Edge Assembly	365-2276	1056	-	290	290	36	-	922	Straight	4
80	Advansys	Base Edge Assembly	544-2655	1056	-	290	290	36	-	922	Straight	4
80	K Series	Base Edge Assembly	365-6127	1300	-	250	250	36	-	1172	Straight	5
80	K Series	Base Edge Assembly	365-6127	1300	-	250	250	36	-	1172	Straight	5
80	K Series	Base Edge Assembly	371-9180	998	-	290	290	36	-	864	Straight	4
80	K Series	Base Edge Assembly	371-9180	998	-	290	290	36	-	864	Straight	4
80	Advansys	Base Edge Assembly	557-1760	998	-	290	290	36	-	864	Straight	4
80	K Series	Base Edge Assembly	371-9181	1512	-	290	290	36	-	1378	Straight	5
80	K Series	Base Edge Assembly	371-9181	1512	-	290	290	36	-	1378	Straight	5
80	Advansys	Base Edge Assembly	557-1761	1512	-	290	290	36	-	1378	Straight	5
80	K Series	Base Edge Assembly	372-4168*	760	-	465	465	36	-	656	Stepped	3
80	K Series	Base Edge Assembly	372-4168*	760	-	465	465	36	-	656	Stepped	3
80	K Series	Base Edge Assembly	(372-8136)	1134	-	290	290	36	-	1038	Straight	5
80	K Series	Base Edge Assembly	(372-8136)	1134	-	290	290	36	-	1038	Straight	5
80	K Series	Base Edge Assembly	376-4825	1091	-	250	250	36	-	957	Straight	4

Cat Hydraulic Excavators

BASE EDGE TABLE

Base Edge Dimensional Reference												
Adapter Size Class	Adapter Series	Edge Type	Part Number								Edge Style	Adapter Quantity Welded on Edge
				A	B	C	D	E	F	G		
80	K Series	Base Edge Assembly	376-4825	1091	-	250	250	36	-	957	Straight	4
80	Advansys	Base Edge Assembly	544-2712	1091	-	250	250	36	-	957	Straight	4
80	K Series	Base Edge Assembly	377-2247	754	-	250	250	36	-	620	Straight	3
80	K Series	Base Edge Assembly	377-2247	754	-	250	250	36	-	620	Straight	3
80	Advansys	Base Edge Assembly	544-2699	754	-	250	250	36	-	620	Straight	3
80	K Series	Base Edge Assembly	378-0380	549	-	290	290	36	-	465	Straight	3
80	K Series	Base Edge Assembly	378-0380	549	-	290	290	36	-	465	Straight	3
80	K Series	Base Edge Assembly	378-0381	704	-	290	290	36	-	620	Straight	4
80	K Series	Base Edge Assembly	378-0382	852	-	290	290	36	-	768	Straight	5
80	K Series	Base Edge Assembly	378-0382	852	-	290	290	36	-	768	Straight	5
80	K Series	Base Edge Assembly	378-0383	1006	-	290	290	36	-	922	Straight	6
80	K Series	Base Edge Assembly	378-0383	1006	-	290	290	36	-	922	Straight	6
80	K Series	Base Edge Assembly	378-0384	1158/1220	-	290	290	36	-	1074	Straight	7
80	K Series	Base Edge Assembly	378-0384	1158/1220	-	290	290	36	-	1074	Straight	7
80	Advansys	Base Edge Assembly	541-1870	1158/1220	-	290	290	36	-	1074	Straight	7
80	K Series	Base Edge Assembly	378-0385	1310	-	290	290	36	-	1226	Straight	8
80	K Series	Base Edge Assembly	378-0385	1310	-	290	290	36	-	1226	Straight	8
80	K Series	Base Edge Assembly	379-1799	535	-	250	250	36	-	401	Straight	3
80	K Series	Base Edge Assembly	379-1799	535	-	250	250	36	-	401	Straight	3
80	K Series	Base Edge Assembly	379-2936	1056	-	250	250	36	-	922	Straight	4
80	K Series	Base Edge Assembly	379-2936	1056	-	250	250	36	-	922	Straight	4
80	K Series	Base Edge Assembly	381-7258	549	-	250	250	36	-	465	Straight	3
80	K Series	Base Edge Assembly	381-7258	549	-	250	250	36	-	465	Straight	3
80	K Series	Base Edge Assembly	381-7259	704	-	250	250	36	-	620	Straight	4
80	K Series	Base Edge Assembly	381-7259	704	-	250	250	36	-	620	Straight	4
80	K Series	Base Edge Assembly	381-7260	1006	-	250	250	36	-	922	Straight	6
80	K Series	Base Edge Assembly	381-7260	1006	-	250	250	36	-	922	Straight	6
80	K Series	Base Edge Assembly	381-7261	1158	-	250	250	36	-	1074	Straight	7
80	K Series	Base Edge Assembly	381-7261	1158	-	250	250	36	-	1074	Straight	7
80	K Series	Base Edge Assembly	390-3447	754	-	250	250	36	-	620	Straight	3
80	K Series	Base Edge Assembly	390-3447	754	-	250	250	36	-	620	Straight	3
80	K Series	Base Edge Assembly	390-3448	1091	-	250	250	36	-	957	Straight	4
80	K Series	Base Edge Assembly	390-3448	1091	-	250	250	36	-	957	Straight	4
80	K Series	Base Edge Assembly	390-3449	1208	-	250	250	36	-	1074	Straight	5
80	K Series	Base Edge Assembly	390-3449	1208	-	250	250	36	-	1074	Straight	5
80	K Series	Base Edge Assembly	390-3450	1404	-	250	250	36	-	1270	Straight	5
80	K Series	Base Edge Assembly	390-3450	1404	-	250	250	36	-	1270	Straight	5
80	K Series	Base Edge Assembly	397-8626	1056	-	250	250	36	-	922	Straight	5
80	K Series	Base Edge Assembly	397-8626	1056	-	250	250	36	-	922	Straight	5
80	Advansys	Base Edge Assembly	557-1735	1056	-	250	250	36	-	922	Straight	5
80	K Series	Base Edge Assembly	416-5447	1208	-	290	290	36	-	1074	Straight	5
80	K Series	Base Edge Assembly	416-5447	1208	-	290	290	36	-	1074	Straight	5
80	K Series	Base Edge Assembly	416-5448	1298	-	290	290	36	-	1164	Straight	5
80	K Series	Base Edge Assembly	416-5448	1298	-	290	290	36	-	1164	Straight	5
80	K Series	Base Edge Assembly	425-1005	500	-	250	250	36	-	365	Straight	3
80	K Series	Base Edge Assembly	425-1005	500	-	250	250	36	-	365	Straight	3
80	K Series	Base Edge Assembly	425-3855	927	-	250	250	36	-	793	Straight	4
80	K Series	Base Edge Assembly	425-3855	927	-	250	250	36	-	793	Straight	4
80	Advansys	Base Edge Assembly	544-2715	927	-	250	250	36	-	793	Straight	4
80	K Series	Base Edge Assembly	431-5168	1100	-	290	290	36	-	966	Straight	4
80	K Series	Base Edge Assembly	431-5168	1100	-	290	290	36	-	966	Straight	4
80	K Series	Base Edge Assembly	440-1463	927	-	250	250	36	-	793	Straight	5
80	K Series	Base Edge Assembly	440-1463	927	-	250	250	36	-	793	Straight	5
80	K Series	Base Edge Assembly	446-1220	450	-	250	250	36	-	317	Straight	3
80	K Series	Base Edge Assembly	446-1220	450	-	250	250	36	-	317	Straight	3
80	K Series	Base Edge Assembly	457-7646	472	-	250	250	36	-	338	Straight	3
80	K Series	Base Edge Assembly	457-7646	472	-	250	250	36	-	338	Straight	3
80	K Series	Base Edge Assembly	476-0396	704	-	250	250	36	-	570	Straight	3
80	K Series	Base Edge Assembly	476-0396	704	-	250	250	36	-	570	Straight	3
80	K Series	Base Edge Assembly	(487-1633)	998	-	250	250	36	-	864	Straight	4
80	K Series	Base Edge Assembly	(487-1633)	998	-	250	250	36	-	864	Straight	4
80	K Series	Base Edge Assembly	(487-1640)	1238	-	250	250	36	-	1104	Straight	5
80	K Series	Base Edge Assembly	(487-1640)	1238	-	250	250	36	-	1104	Straight	5
80	K Series	Base Edge Assembly	(488-0107)	674	-	250	250	36	-	540	Straight	3
80	K Series	Base Edge Assembly	(488-0107)	674	-	250	250	36	-	540	Straight	3
80	K Series	Base Edge Assembly	488-0120	814	-	250	250	36	-	680	Straight	3
80	K Series	Base Edge Assembly	488-0120	814	-	250	250	36	-	680	Straight	3
80	K Series	Base Edge Assembly	488-0124	1020	-	250	250	36	-	886	Straight	4
80	K Series	Base Edge Assembly	488-0124	1020	-	250	250	36	-	886	Straight	4
80	K Series	Base Edge Assembly	488-0127	1230	-	250	250	36	-	1096	Straight	5

Base Edge Dimensional Reference

Adapter Size Class	Adapter Series	Edge Type	Part Number								Edge Style	Adapter Quantity Welded on Edge
				A	B	C	D	E	F	G		
80	K Series	Base Edge Assembly	488-0127	1230	-	250	250	36	-	1096	Straight	5
80	K Series	Base Edge Assembly	492-3723	1398	-	290	290	36	-	1264	Straight	5
80	K Series	Base Edge Assembly	492-3723	1398	-	290	290	36	-	1264	Straight	5
80	K Series	Base Edge Assembly	510-4528	902	-	250	250	36	-	768	Straight	5
80	K Series	Base Edge Assembly	510-4528	902	-	250	250	36	-	768	Straight	5
80	Advansys	Base Edge Assembly	552-8331	902	-	250	250	36	-	768	Straight	5
80	K Series	Base Edge Assembly	513-9535	521	-	250	250	35	-	386	Straight	3
80	K Series	Base Edge Assembly	513-9535	521	-	250	250	35	-	386	Straight	3
80	K Series	Base Edge Assembly	514-7630	629	-	250	250	35	-	495.4	Straight	3
80	K Series	Base Edge Assembly	514-7630	629	-	250	250	35	-	495.4	Straight	3
80	Advansys	Base Edge Assembly	555-7401	629	-	250	250	35	-	495.4	Straight	3
80	K Series	Base Edge Assembly	516-7763	629	-	250	250	35	-	488	Straight	4
80	K Series	Base Edge Assembly	516-7763	629	-	250	250	35	-	488	Straight	4
80	K Series	Base Edge Assembly	516-9289	1208	-	250	250	36	-	1074	Straight	5
80	K Series	Base Edge Assembly	516-9289	1208	-	250	250	36	-	1074	Straight	5
80	K Series	Base Edge Assembly	520-7468	772	-	250	250	35	22.5	638	Straight	4
80	K Series	Base Edge Assembly	520-7468	772	-	250	250	35	22.5	638	Straight	4
80	Advansys	Base Edge Assembly	558-8000	772	-	250	250	35	22.5	638	Straight	4
80	Advansys	Base Edge Assembly	541-1867	1158	-	290	290	36	-	1004	Straight	4
80	Advansys	Base Edge Assembly	541-1868	1245	-	290	290	35	-	1099.6	Straight	6
80	K Series	Base Edge Assembly	525-8903	1198	-	290	290	36	-	1064	Straight	5
80	K Series	Base Edge Assembly	525-8903	1198	-	290	290	36	-	1064	Straight	5
80	K Series	Base Edge Assembly	347-7469	1032	-	290	290	36	-	869.8	Straight	5
80	K Series	Base Edge Assembly	347-7469	1032	-	290	290	36	-	869.8	Straight	5
80	Advansys	Base Edge Assembly	552-3372	1032	-	290	290	36	-	869.8	Straight	5
80	K Series	Conversion Edge	232-0026	1204	-	250	250	36	-	-	Straight	4
80	K Series	Conversion Edge	232-0026	1204	-	250	250	36	-	-	Straight	4
80	K Series	Base Edge Assembly	250-0563*	1201	-	300	300	35	-	1048.6	Straight	7
80	K Series	Base Edge Assembly	250-0563*	1201	-	300	300	35	-	1048.6	Straight	7
80	K Series	Base Edge Assembly	(241-4215)	1359	-	247	247	35	-	1195.6	Straight	8
80	K Series	Base Edge Assembly	(241-4215)	1359	-	247	247	35	-	1195.6	Straight	8
80	K Series	Base Edge Assembly	270-7136*	914.4	-	279.4	279.4	35	-	-	Straight	3
80	K Series	Base Edge Assembly	270-7136*	914.4	-	279.4	279.4	35	-	-	Straight	3
80	K Series	Base Edge Assembly	286-1047*	1348	-	250	250	35	-	1195.6	Straight	8
80	K Series	Base Edge Assembly	286-1047*	1348	-	250	250	35	-	1195.6	Straight	8
80	K Series	Base Edge Assembly	292-4019*	1400	-	290	290	36	-	1304	Straight	9
80	K Series	Base Edge Assembly	292-4019*	1400	-	290	290	36	-	1304	Straight	9
80	K Series	Base Edge Assembly	250-0538*	727	-	300	300	35	-	648	Straight	4
80	K Series	Base Edge Assembly	250-0538*	727	-	300	300	35	-	648	Straight	4
80	K Series	Base Edge Assembly	277-2372*	879	-	250	250	35	-	789	Straight	5
80	K Series	Base Edge Assembly	277-2372*	879	-	250	250	35	-	789	Straight	5
80	K Series	Base Edge Assembly	302-6464*	1068	-	300	300	35	-	945	Straight	5
80	K Series	Base Edge Assembly	302-6464*	1068	-	300	300	35	-	945	Straight	5
80	K Series	Base Edge Assembly	279-3911*	800	-	290	290	36	-	704	Straight	3
80	K Series	Base Edge Assembly	279-3911*	800	-	290	290	36	-	704	Straight	3
80	K Series	Base Edge Assembly	308-5017*	424	-	230	230	35	-	340	Straight	3
80	K Series	Base Edge Assembly	308-5017*	424	-	230	230	35	-	340	Straight	3
80	K Series	Base Edge Assembly	252-5491*	600	-	290	290	36	-	504	Straight	3
80	K Series	Base Edge Assembly	252-5491*	600	-	290	290	36	-	504	Straight	3
80	K Series	Base Edge Assembly	253-9580*	1100	-	290	290	36	-	-	Straight	3
80	K Series	Base Edge Assembly	253-9580*	1100	-	290	290	36	-	-	Straight	3
80	K Series	Base Edge Assembly	250-0539*	902	-	300	300	35	-	823	Straight	5
80	K Series	Base Edge Assembly	250-0539*	902	-	300	300	35	-	823	Straight	5
80	K Series	Base Edge Assembly	279-3914*	1300	-	290	290	36	-	1204	Straight	5
80	K Series	Base Edge Assembly	279-3914*	1300	-	290	290	36	-	1204	Straight	5
80	K Series	Base Edge Assembly	296-0338*	990	-	240	240	36	-	898	Straight	4
80	K Series	Base Edge Assembly	296-0338*	990	-	240	240	36	-	898	Straight	4
80	K Series	Base Edge Assembly	279-3912*	900	-	290	290	36	-	804	Straight	4
80	K Series	Base Edge Assembly	279-3912*	900	-	290	290	36	-	804	Straight	4
80	K Series	Base Edge Assembly	279-3913*	1100	-	290	290	36	-	1004	Straight	4
80	K Series	Base Edge Assembly	279-3913*	1100	-	290	290	36	-	1004	Straight	4
80	K Series	Base Edge Assembly	241-4210*	563	-	250	250	35	-	434.6	Straight	3
80	K Series	Base Edge Assembly	241-4210*	563	-	250	250	35	-	434.6	Straight	3
80	K Series	Base Edge Assembly	250-0564*	1348	-	300	300	35	-	1195.6	Straight	8
80	K Series	Base Edge Assembly	250-0564*	1348	-	300	300	35	-	1195.6	Straight	8
80	K Series	Base Edge Assembly	279-3910*	750	-	290	290	36	-	654	Straight	3
80	K Series	Base Edge Assembly	279-3910*	750	-	290	290	36	-	654	Straight	3
80	K Series	Base Edge Assembly	323-5740*	1200	-	290	290	36	-	1104	Straight	7
80	K Series	Base Edge Assembly	323-5740*	1200	-	290	290	36	-	1104	Straight	7
80	K Series	Base Edge Assembly	300-4628*	563	-	250	250	35	-	418.6	Straight	3
80	K Series	Base Edge Assembly	300-4628*	563	-	250	250	35	-	418.6	Straight	3

Cat Hydraulic Excavators

BASE EDGE TABLE

Base Edge Dimensional Reference												
Adapter Size Class	Adapter Series	Edge Type	Part Number								Edge Style	Adapter Quantity Welded on Edge
				A	B	C	D	E	F	G		
80	K Series	Base Edge Assembly	241-4213*	1029.2	-	250	250	35	-	900.8	Straight	6
80	K Series	Base Edge Assembly	241-4213*	1029.2	-	250	250	35	-	900.8	Straight	6
80	K Series	Base Edge Assembly	250-0537*	586	-	300	300	35	-	507	Straight	3
80	K Series	Base Edge Assembly	250-0537*	586	-	300	300	35	-	507	Straight	3
80	K Series	Base Edge Assembly	253-9575*	1400	-	290	290	36	-	-	Straight	4
80	K Series	Base Edge Assembly	253-9575*	1400	-	290	290	36	-	-	Straight	4
80	K Series	Base Edge Assembly	252-5492*	750	-	290	290	36	-	654	Straight	3
80	K Series	Base Edge Assembly	252-5492*	750	-	290	290	36	-	654	Straight	3
80	K Series	Base Edge Assembly	308-5744*	572	-	230	230	35	-	488	Straight	4
80	K Series	Base Edge Assembly	308-5744*	572	-	230	230	35	-	488	Straight	4
80	K Series	Base Edge Assembly	241-4212*	879	-	250	250	35	-	750.6	Straight	5
80	K Series	Base Edge Assembly	241-4212*	879	-	250	250	35	-	750.6	Straight	5
80	K Series	Base Edge Assembly	279-3915*	1400	-	290	290	36	-	1304	Straight	5
80	K Series	Base Edge Assembly	279-3915*	1400	-	290	290	36	-	1304	Straight	5
80	K Series	Base Edge Assembly	240-9607*	1359	-	247	247	35	-	1268	Straight	6
80	K Series	Base Edge Assembly	240-9607*	1359	-	247	247	35	-	1268	Straight	6
80	K Series	Base Edge Assembly	253-8161*	1187	-	247	247	35	-	1096	Straight	6
80	K Series	Base Edge Assembly	253-8161*	1187	-	247	247	35	-	1096	Straight	6
80	K Series	Base Edge Assembly	240-9603*	704	-	250	250	35	-	648	Straight	4
80	K Series	Base Edge Assembly	240-9603*	704	-	250	250	35	-	648	Straight	4
80	K Series	Base Edge Assembly	286-6920*	800	-	290	290	36	-	704	Straight	4
80	K Series	Base Edge Assembly	286-6920*	800	-	290	290	36	-	704	Straight	4
80	K Series	Base Edge Assembly	291-0632*	1515	-	250	250	35	-	1375	Straight	9
80	K Series	Base Edge Assembly	291-0632*	1515	-	250	250	35	-	1375	Straight	9
80	K Series	Base Edge Assembly	252-5490*	500	-	290	290	36	-	404	Straight	3
80	K Series	Base Edge Assembly	252-5490*	500	-	290	290	36	-	404	Straight	3
80	K Series	Conversion Edge	253-9581*	1200	-	290	290	36	-	-	Straight	3
80	K Series	Conversion Edge	253-9581*	1200	-	290	290	36	-	-	Straight	3
80	K Series	Base Edge Assembly	296-0340*	590	-	240	240	36	-	498	Straight	3
80	K Series	Base Edge Assembly	296-0340*	590	-	240	240	36	-	498	Straight	3
80	K Series	Base Edge Assembly	276-4178*	450	-	290	290	36	-	354	Straight	3
80	K Series	Base Edge Assembly	276-4178*	450	-	290	290	36	-	354	Straight	3
80	K Series	Base Edge Assembly	250-0560*	727	-	300	300	35	-	575.6	Straight	4
80	K Series	Base Edge Assembly	250-0560*	727	-	300	300	35	-	575.6	Straight	4
80	K Series	Base Edge Assembly	271-5409*	1000	-	290	290	36	-	904	Straight	4
80	K Series	Base Edge Assembly	271-5409*	1000	-	290	290	36	-	904	Straight	4
80	K Series	Base Edge Assembly	250-0561*	902	-	300	300	35	-	750.6	Straight	5
80	K Series	Base Edge Assembly	250-0561*	902	-	300	300	35	-	750.6	Straight	5
80	K Series	Base Edge Assembly	297-2393*	1500	-	290	290	36	-	1404	Straight	9
80	K Series	Base Edge Assembly	297-2393*	1500	-	290	290	36	-	1404	Straight	9
80	K Series	Base Edge Assembly	241-4211*	704	-	250	250	35	-	575.6	Straight	4
80	K Series	Base Edge Assembly	241-4211*	704	-	250	250	35	-	575.6	Straight	4
80	K Series	Base Edge Assembly	250-0559*	586	-	300	300	35	-	434.6	Straight	3
80	K Series	Base Edge Assembly	250-0559*	586	-	300	300	35	-	434.6	Straight	3
80	K Series	Base Edge Assembly	250-0540*	1053	-	300	300	35	-	973.2	Straight	5
80	K Series	Base Edge Assembly	250-0540*	1053	-	300	300	35	-	973.2	Straight	5
80	K Series	Base Edge Assembly	273-0009*	1300	-	290	290	36	-	1204	Straight	8
80	K Series	Base Edge Assembly	273-0009*	1300	-	290	290	36	-	1204	Straight	8
80	K Series	Base Edge Assembly	296-0339*	790	-	240	240	36	-	698	Straight	3
80	K Series	Base Edge Assembly	296-0339*	790	-	240	240	36	-	698	Straight	3
80	K Series	Base Edge Assembly	253-0132*	595	-	250	250	36	-	-	Straight	2
80	K Series	Base Edge Assembly	253-0132*	595	-	250	250	36	-	-	Straight	2
80	K Series	Base Edge Assembly	353-0142*	1208	-	300	300	35	-	1074	Straight	5
80	K Series	Base Edge Assembly	353-0142*	1208	-	300	300	35	-	1074	Straight	5
80	Advansys	Base Edge Assembly	544-2736	620	-	230	230	36	-	488	Straight	3
80	Advansys	Base Edge Assembly	544-2737	770	-	230	230	36	-	638	Straight	4
80	Advansys	Base Edge Assembly	544-2738	925	-	230	230	36	-	793	Straight	5
80	Advansys	Base Edge Assembly	544-2739	1077	-	230	230	36	-	945	Straight	5
80	Advansys	Base Edge Assembly	552-3406	1198	-	290	290	36	-	1074	Straight	7
80	K Series	Base Edge Assembly	(392-8128)	1134	-	290	290	36	-	972	Straight	5
80	K Series	Base Edge Assembly	(392-8128)	1134	-	290	290	36	-	972	Straight	5
80	Advansys	Base Edge Assembly	552-3373	1134	-	290	290	36	-	972	Straight	5
80	K Series	Base Edge Assembly	392-8129	1230	-	290	290	36	-	1068	Straight	5
80	K Series	Base Edge Assembly	392-8129	1230	-	290	290	36	-	1068	Straight	5
80	Advansys	Base Edge Assembly	552-3374	1230	-	290	290	36	-	1068	Straight	5
80	Advansys	Base Edge Assembly	552-3377	897	-	230	230	36	-	768.4	Straight	4
80	Advansys	Base Edge Assembly	552-3376	797	-	230	230	36	-	668.4	Straight	4
80	Advansys	Base Edge Assembly	557-1754	970	-	230	230	36	-	840	Straight	5
80	Advansys	Base Edge Assembly	556-0169	599	-	290	290	36	-	465	Straight	3
80	Advansys	Base Edge Assembly	556-0171	902	-	290	290	36	-	768	Straight	5
80	Advansys	Base Edge Assembly	556-0172	1056	-	290	290	36	-	922	Straight	6

Discontinued
Canceled
(Reference)

Part is discontinued. Please contact your service representative.
Part is canceled. Please contact your customer service representative.
Part number is not serviceable. For reference only.

Base Edge Dimensional Reference

Adapter Size Class	Adapter Series	Edge Type	Part Number								Edge Style	Adapter Quantity Welded on Edge
				A	B	C	D	E	F	G		
80	Advansys	Base Edge Assembly	556-0173	1360	-	290	290	36	-	1226	Straight	8
80	Advansys	Base Edge Assembly	556-0174	754	-	290	290	36	-	620	Straight	4
80	Advansys	Base Edge Assembly	563-0200	1360	-	290	290	36	22.5	1204	Straight	5
80	Advansys	Base Edge Assembly	563-0201	1090	-	250	250	35	22.5	947.6	Straight	5
80	Advansys	Base Edge Assembly	563-0202	935	-	250	250	36	22.5	795.6	Straight	5
80	Advansys	Base Edge Assembly	(575-5293)	1120	-	230	230	36	22.5	995.6	Straight	6
90	K Series	Base Edge Assembly	333-2379*	900	-	300	300	40	-	804	Straight	3
90	K Series	Base Edge Assembly	229-6627	913	-	300	300	40	-	-	Straight	5
90	K Series	Base Edge Assembly	489-6708	1574	-	406	406	40	-	912	Straight	6
90	K Series	Base Edge Assembly	337-1808*	1200	-	400	400	40	-	1104	Stepped	4
90	K Series	Base Edge Assembly	239-2642	1053.2	-	300	300	40	-	973.2	Straight	5
90	Advansys	Base Edge Assembly	540-4065	1053.2	-	300	300	40	-	973.2	Straight	5
90	K Series	Base Edge Assembly	250-9674	1400 \ 1450	-	300	300	40	-	1290	Straight	5
90	Advansys	Base Edge Assembly	541-1890	1400 \ 1450	-	300	300	40	-	1290	Straight	5
90	K Series	Base Edge Assembly	250-9676	1600	-	300	300	40	-	1490	Straight	5
90	K Series	Base Edge Assembly	(282-6441)	1600	-	300	300	40	-	1490	Straight	8
90	K Series	Base Edge Assembly	235-2498	1359 \ 1416	-	300	300	40	-	1268	Straight	6
90	Advansys	Base Edge Assembly	540-4066	1359 \ 1416	-	300	300	40	-	1268	Straight	6
90	K Series	Base Edge Assembly	290-1167*	700	-	300	300	40	-	604	Straight	3
90	K Series	Base Edge Assembly	250-2886	1491	-	300	300	40	-	1372	Straight	6
90	K Series	Base Edge Assembly	239-2818*	750	-	250	250	40	-	641.2	Straight	4
90	K Series	Base Edge Assembly	250-9673	1350	-	300	300	40	-	1240	Straight	5
90	K Series	Base Edge Assembly	239-2801*	1208	-	250	250	40	-	1099.2	Straight	6
90	K Series	Base Edge Assembly	257-2255*	1000	-	300	300	40	-	890	Straight	4
90	K Series	Base Edge Assembly	251-8668*	750	-	300	300	40	-	654	Straight	3
90	K Series	Base Edge Assembly	251-8671	1400	-	300	300	40	-	1304	Straight	5
90	K Series	Base Edge Assembly	(229-7704)	1320	-	325	325	40	-	1250	Straight	6
90	K Series	Base Edge Assembly	250-9672*	1300	-	300	300	40	-	1190	Straight	5
90	K Series	Base Edge Assembly	351-0422	-	-	-	-	-	-	-	-	5
90	K Series	Base Edge Assembly	239-2792*	1056	-	250	250	40	-	947.2	Straight	5
90	K Series	Base Edge Assembly	269-8509*	1200	-	300	300	40	-	1104	Straight	4
90	K Series	Base Edge Assembly	227-8740	597	-	300	300	40	-	507	Straight	3
90	K Series	Base Edge Assembly	(261-9706)	1600	-	300	300	40	-	1504	Straight	5
90	K Series	Base Edge Assembly	250-9670*	750	-	300	300	40	-	640	Straight	3
90	K Series	Base Edge Assembly	(235-2497)	615.8	-	300	300	40	-	526	Straight	3
90	K Series	Base Edge Assembly	350-4270	-	-	-	-	-	-	-	-	4
90	K Series	Base Edge Assembly	228-6952	913	-	300	300	40	-	823	Straight	5
90	K Series	Conversion Edge	232-0029	913	-	300	300	40	-	823	Straight	5
90	K Series	Base Edge Assembly	239-2716*	904	-	250	250	40	-	795.2	Straight	5
90	K Series	Base Edge Assembly	228-6951*	738	-	300	300	40	-	648	Straight	4
90	K Series	Base Edge Assembly	228-6953	1064	-	300	300	40	-	973.2	Straight	5
90	Advansys	Base Edge Assembly	540-4065	1064	-	300	300	40	-	973.2	Straight	5
90	K Series	Conversion Edge	232-0030	1064	-	300	300	40	-	973.2	Straight	5
90	K Series	Base Edge Assembly	239-2819*	599	-	250	250	40	-	490.2	Straight	3
90	K Series	Base Edge Assembly	239-2545*	905	-	300	300	40	-	825	Straight	5
90	K Series	Base Edge Assembly	225-6813	1212	-	300	300	40	-	1121	Straight	6
90	Advansys	Base Edge Assembly	540-4064	1212	-	300	300	40	-	1121	Straight	6
90	K Series	Conversion Edge	232-0031	1212	-	300	300	40	-	1121	Straight	6
90	K Series	Base Edge Assembly	239-2634*	728	-	300	300	40	-	648	Straight	4
90	K Series	Base Edge Assembly	250-9671	1250	-	300	300	40	-	1140	Straight	4
90	K Series	Base Edge Assembly	250-9675	1500 \ 1550	-	300	300	40	-	1390	Straight	5
90	Advansys	Base Edge Assembly	540-4063	1500 \ 1550	-	300	300	40	-	1390	Straight	5
90	K Series	Base Edge Assembly	239-2650	1201	-	300	300	40	-	1121	Straight	6
90	Advansys	Base Edge Assembly	540-4064	1201	-	300	300	40	-	1121	Straight	6
90	K Series	Base Edge Assembly	239-2676*	587	-	300	300	40	-	507	Straight	3
90	K Series	Base Edge Assembly	251-8670	1300	-	300	300	40	-	1204	Straight	5
90	K Series	Base Edge Assembly	517-0146	1224	-	300	300	40	-	1074	Straight	5
90	K Series	Base Edge Assembly	513-2144	1072	-	250	250	40	-	922	Straight	5
90	K Series	Base Edge Assembly	513-2146	1072	-	300	300	40	-	922	Straight	5
90	K Series	Base Edge Assembly	(492-3815)	820	-	300	300	40	-	670	Straight	3
90	K Series	Base Edge Assembly	348-3095	1314	-	300	300	40	-	1164	Straight	5
90	Advansys	Base Edge Assembly	540-4075	1314	-	300	300	40	-	1164	Straight	5
90	K Series	Base Edge Assembly	293-7844	1224	-	250	250	40	-	1074	Straight	6
90	Advansys	Base Edge Assembly	540-4072	1224	-	250	250	40	-	1074	Straight	6
90	K Series	Base Edge Assembly	378-0396	1014	-	300	300	40	-	864	Straight	4
90	Advansys	Base Edge Assembly	557-3508	1014	-	300	300	40	-	864	Straight	4
90	K Series	Base Edge Assembly	378-0397	1600	-	300	300	40	-	1450	Straight	5
90	Advansys	Base Edge Assembly	557-3509	1600	-	300	300	40	-	1450	Straight	5
90	K Series	Base Edge Assembly	279-4096*	1528	1462	300	300	40	22.6	1378	Straight	7
90	Advansys	Base Edge Assembly	557-1765	1528	1462	300	300	40	22.6	1378	Straight	7

Cat Hydraulic Excavators

BASE EDGE TABLE

Base Edge Dimensional Reference												
Adapter Size Class	Adapter Series	Edge Type	Part Number								Edge Style	Adapter Quantity Welded on Edge
				A	B	C	D	E	F	G		
90	K Series	Base Edge Assembly	279-4094	1224	-	300	300	40	-	1074	Straight	6
90	Advansys	Base Edge Assembly	540-4072	1224	-	300	300	40	-	1074	Straight	6
90	K Series	Base Edge Assembly	450-9092	615	-	322.5	322.5	40	-	465	Stepped	4
90	K Series	Base Edge Assembly	279-4095	1376	-	300	300	40	-	1226	Straight	7
90	Advansys	Base Edge Assembly	540-4073	1376	-	300	300	40	-	1226	Straight	7
90	K Series	Base Edge Assembly	(349-8480)	1105	-	250	250	40	-	957	Straight	5
90	K Series	Base Edge Assembly	293-7842	918	-	250	250	40	-	768	Straight	5
90	K Series	Base Edge Assembly	279-4092	918	-	300	300	40	-	768	Straight	5
90	Advansys	Base Edge Assembly	540-4070	918	-	300	300	40	-	768	Straight	5
90	K Series	Base Edge Assembly	476-9207	1072	-	300	300	40	-	922	Straight	5
90	K Series	Base Edge Assembly	418-9246*	918	-	300	300	40	-	768	Straight	4
90	K Series	Base Edge Assembly	348-3099	1224	-	356	356	40	-	1074	Stepped	4
90	Advansys	Base Edge Assembly	557-1767	1224	-	356	356	40	-	1074	Stepped	4
90	K Series	Base Edge Assembly	450-3570	918	-	329	329	40	-	768	Stepped	4
90	K Series	Base Edge Assembly	348-3098	1680	-	300	300	40	-	1530	Straight	6
90	K Series	Base Edge Assembly	293-7841*	770	-	250	250	40	-	620	Straight	4
90	K Series	Base Edge Assembly	334-9203	770	-	400	400	40	-	620	Stepped	3
90	K Series	Base Edge Assembly	279-4090	615	-	300	300	40	-	465	Straight	3
90	Advansys	Base Edge Assembly	544-2650	615	-	300	300	40	-	465	Straight	3
90	K Series	Base Edge Assembly	279-4091	770	-	300	300	40	-	620	Straight	4
90	Advansys	Base Edge Assembly	540-4069	770	-	300	300	40	-	620	Straight	4
90	K Series	Base Edge Assembly	279-4093	1072	-	300	300	40	-	922	Straight	5
90	Advansys	Base Edge Assembly	540-4071	1072	-	300	300	40	-	922	Straight	5
90	K Series	Base Edge Assembly	293-7843*	1072	-	250	250	40	-	922	Straight	5
90	Advansys	Base Edge Assembly	557-1724	1072	-	250	250	40	-	922	Straight	5
90	K Series	Base Edge Assembly	348-3093	1072	-	300	300	40	-	922	Straight	4
90	Advansys	Base Edge Assembly	555-7371	1072	-	300	300	40	-	922	Straight	4
90	K Series	Base Edge Assembly	348-3096	1376	-	300	300	40	-	1226	Straight	5
90	Advansys	Base Edge Assembly	555-7372	1376	-	300	300	40	-	1226	Straight	5
90	K Series	Base Edge Assembly	375-6889*	1224	-	300	300	40	-	1074	Straight	5
90	K Series	Base Edge Assembly	454-3459	1416	-	300	300	40	-	1264	Straight	5
90	K Series	Base Edge Assembly	348-3097	1528	-	300	300	40	-	1378	Straight	5
90	Advansys	Base Edge Assembly	544-2503	1528	-	300	300	40	-	1378	Straight	5
90	K Series	Base Edge Assembly	459-6500	1436	-	300	300	40	-	1286	Straight	5
90	K Series	Base Edge Assembly	457-7624	1224	-	356	356	40	-	1074	Stepped	4
90	K Series	Base Edge Assembly	348-3091	770	-	300	300	40	-	620	Straight	3
90	Advansys	Base Edge Assembly	555-7370	770	-	300	300	40	-	620	Straight	3
90	K Series	Base Edge Assembly	348-3094	1224	-	300	300	40	-	1074	Straight	4
90	Advansys	Base Edge Assembly	540-4074	1224	-	300	300	40	-	1074	Straight	4
90	K Series	Base Edge Assembly	348-3092	918	-	300	300	40	-	768	Straight	3
90	K Series	Base Edge Assembly	290-5888*	675.8	-	300	300	40	-	525.8	Straight	3
90	K Series	Base Edge Assembly	371-9146	1376	-	342.7	342.7	40	-	1226	Stepped	5
90	Advansys	Base Edge Assembly	540-4062	1376	-	342.7	342.7	40	-	1226	Stepped	5
90	K Series	Base Edge Assembly	361-4482*	1224	-	250	250	40	-	1074	Straight	4
90	K Series	Base Edge Assembly	465-2320	1528	-	350	350	40	-	1378	Stepped	5
90	K Series	Base Edge Assembly	346-3099*	1224	1158	300	300	40	22.6	1074	Straight	5
90	Advansys	Base Edge Assembly	575-5291	1224	1158	300	300	40	22.6	1074	Straight	5
90	K Series	Base Edge Assembly	335-2182	1495	-	400	400	40	-	1383	Straight	5
90	K Series	Base Edge Assembly	320-6505	1041	-	300	300	40	-	941	Straight	6
90	K Series	Base Edge Assembly	276-5895	1326	-	300	300	40	-	1226	Straight	7
90	Advansys	Base Edge Assembly	540-4068	1326	-	300	300	40	-	1226	Straight	7
90	K Series	Base Edge Assembly	493-5034	1350	-	300	300	40	-	1220	Straight	5
90	K Series	Base Edge Assembly	276-5892*	868	-	300	300	40	-	768	Straight	5
90	K Series	Base Edge Assembly	276-5893*	1022	-	300	300	40	-	922	Straight	5
90	K Series	Base Edge Assembly	276-5891	720	-	300	300	40	-	620	Straight	4
90	K Series	Base Edge Assembly	279-3916*	1200	-	300	300	40	-	1104	Straight	4
90	K Series	Base Edge Assembly	276-5890*	565	-	300	300	40	-	465	Straight	3
90	K Series	Base Edge Assembly	494-2128	1416	-	300	300	40	-	1264	Straight	5
90	K Series	Base Edge Assembly	378-1335	1300	-	300	300	40	-	1164	Straight	5
90	Advansys	Base Edge Assembly	540-4075	1300	-	300	300	40	-	1164	Straight	5
90	K Series	Base Edge Assembly	276-5894	1174	-	300	300	40	-	1074	Straight	6
90	K Series	Conversion Edge	232-0030	1064	-	300	300	40	-	-	Straight	3
90	Advansys	Conversion Edge	547-5091	1064	-	300	300	40	-	-	Straight	3
90	K Series	Base Edge Assembly	255-0372	1054.5	-	290	290	40	-	890	Straight	5
90	K Series	Base Edge Assembly	232-0032	1354	-	300	300	40	-	840	Straight	5
90	Advansys	Base Edge Assembly	547-5093	1354	-	300	300	40	-	840	Straight	5
90	K Series	Base Edge Assembly	(274-5480)	1640	-	300	300	40	-	1517	Straight	6
90	K Series	Base Edge Assembly	232-0027*	606	-	300	300	40	-	-	Straight	1
90	K Series	Base Edge Assembly	255-0385	1174.5	-	290	290	40	-	1010	Straight	5
90	K Series	Base Edge Assembly	232-0028	756	-	300	300	40	-	216	Straight	2
90	K Series	Conversion Edge	238-3199	1212	1212	300	300	40	22.6	-	Straight	3

Discontinued
Canceled
(Reference)

Part is discontinued. Please contact your service representative.
Part is canceled. Please contact your customer service representative.
Part number is not serviceable. For reference only.

Base Edge Dimensional Reference

Adapter Size Class	Adapter Series	Edge Type	Part Number								Edge Style	Adapter Quantity Welded on Edge
				A	B	C	D	E	F	G		
90	Advansys	Conversion Edge	563-0199	1212	1212	300	300	40	22.6	-	Straight	3
90	K Series	Conversion Edge	232-0029	913	-	300	300	40	-	404	Straight	3
90	Advansys	Conversion Edge	547-5092	913	-	300	300	40	-	404	Straight	3
90	K Series	Conversion Edge	232-0031	1212	1212	300	300	40	22.6	-	Straight	4
90	Advansys	Conversion Edge	563-0197	1212	1212	300	300	40	22.6	-	Straight	4
90	K Series	Base Edge Assembly	282-1567*	1000	-	300	300	40	-	904	Straight	4
90	K Series	Base Edge Assembly	253-8209*	1024	-	300	300	40	-	945	Straight	5
90	K Series	Base Edge Assembly	234-9059*	1400	-	300	300	40	-	1282	Straight	6
90	K Series	Base Edge Assembly	265-3004*	1365	-	300	300	40	-	1218	Straight	7
90	K Series	Base Edge Assembly	237-1887*	1064	-	300	300	40	-	889	Straight	6
90	K Series	Base Edge Assembly	237-1886*	913	-	300	300	40	-	738	Straight	5
90	K Series	Conversion Edge	232-0029	913	-	300	300	40	-	738	Straight	5
90	K Series	Base Edge Assembly	236-3946*	1345	-	300	300	40	-	1256	Straight	6
90	K Series	Base Edge Assembly	237-1888*	1212	-	300	300	40	-	1037	Straight	6
90	K Series	Conversion Edge	232-0031	1212	-	300	300	40	-	1037	Straight	6
90	K Series	Base Edge Assembly	253-9576*	1400	-	300	300	40	-	-	Straight	3
90	K Series	Base Edge Assembly	273-0010*	1400	-	300	300	40	-	1290	Straight	7
90	K Series	Base Edge Assembly	245-6354*	1500	-	300	300	40	-	1420	Straight	6
90	K Series	Base Edge Assembly	320-6494*	1524	-	300	300	40	-	1374	Straight	7
90	K Series	Base Edge Assembly	237-1889*	1359	-	300	300	40	-	1184	Straight	7
90	K Series	Base Edge Assembly	266-0243*	1319	-	300	300	40	-	1144	Straight	7
90	K Series	Base Edge Assembly	251-8669*	1250	-	300	300	40	-	1154	Straight	4
90	K Series	Base Edge Assembly	257-3193*	600	-	300	300	40	-	504	Straight	3
90	K Series	Base Edge Assembly	261-9705*	1500	-	300	300	40	-	1404	Straight	5
90	K Series	Base Edge Assembly	237-1885*	738	-	300	300	40	-	563	Straight	4
90	K Series	Base Edge Assembly	273-0011*	1500	-	300	300	40	-	1390	Straight	8
90	K Series	Base Edge Assembly	293-7840*	615	-	250	250	40	-	465	Straight	3
90	K Series	Base Edge Assembly	253-9205*	600	-	300	300	40	-	490	Straight	3
90	K Series	Base Edge Assembly	295-5867*	1640	-	300	300	40	-	1517	Straight	8
90	K Series	Base Edge Assembly	287-6985*	597	-	300	300	40	-	427	Straight	4
90	K Series	Base Edge Assembly	237-1884*	597	-	300	300	40	-	422	Straight	3
90	K Series	Base Edge Assembly	235-2499*	1511	-	300	300	40	-	1420	Straight	7
90	K Series	Base Edge Assembly	253-8153*	1212	-	300	300	40	-	1121	Straight	5
90	K Series	Conversion Edge	238-3199	1212	-	300	300	40	-	1121	Straight	5
90	K Series	Base Edge Assembly	263-5770*	1250	-	400	400	40	-	1154	Stepped	4
90	K Series	Base Edge Assembly	425-5647	1032	-	290	290	40	-	862	Straight	5
90	Advansys	Base Edge Assembly	552-3454	1032	-	290	290	40	-	862	Straight	5
90	K Series	Base Edge Assembly	425-5648	1134	-	290	290	40	-	964	Straight	5
90	Advansys	Base Edge Assembly	552-3455	1134	-	290	290	40	-	964	Straight	5
90	Advansys	Base Edge Assembly	555-7424	615	-	300	300	40	-	465	Straight	3
90	Advansys	Base Edge Assembly	555-7425	770	-	300	300	40	-	620	Straight	4
90	Advansys	Base Edge Assembly	555-7426	918	-	300	300	40	-	768	Straight	5
90	Advansys	Base Edge Assembly	555-7427	1072	-	300	300	40	-	922	Straight	5
90	Advansys	Base Edge Assembly	555-7428	1224	-	300	300	40	-	1074	Straight	6
90	Advansys	Base Edge Assembly	563-0198	1654	1600	300	300	40	22.6	1490	Straight	5
90/100	K Series	Base Edge Assembly	368-2780*	600	-	400	400	40	-	504	Stepped	3
100	K Series	Base Edge Assembly	250-9677*	750	750	305	305	45	22.5	640	Straight	3
100	K Series	Base Edge Assembly	275-2713	1260	1260	325	325	44.5	22.5	1180	Straight	5
100	K Series	Base Edge Assembly	293-8620*	1500	1500	405	305	45	22.5	1390	Stepped	5
100	K Series	Base Edge Assembly	241-6728*	1212	1212	304.8	304.8	44.45	22.5	1121	Straight	5
100	K Series	Conversion Edge	232-0035	1212	1212	304.8	304.8	44.45	22.5	1121	Straight	5
100	K Series	Base Edge Assembly	(239-2481)	1440	1440	350	350	44.5	22.5	1370	Straight	6
100	K Series	Base Edge Assembly	275-3252*	1250	1250	305	305	45	22.5	1140	Straight	4
100	K Series	Base Edge Assembly	229-7953*	1350	1350	325	325	44.5	22.5	1270	Straight	6
100	K Series	Base Edge Assembly	250-9679	1350	1350	305	305	45	22.5	1240	Straight	4
100	K Series	Conversion Edge	253-9577*	1350	1350	305	305	45	22.5	1240	Straight	4
100	K Series	Base Edge Assembly	268-4284*	1600	1600	404.8	304.8	45	22.5	1490	Stepped	5
100	K Series	Base Edge Assembly	239-2875	1230	1230	325	325	44.5	22.5	1150	Straight	5
100	K Series	Base Edge Assembly	384-2215*	750	750	305	305	45	22.5	656	Straight	3
100	K Series	Base Edge Assembly	250-9680	1450	1450	305	305	45	22.5	1340	Straight	5
100	K Series	Base Edge Assembly	241-6730	1511	1511	304.8	304.8	44.45	22.5	1420	Straight	7
100	K Series	Base Edge Assembly	275-2715	1360	1360	325	325	44.5	22.5	1280	Straight	6
100	K Series	Base Edge Assembly	241-6727	1064	1064	304.8	304.8	44.45	22.5	973.2	Straight	5
100	K Series	Conversion Edge	232-0039	1064	1064	304.8	304.8	44.45	22.5	973.2	Straight	5
100	K Series	Base Edge Assembly	264-2665	1700	1700	304.8	304.8	45	22.5	1590	Straight	5
100	K Series	Base Edge Assembly	241-6729	1359	1359	304.8	304.8	44.45	22.5	1268	Straight	6
100	K Series	Conversion Edge	232-0036	1359	1359	304.8	304.8	44.45	22.5	1268	Straight	6
100	K Series	Base Edge Assembly	(239-2588)	1370	1370	350	350	44.45	22.5	1300	Straight	5
100	K Series	Base Edge Assembly	(365-7761)	800	800	304.8	304.8	45	22.5	690	Stepped	3
100	K Series	Base Edge Assembly	264-2666	1800	1800	305	305	45	22.5	1690	Straight	5

Cat Hydraulic Excavators

BASE EDGE TABLE

Base Edge Dimensional Reference												
Adapter Size Class	Adapter Series	Edge Type	Part Number								Edge Style	Adapter Quantity Welded on Edge
				A	B	C	D	E	F	G		
100	K Series	Base Edge Assembly	346-9702*	800	800	304.8	304.8	45	22.5	690	Straight	3
100	K Series	Base Edge Assembly	(322-9572)	1350	1350	404.8	304.8	45	22.5	1240	Stepped	4
100	K Series	Base Edge Assembly	264-2664	1650	1650	305	305	45	22.5	1540	Straight	5
100	K Series	Conversion Edge	253-9579*	1650	1650	305	305	45	22.5	1540	Straight	5
100	K Series	Base Edge Assembly	292-5755*	1200	1200	304.8	304.8	45	22.5	1090	Straight	4
100	K Series	Base Edge Assembly	250-9682	1600	1600	304.8	304.8	45	22.5	1490	Straight	5
100	K Series	Base Edge Assembly	250-9681	1500	1500	305	305	44.45	22.5	1390	Straight	5
100	K Series	Conversion Edge	253-9578*	1500	1500	305	305	44.45	22.5	1390	Straight	5
100	K Series	Base Edge Assembly	241-6726	915	915	304.8	304.8	44.45	22.5	823	Straight	4
100	K Series	Base Edge Assembly	(351-2861)	1260	1179	395	336	45	22.5	1100	Stepped	4
100	K Series	Base Edge Assembly	(239-2433)	1460	1460	350	350	44.5	22.5	1390	Straight	5
100	K Series	Base Edge Assembly	310-1859	1200	1200	304.8	304.8	45	22.5	1090	Straight	4
100	K Series	Base Edge Assembly	241-6724*	598	598	304.8	304.8	44.45	22.5	507	Straight	3
100	K Series	Base Edge Assembly	282-8759*	1350	1350	404.8	304.8	45	22.5	1240	Stepped	4
100	K Series	Base Edge Assembly	522-3423	1808	1734	304.8	304.8	44.45	22.5	1650	Straight	8
100	K Series	Base Edge Assembly	515-3416	1728	1654	304.8	304.8	44.45	22.5	1580	Straight	5
100	K Series	Base Edge Assembly	517-0722	1384	1310	304.8	304.8	44.45	22.5	1226	Straight	5
100	K Series	Base Edge Assembly	514-4616	828	754	304.8	304.8	44.45	22.5	670	Straight	3
100	K Series	Base Edge Assembly	356-4345	1384	1310	372.6	304.8	45	22.5	1226	Stepped	4
100	Advansys	Base Edge Assembly	(540-4042)	1384	1310	372.6	304.8	45	22.5	1226	Stepped	4
100	K Series	Base Edge Assembly	279-4107	1688	1614	304.8	304.8	44.45	22.5	1530	Straight	7
100	Advansys	Base Edge Assembly	540-4038	1688	1614	304.8	304.8	44.45	22.5	1530	Straight	7
100	K Series	Base Edge Assembly	442-6692	1604	1530	304.8	304.8	44.45	22.5	1442	Straight	5
100	K Series	Base Edge Assembly	(487-7780)	1536	1462	304.8	304.8	44.45	22.5	1378	Straight	6
100	K Series	Base Edge Assembly	362-6243	796	722	304.8	304.8	44.45	22.5	-	-	3
100	K Series	Base Edge Assembly	348-3110	1688	1614	304.8	304.8	44.45	22.5	1530	Straight	5
100	Advansys	Base Edge Assembly	543-2759	1688	1614	304.8	304.8	44.45	22.5	1530	Straight	5
100	K Series	Base Edge Assembly	348-3104	1654	1580	304.8	304.8	44.45	22.5	1496	Straight	5
100	Advansys	Base Edge Assembly	541-1875	1654	1580	304.8	304.8	44.45	22.5	1496	Straight	5
100	K Series	Base Edge Assembly	279-4103	1080	1006	304.8	304.8	44.45	22.5	922	Straight	5
100	Advansys	Base Edge Assembly	540-4035	1080	1006	304.8	304.8	44.45	22.5	922	Straight	5
100	K Series	Base Edge Assembly	348-3105*	1808	1734	304.8	304.8	44.45	22.5	1650	Straight	6
100	Advansys	Base Edge Assembly	541-1877	1808	1734	304.8	304.8	44.45	22.5	1650	Straight	6
100	K Series	Base Edge Assembly	348-3109	1080	1006	345	304.8	45	22.5	922	Stepped	4
100	Advansys	Base Edge Assembly	543-2760	1080	1006	345	304.8	45	22.5	922	Stepped	4
100	K Series	Base Edge Assembly	(367-8614)	1536	1462	304.8	304.8	44.45	22.5	1378	Straight	6
100	K Series	Base Edge Assembly	279-4100	623	549	304.8	304.8	44.45	22.5	465	Straight	3
100	Advansys	Base Edge Assembly	542-6855	623	549	304.8	304.8	44.45	22.5	465	Straight	3
100	K Series	Base Edge Assembly	348-3102*	1350	1276	304.8	304.8	44.45	22.5	1192	Straight	4
100	Advansys	Base Edge Assembly	541-1876	1350	1276	304.8	304.8	44.45	22.5	1192	Straight	4
100	K Series	Base Edge Assembly	(371-9049)	1536	1462	356	304.8	45	22.5	1378	Stepped	5
100	K Series	Base Edge Assembly	437-4021	778	704	345	304.8	45	22.5	620	Stepped	3
100	K Series	Base Edge Assembly	(487-5140)	1688	1614	304.8	304.8	44.45	22.5	1530	Straight	6
100	K Series	Base Edge Assembly	469-2476	1322	1248	365	304.8	45	22.5	1164	Stepped	4
100	K Series	Base Edge Assembly	279-4102	926	852	304.8	304.8	44.45	22.5	768	Straight	4
100	Advansys	Base Edge Assembly	540-4034	926	852	304.8	304.8	44.45	22.5	768	Straight	4
100	K Series	Base Edge Assembly	279-4106	1536	1462	304.8	304.8	44.45	22.5	1378	Straight	7
100	Advansys	Base Edge Assembly	538-9472	1536	1462	304.8	304.8	44.45	22.5	1378	Straight	7
100	K Series	Base Edge Assembly	433-0099	1536	1462	385	304.8	45	22.6	1378	Stepped	4
100	Advansys	Base Edge Assembly	576-5329	1536	1462	385	304.8	45	22.6	1378	Stepped	4
100	K Series	Base Edge Assembly	308-5796	1080	1006	304.8	304.8	44.45	22.5	922	Straight	4
100	Advansys	Base Edge Assembly	543-2761	1080	1006	304.8	304.8	44.45	22.5	922	Straight	4
100	K Series	Base Edge Assembly	(332-4868)	1775	1701	304.8	304.8	44.45	22.5	1617	Straight	7
100	K Series	Base Edge Assembly	348-3108	1384	1310	304.8	304.8	44.45	22.5	1226	Straight	4
100	Advansys	Base Edge Assembly	542-6862	1384	1310	304.8	304.8	44.45	22.5	1226	Straight	4
100	K Series	Base Edge Assembly	353-0089	1536	1462	304.8	304.8	44.45	22.5	1378	Straight	5
100	Advansys	Base Edge Assembly	540-4040	1536	1462	304.8	304.8	44.45	22.5	1378	Straight	5
100	K Series	Base Edge Assembly	279-4105	1384	1310	304.8	304.8	44.45	22.5	1226	Straight	6
100	Advansys	Base Edge Assembly	540-4037	1384	1310	304.8	304.8	44.45	22.5	1226	Straight	6
100	K Series	Base Edge Assembly	331-1881*	1333	1259	304.8	304.8	44.45	22.5	1175	Straight	5
100	K Series	Base Edge Assembly	348-3100*	1046	972	304.8	304.8	44.45	22.5	888	Straight	4
100	K Series	Base Edge Assembly	380-5906*	1279	1205	304.8	304.8	44.5	22.5	560.5	Straight	5
100	K Series	Base Edge Assembly	279-4104	1232	1158	304.8	304.8	44.45	22.5	1074	Straight	5
100	Advansys	Base Edge Assembly	540-4036	1232	1158	304.8	304.8	44.45	22.5	1074	Straight	5
100	K Series	Base Edge Assembly	348-3103	1502	1428	304.8	304.8	44.45	22.5	1344	Straight	5
100	Advansys	Base Edge Assembly	541-1898	1502	1428	304.8	304.8	44.45	22.5	1344	Straight	5
100	K Series	Base Edge Assembly	348-3101*	1198	1124	304.8	304.8	44.45	22.5	1040	Straight	4
100	Advansys	Base Edge Assembly	541-1899	1198	1124	304.8	304.8	44.45	22.5	1040	Straight	4
100	K Series	Base Edge Assembly	359-7463	1232	1158	304.8	304.8	44.45	22.5	1074	Straight	4
100	K Series	Base Edge Assembly	501-4897	628	544	324	304.8	45	22.5	465	Stepped	3
100	K Series	Base Edge Assembly	453-3404	742	668	304.8	304.8	44.45	22.5	582	Straight	3

Discontinued
Canceled
(Reference)

Part is discontinued. Please contact your service representative.
Part is canceled. Please contact your customer service representative.
Part number is not serviceable. For reference only.

Base Edge Dimensional Reference

Adapter Size Class	Adapter Series	Edge Type	Part Number								Edge Style	Adapter Quantity Welded on Edge
				A	B	C	D	E	F	G		
100	K Series	Base Edge Assembly	279-4101	778	704	304.8	304.8	44.45	22.5	620	Straight	3
100	Advansys	Base Edge Assembly	540-4033	778	704	304.8	304.8	44.45	22.5	620	Straight	3
100	K Series	Base Edge Assembly	316-4123*	1092	1074	341.7	304.8	45	22.5	990	Stepped	4
100	K Series	Base Edge Assembly	(378-0602)	1223	1205	304.8	304.8	44.45	22.5	1121	Straight	5
100	K Series	Base Edge Assembly	279-4121*	722	704	304.8	304.8	44.45	22.5	620	Straight	3
100	K Series	Base Edge Assembly	279-4123*	1024	1006	304.8	304.8	44.45	22.5	922	Straight	5
100	K Series	Base Edge Assembly	311-1767	1201	1159	304.8	304.8	44.45	22.5	1091.4	Straight	6
100	K Series	Base Edge Assembly	279-4126	1480	1462	304.8	304.8	44.45	22.5	1378	Straight	7
100	K Series	Base Edge Assembly	279-4124*	1176	1158	304.8	304.8	44.45	22.5	1074	Straight	5
100	K Series	Base Edge Assembly	415-8647*	1654	1580	304.8	304.8	44.45	22.5	1474	Straight	5
100	K Series	Base Edge Assembly	279-4122*	870	852	304.8	304.8	44.45	22.5	768	Straight	4
100	K Series	Base Edge Assembly	279-4125	1328	1310	304.8	304.8	44.45	22.5	1226	Straight	6
100	K Series	Base Edge Assembly	324-5219	1070	996	304.8	304.8	44.45	22.5	930.4	Straight	5
100	K Series	Conversion Edge	232-0036	1359	1359	304.8	304.8	44.45	22.5	750	Straight	4
100	Advansys	Conversion Edge	563-0194	1359	1359	304.8	304.8	44.45	22.5	750	Straight	4
100	K Series	Base Edge Assembly	314-8680*	1658	1614	304.8	304.8	44.45	22.5	714	Straight	3
100	K Series	Conversion Edge	232-0039	1064	1064	304.8	304.8	44.45	22.5	476	Straight	3
100	Advansys	Conversion Edge	547-5066*	1064	1064	304.8	304.8	44.45	22.5	476	Straight	3
100	K Series	Base Edge Assembly	368-3737*	1245	1245	407	407	44.45	22.5	560.6	Straight	3
100	K Series	Base Edge Assembly	249-8622	1511	1511	304.8	304.8	44.45	22.5	1332	Straight	6
100	K Series	Base Edge Assembly	232-0037	1501	1457	304.8	304.8	44.45	22.5	916	Straight	5
100	Advansys	Base Edge Assembly	547-5068	1501	1457	304.8	304.8	44.45	22.5	916	Straight	5
100	K Series	Base Edge Assembly	232-0034	926	882	304.8	304.8	44.45	22.5	268	Straight	2
100	Advansys	Base Edge Assembly	547-5067	926	882	304.8	304.8	44.45	22.5	268	Straight	2
100	K Series	Base Edge Assembly	232-0033*	753	709	304.8	304.8	44.45	22.5	-	Straight	1
100	K Series	Conversion Edge	232-0035	1212	1212	304.8	304.8	44.45	22.5	550	Straight	3
100	Advansys	Conversion Edge	547-5065	1212	1212	304.8	304.8	44.45	22.5	550	Straight	3
100	K Series	Base Edge Assembly	(297-5992)	898	862	304.8	304.8	44.45	22.5	761.6	Straight	4
100	K Series	Base Edge Assembly	(349-8219)	1270	1270	350	350	45	22.5	1154.6	Straight	4
100	K Series	Base Edge Assembly	(338-7707)	1205	1163	304.8	304.8	44.45	22.5	1068.6	Straight	5
100	K Series	Base Edge Assembly	232-0038	1658	1614	304.8	304.8	44.45	22.5	-	Straight	5
100	Advansys	Base Edge Assembly	563-0186	1658	1614	304.8	304.8	44.45	22.5	-	Straight	5
100	K Series	Base Edge Assembly	322-6021*	1205	1163	304.8	304.8	44.45	22.5	1068.6	Straight	6
100	Advansys	Base Edge Assembly	540-4043	1580	1506.2	304.8	304.8	45	22.5	1420	Straight	7
100	Advansys	Base Edge Assembly	540-4051	1664	1664	304.8	304.8	44.45	22.5	1490	Straight	5
100	Advansys	Base Edge Assembly	541-1883	1492	1448	304.8	304.8	44.45	22.5	1344	Straight	5
100	Advansys	Base Edge Assembly	542-6846	1492	1438	304.8	304.8	44.45	22.5	1335	Straight	6
100	Advansys	Base Edge Assembly	540-4044	1281	1207.2	304.8	304.8	45	22.5	1121	Straight	5
100	Advansys	Base Edge Assembly	540-4052	1554	1480.2	304.8	304.8	44.45	22.5	1390.4	Straight	5
100	Advansys	Base Edge Assembly	540-4045	983	909.2	304.8	304.8	44.45	22.5	823	Straight	4
100	Advansys	Base Edge Assembly	540-4039*	1386	1312	304.8	304.8	44.45	22.5	1226	Straight	6
100	Advansys	Base Edge Assembly	541-1880	1412	1368	304.8	304.8	44.45	22.5	1264	Straight	5
100	Advansys	Base Edge Assembly	541-1883	1492	1448	304.8	304.8	44.45	22.5	1344	Straight	5
100	Advansys	Base Edge Assembly	541-1882	1568	1524	304.8	304.8	44.45	22.5	1420	Straight	6
100	Advansys	Base Edge Assembly	542-6863	1275	1231	304.8	304.8	44.45	22.5	1122	Straight	5
100	Advansys	Base Edge Assembly	542-6874	1317	1273	304.8	304.8	44.45	22.5	1194	Straight	5
100	Advansys	Base Edge Assembly	542-6875	1437	1383	304.8	304.8	44.45	22.5	1310	Straight	6
100	K Series	Base Edge Assembly	323-1765*	1328	1310	404.8	304.8	45	22.5	1226	Stepped	5
100	K Series	Base Edge Assembly	278-0878*	700	700	304.8	304.8	45	22.5	590	Straight	3
100	K Series	Base Edge Assembly	277-3975*	1057	1004	304.8	304.8	44.5	22.5	893.8	Straight	5
100	K Series	Base Edge Assembly	277-8196*	1150	1150	404.8	304.8	45	22.5	1040	Stepped	4
100	K Series	Base Edge Assembly	241-6737*	1511	1511	304.8	304.8	44.45	22.5	1332	Straight	7
100	K Series	Base Edge Assembly	241-6725*	740	740	304.8	304.8	44.45	22.5	648	Straight	3
100	K Series	Base Edge Assembly	241-6734*	1064	1064	304.8	304.8	44.45	22.5	885.2	Straight	5
100	K Series	Conversion Edge	232-0039	1064	1064	304.8	304.8	44.45	22.5	885.2	Straight	5
100	K Series	Conversion Edge	253-9577*	1350	1350	305	305	45	22.5	-	Straight	2
100	K Series	Base Edge Assembly	308-3703*	1450	1450	304.8	304.8	45	22.5	1340	Straight	5
100	K Series	Base Edge Assembly	264-2665	1700	1700	304.8	304.8	45	22.5	1590	Straight	5
100	K Series	Base Edge Assembly	316-9009*	1150	1150	298	298	45	22.5	1054	Straight	4
100	K Series	Base Edge Assembly	276-5760*	602	549	304.8	304.8	44.5	22.5	450	Straight	3
100	K Series	Base Edge Assembly	241-6736*	1359	1359	304.8	304.8	44.45	22.5	1180	Straight	6
100	K Series	Conversion Edge	232-0036	1359	1359	304.8	304.8	44.45	22.5	1180	Straight	6
100	K Series	Base Edge Assembly	301-4357*	1840	1766	304.8	304.8	44.45	22.5	1682	Straight	7
100	K Series	Base Edge Assembly	311-1757*	744	724	404.8	304.8	45	22.5	648	Stepped	3
100	K Series	Base Edge Assembly	330-6917*	1782	1708	304.8	304.8	44.45	22.5	1624	Straight	7
100	K Series	Base Edge Assembly	295-2209*	1800	1800	305	305	45	22.5	1690	Straight	9
100	K Series	Base Edge Assembly	241-6735*	1212	1212	304.8	304.8	44.45	22.5	1033	Straight	5
100	K Series	Conversion Edge	232-0035	1212	1212	304.8	304.8	44.45	22.5	1033	Straight	5
100	K Series	Base Edge Assembly	264-2663*	1000	1000	305	305	44.45	22.5	890	Straight	4
100	K Series	Base Edge Assembly	301-4369*	1709	1709	304.8	304.8	44.45	22.5	1618	Straight	7
100	K Series	Base Edge Assembly	240-9595*	905	852	304.8	304.8	44.5	22.5	753	Straight	4

Cat Hydraulic Excavators

BASE EDGE TABLE

Base Edge Dimensional Reference												
Adapter Size Class	Adapter Series	Edge Type	Part Number								Edge Style	Adapter Quantity Welded on Edge
				A	B	C	D	E	F	G		
100	K Series	Conversion Edge	253-9579*	1650	1650	305	305	45	22.5	-	Straight	3
100	K Series	Base Edge Assembly	250-9678*	1150	1150	305	305	45	22.5	1040	Straight	4
100	K Series	Base Edge Assembly	241-6732*	740	740	304.8	304.8	44.45	22.5	560	Straight	3
100	K Series	Base Edge Assembly	305-2816*	563	489	304.8	304.8	44.45	22.5	405	Straight	3
100	K Series	Base Edge Assembly	330-6911*	1850	1776	304.8	304.8	44.45	22.5	1692	Straight	7
100	K Series	Base Edge Assembly	273-5589*	1800	1800	305	305	45	22.5	1690	Straight	8
100	K Series	Base Edge Assembly	359-3008*	832	814	304.8	304.8	44.45	22.5	730	Straight	4
100	K Series	Base Edge Assembly	241-4209*	753	700	304.8	304.8	44.5	22.5	601	Straight	3
100	K Series	Base Edge Assembly	269-2700*	1363	1310	304.8	304.8	44.5	22.5	1211	Straight	6
100	K Series	Base Edge Assembly	242-1794*	1664	1664	304.8	304.8	44.45	22.5	1573	Straight	7
100	K Series	Base Edge Assembly	308-5755*	1328	1310	404.8	304.8	45	22.5	1226	Stepped	4
100	K Series	Base Edge Assembly	271-7299*	1515	1462	304.8	304.8	44.5	22.5	1363	Straight	7
100	K Series	Base Edge Assembly	241-6733*	915	915	304.8	304.8	44.45	22.5	735	Straight	4
100	K Series	Base Edge Assembly	269-2699*	1211	1158	304.8	304.8	44.5	22.5	1059	Straight	5
100	K Series	Conversion Edge	253-9578*	1500	1500	305	305	44.45	22.5	-	Straight	3
100	Advansys	Base Edge Assembly	543-2712	778	704	304.8	304.8	44.45	22.5	598	Straight	3
100	Advansys	Base Edge Assembly	543-2713	926	852	304.8	304.8	44.45	22.5	746	Straight	4
100	Advansys	Base Edge Assembly	543-2714	1080	1006	304.8	304.8	44.45	22.5	900	Straight	5
100	Advansys	Base Edge Assembly	543-2715	1232	1158	304.8	304.8	44.45	22.5	1052	Straight	5
100	Advansys	Base Edge Assembly	543-2716	1384	1310	304.8	304.8	44.45	22.5	1204	Straight	6
100	Advansys	Base Edge Assembly	543-2717	1536	1462	304.8	304.8	44.45	22.5	1356	Straight	7
100	Advansys	Base Edge Assembly	556-0159	1502	1428	304.8	304.8	44.45	22.5	1325	Straight	6
100	Advansys	Base Edge Assembly	557-1744	1688	1614	304.8	304.8	44.45	22.5	1530	Straight	6
100	Advansys	Base Edge Assembly	563-0188	1226	1226	400	400	44.5	22.5	1051	Straight	5
100	Advansys	Base Edge Assembly	564-6512	1604	1530	304.8	304.8	44.45	22.6	1442	Straight	6
100	Advansys	Base Edge Assembly	565-6342	1448	1394	304.8	304.8	44.5	22.6	1294.6	Straight	5
100	Advansys	Base Edge Assembly	567-1137	1744	1670	304.8	304.8	44.5	22.6	1586	Straight	5
100	Advansys	Base Edge Assembly	570-5378	1697	1653	304.8	304.8	44.45	22.6	1545.6	Straight	6
100/110	K Series	Base Edge Assembly	462-9457	958	884	484.8	304.8	45	22.5	800	Stepped	3
110	K Series	Conversion Edge	253-0105	1050	1050	325	325	60	22.5	949	Straight	2
110	Advansys	Conversion Edge	547-5075	1050	1050	325	325	60	22.5	949	Straight	2
110	K Series	Base Edge Assembly	385-0432	593	593	325	325	60	22.5	492	Straight	3
110	K Series	Base Edge Assembly	482-2125	593	593	325	325	60	22.5	492	Straight	3
110	Advansys	Base Edge Assembly	533-1202	675	607	325	325	60	22.5	492	Straight	3
110	K Series	Base Edge Assembly	257-1771	1216	1216	400	400	60	22.5	554	Straight	3
110	Advansys	Base Edge Assembly	547-5074	1216	1216	400	400	60	22.5	554	Straight	3
110	K Series	Conversion Edge	253-0106	1202	1202	325	325	60	22.5	554	Straight	3
110	Advansys	Conversion Edge	547-5069	1202	1202	325	325	60	22.5	554	Straight	3
110	K Series	Base Edge Assembly	271-7295*	758	684	325	325	60	22.5	571.8	Straight	3
110	K Series	Base Edge Assembly	476-2226	762	684	325	325	60	22.5	582	Straight	3
110	K Series	Base Edge Assembly	476-2226	762	684	325	325	60	22.5	582	Straight	3
110	Advansys	Base Edge Assembly	533-1192	762	684	325	325	60	22.5	582	Straight	3
110	K Series	Base Edge Assembly	294-2250*	739	673	417.3	328	60	22.5	582	Stepped	3
110	K Series	Base Edge Assembly	443-6261	762	684	354	325	60	22.5	582	Stepped	3
110	K Series	Base Edge Assembly	287-8816*	776	698	325	325	60	22.5	595.8	Straight	3
110	Advansys	Base Edge Assembly	(570-5336)	776	698	325	325	60	22.5	595.8	Straight	3
110	K Series	Base Edge Assembly	362-6245*	780	702	325	325	60	22.5	600	Straight	3
110	K Series	Base Edge Assembly	476-2234	794	716	380	380	60	22.5	614	Straight	3
110	K Series	Base Edge Assembly	476-2234	794	716	380	380	60	22.5	614	Straight	3
110	Advansys	Base Edge Assembly	528-2078	794	716	380	380	60	22.5	614	Straight	3
110	K Series	Conversion Edge	253-0108	1355	1355	325	325	60	22.5	616.5	Straight	3
110	Advansys	Conversion Edge	547-5073	1355	1355	325	325	60	22.5	616.5	Straight	3
110	K Series	Base Edge Assembly	253-0107	1369	1369	400	400	60	22.5	620	Straight	3
110	Advansys	Base Edge Assembly	547-5070	1369	1369	400	400	60	22.5	620	Straight	3
110	K Series	Base Edge Assembly	292-4035*	750	750	325	325	60	22.5	640	Straight	3
110	K Series	Base Edge Assembly	241-6717*	751	751	380	380	60	22.5	650	Straight	3
110	K Series	Base Edge Assembly	258-4571*	751	751	325	325	60	22.5	650	Straight	3
110	K Series	Conversion Edge	253-0103	751	751	325	325	60	22.5	650	Straight	3
110	K Series	Base Edge Assembly	382-1131*	800	800	380	380	60	22.5	674	Straight	3
110	K Series	Base Edge Assembly	260-9411*	904	904	380	380	60	22.5	690	Straight	4
110	K Series	Base Edge Assembly	476-2246	904	904	380	380	60	22.5	690	Straight	4
110	Advansys	Base Edge Assembly	528-2087	904	904	380	380	60	22.5	690	Straight	4
110	K Series	Base Edge Assembly	301-6966*	800	800	325	325	60	22.5	690	Stepped	3
110	K Series	Base Edge Assembly	277-3959*	911.6	837.6	380	380	60	22.5	724	Straight	4
110	K Series	Base Edge Assembly	512-7869	914	836	380	380	60	22.5	734	Straight	3
110	K Series	Base Edge Assembly	469-4422	914	836	325	325	60	22.5	734	Straight	3
110	K Series	Base Edge Assembly	512-9051	914	836	325	325	60	22.5	734	Straight	3
110	K Series	Base Edge Assembly	476-2227	914	836	325	325	60	22.5	734	Straight	4
110	K Series	Base Edge Assembly	476-2227	914	836	325	325	60	22.5	734	Straight	4
110	Advansys	Base Edge Assembly	533-1193	914	836	325	325	60	22.5	734	Straight	4

Base Edge Dimensional Reference

Adapter Size Class	Adapter Series	Edge Type	Part Number								Edge Style	Adapter Quantity Welded on Edge
				A	B	C	D	E	F	G		
110	K Series	Base Edge Assembly	476-2235	914	836	380	380	60	22.5	734	Straight	4
110	K Series	Base Edge Assembly	476-2235	914	836	380	380	60	22.5	734	Straight	4
110	Advansys	Base Edge Assembly	528-2079	914	836	380	380	60	22.5	734	Straight	4
110	K Series	Conversion Edge	253-0112	1659	1659	325	325	60	22.5	758	Straight	3
110	Advansys	Conversion Edge	547-5077	1659	1659	325	325	60	22.5	758	Straight	3
110	K Series	Base Edge Assembly	(420-1242)	948	870	380	380	60	22.5	768	Straight	4
110	K Series	Base Edge Assembly	(492-3761)	950	872	325	325	60	22.5	770	Straight	3
110	K Series	Base Edge Assembly	324-8369*	900	900	325	325	60	22.5	790	Stepped	3
110	K Series	Base Edge Assembly	462-9457	958	884	484.8	304.8	45	22.6	800	Stepped	3
110	K Series	Base Edge Assembly	244-3895	904	904	380	380	60	22.5	802	Straight	4
110	K Series	Base Edge Assembly	258-4572*	903	903	325	325	60	22.5	802	Straight	4
110	K Series	Base Edge Assembly	275-2460*	1580	1580	325	325	60	22.5	-	Straight	4
110	K Series	Conversion Edge	253-0109	1507	1507	325	325	60	22.5	-	Straight	4
110	Advansys	Conversion Edge	547-5072	1507	1507	325	325	60	22.5	-	Straight	4
110	K Series	Base Edge Assembly	260-9413*	1050	1050	380	380	60	22.5	837	Straight	4
110	K Series	Base Edge Assembly	253-0110	1527	1527	400	400	60	22.5	842	Straight	4
110	Advansys	Base Edge Assembly	547-5071	1527	1527	400	400	60	22.5	842	Straight	4
110	K Series	Base Edge Assembly	253-0111	1580	1580	325	325	60	22.5	858	Straight	4
110	Advansys	Base Edge Assembly	547-5076	1580	1580	325	325	60	22.5	858	Straight	4
110	K Series	Base Edge Assembly	322-4906*	1000	1000	380	380	60	22.5	870	Straight	4
110	K Series	Base Edge Assembly	(339-5964)	1000	1000	425	325	60	22.5	876	Stepped	4
110	K Series	Base Edge Assembly	277-3890*	1063	989	325	325	60	22.5	876.6	Straight	4
110	K Series	Base Edge Assembly	476-2228	1068	990	325	325	60	22.5	888	Straight	4
110	K Series	Base Edge Assembly	476-2228	1068	990	325	325	60	22.5	888	Straight	4
110	Advansys	Base Edge Assembly	533-1194	1068	990	325	325	60	22.5	888	Straight	4
110	K Series	Base Edge Assembly	476-2252	1068	990	325	325	60	22.5	888	Straight	3
110	K Series	Base Edge Assembly	476-2252	1068	990	325	325	60	22.5	888	Straight	3
110	K Series	Base Edge Assembly	476-2236	1068	990	380	380	60	22.5	888	Straight	4
110	K Series	Base Edge Assembly	476-2236	1068	990	380	380	60	22.5	888	Straight	4
110	Advansys	Base Edge Assembly	528-2080	1068	990	380	380	60	22.5	888	Straight	4
110	K Series	Base Edge Assembly	362-0113	1068	990	395.2	325	60	22.5	888	Stepped	3
110	K Series	Base Edge Assembly	264-2670*	1000	1000	325	325	60	22.5	890	Straight	3
110	K Series	Base Edge Assembly	303-6673*	1000	1000	425	325	60	22.5	890	Stepped	4
110	K Series	Base Edge Assembly	253-0114	1659	1659	400	400	60	22.5	921	Straight	4
110	Advansys	Base Edge Assembly	547-5080	1659	1659	400	400	60	22.5	921	Straight	4
110	K Series	Base Edge Assembly	253-0113	1659	1659	325	325	60	22.5	921	Straight	4
110	Advansys	Base Edge Assembly	547-5078	1659	1659	325	325	60	22.5	921	Straight	4
110	K Series	Base Edge Assembly	(331-0853)	1060	1060	650	400	60	22.5	928.6	Stepped	3
110	K Series	Base Edge Assembly	241-6719*	1050	1050	380	380	60	22.5	949	Straight	4
110	K Series	Base Edge Assembly	258-4573	1050	1050	325	325	60	22.5	949	Straight	4
110	K Series	Conversion Edge	253-0105	1050	1050	325	325	60	22.5	949	Straight	4
110	K Series	Base Edge Assembly	286-5852*	1221	1221	325	325	60	22.5	955.8	Straight	5
110	K Series	Base Edge Assembly	(359-3038)	1230.8	1171.8	325	325	60	22.5	958.6	Straight	5
110	K Series	Base Edge Assembly	253-0115*	1704	1704	325	325	60	22.5	972	Straight	4
110	K Series	Base Edge Assembly	476-2229	1220	1142	325	325	60	22.5	1040	Straight	5
110	K Series	Base Edge Assembly	476-2229	1220	1142	325	325	60	22.5	1040	Straight	5
110	Advansys	Base Edge Assembly	533-1195	1220	1142	325	325	60	22.5	1040	Straight	5
110	K Series	Base Edge Assembly	476-2237	1220	1142	380	380	60	22.5	1040	Straight	5
110	K Series	Base Edge Assembly	476-2237	1220	1142	380	380	60	22.5	1040	Straight	5
110	Advansys	Base Edge Assembly	528-2081	1220	1142	380	380	60	22.5	1040	Straight	5
110	K Series	Base Edge Assembly	295-0487*	1150	1150	325	325	60	22.5	1040	Straight	4
110	K Series	Base Edge Assembly	324-5274*	1220	1142	325	325	60	22.5	1040	Stepped	5
110	K Series	Base Edge Assembly	253-0116	1701	1701	400	400	60	22.5	1051.4	Straight	5
110	K Series	Base Edge Assembly	(341-5627)	1254	1176	325	325	60	22.5	1074	Straight	5
110	K Series	Base Edge Assembly	471-1272	1254	1176	325	325	60	22.5	1074	Straight	5
110	K Series	Base Edge Assembly	241-6720*	1202	1202	380	380	60	22.5	1101	Straight	5
110	K Series	Base Edge Assembly	258-4574	1202	1202	325	325	60	22.5	1101	Straight	5
110	K Series	Conversion Edge	253-0106	1202	1202	325	325	60	22.5	1101	Straight	5
110	Advansys	Base Edge Assembly	541-1893	1298	1220	325	325	60	22.5	1101	Straight	5
110	K Series	Base Edge Assembly	253-0117	1784	1784	400	400	60	22.5	1108	Straight	5
110	Advansys	Base Edge Assembly	563-0191	1784	1784	400	400	60	22.5	1108	Straight	5
110	K Series	Base Edge Assembly	353-0156	1393	1334	325	325	60	22.5	1114.2	Straight	6
110	Advansys	Base Edge Assembly	532-8343	1298	1220	325	325	60	22.5	1122	Straight	4
110	K Series	Base Edge Assembly	275-3257*	1250	1250	445	325	60	22.5	1140	Stepped	4
110	K Series	Base Edge Assembly	301-2891*	1250	1250	445	325	60	22.5	1140	Stepped	4
110	K Series	Base Edge Assembly	481-1241	1355	1355	380	380	60	22.5	1142	Straight	6
110	K Series	Base Edge Assembly	481-1241	1355	1355	380	380	60	22.5	1142	Straight	6
110	Advansys	Base Edge Assembly	528-2088	1355	1355	380	380	60	22.5	1142	Straight	6
110	K Series	Base Edge Assembly	(357-8212)	1363	1363	380	380	60	22.5	1150	Straight	6
110	Advansys	Base Edge Assembly	532-8344	1340	1262	325	325	60	22.5	1164	Straight	4
110	K Series	Base Edge Assembly	476-2254	1372	1294	380	380	60	22.5	1192	Straight	4

Cat Hydraulic Excavators

BASE EDGE TABLE

Base Edge Dimensional Reference												
Adapter Size Class	Adapter Series	Edge Type	Part Number								Edge Style	Adapter Quantity Welded on Edge
				A	B	C	D	E	F	G		
110	K Series	Base Edge Assembly	476-2254	1372	1294	380	380	60	22.5	1192	Straight	4
110	K Series	Base Edge Assembly	476-2230	1372	1294	325	325	60	22.5	1192	Straight	5
110	K Series	Base Edge Assembly	476-2230	1372	1294	325	325	60	22.5	1192	Straight	5
110	Advansys	Base Edge Assembly	533-1197	1372	1294	325	325	60	22.5	1192	Straight	5
110	K Series	Base Edge Assembly	476-2255	1372	1294	436	380	60	22.5	1192	Stepped	4
110	K Series	Base Edge Assembly	476-2255	1372	1294	436	380	60	22.5	1192	Stepped	4
110	Advansys	Base Edge Assembly	535-7483	1372	1294	436	380	60	22.5	1192	Stepped	4
110	K Series	Base Edge Assembly	476-2238	1372	1294	380	380	60	22.5	1192	Straight	5
110	K Series	Base Edge Assembly	476-2238	1372	1294	380	380	60	22.5	1192	Straight	5
110	Advansys	Base Edge Assembly	528-2082	1372	1294	380	380	60	22.5	1192	Straight	5
110	K Series	Base Edge Assembly	476-2248	1372	1294	325	325	60	22.5	1192	Straight	4
110	K Series	Base Edge Assembly	476-2248	1372	1294	325	325	60	22.5	1192	Straight	4
110	Advansys	Base Edge Assembly	533-1196	1372	1294	325	325	60	22.5	1192	Straight	4
110	K Series	Base Edge Assembly	314-9313*	1372	1316.6	380	380	60	22.5	1192	Straight	5
110	K Series	Base Edge Assembly	348-3116	1372	1294	383.3	325	60	22.5	1192	Stepped	4
110	Advansys	Base Edge Assembly	533-1973	1372	1294	383.3	325	60	22.5	1192	Stepped	4
110	K Series	Base Edge Assembly	444-6249	1372	1294	383.3	325	60	22.5	1192	Stepped	4
110	K Series	Base Edge Assembly	324-0164*	1360	1280	435.9	380	60	22.5	1196	Stepped	4
110	K Series	Base Edge Assembly	304-8291*	1424	1424	380	380	60	22.5	1202	Straight	6
110	K Series	Base Edge Assembly	(244-3892)	1306	1306	380	380	60	22.5	1205	Straight	5
110	K Series	Base Edge Assembly	(368-3732)	1398	1320	325	325	60	22.5	1226	Straight	5
110	Advansys	Base Edge Assembly	532-8345	1402	1324	325	325	60	22.5	1226	Straight	5
110	K Series	Base Edge Assembly	268-9958*	1350	1350	325	325	60	22.5	1240	Straight	4
110	K Series	Base Edge Assembly	312-0734*	1350	1350	445	325	60	22.5	1240	Stepped	4
110	K Series	Base Edge Assembly	257-5354*	1380	1380	380	380	60	22.5	1250	Straight	4
110	K Series	Base Edge Assembly	257-5362*	1380	1380	500	380	60	22.5	1250	Stepped	4
110	K Series	Base Edge Assembly	(320-6538)	1380	1380	500	380	60	22.5	1250	Stepped	4
110	K Series	Base Edge Assembly	241-6721	1355	1355	380	380	60	22.5	1254	Straight	5
110	K Series	Base Edge Assembly	258-4575	1355	1355	325	325	60	22.5	1254	Straight	5
110	K Series	Conversion Edge	253-0108	1355	1355	325	325	60	22.5	1254	Straight	5
110	Advansys	Base Edge Assembly	532-8341	1430	1362	325	325	60	22.5	1264	Straight	5
110	K Series	Base Edge Assembly	300-6198*	1400	1400	445	325	60	22.5	1290	Stepped	4
110	K Series	Base Edge Assembly	476-2224	1507	1507	380	380	60	22.5	1294	Straight	6
110	K Series	Base Edge Assembly	476-2224	1507	1507	380	380	60	22.5	1294	Straight	6
110	Advansys	Base Edge Assembly	528-2089	1507	1507	380	380	60	22.5	1294	Straight	6
110	K Series	Base Edge Assembly	244-3898*	1527	1527	380	380	60	22.5	1305	Straight	6
110	K Series	Base Edge Assembly	295-2014*	1490	1412	325	325	60	22.5	1310	Straight	4
110	K Series	Base Edge Assembly	(504-8186)	1524	1446	450	380	60	22.5	1344	Stepped	4
110	K Series	Base Edge Assembly	476-2257	1524	1446	397.5	325	60	22.5	1344	Stepped	4
110	K Series	Base Edge Assembly	476-2257	1524	1446	397.5	325	60	22.5	1344	Stepped	4
110	Advansys	Base Edge Assembly	533-1974	1524	1446	397.5	325	60	22.5	1344	Stepped	4
110	K Series	Base Edge Assembly	(389-7179)	1524	1446	325	325	60	22.5	1344	Straight	5
110	K Series	Base Edge Assembly	(504-7547)	1524	1446	325	325	60	22.5	1344	Straight	5
110	Advansys	Base Edge Assembly	532-8339	1524	1446	325	325	60	22.5	1344	Straight	5
110	K Series	Base Edge Assembly	476-3429	1524	1446	380	380	60	22.5	1344	Straight	4
110	K Series	Base Edge Assembly	476-3429	1524	1446	380	380	60	22.5	1344	Straight	4
110	K Series	Base Edge Assembly	476-2249	1524	1446	325	325	60	22.5	1344	Straight	4
110	K Series	Base Edge Assembly	476-2249	1524	1446	325	325	60	22.5	1344	Straight	4
110	Advansys	Base Edge Assembly	532-8348	1524	1446	325	325	60	22.5	1344	Straight	4
110	K Series	Base Edge Assembly	476-2239	1524	1446	380	380	60	22.5	1344	Straight	6
110	K Series	Base Edge Assembly	476-2239	1524	1446	380	380	60	22.5	1344	Straight	6
110	Advansys	Base Edge Assembly	528-2083	1524	1446	380	380	60	22.5	1344	Straight	6
110	K Series	Base Edge Assembly	476-2231	1524	1446	325	325	60	22.5	1344	Straight	6
110	K Series	Base Edge Assembly	476-2231	1524	1446	325	325	60	22.5	1344	Straight	6
110	Advansys	Base Edge Assembly	533-1198	1524	1446	325	325	60	22.5	1344	Straight	6
110	K Series	Base Edge Assembly	399-0343*	1524	1446	325	325	60	22.5	1344	Straight	5
110	K Series	Base Edge Assembly	455-8442	1524	1446	397.5	325	60	22.5	1344	Stepped	4
110	K Series	Base Edge Assembly	324-0162	1524	1444	460.2	380	60	22.5	1360	Stepped	5
110	K Series	Base Edge Assembly	257-5356*	1500	1500	380	380	60	22.5	1370	Straight	4
110	K Series	Base Edge Assembly	257-5364*	1500	1500	500	380	60	22.5	1370	Stepped	4
110	Advansys	Base Edge Assembly	532-8342	1554	1476	325	325	60	22.5	1378	Straight	5
110	K Series	Base Edge Assembly	274-8272*	1500	1500	350	350	60	22.5	1383	Straight	4
110	K Series	Base Edge Assembly	266-8402*	1500	1500	325	325	60	22.5	1390	Straight	4
110	K Series	Base Edge Assembly	266-8403	1500	1500	445	325	60	22.5	1390	Stepped	4
110	K Series	Base Edge Assembly	324-1393*	1500	1500	445	325	60	22.5	1390	Stepped	4
110	K Series	Base Edge Assembly	241-6722	1507	1507	380	380	60	22.5	1406	Straight	6
110	K Series	Base Edge Assembly	258-4576	1507	1507	325	325	60	22.5	1406	Straight	6
110	K Series	Conversion Edge	253-0109	1507	1507	325	325	60	22.5	1406	Straight	6
110	K Series	Base Edge Assembly	260-9417**	1659	1659	380	380	60	22.5	1446	Straight	7
110	K Series	Base Edge Assembly	481-1242*	1659	1659	380	380	60	22.5	1446	Straight	7
110	Advansys	Base Edge Assembly	528-2090	1659	1659	380	380	60	22.5	1446	Straight	7

Discontinued
Canceled
(Reference)

Part is discontinued. Please contact your service representative.
Part is canceled. Please contact your customer service representative.
Part number is not serviceable. For reference only.

Base Edge Dimensional Reference

Adapter Size Class	Adapter Series	Edge Type	Part Number								Edge Style	Adapter Quantity Welded on Edge
				A	B	C	D	E	F	G		
110	K Series	Base Edge Assembly	290-2826*	1626	1626	325	325	60	22.5	1446	Straight	4
110	K Series	Base Edge Assembly	301-8290	1600	1600	380	380	60	22.5	1470	Straight	5
110	K Series	Base Edge Assembly	318-4409*	1665	1587	380	380	60	22.5	1485	Straight	6
110	K Series	Base Edge Assembly	264-2667*	1600	1600	325	325	60	22.5	1490	Straight	5
110	K Series	Base Edge Assembly	476-2251	1676	1598	325	325	60	22.5	1496	Straight	5
110	K Series	Base Edge Assembly	476-2250	1676	1598	325	325	60	22.5	1496	Straight	5
110	Advansys	Base Edge Assembly	532-8349	1676	1598	325	325	60	22.5	1496	Straight	5
110	K Series	Base Edge Assembly	517-0812	1676	1598	325	325	60	22.5	1496	Straight	5
110	K Series	Base Edge Assembly	476-2244	1676	1598	376.2	325	60	22.5	1496	Stepped	5
110	K Series	Base Edge Assembly	476-2244	1676	1598	376.2	325	60	22.5	1496	Stepped	5
110	Advansys	Base Edge Assembly	533-1975	1676	1598	376.2	325	60	22.5	1496	Stepped	5
110	K Series	Base Edge Assembly	476-2245	1676	1598	431.2	380	60	22.5	1496	Stepped	5
110	K Series	Base Edge Assembly	476-2245	1676	1598	431.2	380	60	22.5	1496	Stepped	5
110	Advansys	Base Edge Assembly	535-7482	1676	1598	431.2	380	60	22.5	1496	Stepped	5
110	K Series	Base Edge Assembly	476-2232	1676	1598	325	325	60	22.5	1496	Straight	7
110	K Series	Base Edge Assembly	476-2232	1676	1598	325	325	60	22.5	1496	Straight	7
110	Advansys	Base Edge Assembly	533-1199	1676	1598	325	325	60	22.5	1496	Straight	7
110	K Series	Base Edge Assembly	476-2240	1676	1598	380	380	60	22.5	1496	Straight	7
110	K Series	Base Edge Assembly	476-2240	1676	1598	380	380	60	22.5	1496	Straight	7
110	Advansys	Base Edge Assembly	528-2094	1676	1598	380	380	60	22.5	1496	Straight	7
110	K Series	Base Edge Assembly	(443-4440)	1676	1598	325	325	60	22.5	1496	Straight	6
110	K Series	Base Edge Assembly	364-0067*	1676	1598	325	325	60	22.5	1496	Straight	5
110	K Series	Base Edge Assembly	446-1246	1623	1598	325	325	60	22.5	1496	Straight	5
110	K Series	Base Edge Assembly	359-3644	1676	1598	380	380	60	22.5	1496	Straight	5
110	K Series	Base Edge Assembly	445-0064	1623	1598	431.2	380	60	22.5	1496	Stepped	5
110	K Series	Base Edge Assembly	476-2253	1676	1598	380	380	60	22.5	1496	Straight	5
110	K Series	Base Edge Assembly	476-2253	1676	1598	380	380	60	22.5	1496	Straight	5
110	Advansys	Base Edge Assembly	528-2093	1676	1598	380	380	60	22.5	1496	Straight	5
110	K Series	Base Edge Assembly	461-5544	1676	1598	376.2	325	60	22.5	1496	Stepped	5
110	K Series	Base Edge Assembly	(487-7781)	1676	1598	325	325	60	22.5	1496	Straight	6
110	K Series	Base Edge Assembly	524-8494	1676	1598	325	325	60	22.5	1496	Straight	6
110	K Series	Base Edge Assembly	476-3430	1676	1598	380	380	60	22.5	1496	Straight	5
110	K Series	Base Edge Assembly	476-3430	1676	1598	380	380	60	22.5	1496	Straight	5
110	Advansys	Base Edge Assembly	528-2093	1676	1598	380	380	60	22.5	1496	Straight	5
110	K Series	Base Edge Assembly	295-8585*	1650	1650	380	380	60	22.5	1520	Straight	5
110	K Series	Base Edge Assembly	475-4301	1710	1632	325	325	60	22.5	1530	Straight	7
110	K Series	Base Edge Assembly	(490-5912)	1720	1642	380	380	60	22.5	1530	Straight	7
110	K Series	Base Edge Assembly	425-3864	1710	1632	325	325	60	22.5	1530	Straight	6
110	K Series	Base Edge Assembly	(492-3702)	1710	1632	380	380	60	22.5	1530	Straight	6
110	K Series	Base Edge Assembly	(389-7176)	1720	1642	380	380	60	22.5	1540	Straight	6
110	K Series	Base Edge Assembly	264-5423	1650	1650	445	325	60	22.5	1540	Stepped	5
110	K Series	Base Edge Assembly	264-2668	1650	1650	325	325	60	22.5	1540	Straight	5
110	K Series	Base Edge Assembly	476-2242	1720	1642	380	380	60	22.5	1540	Straight	7
110	K Series	Base Edge Assembly	476-2242	1720	1642	380	380	60	22.5	1540	Straight	7
110	Advansys	Base Edge Assembly	528-2084	1720	1642	380	380	60	22.5	1540	Straight	7
110	K Series	Base Edge Assembly	241-6723	1659	1659	380	380	60	22.5	1558	Straight	7
110	K Series	Base Edge Assembly	258-4577	1659	1659	325	325	60	22.5	1558	k?	7
110	K Series	Base Edge Assembly	(276-0023)	1659	1659	325	325	60	22.5	1558	Straight	5
110	K Series	Conversion Edge	253-0112	1659	1659	325	325	60	22.5	1558	Straight	5
110	K Series	Base Edge Assembly	(274-1368)	1659	1659	325	325	60	22.5	1572	Straight	5
110	K Series	Conversion Edge	253-0112	1659	1659	325	325	60	22.5	1572	Straight	5
110	K Series	Base Edge Assembly	273-1420*	1700	1700	350	350	60	22.5	1583	Straight	5
110	K Series	Base Edge Assembly	264-2669	1700	1700	325	325	60	22.5	1590	Straight	5
110	K Series	Base Edge Assembly	324-0059	1757	1677	491.4	380	60	22.5	1593	Stepped	5
110	Advansys	Base Edge Assembly	563-0195	1757	1677	491.4	380	60	22.5	1593	Stepped	5
110	K Series	Base Edge Assembly	530-1885	1776	1698	431	380	60	22.5	1596	Stepped	5
110	K Series	Base Edge Assembly	290-2838*	1778	1700	325	325	60	22.5	1598	Straight	5
110	K Series	Base Edge Assembly	481-1243	1812	1812	380	380	60	22.5	1599	Straight	7
110	K Series	Base Edge Assembly	481-1243	1812	1812	380	380	60	22.5	1599	Straight	7
110	Advansys	Base Edge Assembly	528-2091	1812	1812	380	380	60	22.5	1599	Straight	7
110	K Series	Base Edge Assembly	476-2259	1780	1702	380	380	60	22.5	1600	Straight	5
110	K Series	Base Edge Assembly	476-2259	1780	1702	380	380	60	22.5	1600	Straight	5
110	K Series	Base Edge Assembly	257-5358*	1750	1750	380	380	60	22.5	1620	Straight	5
110	K Series	Base Edge Assembly	319-4955*	1750	1750	380	380	60	22.5	1620	Straight	5
110	K Series	Base Edge Assembly	300-6390	1734	1734	380	380	60	22.5	1633	Straight	7
110	K Series	Base Edge Assembly	476-3431	1830	1752	380	380	60	22.5	1650	Straight	7
110	K Series	Base Edge Assembly	476-3431	1830	1752	380	380	60	22.5	1650	Straight	7
110	Advansys	Base Edge Assembly	528-2095	1830	1752	380	380	60	22.5	1650	Straight	7
110	K Series	Base Edge Assembly	488-2668	1830	1752	325	325	60	22.5	1650	Straight	5
110	Advansys	Base Edge Assembly	532-8350	1830	1752	325	325	60	22.5	1650	Straight	5
110	K Series	Base Edge Assembly	481-5344?	1830	1752	443	380	60	22.5	1650	Stepped	5

Cat Hydraulic Excavators

BASE EDGE TABLE

Base Edge Dimensional Reference												
Adapter Size Class	Adapter Series	Edge Type	Part Number								Edge Style	Adapter Quantity Welded on Edge
				A	B	C	D	E	F	G		
110	K Series	Base Edge Assembly	481-5344	1830	1752	443	380	60	22.5	1650	Stepped	5
110	Advansys	Base Edge Assembly	535-7484	1830	1752	443	380	60	22.5	1650	Stepped	5
110	K Series	Base Edge Assembly	476-2258	1830	1752	380	380	60	22.5	1650	Straight	5
110	K Series	Base Edge Assembly	476-2258	1830	1752	380	380	60	22.5	1650	Straight	5
110	Advansys	Base Edge Assembly	528-4546	1830	1752	380	380	60	22.5	1650	Straight	5
110	K Series	Base Edge Assembly	476-2251	1830	1752	325	325	60	22.5	1650	Straight	5
110	K Series	Base Edge Assembly	476-2251	1830	1752	325	325	60	22.5	1650	Straight	5
110	Advansys	Base Edge Assembly	532-8350	1830	1752	325	325	60	22.5	1650	Straight	5
110	K Series	Base Edge Assembly	476-2233	1830	1752	325	325	60	22.5	1650	Straight	7
110	K Series	Base Edge Assembly	476-2233	1830	1752	325	325	60	22.5	1650	Straight	7
110	Advansys	Base Edge Assembly	533-1200	1830	1752	325	325	60	22.5	1650	Straight	7
110	K Series	Base Edge Assembly	314-8429*	1830	1752	380	380	60	22.5	1650	Straight	7
110	K Series	Base Edge Assembly	315-9710	1830	1752	380	380	60	22.5	1650	Straight	7
110	K Series	Base Edge Assembly	(274-1380)	1769.4	1769.4	325	325	60	22.5	1668	Straight	6
110	K Series	Base Edge Assembly	277-6805*	1800	1800	380	380	60	22.5	1670	Straight	5
110	K Series	Base Edge Assembly	266-8404	1800	1800	445	325	60	22.5	1690	Stepped	5
110	K Series	Base Edge Assembly	311-0948	1800	1800	325	325	60	22.5	1690	Straight	5
110	Advansys	Base Edge Assembly	(541-1892)	1864	1786	445	325	60	22.5	1690	Stepped	5
110	K Series	Base Edge Assembly	476-2256	1880	1802	380	380	60	22.5	1700	Straight	6
110	K Series	Base Edge Assembly	476-2256	1880	1802	380	380	60	22.5	1700	Straight	6
110	Advansys	Base Edge Assembly	528-2096	1880	1802	380	380	60	22.5	1700	Straight	6
110	K Series	Base Edge Assembly	476-2241	1880	1802	380	380	60	22.5	1700	Straight	7
110	K Series	Base Edge Assembly	476-2241	1880	1802	380	380	60	22.5	1700	Straight	7
110	Advansys	Base Edge Assembly	528-2085	1880	1802	380	380	60	22.5	1700	Straight	7
110	K Series	Base Edge Assembly	346-3153*	1880	1802	513	380	60	22.5	1700	Stepped	5
110	K Series	Base Edge Assembly	(524-8493)	1880	1802	380	380	60	22.5	1700	Straight	6
110	K Series	Base Edge Assembly	244-3889	1812	1812	380	380	60	22.5	1711	Straight	7
110	K Series	Base Edge Assembly	311-1854*	1905	1827	380	380	60	22.5	1725	Straight	6
110	K Series	Base Edge Assembly	(490-0724)	1910	1832	325	325	60	22.5	1730	Straight	5
110	K Series	Base Edge Assembly	469-4311	1964	1964	380	380	60	22.5	1751	Straight	8
110	K Series	Base Edge Assembly	476-2225	1964	1964	380	380	60	22.5	1751	Straight	8
110	Advansys	Base Edge Assembly	528-2092	1964	1964	380	380	60	22.5	1751	Straight	8
110	K Series	Base Edge Assembly	476-2225	1964	1964	380	380	60	22.5	1751	Straight	8
110	K Series	Base Edge Assembly	(337-5333)	1900	1900	380	380	60	22.5	1770	Straight	5
110	K Series	Base Edge Assembly	331-1864*	1956	1878	380	380	60	22.5	1776	Straight	7
110	K Series	Base Edge Assembly	273-1421	1900	1900	350	350	60	22.5	1783	Straight	5
110	K Series	Base Edge Assembly	(269-6372)	1895	1895	380	380	60	22.5	1786.8	Straight	6
110	K Series	Base Edge Assembly	275-5774*	1969	1902	380	380	60	22.5	1789.6	Straight	7
110	K Series	Base Edge Assembly	295-0443*	1900	1900	325	325	60	22.5	1790	Straight	5
110	K Series	Base Edge Assembly	328-3157*	1970	1890	620	380	60	22.5	1804	Stepped	6
110	K Series	Base Edge Assembly	(492-3770)	2020	1942	380	380	60	22.5	1840	Straight	6
110	K Series	Base Edge Assembly	476-2243	2043	1963	380	380	60	22.5	1863	Straight	7
110	K Series	Base Edge Assembly	476-2243	2043	1963	380	380	60	22.5	1863	Straight	7
110	Advansys	Base Edge Assembly	528-2086	2043	1963	380	380	60	22.5	1863	Straight	7
110	K Series	Base Edge Assembly	292-5767*	2000	2000	380	380	60	22.5	1870	Straight	6
110	K Series	Base Edge Assembly	361-4583*	2000	2000	325	325	60	22.5	1890	Straight	5
110	K Series	Base Edge Assembly	253-0104	903	903	325	325	60	22.5	-	Straight	1
110	Advansys	Base Edge Assembly	547-5081	903	903	325	325	60	22.5	-	Straight	1
110	K Series	Conversion Edge	253-0103	751	751	325	325	60	22.5	-	Straight	1
110	K Series	Base Edge Assembly	533-1844	700	674	380	380	60	22.5	470	Straight	3
110	K Series	Base Edge Assembly	297-5917	2204	2204	380	380	60	22.5	2009	Straight	6
110	K Series	Base Edge Assembly	378-0615*	1099	1025	325	325	60	22.5	922	Straight	4
110	K Series	Base Edge Assembly	(361-2324)	1099	1025	325	325	60	22.5	912.6	Straight	4
110	K Series	Base Edge Assembly	(383-3292)	1932	1858	380	380	60	22.5	1745.4	Straight	5
110	K Series	Base Edge Assembly	332-9159*	1645	1645	350	350	60	22.5	-	Straight	5
110	K Series	Base Edge Assembly	281-7649	1964	1964	380	380	60	22.5	1751	Straight	7
110	K Series	Base Edge Assembly	260-9414*	1202	1202	380	380	60	22.5	989	Straight	5
110	K Series	Base Edge Assembly	271-7296*	1216	1142	325	325	60	22.5	1029.8	Straight	5
110	K Series	Base Edge Assembly	273-1331*	1063	989	325	325	60	22.5	724.2	Straight	4
110	K Series	Base Edge Assembly	271-7298*	1520	1446	325	325	60	22.5	1333.8	Straight	6
110	K Series	Base Edge Assembly	290-2808*	1757	1677	620	380	60	22.5	1593	Stepped	6
110	K Series	Base Edge Assembly	310-2006*	760	760	380	380	60	22.5	544	Straight	3
110	K Series	Base Edge Assembly	282-7810*	694	694	380	380	60	22.5	500	Straight	3
110	K Series	Base Edge Assembly	277-3961*	1521.2	1447.2	380	380	60	22.5	1333.6	Straight	6
110	K Series	Base Edge Assembly	275-5772*	1826	1752	380	380	60	22.5	1639.6	Straight	7
110	K Series	Base Edge Assembly	305-2867	1241	1182	325	325	60	22.5	1082.2	Straight	5
110	K Series	Base Edge Assembly	271-7297*	1368	1294	325	325	60	22.5	1181.8	Straight	5
110	K Series	Base Edge Assembly	357-8194*	1932	1858	380	380	60	22.5	1745.4	Straight	7
110	Advansys	Base Edge Assembly	544-2722	1524	1446	380	380	60	22.5	1344	Straight	5
110	Advansys	Base Edge Assembly	544-2723	1588	1510	380	380	60	22.5	1588	Straight	5
110	Advansys	Conversion Edge	554-0854	1202	1202	380	380	60	22.5	-	Straight	3

Discontinued
Canceled
(Reference)

Part is discontinued. Please contact your service representative.
Part is canceled. Please contact your customer service representative.
Part number is not serviceable. For reference only.

Base Edge Dimensional Reference

Adapter Size Class	Adapter Series	Edge Type	Part Number								Edge Style	Adapter Quantity Welded on Edge
				A	B	C	D	E	F	G		
110	Advansys	Conversion Edge	554-0855	794	716	380	380	60	22.5	-	Straight	1
110	Advansys	Base Edge Assembly	575-5247	1697	1602	480	480	60	22.5	1442.2	Straight	4
130	K Series	Base Edge Assembly	(365-7272)	1700	1666	510	400	70	22.5	1535	Stepped	4
130	K Series	Base Edge Assembly	(365-7272)	1700	1666	510	400	70	22.5	1535	Stepped	4
130	K Series	Base Edge Assembly	273-1430	1800	1766	510	400	70	22.5	1629	Stepped	5
130	K Series	Base Edge Assembly	273-1430	1800	1766	510	400	70	22.5	1629	Stepped	5
130	Advansys	Base Edge Assembly	540-4032	1800	1766	510	400	70	22.5	1629	Stepped	5
130	K Series	Base Edge Assembly	265-3376*	1895	1895	380	380	70	22.5	1758	Straight	6
130	K Series	Base Edge Assembly	265-3376*	1895	1895	380	380	70	22.5	1758	Straight	6
130	Advansys	Base Edge Assembly	556-7895	1895	1895	380	380	70	22.5	1758	Straight	6
130	K Series	Conversion Edge	257-1753	1895	1895	380	380	70	22.5	1758	Straight	6
130	K Series	Base Edge Assembly	357-0977*	1750	1716	400	400	70	22.5	1583	Straight	5
130	K Series	Base Edge Assembly	357-0977*	1750	1716	400	400	70	22.5	1583	Straight	5
130	K Series	Base Edge Assembly	260-1256	1475	1435.6	560	450	70	22.5	1310	Stepped	4
130	K Series	Base Edge Assembly	260-1256	1475	1435.6	560	450	70	22.5	1310	Stepped	4
130	Advansys	Base Edge Assembly	566-9372	1475	1435.6	560	450	70	22.5	1310	Stepped	4
130	K Series	Base Edge Assembly	265-3400	1970	1870	630	380	70	22.5	1793	Stepped	6
130	K Series	Base Edge Assembly	265-3400	1970	1870	630	380	70	22.5	1793	Stepped	6
130	Advansys	Base Edge Assembly	550-4397	1970	1870	630	380	70	22.5	1793	Stepped	6
130	K Series	Base Edge Assembly	260-1257*	1725	1685.6	560	450	70	22.5	1560	Stepped	4
130	K Series	Base Edge Assembly	260-1257*	1725	1685.6	560	450	70	22.5	1560	Stepped	4
130	K Series	Base Edge Assembly	253-9075*	1238	1238	421	421	70	22.5	1101	Straight	4
130	K Series	Base Edge Assembly	253-9075*	1238	1238	421	421	70	22.5	1101	Straight	4
130	K Series	Base Edge Assembly	260-1254*	1950	1898	450	450	70	22.5	1760	Straight	4
130	K Series	Base Edge Assembly	260-1254*	1950	1898	450	450	70	22.5	1760	Straight	4
130	Advansys	Base Edge Assembly	568-8830	1950	1898	450	450	70	22.5	1760	Straight	4
130	K Series	Base Edge Assembly	274-8285*	1400	1366	400	400	70	22.5	1232	Straight	4
130	K Series	Base Edge Assembly	274-8285*	1400	1366	400	400	70	22.5	1232	Straight	4
130	Advansys	Base Edge Assembly	566-1848	1400	1366	400	400	70	22.5	1232	Straight	4
130	K Series	Base Edge Assembly	276-8732*	1750	1716	487.2	400	70	22.5	1583	Stepped	4
130	K Series	Base Edge Assembly	276-8732*	1750	1716	487.2	400	70	22.5	1583	Stepped	4
130	Advansys	Base Edge Assembly	568-8845	1750	1716	487.2	400	70	22.5	1583	Stepped	4
130	K Series	Base Edge Assembly	256-9465*	1450	1416	510	400	70	22.5	1283	Stepped	4
130	K Series	Base Edge Assembly	256-9465*	1450	1416	510	400	70	22.5	1283	Stepped	4
130	Advansys	Base Edge Assembly	566-9373	1450	1416	510	400	70	22.5	1283	Stepped	4
130	K Series	Base Edge Assembly	273-1424*	1750	1716	400	400	70	22.5	1583	Straight	4
130	K Series	Base Edge Assembly	273-1424*	1750	1716	400	400	70	22.5	1583	Straight	4
130	K Series	Base Edge Assembly	260-1255*	1500	1448	450	450	70	22.5	1310	Straight	3
130	K Series	Base Edge Assembly	260-1255*	1500	1448	450	450	70	22.5	1310	Straight	3
130	K Series	Base Edge Assembly	273-1429	1700	1666	510	400	70	22.5	1535	Stepped	4
130	K Series	Base Edge Assembly	273-1429	1700	1666	510	400	70	22.5	1535	Stepped	4
130	Advansys	Base Edge Assembly	550-8875	1700	1666	510	400	70	22.5	1535	Stepped	4
130	K Series	Base Edge Assembly	273-1409	1450	1416	510	400	70	22.5	1285	Stepped	4
130	K Series	Base Edge Assembly	273-1409	1450	1416	510	400	70	22.5	1285	Stepped	4
130	Advansys	Base Edge Assembly	550-4399	1450	1416	510	400	70	22.5	1285	Stepped	4
130	K Series	Base Edge Assembly	273-1425*	1850	1816	400	400	70	22.5	1683	Straight	5
130	K Series	Base Edge Assembly	273-1425*	1850	1816	400	400	70	22.5	1683	Straight	5
130	Advansys	Base Edge Assembly	550-8871	1850	1816	400	400	70	22.5	1683	Straight	5
130	K Series	Base Edge Assembly	(276-0013)	1418	1418	421	421	70	22.5	1280	Straight	5
130	K Series	Base Edge Assembly	(276-0013)	1418	1418	421	421	70	22.5	1280	Straight	5
130	K Series	Base Edge Assembly	301-2987*	1190	1138	450	450	70	22.5	1000	Straight	3
130	K Series	Base Edge Assembly	301-2987*	1190	1138	450	450	70	22.5	1000	Straight	3
130	K Series	Base Edge Assembly	253-9076*	1392	1392	421	421	70	22.5	1254	Straight	4
130	K Series	Base Edge Assembly	253-9076*	1392	1392	421	421	70	22.5	1254	Straight	4
130	K Series	Base Edge Assembly	273-1428	1550	1516	510	400	70	22.5	1385	Stepped	4
130	K Series	Base Edge Assembly	273-1428	1550	1516	510	400	70	22.5	1385	Stepped	4
130	Advansys	Base Edge Assembly	550-8868	1550	1516	510	400	70	22.5	1385	Stepped	4
130	K Series	Base Edge Assembly	520-3996	1905	1805	436	380	70	22.5	1700	Stepped	5
130	Advansys	Base Edge Assembly	532-2964	1905	1805	436	380	70	22.5	1700	Stepped	5
130	K Series	Base Edge Assembly	518-5938	1808	1708	464	380	70	22.5	1600	Stepped	4
130	K Series	Base Edge Assembly	512-9249	1843	1732	380	380	70	22.5	1638	Straight	5
130	K Series	Base Edge Assembly	362-5049	1943	1848	380	380	70	22.5	1738	Straight	5
130	K Series	Base Edge Assembly	509-7006	1943	1848	380	380	70	22.5	1738	Straight	5
130	Advansys	Base Edge Assembly	517-2365	1943	1848	380	380	70	22.5	1738	Straight	5
130	K Series	Base Edge Assembly	484-0392	1568	1473	380	380	70	22.5	1363	Straight	4
130	K Series	Base Edge Assembly	484-0392	1568	1473	380	380	70	22.5	1363	Straight	4
130	K Series	Base Edge Assembly	484-0381	1549	1454	380	380	70	22.5	1344	Straight	5
130	K Series	Base Edge Assembly	484-0381	1549	1454	380	380	70	22.5	1344	Straight	5
130	Advansys	Base Edge Assembly	517-2359	1549	1454	380	380	70	22.5	1344	Straight	5
130	K Series	Base Edge Assembly	484-0410?	1763	1663	461	380	70	22.5	1558	Stepped	4

Cat Hydraulic Excavators

BASE EDGE TABLE

Base Edge Dimensional Reference												
Adapter Size Class	Adapter Series	Edge Type	Part Number								Edge Style	Adapter Quantity Welded on Edge
				A	B	C	D	E	F	G		
130	K Series	Base Edge Assembly	484-0410	1763	1663	461	380	70	22.5	1558	Stepped	4
130	Advansys	Base Edge Assembly	553-5216	1763	1663	461	380	70	22.5	1558	Stepped	4
130	K Series	Base Edge Assembly	484-0404	1763	1663	461	380	70	22.5	1558	Stepped	4
130	K Series	Base Edge Assembly	484-0404	1763	1663	461	380	70	22.5	1558	Stepped	4
130	Advansys	Base Edge Assembly	517-2367	1763	1663	461	380	70	22.5	1558	Stepped	4
130	K Series	Base Edge Assembly	480-3495	939	844	380	380	70	22.5	734	Straight	3
130	K Series	Base Edge Assembly	480-3495	939	844	380	380	70	22.5	734	Straight	3
130	K Series	Base Edge Assembly	484-0382	1701	1606	380	380	70	22.5	1496	Straight	5
130	K Series	Base Edge Assembly	484-0382	1701	1606	380	380	70	22.5	1496	Straight	5
130	Advansys	Base Edge Assembly	517-2360	1701	1606	380	380	70	22.5	1496	Straight	5
130	K Series	Base Edge Assembly	484-0403	1643	1543	450	380	70	22.5	1438	Stepped	4
130	K Series	Base Edge Assembly	484-0403	1643	1543	450	380	70	22.5	1438	Stepped	4
130	Advansys	Base Edge Assembly	518-9272	1643	1543	450	380	70	22.5	1438	Stepped	4
130	K Series	Base Edge Assembly	484-0379	1843	1732	380	380	70	22.5	1638	Straight	4
130	K Series	Base Edge Assembly	484-0379	1843	1732	380	380	70	22.5	1638	Straight	4
130	Advansys	Base Edge Assembly	517-2364	1843	1732	380	380	70	22.5	1638	Straight	4
130	K Series	Base Edge Assembly	484-0394, 419-5463 ⁺	1843	1743	464.5	380	70	22.5	1638	Stepped	4
130	K Series	Base Edge Assembly	484-0394	1843	1743	464.5	380	70	22.5	1638	Stepped	4
130	Advansys	Base Edge Assembly	517-2366	1843	1743	464.5	380	70	22.5	1638	Stepped	4
130	K Series	Base Edge Assembly	315-3488*	1397	1286	380	380	70	22.5	1192	Straight	5
130	K Series	Base Edge Assembly	(484-0378)	1397	1286	380	380	70	22.5	1192	Straight	5
130	K Series	Base Edge Assembly	484-0380	1397	1302	380	380	70	22.5	1192	Straight	4
130	K Series	Base Edge Assembly	484-0380	1397	1302	380	380	70	22.5	1192	Straight	4
130	Advansys	Base Edge Assembly	517-2358	1397	1302	380	380	70	22.5	1192	Straight	4
130	Advansys	Base Edge Assembly	523-5769	1397	1302	380	380	70	22.5	1192	Straight	4
130	K Series	Base Edge Assembly	484-0383	1855	1760	380	380	70	22.5	1650	Straight	6
130	K Series	Base Edge Assembly	484-0383	1855	1760	380	380	70	22.5	1650	Straight	6
130	Advansys	Base Edge Assembly	517-2361	1855	1760	380	380	70	22.5	1650	Straight	6
130	K Series	Base Edge Assembly	484-0385	1963	1863	440	380	70	22.5	1738	Stepped	5
130	K Series	Base Edge Assembly	484-0385	1963	1863	440	380	70	22.5	1738	Stepped	5
130	Advansys	Base Edge Assembly	517-2376	1963	1863	440	380	70	22.5	1738	Stepped	5
130	K Series	Base Edge Assembly	484-0407	1905	1805	436	380	70	22.5	1700	Stepped	5
130	K Series	Base Edge Assembly	484-0407	1905	1805	436	380	70	22.5	1700	Stepped	5
130	Advansys	Base Edge Assembly	517-2371	1905	1805	436	380	70	22.5	1700	Stepped	5
130	K Series	Base Edge Assembly	380-1588	1999	1888	380	380	70	22.5	1784.8	Straight	6
130	K Series	Base Edge Assembly	494-1950	1999	1888	380	380	70	22.5	1784.8	Straight	6
130	Advansys	Base Edge Assembly	517-2357	1999	1888	380	380	70	22.5	1784.8	Straight	6
130	K Series	Conversion Edge	368-3678*	1999	1888	380	380	70	22.5	1784.8	Straight	6
130	K Series	Base Edge Assembly	480-6037	939	828	412	380	70	22.5	701	Stepped	3
130	K Series	Base Edge Assembly	480-6037	939	828	412	380	70	22.5	701	Stepped	3
130	K Series	Base Edge Assembly	484-0406	1701	1601	455	380	70	22.5	1496	Stepped	4
130	K Series	Base Edge Assembly	484-0406	1701	1601	455	380	70	22.5	1496	Stepped	4
130	Advansys	Base Edge Assembly	517-2372	1701	1601	455	380	70	22.5	1496	Stepped	4
130	K Series	Base Edge Assembly	484-0388	1245	1150	380	380	70	22.5	1040	Straight	4
130	K Series	Base Edge Assembly	484-0388	1245	1150	380	380	70	22.5	1040	Straight	4
130	Advansys	Base Edge Assembly	517-2362	1245	1150	380	380	70	22.5	1040	Straight	4
130	K Series	Base Edge Assembly	484-0409	1397	1302	380	380	70	22.5	1192	Straight	5
130	K Series	Base Edge Assembly	484-0409	1397	1302	380	380	70	22.5	1192	Straight	5
130	K Series	Base Edge Assembly	484-8408	1843	1743	431	380	70	22.5	1638	Stepped	5
130	K Series	Base Edge Assembly	484-0408	1843	1743	431	380	70	22.5	1638	Stepped	5
130	K Series	Base Edge Assembly	484-0389	1905	1810	380	380	70	22.5	1700	Straight	5
130	K Series	Base Edge Assembly	484-0389	1905	1810	380	380	70	22.5	1700	Straight	5
130	Advansys	Base Edge Assembly	517-2370	1905	1810	380	380	70	22.5	1700	Straight	5
130	K Series	Base Edge Assembly	484-0395	1468	1368	434	380	70	22.5	1263	Stepped	4
130	K Series	Base Edge Assembly	484-0395	1468	1368	434	380	70	22.5	1263	Stepped	4
130	Advansys	Base Edge Assembly	568-3343	1468	1368	434	380	70	22.5	1263	Stepped	4
130	K Series	Base Edge Assembly	484-0396	1568	1468	443	380	70	22.5	1363	Stepped	4
130	K Series	Base Edge Assembly	484-0396	1568	1468	443	380	70	22.5	1363	Stepped	4
130	Advansys	Base Edge Assembly	517-2374	1568	1468	443	380	70	22.5	1363	Stepped	4
130	K Series	Base Edge Assembly	482-8587	2081	1981	466	380	70	22.5	1876	Stepped	6
130	K Series	Base Edge Assembly	317-7866	1745	1634	380	380	70	22.5	1540	Straight	5
130	K Series	Base Edge Assembly	317-7866	1745	1634	380	380	70	22.5	1540	Straight	5
130	K Series	Conversion Edge	368-3739*	1745	1634	380	380	70	22.5	1540	Straight	5
130	K Series	Base Edge Assembly	484-0387	1701	1601	455	380	70	22.5	1496	Stepped	4
130	K Series	Base Edge Assembly	484-0387	1701	1601	455	380	70	22.5	1496	Stepped	4
130	Advansys	Base Edge Assembly	517-2369	1701	1601	455	380	70	22.5	1496	Stepped	4
130	K Series	Base Edge Assembly	484-0384	1643	1543	450	380	70	22.5	1438	Stepped	4
130	K Series	Base Edge Assembly	484-0384	1643	1543	450	380	70	22.5	1438	Stepped	4
130	Advansys	Base Edge Assembly	517-2375	1643	1543	450	380	70	22.5	1438	Stepped	4
130	K Series	Base Edge Assembly	484-0393	2023	1928	380	380	70	22.5	1818	Straight	5
130	K Series	Base Edge Assembly	484-0393	2023	1928	380	380	70	22.5	1818	Straight	5

Base Edge Dimensional Reference

Adapter Size Class	Adapter Series	Edge Type	Part Number								Edge Style	Adapter Quantity Welded on Edge
				A	B	C	D	E	F	G		
130	Advansys	Base Edge Assembly	517-2373	2023	1928	380	380	70	22.5	1818	Straight	5
130	K Series	Base Edge Assembly	341-5688*	1253	1142	380	380	70	22.5	1040	Straight	4
130	K Series	Base Edge Assembly	(501-4504)	1253	1142	380	380	70	22.5	1040	Straight	4
130	K Series	Base Edge Assembly	484-0390	1643	1548	380	380	70	22.5	1438	Straight	4
130	K Series	Base Edge Assembly	484-0390	1643	1548	380	380	70	22.5	1438	Straight	4
130	Advansys	Base Edge Assembly	517-2363	1643	1548	380	380	70	22.5	1438	Straight	4
130	K Series	Base Edge Assembly	433-6512	1548	1458	380	380	70	22.5	1344	Straight	5
130	Advansys	Base Edge Assembly	519-2242	1548	1458	380	380	70	22.5	1344	Straight	5
130	K Series	Base Edge Assembly	484-0397	1568	1468	443	380	70	22.5	1363	Stepped	4
130	K Series	Base Edge Assembly	484-0397	1568	1468	443	380	70	22.5	1363	Stepped	4
130	K Series	Base Edge Assembly	484-0391	1468	1373	380	380	70	22.5	1263	Straight	4
130	K Series	Base Edge Assembly	484-0391	1468	1373	380	380	70	22.5	1263	Straight	4
130	K Series	Base Edge Assembly	(483-0429)	1745	1650	380	380	70	22.5	1540	Straight	5
130	K Series	Base Edge Assembly	484-0405	1549	1449	442	380	70	22.5	1344	Stepped	4
130	K Series	Base Edge Assembly	484-0405	1549	1449	442	380	70	22.5	1344	Stepped	4
130	Advansys	Base Edge Assembly	525-4059	1549	1449	442	380	70	22.5	1344	Stepped	4
130	K Series	Base Edge Assembly	484-0386	1549	1449	442	380	70	22.5	1344	Stepped	4
130	K Series	Base Edge Assembly	484-0386	1549	1449	442	380	70	22.5	1344	Stepped	4
130	Advansys	Base Edge Assembly	517-2368	1549	1449	442	380	70	22.5	1344	Stepped	4
130	K Series	Base Edge Assembly	257-1755	1957	1957	380	380	70	22.5	1083	Straight	4
130	K Series	Base Edge Assembly	257-1755	1957	1957	380	380	70	22.5	1083	Straight	4
130	Advansys	Base Edge Assembly	547-5085	1957	1957	380	380	70	22.5	1083	Straight	4
130	K Series	Base Edge Assembly	489-6699*	1372	1272	540	486	70	22.5	380	Stepped	2
130	K Series	Base Edge Assembly	257-1752	1535	1535	380	380	70	22.5	687.6	Straight	3
130	K Series	Base Edge Assembly	257-1752	1535	1535	380	380	70	22.5	687.6	Straight	3
130	Advansys	Base Edge Assembly	538-9163	1535	1535	380	380	70	22.5	687.6	Straight	3
130	K Series	Conversion Edge	253-0128	1356	1356	380	380	70	22.5	-	Straight	3
130	K Series	Conversion Edge	253-0128	1356	1356	380	380	70	22.5	-	Straight	3
130	Advansys	Conversion Edge	535-6639	1356	1356	380	380	70	22.5	-	Straight	3
130	K Series	Base Edge Assembly	253-0127	1212	1212	380	380	70	22.5	353.4	Straight	2
130	K Series	Base Edge Assembly	253-0127	1212	1212	380	380	70	22.5	353.4	Straight	2
130	Advansys	Base Edge Assembly	547-5084	1212	1212	380	380	70	22.5	353.4	Straight	2
130	K Series	Conversion Edge	257-1753	1895	1895	380	380	70	22.5	1041	Straight	4
130	K Series	Conversion Edge	257-1753	1895	1895	380	380	70	22.5	1041	Straight	4
130	Advansys	Conversion Edge	535-6640	1895	1895	380	380	70	22.5	1041	Straight	4
130	K Series	Base Edge Assembly	253-0126*	1015	1015	380	380	70	22.5	-	Straight	1
130	K Series	Base Edge Assembly	253-0126*	1015	1015	380	380	70	22.5	-	Straight	1
130	Advansys	Base Edge Assembly	550-8874	1015	1015	380	380	70	22.5	-	Straight	1
130	Advansys	Base Edge Assembly	382-1840*	1863	1760	380	380	70	22.5	1650.2	Straight	6
130	Advansys	Base Edge Assembly	382-1854*	1852.4	1743	431	380	70	22.5	1635.7	Stepped	5
130	K Series	Base Edge Assembly	323-6420*	1426	1285	380	380	70	22.5	1200	Straight	5
130	Advansys	Base Edge Assembly	517-2356	1426	1285	380	380	70	22.5	1200	Straight	5
130	K Series	Base Edge Assembly	433-6514	1701	1611	380	380	70	22.5	1496	Straight	5
130	Advansys	Base Edge Assembly	519-2243	1701	1611	380	380	70	22.5	1496	Straight	5
130	K Series	Base Edge Assembly	445-5744	1569	1474	380	380	70	22.5	1363	Straight	5
130	Advansys	Base Edge Assembly	523-3399	1569	1474	380	380	70	22.5	1363	Straight	5
130	K Series	Base Edge Assembly	434-2499	1833	1743	442	380	60	22.5	1638	Stepped	5
130	Advansys	Base Edge Assembly	518-9276	1833	1743	442	380	60	22.5	1638	Stepped	5
130	K Series	Base Edge Assembly	309-7545*	1650	1650	470	380	70	22.5	1538	Stepped	4
130	K Series	Base Edge Assembly	438-7883*	1720	1720	450	450	70	22.5	1530	Straight	5
130	K Series	Base Edge Assembly	425-3891	2078	1967	380	380	70	22.5	1863	Straight	6
130	Advansys	Base Edge Assembly	573-9436	2078	1967	380	380	70	22.5	1863	Straight	6
130	K Series	Base Edge Assembly	(331-0853)	1060	1060	650	400	60	22.5	928.6	Stepped	3
130	K Series	Base Edge Assembly	291-1926*	943	943	421	421	70	22.5	802	Straight	3
130	K Series	Base Edge Assembly	423-0586	804	716	402	380	70	22.5	614	Stepped	3
130	Advansys	Base Edge Assembly	(570-5334)	804	716	402	380	70	22.5	614	Stepped	3
130	K Series	Base Edge Assembly	279-9974*	1549	1438	380	380	70	22.5	1310	Straight	5
130	K Series	Base Edge Assembly	318-4461*	2135	2024	380	380	70	22.5	1930	Straight	7
130	K Series	Base Edge Assembly	373-6825	1691	1591	453	380	70	22.5	1486	Stepped	4
130	Advansys	Base Edge Assembly	572-3053	1691	1591	453	380	70	22.5	1486	Stepped	4
130	K Series	Conversion Edge	368-3739*	1745	1634	380	380	70	22.5	770	Straight	3
130	K Series	Base Edge Assembly	256-9466*	1575	1548.8	560	450	70	22.5	1408	Stepped	4
130	K Series	Base Edge Assembly	277-8478*	1835	1835	380	380	70	22.5	1700	Straight	6
130	K Series	Base Edge Assembly	373-6888	1843	1743	380	380	70	22.5	1639	Straight	4
130	K Series	Base Edge Assembly	277-8489*	1960	1960	380	380	70	22.5	1822	Straight	6
130	K Series	Base Edge Assembly	279-9975*	1667	1556	380	380	70	22.5	1462	Straight	5
130	K Series	Base Edge Assembly	273-1422*	1550	1516	400	400	70	22.5	1383	Straight	4
130	K Series	Base Edge Assembly	423-2332	1568	1468	443	380	70	22.5	1363	Stepped	4
130	K Series	Base Edge Assembly	484-0397	1568	1468	443	380	70	22.5	1363	Stepped	4
130	Advansys	Base Edge Assembly	532-2965	1568	1468	443	380	70	22.5	1363	Stepped	4
130	K Series	Base Edge Assembly	394-5251	1556	1445	380	380	70	22.5	1310.4	Straight	5

Cat Hydraulic Excavators

BASE EDGE TABLE

Base Edge Dimensional Reference												
Adapter Size Class	Adapter Series	Edge Type	Part Number								Edge Style	Adapter Quantity Welded on Edge
				A	B	C	D	E	F	G		
130	K Series	Base Edge Assembly	279-9972*	1245	1134	380	380	70	22.5	1006	Straight	4
130	K Series	Base Edge Assembly	346-3165*	1543	1543	471	421	70	22.5	1406	Stepped	4
130	K Series	Base Edge Assembly	282-8936*	940	940	440	365	70	22.5	802	Stepped	4
130	K Series	Base Edge Assembly	321-3957*	2081	-	380	380	70	22.5	1876	Straight	6
130	K Series	Base Edge Assembly	253-9077*	1543	1543	421	421	70	22.5	1406	Straight	5
130	K Series	Base Edge Assembly	457-7613	1549	1454	380	380	70	22.5	1344	Straight	6
130	K Series	Base Edge Assembly	353-0093	1905	1802	380	380	70	22.5	1700	Straight	6
130	Advansys	Base Edge Assembly	566-9371	1905	1802	380	380	70	22.5	1700	Straight	6
130	K Series	Base Edge Assembly	279-9971*	994	883	380	380	70	22.5	784	Straight	3
130	K Series	Base Edge Assembly	460-5864	815	815	380	380	70	22.5	-	Straight	1
130	K Series	Base Edge Assembly	334-9152*	1127	1016	380	380	70	22.5	888	Straight	4
130	K Series	Base Edge Assembly	350-1915*	1127	1016	427.8	380	70	22.5	888	Stepped	3
130	K Series	Base Edge Assembly	277-5913*	1910	1810	630	380	70	22.5	1733	Stepped	6
130	K Series	Base Edge Assembly	279-9973*	1397	1286	380	380	70	22.5	1192	Straight	4
130	Advansys	Base Edge Assembly	566-1849	1397	1286	380	380	70	22.5	1192	Straight	4
130	K Series	Base Edge Assembly	338-7682	1825	1714	380	380	70	22.5	1620	Straight	6
130	K Series	Base Edge Assembly	353-0080*	1436	1325	380	380	70	22.5	1221.8	Straight	5
130	K Series	Base Edge Assembly	320-1413*	1345.2	1234.2	380	380	70	22.5	1124.2	Straight	5
130	K Series	Base Edge Assembly	(373-6873)	901	806	380	380	70	22.5	696	Straight	3
130	K Series	Base Edge Assembly	277-4814*	1618	1518	545	380	70	22.5	1441	Stepped	4
130	K Series	Base Edge Assembly	(328-3126)	2008	1897	380	380	70	22.5	1776.6	Straight	5
130	K Series	Base Edge Assembly	297-6066*	1583	1472	380	380	70	22.5	1344	Straight	5
130	K Series	Conversion Edge	368-3678*	1999	1888	380	380	70	22.5	-	Straight	4
130	Advansys	Conversion Edge	566-9350	1999	1888	380	380	70	22.5	-	Straight	4
130	K Series	Base Edge Assembly	293-4349*	1800	1766	400	400	70	22.5	1633	Straight	5
130	K Series	Base Edge Assembly	324-8282*	2031	1920	380	380	70	22.5	1826	Straight	6
130	K Series	Base Edge Assembly	323-6420*	1396	1285	380	380	70	22.5	1184.8	Straight	5
130	K Series	Base Edge Assembly	532-6695	1396	1285	380	380	70	22.5	1184.8	Straight	5
130	Advansys	Base Edge Assembly	(576-7437)	1396	1285	380	380	70	22.5	1184.8	Straight	5
130	K Series	Base Edge Assembly	(368-3708)	2005	1894	380	380	70	22.5	1800	Straight	6
130	K Series	Base Edge Assembly	357-8234*	1338	1338	380	380	70	22.5	1092.6	Straight	4
130	K Series	Base Edge Assembly	265-3398	1618	1518	545	380	70	22.5	1441	Stepped	4
130	Advansys	Base Edge Assembly	550-4394	1618	1518	545	380	70	22.5	1441	Stepped	4
130	K Series	Base Edge Assembly	(368-3695)	1929	1818	380	380	70	22.5	1724	Straight	6
130	K Series	Base Edge Assembly	273-0962*	1837	1837	380	380	70	22.5	1700	Straight	6
130	K Series	Base Edge Assembly	279-9976	1963	1852	380	380	70	22.5	1758	Straight	6
130	Advansys	Base Edge Assembly	550-4393	1963	1852	380	380	70	22.5	1758	Straight	6
130	K Series	Base Edge Assembly	357-8172*	1772	1661	380	380	70	22.5	1557.8	Straight	6
130	K Series	Base Edge Assembly	328-3166*	1804	1804	380	380	70	22.5	1558.6	Straight	6
130	K Series	Base Edge Assembly	456-4667	1701	1701	380	380	70	22.5	1496	Straight	5
130	Advansys	Base Edge Assembly	553-0056	1701	1701	380	380	70	22.5	1496	Straight	5
130	K Series	Base Edge Assembly	312-0418*	1821	1710	380	380	70	22.5	1616	Straight	6
130	K Series	Base Edge Assembly	273-1431*	1550	1516	510	400	70	22.5	1383	Stepped	4
130	K Series	Base Edge Assembly	361-2313*	1905	1802	380	380	70	22.5	1700	Straight	5
130	K Series	Base Edge Assembly	425-3865	1963	1863	453.3	380	70	22.5	1758	Stepped	6
130	Advansys	Base Edge Assembly	573-9435	1963	1863	453.3	380	70	22.5	1758	Stepped	6
130	K Series	Base Edge Assembly	433-8116	1250	1150	417	380	70	22.5	1040	Stepped	4
130	Advansys	Base Edge Assembly	(573-9437)	1250	1150	417	380	70	22.5	1040	Stepped	4
130	K Series	Base Edge Assembly	420-3384	1943	1848	380	380	70	22.5	1738	Straight	4
130	Advansys	Base Edge Assembly	568-8866	1943	1848	380	380	70	22.5	1738	Straight	4
130	K Series	Base Edge Assembly	311-0130*	1369	1258	380	380	70	22.5	1164	Straight	4
130	K Series	Base Edge Assembly	437-1844	2135	2040	380	380	70	22.5	1930	Straight	6
130	Advansys	Base Edge Assembly	573-9439	2135	2040	380	380	70	22.5	1930	Straight	6
130	K Series	Base Edge Assembly	452-5058	1170	1070	580	380	70	22.5	965	Stepped	3
130	Advansys	Base Edge Assembly	528-9655	1855	1760	380	380	70	22.5	1650	Straight	5
130	Advansys	Base Edge Assembly	538-9149	1930	1910	504	421	70	22.5	1738	Stepped	4
130	Advansys	Base Edge Assembly	540-3532	1255	1255	380	380	70	22.5	-	Straight	2
130	Advansys	Base Edge Assembly	540-3534	1550	1550	380	380	70	22.5	-	Straight	3
130	Advansys	Base Edge Assembly	540-3536	1400	1400	380	380	70	22.5	-	Straight	3
130	Advansys	Base Edge Assembly	541-8811	1255	1255	450	450	70	22.5	-	Straight	2
130	Advansys	Base Edge Assembly	543-4779	1255	1255	450	450	70	22.5	-	Straight	2
130	Advansys	Base Edge Assembly	545-8954	1610	1610	400	330	70	22.5	-	Stepped	4
130	K Series	Base Edge Assembly	(541-1913)	2078	1978	463.9	380	70	22.5	1863	Stepped	6
130	K Series	Base Edge Assembly	532-8231	2063	1963	450	380	70	22.5	1838	Stepped	5
130	K Series	Base Edge Assembly	361-2302*	1905	1802	380	380	70	22.5	1700	Straight	5
130	Advansys	Base Edge Assembly	553-5217	1778	1778	380	380	70	22.5	1778	Straight	3
130	Advansys	Conversion Edge	556-7888	1701	1701	380	380	70	22.5	1701	Straight	3
130	Advansys	Base Edge Assembly	561-2665	2009	1914	380	380	70	22.5	1804	Straight	6
130	Advansys	Base Edge Assembly	563-2903	1825	1730	380	380	70	22.5	1620	Straight	5
130	Advansys	Base Edge Assembly	566-1813	1306	1238	421	421	70	22.5	1101	Straight	4
130	Advansys	Base Edge Assembly	566-1847	1850	1816	400	400	70	22.5	1583	Straight	4

Discontinued
Canceled
(Reference)

Part is discontinued. Please contact your service representative.
Part is canceled. Please contact your customer service representative.
Part number is not serviceable. For reference only.

Base Edge Dimensional Reference

Adapter Size Class	Adapter Series	Edge Type	Part Number								Edge Style	Adapter Quantity Welded on Edge
				A	B	C	D	E	F	G		
130	Advansys	Base Edge Assembly	568-0431	1745	1650	480	480	70	22.5	1496	Straight	5
130	Advansys	Base Edge Assembly	568-6996	1443	1443	421	421	70	22.5	1254	Straight	4
130	Advansys	Base Edge Assembly	568-6998	1593	1593	421	421	70	22.5	1406	Straight	5
130	Advansys	Base Edge Assembly	568-0429	1517	1422	380	380	70	22.5	1312	Straight	4
130	Advansys	Base Edge Assembly	568-0430	1745	1650	380	380	70	22.5	1542	Straight	4
130	Advansys	Base Edge Assembly	570-5305	1609	1514	380	380	70	22.5	1406	Straight	5
130	Advansys	Base Edge Assembly	570-5356	1569	1474	480	480	70	22.5	1320	Straight	5
130	Advansys	Base Edge Assembly	570-5357	1681	1586	480	480	70	22.5	1432	Straight	5
130	Advansys	Base Edge Assembly	568-0404	1517	1422	480	480	70	22.5	1272	Straight	4
150	K Series	Base Edge Assembly	(507-8220)	1321	1311	421	421	80	22.5	1145	Straight	4
150	K Series	Base Edge Assembly	509-7869	2235	2125	421	421	80	22.5	1806	Straight	5
150	K Series	Base Edge Assembly	485-8387?	1930	1920	421	421	80	22.5	1750	Straight	5
150	K Series	Base Edge Assembly	485-8387	1930	1920	421	421	80	22.5	1750	Straight	5
150	Advansys	Base Edge Assembly	519-5372	1930	1920	421	421	80	22.5	1750	Straight	5
150	K Series	Base Edge Assembly	264-2027	1753	1753	500	500	80	22.5	760	Straight	3
150	Advansys	Base Edge Assembly	547-5088	1753	1753	500	500	80	22.5	760	Straight	3
150	K Series	Base Edge Assembly	485-8390?	1705	1695	421	421	80	22.5	1525	Straight	4
150	K Series	Base Edge Assembly	485-8390	1705	1695	421	421	80	22.5	1525	Straight	4
150	Advansys	Base Edge Assembly	519-5376	1705	1695	421	421	80	22.5	1525	Straight	4
150	K Series	Base Edge Assembly	485-8388?	1120	1110	421	421	80	22.5	940	Straight	3
150	K Series	Base Edge Assembly	485-8388	1120	1110	421	421	80	22.5	940	Straight	3
150	Advansys	Base Edge Assembly	519-5383	1120	1110	421	421	80	22.5	940	Straight	3
150	K Series	Base Edge Assembly	485-8392?	2020	2010	421	421	80	22.5	1840	Straight	5
150	K Series	Base Edge Assembly	485-8392	2020	2010	421	421	80	22.5	1840	Straight	5
150	Advansys	Base Edge Assembly	519-5373	2020	2010	421	421	80	22.5	1840	Straight	5
150	K Series	Base Edge Assembly	264-2031	2087	2087	500	500	80	22.5	1110	Straight	4
150	Advansys	Base Edge Assembly	547-5087	2087	2087	500	500	80	22.5	1110	Straight	4
150	K Series	Base Edge Assembly	485-8386?	1930	1920	421	421	80	22.5	1750	Straight	4
150	K Series	Base Edge Assembly	485-8386	1930	1920	421	421	80	22.5	1750	Straight	4
150	Advansys	Base Edge Assembly	519-5381	1930	1920	421	421	80	22.5	1750	Straight	4
150	K Series	Base Edge Assembly	264-2035	2050	2050	548	448	80	22.5	604	Stepped	2
150	Advansys	Base Edge Assembly	550-4396	2050	2050	548	448	80	22.5	604	Stepped	2
150	K Series	Base Edge Assembly	485-8664?	2220	2210	421	421	80	22.5	2040	Straight	6
150	K Series	Base Edge Assembly	485-8664	2220	2210	421	421	80	22.5	2040	Straight	6
150	Advansys	Base Edge Assembly	572-3052	2220	2210	421	421	80	22.5	2040	Straight	6
150	K Series	Base Edge Assembly	485-8391?	2020	2010	421	421	80	22.5	1840	Straight	4
150	K Series	Base Edge Assembly	485-8391	2020	2010	421	421	80	22.5	1840	Straight	4
150	Advansys	Base Edge Assembly	519-5385	2020	2010	421	421	80	22.5	1840	Straight	4
150	K Series	Base Edge Assembly	264-2043	2220	2220	491.4	407.4	80	22.5	-	Stepped	4
150	Advansys	Base Edge Assembly	568-8837	2220	2220	491.4	407.4	80	22.5	-	Stepped	4
150	K Series	Base Edge Assembly	485-8663?	1392	1382	421	421	80	22.5	1212	Straight	3
150	K Series	Base Edge Assembly	485-8663	1392	1382	421	421	80	22.5	1212	Straight	3
150	Advansys	Base Edge Assembly	519-5384	1392	1382	421	421	80	22.5	1212	Straight	3
150	K Series	Base Edge Assembly	264-2033	2413	2413	500	500	80	22.5	-	Straight	5
150	Advansys	Base Edge Assembly	566-9364	2413	2413	500	500	80	22.5	-	Straight	5
150	K Series	Base Edge Assembly	264-2041	2450	2450	560	476	80	22.5	1100	Stepped	3
150	Advansys	Base Edge Assembly	550-4401	2450	2450	560	476	80	22.5	1100	Stepped	3
150	K Series	Base Edge Assembly	(486-9226)	1930	1910	469	421	80	22.5	1750	Stepped	5
150	K Series	Base Edge Assembly	485-8385?	1545	1535	421	421	80	22.5	1365	Straight	4
150	K Series	Base Edge Assembly	485-8385	1545	1535	421	421	80	22.5	1365	Straight	4
150	Advansys	Base Edge Assembly	519-5375	1545	1535	421	421	80	22.5	1365	Straight	4
150	K Series	Base Edge Assembly	485-8389?	1240	1230	421	421	80	22.5	1060	Straight	3
150	K Series	Base Edge Assembly	485-8389	1240	1230	421	421	80	22.5	1060	Straight	3
150	Advansys	Base Edge Assembly	519-5374	1240	1230	421	421	80	22.5	1060	Straight	3
150	K Series	Base Edge Assembly	264-2045*	2515	2515	492.3	387.3	80	22.5	-	Stepped	4
150	Advansys	Base Edge Assembly	568-8838	2515	2515	492.3	387.3	80	22.5	-	Stepped	4
150	K Series	Base Edge Assembly	485-8383?	2120	2110	421	421	80	22.5	1940	Straight	4
150	K Series	Base Edge Assembly	485-8383	2120	2110	421	421	80	22.5	1940	Straight	4
150	Advansys	Base Edge Assembly	519-5382	2120	2110	421	421	80	22.5	1940	Straight	4
150	K Series	Base Edge Assembly	(486-9868)	1240	1230	421	421	80	22.5	1060	Straight	4
150	K Series	Base Edge Assembly	485-8448?	1392	1382	421	421	80	22.5	1212	Straight	4
150	K Series	Base Edge Assembly	485-8448	1392	1382	421	421	80	22.5	1212	Straight	4
150	Advansys	Base Edge Assembly	519-5379	1392	1382	421	421	80	22.5	1212	Straight	4
150	K Series	Base Edge Assembly	485-8384?	2270	2260	421	421	80	22.5	2090	Straight	5
150	K Series	Base Edge Assembly	485-8384	2270	2260	421	421	80	22.5	2090	Straight	5
150	Advansys	Base Edge Assembly	543-2774	2270	2260	421	421	80	22.5	2090	Straight	5
150	K Series	Base Edge Assembly	318-9416*	2354.6	2302.2	450	450	80	22.5	2154.4	Straight	6
150	K Series	Base Edge Assembly	(495-9663)	2354.6	2302.2	450	450	80	22.5	2154.4	Straight	6
150	K Series	Base Edge Assembly	505-4734	1705	1681	486	421	80	22.5	1525	Stepped	4
150	K Series	Base Edge Assembly	264-2039*	2250	2250	591	450	80	22.5	-	Stepped	3

Cat Hydraulic Excavators

BASE EDGE TABLE

Base Edge Dimensional Reference												
Adapter Size Class	Adapter Series	Edge Type	Part Number								Edge Style	Adapter Quantity Welded on Edge
				A	B	C	D	E	F	G		
150	Advansys	Base Edge Assembly	(553-5218)	2250	2250	591	450	80	22.5	-	Stepped	3
150	K Series	Base Edge Assembly	485-8393	1930	1920	421	421	80	22.5	1750	Straight	4
150	K Series	Base Edge Assembly	485-8393	1930	1920	421	421	80	22.5	1750	Straight	4
150	Advansys	Base Edge Assembly	519-5377	1930	1920	421	421	80	22.5	1750	Straight	4
150	K Series	Base Edge Assembly	437-1790	1805	1795	421	421	80	22.5	1625	Straight	4
150	Advansys	Base Edge Assembly	519-5380	1805	1795	421	421	80	22.5	1625	Straight	4
150	K Series	Base Edge Assembly	340-6403*	2250	2140	421	421	80	22.5	2008	Straight	5
150	K Series	Base Edge Assembly	302-0537*	1850	1816	487.2	400	80	22.5	1620	Stepped	4
150	K Series	Base Edge Assembly	437-1784	1595	1585	421	421	80	22.5	1415	Straight	4
150	Advansys	Base Edge Assembly	553-5224	1595	1585	421	421	80	22.5	1415	Straight	4
150	K Series	Base Edge Assembly	293-6381	1372	1262	421	421	80	22.5	1130	Straight	4
150	Advansys	Base Edge Assembly	569-4911	1372	1262	421	421	80	22.5	1130	Straight	4
150	K Series	Base Edge Assembly	312-0425*	1638	1585.6	450	450	80	22.5	1436	Straight	4
150	K Series	Base Edge Assembly	442-8444	1930	1910	508	421	80	22.5	1750	Stepped	4
150	Advansys	Base Edge Assembly	573-9441	1930	1910	508	421	80	22.5	1750	Stepped	4
150	K Series	Base Edge Assembly	297-6155*	1524	1464	421	421	80	22.5	1282	Straight	4
150	K Series	Base Edge Assembly	340-6407*	1900	1790	537	450	80	22.5	1658	Stepped	4
150	K Series	Base Edge Assembly	(492-3755)	1900	1790	537	450	80	22.5	1658	Stepped	4
150	Advansys	Base Edge Assembly	(569-5964)	1900	1790	537	450	80	22.5	1658	Stepped	4
150	K Series	Base Edge Assembly	270-8240	1350	1324	450	450	80	22.5	1168	Straight	3
150	Advansys	Base Edge Assembly	(566-9351)	1350	1324	450	450	80	22.5	1168	Straight	3
150	K Series	Base Edge Assembly	323-6140*	1980	1870	421	421	80	22.5	1738	Straight	5
150	K Series	Base Edge Assembly	260-1158	2000	2000	600	450	80	22.5	1818	Stepped	4
150	Advansys	Base Edge Assembly	550-8869	2000	2000	600	450	80	22.5	1818	Stepped	4
150	K Series	Base Edge Assembly	340-6401*	2100	1990	421	421	80	22.5	1858	Straight	5
150	K Series	Base Edge Assembly	301-7694*	2450	2424	450	450	80	22.5	2268	Straight	5
150	K Series	Base Edge Assembly	264-2029*	2430	2430	500	500	80	22.5	1096	Straight	3
150	K Series	Base Edge Assembly	346-3113*	1931	1821	421	421	80	22.5	1689	Straight	4
150	Advansys	Base Edge Assembly	566-9367	1931	1821	421	421	80	22.5	1689	Straight	4
150	K Series	Base Edge Assembly	260-1245	2200	2174	450	450	80	22.5	2018	Straight	4
150	Advansys	Base Edge Assembly	553-5222	2200	2174	450	450	80	22.5	2018	Straight	4
150	K Series	Base Edge Assembly	304-3609*	2078.4	1968	450	450	80	22.5	1820	Straight	4
150	Advansys	Base Edge Assembly	569-5966	2078.4	1968	450	450	80	22.5	1820	Straight	4
150	K Series	Base Edge Assembly	308-6215*	2132	2132	574	470	80	22.5	1950.6	Stepped	5
150	K Series	Conversion Edge	466-3070	2442	2332	421	421	80	22.5	1320	Straight	4
150	K Series	Base Edge Assembly	328-3172*	2442	2332	421	421	80	22.5	2200	Straight	6
150	K Series	Base Edge Assembly	270-8241*	1750	1724	450	450	80	22.5	1568	Straight	4
150	Advansys	Base Edge Assembly	568-8842	1750	1724	450	450	80	22.5	1568	Straight	4
150	K Series	Base Edge Assembly	260-1247	1800	1800	600	450	80	22.5	1618	Stepped	4
150	Advansys	Base Edge Assembly	566-9378	1800	1800	600	450	80	22.5	1618	Stepped	4
150	K Series	Base Edge Assembly	452-5058	1170	1070	580	200	80	22.5	965	Stepped	3
150	K Series	Base Edge Assembly	260-1242	2300	2274	450	450	80	22.5	2118	Straight	5
150	Advansys	Base Edge Assembly	550-4403	2300	2274	450	450	80	22.5	2118	Straight	5
150	K Series	Conversion Edge	361-2315*	2300	2274	450	450	80	22.5	2118	Straight	5
150	K Series	Base Edge Assembly	319-6456*	1750	1716	510	400	80	22.5	1535	Stepped	4
150	K Series	Base Edge Assembly	346-3116*	2000	1890	421	421	80	22.5	1758	Straight	4
150	Advansys	Base Edge Assembly	568-8867	2000	1890	421	421	80	22.5	1758	Straight	4
150	K Series	Base Edge Assembly	322-7626*	2235	2125	421	421	80	22.5	1993	Straight	5
150	K Series	Base Edge Assembly	(359-3052)	1931	1821	421	421	80	22.5	1689	Straight	4
150	K Series	Base Edge Assembly	289-0766*	1942	1942	421	421	80	22.5	1801	Straight	5
150	K Series	Base Edge Assembly	293-6380*	1067	957	421	421	80	22.5	825	Straight	3
150	K Series	Base Edge Assembly	340-6394*	1000	890	421	421	80	22.5	758	Straight	3
150	K Series	Base Edge Assembly	440-3721	1800	1750	537	450	80	22.5	1638	Stepped	4
150	K Series	Base Edge Assembly	260-1253*	2100	2100	560	450	80	22.5	1918	Stepped	4
150	Advansys	Base Edge Assembly	550-8866	2100	2100	560	450	80	22.5	1918	Stepped	4
150	K Series	Base Edge Assembly	317-9480*	2000	200	540	450	80	22.5	1818	Stepped	4
150	K Series	Base Edge Assembly	276-6147*	1942	1942	421	421	80	22.5	1801	Straight	5
150	K Series	Base Edge Assembly	333-8857*	1900	1900	560	450	80	22.5	1718	Stepped	4
150	K Series	Base Edge Assembly	283-5598*	1335	1335	421	421	80	22.5	1193.9	Straight	4
150	K Series	Base Edge Assembly	264-2037*	2430	2430	550	450	80	22.5	604	Stepped	2
150	K Series	Base Edge Assembly	297-5952*	2442	2332	421	421	80	22.5	2200	Straight	6
150	K Series	Conversion Edge	466-3070	2442	2332	421	421	80	22.5	2200	Straight	6
150	K Series	Base Edge Assembly	293-6383	1981	1871	421	421	80	22.5	1739	Straight	5
150	Advansys	Base Edge Assembly	540-4030	1981	1871	421	421	80	22.5	1739	Straight	5
150	K Series	Base Edge Assembly	270-8239*	1150	1124	450	450	80	22.5	968	Straight	3
150	Advansys	Base Edge Assembly	568-8841	1150	1124	450	450	80	22.5	968	Straight	3
150	K Series	Base Edge Assembly	329-1977*	2250	2140	560	450	80	22.5	2008	Stepped	4
150	K Series	Base Edge Assembly	340-6406*	1800	1690	528	450	80	22.5	1558	Stepped	4
150	K Series	Base Edge Assembly	331-4276*	2100	1990	421	421	80	22.5	1858	Straight	4
150	K Series	Base Edge Assembly	286-5256*	1335	1335	421	421	80	22.5	1193.9	Straight	5
150	K Series	Base Edge Assembly	(479-1629)	2020	2000	508	421	80	22.5	1840	βStepped	4

Discontinued
Canceled
(Reference)

Part is discontinued. Please contact your service representative.
Part is canceled. Please contact your customer service representative.
Part number is not serviceable. For reference only.

Base Edge Dimensional Reference

Adapter Size Class	Adapter Series	Edge Type	Part Number								Edge Style	Adapter Quantity Welded on Edge
				A	B	C	D	E	F	G		
150	K Series	Base Edge Assembly	340-6397*	1680	1570	421	421	80	22.5	1438	Straight	4
150	K Series	Base Edge Assembly	(416-6431)	1705	1695	421	421	80	22.5	1525	Straight	5
150	K Series	Conversion Edge	361-2315*	2300	2274	450	450	80	22.5	-	Straight	3
150	Advansys	Conversion Edge	568-8844	2300	2274	450	450	80	22.5	-	Straight	3
150	K Series	Base Edge Assembly	340-6398*	1980	1870	421	421	80	22.5	1738	Straight	4
150	K Series	Base Edge Assembly	260-1243	1900	1874	450	450	80	22.5	1718	Straight	4
150	Advansys	Base Edge Assembly	550-4400	1900	1874	450	450	80	22.5	1718	Straight	4
150	K Series	Base Edge Assembly	340-6396*	1525	1415	421	421	80	22.5	1284	Straight	4
150	K Series	Base Edge Assembly	260-1244	2000	1948	450	450	80	22.5	1818	Straight	4
150	Advansys	Base Edge Assembly	566-9376	2000	1948	450	450	80	22.5	1818	Straight	4
150	K Series	Base Edge Assembly	311-7864*	2010	1890	548	448	80	22.5	1774	Stepped	4
150	K Series	Base Edge Assembly	293-7253*	1550	1516	510	400	80	22.5	1378	Stepped	4
150	K Series	Base Edge Assembly	340-6395*	1220	1110	421	421	80	22.5	978	Straight	3
150	K Series	Base Edge Assembly	294-4355*	2310	2310	610.1	417.2	80	22.5	2090	Stepped	6
150	K Series	Base Edge Assembly	388-7673	1280.2	1222.2	421	421	80	22.5	1070	Straight	4
150	Advansys	Base Edge Assembly	553-5226	1280.2	1222.2	421	421	80	22.5	1070	Straight	4
150	K Series	Base Edge Assembly	238-3179*	2625	2625	600	450	80	22.5	2396	Stepped	5
150	K Series	Base Edge Assembly	329-1974*	1900	1790	537	450	80	22.5	1658	Stepped	4
150	K Series	Base Edge Assembly	276-5961*	941	941	421	421	80	22.5	660.8	Straight	3
150	K Series	Base Edge Assembly	437-1820	1755	1745	421	421	80	22.5	1575	Straight	4
150	Advansys	Base Edge Assembly	(572-9990)	1755	1745	421	421	80	22.5	1575	Straight	4
150	K Series	Base Edge Assembly	(334-3402)	2000	1890	543	450	80	22.5	1758	Stepped	4
150	K Series	Base Edge Assembly	302-9049*	2100	1990	553	450	80	22.5	1858	Stepped	4
150	K Series	Base Edge Assembly	260-1246*	1700	1700	600	450	80	22.5	1518	Stepped	4
150	Advansys	Base Edge Assembly	566-9377	1700	1700	600	450	80	22.5	1518	Stepped	4
150	K Series	Base Edge Assembly	260-1252	2000	2000	560	450	80	22.5	1820	Stepped	4
150	Advansys	Base Edge Assembly	566-9380	2000	2000	560	450	80	22.5	1820	Stepped	4
150	K Series	Base Edge Assembly	340-6408*	2250	2140	560	450	80	22.5	2008	Stepped	4
150	K Series	Base Edge Assembly	274-1384*	1639	1639	424	424	80	22.5	1498	Straight	5
150	K Series	Base Edge Assembly	390-6060	1880	1770	421	421	80	22.5	1638	Straight	5
150	K Series	Base Edge Assembly	329-1975*	2000	1890	543	450	80	22.5	1758	Stepped	4
150	Advansys	Base Edge Assembly	568-8835	2000	1890	543	450	80	22.5	1758	Stepped	4
150	K Series	Base Edge Assembly	470-7875	1880	1750	537	450	80	22.5	1638	Stepped	4
150	Advansys	Base Edge Assembly	532-2966	1880	1750	537	450	80	22.5	1638	Stepped	4
150	K Series	Base Edge Assembly	300-9757*	1300	1274	450	450	80	22.5	1118	Straight	3
150	K Series	Base Edge Assembly	329-1976*	2100	1990	553	450	80	22.5	1858	Stepped	4
150	K Series	Base Edge Assembly	284-3396*	2200	2200	560	560	80	22.5	2018	Stepped	4
150	K Series	Base Edge Assembly	300-5043*	1180	1154	450	450	80	22.5	998	Straight	3
150	K Series	Base Edge Assembly	260-1250	2200	2200	600	450	80	22.5	2018	Stepped	4
150	Advansys	Base Edge Assembly	550-8870	2200	2200	600	450	80	22.5	2018	Stepped	4
150	K Series	Base Edge Assembly	293-6382	1677	1567	421	421	80	22.5	1435	Straight	4
150	Advansys	Base Edge Assembly	553-5215	1677	1567	421	421	80	22.5	1435	Straight	4
150	K Series	Base Edge Assembly	359-2979*	1829	1719	421	421	80	22.5	1587	Straight	4
150	K Series	Base Edge Assembly	260-1248	1900	1900	600	450	80	22.5	1718	Stepped	4
150	Advansys	Base Edge Assembly	553-5223	1900	1900	600	450	80	22.5	1718	Stepped	4
150	K Series	Base Edge Assembly	260-1251	1900	1900	560	450	80	22.5	1718	Stepped	4
150	Advansys	Base Edge Assembly	553-5220	1900	1900	560	450	80	22.5	1718	Stepped	4
150	K Series	Base Edge Assembly	313-5702*	964	854	421	421	80	22.5	722	Straight	3
150	K Series	Base Edge Assembly	(369-4452)	1210	1190	450	450	80	22.5	1000	Straight	3
150	K Series	Base Edge Assembly	284-4894*	1895	1805	380	380	80	22.5	1880.2	Straight	6
150	K Series	Base Edge Assembly	260-1249*	2100	2100	600	450	80	22.5	1918	Stepped	4
150	Advansys	Base Edge Assembly	566-9379	2100	2100	600	450	80	22.5	1918	Stepped	4
150	K Series	Base Edge Assembly	322-6075*	2015	1905	421	421	80	22.5	1773	Straight	5
150	K Series	Base Edge Assembly	260-1241	2100	2074	450	450	80	22.5	1920	Straight	4
150	Advansys	Base Edge Assembly	532-2967	2100	2074	450	450	80	22.5	1920	Straight	4
150	Advansys	Base Edge Assembly	519-5386	1949	1855	400	400	80	22.5	1731	Straight	5
150	Advansys	Base Edge Assembly	527-5502	1669	1575	400	400	80	22.5	1450	Straight	4
150	Advansys	Base Edge Assembly	538-9157	1930	1930	504	421	80	22.5	1738	Stepped	4
150	Advansys	Base Edge Assembly	541-8813	1905	1905	550	550	80	22.5	862.6	Straight	3
150	Advansys	Base Edge Assembly	543-4780	1905	1905	550	550	80	22.5	862.6	Straight	3
150	K Series	Base Edge Assembly	527-7113	1120	1110	421	421	80	22.5	940	Straight	3
150	Advansys	Base Edge Assembly	558-7886	1120	1110	421	421	80	22.5	940	Straight	3
150	K Series	Base Edge Assembly	524-8774	1847	1837	421	421	80	22.5	1668	Straight	4
150	K Series	Base Edge Assembly	308-6215*	2132	2132	620	470	80	22.5	1950.6	Stepped	5
150	K Series	Base Edge Assembly	338-7675*	2100	1990	421	421	80	22.5	1858.2	Straight	5
150	Advansys	Base Edge Assembly	553-0049	1640	1546	380	380	80	22.5	1412	Straight	4
150	Advansys	Base Edge Assembly	(565-6321)	2156	2146	421	421	80	22.5	1966	Straight	6
150	Advansys	Base Edge Assembly	569-4908	1956	1892	400	400	80	22.5	1870.2	Straight	6
150	Advansys	Base Edge Assembly	(573-9440)	1880	1750	537	450	80	22.5	1638	Stepped	4
170	K Series	Base Edge Assembly	506-0478	2200	2186	562	500	90	35	2006	Stepped	6

Cat Hydraulic Excavators

BASE EDGE TABLE

Base Edge Dimensional Reference												
Adapter Size Class	Adapter Series	Edge Type	Part Number								Edge Style	Adapter Quantity Welded on Edge
				A	B	C	D	E	F	G		
170	K Series	Base Edge Assembly	479-0494	2300	2286	610	500	90	35	2106	Stepped	4
170	K Series	Base Edge Assembly	264-2047	2450	2450	560	475	90	35	1100	Stepped	3
170	Advansys	Base Edge Assembly	550-8865	2450	2450	560	475	90	35	1100	Stepped	3
170	K Series	Base Edge Assembly	360-6142	2575	2551	500	500	90	35	2381	Straight	6
170	K Series	Base Edge Assembly	491-6798	2575	2551	500	500	90	35	2381	Straight	6
170	Advansys	Base Edge Assembly	532-2970	2575	2551	500	500	90	35	2381	Straight	6
170	K Series	Base Edge Assembly	491-6787	2000	1986	584	500	90	35	1806	Stepped	4
170	K Series	Base Edge Assembly	491-6787	2000	1986	584	500	90	35	1806	Stepped	4
170	Advansys	Base Edge Assembly	519-5453	2000	1986	584	500	90	35	1806	Stepped	4
170	K Series	Base Edge Assembly	491-6792	1900	1886	576	500	90	35	1706	Stepped	4
170	K Series	Base Edge Assembly	491-6792	1900	1886	576	500	90	35	1706	Stepped	4
170	Advansys	Base Edge Assembly	519-5445	1900	1886	576	500	90	35	1706	Stepped	4
170	K Series	Base Edge Assembly	264-2209*	2114.8	1942	500	500	90	35	1837	Straight	5
170	K Series	Base Edge Assembly	358-6834*	2044	1998	722	500	90	35	1780	Stepped	5
170	Advansys	Base Edge Assembly	568-8870	2044	1998	722	500	90	35	1780	Stepped	5
170	K Series	Base Edge Assembly	491-6795	2200	2186	602.2	500	90	35	2006	Stepped	4
170	K Series	Base Edge Assembly	491-6795	2200	2186	602.2	500	90	35	2006	Stepped	4
170	Advansys	Base Edge Assembly	519-5451	2200	2186	602.2	500	90	35	2006	Stepped	4
170	K Series	Base Edge Assembly	491-6786	2420	2396	500	500	90	35	2226	Straight	6
170	K Series	Base Edge Assembly	491-6786	2420	2396	500	500	90	35	2226	Straight	6
170	Advansys	Base Edge Assembly	519-5448	2420	2396	500	500	90	35	2226	Straight	6
170	K Series	Base Edge Assembly	264-2049	2450	2450	530.4	450	90	35	-	Stepped	3
170	Advansys	Base Edge Assembly	523-9782	2450	2450	530.4	450	90	35	-	Stepped	3
170	K Series	Base Edge Assembly	264-2051*	2360	2360	573	482.6	90	35	-	Stepped	4
170	Advansys	Base Edge Assembly	568-8109	2360	2360	573	482.6	90	35	-	Stepped	4
170	K Series	Base Edge Assembly	491-6799	2000	1976	500	500	90	35	1806	Straight	4
170	K Series	Base Edge Assembly	491-6799	2000	1976	500	500	90	35	1806	Straight	4
170	Advansys	Base Edge Assembly	550-4402	2000	1976	500	500	90	35	1806	Straight	4
170	K Series	Base Edge Assembly	491-6791	1800	1786	565.8	500	90	35	1606	Stepped	4
170	K Series	Base Edge Assembly	491-6791	1800	1786	565.8	500	90	35	1606	Stepped	4
170	Advansys	Base Edge Assembly	568-8869	1800	1786	565.8	500	90	35	1606	Stepped	4
170	K Series	Base Edge Assembly	491-6785	2300	2276	500	500	90	35	2106	Straight	6
170	K Series	Base Edge Assembly	491-6785	2300	2276	500	500	90	35	2106	Straight	6
170	Advansys	Base Edge Assembly	519-5447	2300	2276	500	500	90	35	2106	Straight	6
170	K Series	Base Edge Assembly	264-2121*	2750	2750	585	585	90	35	-	Straight	4
170	Advansys	Base Edge Assembly	568-8108	2750	2750	585	585	90	35	-	Straight	4
170	K Series	Base Edge Assembly	491-6789	2100	2086	593	500	90	35	1906	Stepped	4
170	K Series	Base Edge Assembly	491-6789	2100	2086	593	500	90	35	1906	Stepped	4
170	Advansys	Base Edge Assembly	519-5454	2100	2086	593	500	90	35	1906	Stepped	4
170	K Series	Base Edge Assembly	491-6794	2100	2086	593	500	90	35	1906	Stepped	4
170	K Series	Base Edge Assembly	491-6794	2100	2086	593	500	90	35	1906	Stepped	4
170	Advansys	Base Edge Assembly	519-5449	2100	2086	593	500	90	35	1906	Stepped	4
170	K Series	Base Edge Assembly	491-6793	2000	1986	584	500	90	35	1806	Stepped	4
170	K Series	Base Edge Assembly	491-6793	2000	1986	584	500	90	35	1806	Stepped	4
170	Advansys	Base Edge Assembly	519-5446	2000	1986	584	500	90	35	1806	Stepped	4
170	K Series	Base Edge Assembly	319-5387	2400	2400	700	575	90	35	2110	Stepped	4
170	Advansys	Base Edge Assembly	568-8847	2400	2400	700	575	90	35	2110	Stepped	4
170	K Series	Base Edge Assembly	491-6788	1900	1886	576	500	90	35	1706	Stepped	4
170	K Series	Base Edge Assembly	491-6788	1900	1886	576	500	90	35	1706	Stepped	4
170	K Series	Base Edge Assembly	491-6797	2090	2066	500	500	90	35	1896	Straight	5
170	K Series	Base Edge Assembly	491-6797	2090	2066	500	500	90	35	1896	Straight	5
170	Advansys	Base Edge Assembly	519-5456	2090	2066	500	500	90	35	1896	Straight	5
170	K Series	Base Edge Assembly	360-6120	1750	1726	500	500	90	35	1556	Straight	4
170	K Series	Base Edge Assembly	491-6796	1750	1726	500	500	90	35	1556	Straight	4
170	Advansys	Base Edge Assembly	532-2969	1750	1726	500	500	90	35	1556	Straight	4
170	K Series	Base Edge Assembly	491-6790	2200	2186	602.2	500	90	35	2006	Stepped	4
170	K Series	Base Edge Assembly	491-6790	2200	2186	602.2	500	90	35	2006	Stepped	4
170	Advansys	Base Edge Assembly	519-5455	2200	2186	602.2	500	90	35	2006	Stepped	4
170	K Series	Base Edge Assembly	341-9050*	2350	2240	571.6	500	90	35	2110	Stepped	5
170	K Series	Base Edge Assembly	293-6388	2310	2200	500	500	90	35	2070	Straight	6
170	Advansys	Base Edge Assembly	566-9365	2310	2200	500	500	90	35	2070	Straight	6
170	K Series	Base Edge Assembly	(415-5214)	1526	1416	500	500	90	35	1286	Straight	4
170	K Series	Base Edge Assembly	420-3382	2106.5	1996	597.5	500	90	35	1866	Stepped	4
170	Advansys	Base Edge Assembly	568-6617	2106.5	1996	597.5	500	90	35	1866	Stepped	4
170	K Series	Base Edge Assembly	328-3136*	1788	1678	585	585	90	35	1548	Straight	4
170	K Series	Base Edge Assembly	342-3394	2106.5	1996	597.5	500	90	35	1866	Stepped	4
170	Advansys	Base Edge Assembly	566-9366	2106.5	1996	597.5	500	90	35	1866	Stepped	4
170	K Series	Base Edge Assembly	331-6804*	2420	2310	576	500	90	35	2180	Stepped	5
170	K Series	Base Edge Assembly	350-1927*	2106.4	1996.4	598	500	90	35	1866	Stepped	5
170	Advansys	Base Edge Assembly	568-8868	2106.4	1996.4	598	500	90	35	1866	Stepped	5
170	K Series	Base Edge Assembly	420-3383	2106.5	1996	597.5	500	90	35	1866	Stepped	4

Discontinued
Canceled
(Reference)

Part is discontinued. Please contact your service representative.
Part is canceled. Please contact your customer service representative.
Part number is not serviceable. For reference only.

Base Edge Dimensional Reference

Adapter Size Class	Adapter Series	Edge Type	Part Number								Edge Style	Adapter Quantity Welded on Edge
				A	B	C	D	E	F	G		
170	K Series	Base Edge Assembly	342-3362*	2106	1996	500	500	90	35	1866	Straight	4
170	K Series	Base Edge Assembly	293-6389	2440	2330	500	500	90	35	2200	Straight	6
170	K Series	Base Edge Assembly	344-2480*	2350	2240	616	500	90	35	2110	Stepped	4
170	Advansys	Base Edge Assembly	522-2046	1956	1942	605	500	90	35	1740	Stepped	5
170	Advansys	Base Edge Assembly	482-6300	2440	2396	500	500	90	35	2226	Straight	6
170	K Series	Base Edge Assembly	379-3032	2220	2206	593	500	90	35	1956	Stepped	4
170	Advansys	Base Edge Assembly	519-5450	2220	2206	593	500	90	35	1956	Stepped	4
170	K Series	Base Edge Assembly	379-3031	2120	2106	590	500	90	35	1856	Stepped	4
170	Advansys	Base Edge Assembly	519-5452	2120	2106	590	500	90	35	1856	Stepped	4
170	K Series	Base Edge Assembly	453-8156	2420	2396	500	500	90	35	2226	Straight	5
170	Advansys	Base Edge Assembly	519-5457	2420	2396	500	500	90	35	2226	Straight	5
170	K Series	Base Edge Assembly	455-2939	2420	2406	576	500	90	35	2226	Stepped	5
170	Advansys	Base Edge Assembly	519-5458	2420	2406	576	500	90	35	2226	Stepped	5
170	Advansys	Base Edge Assembly	528-9656	2575	2551	500	500	90	35	2276	Straight	6
170	K Series	Base Edge Assembly	(361-2362)	2300	2276	500	500	90	35	2106	Straight	5
170	K Series	Base Edge Assembly	251-7062*	2004	1960	500	500	90	35	1802	Straight	5
170	K Series	Base Edge Assembly	257-1814*	2700	2700	585	585	90	35	2286	Straight	5
170	K Series	Base Edge Assembly	260-1258	2250	2210	500	500	90	35	2048	Straight	4
170	Advansys	Base Edge Assembly	540-4031	2250	2210	500	500	90	35	2048	Straight	4
170	K Series	Base Edge Assembly	260-1259*	2150	2110	500	500	90	35	1948	Straight	4
170	Advansys	Base Edge Assembly	568-8831	2150	2110	500	500	90	35	1948	Straight	4
170	K Series	Base Edge Assembly	313-8817**	1900	1880	650	500	90	35	1698	Stepped	4
170	K Series	Base Edge Assembly	315-5319	2000	1980	650	500	90	35	1798	Stepped	4
170	K Series	Base Edge Assembly	314-2859	2150	2130	650 / 560	500	90	35	1948	Stepped	5
170	K Series	Base Edge Assembly	314-2859	2150	2130	650 / 560	500	90	35	1948	Stepped	5
170	Advansys	Base Edge Assembly	568-8832	2150	2130	650 / 560	500	90	35	1948	Stepped	5
170	K Series	Base Edge Assembly	314-2858	2250	2230	650	500	90	35	2048	Stepped	5
170	K Series	Base Edge Assembly	260-1264	2000	1980	610	500	90	35	1798	Stepped	4
170	Advansys	Base Edge Assembly	550-4395	2000	1980	610	500	90	35	1798	Stepped	4
170	K Series	Base Edge Assembly	260-1265	2150	2130	610	500	90	35	1948	Stepped	4
170	Advansys	Base Edge Assembly	550-4398	2150	2130	610	500	90	35	1948	Stepped	4
170	K Series	Base Edge Assembly	260-1266	1900	1880	610	500	90	35	1698	Stepped	4
170	Advansys	Base Edge Assembly	(566-1814)	1900	1880	610	500	90	35	1698	Stepped	4
170	K Series	Base Edge Assembly	267-5392*	2537	2537	708.2	500	90	35	2335	Stepped	6
170	K Series	Base Edge Assembly	267-5402*	2667	2667	708.2	500	90	35	2447	Stepped	6
170	Advansys	Base Edge Assembly	543-4777	2667	2667	708.2	500	90	35	2447	Stepped	6
170	K Series	Base Edge Assembly	270-3715	1600	1560	500	500	90	35	1398	Straight	3
170	Advansys	Base Edge Assembly	550-8867	1600	1560	500	500	90	35	1398	Straight	3
170	K Series	Base Edge Assembly	282-8926*	2032	1982	722	500	90	35	1802	Stepped	5
170	K Series	Base Edge Assembly	293-6392*	2380	2290	700	500	90	35	2120	Stepped	5
170	Advansys	Base Edge Assembly	566-1850	2380	2290	700	500	90	35	2120	Stepped	5
170	K Series	Base Edge Assembly	296-7430*	2000	1980	610	500	90	35	1760	Stepped	4
170	K Series	Base Edge Assembly	297-5947*	2506	2416	692.8	489.3	90	35	2250	Stepped	5
170	Advansys	Base Edge Assembly	569-4914	2506	2416	692.8	489.3	90	35	2250	Stepped	5
170	K Series	Base Edge Assembly	297-6011*	1975	1931	500	500	90	35	1801	Straight	5
170	K Series	Base Edge Assembly	297-9991*	2426	2406	564	500	90	35	2221	Stepped	4
170	Advansys	Base Edge Assembly	569-5957	2426	2406	564	500	90	35	2221	Stepped	4
170	K Series	Base Edge Assembly	299-6150*	2360	2316	642.7	486.7	90	35	2120	Stepped	5
170	K Series	Base Edge Assembly	300-5943*	2360.4	2210	585	585	90	35	2070	Straight	5
170	K Series	Base Edge Assembly	302-6481*	2272	2228	500	500	90	35	2070	Straight	5
170	K Series	Base Edge Assembly	311-1821*	2310	2200	585	585	90	35	2070	Straight	5
170	K Series	Base Edge Assembly	313-8817**	1900	1880	610	500	90	35	1698	Stepped	4
170	Advansys	Base Edge Assembly	568-8836	1900	1880	610	500	90	35	1698	Stepped	4
170	K Series	Base Edge Assembly	314-2858	2250	2230	564	500	90	35	2048	Stepped	5
170	Advansys	Base Edge Assembly	550-4405	2250	2230	564	500	90	35	2048	Stepped	5
170	K Series	Base Edge Assembly	315-5319	2000	1980	565	500	90	35	1798 / 1800	Stepped	4
170	Advansys	Base Edge Assembly	566-9349	2000	1980	565	500	90	35	1798 / 1800	Stepped	4
170	K Series	Base Edge Assembly	321-7551*	2514	2404	500	500	90	35	2274	Straight	6
170	K Series	Base Edge Assembly	323-6446*	2270	2160	500	500	90	35	2001.6	Straight	6
170	K Series	Base Edge Assembly	325-5395*	2650	2560	720	500	90	35	2390	Stepped	6
170	K Series	Base Edge Assembly	330-6958*	2340	2242	700	500	90	35	2070	Stepped	6
170	K Series	Base Edge Assembly	330-6967*	2398	2288	500	500	90	35	2158	Straight	6
170	K Series	Base Edge Assembly	334-9205*	2150	2150	599.3	500	90	35	1950	Stepped	4
170	K Series	Base Edge Assembly	338-8669*	2196	2107.4	580	465	90	35	1938	Stepped	5
170	Advansys	Base Edge Assembly	(569-5963)	2196	2107.4	580	465	90	35	1938	Stepped	5
170	K Series	Base Edge Assembly	343-6515*	1760	1760	700	500	120	35	1500	Stepped	4
170	K Series	Base Edge Assembly	(354-8528)	2420	2400	576	500	90	35	2180	Stepped	5
170	K Series	Base Edge Assembly	(358-2664)	2350	2310	500	500	90	35	2148	Straight	6
170	K Series	Base Edge Assembly	378-1113*	2380	2380	652.7	496.7	90	35	-	Stepped	3
170	Advansys	Base Edge Assembly	572-3055	2380	2380	652.7	496.7	90	35	-	Stepped	3
170	K Series	Base Edge Assembly	379-2225*	2310	2310	500	500	90	35	-	Straight	3







Cat Hydraulic Excavators

BASE EDGE TABLE

Base Edge Dimensional Reference												
Adapter Size Class	Adapter Series	Edge Type	Part Number								Edge Style	Adapter Quantity Welded on Edge
				A	B	C	D	E	F	G		
170	Advansys	Base Edge Assembly	568-8863	2310	2310	500	500	90	35	-	Straight	3
170	K Series	Base Edge Assembly	(390-8334)	1794	1770	500	500	90	35	1600	Straight	4
170	K Series	Base Edge Assembly	(456-4240)	2590	2590	641.2	456	90	35	2320	Stepped	5
170	Advansys	Base Edge Assembly	547-3352	2590	2590	641.2	456	90	35	2320	Stepped	5
170	K Series	Base Edge Assembly	461-7851	2380	2290	700	500	90	35	-	Stepped	3
170	Advansys	Base Edge Assembly	566-9370	2380	2290	700	500	90	35	-	Stepped	3
170	K Series	Base Edge Assembly	(466-1826)	3640	3586.2	595.4	526.3	90	35	3388	Stepped	8
170	K Series	Base Edge Assembly	466-3065	1719	1695	500	500	90	35	1526	Straight	4
170	Advansys	Base Edge Assembly	528-9657	1719	1695	500	500	90	35	1526	Straight	4
170	K Series	Base Edge Assembly	(481-9626)	2500	2500	630	445	90	35	1128	Stepped	5
170	K Series	Base Edge Assembly	484-1311	2420	2406	622	500	90	35	2420	Stepped	2
170	K Series	Base Edge Assembly	500-1188	2500	2500	630	445	90	35	2295.9	Stepped	2
170	Advansys	Base Edge Assembly	538-2276	2020	2020	450	450	90	35	1840	Straight	5
170	K Series	Base Edge Assembly	362-5345*	2333.2	2238	622.8	500	90	35	-	Stepped	2
170	K Series	Base Edge Assembly	362-5345*	2333.2	2238	622.8	500	90	35	-	Stepped	2
170	Advansys	Base Edge Assembly	551-2809	2120	2106	590	500	90	35	1807.8	Stepped	4
170	Advansys	Base Edge Assembly	556-7894	2350	2310	650	500	90	35	2109	Stepped	4
170	Advansys	Base Edge Assembly	557-4695	2020	2006	584	500	90	35	1806	Stepped	4
170	Advansys	Base Edge Assembly	547-3351	2590	2590	641.2	456	90	35	2320	Stepped	5
170	Advansys	Base Edge Assembly	568-8107	2130.8	1958	500	500	90	35	1837	Straight	5
170	Advansys	Base Edge Assembly	569-4916	2044	2000	500	500	90	35	1801	Straight	5
170	Advansys	Base Edge Assembly	568-8860	2420	2396	500	500	90	35	-	Straight	4
J800/200	J Series	Base Edge Assembly	415-4014	2510	2496	656	500	100	35	2220	Stepped	5
J800/200	J Series	Base Edge Assembly	519-8495	2510	2496	656	500	100	35	2220	Stepped	5
J800/200	J Series	Base Edge Assembly	360-5998	2510	2496	578	500	100	35	2220	Stepped	5
J800/200	J Series	Base Edge Assembly	519-5502	2510	2496	578	500	100	35	2220	Stepped	5
J800/200	J Series	Base Edge Assembly	360-5995	2040	2026	500	500	100	35	1740	Straight	4
J800/200	J Series	Base Edge Assembly	519-5500	2040	2026	500	500	100	35	1740	Straight	4
J800/200	J Series	Base Edge Assembly	360-5996	2310	2296	607	500	100	35	2020	Stepped	4
J800/200	J Series	Base Edge Assembly	519-5501	2310	2296	607	500	100	35	2020	Stepped	4
J800/200	J Series	Base Edge Assembly	360-6056	2160	2146	593	500	100	35	1870	Stepped	4
J800/200	J Series	Base Edge Assembly	519-5503	2160	2146	593	500	100	35	1870	Stepped	4
J800/200	J Series	Base Edge Assembly	(417-4244)	2160	2146	578	500	100	35	1850	Stepped	4
J800/200	J Series	Base Edge Assembly	519-5505	2160	2146	578	500	100	35	1850	Stepped	4
J800/200	J Series	Base Edge Assembly	422-7802	2310	2276	500	500	100	35	2020	Straight	4
J800/200	J Series	Base Edge Assembly	519-5506	2310	2276	500	500	100	35	2020	Straight	4
J800/200	J Series	Base Edge Assembly	360-5997	2420	2406	615	500	100	35	2130	Stepped	4
J800/200	J Series	Base Edge Assembly	519-5507	2420	2406	615	500	100	35	2130	Stepped	4
J800/200	J Series	Base Edge Assembly	360-6057	2310	2296	607	500	100	35	2020	Stepped	4
J800/200	J Series	Base Edge Assembly	519-5508	2310	2296	607	500	100	35	2020	Stepped	4
J800/200	J Series	Base Edge Assembly	360-6058	2420	2406	615	500	100	35	2130	Stepped	4
J800/200	J Series	Base Edge Assembly	519-5509	2420	2406	615	500	100	35	2130	Stepped	4
J800/200	J Series	Base Edge Assembly	396-3017	2660	2646	578	500	100	35	2360	Stepped	5
J800/200	J Series	Base Edge Assembly	543-2829	2660	2646	578	500	100	35	2360	Stepped	5
J800/200	J Series	Base Edge Assembly	492-3846	2100	2086	907	500	100	35	1797.2	Stepped	3
J800/200	J Series	Base Edge Assembly	432-5913	2510	2496	615	500	100	35	2216	Stepped	4
J800/200	J Series	Base Edge Assembly	556-7880	2510	2496	615	500	100	35	2216	Stepped	4
J800/200	J Series	Base Edge Assembly	379-3119	2040	2026	500	500	120	35	1740	Straight	4
J800/200	J Series	Base Edge Assembly	465-7903	2010	1996	580	500	100	35	1700	Stepped	4
J800/200	J Series	Base Edge Assembly	(390-8341)	1880	1846	500	500	100	35	1600	Straight	4
J800/200	J Series	Base Edge Assembly	440-1584	1880	1866	568	500	100	35	1580	Stepped	4
J800/200	J Series	Base Edge Assembly	(416-6439)	2420	2406	500	500	100	35	2130	Straight	4
J800/200	J Series	Base Edge Assembly	447-6965	1670	1656	611	500	100	35	1380	Stepped	3
J800/200	J Series	Base Edge Assembly	394-7027	2295	2261	500	500	100	35	2015	Straight	5
J800/200	J Series	Base Edge Assembly	365-5814*	2160	2146	500	500	100	35	1870	Straight	4
J800/200	J Series	Base Edge Assembly	425-9690	1820	1806	500	500	100	35	1540	Straight	4
J800/200	J Series	Base Edge Assembly	396-3017	2660	2646	578	500	100	35	2360	Stepped	5
J800/200	J Series	Base Edge Assembly	368-3656	2650	2636	500	500	100	35	2360	Straight	5
J800/200	J Series	Base Edge Assembly	(373-6787)	2090	2076	500	500	100	35	1790	Straight	4
J800/200	J Series	Base Edge Assembly	377-5784*	2540	2540	500	500	100	35	-	Straight	3
J800/200	J Series	Base Edge Assembly	(547-8405)	2730	2716	590	500	100	35	2440	Stepped	5
J800/200	J Series	Base Edge Assembly	(433-8882)	3940	3896	700	598	100	35	3672	Stepped	7
J800/200	J Series	Base Edge Assembly	365-2889*	2638	2592	663.7	500	100	35	2348	Stepped	5







Cat Hydraulic Excavators

BASE EDGE PART NUMBER REFERENCE TABLE

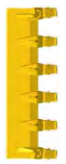





Base Edge Part Number Reference							
Adapter Size	K Base Edge As	Advansys Edge As	K Conversion Edge	Advansys Conversion Edge	Conversion Edge Adapter Qty	Replacement Cut To Length Edge	Corner Adapter Style
							 Center  Corner
80	-	-	232-0022	-	1	-	-
80	-	-	232-0022	-	1	-	-
80	-	-	232-0023 ^x	-	2	-	-
80	-	-	232-0023 ^x	-	2	-	-
80	-	-	232-0024	547-5089	3	-	-
80	-	-	232-0024	547-5089	3	-	-
80	-	-	232-0025	547-5090	3	-	-
80	-	-	232-0025	547-5090	3	-	-
80	239-2599*	-	-	-	-	71-6713	-
80	239-2619	-	232-0024	547-5089	3	-	Corner
80	239-2619	-	232-0024	547-5089	3	-	Corner
80	239-2659*	-	-	-	-	71-6713	-
80	239-2764	-	232-0025	547-5090	3	-	Corner
80	239-2764	-	232-0025	547-5090	3	-	Corner
80	239-2774*	-	232-0023 ^x	-	2	-	Corner
80	239-2774*	-	232-0023 ^x	-	2	-	Corner
80	239-2784	-	232-0026	-	4	-	Corner
80	239-2784	-	232-0026	-	4	-	Corner
80	239-2810*	-	232-0022	-	1	-	Corner
80	239-2810*	-	232-0022	-	1	-	Corner
80	240-9602*	-	-	-	-	-	-
80	240-9604	-	-	-	-	-	-
80	240-9605	-	-	-	-	-	-
80	240-9606 ^x	-	-	-	-	-	-
80	241-4214 ^x	-	-	-	-	-	-
80	250-0541 ^x	-	-	-	-	-	-
80	250-0542 ^x	-	-	-	-	-	-
80	250-0562	541-1871	-	-	-	-	-
80	251-8661*	-	-	-	-	71-6713	-
80	251-8662*	-	-	-	-	71-6713	-
80	251-8663	-	253-9581 ^x	-	3	71-6713	Corner
80	251-8663	-	253-9581 ^x	-	3	71-6713	Corner
80	251-8664	-	-	-	-	71-6713	-
80	251-8665	-	-	-	-	71-6713	-
80	251-8666	541-1866	-	-	-	71-6713	-
80	251-8667	-	-	-	-	71-6713	-
80	252-1212*	-	-	-	-	71-6713	-
80	252-1213	-	-	-	-	71-6713	-
80	(264-0275)	-	-	-	-	-	-
80	270-1782*	-	-	-	-	-	-
80	271-5410 ^x	-	253-9581 ^x	-	3	71-6713	Corner
80	271-5410 ^x	-	253-9581 ^x	-	3	71-6713	Corner
80	276-5880 ^x	-	-	-	-	-	-
80	276-5881 ^x	-	-	-	-	-	-
80	276-5882 ^x	-	-	-	-	-	-

Cat Hydraulic Excavators

BASE EDGE PART NUMBER REFERENCE TABLE







Base Edge Part Number Reference							
Adapter Size	K Base Edge As	Advansys Edge As	K Conversion Edge	Advansys Conversion Edge	Conversion Edge Adapter Qty	Replacement Cut To Length Edge	Corner Adapter Style
							 Center  Corner
80	276-5883*	-	-	-	-	-	-
80	276-5884	-	-	-	-	-	-
80	276-5885	-	-	-	-	-	-
80	279-3909*	-	-	-	-	71-6713	-
80	279-4080*	-	-	-	-	-	-
80	279-4081*	-	-	-	-	-	-
80	279-4082*	-	-	-	-	-	-
80	279-4083	-	-	-	-	-	-
80	279-4084	-	-	-	-	-	-
80	279-4085*	-	-	-	-	-	-
80	292-8978*	-	-	-	-	71-6713	-
80	298-0106*	544-2692	-	-	-	-	-
80	298-0107*	-	-	-	-	-	-
80	298-0108	-	-	-	-	-	-
80	298-0109	-	-	-	-	-	-
80	298-0110	-	-	-	-	-	-
80	(306-4048)	-	-	-	-	-	-
80	306-5688	-	-	-	-	-	-
80	(306-5702)	-	-	-	-	-	-
80	(308-5748)	-	-	-	-	-	-
80	313-1311*	-	-	-	-	71-6713	-
80	317-0121	-	-	-	-	-	-
80	320-1433	-	-	-	-	-	-
80	323-1387*	-	-	-	-	-	-
80	327-3646*	-	-	-	-	-	-
80	(331-9368)	-	-	-	-	71-6713	-
80	347-7466	557-1759	-	-	-	71-6713	-
80	347-7467	560-3997	-	-	-	71-6713	-
80	347-7468	544-2706	-	-	-	71-6713	-
80	347-7580	544-2641	-	-	-	71-6713	-
80	347-7581	556-0170	-	-	-	71-6713	-
80	347-7582	552-6835	-	-	-	71-6713	-
80	347-7583	552-6836	-	-	-	71-6713	-
80	347-7584	-	-	-	-	71-6713	-
80	347-7585	541-1869	-	-	-	71-6713	-
80	347-7586	541-1865	-	-	-	71-6713	-
80	347-7587	544-2670	-	-	-	71-6713	-
80	347-7588	552-6868	-	-	-	71-6713	-
80	347-7589	544-2703	-	-	-	71-6713	-
80	(348-3088)	-	-	-	-	71-6713	-
80	(348-3203)	-	-	-	-	71-6713	-
80	357-9720*	560-3388	-	-	-	-	-
80	358-8602*	544-2678	-	-	-	-	-
80	361-0518	544-2633	-	-	-	-	-

Base Edge Part Number Reference

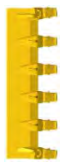





Adapter Size	K Base Edge As	Advansys Edge As	K Conversion Edge	Advansys Conversion Edge	Conversion Edge Adapter Qty	Replacement Cut To Length Edge	Corner Adapter Style
							 Center  Corner
80	362-9163	544-2684	-	-	-	-	-
80	365-2276	544-2655	-	-	-	71-6713	-
80	365-6127	-	-	-	-	-	-
80	371-9180	557-1760	-	-	-	71-6713	-
80	371-9181	557-1761	-	-	-	71-6713	-
80	372-4168*	-	-	-	-	-	-
80	(372-8136)	-	-	-	-	71-6713	-
80	376-4825	544-2712	-	-	-	-	-
80	377-2247	544-2699	-	-	-	-	-
80	378-0380	-	-	-	-	71-6713	-
80	378-0381	-	-	-	-	71-6713	-
80	378-0382	-	-	-	-	71-6713	-
80	378-0383	-	-	-	-	71-6713	-
80	378-0384	541-1870	-	-	-	71-6713	-
80	378-0385	-	-	-	-	71-6713	-
80	379-1799	-	-	-	-	-	-
80	379-2936	-	-	-	-	-	-
80	381-7258	-	-	-	-	-	-
80	381-7259	-	-	-	-	-	-
80	381-7260	-	-	-	-	-	-
80	381-7261	-	-	-	-	-	-
80	390-3447	-	-	-	-	-	-
80	390-3448	-	-	-	-	-	-
80	390-3449	-	-	-	-	-	-
80	390-3450	-	-	-	-	-	-
80	397-8626	557-1735	-	-	-	-	-
80	416-5447	-	-	-	-	71-6713	-
80	416-5448	-	-	-	-	71-6713	-
80	425-1005	-	-	-	-	-	-
80	425-3855	544-2715	-	-	-	-	-
80	431-5168	-	-	-	-	71-6713	-
80	440-1463	-	-	-	-	-	-
80	446-1220	-	-	-	-	-	-
80	457-7646	-	-	-	-	-	-
80	476-0396	-	-	-	-	-	-
80	(487-1633)	-	-	-	-	-	-
80	(487-1640)	-	-	-	-	-	-
80	(488-0107)	-	-	-	-	-	-
80	488-0120	-	-	-	-	-	-
80	488-0124	-	-	-	-	-	-
80	488-0127	-	-	-	-	-	-
80	492-3723	-	-	-	-	71-6713	-
80	510-4528	552-8331	-	-	-	-	-
80	513-9535	-	-	-	-	-	-

Cat Hydraulic Excavators

BASE EDGE PART NUMBER REFERENCE TABLE







Base Edge Part Number Reference							
Adapter Size	K Base Edge As	Advansys Edge As	K Conversion Edge	Advansys Conversion Edge	Conversion Edge Adapter Qty	Replacement Cut To Length Edge	Corner Adapter Style
							 Center  Corner
80	514-7630	555-7401	-	-	-	-	-
80	516-7763	-	-	-	-	-	-
80	516-9289	-	-	-	-	-	-
80	520-7468	558-8000	-	-	-	-	-
80	-	541-1867	-	-	-	71-6713	-
80	-	541-1868	-	-	-	71-6713	-
80	525-8903	-	-	-	-	71-6713	-
80	347-7469	552-3372	-	-	-	71-6713	-
80	-	-	232-0026	-	4	-	-
80	-	-	232-0026	-	4	-	-
80	250-0563*	-	-	-	-	-	-
80	(241-4215)	-	-	-	-	-	-
80	270-7136*	-	-	-	-	-	-
80	286-1047*	-	-	-	-	-	-
80	292-4019*	-	-	-	-	71-6713	-
80	250-0538*	-	-	-	-	-	-
80	277-2372*	-	-	-	-	-	-
80	302-6464*	-	-	-	-	-	-
80	279-3911*	-	-	-	-	71-6713	-
80	308-5017*	-	-	-	-	-	-
80	252-5491*	-	-	-	-	71-6713	-
80	253-9580*	-	-	-	-	71-6713	-
80	250-0539*	-	-	-	-	-	-
80	279-3914*	-	-	-	-	71-6713	-
80	296-0338*	-	-	-	-	-	-
80	279-3912*	-	-	-	-	71-6713	-
80	279-3913*	-	-	-	-	71-6713	-
80	241-4210*	-	-	-	-	-	-
80	250-0564*	-	-	-	-	-	-
80	279-3910*	-	-	-	-	71-6713	-
80	323-5740*	-	-	-	-	71-6713	-
80	300-4628*	-	-	-	-	-	-
80	241-4213*	-	-	-	-	-	-
80	250-0537*	-	-	-	-	-	-
80	253-9575*	-	-	-	-	71-6713	-
80	252-5492*	-	-	-	-	71-6713	-
80	308-5744*	-	-	-	-	-	-
80	241-4212*	-	-	-	-	-	-
80	279-3915*	-	-	-	-	71-6713	-
80	240-9607*	-	-	-	-	-	-
80	253-8161*	-	-	-	-	-	-
80	240-9603*	-	-	-	-	-	-
80	286-6920*	-	-	-	-	71-6713	-
80	291-0632*	-	-	-	-	-	-

Base Edge Part Number Reference







Adapter Size	K Base Edge As	Advansys Edge As	K Conversion Edge	Advansys Conversion Edge	Conversion Edge Adapter Qty	Replacement Cut To Length Edge	Corner Adapter Style
							 Center  Corner
80	252-5490*	-	-	-	-	71-6713	-
80	-	-	253-9581*	-	3	71-6713	-
80	-	-	253-9581*	-	3	71-6713	-
80	296-0340*	-	-	-	-	-	-
80	276-4178*	-	-	-	-	71-6713	-
80	250-0560*	-	-	-	-	-	-
80	271-5409*	-	-	-	-	71-6713	-
80	250-0561*	-	-	-	-	-	-
80	297-2393*	-	-	-	-	71-6713	-
80	241-4211*	-	-	-	-	-	-
80	250-0559*	-	-	-	-	-	-
80	250-0540*	-	-	-	-	-	-
80	273-0009*	-	-	-	-	71-6713	-
80	296-0339*	-	-	-	-	-	-
80	253-0132*	-	-	-	-	-	-
80	353-0142*	-	-	-	-	-	-
80	-	544-2736	-	-	-	-	-
80	-	544-2737	-	-	-	-	-
80	-	544-2738	-	-	-	-	-
80	-	544-2739	-	-	-	-	-
80	-	552-3406	-	-	-	71-6713	-
80	(392-8128)	552-3373	-	-	-	71-6713	-
80	392-8129	552-3374	-	-	-	71-6713	-
80	-	552-3377	-	-	-	-	-
80	-	552-3376	-	-	-	-	-
80	-	557-1754	-	-	-	-	-
80	-	556-0169	-	-	-	71-6713	-
80	-	556-0171	-	-	-	71-6713	-
80	-	556-0172	-	-	-	71-6713	-
80	-	556-0173	-	-	-	71-6713	-
80	-	556-0174	-	-	-	71-6713	-
80	-	563-0200	-	-	-	71-6713	-
80	-	563-0201	-	-	-	-	-
80	-	563-0202	-	-	-	-	-
80	-	(575-5293)	-	-	-	-	-
90	333-2379*	-	-	-	-	129-1540	-
90	229-6627	-	-	-	-	129-1540	-
90	489-6708	-	-	-	-	-	-
90	337-1808*	-	-	-	-	-	-
90	239-2642	540-4065	-	-	-	129-1540	-
90	250-9674	541-1890	-	-	-	129-1540	-
90	250-9676	-	-	-	-	129-1540	-
90	(282-6441)	-	-	-	-	129-1540	-
90	235-2498	540-4066	-	-	-	129-1540	-

Cat Hydraulic Excavators

BASE EDGE PART NUMBER REFERENCE TABLE







Base Edge Part Number Reference							
Adapter Size	K Base Edge As	Advansys Edge As	K Conversion Edge	Advansys Conversion Edge	Conversion Edge Adapter Qty	Replacement Cut To Length Edge	Corner Adapter Style
							 Center  Corner
90	290-1167*	-	-	-	-	129-1540	-
90	250-2886	-	-	-	-	129-1540	-
90	239-2818*	-	-	-	-	-	-
90	250-9673	-	-	-	-	129-1540	-
90	239-2801*	-	-	-	-	-	-
90	257-2255*	-	-	-	-	129-1540	-
90	251-8668*	-	-	-	-	129-1540	-
90	251-8671	-	-	-	-	129-1540	-
90	(229-7704)	-	-	-	-	-	-
90	250-9672*	-	-	-	-	129-1540	-
90	351-0422	-	-	-	-	-	-
90	239-2792*	-	-	-	-	-	-
90	269-8509*	-	-	-	-	129-1540	-
90	227-8740	-	-	-	-	129-1540	-
90	(261-9706)	-	-	-	-	129-1540	-
90	250-9670*	-	-	-	-	129-1540	-
90	(235-2497)	-	-	-	-	129-1540	-
90	350-4270	-	-	-	-	-	-
90	228-6952	-	232-0029	547-5092	3	129-1540	Corner
90	239-2716*	-	-	-	-	-	-
90	228-6951*	-	-	-	-	129-1540	-
90	228-6953	540-4065	232-0030	547-5091	3	129-1540	Corner
90	239-2819*	-	-	-	-	-	-
90	239-2545*	-	-	-	-	129-1540	-
90	225-6813	540-4064	232-0031	563-0197	4	129-1540	Corner
90	239-2634*	-	-	-	-	129-1540	-
90	250-9671	-	-	-	-	129-1540	-
90	250-9675	540-4063	-	-	-	129-1540	-
90	239-2650	540-4064	-	-	-	129-1540	-
90	239-2676*	-	-	-	-	129-1540	-
90	251-8670	-	-	-	-	129-1540	-
90	517-0146	-	-	-	-	129-1540	-
90	513-2144	-	-	-	-	-	-
90	513-2146	-	-	-	-	129-1540	-
90	(492-3815)	-	-	-	-	129-1540	-
90	348-3095	540-4075	-	-	-	129-1540	-
90	293-7844	540-4072	-	-	-	-	-
90	378-0396	557-3508	-	-	-	129-1540	-
90	378-0397	557-3509	-	-	-	129-1540	-
90	279-4096*	557-1765	-	-	-	129-1540	-
90	279-4094	540-4072	-	-	-	129-1540	-
90	450-9092	-	-	-	-	-	-
90	279-4095	540-4073	-	-	-	129-1540	-
90	(349-8480)	-	-	-	-	-	-

Base Edge Part Number Reference

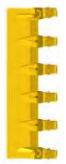





Adapter Size	K Base Edge As	Advansys Edge As	K Conversion Edge	Advansys Conversion Edge	Conversion Edge Adapter Qty	Replacement Cut To Length Edge	Corner Adapter Style
							 Center  Corner
90	293-7842	-	-	-	-	-	-
90	279-4092	540-4070	-	-	-	129-1540	-
90	476-9207	-	-	-	-	129-1540	-
90	418-9246*	-	-	-	-	129-1540	-
90	348-3099	557-1767	-	-	-	-	-
90	450-3570	-	-	-	-	-	-
90	348-3098	-	-	-	-	-	-
90	293-7841*	-	-	-	-	-	-
90	334-9203	-	-	-	-	-	-
90	279-4090	544-2650	-	-	-	129-1540	-
90	279-4091	540-4069	-	-	-	129-1540	-
90	279-4093	540-4071	-	-	-	129-1540	-
90	293-7843*	557-1724	-	-	-	-	-
90	348-3093	555-7371	-	-	-	129-1540	-
90	348-3096	555-7372	-	-	-	129-1540	-
90	375-6889*	-	-	-	-	129-1540	-
90	454-3459	-	-	-	-	129-1540	-
90	348-3097	544-2503	-	-	-	129-1540	-
90	459-6500	-	-	-	-	129-1540	-
90	457-7624	-	-	-	-	-	-
90	348-3091	555-7370	-	-	-	129-1540	-
90	348-3094	540-4074	-	-	-	129-1540	-
90	348-3092	-	-	-	-	129-1540	-
90	290-5888*	-	-	-	-	129-1540	-
90	371-9146	540-4062	-	-	-	-	-
90	361-4482*	-	-	-	-	-	-
90	465-2320	-	-	-	-	-	-
90	346-3099*	575-5291	-	-	-	129-1540	-
90	335-2182	-	-	-	-	-	-
90	320-6505	-	-	-	-	129-1540	-
90	276-5895	540-4068	-	-	-	129-1540	-
90	493-5034	-	-	-	-	129-1540	-
90	276-5892*	-	-	-	-	129-1540	-
90	276-5893*	-	-	-	-	129-1540	-
90	276-5891	-	-	-	-	129-1540	-
90	279-3916*	-	-	-	-	129-1540	-
90	276-5890*	-	-	-	-	129-1540	-
90	494-2128	-	-	-	-	129-1540	-
90	378-1335	540-4075	-	-	-	129-1540	-
90	276-5894	-	-	-	-	129-1540	-
90	-	-	232-0030	547-5091	3	129-1540	-
90	255-0372	-	-	-	-	-	-
90	232-0032	547-5093	-	-	-	129-1540	-
90	(274-5480)	-	-	-	-	-	-

Cat Hydraulic Excavators

BASE EDGE PART NUMBER REFERENCE TABLE







Base Edge Part Number Reference							
Adapter Size	K Base Edge As	Advansys Edge As	K Conversion Edge	Advansys Conversion Edge	Conversion Edge Adapter Qty	Replacement Cut To Length Edge	Corner Adapter Style
							 Center  Corner
90	232-0027*	-	-	-	-	129-1540	-
90	255-0385	-	-	-	-	-	-
90	232-0028	-	-	-	-	129-1540	-
90	-	-	238-3199	563-0199	3	129-1540	-
90	-	-	232-0029	547-5092	3	129-1540	-
90	-	-	232-0031	563-0197	4	129-1540	-
90	282-1567*	-	-	-	-	129-1540	-
90	253-8209*	-	-	-	-	129-1540	-
90	234-9059*	-	-	-	-	129-1540	-
90	265-3004*	-	-	-	-	129-1540	-
90	237-1887*	-	-	-	-	129-1540	-
90	237-1886*	-	232-0029	547-5092	3	129-1540	Center
90	236-3946*	-	-	-	-	129-1540	-
90	237-1888*	-	232-0031	563-0197	4	129-1540	Center
90	253-9576*	-	-	-	-	129-1540	-
90	273-0010*	-	-	-	-	129-1540	-
90	245-6354*	-	-	-	-	129-1540	-
90	320-6494*	-	-	-	-	129-1540	-
90	237-1889*	-	-	-	-	129-1540	-
90	266-0243*	-	-	-	-	129-1540	-
90	251-8669*	-	-	-	-	129-1540	-
90	257-3193*	-	-	-	-	129-1540	-
90	261-9705*	-	-	-	-	129-1540	-
90	237-1885*	-	-	-	-	129-1540	-
90	273-0011*	-	-	-	-	129-1540	-
90	293-7840*	-	-	-	-	-	-
90	253-9205*	-	-	-	-	129-1540	-
90	295-5867*	-	-	-	-	-	-
90	287-6985*	-	-	-	-	129-1540	-
90	237-1884*	-	-	-	-	129-1540	-
90	235-2499*	-	-	-	-	129-1540	-
90	253-8153*	-	238-3199	563-0199	3	129-1540	Corner
90	263-5770*	-	-	-	-	-	-
90	425-5647	552-3454	-	-	-	-	-
90	425-5648	552-3455	-	-	-	-	-
90	-	555-7424	-	-	-	129-1540	-
90	-	555-7425	-	-	-	129-1540	-
90	-	555-7426	-	-	-	129-1540	-
90	-	555-7427	-	-	-	129-1540	-
90	-	555-7428	-	-	-	129-1540	-
90	-	563-0198	-	-	-	-	-
90/100	368-2780*	-	-	-	-	-	-
100	250-9677*	-	-	-	-	127-2317	-
100	275-2713	-	-	-	-	-	-

Base Edge Part Number Reference

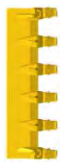





Adapter Size	K Base Edge As	Advansys Edge As	K Conversion Edge	Advansys Conversion Edge	Conversion Edge Adapter Qty	Replacement Cut To Length Edge	Corner Adapter Style
							 Center  Corner
100	293-8620*	-	-	-	-	-	-
100	241-6728*	-	232-0035	547-5065	3	127-2317	Corner
100	(239-2481)	-	-	-	-	-	-
100	275-3252*	-	-	-	-	127-2317	-
100	229-7953*	-	-	-	-	-	-
100	250-9679	-	253-9577*	-	2	127-2317	Corner
100	268-4284*	-	-	-	-	-	-
100	239-2875	-	-	-	-	-	-
100	384-2215*	-	-	-	-	127-2317	-
100	250-9680	-	-	-	-	127-2317	-
100	241-6730	-	-	-	-	127-2317	-
100	275-2715	-	-	-	-	-	-
100	241-6727	-	232-0039	547-5066*	3	127-2317	Corner
100	264-2665	-	-	-	-	127-2317	-
100	241-6729	-	232-0036	563-0194	4	127-2317	Corner
100	(239-2588)	-	-	-	-	-	-
100	(365-7761)	-	-	-	-	-	-
100	264-2666	-	-	-	-	127-2317	-
100	346-9702*	-	-	-	-	127-2317	-
100	(322-9572)	-	-	-	-	-	-
100	264-2664	-	253-9579*	-	3	127-2317	Corner
100	292-5755*	-	-	-	-	127-2317	-
100	250-9682	-	-	-	-	127-2317	-
100	250-9681	-	253-9578*	-	3	127-2317	Corner
100	241-6726	-	-	-	-	127-2317	-
100	(351-2861)	-	-	-	-	-	-
100	(239-2433)	-	-	-	-	-	-
100	310-1859	-	-	-	-	127-2317	-
100	241-6724*	-	-	-	-	127-2317	-
100	282-8759*	-	-	-	-	-	-
100	522-3423	-	-	-	-	127-2317	-
100	515-3416	-	-	-	-	127-2317	-
100	517-0722	-	-	-	-	127-2317	-
100	514-4616	-	-	-	-	127-2317	-
100	356-4345	(540-4042)	-	-	-	-	-
100	279-4107	540-4038	-	-	-	127-2317	-
100	442-6692	-	-	-	-	127-2317	-
100	(487-7780)	-	-	-	-	127-2317	-
100	362-6243	-	-	-	-	127-2317	-
100	348-3110	543-2759	-	-	-	127-2317	-
100	348-3104	541-1875	-	-	-	127-2317	-
100	279-4103	540-4035	-	-	-	127-2317	-
100	348-3105*	541-1877	-	-	-	127-2317	-
100	348-3109	543-2760	-	-	-	-	-

Cat Hydraulic Excavators

BASE EDGE PART NUMBER REFERENCE TABLE







Base Edge Part Number Reference							
Adapter Size	K Base Edge As	Advansys Edge As	K Conversion Edge	Advansys Conversion Edge	Conversion Edge Adapter Qty	Replacement Cut To Length Edge	Corner Adapter Style
							 Center  Corner
100	(367-8614)	-	-	-	-	127-2317	-
100	279-4100	542-6855	-	-	-	127-2317	-
100	348-3102*	541-1876	-	-	-	127-2317	-
100	(371-9049)	-	-	-	-	-	-
100	437-4021	-	-	-	-	-	-
100	(487-5140)	-	-	-	-	127-2317	-
100	469-2476	-	-	-	-	-	-
100	279-4102	540-4034	-	-	-	127-2317	-
100	279-4106	538-9472	-	-	-	127-2317	-
100	433-0099	576-5329	-	-	-	-	-
100	308-5796	543-2761	-	-	-	127-2317	-
100	(332-4868)	-	-	-	-	127-2317	-
100	348-3108	542-6862	-	-	-	127-2317	-
100	353-0089	540-4040	-	-	-	127-2317	-
100	279-4105	540-4037	-	-	-	127-2317	-
100	331-1881*	-	-	-	-	127-2317	-
100	348-3100*	-	-	-	-	127-2317	-
100	380-5906*	-	-	-	-	127-2317	-
100	279-4104	540-4036	-	-	-	127-2317	-
100	348-3103	541-1898	-	-	-	127-2317	-
100	348-3101*	541-1899	-	-	-	127-2317	-
100	359-7463	-	-	-	-	127-2317	-
100	501-4897	-	-	-	-	-	-
100	453-3404	-	-	-	-	127-2317	-
100	279-4101	540-4033	-	-	-	127-2317	-
100	316-4123*	-	-	-	-	-	-
100	(378-0602)	-	-	-	-	127-2317	-
100	279-4121*	-	-	-	-	127-2317	-
100	279-4123*	-	-	-	-	127-2317	-
100	311-1767	-	-	-	-	127-2317	-
100	279-4126	-	-	-	-	127-2317	-
100	279-4124*	-	-	-	-	127-2317	-
100	415-8647*	-	-	-	-	127-2317	-
100	279-4122*	-	-	-	-	127-2317	-
100	279-4125	-	-	-	-	127-2317	-
100	324-5219	-	-	-	-	127-2317	-
100	-	-	232-0036	563-0194	4	127-2317	-
100	314-8680*	-	-	-	-	127-2317	-
100	-	-	232-0039	547-5066*	3	127-2317	-
100	368-3737*	-	-	-	-	-	-
100	249-8622	-	-	-	-	127-2317	-
100	232-0037	547-5068	-	-	-	127-2317	-
100	232-0034	547-5067	-	-	-	127-2317	-
100	232-0033*	-	-	-	-	127-2317	-

Base Edge Part Number Reference

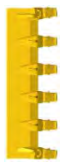





Adapter Size	K Base Edge As	Advansys Edge As	K Conversion Edge	Advansys Conversion Edge	Conversion Edge Adapter Qty	Replacement Cut To Length Edge	Corner Adapter Style
							 Center  Corner
100	-	-	232-0035	547-5065	3	127-2317	-
100	(297-5992)	-	-	-	-	127-2317	-
100	(349-8219)	-	-	-	-	-	-
100	(338-7707)	-	-	-	-	127-2317	-
100	232-0038	563-0186	-	-	-	127-2317	-
100	322-6021*	-	-	-	-	127-2317	-
100	-	540-4043	-	-	-	127-2317	-
100	-	540-4051	-	-	-	127-2317	-
100	-	541-1883	-	-	-	127-2317	-
100	-	542-6846	-	-	-	127-2317	-
100	-	540-4044	-	-	-	127-2317	-
100	-	540-4052	-	-	-	127-2317	-
100	-	540-4045	-	-	-	127-2317	-
100	-	540-4039*	-	-	-	127-2317	-
100	-	541-1880	-	-	-	127-2317	-
100	-	541-1883	-	-	-	127-2317	-
100	-	541-1882	-	-	-	127-2317	-
100	-	542-6863	-	-	-	127-2317	-
100	-	542-6874	-	-	-	127-2317	-
100	-	542-6875	-	-	-	127-2317	-
100	323-1765*	-	-	-	-	-	-
100	278-0878*	-	-	-	-	127-2317	-
100	277-3975*	-	-	-	-	127-2317	-
100	277-8196*	-	-	-	-	-	-
100	241-6737*	-	-	-	-	127-2317	-
100	241-6725*	-	-	-	-	127-2317	-
100	241-6734*	-	232-0039	547-5066*	3	127-2317	Center
100	-	-	253-9577*	-	2	127-2317	-
100	308-3703*	-	-	-	-	127-2317	-
100	264-2665	-	-	-	-	127-2317	-
100	316-9009*	-	-	-	-	-	-
100	276-5760*	-	-	-	-	127-2317	-
100	241-6736*	-	232-0036	563-0194	4	127-2317	Center
100	301-4357*	-	-	-	-	-	-
100	311-1757*	-	-	-	-	-	-
100	330-6917*	-	-	-	-	127-2317	-
100	295-2209*	-	-	-	-	127-2317	-
100	241-6735*	-	232-0035	547-5065	3	127-2317	Center
100	264-2663*	-	-	-	-	127-2317	-
100	301-4369*	-	-	-	-	127-2317	-
100	240-9595*	-	-	-	-	127-2317	-
100	-	-	253-9579*	-	3	127-2317	-
100	250-9678*	-	-	-	-	127-2317	-
100	241-6732*	-	-	-	-	127-2317	-

Cat Hydraulic Excavators

BASE EDGE PART NUMBER REFERENCE TABLE







Base Edge Part Number Reference							
Adapter Size	K Base Edge As	Advansys Edge As	K Conversion Edge	Advansys Conversion Edge	Conversion Edge Adapter Qty	Replacement Cut To Length Edge	Corner Adapter Style
							 Center  Corner
100	305-2816 ^x	-	-	-	-	127-2317	-
100	330-6911 ^x	-	-	-	-	-	-
100	273-5589 ^x	-	-	-	-	127-2317	-
100	359-3008 ^x	-	-	-	-	127-2317	-
100	241-4209 ^x	-	-	-	-	127-2317	-
100	269-2700 ^x	-	-	-	-	127-2317	-
100	242-1794 ^x	-	-	-	-	127-2317	-
100	308-5755 ^x	-	-	-	-	-	-
100	271-7299 ^x	-	-	-	-	127-2317	-
100	241-6733 ^x	-	-	-	-	127-2317	-
100	269-2699 ^x	-	-	-	-	127-2317	-
100	-	-	253-9578 ^x	-	3	127-2317	-
100	-	543-2712	-	-	-	127-2317	-
100	-	543-2713	-	-	-	127-2317	-
100	-	543-2714	-	-	-	127-2317	-
100	-	543-2715	-	-	-	127-2317	-
100	-	543-2716	-	-	-	127-2317	-
100	-	543-2717	-	-	-	127-2317	-
100	-	556-0159	-	-	-	127-2317	-
100	-	557-1744	-	-	-	127-2317	-
100	-	563-0188	-	-	-	-	-
100	-	564-6512	-	-	-	127-2317	-
100	-	565-6342	-	-	-	127-2317	-
100	-	567-1137	-	-	-	127-2317	-
100	-	570-5378	-	-	-	127-2317	-
100/110	462-9457	-	-	-	-	-	-
110	-	-	-	547-5075	2	-	-
110	-	-	253-0105	547-5075	2	-	-
110	385-0432	-	-	-	-	-	-
110	-	533-1202	-	-	-	-	-
110	-	547-5074	-	-	-	-	-
110	-	-	-	547-5069	3	-	-
110	-	-	253-0106	547-5069	3	-	-
110	271-7295 ^x	-	-	-	-	-	-
110	476-2226	533-1192	-	-	-	-	-
110	294-2250 ^x	-	-	-	-	-	-
110	443-6261	-	-	-	-	-	-
110	287-8816 ^x	(570-5336)	-	-	-	-	-
110	362-6245 ^x	-	-	-	-	-	-
110	476-2234	528-2078	-	554-0855	1	108-1066	Corner
110	476-2234	528-2078	-	554-0855	1	108-1066	Corner
110	-	-	-	547-5073	3	-	-
110	-	-	253-0108	547-5073	3	-	-
110	-	547-5070	-	-	-	-	-

Base Edge Part Number Reference







Adapter Size	K Base Edge As	Advansys Edge As	K Conversion Edge	Advansys Conversion Edge	Conversion Edge Adapter Qty	Replacement Cut To Length Edge	Corner Adapter Style
							 Center  Corner
110	292-4035*	-	-	-	-	-	-
110	241-6717*	-	-	-	-	108-1066	-
110	258-4571*	-	253-0103	-	1	-	Corner
110	382-1131*	-	-	-	-	108-1066	-
110	260-9411*	528-2087	-	-	-	108-1066	-
110	301-6966*	-	-	-	-	-	-
110	277-3959*	-	-	-	-	108-1066	-
110	-	-	-	-	-	108-1066	-
110	469-4422	-	-	-	-	-	-
110	476-2227	533-1193	-	-	-	-	-
110	476-2235	528-2079	-	-	-	108-1066	-
110	-	-	-	547-5077	3	-	-
110	-	-	253-0112	547-5077	3	-	-
110	(420-1242)	-	-	-	-	108-1066	-
110	-	-	-	-	-	-	-
110	324-8369*	-	-	-	-	-	-
110	462-9457	-	-	-	-	-	-
110	244-3895	-	-	-	-	108-1066	-
110	258-4572*	-	-	-	-	-	-
110	-	-	-	-	-	-	-
110	-	-	-	547-5072	4	-	-
110	-	-	253-0109	547-5072	4	-	-
110	260-9413*	-	-	-	-	108-1066	-
110	-	547-5071	-	-	-	-	-
110	-	547-5076	-	-	-	-	-
110	322-4906*	-	-	-	-	108-1066	-
110	(339-5964)	-	-	-	-	-	-
110	277-3890*	-	-	-	-	-	-
110	476-2228	533-1194	-	-	-	-	-
110	476-2252	-	-	-	-	-	-
110	476-2236	528-2080	-	-	-	108-1066	-
110	362-0113	-	-	-	-	-	-
110	264-2670*	-	-	-	-	-	-
110	303-6673*	-	-	-	-	-	-
110	-	547-5080	-	-	-	-	-
110	-	547-5078	-	-	-	-	-
110	(331-0853)	-	-	-	-	-	-
110	241-6719*	-	-	-	-	108-1066	-
110	258-4573	-	253-0105	547-5075	2	-	Corner
110	286-5852*	-	-	-	-	-	-
110	(359-3038)	-	-	-	-	-	-
110	-	-	-	-	-	-	-
110	476-2229	533-1195	-	-	-	-	-
110	476-2237	528-2081	-	-	-	108-1066	-

Cat Hydraulic Excavators

BASE EDGE PART NUMBER REFERENCE TABLE







Base Edge Part Number Reference							
Adapter Size	K Base Edge As	Advansys Edge As	K Conversion Edge	Advansys Conversion Edge	Conversion Edge Adapter Qty	Replacement Cut To Length Edge	Corner Adapter Style
							 Center  Corner
110	295-0487*	-	-	-	-	-	-
110	324-5274*	-	-	-	-	-	-
110	-	-	-	-	-	-	-
110	(341-5627)	-	-	-	-	-	-
110	471-1272	-	-	-	-	-	-
110	241-6720*	-	-	554-0854	3	108-1066	Corner
110	258-4574	-	253-0106	547-5069	3	-	Corner
110	-	541-1893	-	-	-	-	-
110	-	563-0191	-	-	-	-	-
110	353-0156	-	-	-	-	-	-
110	-	532-8343	-	-	-	-	-
110	275-3257*	-	-	-	-	-	-
110	301-2891*	-	-	-	-	-	-
110	481-1241	528-2088	-	-	-	108-1066	-
110	(357-8212)	-	-	-	-	108-1066	-
110	-	532-8344	-	-	-	-	-
110	476-2254	-	-	-	-	108-1066	-
110	476-2230	533-1197	-	-	-	-	-
110	476-2255	535-7483	-	-	-	-	-
110	476-2238	528-2082	-	-	-	108-1066	-
110	476-2248	533-1196	-	-	-	-	-
110	314-9313*	-	-	-	-	108-1066	-
110	348-3116	533-1973	-	-	-	-	-
110	444-6249	-	-	-	-	-	-
110	324-0164*	-	-	-	-	-	-
110	304-8291*	-	-	-	-	108-1066	-
110	(244-3892)	-	-	-	-	108-1066	-
110	(368-3732)	-	-	-	-	-	-
110	-	532-8345	-	-	-	-	-
110	268-9958*	-	-	-	-	-	-
110	312-0734*	-	-	-	-	-	-
110	257-5354*	-	-	-	-	108-1066	-
110	257-5362*	-	-	-	-	-	-
110	(320-6538)	-	-	-	-	-	-
110	241-6721	-	-	-	-	108-1066	-
110	258-4575	-	253-0108	547-5073	3	-	Corner
110	-	532-8341	-	-	-	-	-
110	300-6198*	-	-	-	-	-	-
110	476-2224	528-2089	-	-	-	108-1066	-
110	244-3898*	-	-	-	-	108-1066	-
110	295-2014*	-	-	-	-	-	-
110	-	-	-	-	-	-	-
110	476-2257	533-1974	-	-	-	-	-
110	(389-7179)	532-8339	-	-	-	-	-

Base Edge Part Number Reference







Adapter Size	K Base Edge As	Advansys Edge As	K Conversion Edge	Advansys Conversion Edge	Conversion Edge Adapter Qty	Replacement Cut To Length Edge	Corner Adapter Style
							 Center  Corner
110	476-3429	-	-	-	-	108-1066	-
110	476-2249	532-8348	-	-	-	-	-
110	476-2239	528-2083	-	-	-	108-1066	-
110	476-2231	533-1198	-	-	-	-	-
110	399-0343*	-	-	-	-	-	-
110	455-8442	-	-	-	-	-	-
110	324-0162	-	-	-	-	-	-
110	257-5356*	-	-	-	-	108-1066	-
110	257-5364*	-	-	-	-	-	-
110	-	532-8342	-	-	-	-	-
110	274-8272*	-	-	-	-	-	-
110	266-8402*	-	-	-	-	-	-
110	266-8403	-	-	-	-	-	-
110	324-1393*	-	-	-	-	-	-
110	241-6722	-	-	-	-	108-1066	-
110	258-4576	-	253-0109	547-5072	4	-	Corner
110	260-9417**	528-2090	-	-	-	108-1066	-
110	290-2826*	-	-	-	-	-	-
110	301-8290	-	-	-	-	108-1066	-
110	318-4409*	-	-	-	-	108-1066	-
110	264-2667*	-	-	-	-	-	-
110	476-2250	532-8349	-	-	-	-	-
110	-	-	-	-	-	-	-
110	476-2244	533-1975	-	-	-	-	-
110	476-2245	535-7482	-	-	-	-	-
110	476-2232	533-1199	-	-	-	-	-
110	476-2240	528-2094	-	-	-	108-1066	-
110	(443-4440)	-	-	-	-	-	-
110	364-0067*	-	-	-	-	-	-
110	446-1246	-	-	-	-	-	-
110	359-3644	-	-	-	-	108-1066	-
110	445-0064	-	-	-	-	-	-
110	476-2253	528-2093	-	-	-	108-1066	-
110	461-5544	-	-	-	-	-	-
110	(487-7781)	-	-	-	-	-	-
110	476-3430	528-2093	-	-	-	108-1066	-
110	295-8585*	-	-	-	-	108-1066	-
110	475-4301	-	-	-	-	-	-
110	-	-	-	-	-	108-1066	-
110	425-3864	-	-	-	-	-	-
110	-	-	-	-	-	108-1066	-
110	(389-7176)	-	-	-	-	108-1066	-
110	264-5423	-	-	-	-	-	-
110	264-2668	-	-	-	-	-	-

Cat Hydraulic Excavators

BASE EDGE PART NUMBER REFERENCE TABLE







Base Edge Part Number Reference							
Adapter Size	K Base Edge As	Advansys Edge As	K Conversion Edge	Advansys Conversion Edge	Conversion Edge Adapter Qty	Replacement Cut To Length Edge	Corner Adapter Style
							 Center  Corner
110	476-2242	528-2084	-	-	-	108-1066	-
110	241-6723	-	-	-	-	108-1066	-
110	258-4577	-	-	-	-	-	-
110	(276-0023)	-	253-0112	547-5077	3	-	Corner
110	(274-1368)	-	253-0112	547-5077	3	-	Corner
110	273-1420*	-	-	-	-	-	-
110	264-2669	-	-	-	-	-	-
110	324-0059	563-0195	-	-	-	-	-
110	530-1885	-	-	-	-	-	-
110	290-2838*	-	-	-	-	-	-
110	481-1243	528-2091	-	-	-	108-1066	-
110	476-2259	-	-	-	-	108-1066	-
110	257-5358*	-	-	-	-	108-1066	-
110	319-4955*	-	-	-	-	108-1066	-
110	300-6390	-	-	-	-	108-1066	-
110	476-3431	528-2095	-	-	-	108-1066	-
110	-	532-8350	-	-	-	-	-
110	481-5344	535-7484	-	-	-	-	-
110	476-2258	528-4546	-	-	-	108-1066	-
110	476-2251	532-8350	-	-	-	-	-
110	476-2233	533-1200	-	-	-	-	-
110	314-8429*	-	-	-	-	108-1066	-
110	315-9710	-	-	-	-	108-1066	-
110	(274-1380)	-	-	-	-	-	-
110	277-6805*	-	-	-	-	108-1066	-
110	266-8404	-	-	-	-	-	-
110	311-0948	-	-	-	-	-	-
110	-	(541-1892)	-	-	-	-	-
110	476-2256	528-2096	-	-	-	108-1066	-
110	476-2241	528-2085	-	-	-	108-1066	-
110	346-3153*	-	-	-	-	-	-
110	(524-8493)	-	-	-	-	108-1066	-
110	244-3889	-	-	-	-	108-1066	-
110	311-1854*	-	-	-	-	108-1066	-
110	(490-0724)	-	-	-	-	-	-
110	469-4311	528-2092	-	-	-	108-1066	-
110	476-2225	-	-	-	-	108-1066	-
110	(337-5333)	-	-	-	-	108-1066	-
110	331-1864*	-	-	-	-	108-1066	-
110	273-1421	-	-	-	-	-	-
110	(269-6372)	-	-	-	-	108-1066	-
110	275-5774*	-	-	-	-	108-1066	-
110	295-0443*	-	-	-	-	-	-
110	328-3157*	-	-	-	-	-	-

Base Edge Part Number Reference

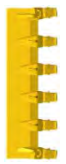





Adapter Size	K Base Edge As	Advansys Edge As	K Conversion Edge	Advansys Conversion Edge	Conversion Edge Adapter Qty	Replacement Cut To Length Edge	Corner Adapter Style
							 Center  Corner
110	-	-	-	-	-	108-1066	-
110	476-2243	528-2086	-	-	-	108-1066	-
110	292-5767*	-	-	-	-	108-1066	-
110	361-4583*	-	-	-	-	-	-
110	-	547-5081	-	-	-	-	-
110	-	-	-	-	1	-	-
110	-	-	253-0103	-	1	-	-
110	-	-	-	-	-	108-1066	-
110	297-5917	-	-	-	-	-	-
110	378-0615*	-	-	-	-	-	-
110	(361-2324)	-	-	-	-	-	-
110	(383-3292)	-	-	-	-	108-1066	-
110	332-9159*	-	-	-	-	-	-
110	281-7649	-	-	-	-	108-1066	-
110	260-9414*	-	-	554-0854	3	108-1066	Center
110	271-7296*	-	-	-	-	-	-
110	273-1331*	-	-	-	-	-	-
110	271-7298*	-	-	-	-	-	-
110	290-2808*	-	-	-	-	-	-
110	310-2006*	-	-	-	-	108-1066	-
110	282-7810*	-	-	-	-	108-1066	-
110	277-3961*	-	-	-	-	108-1066	-
110	275-5772*	-	-	-	-	108-1066	-
110	305-2867	-	-	-	-	-	-
110	271-7297*	-	-	-	-	-	-
110	357-8194*	-	-	-	-	108-1066	-
110	-	544-2722	-	-	-	108-1066	-
110	-	544-2723	-	-	-	108-1066	-
110	-	-	-	554-0854	3	108-1066	-
110	-	-	-	554-0855	1	108-1066	-
110	-	575-5247	-	-	-	-	-
130	(365-7272)	-	-	-	-	-	-
130	273-1430	540-4032	-	-	-	-	-
130	265-3376*	556-7895 257-1753	535-6640	4	6I-5303	Corner	-
130	265-3376*	556-7895 257-1753	535-6640	4	6I-5303	Corner	-
130	357-0977*	-	-	-	-	-	-
130	260-1256	566-9372	-	-	-	-	-
130	265-3400	550-4397	-	-	-	-	-
130	260-1257*	-	-	-	-	-	-
130	253-9075*	-	-	-	-	-	-
130	260-1254*	568-8830	-	-	-	-	-
130	274-8285*	566-1848	-	-	-	-	-
130	276-8732*	568-8845	-	-	-	-	-
130	256-9465*	566-9373	-	-	-	-	-

Cat Hydraulic Excavators

BASE EDGE PART NUMBER REFERENCE TABLE







Base Edge Part Number Reference							
Adapter Size	K Base Edge As	Advansys Edge As	K Conversion Edge	Advansys Conversion Edge	Conversion Edge Adapter Qty	Replacement Cut To Length Edge	Corner Adapter Style
							 Center  Corner
130	273-1424*	-	-	-	-	-	-
130	260-1255*	-	-	-	-	-	-
130	273-1429	550-8875	-	-	-	-	-
130	273-1409	550-4399	-	-	-	-	-
130	273-1425*	550-8871	-	-	-	-	-
130	(276-0013)	-	-	-	-	-	-
130	301-2987*	-	-	-	-	-	-
130	253-9076*	-	-	-	-	-	-
130	273-1428	550-8868	-	-	-	-	-
130	-	532-2964	-	-	-	-	-
130	-	-	-	-	-	-	-
130	-	-	-	-	-	-	-
130	-	-	-	-	-	6I-5303	-
130	362-5049	517-2365	-	-	-	6I-5303	-
130	484-0392	-	-	-	-	6I-5303	-
130	484-0381	517-2359	-	-	-	6I-5303	-
130	484-0410	553-5216	-	-	-	-	-
130	484-0404	517-2367	-	-	-	-	-
130	480-3495	-	-	-	-	6I-5303	-
130	484-0382	517-2360	-	-	-	6I-5303	-
130	484-0403	518-9272	-	-	-	-	-
130	484-0379	517-2364	-	-	-	6I-5303	-
130	484-0394, 419-5463*	517-2366	-	-	-	-	-
130	315-3488*	-	-	-	-	6I-5303	-
130	484-0380	517-2358	-	-	-	6I-5303	-
130	-	523-5769	-	-	-	6I-5303	-
130	484-0383	517-2361	-	-	-	6I-5303	-
130	484-0385	517-2376	-	-	-	-	-
130	484-0407	517-2371	-	-	-	-	-
130	380-1588	517-2357 368-3678*	566-9350	4	6I-5303	Corner	-
130	494-1950	517-2357 368-3678*	566-9350	4	6I-5303	Corner	-
130	480-6037	-	-	-	-	-	-
130	484-0406	517-2372	-	-	-	-	-
130	484-0388	517-2362	-	-	-	6I-5303	-
130	484-0409	-	-	-	-	6I-5303	-
130	484-8408	-	-	-	-	-	-
130	484-0389	517-2370	-	-	-	6I-5303	-
130	484-0395	568-3343	-	-	-	-	-
130	484-0396	517-2374	-	-	-	-	-
130	-	-	-	-	-	-	-
130	317-7866	-	368-3739*	-	3	6I-5303	Corner
130	317-7866	-	368-3739*	-	3	6I-5303	Corner
130	484-0387	517-2369	-	-	-	-	-
130	484-0384	517-2375	-	-	-	-	-
130	484-0393	517-2373	-	-	-	6I-5303	-

Base Edge Part Number Reference







Adapter Size	K Base Edge As	Advansys Edge As	K Conversion Edge	Advansys Conversion Edge	Conversion Edge Adapter Qty	Replacement Cut To Length Edge	Corner Adapter Style
							 Center  Corner
130	341-5688*	-	-	-	-	6I-5303	-
130	484-0390	517-2363	-	-	-	6I-5303	-
130	-	519-2242	-	-	-	6I-5303	-
130	484-0397	-	-	-	-	-	-
130	484-0391	-	-	-	-	6I-5303	-
130	-	-	-	-	-	6I-5303	-
130	484-0405	525-4059	-	-	-	-	-
130	484-0386	517-2368	-	-	-	-	-
130	257-1755	547-5085	-	-	-	6I-5303	-
130	-	-	-	-	-	-	-
130	257-1752	538-9163	-	-	-	6I-5303	-
130	-	-	253-0128	535-6639	3	6I-5303	-
130	-	-	253-0128	535-6639	3	6I-5303	-
130	253-0127	547-5084	-	-	-	6I-5303	-
130	-	-	257-1753	535-6640	4	6I-5303	-
130	-	-	257-1753	535-6640	4	6I-5303	-
130	253-0126*	550-8874	-	-	-	6I-5303	-
130	-	382-1840*	-	-	-	6I-5303	-
130	-	382-1854*	-	-	-	-	-
130	-	517-2356	-	-	-	6I-5303	-
130	-	519-2243	-	-	-	6I-5303	-
130	-	523-3399	-	-	-	6I-5303	-
130	-	518-9276	-	-	-	-	-
130	309-7545*	-	-	-	-	-	-
130	438-7883*	-	-	-	-	-	-
130	425-3891	573-9436	-	-	-	-	-
130	(331-0853)	-	-	-	-	-	-
130	291-1926*	-	-	-	-	-	-
130	423-0586	(570-5334)	-	-	-	-	-
130	279-9974*	-	-	-	-	6I-5303	-
130	318-4461*	-	-	-	-	-	-
130	373-6825	572-3053	-	-	-	-	-
130	-	-	368-3739*	-	3	6I-5303	-
130	256-9466*	-	-	-	-	-	-
130	277-8478*	-	-	-	-	6I-5303	-
130	373-6888	-	-	-	-	6I-5303	-
130	277-8489*	-	-	-	-	6I-5303	-
130	279-9975*	-	-	-	-	6I-5303	-
130	273-1422*	-	-	-	-	-	-
130	423-2332	532-2965	-	-	-	-	-
130	394-5251	-	-	-	-	6I-5303	-
130	279-9972*	-	-	-	-	6I-5303	-
130	346-3165*	-	-	-	-	-	-
130	282-8936*	-	-	-	-	-	-

Cat Hydraulic Excavators

BASE EDGE PART NUMBER REFERENCE TABLE







Base Edge Part Number Reference							
Adapter Size	K Base Edge As	Advansys Edge As	K Conversion Edge	Advansys Conversion Edge	Conversion Edge Adapter Qty	Replacement Cut To Length Edge	Corner Adapter Style
							 Center  Corner
130	321-3957*	-	-	-	-	-	-
130	253-9077*	-	-	-	-	-	-
130	457-7613	-	-	-	-	6I-5303	-
130	353-0093	566-9371	-	-	-	6I-5303	-
130	279-9971*	-	-	-	-	6I-5303	-
130	460-5864	-	-	-	-	6I-5303	-
130	334-9152*	-	-	-	-	6I-5303	-
130	350-1915*	-	-	-	-	-	-
130	277-5913*	-	-	-	-	-	-
130	279-9973*	566-1849	-	-	-	6I-5303	-
130	338-7682	-	-	-	-	6I-5303	-
130	353-0080*	-	-	-	-	6I-5303	-
130	320-1413*	-	-	-	-	6I-5303	-
130	(373-6873)	-	-	-	-	6I-5303	-
130	277-4814*	-	-	-	-	-	-
130	(328-3126)	-	-	-	-	6I-5303	-
130	297-6066*	-	-	-	-	6I-5303	-
130	-	-	368-3678*	566-9350	4	6I-5303	-
130	293-4349*	-	-	-	-	-	-
130	324-8282*	-	-	-	-	-	-
130	323-6420*	(576-7437)	-	-	-	6I-5303	-
130	(368-3708)	-	-	-	-	6I-5303	-
130	357-8234*	-	-	-	-	6I-5303	-
130	265-3398	550-4394	-	-	-	-	-
130	(368-3695)	-	-	-	-	6I-5303	-
130	273-0962*	-	-	-	-	6I-5303	-
130	279-9976	550-4393	-	-	-	6I-5303	-
130	357-8172*	-	-	-	-	6I-5303	-
130	328-3166*	-	-	-	-	6I-5303	-
130	456-4667	553-0056	-	556-7888	3	6I-5303	Center
130	312-0418*	-	-	-	-	6I-5303	-
130	273-1431*	-	-	-	-	-	-
130	361-2313*	-	-	-	-	6I-5303	-
130	425-3865	573-9435	-	-	-	-	-
130	433-8116	(573-9437)	-	-	-	-	-
130	420-3384	568-8866	-	-	-	6I-5303	-
130	311-0130*	-	-	-	-	6I-5303	-
130	437-1844	573-9439	-	-	-	-	-
130	452-5058	-	-	-	-	-	-
130	-	528-9655	-	-	-	6I-5303	-
130	-	538-9149	-	-	-	-	-
130	-	540-3532	-	-	-	6I-5303	-
130	-	540-3534	-	-	-	6I-5303	-
130	-	540-3536	-	-	-	6I-5303	-

Base Edge Part Number Reference

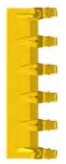





Adapter Size	K Base Edge As	Advansys Edge As	K Conversion Edge	Advansys Conversion Edge	Conversion Edge Adapter Qty	Replacement Cut To Length Edge	Corner Adapter Style
							 Center  Corner
130	-	541-8811	-	-	-	-	-
130	-	543-4779	-	-	-	-	-
130	-	545-8954	-	-	-	-	-
130	-	-	-	-	-	-	-
130	-	-	-	-	-	-	-
130	361-2302*	-	-	-	-	6I-5303	-
130	-	553-5217	-	-	-	6I-5303	-
130	-	-	-	556-7888	3	6I-5303	-
130	-	561-2665	-	-	-	6I-5303	-
130	-	563-2903	-	-	-	6I-5303	-
130	-	566-1813	-	-	-	-	-
130	-	566-1847	-	-	-	-	-
130	-	568-0431	-	-	-	-	-
130	-	568-6996	-	-	-	-	-
130	-	568-6998	-	-	-	-	-
130	-	568-0429	-	-	-	6I-5303	-
130	-	568-0430	-	-	-	6I-5303	-
130	-	570-5305	-	-	-	6I-5303	-
130	-	570-5356	-	-	-	-	-
130	-	570-5357	-	-	-	-	-
130	-	568-0404	-	-	-	-	-
150	-	-	-	-	-	-	-
150	-	-	-	-	-	-	-
150	485-8387	519-5372	-	-	-	-	-
150	-	547-5088	-	-	-	-	-
150	485-8390	519-5376	-	-	-	-	-
150	485-8388	519-5383	-	-	-	-	-
150	485-8392	519-5373	-	-	-	-	-
150	-	547-5087	-	-	-	-	-
150	485-8386	519-5381	-	-	-	-	-
150	-	550-4396	-	-	-	-	-
150	485-8664	572-3052	-	-	-	-	-
150	485-8391	519-5385	-	-	-	-	-
150	-	568-8837	-	-	-	-	-
150	485-8663	519-5384	-	-	-	-	-
150	-	566-9364	-	-	-	-	-
150	-	550-4401	-	-	-	-	-
150	-	-	-	-	-	-	-
150	485-8385	519-5375	-	-	-	-	-
150	485-8389	519-5374	-	-	-	-	-
150	-	568-8838	-	-	-	-	-
150	485-8383	519-5382	-	-	-	-	-
150	-	-	-	-	-	-	-
150	485-8448	519-5379	-	-	-	-	-

Cat Hydraulic Excavators

BASE EDGE PART NUMBER REFERENCE TABLE







Base Edge Part Number Reference							
Adapter Size	K Base Edge As	Advansys Edge As	K Conversion Edge	Advansys Conversion Edge	Conversion Edge Adapter Qty	Replacement Cut To Length Edge	Corner Adapter Style
							 Center  Corner
150	485-8384	543-2774	-	-	-	-	-
150	318-9416 ^x	-	-	-	-	-	-
150	-	-	-	-	-	-	-
150	-	(553-5218)	-	-	-	-	-
150	485-8393	519-5377	-	-	-	-	-
150	437-1790	519-5380	-	-	-	-	-
150	340-6403*	-	-	-	-	-	-
150	302-0537 ^x	-	-	-	-	-	-
150	437-1784	553-5224	-	-	-	-	-
150	293-6381	569-4911	-	-	-	-	-
150	312-0425 ^x	-	-	-	-	119-3174	-
150	442-8444	573-9441	-	-	-	-	-
150	297-6155 ^x	-	-	-	-	-	-
150	340-6407*	(569-5964)	-	-	-	-	-
150	270-8240	(566-9351)	-	-	-	119-3174	-
150	323-6140*	-	-	-	-	-	-
150	260-1158	550-8869	-	-	-	-	-
150	340-6401 ^x	-	-	-	-	-	-
150	301-7694 ^x	-	-	-	-	-	-
150	-	-	-	-	-	-	-
150	346-3113*	566-9367	-	-	-	-	-
150	260-1245	553-5222	-	-	-	119-3174	-
150	304-3609*	569-5966	-	-	-	119-3174	-
150	308-6215 ^x *	-	-	-	-	-	-
150	-	-	466-3070	-	4	-	-
150	328-3172 ^x	-	-	-	-	-	-
150	270-8241*	568-8842	-	-	-	119-3174	-
150	260-1247	566-9378	-	-	-	-	-
150	452-5058	-	-	-	-	-	-
150	260-1242	550-4403	361-2315*	568-8844	3	119-3174	Corner
150	319-6456 ^x	-	-	-	-	-	-
150	346-3116*	568-8867	-	-	-	-	-
150	322-7626 ^x	-	-	-	-	-	-
150	(359-3052)	-	-	-	-	-	-
150	289-0766 ^x	-	-	-	-	-	-
150	293-6380 ^x	-	-	-	-	-	-
150	340-6394 ^x	-	-	-	-	-	-
150	440-3721	-	-	-	-	-	-
150	260-1253*	550-8866	-	-	-	-	-
150	317-9480 ^x	-	-	-	-	-	-
150	276-6147 ^x	-	-	-	-	-	-
150	333-8857*	-	-	-	-	-	-
150	283-5598 ^x	-	-	-	-	-	-
150	-	-	-	-	-	-	-

Base Edge Part Number Reference

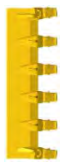





Adapter Size	K Base Edge As	Advansys Edge As	K Conversion Edge	Advansys Conversion Edge	Conversion Edge Adapter Qty	Replacement Cut To Length Edge	Corner Adapter Style
							 Center  Corner
150	297-5952*	-	466-3070	-	4	-	Corner
150	293-6383	540-4030	-	-	-	-	-
150	270-8239*	568-8841	-	-	-	119-3174	-
150	329-1977*	-	-	-	-	-	-
150	340-6406*	-	-	-	-	-	-
150	331-4276*	-	-	-	-	-	-
150	286-5256*	-	-	-	-	-	-
150	(479-1629)	-	-	-	-	-	-
150	340-6397*	-	-	-	-	-	-
150	(416-6431)	-	-	-	-	-	-
150	-	-	361-2315*	568-8844	3	119-3174	-
150	340-6398*	-	-	-	-	-	-
150	260-1243	550-4400	-	-	-	119-3174	-
150	340-6396*	-	-	-	-	-	-
150	260-1244	566-9376	-	-	-	119-3174	-
150	311-7864*	-	-	-	-	-	-
150	293-7253*	-	-	-	-	-	-
150	340-6395*	-	-	-	-	-	-
150	294-4355*	-	-	-	-	-	-
150	388-7673	553-5226	-	-	-	-	-
150	238-3179*	-	-	-	-	-	-
150	329-1974*	-	-	-	-	-	-
150	276-5961*	-	-	-	-	-	-
150	437-1820	(572-9990)	-	-	-	-	-
150	(334-3402)	-	-	-	-	-	-
150	302-9049*	-	-	-	-	-	-
150	260-1246*	566-9377	-	-	-	-	-
150	260-1252	566-9380	-	-	-	-	-
150	340-6408*	-	-	-	-	-	-
150	274-1384*	-	-	-	-	-	-
150	390-6060	-	-	-	-	-	-
150	329-1975*	568-8835	-	-	-	-	-
150	470-7875	532-2966	-	-	-	-	-
150	300-9757*	-	-	-	-	119-3174	-
150	329-1976*	-	-	-	-	-	-
150	284-3396*	-	-	-	-	-	-
150	300-5043*	-	-	-	-	119-3174	-
150	260-1250	550-8870	-	-	-	-	-
150	293-6382	553-5215	-	-	-	-	-
150	359-2979*	-	-	-	-	-	-
150	260-1248	553-5223	-	-	-	-	-
150	260-1251	553-5220	-	-	-	-	-
150	313-5702*	-	-	-	-	-	-
150	(369-4452)	-	-	-	-	119-3174	-

Cat Hydraulic Excavators

BASE EDGE PART NUMBER REFERENCE TABLE







Base Edge Part Number Reference							
Adapter Size	K Base Edge As	Advansys Edge As	K Conversion Edge	Advansys Conversion Edge	Conversion Edge Adapter Qty	Replacement Cut To Length Edge	Corner Adapter Style
							 Center  Corner
150	284-4894*	-	-	-	-	-	-
150	260-1249*	566-9379	-	-	-	-	-
150	322-6075*	-	-	-	-	-	-
150	260-1241	532-2967	-	-	-	119-3174	-
150	-	519-5386	-	-	-	-	-
150	-	527-5502	-	-	-	-	-
150	-	538-9157	-	-	-	-	-
150	-	541-8813	-	-	-	-	-
150	-	543-4780	-	-	-	-	-
150	-	558-7886	-	-	-	-	-
150	-	-	-	-	-	-	-
150	308-6215*	-	-	-	-	-	-
150	338-7675*	-	-	-	-	-	-
150	-	553-0049	-	-	-	-	-
150	-	(565-6321)	-	-	-	-	-
150	-	569-4908	-	-	-	-	-
150	-	(573-9440)	-	-	-	-	-
170	-	-	-	-	-	-	-
170	-	-	-	-	-	-	-
170	-	550-8865	-	-	-	-	-
170	360-6142	532-2970	-	-	-	-	-
170	491-6787	519-5453	-	-	-	-	-
170	491-6792	519-5445	-	-	-	-	-
170	-	-	-	-	-	211-2757	-
170	-	568-8870	-	-	-	-	-
170	491-6795	519-5451	-	-	-	-	-
170	491-6786	519-5448	-	-	-	211-2757	-
170	-	523-9782	-	-	-	-	-
170	-	568-8109	-	-	-	-	-
170	491-6799	550-4402	-	-	-	211-2757	-
170	491-6791	568-8869	-	-	-	-	-
170	491-6785	519-5447	-	-	-	211-2757	-
170	-	568-8108	-	-	-	-	-
170	491-6789	519-5454	-	-	-	-	-
170	491-6794	519-5449	-	-	-	-	-
170	491-6793	519-5446	-	-	-	-	-
170	-	568-8847	-	-	-	-	-
170	491-6788	-	-	-	-	-	-
170	491-6797	519-5456	-	-	-	211-2757	-
170	360-6120	532-2969	-	-	-	211-2757	-
170	491-6790	519-5455	-	-	-	-	-
170	-	-	-	-	-	-	-
170	-	566-9365	-	-	-	211-2757	-
170	-	-	-	-	-	211-2757	-

Base Edge Part Number Reference







Adapter Size	K Base Edge As	Advansys Edge As	K Conversion Edge	Advansys Conversion Edge	Conversion Edge Adapter Qty	Replacement Cut To Length Edge	Corner Adapter Style
							 Center  Corner
170	-	568-6617	-	-	-	-	-
170	-	-	-	-	-	211-2757	-
170	-	566-9366	-	-	-	-	-
170	-	-	-	-	-	-	-
170	-	568-8868	-	-	-	-	-
170	-	-	-	-	-	-	-
170	-	-	-	-	-	211-2757	-
170	-	-	-	-	-	-	-
170	-	-	-	-	-	-	-
170	-	522-2046	-	-	-	-	-
170	-	482-6300	-	-	-	-	-
170	-	519-5450	-	-	-	-	-
170	-	519-5452	-	-	-	-	-
170	-	519-5457	-	-	-	211-2757	-
170	-	519-5458	-	-	-	-	-
170	-	528-9656	-	-	-	-	-
170	-	-	-	-	-	211-2757	-
170	251-7062*	-	-	-	-	211-2757	-
170	257-1814*	-	-	-	-	-	-
170	260-1258	540-4031	-	-	-	211-2757	-
170	260-1259*	568-8831	-	-	-	211-2757	-
170	313-8817**	-	-	-	-	-	-
170	315-5319	-	-	-	-	-	-
170	314-2859	568-8832	-	-	-	-	-
170	314-2858	-	-	-	-	-	-
170	260-1264	550-4395	-	-	-	-	-
170	260-1265	550-4398	-	-	-	-	-
170	260-1266	(566-1814)	-	-	-	-	-
170	267-5392*	-	-	-	-	-	-
170	267-5402*	543-4777	-	-	-	-	-
170	270-3715	550-8867	-	-	-	211-2757	-
170	282-8926*	-	-	-	-	-	-
170	293-6392*	566-1850	-	-	-	-	-
170	296-7430*	-	-	-	-	-	-
170	297-5947*	569-4914	-	-	-	-	-
170	297-6011*	-	-	-	-	211-2757	-
170	297-9991*	569-5957	-	-	-	-	-
170	299-6150*	-	-	-	-	-	-
170	300-5943*	-	-	-	-	211-2757	-
170	302-6481*	-	-	-	-	211-2757	-
170	311-1821*	-	-	-	-	211-2757	-
170	313-8817**	568-8836	-	-	-	-	-
170	314-2858	550-4405	-	-	-	-	-
170	315-5319	566-9349	-	-	-	-	-

Cat Hydraulic Excavators

BASE EDGE PART NUMBER REFERENCE TABLE

Base Edge Part Number Reference							
Adapter Size	K Base Edge As	Advansys Edge As	K Conversion Edge	Advansys Conversion Edge	Conversion Edge Adapter Qty	Replacement Cut To Length Edge	Corner Adapter Style
							 Center  Corner
170	321-7551*	-	-	-	-	-	-
170	323-6446*	-	-	-	-	211-2757	-
170	325-5395*	-	-	-	-	-	-
170	330-6958*	-	-	-	-	-	-
170	330-6967*	-	-	-	-	211-2757	-
170	334-9205*	-	-	-	-	-	-
170	338-8669*	(569-5963)	-	-	-	-	-
170	343-6515*	-	-	-	-	-	-
170	(354-8528)	-	-	-	-	-	-
170	(358-2664)	-	-	-	-	211-2757	-
170	378-1113*	572-3055	-	-	-	-	-
170	379-2225*	568-8863	-	-	-	211-2757	-
170	(390-8334)	-	-	-	-	211-2757	-
170	(456-4240)	547-3352	-	-	-	-	-
170	461-7851	566-9370	-	-	-	-	-
170	(466-1826)	-	-	-	-	-	-
170	466-3065	528-9657	-	-	-	211-2757	-
170	(481-9626)	-	-	-	-	-	-
170	484-1311	-	-	-	-	-	-
170	500-1188	-	-	-	-	-	-
170	-	538-2276	-	-	-	211-2757	-
170	362-5345*	-	-	-	-	-	-
170	362-5345*	-	-	-	-	-	-
170	-	551-2809	-	-	-	-	-
170	-	556-7894	-	-	-	-	-
170	-	557-4695	-	-	-	-	-
170	-	547-3351	-	-	-	-	-
170	-	568-8107	-	-	-	211-2757	-
170	-	569-4916	-	-	-	211-2757	-
170	-	568-8860	-	-	-	211-2757	-
J800/200	492-3846	-	-	-	-	-	-
J800/200	379-3119	-	-	-	-	-	-
J800/200	465-7903	-	-	-	-	-	-
J800/200	(390-8341)	-	-	-	-	-	-
J800/200	440-1584	-	-	-	-	-	-
J800/200	(416-6439)	-	-	-	-	-	-
J800/200	447-6965	-	-	-	-	-	-
J800/200	394-7027	-	-	-	-	-	-
J800/200	365-5814*	-	-	-	-	-	-
J800/200	425-9690	-	-	-	-	-	-
J800/200	396-3017	-	-	-	-	-	-
J800/200	368-3656	-	-	-	-	-	-
J800/200	(373-6787)	-	-	-	-	-	-
J800/200	377-5784*	-	-	-	-	-	-

Base Edge Part Number Reference

Adapter Size	K Base Edge As	Advansys Edge As	K Conversion Edge	Advansys Conversion Edge	Conversion Edge Adapter Qty	Replacement Cut To Length Edge	Corner Adapter Style
							 Center  Corner
J800/200	(547-8405)	-	-	-	-	-	-
J800/200	(433-8882)	-	-	-	-	-	-
J800/200	365-2889*	-	-	-	-	-	-

Cat Hydraulic Excavators

OPTIONS

CAT ADVANSYS™ TIP OPTIONS

Below are the tip shapes best suited for the wide range of jobsite conditions performed by large hydraulic excavators. We also offer additional Cat Advansys™ tips more commonly used with wheel loaders. Your Cat dealer can help you choose the one that offers the right balance of penetration and wear life for your application.

ABRASION

HEAVY DUTY

A.R.M.
OPTION
AVAILABLE



Heavy Duty and Heavy Duty A.R.M.* tips include approximately 60 percent more wear material in the tip body. The A.R.M. wears around the profile to increase penetration.

GENERAL PURPOSE



General Purpose tips are symmetrical and the baseline for other tip styles. All wear comparisons are to the General Purpose tip unless otherwise noted.

GENERAL PURPOSE



General Purpose Excavator for 110 size and down have been designed to maintain wear material and support material where it is needed, while wearing sharp for better penetration.

WIDE



Wide tips are used to maintain smooth trench floors and in low-abrasion, easy-to-penetrate material.

PENETRATION PLUS



Penetration Plus tips feature 25 percent more wear material and a leading edge with 25 percent less cross-sectional area. They self-sharpen as they wear.

PENETRATION

A.R.M.
OPTION
AVAILABLE



Penetration tips are ideal for densely compacted materials. They feature a leading edge with 60 percent less cross-sectional area—allowing for maximum penetration—and a single center rib that self-sharpens as it wears. These tips are available with A.R.M.*

SPIKE



Spike tips are used to achieve maximum penetration. They are typically used in cohesive material and stay sharp during the life of the tip.

DOUBLE SPIKE











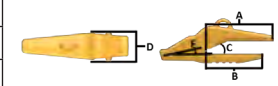

Double Spike tips are used in the corner positions with the spike tips for hard-to-penetrate, fracturable materials.

IMPACT

*Abrasion Resistant Material (A.R.M.) is a welding process that bonds very hard tungsten carbide particles to Cat G.E.T. to create a protective shield over the component. Typically, the A.R.M. process doubles wear life and can last even longer in some applications.

Cat Advansys[™] 70 Series - Base Edge Thickness: 32mm

Machine Model: 311 - 315

Adapters									
Type	Part Number	Edge Thickness	A (mm)	B (mm)	C (deg)	D (mm)	E (deg)	Weight (kg)	Notes
Center 2-Strap	539-5710	32	122	161.7	22.5	67.6	9	4.41	
RH 2 Strap Corner (5 degrees)	539-5711	32	101.2	171	22.5	71.6	9	4.56	
LH 2 Strap Corner (5 degrees)	539-5712	32	101.2	171	22.5	71.6	9	4.56	
Tips									
Type	Part Number	Dimensions (mm)			Weight (kg)	Retainer and Sleeve	Notes		
	Aggregate 539-5776	A	B	C	4.92	Retainer: 516-9166 Sleeve: 516-9165	 <p>*Overall Width 165 mm</p>		
	General Duty 539-5678	229.3	41.4	71.2	4.09				
	Wide 539-5670	215.9	37.6	71.2	4.36				
	Penetration Plus 539-5673	213.8	113.2	71.2	4.18				
	Penetration 539-5677	228.6	49.7	71.2	4.18				
	Double Spike 539-5675	217.1	13.3	71.2	3.43				
	Heavy Abrasion 539-5771	220.4	103.2	71.2	4.26				
	Aggregate Long Life (ARM) 539-5777	222.4	109.7	71.2	5.28	Retainer: 516-9166 Sleeve: 516-9165	The black areas in the pictures of the tips is where the ARM will be applied.		
Hardware									
Type	Quantity				Part Number				
LH/RH Rear Bolts	2 Per Adapter				4F-4042				
LH/RH Front Bolts	2 Per Adapter				4J-9058				
LH/RH Nuts	4 Per Adapter				2J-3507				
CTR Bolts	2 Per Adapter				8J-2928				
CTR Nuts	2 Per Adapter				8J-2933				

*Note Some of the 70 Series tip options have been redesigned vs their J-Series counterparts. Some profiles have been combined to improve performance for machines in this class. The reference below illustrates the length and weight differences to help with tip selection.

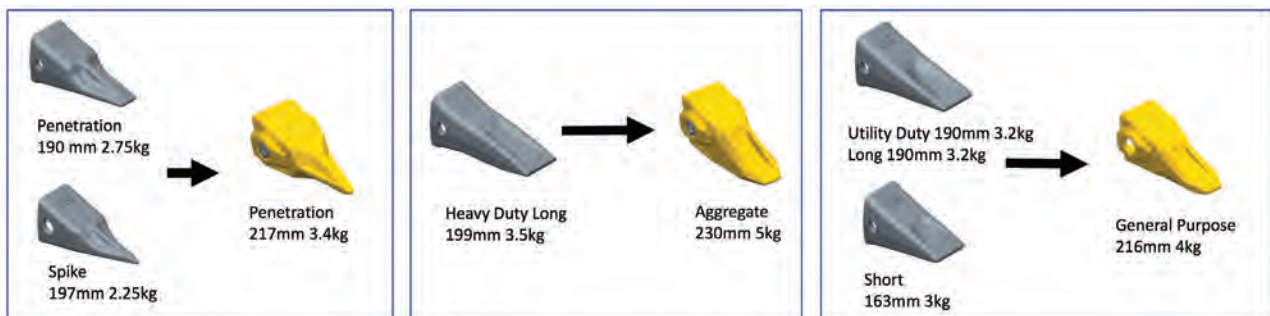

Cat Advansys™ 80 Series - Base Edge Thickness: 36mm

Machine Model: 315D, 316E/F, 318C/E/F, 319D, 320E/F, 321D, 323F, M322D/F

Adapters												
Type	Part Number	Edge Thickness	A (mm)	B (mm)	C (deg)	D (mm)	E (deg)	Weight (kg)	Notes			
Center 2-Strap	505-4130	36	150.5	210.4	22.5	91.8	12.66	9.6				
RH 2 Strap Corner (5 degrees)	505-4131	36	112	190	22.5	105	12.66	10.4				
LH 2 Strap Corner (5 degrees)	505-4132	36	112	190	22.5	105	12.66	10.4				
Tips												
Type	Part Number	Dimensions (mm)			Weight (kg)	Retainer and Sleeve	Notes					
		A	B	C								
	Heavy Duty 505-3982	288	55	91.5	7.89	Retainer: 516-9166 Sleeve: 516-9165	    *Overall Width 113.4 mm					
	General Purpose 505-4086	266	49	91.5	6.92							
	Wide 505-4080	266	149.4	91.5	7.66							
	Penetration Plus 505-4083	286	62	91.5	7.56							
	Penetration 505-4081	266	16.2	91.5	6.22							
	Spike 505-4084	297	14.8	91.5	6.66							
	Double Spike 505-4085	297	8.7	91.5	7.55							
Specialty												
	Heavy Duty Long Life (ARM) 505-3983	288	55	91.5	8.19	Retainer: 516-9166 Sleeve: 516-9165	The black areas in the pictures of the tips is where the ARM will be applied.					
	Penetration Long Life (ARM) 505-4082	266	62	91.5	6.31							
	Leveling Edge Conversion 505-3985	169	83.2	91.5	5.77							
Wear Protection												
Type	Machine	Part Number	Bolts	Nuts	Washer	Retainer / Pin	Qty.	Notes				
HEX Sidebar Protector	320-336	329-5958	N/A	N/A	N/A	132-0999/275-5982	2	Hex Sidebar Protector uses shear block 330-2174.				
GP Sidecutter, RH	315-319	357-2714	8T-0664	7X-0851	N/A	N/A	8					
GP Sidecutter, LH		357-2713										
GP Sidecutter, RH	320-336	7Y-0357	6I-6371	2J-3507	N/A	N/A	6					
GP Sidecutter, LH		7Y-0358										
HD Sidecutter, RH	320-336	522-6333	6I-6371	2J-3507	3K-5234	N/A	8					
HD Sidecutter, LH		522-6334										

Cat Advansys™ 90 Series - Base Edge Thickness: 40mm

Machine Model: 315D, 316E/F, 318E/F, 320E/F, 321D, 323F, M322D/F, 324E, 326F, 328D, 329E/F, 330F









Adapters										
Type	Part Number	Edge Thickness	*A (mm)	B (mm)	C (deg)	D (mm)	E (deg)	Weight (kg)	Notes	
Center 2-Strap	505-4140	40	192	234	22.5	98	11.01	12.1		
RH 2 Strap Corner (5 degrees)	505-4141	40	133	219	22.5	120	11.01	12.7		
LH 2 Strap Corner (5 degrees)	505-4142	40	133	219	22.5	120	11.01	12.7		
Tips										
Type	Part Number	Dimensions (mm)			Weight (kg)	Retainer and Sleeve	Notes			
 Heavy Duty	505-3996	A	B	C	10.23	Retainer: 516-9168 Sleeve: 516-9167	    *Overall Width 142.6 mm	The black areas in the pictures of the tips is where the ARM will be applied.		
 General Purpose	505-4096	307	68	104	9.02					
 Wide	505-4090	295	172	104	10.77					
 Penetration Plus	505-4097	306	58	104	10.46					
 Penetration	505-4091	295	19	104	8.40					
 Spike	505-4098	327	19.6	104	8.92					
 Double Spike	505-4095	327	16.3	104	10.46					
Specialty										
 Heavy Duty Long Life (ARM)	505-3993	307	68	104	10.60	Retainer: 516-9168 Sleeve: 516-9167	The black areas in the pictures of the tips is where the ARM will be applied.			
 Penetration Long Life (ARM)	505-4092	295	19	104	8.48					
 Leveling Edge Conversion	505-3995	182	97	104	7.23					
Wear Protection										
Type	Machine	Part Number	Bolts	Nuts	Washer	Retainer / Pin	Qty.	Notes		
HEX Sidebar Protector	320-336	329-5958	N/A	N/A	N/A	132-0999/275-5982	2	Hex Sidebar Protector uses shear block 330-2174.		
GP Sidecutter, RH	315-319	357-2714	8T-0664	7X-0851	N/A	N/A	8			
GP Sidecutter, LH		357-2713								
GP Sidecutter, RH	320-336	7Y-0357	6I-6371	2J-3507	N/A	N/A	6			
GP Sidecutter, LH		7Y-0358								
HD Sidecutter, RH	320-336	522-6333	6I-6371	2J-3507	3K-5234	N/A	8			
HD Sidecutter, LH		522-6334								

Cat Hydraulic Excavators

PART NUMBERS



Cat Advansys™ 100 Series - Base Edge Thickness: 45mm

Machine Models: 324E, 326F, 328D, 329E/F, 330F, 336E/F, 324E-ME, 326F-ME, 329E/F-ME

Adapters									
Type	Part Number	Edge Thickness	A (mm)	B (mm)	C (deg)	D (mm)	E (deg)	Weight (kg)	Notes
Center 2-Strap	505-4150	45	188	245	22.5	109	11.1	14.7	
RH 2 Strap Corner (5 degrees)	505-4151	45	147	226	22.5	130	11.1	15.0	
LH 2 Strap Corner (5 degrees)	505-4152	45	147	226	22.5	130	11.1	15.0	
Tips									
Type	Part Number	Dimensions (mm)			Weight (kg)	Retainer and Sleeve	Notes		
		A	B	C					
	Heavy Duty 505-4002	335	74	109	13.2	Retainer: 516-9168 Sleeve: 516-9167	    CapSure Plug 523-9811 *Overall width 165 mm		
	General Purpose 505-4106	323	50	109	11.4				
	Wide 505-4100	322	205	109	13.9				
	Penetration Plus 505-4103	335	72	109	12.5				
	Penetration 505-4101	323	22	109	10.6				
	Spike 505-4104	354	16	109	10.8				
	Double Spike 505-4105	352	13*	109	13.7				
Specialty									
	Heavy Duty Long Life (ARM) 505-4003	335	74	109	13.6	Retainer: 516-9168 Sleeve: 516-9167	The black areas in the pictures of the tips is where the ARM will be applied.		
	Penetration Long Life (ARM) 505-4102	323	22	109	10.7				
	Leveling Edge Conversion 505-4005	189	100	109	9.9				
Wear Protection									
Type	Machine	Part Number	Bolts	Nuts	Washer	Retainer / Pin	Qty.	Notes	
HEX Sidebar Protector	320-336	329-5958	N/A	N/A	N/A	132-0999/275-5982	2	Hex Sidebar Protector uses shear block 330-2174.	
GP Sidecutter, RH	320-336	7Y-0357	6I-6371	2J-3507	N/A	N/A	6		
GP Sidecutter, LH		7Y-0358							
HD Sidecutter, RH	320-336	522-6333	6I-6371	2J-3507	3K-5234	N/A	8		
HD Sidecutter, LH		522-6334							
Modular Edge Shrouds									
Model	Base Edge	Bevel Angle	Part Number	Width (mm)	Weight (kg)	Notes			
320, 324	45mm	22.5°	459-1903	37	2.6				
			459-1904	50	3.5				

Cat Advansys™ 110 Series - Base Edge Thickness: 60mm

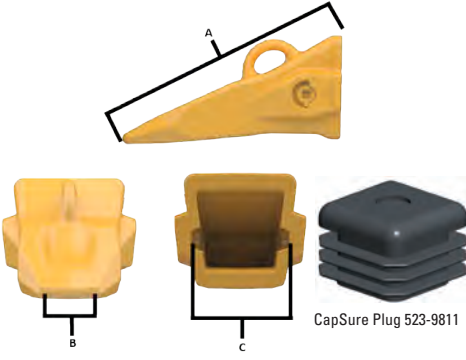
Machine Models: 336E/F, 324E-ME, 326F-ME, 329E/F-ME, 352F, 349E/F, 336E/F-ME











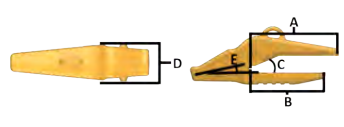

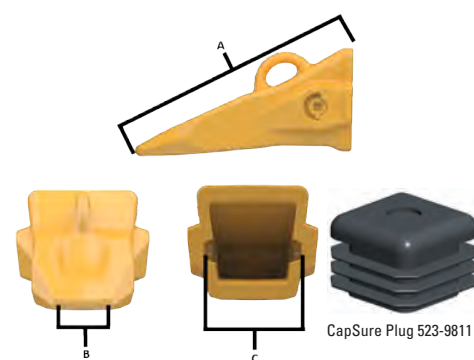
Adapters									
Type	Part Number	Edge Thickness	A (mm)	B (mm)	C (deg)	D (mm)	E (deg)	Weight (kg)	Notes
Center 2-Strap	505-4160	60	242	295	22.5	122	9.8	21.7	
RH 2 Strap Corner (5 degrees)	505-4161	60	223	275	22.5	138	9.8	23.9	
LH 2 Strap Corner (5 degrees)	505-4162	60	223	275	22.5	138	9.8	23.9	
Tips									
Type	Part Number	Dimensions (mm)			Weight (kg)	Retainer and Sleeve	Notes		
		A	B	C					
	Heavy Duty 505-4012	372	78	123	17.7	Retainer: 456-7043 Sleeve: 456-7042	 <p>*Overall width 188 mm</p>		
	General Purpose 505-4116	345	70	123	13.5				
	Wide 505-4110	344	220	123	17.1				
	Penetration Plus 505-4113	371	90	123	16.3				
	Penetration 505-4111	345	26	123	12.3				
	Spike 505-4114	382	18	123	13.6				
	Double Spike 505-4115	381	12*	123	16.8				
Specialty									
	Heavy Duty Long Life (ARM) 505-4013	372	124	123	17.9	Retainer: 456-7043 Sleeve: 456-7042	The black areas in the pictures of the tips is where the ARM will be applied.		
	Penetration Long Life (ARM) 505-4112	345	26	123	12.5				
Wear Protection									
Type	Machine	Part Number	Bolts	Nuts	Washer	Retainer / Pin	Qty.	Notes	
HEX Sidebar Protector	320-336	329-5958	N/A	N/A	N/A	132-0999/275-5982	2	Hex Sidebar Protector uses shear block 330-2174.	
HEX Sidebar Protector	345-385	326-3407	N/A	N/A	N/A	132-0999/132-0998	2		
GP Sidecutter, RH	320-336	7Y-0357	6I-6371	2J-3507	N/A	N/A	6		
GP Sidecutter, LH		7Y-0358							
HD Sidecutter, RH	320-336	522-6333	6I-6371	2J-3507	3K-5234	N/A	8		
HD Sidecutter, LH		522-6334							
HD Sidecutter, RH	345-385	326-3405	1D-4637	2J-3507	3K-5234	N/A	10		
HD Sidecutter, LH		326-3406							
Modular Edge Shrouds									
Model	Base Edge	Bevel Angle	Part Number	Width (mm)	Weight (kg)	Notes			
324, 336, 345	60mm	22.5°	459-9812	55	5.2				
			459-9814	70	6.6				

Cat Hydraulic Excavators

PART NUMBERS

Cat Advansys™ 130 Series - Base Edge Thickness: 70mm

Machine Models: 352F, 349E/F, 336E/F-ME, 345D-ME, 349F-ME

Adapters									
Type	Part Number	Edge Thickness	A (mm)	B (mm)	C (deg)	D (mm)	E (deg)	Weight (kg)	Notes
Center 2-Strap	368-3780	70	237	300	22.5	160	10	36.7	
RH 2 Strap Corner (5 degrees)	368-3781	70	245	305	22.5	158	10	38.2	
LH 2 Strap Corner (5 degrees)	368-3782	70	245	305	22.5	158	10	38.2	
Tips									
Type	Part Number	Dimensions (mm)			Weight (kg)	Retainer and Sleeve	Notes		
		A	B	C					
	Heavy Duty 368-3791	400	92	148	25.8	Retainer: 456-7043 Sleeve: 454-7042	 <p>*Overall width B from spike to spike 198</p>		
	General Purpose 381-4088	381	137	148	20.1				
	Wide 381-4091	381	262	148	27.2				
	Penetration Plus 381-4089	401	105	148	23.3				
	Penetration 381-4093	380	30	148	18.5				
	Spike 381-4090	422	20	148	18.7				
	Double Spike 381-4092	422	10*	148	25.5				
Specialty									
	Heavy Duty Long Life (ARM) 368-3857	400	92	148	26.6	Retainer: 456-7043 Sleeve: 454-7042	The black areas in the pictures of the tips is where the ARM will be applied.		
	Penetration Long Life (ARM) 368-3858	380	30	148	19.0				
Wear Protection									
Type	Machine	Part Number	Bolts	Nuts	Washer	Retainer / Pin	Qty.	Notes	
HEX Sidebar Protector	320-336	329-5958	N/A	N/A	N/A	132-0999/275-5982	2	Hex Sidebar Protector uses shear block 330-2174.	
HEX Sidebar Protector	345-385	326-3407	N/A	N/A	N/A	132-0999/132-0998	2		
GP Sidecutter, RH	320-336	7Y-0357	6I-6371	2J-3507	N/A	N/A	6		
GP Sidecutter, LH		7Y-0358							
HD Sidecutter, RH	320-336	522-6333	6I-6371	2J-3507	3K-5234	N/A	8		
HD Sidecutter, LH		522-6334							
HD Sidecutter, RH	345-385	326-3405	1D-4637	2J-3507	3K-5234	N/A	10		
HD Sidecutter, LH		326-3406							
Modular Edge Shrouds									
Model	Base Edge	Bevel Angle	Part Number	Width (mm)	Weight (kg)	Notes			
336, 345	70mm	22.5°	459-9822	55	6.8				
			459-9823	68	8.5				

Cat Advansys™ 150 Series - Base Edge Thickness: 80mm

Machine Models: 374D/F, 374D/F-ME, 390D/F

Adapters									
Type	Part Number	Edge Thickness	A (mm)	B (mm)	C (deg)	D (mm)	E (deg)	Weight (kg)	Notes
Center 2-Strap	368-3800	80	285	335	22.5	196	8.5	50.0	
RH 2 Strap Corner (5 degrees)	368-3801	80	280	330	22.5	200	8.5	54.0	
LH 2 Strap Corner (5 degrees)	368-3802	80	280	330	22.5	200	8.5	54.0	
Tips									
Type	Part Number	Dimensions (mm)			Weight (kg)	Retainer and Sleeve	Notes		
		A	B	C					
	Heavy Duty 368-3786	468	90	166	40.7	Retainer: 456-1689 Sleeve: 454-9600	 <p>CapSure Plug 468-8046</p>		
	General Purpose 368-3789	445	170	166	33.3				
	Wide 368-3790	445	304	166	38.9				
	Penetration Plus 368-3783	465	110	166	34.2				
	Penetration 368-3785	441	28	166	28.2				
	Spike 368-3787	496	20	166	30.9				
	Double Spike 368-3788	497	9*	166	36.6				
*Overall width B between spikes 204 mm									
Specialty									
	Heavy Duty Long Life (ARM) 368-3861	468	90	166	41.9	Retainer: 456-1689 Sleeve: 454-9600	The black areas in the pictures of the tips is where the ARM will be applied.		
	Penetration Long Life (ARM) 368-3874	441	28	166	28.8				
Wear Protection									
Type	Machine	Part Number	Bolts	Nuts	Washer	Retainer / Pin	Qty.	Notes	
HEX Sidebar Protector	374, 390	329-5955	N/A	N/A	N/A	132-0999/132-1008	2	Hex Sidebar Protector uses shear block 330-2174.	
HD Sidecutter, RH	374, 390	326-3405	7X-0410*	2J-3507	3K-5234	N/A	10		
HD Sidecutter, LH		326-3406							
Modular Edge Shrouds									
Model	Base Edge	Bevel Angle	Part Number	Width (mm)	Weight (kg)	Notes			
374, 390	80mm	22.5°	459-9824	58	10.0				
			459-9825	70	12.0				

Cat Hydraulic Excavators

PART NUMBERS

Cat Advansys™ 170 Series - Base Edge Thickness: 90mm

Machine Models: 374D/F-ME, 390D/F-ME

Adapters										
Type	Part Number	Edge Thickness	A (mm)	B (mm)	C (deg)	D (mm)	E (deg)	Weight (kg)	Notes	
Center 2-Strap	368-3822	90	313	429	35	208	10	83.0		
RH 2 Strap Corner (5 degrees)	368-3823	90	325	375	35	214	10	81.5		
LH 2 Strap Corner (5 degrees)	368-3824	90	325	375	35	214	10	81.5		
Tips										
Type	Part Number	Dimensions (mm)			Weight (kg)	Retainer and Sleeve	Notes			
		A	B	C						
	Heavy Duty 368-3867	499	89	171	52.9	Retainer: 456-1689 Sleeve: 454-9600	   CapSure Plug 468-8046	*Overall width B from spike to spike 259 mm		
	General Purpose 368-3872	474	164	171	41.9					
	Wide 368-3866	478	356	171	58.1					
	Penetration Plus 368-3869	502	132	171	45.9					
	Penetration 368-3868	474	36	171	38.2					
	Spike 368-3870	506	24	171	42.1					
	Double Spike 368-3871	508	32*	171	47.4					
Specialty										
	Heavy Duty Long Life (ARM) 387-6856	499	89	171	54.0	Retainer: 456-1689 Sleeve: 454-9600	The black areas in the pictures of the tips is where the ARM will be applied.			
	Penetration Long Life (ARM) 387-6866	474	36	171	38.6					
Wear Protection										
Type	Machine	Part Number	Bolts	Nuts	Washer	Retainer / Pin	Qty.	Notes		
HEX Sidebar Protector	374, 390	329-5955	N/A	N/A	N/A	132-0999/132-1008	2	Hex Sidebar Protector uses shear block 330-2174.		
HD Sidecutter, RH	374, 390	326-3405	7X-0410*	2J-3507	3K-5234	N/A	10			
HD Sidecutter, LH		326-3406								
Modular Edge Shrouds										
Model	Base Edge	Bevel Angle	Part Number	Width (mm)	Weight (kg)	Notes				
374, 390	90mm	35°	459-9826	60	15.0					
			459-9827	70	17.5					

Cat Advansys™ 200 Series - Base Edge Thickness: 100mm

Machine Models: 390D/F-ME

Adapters									
Type	Part Number	Edge Thickness	A (mm)	B (mm)	C (deg)	D (mm)	E (deg)	Weight (kg)	Notes
Center 2-Strap	368-3849	100	313	413	35	220	11.5	105.0	
Tips									
Type	Part Number	Dimensions (mm)			Weight (kg)	Retainer and Sleeve	Notes		
		A	B	C					
	Heavy Duty 385-4814	513	144	196	75.3	Retainer: 454-0278 Sleeve: 454-0277	    CapSure Plug 468-8046		
	General Purpose 385-4811	497	183	196	55.5				
	Penetration Plus 368-3878	544	145	196	62.5				
	Penetration 368-3877	494	109	196	54.0				
Specialty									
	Heavy Duty Long Life (ARM) 387-6867	513	144	196	77.1	Retainer: 454-0278 Sleeve: 454-0277	The black areas in the pictures of the tips is where the ARM will be applied.		
	Penetration Long Life (ARM) 387-6868	494	109	196	54.5				
Wear Protection									
Type	Machine	Part Number	Bolts	Nuts	Washer	Retainer / Pin	Qty.	Notes	
HEX Sidebar Protector	374, 390	329-5955	N/A	N/A	N/A	132-0999/132-1008	2	Hex Sidebar Protector uses shear block 330-2174.	
HD Sidecutter, RH	374, 390	326-3405	7X-0410*	2J-3507	3K-5234	N/A	10		
HD Sidecutter, LH		326-3406							
Modular Edge Shrouds									
Model	Base Edge	Bevel Angle	Part Number	Width (mm)	Weight (kg)	Notes			
390	100mm	35°	449-0904	70	17.0				
			449-0905	85	21.0				

Cat Hydraulic Excavators

OPTIONS

K SERIES TIP OPTIONS

Below are the tip shapes best suited for the wide range of jobsite conditions performed by hydraulic excavators. We also offer additional K Series tips more commonly used with wheel loaders. Your Cat dealer can help you choose the one that offers the right balance of penetration and wear life for your application.

ABRASION
↑

EXTRA DUTY

A.R.M.
OPTION
AVAILABLE



Extra Duty and Extra Duty Abrasion Resistant Material (A.R.M.)* tips include approximately 60% more wear material in the tip body. The A.R.M. wears around the profile to increase penetration.

GENERAL PURPOSE



General Purpose General Purpose tips are symmetrical and the baseline for other tip styles. All wear comparisons are to the General Purpose tip unless otherwise noted.

WIDE



Wide tips are used to maintain smooth trench floors and in low-abrasion, easy-to-penetrate material.

PENETRATION PLUS



Penetration Plus tips feature 25% more wear material and a leading edge with 25% less cross-sectional area. They self-sharpen as they wear.

PENETRATION

A.R.M.
OPTION
AVAILABLE



Penetration tips are ideal for densely compacted materials. They feature a leading edge with 60% less cross-sectional area—allowing for maximum penetration—and a single center rib that self-sharpen as it wears. These tips are available with A.R.M.*

SPIKE



Spike tips are used to achieve maximum penetration. They are typically used in cohesive material and stay sharp during the life of the tip.

DOUBLE SPIKE



Double Spike tips are used in the corner positions with the spike tips for hard-to-penetrate, fracturable materials.

↓
IMPACT







* Abrasion Resistant Material (A.R.M.) is a welding process that bonds very hard tungsten carbide particles to Cat G.E.T. to create a protective shield over the component. Typically, the A.R.M. process doubles wear life—and can last even longer in some applications.

Cat Hydraulic Excavators

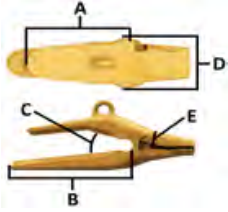
PART NUMBERS

36mm Bucket Edge Thickness

Machine Models: 315D, 316E/F, 318C/E/F, 319D, 320E/F, 321D, 323F, M322D/F

K80 Adapters										
Type	Part Number	Edge Thickness	A (mm)	B (mm)	C (deg)	D (mm)	E (deg)	Weight (kg)	Notes	
Center 2-Strap	220-9084	36	151	211	22.5	90	11.6	3.9		
RH 2 Strap Corner (0 degrees)	229-7085	36	125	204	22.5	92	11.6	3.5		
LH 2 Strap Corner (0 degrees)	229-7086	36	125	204	22.5	92	11.6	3.5		
RH 2 Strap Corner (4 degrees)	220-9085	36	126	203	22.5	92	11.6	3.6		
LH 2 Strap Corner (4 degrees)	220-9086	36	126	203	22.5	92	11.6	3.6		
RH 2 Strap Corner (5 degrees)	232-2085	36	124	202	22.5	109	11.6	4.7		
LH 2 Strap Corner (5 degrees)	232-2086	36	124	202	22.5	109	11.6	4.7		
K80 Tips										
Type	Part Number	Dimensions (mm)			Weight (kg)	Retainer	Notes			
		A	B	C						
	Extra Duty	475-5468	268	92	80	5.9	220-9090			
	General Duty	475-5473	247	92	80	5.1				
	Wide	475-5474	247	150	80	5.7				
	Penetration Plus	475-5470	268	84	80	5.7				
	Penetration	475-5469	247	58	80	4.1				
	Spike	475-5471	283	32	80	4.3				
	Double Spike	475-5472	283	112	80	5.2				
Specialty										
	Extra Duty Long Life (ARM)	475-5477	268	92	80	6.3	220-9090	The black areas in the pictures of the tips is where the ARM will be applied.		
	Penetration Long Life (ARM)	475-5478	247	58	80	4.3				
	Leveling Edge Conversion	475-5479	178	87	80	4.4				
Wear Protection										
Type	Machine	Part Number	Bolts	Nuts	Washer	Retainer / Pin	Qty.	Notes		
HEX Sidebar Protector	320-336	329-5958	N/A	N/A	N/A	132-0999/275-5982	2	Hex Sidebar Protector uses shear block 330-2174.		
GP Sidecutter, RH	315-319	357-2714	8T-0664	7X-0851	N/A	N/A	8			
GP Sidecutter, LH		357-2713								
GP Sidecutter, RH	320-336	7Y-0357	6I-6371	2J-3507	N/A	N/A	6			
GP Sidecutter, LH		7Y-0358								
HD Sidecutter, RH	320-336	522-6333	6I-6371	2J-3507	3K-5234	N/A	8			
HD Sidecutter, LH		522-6334								

Cat Hydraulic Excavators

PART NUMBERS

40mm Bucket Edge Thickness

Machine Models: 315D, 316E/F, 318E/F, 320E/F, 321D, 323F, M322D/F, 324E, 326F, 328D, 329E/F, 330F

K90 Adapters										
Type	Part Number	Edge Thickness	A (mm)	B (mm)	C (deg)	D (mm)	E (deg)	Weight (kg)	Notes	
Center 2-Strap	220-9094	40	192	234	22.5	99	10	11.3		
RH 2 Strap Corner (0 degrees)	223-8095	40	138	223	22.5	99	10	10.4		
LH 2 Strap Corner (0 degrees)	223-8096	40	138	223	22.5	99	10	10.4		
RH 2 Strap Corner (4 degrees)	220-9095	40	138	226	22.5	99	10	10.4		
LH 2 Strap Corner (4 degrees)	220-9096	40	138	226	22.5	99	10	10.4		
RH 2 Strap Corner (5 degrees)	232-2095	40	130	215	22.5	123	10	13.1		
LH 2 Strap Corner (5 degrees)	232-2096	40	130	215	22.5	123	10	13.1		
K90 Tips										
Type	Part Number	Dimensions (mm)			Weight (kg)	Retainer	Notes			
		A	B	C						
	Extra Duty	475-5480	279	99	90	8.1	220-9090			
	General Duty	475-5484	267	99	90	6.4				
	Wide	475-5485	267	178	90	8.3				
	Penetration Plus	475-5482	278	84	90	6.7				
	Penetration	475-5481	267	63	90	5.6				
	Spike	475-5483	303	36	90	5.9				
	Double Spike	475-5491	304	140	90	7.5				
Specialty										
	Extra Duty Long Life (ARM)	475-5488	279	99	90	8.1	220-9090	The black areas in the pictures of the tips is where the ARM will be applied.		
	Penetration Long Life (ARM)	475-5489	267	63	90	5.6				
	Leveling Edge Conversion	475-5490	189	95	90	6.0				
Wear Protection										
Type	Machine	Part No.	Bolts	Nuts	Washer	Retainer / Pin	Qty.	Notes		
HEX Sidebar Protector	320-336	329-5958	N/A	N/A	N/A	132-0999/275-5982	2	Hex Sidebar Protector uses shear block 330-2174.		
GP Sidecutter, RH	315-319	357-2714	8T-0664	7X-0851	N/A	N/A	8			
GP Sidecutter, LH		357-2713								
GP Sidecutter, RH	320-336	7Y-0357	6I-6371	2J-3507	N/A	N/A	6			
GP Sidecutter, LH		7Y-0358								
HD Sidecutter, RH	320-336	522-6333	6I-6371	2J-3507	3K-5234	N/A	8			
HD Sidecutter, LH		522-6334								
Modular Edge Shrouds										
Model	Base Edge	Bevel Angle	Part Number	Width (mm)	Weight (kg)	Notes				
320	40mm	22.5°	457-7562	34	2.0					
			457-7564	48	2.9					

45mm Bucket Edge Thickness

Machine Models: 324E, 326F, 328D, 329E/F, 330F, 336E/F, 324E-ME, 326F-ME, 329E/F-ME

K100 Adapters										
Type	Part Number	Edge Thickness	A (mm)	B (mm)	C (deg)	D (mm)	E (deg)	Weight (kg)	Notes	
Center 2-Strap	220-9104	45	187	238	22.5	110	10	13.6		
RH 2 Strap Corner (0 degrees)	232-0105	45	148	228	22.5	110	10	12.1		
LH 2 Strap Corner (0 degrees)	232-0106	45	148	228	22.5	110	10	12.1		
RH 2 Strap Corner (4 degrees)	220-9105	45	148	227	22.5	110	10	12.4		
LH 2 Strap Corner (4 degrees)	220-9106	45	148	227	22.5	110	10	12.4		
RH 2 Strap Corner (5 degrees)	232-2105	45	145	224	22.5	135	10	15.9		
LH 2 Strap Corner (5 degrees)	232-2106	45	145	224	22.5	135	10	15.9		
K100 Tips										
Type	Part Number	Dimensions (mm)			Weight (kg)	Retainer	Notes			
	Extra Duty	475-5492	309	110	96	11.2	220-9090			
	General Duty	475-5497	296	110	96	9.4				
	Wide	475-5498	296	206	96	11.6				
	Penetration Plus	475-5494	309	102	96	10.4				
	Penetration	475-5493	296	69	96	8.4				
	Spike	475-5495	331	54	96	8.5				
	Double Spike	475-5496	331	166	96	10.8				
Specialty										
	Extra Duty Long Life (ARM)	475-5501	309	110	96	11.8	220-9090	The black areas in the pictures of the tips is where the ARM will be applied.		
	Penetration Long Life (ARM)	475-5502	296	69	96	8.5				
	Leveling Edge Conversion	475-5503	212	105	96	7.9				
Wear Protection										
Type	Machine	Part No.	Bolts	Nuts	Washer	Retainer / Pin	Qty.	Notes		
HEX Sidebar Protector	320-336	329-5958	N/A	N/A	N/A	132-0999/275-5982	2	Hex Sidebar Protector uses shear block 330-2174.		
GP Sidecutter, RH	320-336	7Y-0357	6I-6371	2J-3507	N/A	N/A	6			
GP Sidecutter, LH		7Y-0358								
HD Sidecutter, RH	320-336	522-6333	6I-6371	2J-3507	3K-5234	N/A	8			
HD Sidecutter, LH		522-6334								
Modular Edge Shrouds										
Model	Base Edge	Bevel Angle	Part Number	Width (mm)	Weight (kg)	Notes				
320, 324	45mm	22.5°	459-1903	37	2.6					
			459-1904	50	3.5					

Cat Hydraulic Excavators

PART NUMBERS

60mm Bucket Edge Thickness

Machine Models: 336E/F, 324E-ME, 326F-ME, 329E/F-ME, 352F, 349E/F, 336E/F-ME

K110 Adapters									
Type	Part Number	Edge Thickness	A (mm)	B (mm)	C (deg)	D (mm)	E (deg)	Weight (kg)	Notes
Center 2-Strap	469-4311	60	241	294	22.5	120	9	22.3	
RH 2 Strap Corner (4 degrees)	469-4314	60	241	294	22.5	120	9	21.0	
LH 2 Strap Corner (4 degrees)	469-4315	60	241	294	22.5	120	9	21.0	
RH 2 Strap Corner (5 degrees)	469-4312	60	236	289	22.5	152	9	25.4	
LH 2 Strap Corner (5 degrees)	469-4313	60	236	289	22.5	152	9	25.4	
K110 Tips									
Type	Part Number	Dimensions (mm)			Weight (kg)	Retainer / Slag Retainer	Notes		
		A	B	C					
	Extra Duty 467-9821	346	126	110	17.1	286-2110 / 309-1119			
	General Duty 467-9824	319	118	110	11.9				
	Wide 470-7986	319	220	110	15.1				
	Penetration Plus 467-9823	346	125	110	16.5				
	Penetration 467-9822	319	49	110	10.6				
	Spike 470-7972	361	56	110	11.8				
	Double Spike 470-7973	361	186	110	14.6				
Specialty									
	Extra Duty Long Life (ARM) 472-7763	346	126	110	17.8	286-2110 / 309-1119	The black areas in the pictures of the tips is where the ARM will be applied.		
	Penetration Long Life (ARM) 472-7764	319	49	110	10.7				
Wear Protection									
Type	Machine	Part No.	Bolts	Nuts	Washer	Retainer / Pin	Qty.	Notes	
HEX Sidebar Protector	320-336	329-5958	N/A	N/A	N/A	132-0999/275-5982	2	Hex Sidebar Protector uses shear block 330-2174.	
HEX Sidebar Protector	345-385	326-3407	N/A	N/A	N/A	132-0999/132-0998	2		
GP Sidecutter, RH	320-336	7Y-0357	6I-6371	2J-3507	N/A	N/A	6		
GP Sidecutter, LH		7Y-0358							
HD Sidecutter, RH	320-336	522-6333	6I-6371	2J-3507	3K-5234	N/A	8		
HD Sidecutter, LH		522-6334							
HD Sidecutter, RH	345-385	326-3405	1D-4637	2J-3507	3K-5234	N/A	10		
HD Sidecutter, LH		326-3406							
Modular Edge Shrouds									
Model	Base Edge	Bevel Angle	Part Number	Width (mm)	Weight (kg)	Notes			
324, 336, 345	60mm	22.5°	459-9812	55	5.2				
			459-9814	70	6.6				

70mm Bucket Edge Thickness

Machine Models: 352F, 349E/F, 336E/F-ME, 345D-ME, 349F-ME

K130 Adapters									
Type	Part Number	Edge Thickness	A (mm)	B (mm)	C (deg)	D (mm)	E (deg)	Weight (kg)	Notes
Center 2-Strap	469-4316	70	299	360	22.5	170	9	37.0	
RH 2 Strap Corner (4 degrees)	469-4317	70	299	360	22.5	169	9	37.1	
LH 2 Strap Corner (4 degrees)	469-4318	70	299	360	22.5	169	9	37.1	
RH 2 Strap Corner (5 degrees)	469-4319	70	292	353	22.5	168	9	37.1	
LH 2 Strap Corner (5 degrees)	469-4320	70	292	353	22.5	168	9	37.1	
K130 Tips									
Type	Part Number	Dimensions (mm)			Weight (kg)	Retainer / Slag Retainer	Notes		
		A	B	C					
	Extra Duty 467-9815	386	148	130	24.5	220-9130 / 232-2139			
	General Duty 470-7978	364	150	130	18.8				
	Wide 470-7979	364	280	130	28.0				
	Penetration Plus 467-9813	386	150	130	22.0				
	Penetration 470-7975	364	20	130	16.4				
	Spike 470-7976	396	54	130	16.5				
	Double Spike 470-7977	394	198	130	20.8				
Specialty									
	Extra Duty Long Life (ARM) 472-7765	386	148	130	25.3	220-9130 / 232-2139	The black areas in the pictures of the tips is where the ARM will be applied.		
	Penetration Long Life (ARM) 472-7766	364	20	130	16.6				
Wear Protection									
Type	Machine	Part No.	Bolts	Nuts	Washer	Retainer / Pin	Qty.	Notes	
HEX Sidebar Protector	320-336	329-5958	N/A	N/A	N/A	132-0999/275-5982	2	Hex Sidebar Protector uses shear block 330-2174.	
HEX Sidebar Protector	345-385	326-3407	N/A	N/A	N/A	132-0999/132-0998	2		
GP Sidecutter, RH	320-336	7Y-0357	6I-6371	2J-3507	N/A	N/A	6		
GP Sidecutter, LH		7Y-0358							
HD Sidecutter, RH	320-336	522-6333	6I-6371	2J-3507	3K-5234	N/A	8		
HD Sidecutter, LH		522-6334							
HD Sidecutter, RH	345-385	326-3405	1D-4637	2J-3507	3K-5234	N/A	10		
HD Sidecutter, LH		326-3406							
Modular Edge Shrouds									
Model	Base Edge	Bevel Angle	Part Number	Width (mm)	Weight (kg)	Notes			
336, 345	70mm	22.5°	459-9822	55	6.8				
			459-9823	68	8.5				

Cat Hydraulic Excavators

PART NUMBERS











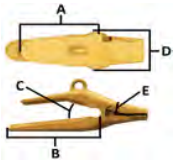

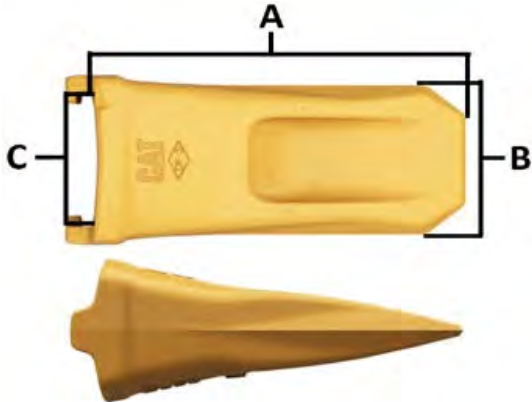
80mm Bucket Edge Thickness

Machine Models: 374D/F, 374D/F-ME, 390D/F

K150 Adapters									
Type	Part Number	Edge Thickness	A (mm)	B (mm)	C (deg)	D (mm)	E (deg)	Weight (kg)	Notes
Center 2-Strap	472-0802	80	332	383	22.5	196	8	50.2	
RH 2 Strap Corner (4 degrees)	472-0803	80	335	385	22.5	199	8	52.6	
LH 2 Strap Corner (4 degrees)	472-0804	80	335	385	22.5	199	8	52.6	
RH 2 Strap Corner (5 degrees)	472-0809	80	329	380	22.5	198	8	54.1	
LH 2 Strap Corner (5 degrees)	472-0810	80	329	380	22.5	198	8	54.1	
K150 Tips									
Type	Part Number	Dimensions (mm)			Weight (kg)	Retainer / Slag Retainer	Notes		
		A	B	C					
	Extra Duty 467-9819	444	178	150	40.2	233-7150 / 232-2159			
	General Duty 470-7985	421	168	150	30.5				
	Wide 470-7981	421	310	150	38.5				
	Penetration Plus 467-9817	445	174	150	33.2				
	Penetration 470-7982	421	28	150	27.3				
	Spike 470-7983	462	54	150	26.8				
	Double Spike 470-7984	462	204	150	29.6				
Specialty									
	Extra Duty Long Life (ARM) 472-7768	444	178	150	41.0	233-7150 / 232-2159	The black areas in the pictures of the tips is where the ARM will be applied.		
	Penetration Long Life (ARM) 472-7769	421	28	150	27.6				
Wear Protection									
Type	Machine	Part No.	Bolts	Nuts	Washer	Retainer / Pin	Qty.	Notes	
HEX Sidebar Protector	374, 390	329-5955	N/A	N/A	N/A	132-0999/132-1008	2	Hex Sidebar Protector uses shear block 330-2174.	
HD Sidecutter, RH	374, 390	326-3405	7X-0410*	2J-3507	3K-5234	N/A	10		
HD Sidecutter, LH		326-3406							
Modular Edge Shrouds									
Model	Base Edge	Bevel Angle	Part Number	Width (mm)	Weight (kg)	Notes			
374, 390	80mm	22.5°	459-9824	58	10.0				
			459-9825	70	12.0				

90mm Bucket Edge Thickness

Machine Models: 374D/F-ME, 390D/F-ME





K170 Adapters									
Type	Part Number	Edge Thickness	A (mm)	B (mm)	C (deg)	D (mm)	E (deg)	Weight (kg)	Notes
Center 2-Strap	478-2532	90	441	326	35	208	8	82.2	
RH 2 Strap Corner (4 degrees)	478-2533	90	441	326	35	207	8	81.2	
LH 2 Strap Corner (4 degrees)	478-2534	90	441	326	35	207	8	81.2	
RH 2 Strap Corner (5 degrees)	478-2538	90	445	329	35	211	8	76.3	
LH 2 Strap Corner (5 degrees)	478-2539	90	445	329	35	211	8	76.3	
K170 Tips									
Type	Part Number	Dimensions (mm)			Weight (kg)	Retainer / Slag Retainer	Notes		
		A	B	C					
	Extra Duty 264-2171	485	194	170	57.1	232-0170/ 232-2179			
	General Duty 232-0179	459	190	170	36.8				
	Wide 223-8170	460	360	170	57.5				
	Penetration Plus 232-0173	484	190	170	47.2				
	Penetration 232-0172	459	28	170	38.0				
	Spike 232-0177	495	106	170	38.8				
	Double Spike 232-0178	494	259	170	46.3				
Specialty									
	Extra Duty Long Life (ARM) 233-7170	485	194	170	58.4	232-0170/ 232-2179	The black areas in the pictures of the tips is where the ARM will be applied.		
	Penetration Long Life (ARM) 233-7171	459	28	170	38.1				
Wear Protection									
Type	Machine	Part No.	Bolts	Nuts	Washer	Retainer / Pin	Qty.	Notes	
HEX Sidebar Protector	374, 390	329-5955	N/A	N/A	N/A	132-0999/132-1008	2	Hex Sidebar Protector uses shear block 330-2174.	
HD Sidecutter, RH	374, 390	326-3405	7X-0410*	2J-3507	3K-5234	N/A	10		
HD Sidecutter, LH		326-3406							
Modular Edge Shrouds									
Model	Base Edge	Bevel Angle	Part Number	Width (mm)	Weight (kg)	Notes			
374, 390	90mm	35°	459-9826	60	15.0				
			459-9827	70	17.5				

Cat Hydraulic Excavators

OPTIONS

CAPSURE TIP OPTIONS

We offer four CapSure tip options designed for a range of jobsite conditions. Your Cat dealer can help you choose the one that offers the right balance of penetration and wear life for your application.

ABRASION ↑	HEAVY DUTY ABRASION		Heavy Duty Abrasion tips are ideal for high-abrasion applications like sand, gravel and shot rock. They have the maximum amount of wear material—approximately 145% more—and the tip base features 35% more surface area than Heavy Penetration tips.
	HEAVY PENETRATION		Heavy Penetration tips are ideal for high-impact, hard-to-penetrate materials. They feature approximately 120% more material in the high wear area as well as a sharp spade design with 70% less cross-sectional area on the leading edge than Heavy Duty Abrasion tips.
	HEAVY DUTY		Heavy Duty tips are the baseline for other tips. All wear comparisons are to the Heavy Duty tip unless otherwise noted.
	PENETRATION PLUS		Penetration Plus tips feature 30% more wear material and 25% less cross-sectional area. They self-sharpen as they wear.
↓ IMPACT			

Cat Hydraulic Excavators

PART NUMBERS

60mm Bucket Edge Thickness

Machine Models: 336E/F, 324E-ME, 326F-ME, 329E/F-ME, 352F, 349E/F, 336E/F-ME

CapSure J550 Adapters									
Type	Part Number	Edge Thickness	A (mm)	B (mm)	C (deg)	D (mm)	E (deg)	Weight (kg)	Notes
Center 2-Strap	6I-6554	60	279	339	22.5	120	9	31.2	
RH 2 Strap Corner (4 degrees)	6I-6555	60	279	339	22.5	120	9	30.4	
LH 2 Strap Corner (4 degrees)	6I-6556	60	279	339	22.5	120	9	30.4	
Center Rock Ripping	107-8554	60	250	190	0	160	46.5	41.8	
Int Rock Ripping	107-8555	60	250	190	0	160	19	36.9	
Rock Ripping Corner	107-8556	60	NA	NA	NA	160	0	38.9	
CapSure J550 Tips									
Type	Part Number	Dimensions (mm)			Weight (kg)	CapSure Pin Kit	Notes		
		A	B	C					
	Heavy Abrasion 460-8042	347	160	140	34.4	365-4528			
	Extra Duty 460-8046	347	164	140	32.8				
	General Duty 460-8044	330	150	140	21.4				
	Penetration Plus 460-8048	330	280	140	25.2				
Wear Protection									
Type	Machine	Part Number	Bolts	Nuts	Washer	Retainer / Pin	Qty.	Notes	
HEX Sidebar Protector	320-336	329-5958	N/A	N/A	N/A	132-0999/275-5982	2	Hex Sidebar Protector uses shear block 330-2174.	
HEX Sidebar Protector	345-385	326-3407	N/A	N/A	N/A	132-0999/132-0998	2		
GP Sidecutter, RH	320-336	7Y-0357	6I-6371	2J-3507	N/A	N/A	6		
GP Sidecutter, LH		7Y-0358							
HD Sidecutter, RH	320-336	522-6333	6I-6371	2J-3507	3K-5234	N/A	8		
HD Sidecutter, LH		522-6334							
HD Sidecutter, RH	345-385	326-3405	1D-4637	2J-3507	3K-5234	N/A	10		
HD Sidecutter, LH		326-3406							
Modular Edge Shrouds									
Model	Base Edge	Bevel Angle	Part Number	Width (mm)	Weight (kg)	Notes			
324, 336, 345	60mm	22.5°	459-9812	55	5.2				
			459-9814	70	6.6				

Cat Hydraulic Excavators

PART NUMBERS

64mm Bucket Edge Thickness

Machine Models: 336E/F, 324E-ME, 326F-ME, 329E/F-ME, 352F, 349E/F, 336E/F-ME

CapSure J550 Adapters									
Type	Part Number	Edge Thickness	A (mm)	B (mm)	C (deg)	D (mm)	E (deg)	Weight (kg)	Notes
Center 2-Strap	3G-9494	64	371	331	22.5	118	15	33.6	
RH 2 Strap Corner (4 degrees)	3G-9495	64	371	331	22.5	118	15	32.6	
LH 2 Strap Corner (4 degrees)	3G-9496	64	371	331	22.5	118	15	32.6	
CapSure J550 Tips									
Type	Part Number	Dimensions (mm)			Weight (kg)	CapSure Pin Kit	Notes		
		A	B	C					
	Heavy Abrasion 460-8042	347	160	140	34.4	365-4528			
	Extra Duty 460-8046	347	164	140	32.8				
	General Duty 460-8044	330	150	140	21.4				
	Penetration Plus 460-8048	330	280	140	25.2				
Wear Protection									
Type	Machine	Part Number	Bolts	Nuts	Washer	Retainer / Pin	Qty.	Notes	
HEX Sidebar Protector	320-336	329-5958	N/A	N/A	N/A	132-0999/275-5982	2	Hex Sidebar Protector uses shear block 330-2174.	
HEX Sidebar Protector	345-385	326-3407	N/A	N/A	N/A	132-0999/132-0998	2		
GP Sidecutter, RH	320-336	7Y-0357	6I-6371	2J-3507	N/A	N/A	6		
GP Sidecutter, LH		7Y-0358							
HD Sidecutter, RH	320-336	522-6333	6I-6371	2J-3507	3K-5234	N/A	8		
HD Sidecutter, LH		522-6334							
HD Sidecutter, RH	345-385	326-3405	1D-4637	2J-3507	3K-5234	N/A	10		
HD Sidecutter, LH		326-3406							
Modular Edge Shrouds									
Model	Base Edge	Bevel Angle	Part Number	Width (mm)	Weight (kg)	Notes			
324, 336, 345	60mm	22.5°	459-9812	55	5.2				
			459-9814	70	6.6				

70mm Bucket Edge Thickness

Machine Models: 352F, 349E/F, 336E/F-ME, 345D-ME, 349F-ME

CapSure J550 Adapters									
Type	Part Number	Edge Thickness	A (mm)	B (mm)	C (deg)	D (mm)	E (deg)	Weight (kg)	Notes
Center 2-Strap	275-2759	70	269.7	329.7	22.5	140	9	35.3	
RH 2 Strap Corner (4 degrees)	275-2760	70	269.7	329.7	22.5	140	9	35.3	
LH 2 Strap Corner (4 degrees)	275-2760	70	269.7	329.7	22.5	140	9	35.3	
CapSure J550 Tips									
Type	Part Number	Dimensions (mm)			Weight (kg)	CapSure Pin Kit	Notes		
		A	B	C					
	Heavy Abrasion	460-8042	347	160	140	34.4			
	Extra Duty	460-8046	347	164	140	32.8			
	General Duty	460-8044	330	150	140	21.4			
	Penetration Plus	460-8048	330	280	140	25.2			
365-4528									
Wear Protection									
Type	Machine	Part Number	Bolts	Nuts	Washer	Retainer / Pin	Qty.	Notes	
HEX Sidebar Protector	320-336	329-5958	N/A	N/A	N/A	132-0999/275-5982	2	Hex Sidebar Protector uses shear block 330-2174.	
HEX Sidebar Protector	345-385	326-3407	N/A	N/A	N/A	132-0999/132-0998	2		
GP Sidecutter, RH	320-336	7Y-0357	6I-6371	2J-3507	N/A	N/A	6		
GP Sidecutter, LH		7Y-0358							
HD Sidecutter, RH	320-336	522-6333	6I-6371	2J-3507	3K-5234	N/A	8		
HD Sidecutter, LH		522-6334							
HD Sidecutter, RH	345-385	326-3405	1D-4637	2J-3507	3K-5234	N/A	10		
HD Sidecutter, LH		326-3406							
Modular Edge Shrouds									
Model	Base Edge	Bevel Angle	Part Number	Width (mm)	Weight (kg)	Notes			
336, 345	70mm	22.5°	459-9822	55	6.8				
			459-9823	68	8.5				

Cat Hydraulic Excavators

PART NUMBERS







70mm Bucket Edge Thickness

Machine Models: 352F, 349E/F, 336E/F-ME, 345D-ME, 349F-ME

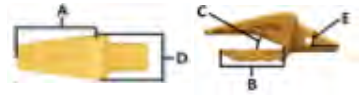
CapSure J600 Adapters									
Type	Part Number	Edge Thickness	A (mm)	B (mm)	C (deg)	D (mm)	E (deg)	Weight (kg)	Notes
Center 2-Strap	61-6604	70	310	365	22.5	144	8	47.8	
RH 2 Strap Corner (4 degrees)	61-6605	70	310	365	22.5	144	8	46.7	
LH 2 Strap Corner (4 degrees)	61-6606	70	310	365	22.5	144	8	46.7	
Center 2-Strap	61-8604	70	310	365	22.5	188	15	53.5	
RH 2 Strap Corner	61-8605	70	310	365	22.5	188	15	52.6	
LH 2 Strap Corner	61-8606	70	310	365	22.5	188	15	52.6	
Center Rock Ripping	107-8604	70	262	207	0	200	46.5	68.9	
Int Rock Ripping	107-8605	70	262	207	0	200	19	59.9	
Rock Ripping Corner	107-8606	70	NA	NA	NA	200	0	62.0	
CapSure J600 Tips									
Type	Part Number	Dimensions (mm)			Weight (kg)	CapSure Pin Kit	Notes		
		A	B	C					
	Heavy Abrasion 459-2186	408	230	152	56.0	364-9751			
	Extra Duty 459-2182	408	170	152	45.7				
	Penetration Plus 459-2180	425	170	152	40.3				
Wear Protection									
Type	Machine	Part Number	Bolts	Nuts	Washer	Retainer / Pin	Qty.	Notes	
HEX Sidebar Protector	320-336	329-5958	N/A	N/A	N/A	132-0999/275-5982	2	Hex Sidebar Protector uses shear block 330-2174.	
HEX Sidebar Protector	345-385	326-3407	N/A	N/A	N/A	132-0999/132-0998	2		
GP Sidecutter, RH	320-336	7Y-0357	6I-6371	2J-3507	N/A	N/A	6		
GP Sidecutter, LH		7Y-0358							
HD Sidecutter, RH	320-336	522-6333	6I-6371	2J-3507	3K-5234	N/A	8		
HD Sidecutter, LH		522-6334							
HD Sidecutter, RH	345-385	326-3405	1D-4637	2J-3507	3K-5234	N/A	10		
HD Sidecutter, LH		326-3406							
Modular Edge Shrouds									
Model	Base Edge	Bevel Angle	Part Number	Width (mm)	Weight (kg)	Notes			
336, 345	70mm	22.5°	459-9822	55	6.8				
			459-9823	68	8.5				

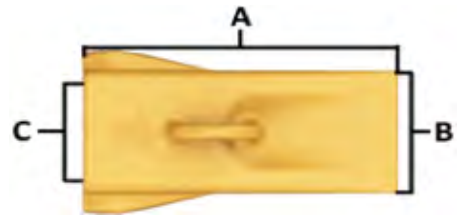
80mm Bucket Edge Thickness

Machine Models: 374D/F, 374D/F-ME, 390D/F

CapSure J600 Adapters									
Type	Part Number	Edge Thickness	A (mm)	B (mm)	C (deg)	D (mm)	E (deg)	Weight (kg)	Notes
Center 2-Strap	113-9604	80	310	365	22.5	144	8	48.3	
RH 2 Strap Corner (4 degrees)	113-9605	80	310	365	22.5	144	8	49.7	
LH 2 Strap Corner (4 degrees)	113-9606	80	310	365	22.5	144	8	49.7	
CapSure J600 Tips									
Type	Part Number	Dimensions (mm)			Weight (kg)	CapSure Pin Kit	Notes		
		A	B	C					
 Heavy Abrasion	459-2186	408	230	152	56.0	364-9751			
 Extra Duty	459-2182	408	170	152	45.7				
 Penetration Plus	459-2180	425	170	152	40.3				
Wear Protection									
Type	Machine	Part Number	Bolts	Nuts	Washer	Retainer / Pin	Qty.	Notes	
HEX Sidebar Protector	374, 390	329-5955	N/A	N/A	N/A	132-0999/132-1008	2	Hex Sidebar Protector uses shear block 330-2174.	
HD Sidecutter, RH	374, 390	326-3405	7X-0410*	2J-3507	3K-5234	N/A	10		
HD Sidecutter, LH		326-3406							
Modular Edge Shrouds									
Model	Base Edge	Bevel Angle	Part Number	Width (mm)	Weight (kg)	Notes			
374, 390	80mm	22.5°	459-9824	58	10.0				
			459-9825	70	12.0				

Cat Hydraulic Excavators

PART NUMBERS

80mm Bucket Edge Thickness

Machine Models: 374D/F, 374D/F-ME, 390D/F

CapSure J700 Adapters									
Type	Part Number	Edge Thickness	A (mm)	B (mm)	C (deg)	D (mm)	E (deg)	Weight (kg)	Notes
Center 2-Strap	132-4704	80	435	335	22.5	154	9	64.5	
RH 2 Strap Corner (4 degrees)	132-4705	80	414	314	22.5	154	9	64.9	
LH 2 Strap Corner (4 degrees)	132-4706	80	414	314	22.5	154	9	64.9	
CapSure J700 Tips									
Type	Part Number	Dimensions (mm)			Weight (kg)	CapSure Pin Kit	Notes		
		A	B	C					
 Heavy Abrasion	455-1027	415	260	178	79.0	363-9110			
 Extra Duty	455-1031	465	188	178	60.8				
 Penetration Plus	455-1024	455	188	178	51.3				
Wear Protection									
Type	Machine	Part Number	Bolts	Nuts	Washer	Retainer / Pin	Qty.	Notes	
HEX Sidebar Protector	374, 390	329-5955	N/A	N/A	N/A	132-0999/132-1008	2	Hex Sidebar Protector uses shear block 330-2174.	
HD Sidecutter, RH	374, 390	326-3405	7X-0410*	2J-3507	3K-5234	N/A	10		
HD Sidecutter, LH		326-3406							
Modular Edge Shrouds									
Model	Base Edge	Bevel Angle	Part Number	Width (mm)	Weight (kg)	Notes			
374, 390	80mm	22.5°	459-9824	58	10.0				
			459-9825	70	12.0				

90mm Bucket Edge Thickness

Machine Models: 374D/F-ME, 390D/F-ME







CapSure J700 Adapters									
Type	Part Number	Edge Thickness	A (mm)	B (mm)	C (deg)	D (mm)	E (deg)	Weight (kg)	Notes
Center 2-Strap	222-7700	90	464	314	35	190	8	84.1	
CapSure J700 Tips									
Type	Part Number	Dimensions (mm)			Weight (kg)	CapSure Pin Kit	Notes		
	Heavy Abrasion 455-1027	A	B	C	79.0	363-9110			
	Extra Duty 455-1031	415	260	178	60.8				
	Penetration Plus 455-1024	465	188	178	51.3				
Wear Protection									
Type	Machine	Part Number	Bolts	Nuts	Washer	Retainer / Pin	Qty.	Notes	
HEX Sidebar Protector	374, 390	329-5955	N/A	N/A	N/A	132-0999/132-1008	2	Hex Sidebar Protector uses shear block 330-2174.	
HD Sidecutter, RH	374, 390	326-3405	7X-0410*	2J-3507	3K-5234	N/A	10		
HD Sidecutter, LH		326-3406							
Modular Edge Shrouds									
Model	Base Edge	Bevel Angle	Part Number	Width (mm)	Weight (kg)	Notes			
374, 390	90mm	35°	459-9826	60	15.0				
			459-9827	70	17.5				

Cat Hydraulic Excavators

PART NUMBERS

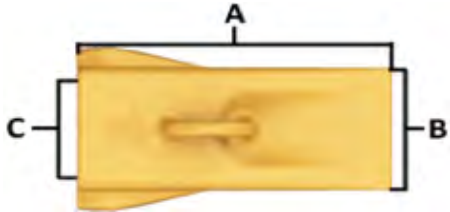
100mm Bucket Edge Thickness

Machine Models: 390D/F-ME









CapSure J800 Adapters									
Type	Part Number	Edge Thickness	A (mm)	B (mm)	C (deg)	D (mm)	E (deg)	Weight (kg)	Notes
Center 2-Strap	357-6516	100	435	335	35	220	8	104.3	
CapSure J800 Tips									
Type	Part Number	Dimensions (mm)			Weight (kg)	CapSure Pin Kit	Notes		
		A	B	C					
 Heavy Abrasion	444-7594	515	277	203	111.1	310-2788			
 Extra Duty	453-3648	475	220	203	91.2				
 Penetration Plus	453-3646	475	240	203	83.4				
Wear Protection									
Type	Machine	Part Number	Bolts	Nuts	Washer	Retainer / Pin	Qty.	Notes	
HEX Sidebar Protector	374, 390	329-5955	N/A	N/A	N/A	132-0999/132-1008	2	Hex Sidebar Protector uses shear block 330-2174.	
HD Sidecutter, RH	374, 390	326-3405	7X-0410*	2J-3507	3K-5234	N/A	10		
HD Sidecutter, LH		326-3406							
Modular Edge Shrouds									
Model	Base Edge	Bevel Angle	Part Number	Width (mm)	Weight (kg)	Notes			
390	100mm	35°	449-0904	70	17.0				
			449-0905	85	21.0				

Cat Hydraulic Excavators

OPTIONS

J SERES TIP OPTIONS

Below are the tip shapes best suited for the wide range of jobsite conditions performed by hydraulic excavators. We also offer additional J Series tips more commonly used with wheel loaders. Your Cat dealer can help you choose the one that offers the right balance of penetration and wear life for your application.

<p style="writing-mode: vertical-rl; transform: rotate(180deg);">ABRASION ↑</p> <p style="writing-mode: vertical-rl; transform: rotate(180deg);">↓ IMPACT</p>	<p>HEAVY DUTY LONG</p> <p>A.R.M. OPTION AVAILABLE</p> 	<p>Heavy Duty Long and Heavy Duty Abrasion Resistant Material (A.R.M.)* tips include approximately 60% more wear material in the tip body. The A.R.M. wears around the profile to increase penetration.</p>
	<p>LONG (GENERAL PURPOSE)</p> 	<p>Long tips are symmetrical and the baseline for other tip styles. All wear comparisons are to the Long tip unless otherwise noted.</p>
	<p>WIDE</p> 	<p>Wide tips are used to maintain smooth trench floors and in low-abrasion, easy-to-penetrate material.</p>
	<p>PENETRATION PLUS</p> 	<p>Penetration Plus tips feature 30% more wear material and 25% less cross-sectional area. They self-sharpen as they wear.</p>
	<p>PENETRATION</p> <p>A.R.M. OPTION AVAILABLE</p> 	<p>Penetration and Penetration A.R.M.* tips are ideal for densely compacted materials. They feature a leading edge with approximately 50% less cross-sectional area and a single center rib for strength—allowing for maximum penetration.</p>
	<p>SPIKE</p> 	<p>Spike tips are used to achieve maximum penetration. They are typically used in cohesive material and stay sharp during the life of the tip.</p>
	<p>SPIKE CORNER</p> 	<p>Spike Corner tips can be used in the corner position with sharp center tips.</p>
	<p>DOUBLE SPIKE</p> 	<p>Double Spike tips are used in the corner positions with the spike tips for hard-to-penetrate, fracturable materials.</p>





*Abrasion Resistant Material (A.R.M.) is a welding process that bonds very hard tungsten carbide particles to Cat G.E.T. to create a protective shield over the component. Typically, the A.R.M. process doubles wear life—and can last even longer in some applications.

Cat Hydraulic Excavators

PART NUMBERS

36mm Bucket Edge Thickness

Machine Models: 315D, 316E/F, 318C/E/F, 319D, 320E/F, 321D, 323F, M322D/F

J300 Adapters									
Type	Part Number	Edge Thickness	A (mm)	B (mm)	C (deg)	D (mm)	E (deg)	Weight (kg)	Notes
Center 2-Strap	8E-9490	36	150	210	22.5	70	11.6	7.67	
Center Flushmount	1U-1304	36	238	NA	22.5	70	14	8.17	
J300 Tips									
Type	Part Number	Dimensions (mm)			Weight (kg)	Retainer	Notes		
		A	B	C					
	General Duty	1U-3302	215	80	65.2	4.2			
	Wide	107-3300	215	150	65.2	5.2			
	Penetration Plus	183-5300	235	55	65.2	5.3			
	Penetration	9J-4309	219.2	36	65.2	3.6			
	Spike	168-1300	260	33	65.2	3.9			
	Double Spike	135-9308	229	112	65.2	5.0			
Specialty									
	Penetration Long Life (ARM)	125-8309	223	36	65.2	5.1	Pin: 132-4766 Retainer: 149-5733	The black areas in the pictures of the tips is where the ARM will be applied.	
Wear Protection									
Type	Machine	Part Number	Bolts	Nuts	Washer	Retainer / Pin	Qty.	Notes	
HEX Sidebar Protector	320-336	329-5958	N/A	N/A	N/A	132-0999/275-5982	2	Hex Sidebar Protector uses shear block 330-2174.	
GP Sidecutter, RH	315-319	357-2714	8T-0664	7X-0851	N/A	N/A	8		
GP Sidecutter, LH		357-2713							
GP Sidecutter, RH	320-336	7Y-0357	6I-6371	2J-3507	N/A	N/A	6		
GP Sidecutter, LH		7Y-0358							
HD Sidecutter, RH	320-336	522-6333	6I-6371	2J-3507	3K-5234	N/A	8		
HD Sidecutter, LH		522-6334							

32mm Bucket Edge Thickness

Machine Models: 315D, 316E/F, 318C/E/F, 319D, 320E/F, 321D, 323F, M322D/F

J300 Adapters									
Type	Part Number	Edge Thickness	A (mm)	B (mm)	C (deg)	D (mm)	E (deg)	Weight (kg)	Notes
Center 2-Strap	9W-1304	32	110	190	22.5	68	8	6.32	
RH 2 Strap Corner (4 degrees)	7T-3305	32	110	190	22.5	68	8	6.30	
LH 2 Strap Corner (4 degrees)	7T-3306	32	110	190	22.5	68	8	6.30	
RH 2 Strap Corner (0 degrees)	3G-6305	32	113	203	22.5	74	8	7.71	
LH 2 Strap Corner (0 degrees)	3G-6306	32	113	203	22.5	74	8	7.41	
Center Flushmount	1U-1304	32	238	NA	22.5	70	14	8.17	
Center Bottom Strap	9J-8929	32	50	200	22.5	70	14	7.94	
J300 Tips									
Type	Part Number	Dimensions (mm)			Weight (kg)	Retainer	Notes		
		A	B	C					
	General Duty	1U-3302	215	80	65.2	4.2			
	Wide	107-3300	215	150	65.2	5.2			
	Penetration Plus	183-5300	235	55	65.2	5.3			
	Penetration	9J-4309	219.2	36	65.2	3.6			
	Spike	168-1300	260	33	65.2	3.9			
	Double Spike	135-9308	229	112	65.2	5.0			
Specialty									
	Penetration Long Life (ARM)	125-8309	223	36	65.2	5.1	Pin: 132-4766 Retainer: 149-5733	The black areas in the pictures of the tips is where the ARM will be applied.	
Wear Protection									
Type	Machine	Part Number	Bolts	Nuts	Washer	Retainer / Pin	Qty.	Notes	
HEX Sidebar Protector	320-336	329-5958	N/A	N/A	N/A	132-0999/275-5982	2	Hex Sidebar Protector uses shear block 330-2174.	
GP Sidecutter, RH	315-319	357-2714	8T-0664	7X-0851	N/A	N/A	8		
GP Sidecutter, LH		357-2713							
GP Sidecutter, RH	320-336	7Y-0357	6I-6371	2J-3507	N/A	N/A	6		
GP Sidecutter, LH		7Y-0358							
HD Sidecutter, RH	320-336	522-6333	6I-6371	2J-3507	3K-5234	N/A	8		
HD Sidecutter, LH		522-6334							

Cat Hydraulic Excavators

PART NUMBERS

40mm Bucket Edge Thickness

Machine Models: 315D, 316E/F, 318E/F, 320E/F, 321D, 323F, M322D/F, 324E, 326F, 328D, 329E/F, 330F

J350 Adapters									
Type	Part Number	Edge Thickness	A (mm)	B (mm)	C (deg)	D (mm)	E (deg)	Weight (kg)	Notes
Center 2-Strap	6I-6354	40	184	229	22.5	90	10.6	10.2	
RH 2 Strap Corner (4 degrees)	6I-6355	40	184	229	22.5	90	10.6	10.0	
LH 2 Strap Corner (4 degrees)	6I-6356	40	184	229	22.5	90	10.6	10.0	
Center Flushmount	1U-1354	40	284	0	22.5	96	14	12.2	
Center Bottom Strap	1U-1350	40	48	262	22.5	76	14	12.2	
J350 Tips									
Type	Part Number	Dimensions (mm)			Weight (kg)	Retainer	Notes		
		A	B	C					
	General Duty	1U-3352	240	90	74.8	6.6			
	Wide	107-3350	330	178	74.8	6.8			
	Penetration Plus	168-1359	260	57	74.8	7.5			
	Penetration	9J-4359	240	46	74.8	5.4			
	Spike	168-1350	286	14	74.8	5.6			
	Double Spike	135-9357	266.5	130	74.8	6.5			
Specialty									
	Penetration Long Life (ARM)	119-9359	251	40	74.8	7.3	Pin: 114-0358 Retainer: 114-0359	The black areas in the pictures of the tips is where the ARM will be applied.	
Wear Protection									
Type	Machine	Part Number	Bolts	Nuts	Washer	Retainer / Pin	Qty.	Notes	
HEX Sidebar Protector	320-336	329-5958	N/A	N/A	N/A	132-0999/275-5982	2	Hex Sidebar Protector uses shear block 330-2174.	
GP Sidecutter, RH	315-319	357-2714	8T-0664	7X-0851	N/A	N/A	8		
GP Sidecutter, LH		357-2713							
GP Sidecutter, RH	320-336	7Y-0357	6I-6371	2J-3507	N/A	N/A	6		
GP Sidecutter, LH		7Y-0358							
HD Sidecutter, RH	320-336	522-6333	6I-6371	2J-3507	3K-5234	N/A	8		
HD Sidecutter, LH		522-6334							
Modular Edge Shrouds									
Model	Base Edge	Bevel Angle	Part Number	Width (mm)	Weight (kg)	Notes			
320	40mm	22.5°	457-7562	34	2.0				
			457-7564	48	2.9				

38mm Bucket Edge Thickness

Machine Models: 315D, 316E/F, 318E/F, 320E/F, 321D, 323F, M322D/F, 324E, 326F, 328D, 329E/F, 330F

J350 Adapters									
Type	Part Number	Edge Thickness	A (mm)	B (mm)	C (deg)	D (mm)	E (deg)	Weight (kg)	Notes
Center 2-Strap	3G-8354	38	126	216	35	78	8	9.0	
RH 2 Strap Corner (0 degrees)	3G-8354	38	130	218	35	78	8	9.0	
LH 2 Strap Corner (0 degrees)	3G-8354	38	130	218	35	78	8	9.0	
Center Flushmount	1U-1354	38	284	0	22.5	96	14	1.7	
Center Bottom Strap	1U-1350	38	48	262	22.5	76	14.0	12.2	
J350 Tips									
Type	Part Number	Dimensions (mm)			Weight (kg)	Retainer	Notes		
		A	B	C					
	General Duty	1U-3352	240	90	74.8	6.6	<p>Pin: 114-0358 Retainer: 114-0359</p>		
	Wide	107-3350	330	178	74.8	6.8			
	Penetration Plus	168-1359	260	57	74.8	7.5			
	Penetration	9J-4359	240	46	74.8	5.4			
	Spike	168-1350	286	14	74.8	5.6			
	Double Spike	135-9357	266.5	130	74.8	6.5			
Specialty									
	Penetration Long Life (ARM)	119-9359	251	40	74.8	7.3	Pin: 114-0358 Retainer: 114-0359	The black areas in the pictures of the tips is where the ARM will be applied.	
Wear Protection									
Type	Machine	Part Number	Bolts	Nuts	Washer	Retainer / Pin	Qty.	Notes	
HEX Sidebar Protector	320-336	329-5958	N/A	N/A	N/A	132-0999/275-5982	2	Hex Sidebar Protector uses shear block 330-2174.	
GP Sidecutter, RH	315-319	357-2714	8T-0664	7X-0851	N/A	N/A	8		
GP Sidecutter, LH		357-2713							
GP Sidecutter, RH	320-336	7Y-0357	6I-6371	2J-3507	N/A	N/A	6		
GP Sidecutter, LH		7Y-0358							
HD Sidecutter, RH	320-336	522-6333	6I-6371	2J-3507	3K-5234	N/A	8		
HD Sidecutter, LH		522-6334							
Modular Edge Shrouds									
Model	Base Edge	Bevel Angle	Part Number	Width (mm)	Weight (kg)	Notes			
320	40mm	22.5°	457-7562	34	2.0				
			457-7564	48	2.9				

Cat Hydraulic Excavators

PART NUMBERS









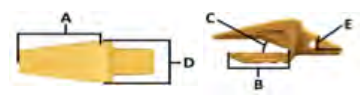

45mm Bucket Edge Thickness

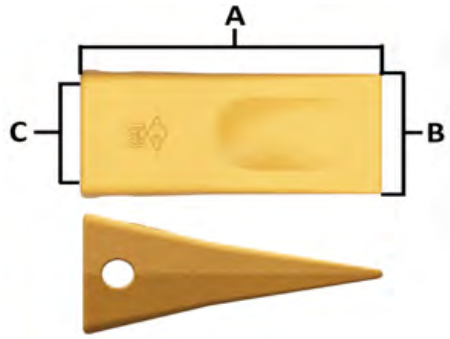
Machine Models: 324E, 326F, 328D, 329E/F, 330F, 336E/F, 324E-ME, 326F-ME, 329E/F-ME

J400 Adapters									
Type	Part Number	Edge Thickness	A (mm)	B (mm)	C (deg)	D (mm)	E (deg)	Weight (kg)	Notes
Center 2-Strap	6I-6404	45	192	252	22.5	102	10	13.4	
RH 2 Strap Corner (4 degrees)	6I-6405	45	192	252	22.5	102	10	13.0	
LH 2 Strap Corner (4 degrees)	6I-6406	45	192	252	22.5	102	10	13.0	
J400 Tips									
Type	Part Number	Dimensions (mm)			Weight (kg)	Retainer	Notes		
		A	B	C					
	General Duty	7T-3402	265	107.4	86	9.3	<p>Pin: 116-7408 Retainer: 116-7409</p>		
	Wide	107-3400	265	206	86	11.1			
	Penetration Plus	168-1409	290	71	86	11.0			
	Penetration	6Y-7409	265	52	86	8.1			
	Spike	159-0400	312	17	86	8.5			
	Double Spike	135-9408	282	142	86	9.9			
Specialty									
	Penetration Long Life (ARM)	124-7409	277	44	86	11.3	Pin: 116-7408 Retainer: 116-7409	The black areas in the pictures of the tips is where the ARM will be applied.	
Wear Protection									
Type	Machine	Part Number	Bolts	Nuts	Washer	Retainer / Pin	Qty.	Notes	
HEX Sidebar Protector	320-336	329-5958	N/A	N/A	N/A	132-0999/275-5982	2	Hex Sidebar Protector uses shear block 330-2174.	
GP Sidecutter, RH	320-336	7Y-0357	6I-6371	2J-3507	N/A	N/A	6		
GP Sidecutter, LH		7Y-0358							
HD Sidecutter, RH	320-336	522-6333	6I-6371	2J-3507	3K-5234	N/A	8		
HD Sidecutter, LH		522-6334							
Modular Edge Shrouds									
Model	Base Edge	Bevel Angle	Part Number	Width (mm)	Weight (kg)	Notes			
320, 324	45mm	22.5°	459-1903	37	2.6				
			459-1904	50	3.5				

60mm Bucket Edge Thickness

Machine Models: 336E/F, 324E-ME, 326F-ME, 329E/F-ME, 352F, 349E/F, 336E/F-ME









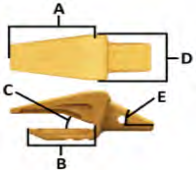

J450/460 Adapters									
Type	Part Number	Edge Thickness	A (mm)	B (mm)	C (deg)	D (mm)	E (deg)	Weight (kg)	Notes
RH 2 Strap Corner (0 degrees)	8E-4465	60	314.5	238.7	22.5	106	14	21.0	
LH 2 Strap Corner (0 degrees)	8E-4466	60	314.5	238.7	22.5	106	14	20.7	
J450/460 Tips									
Type	Part Number	Dimensions (mm)			Weight (kg)	Retainer / Slag Retainer	Notes		
		A	B	C					
	General Duty	9W-8452	294	124	97.4	16.3			
	Wide	107-3450	290	228	97.4	15.1			
	Penetration Plus	159-0459	325	86	97.4	15.5			
	Penetration	9W-8459	290	52	97.4	9.1			
	Spike	159-0450	341	20	97.4	11.7			
	Double Spike	138-6458	311	158	97.4	12.7			
Specialty									
	Penetration Long Life (ARM)	116-7459	306	48	97.4	14.8	Pin: 114-0468 Retainer: 107-3469	The black areas in the pictures of the tips is where the ARM will be applied.	
Wear Protection									
Type	Machine	Part Number	Bolts	Nuts	Washer	Retainer / Pin	Qty.	Notes	
HEX Sidebar Protector	320-336	329-5958	N/A	N/A	N/A	132-0999/275-5982	2	Hex Sidebar Protector uses shear block 330-2174.	
HEX Sidebar Protector	345-385	326-3407	N/A	N/A	N/A	132-0999/132-0998	2		
GP Sidecutter, RH	320-336	7Y-0357	6I-6371	2J-3507	N/A	N/A	6		
GP Sidecutter, LH		7Y-0358							
HD Sidecutter, RH	320-336	522-6333	6I-6371	2J-3507	3K-5234	N/A	8		
HD Sidecutter, LH		522-6334							
HD Sidecutter, RH	345-385	326-3405	1D-4637	2J-3507	3K-5234	N/A	10		
HD Sidecutter, LH		326-3406							
Modular Edge Shrouds									
Model	Base Edge	Bevel Angle	Part Number	Width (mm)	Weight (kg)	Notes			
324, 336, 345	60mm	22.5°	459-9812	55	5.2				
			459-9814	70	6.6				

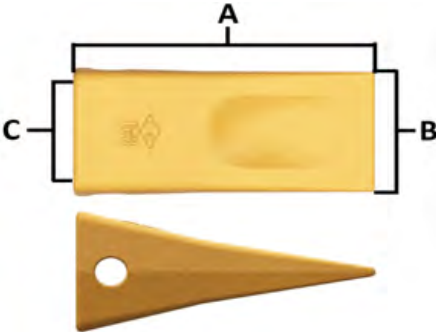
Cat Hydraulic Excavators

PART NUMBERS

50mm Bucket Edge Thickness

Machine Models: 336E/F, 324E-ME, 326F-ME, 329E/F-ME, 352F, 349E/F, 336E/F-ME

J450/460 Adapters									
Type	Part Number	Edge Thickness	A (mm)	B (mm)	C (deg)	D (mm)	E (deg)	Weight (kg)	Notes
Center 2-Strap	159-0464	50	227	287	22.5	116	9	19.2	
RH 2 Strap Corner (4 degrees)	159-0465	50	227	287	22.5	116	9	19.8	
LH 2 Strap Corner (4 degrees)	159-0466	50	227	287	22.5	116	9	19.8	
Center Rock Ripping	107-3464	50	172	207	0	130	46.5	24.7	
Int Rock Ripping	107-3465*	50	172	207	0	130	19	25.0	
Rock Ripping Corner	107-3466	50	NA	NA	NA	113.6	0	23.2	
J450 /460 Tips									
Type	Part Number	Dimensions (mm)			Weight (kg)	Retainer / Slag Retainer	Notes		
		A	B	C					
	General Duty	9W-8452	294	124	97.4	16.3			
	Wide	107-3450	290	228	97.4	15.1			
	Penetration Plus	159-0459	325	86	97.4	15.5			
	Penetration	9W-8459	290	52	97.4	9.1			
	Spike	159-0450	341	20	97.4	11.7			
	Double Spike	138-6458	311	158	97.4	12.7			
Specialty									
	Penetration Long Life (ARM)	116-7459	306	48	97.4	32.6	Pin: 114-0468 Retainer: 107-3469	The black areas in the pictures of the tips is where the ARM will be applied.	
Wear Protection									
Type	Machine	Part Number	Bolts	Nuts	Washer	Retainer / Pin	Qty.	Notes	
HEX Sidebar Protector	320-336	329-5958	N/A	N/A	N/A	132-0999/275-5982	2	Hex Sidebar Protector uses shear block 330-2174.	
HEX Sidebar Protector	345-385	326-3407	N/A	N/A	N/A	132-0999/132-0998	2		
GP Sidecutter, RH	320-336	7Y-0357	6I-6371	2J-3507	N/A	N/A	6		
GP Sidecutter, LH		7Y-0358							
HD Sidecutter, RH	320-336	522-6333	6I-6371	2J-3507	3K-5234	N/A	8		
HD Sidecutter, LH		522-6334							
HD Sidecutter, RH	345-385	326-3405	1D-4637	2J-3507	3K-5234	N/A	10		
HD Sidecutter, LH		326-3406							
Modular Edge Shrouds									
Model	Base Edge	Bevel Angle	Part Number	Width (mm)	Weight (kg)	Notes			
324, 336, 345	60mm	22.5°	459-9812	55	5.2				
			459-9814	70	6.6				

60mm Bucket Edge Thickness

Machine Models: 336E/F, 324E-ME, 326F-ME, 329E/F-ME, 352F, 349E/F, 336E/F-ME

J550 Adapters									
Type	Part Number	Edge Thickness	A (mm)	B (mm)	C (deg)	D (mm)	E (deg)	Weight (kg)	Notes
Center 2-Strap	61-6554	60	279	339	22.5	120	9	31.2	
RH 2 Strap Corner (4 degrees)	61-6555	60	279	339	22.5	120	9	30.4	
LH 2 Strap Corner (4 degrees)	61-6556	60	279	339	22.5	120	9	30.4	
Center Rock Ripping	107-8554	60	250	190	0	160	46.5	41.8	
Int Rock Ripping	107-8555	60	250	190	0	160	19	36.9	
Rock Ripping Corner	107-8556	60	NA	NA	NA	160	0	38.9	
J550 Tips									
Type	Part Number	Dimensions (mm)			Weight (kg)	Retainer Kit	Notes		
		A	B	C					
	General Duty	9W-8552	330	150	118	16.6	<p>Pin: 107-3378 Retainer: 107-8559</p>		
	Wide	107-3550	330	280	118	25.3			
	Penetration Plus	159-0559	370	101	118	23.4			
	Penetration	9W-8559	330	66	118	13.6			
	Spike	159-0550	377	24	118	17.0			
	Double Spike	222-7553	377	194	118	20.3			
Specialty									
	Penetration Long Life (ARM)	113-0559	347	52	118	24.3	Pin: 107-3378 Retainer: 107-8559	The black areas in the pictures of the tips is where the ARM will be applied.	
Wear Protection									
Type	Machine	Part Number	Bolts	Nuts	Washer	Retainer / Pin	Qty.	Notes	
HEX Sidebar Protector	320-336	329-5958	N/A	N/A	N/A	132-0999/275-5982	2	Hex Sidebar Protector uses shear block 330-2174.	
HEX Sidebar Protector	345-385	326-3407	N/A	N/A	N/A	132-0999/132-0998	2		
GP Sidecutter, RH	320-336	7Y-0357	61-6371	2J-3507	N/A	N/A	6		
GP Sidecutter, LH		7Y-0358							
HD Sidecutter, RH	320-336	522-6333	61-6371	2J-3507	3K-5234	N/A	8		
HD Sidecutter, LH		522-6334							
HD Sidecutter, RH	345-385	326-3405	1D-4637	2J-3507	3K-5234	N/A	10		
HD Sidecutter, LH		326-3406							
Modular Edge Shrouds									
Model	Base Edge	Bevel Angle	Part Number	Width (mm)	Weight (kg)	Notes			
324, 336, 345	60mm	22.5°	459-9812	55	5.2				
			459-9814	70	6.6				

Cat Hydraulic Excavators

PART NUMBERS

64mm Bucket Edge Thickness

Machine Models: 336E/F, 324E-ME, 326F-ME, 329E/F-ME, 352F, 349E/F, 336E/F-ME

J550 Adapters									
Type	Part Number	Edge Thickness	A (mm)	B (mm)	C (deg)	D (mm)	E (deg)	Weight (kg)	Notes
Center 2-Strap	3G-9494	64	371	331	22.5	118	15	33.6	
RH 2 Strap Corner (0 degrees)	3G-9495	64	371	331	22.5	118	15	32.6	
LH 2 Strap Corner (0 degrees)	3G-9496	64	371	331	22.5	118	15	32.6	
J550 Tips									
Type	Part Number	Dimensions (mm)			Weight (kg)	Retainer Kit	Notes		
		A	B	C					
	General Duty	9W-8552	330	150	118	16.6	Pin: 107-3378 Retainer: 107-8559		
	Wide	107-3550	330	280	118	25.3			
	Penetration Plus	159-0559	370	101	118	23.4			
	Penetration	9W-8559	330	66	118	13.6			
	Spike	159-0550	377	24	118	17.0			
	Double Spike	222-7553	377	194	118	20.3			
Specialty									
	Penetration Long Life (ARM)	113-0559	347	52	118	24.3	Pin: 107-3378 Retainer: 107-8559	The black areas in the pictures of the tips is where the ARM will be applied.	
Wear Protection									
Type	Machine	Part Number	Bolts	Nuts	Washer	Retainer / Pin	Qty.	Notes	
HEX Sidebar Protector	320-336	329-5958	N/A	N/A	N/A	132-0999/275-5982	2	Hex Sidebar Protector uses shear block 330-2174.	
HEX Sidebar Protector	345-385	326-3407	N/A	N/A	N/A	132-0999/132-0998	2		
GP Sidecutter, RH	320-336	7Y-0357	6I-6371	2J-3507	N/A	N/A	6		
GP Sidecutter, LH		7Y-0358							
HD Sidecutter, RH	320-336	522-6333	6I-6371	2J-3507	3K-5234	N/A	8		
HD Sidecutter, LH		522-6334							
HD Sidecutter, RH	345-385	326-3405	1D-4637	2J-3507	3K-5234	N/A	10		
HD Sidecutter, LH		326-3406							
Modular Edge Shrouds									
Model	Base Edge	Bevel Angle	Part Number	Width (mm)	Weight (kg)	Notes			
324, 336, 345	60mm	22.5°	459-9812	55	5.2				
			459-9814	70	6.6				

70mm Bucket Edge Thickness

Machine Models: 336E/F, 324E-ME, 326F-ME, 329E/F-ME, 352F, 349E/F, 336E/F-ME









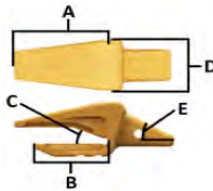

J550 Adapters									
Type	Part Number	Edge Thickness	A (mm)	B (mm)	C (deg)	D (mm)	E (deg)	Weight (kg)	Notes
Center 2-Strap	275-2759	70	269.7	329.7	22.5	140	9	35.3	
RH 2 Strap Corner (0 degrees)	275-2760	70	269.7	329.7	22.5	140	9	35.3	
LH 2 Strap Corner (0 degrees)	275-2760	70	269.7	329.7	22.5	140	9	35.3	
J550 Tips									
Type	Part Number	Dimensions (mm)			Weight (kg)	Retainer Kit	Notes		
		A	B	C					
	General Duty	9W-8552	330	150	118	16.6			
	Wide	107-3550	330	280	118	25.3			
	Penetration Plus	159-0559	370	101	118	23.4			
	Penetration	9W-8559	330	66	118	13.6			
	Spike	159-0550	377	24	118	17.0			
	Double Spike	222-7553	377	194	118	20.3			
Specialty									
	Penetration Long Life (ARM)	113-0559	347	52	118	24.3	Pin: 107-3378 Retainer: 107-8559	The black areas in the pictures of the tips is where the ARM will be applied.	
Wear Protection									
Type	Machine	Part Number	Bolts	Nuts	Washer	Retainer / Pin	Qty.	Notes	
HEX Sidebar Protector	320-336	329-5958	N/A	N/A	N/A	132-0999/275-5982	2	Hex Sidebar Protector uses shear block 330-2174.	
HEX Sidebar Protector	345-385	326-3407	N/A	N/A	N/A	132-0999/132-0998	2		
GP Sidecutter, RH	320-336	7Y-0357	6I-6371	2J-3507	N/A	N/A	6		
GP Sidecutter, LH		7Y-0358							
HD Sidecutter, RH	320-336	522-6333	6I-6371	2J-3507	3K-5234	N/A	8		
HD Sidecutter, LH		522-6334							
HD Sidecutter, RH	345-385	326-3405	1D-4637	2J-3507	3K-5234	N/A	10		
HD Sidecutter, LH		326-3406							
Modular Edge Shrouds									
Model	Base Edge	Bevel Angle	Part Number	Width (mm)	Weight (kg)	Notes			
324, 336, 345	60mm	22.5°	459-9812	55	5.2				
			459-9814	70	6.6				

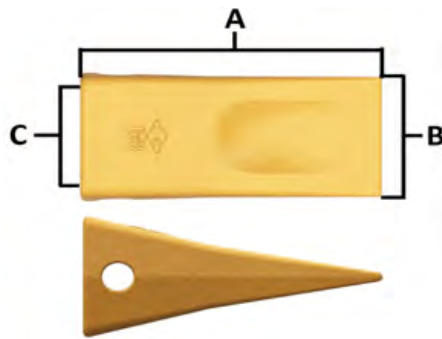
Cat Hydraulic Excavators

PART NUMBERS

70mm Bucket Edge Thickness

Machine Models: 352F, 349E/F, 336E/F-ME, 345D-ME, 349F-ME

J600 Adapters										
Type	Part Number	Edge Thickness	A (mm)	B (mm)	C (deg)	D (mm)	E (deg)	Weight (kg)	Notes	
Center 2-Strap	61-6604	70	310	365	22.5	144	8	47.8		
RH 2 Strap Corner (4 degrees)	61-6605	70	310	365	22.5	144	8	46.7		
LH 2 Strap Corner (4 degrees)	61-6606	70	310	365	22.5	144	8	46.7		
Center 2-Strap	61-8604	70	310	365	22.5	188	15	53.5		
RH 2 Strap Corner	61-8605	70	310	365	22.5	188	15	52.6		
LH 2 Strap Corner	61-8606	70	310	365	22.5	188	15	52.6		
Center Rock Ripping	107-8604	70	262	207	0	200	46.5	68.9		
Int Rock Ripping	107-8605	70	262	207	0	200	19	59.9		
Rock Ripping Corner	107-8606	70	NA	NA	NA	200	0	62.0		
J600 Tips										
Type	Part Number	Dimensions (mm)			Weight (kg)	Retainer Kit	Notes			
		A	B	C						
	General Duty	61-6602	388	170	140.8	27.8	Pin: 113-9608 Retainer: 113-9609			
	Penetration Plus	159-0607	425	79	140.8	37.5				
	Penetration	71-7609	388	82	140.8	25.4				
	Spike	159-0600	445	30	140.8	28.3				
	Double Spike	222-7603	445	222	140.8	32.9				
Specialty										
	Penetration Long Life (ARM)	119-9609	408	60	140.8	38.2	Pin: 113-9608 Retainer: 113-9609	The black areas in the pictures of the tips is where the ARM will be applied.		
Wear Protection										
Type	Machine	Part Number	Bolts	Nuts	Washer	Retainer / Pin	Qty.	Notes		
HEX Sidebar Protector	320-336	329-5958	N/A	N/A	N/A	132-0999/275-5982	2	Hex Sidebar Protector uses shear block 330-2174.		
HEX Sidebar Protector	345-385	326-3407	N/A	N/A	N/A	132-0999/132-0998	2			
GP Sidecutter, RH	320-336	7Y-0357	6I-6371	2J-3507	N/A	N/A	6			
GP Sidecutter, LH		7Y-0358								
HD Sidecutter, RH	320-336	522-6333	6I-6371	2J-3507	3K-5234	N/A	8			
HD Sidecutter, LH		522-6334								
HD Sidecutter, RH	345-385	326-3405	1D-4637	2J-3507	3K-5234	N/A	10			
HD Sidecutter, LH		326-3406								
Modular Edge Shrouds										
Model	Base Edge	Bevel Angle	Part Number	Width (mm)	Weight (kg)	Notes				
336, 345	70mm	22.5°	459-9822	55	6.8					
			459-9823	68	8.5					

80mm Bucket Edge Thickness

Machine Models: 352F, 349E/F, 336E/F-ME, 345D-ME, 349F-ME

J600 Adapters									
Type	Part Number	Edge Thickness	A (mm)	B (mm)	C (deg)	D (mm)	E (deg)	Weight (kg)	Notes
Center 2-Strap	113-9604	80	310	365	22.5	144	8	48.3	
RH 2 Strap Corner (4 degrees)	113-9605	80	310	365	22.5	144	8	49.7	
LH 2 Strap Corner (4 degrees)	113-9606	80	310	365	22.5	144	8	49.7	
J600 Tips									
Type	Part Number	Dimensions (mm)			Weight (kg)	Retainer Kit	Notes		
		A	B	C					
	General Duty	61-6602	388	170	140.8	27.8	Pin: 113-9608 Retainer: 113-9609		
	Penetration Plus	159-0607	425	79	140.8	37.5			
	Penetration	71-7609	388	82	140.8	25.4			
	Spike	159-0600	445	30	140.8	28.3			
	Double Spike	222-7603	445	222	140.8	32.9			
Specialty									
	Penetration Long Life (ARM)	119-9609	408	60	140.8	38.2	Pin: 113-9608 Retainer: 113-9609	The black areas in the pictures of the tips is where the ARM will be applied.	
Wear Protection									
Type	Machine	Part Number	Bolts	Nuts	Washer	Retainer / Pin	Qty.	Notes	
HEX Sidebar Protector	320-336	329-5958	N/A	N/A	N/A	132-0999/275-5982	2	Hex Sidebar Protector uses shear block 330-2174.	
HEX Sidebar Protector	345-385	326-3407	N/A	N/A	N/A	132-0999/132-0998	2		
GP Sidecutter, RH	320-336	7Y-0357	61-6371	2J-3507	N/A	N/A	6		
GP Sidecutter, LH		7Y-0358							
HD Sidecutter, RH	320-336	522-6333	61-6371	2J-3507	3K-5234	N/A	8		
HD Sidecutter, LH		522-6334							
HD Sidecutter, RH	345-385	326-3405	1D-4637	2J-3507	3K-5234	N/A	10		
HD Sidecutter, LH		326-3406							
Modular Edge Shrouds									
Model	Base Edge	Bevel Angle	Part Number	Width (mm)	Weight (kg)	Notes			
336, 345	70mm	22.5°	459-9822	55	6.8				
			459-9823	68	8.5				

Cat Hydraulic Excavators

PART NUMBERS







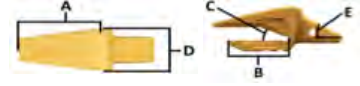

80mm Bucket Edge Thickness

Machine Models: 374D/F, 374D/F-ME, 390D/F

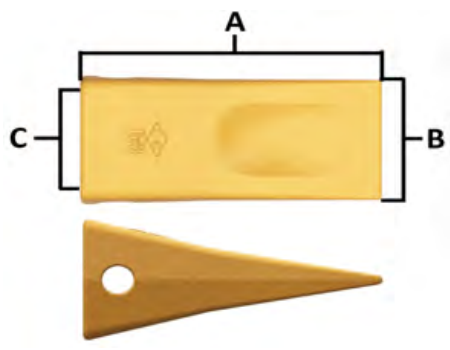
J700 Adapters									
Type	Part Number	Edge Thickness	A (mm)	B (mm)	C (deg)	D (mm)	E (deg)	Weight (kg)	Notes
Center 2-Strap	132-4704	80	435	335	22.5	154	9	64.5	
RH 2 Strap Corner (4 degrees)	132-4705	80	414	314	22.5	154	9	64.9	
LH 2 Strap Corner (4 degrees)	132-4706	80	414	314	22.5	154	9	64.9	
J700 Tips									
Type	Part Number	Dimensions (mm)			Weight (kg)	Retainer Kit	Notes		
		A	B	C					
	General Duty	4T-4702	379	180	150.6	42.4	Pin: 113-4708 Retainer: 113-4709		
	Penetration Plus	171-1709	455	132	150.6	51.2			
	Penetration	4T-4709	415	80	150.6	38.0			
	Spike	136-8700	465	36	150.6	39.4			
Wear Protection									
Type	Machine	Part Number	Bolts	Nuts	Washer	Retainer / Pin	Qty.	Notes	
HEX Sidebar Protector	374, 390	329-5955	N/A	N/A	N/A	132-0999/132-1008	2	Hex Sidebar Protector uses shear block 330-2174.	
HD Sidecutter, RH	374, 390	326-3405	7X-0410*	2J-3507	3K-5234	N/A	10		
HD Sidecutter, LH		326-3406							
Modular Edge Shrouds									
Model	Base Edge	Bevel Angle	Part Number	Width (mm)	Weight (kg)	Notes			
374, 390	80mm	22.5°	459-9824	58	10.0				
			459-9825	70	12.0				





90mm Bucket Edge Thickness

Machine Models: 374D/F, 374D/F-ME, 390D/F

J700 Adapters									
Type	Part Number	Edge Thickness	A (mm)	B (mm)	C (deg)	D (mm)	E (deg)	Weight (kg)	Notes
Center 2-Strap	222-7700	90	464	314	35	190	8	84.1	
J700 Tips									
Type	Part Number	Dimensions (mm)			Weight (kg)	Retainer Kit	Notes		
		A	B	C					
	General Duty	4T-4702	379	180	150.6	42.4	Pin: 113-4708 Retainer: 113-4709		
	Penetration Plus	171-1709	455	132	150.6	51.2			
	Penetration	4T-4709	415	80	150.6	38.0			
	Spike	136-8700	465	36	150.6	39.4			
Wear Protection									
Type	Machine	Part Number	Bolts	Nuts	Washer	Retainer / Pin	Qty.	Notes	
HEX Sidebar Protector	374, 390	329-5955	N/A	N/A	N/A	132-0999/132-1008	2	Hex Sidebar Protector uses shear block 330-2174.	
HD Sidecutter, RH	374, 390	326-3405	7X-0410*	2J-3507	3K-5234	N/A	10		
HD Sidecutter, LH		326-3406							
Modular Edge Shrouds									
Model	Base Edge	Bevel Angle	Part Number	Width (mm)	Weight (kg)	Notes			
374, 390	80mm	22.5°	459-9824	58	10.0				
			459-9825	70	12.0				

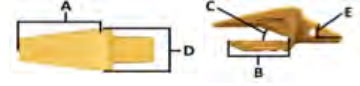
100mm Bucket Edge Thickness

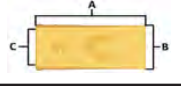
Machine Models: 390D/F-ME

J800 Adapters									
Type	Part Number	Edge Thickness	A (mm)	B (mm)	C (deg)	D (mm)	E (deg)	Weight (kg)	Notes
Center 2-Strap	357-6516	100	435	335	35	220	8	104.3	
J800 Tips									
Type	Part Number	Dimensions (mm)			Weight (kg)	Retainer Kit	Notes		
		A	B	C					
 Penetration	117-6809	455	105	169.6	54.6	Pin: 134-1808 Retainer: 134-1809			
Wear Protection									
Type	Machine	Part Number	Bolts	Nuts	Washer	Retainer / Pin	Qty.	Notes	
HEX Sidebar Protector	374, 390	329-5955	N/A	N/A	N/A	132-0999/132-1008	2	Hex Sidebar Protector uses shear block 330-2174.	
HD Sidecutter, RH	374, 390	326-3405	7X-0410*	2J-3507	3K-5234	N/A	10		
HD Sidecutter, LH		326-3406							
Modular Edge Shrouds									
Model	Base Edge	Bevel Angle	Part Number	Width (mm)	Weight (kg)	Notes			
390	100mm	35°	449-0904	70	17.0				
			449-0905	85	21.0				

Dozers



Cat Dozers

OPTIONS

CUTTING EDGE AND END BIT OPTIONS

We have Ground Engaging Tools (GET) for your blade no matter the application or environment. As machines grow larger, their jobs become tougher, and so does Cat GET. Maximum wear life and breakage resistance is possible with our steel alloy that can endure 2x the heat and pressure of traditional blade steel products. Consult your local Cat Dealer to help determine the best cutting edge system for your application to give you the lowest cost per hour.

SMALL DOZER GET OPTIONS

A.R.M.
OPTION
AVAILABLE



Level Cut / Finish (Factory First Fit)

- Recommended for finish and semi-finish dozing
- Matches cutting edge's depth of cut
- Low-impact, low abrasion materials only



Level Cut Reversible

- Reversible finish and semi-finish dozing end bits
- Used in applications where curbing is not a requirement



Level Cut Extended Reversible

- Longer reversible finish and semi-dozing dozing end bits used to extend the length of the blade
- Used in applications where curbing is not a requirement

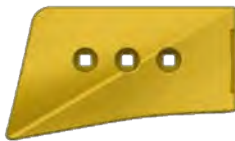

Performance End Bits

- Forward profile for penetration in tough soil
- Excellent blade control in tough production dozing applications
- Superior finish grading capabilities
- Match with Extended Wear Life (EWL) cutting edges for long wear life





IT'S EASY TO TELL WHEN IT'S TIME TO REPLACE MY EDGES BEFORE ANY BLADE DAMAGE HAPPENS. I CAN INSPECT THESE EDGES SAFELY FROM GROUND LEVEL DURING MY DAILY MACHINE WALK AROUND.

Mark Burris
Fowler Construction

Protect Your Blade Investment with Precision Cutting Edges

Cat Precision Cutting edges are the only cutting edges with wear indicators rolled right into the edge material. These wear indicators ensure you know when to flip your cutting edges to avoid costly blade repairs. Precision Cutting Edges are:

- Reversible cutting edges sized to fit machines that use 6.5 cutting edges
- Designed to provide the lowest cost per hour operation with 20% more wear material than legacy cutting edges
- Offered in a new thickness that will provide 40% more wear material
- Designed to reduce your throw away weight with optimized wear material placement
- Designed by Caterpillar and manufactured to our specifications – ensuring reliability and durability
- Made from proven DH2 Cat materials
- Manufactured with built in wear indicators to let you know when to replace
- Available when you need them exclusively through the Cat dealer network
- Backed by the standard Caterpillar warranty against breakage





Cat Dozers

PART NUMBERS

D3 XL Blades

Blade Serial Numbers: 6EH, 15W, 86U, 8SU, 1GP, 2JP, 9RH, 5LH





Applies to: D3B, D3C, D3G

End Bits and Cutting Edges 6 1/2"										
Type		End Bits				Edges				Notes
		Thickness	End Bits	Hardware	Position	Thickness	Edges	Quantity	Hardware	
	Precision Level Cut	18	462-8032 462-8033	3 3	RH LH	18	467-8024	2	6	Equipped from factory GP: (500-3874)
		21	472-4112 472-4113	3 3	RH LH	21	472-4114	2	6	GP: (500-3874)
	Level Cut	19	469-4405 469-4404	3 3	RH LH	19				
	(Precision) Level Cut Reversible	18	491-3754 (2 Req'd)	3	RH LH	18	467-8024	2	6	GP: 507-2792*
		21	491-3755 (2 Req'd)	3	RH LH	21	472-4114	2	6	GP: 507-2793*
	Extended Cut Reversible ¹	16	195-7193 (2 Req'd)	3	RH LH	16	4T-6230	2	6	GP: 507-2789*
Specialty										
	Performance End Bits	19	480-8939 480-8940	3 3	RH LH	21	472-4114	2	6	GP: (522-3995)
	A.R.M. ¹	16	477-7839 477-7840	3 3	RH LH					
Hardware, Repair Parts and Wear Protection										
Type	Description		Part Number	Quantity	Notes					
Hardware	Bolts	5/8-11 x 2-1/4	3F-5108	18	Ensure Base Edge is flat and not excessively worn Clean and remove any paint on mating surfaces Torque, Bang, Torque					
	Nuts	5/8-11	4K-0367	18						
	Washers	5/8"	5P-8247	18						
Blade Repair	Edge Support		(183-9073)	1						

¹Traditional Design

D3 XL Blades

Applies to: D3K, D3K2, D1

End Bits and Cutting Edges 6 1/2"										
Type		End Bits				Edges				Notes
		Thickness	End Bits	Hardware	Position	Thickness	Edges	Quantity	Hardware	
	(Precision) Level Cut	18	462-8032 462-8033	3 3	RH LH	18	467-7955	2	6	Equipped from factory GP:(467-7951)
		21	472-4112 472-4113	3 3	RH LH	21	472-4116	2	6	GP: 500-3869*
	(Precision) Level Cut Reversible	18	491-3754 (2 Req'd)	3	RH LH	18	467-7955	2	6	GP: 507-2794*
		21	491-3755 (2 Req'd)	3	RH LH	21	472-4116	2	6	GP: 507-2795*
	Extended Cut Reversible ¹	16	195-7193 (2 Req'd)	3	RH LH	16	140-6836	2	6	GP: 507-2791*
Specialty										
	Performance End Bits	19	480-8939 480-8940	3 3	RH LH	21	472-4116	2	6	GP: (522-3996)
	A.R.M. ¹	16	477-7839 477-7840	3 3	RH LH					
Hardware, Repair Parts and Wear Protection										
Type	Description		Part Number	Quantity	Notes					
Hardware	Bolts	5/8-11 x 2-1/4	3F-5108	18	Ensure Base Edge is flat and not excessively worn Clean and remove any paint on mating surfaces Torque, Bang, Torque					
	Nuts	5/8-11	4K-0367	18						
	Washers	5/8"	5P-8247	18						
Blade Repair	Edge Support		(255-1408)	1						

¹Traditional Design





Cat Dozers

PART NUMBERS

D3 LGP Blades

Blade Serial Numbers: 96X, 5WH, 8JP





Applies to: D3B, D3C, D3G, D3K, D3K2, D1

End Bits and Cutting Edges 6 1/2"										
Type		End Bits				Edges				Notes
		Thickness	End Bits	Hardware	Position	Thickness	Edges	Quantity	Hardware	
	Precision Level Cut	18	462-8032 462-8033	3 3	RH LH	18	467-7956	2	6	Equipped from factory GP: (467-7953)
		21	472-4112 472-4113	3 3	RH LH	21	472-4122	2	6	GP: 500-3870*
	Precision Level Cut Reversible	18	491-3754 (2 Req'd)	3	RH LH	18	467-7956	2	6	GP: (507-2797)
		21	491-3755 (2 Req'd)	3	RH LH	21	472-4122	2	6	GP: (507-2798)
	Extended Cut Reversible ¹	16	195-7193 (2 Req'd)	3	RH LH	16	4T-6232	2	6	GP: (507-2796)
Specialty										
	Performance End Bits	19	480-8939 480-8940	3 3	RH LH	21	472-4122	2	6	GP: (522-3997)
	A.R.M. ¹	16	477-7839 477-7840	3 3	RH LH					
Hardware, Repair Parts and Wear Protection										
Type	Description		Part Number	Quantity	Notes					
Hardware	Bolts	5/8-11 x 2-1/4	3F-5108	18	Ensure Base Edge is flat and not excessively worn Clean and remove any paint on mating surfaces Torque, Bang, Torque					
	Nuts	5/8-11	4K-0367	18						
	Washers	5/8"	5P-8247	18						
Blade Repair	Edge Support		(255-1376)	1						

¹Traditional Design

D3 LGP Narrow 115" Blades

Applies to: D3G, D3K, D3K2, D1

End Bits and Cutting Edges 6 1/2"										
Type		End Bits				Edges				Notes
		Thickness	End Bits	Hardware	Position	Thickness	Edges	Quantity	Hardware	
	Precision Level Cut	18	462-8032 462-8033	3 3	RH LH	18	467-7957	2	7	Equipped from factory GP: (467-7954)
		21	472-4112 472-4113	3 3	RH LH	21	472-4120	2	7	GP: 500-3873*
	Precision Level Cut Reversible	18	491-3754 (2 Req'd)	3	RH LH	18	467-7957	2	7	GP: 507-2800*
		21	491-3755 (2 Req'd)	3	RH LH	21	472-4120	2	7	GP: 507-2801*
	Extended Cut Reversible ¹	16	195-7193 (2 Req'd)	3	RH LH	16	157-7338	2	7	GP: 507-2799*
Specialty										
	Performance End Bits	19	480-8939 480-8940	3 3	RH LH	21	472-4120	2	7	GP: (522-3998)
	A.R.M. ¹	16	477-7839 477-7840	3 3	RH LH					
Hardware, Repair Parts and Wear Protection										
Type	Description		Part Number	Quantity	Notes					
Hardware	Bolts	5/8-11 x 2-1/4	3F-5108	18	Ensure Base Edge is flat and not excessively worn Clean and remove any paint on mating surfaces Torque, Bang, Torque					
	Nuts	5/8-11	4K-0367	18						
	Washers	5/8"	5P-8247	18						
Blade Repair	Edge Support		(255-1500)	1						

¹Traditional Design





Cat Dozers

PART NUMBERS

D4 XL Blades

Blade Serial Numbers: 9SH





Applies to: D4C, D4G

End Bits and Cutting Edges 6 1/2"										
Type		End Bits				Edges				Notes
		Thickness	End Bits	Hardware	Position	Thickness	Edges	Quantity	Hardware	
	(Precision) Level Cut	18	462-8032 462-8033	3 3	RH LH	18	467-8026	2	6	Equipped from factory GP: 500-3878*
		21	472-4112 472-4113	3 3	RH LH	21	472-4117	2	6	GP: 500-3879*
	(Precision) Level Cut Reversible	18	491-3754 (2 Req'd)	3	RH LH	18	467-8026	2	6	GP: 507-2804*
		21	491-3755 (2 Req'd)	3	RH LH	21	472-4117	2	6	GP: 507-2805*
	Extended Cut Reversible ¹	16	195-7193 (2 Req'd)	3	RH LH	16	104-9634	2	6	GP: 507-2803*
Specialty										
	Performance End Bits	19	480-8939 480-8940	3 3	RH LH	21	472-4117	2	6	GP: 522-3999*
	A.R.M. ¹	16	477-7839 477-7840	3 3	RH LH					
Hardware, Repair Parts and Wear Protection										
Type	Description		Part Number	Quantity	Notes					
Hardware	Bolts	5/8-11 x 2-1/4	3F-5108	18	Ensure Base Edge is flat and not excessively worn Clean and remove any paint on mating surfaces Torque, Bang, Torque					
	Nuts	5/8-11	4K-0367	18						
	Washers	5/8"	5P-8247	18						
Blade Repair	Edge Support		178-9322*	1						

¹Traditional Design

D4 XL Blades

Applies to: D4K, D4K2, D2

End Bits and Cutting Edges 6 1/2"										
Type		End Bits				Edges				Notes
		Thickness	End Bits	Hardware	Position	Thickness	Edges	Quantity	Hardware	
	(Precision) Level Cut	18	462-8032 462-8033	3 3	RH LH	18	462-8030	2	6	Equipped from factory GP: (467-7949)
		21	472-4112 472-4113	3 3	RH LH	21	472-4118	2	6	GP: 500-3871*
	(Precision) Level Cut Reversible	18	491-3754 (2 Req'd)	3	RH LH	18	462-8030	2	6	GP: (507-2820)
		21	491-3755 (2 Req'd)	3	RH LH	21	472-4118	2	6	GP: (507-2809)
	Extended Cut Reversible ¹	16	195-7193 (2 Req'd)	3	RH LH	16	255-1429	2	6	GP: (507-2807)
Specialty										
	Performance End Bits	19	480-8939 480-8940	3 3	RH LH	21	472-4118	2	6	GP: 522-4000*
	A.R.M. ¹	16	477-7839 477-7840	3 3	RH LH					
Hardware, Repair Parts and Wear Protection										
Type	Description		Part Number	Quantity	Notes					
Hardware	Bolts	5/8-11 x 2-1/4	3F-5108	18	Ensure Base Edge is flat and not excessively worn Clean and remove any paint on mating surfaces Torque, Bang, Torque					
	Nuts	5/8-11	4K-0367	18						
	Washers	5/8"	5P-8247	18						
Blade Repair	Edge Support		(255-1465)	1						

¹Traditional Design



Cat Dozers

PART NUMBERS

D4 LGP 119" Blades

Blade Serial Numbers: 84E, 19J, 45J

Applies to: D4E

End Bits and Cutting Edges 8"										
Type		End Bits				Edges				Notes
		Thickness	End Bits	Hardware	Position	Thickness	Edges	Quantity	Hardware	
	Level Cut	19	4T-3051	6	RH	16	4T-2972	2	4	Equipped from factory GP: (7J-2791)
			4T-3052	6	LH		4T-2982	1	7	
	HC	22	3G-8321	6	RH	19	4T-3028	2	4	GP: 507-2812*
			3G-8322	6	LH		4T-3029	1	7	
Hardware, Repair Parts and Wear Protection										
Type	Description		Part Number	Quantity	Notes					
Hardware	Bolts	5/8-11 x 2	4F-3654	27	Ensure Base Edge is flat and not excessively worn Clean and remove any paint on mating surfaces Torque, Bang, Torque					
	Nuts	5/8-11	4K-0367	27						
	Washers	5/8"	5P-8247	27						

D4 LGP 122" Blades

Blade Serial Numbers: 52E, 96E, 26F, 95G, 33R





Applies to: D4E

End Bits and Cutting Edges 8"										
Type		End Bits				Edges				Notes
		Thickness	End Bits	Hardware	Position	Thickness	Edges	Quantity	Hardware	
	Level Cut	19	4T-3043	3	RH	16	4T-2974	1	5	Equipped from factory GP: (7J-2777)
			4T-3044	3	LH		4T-2973	2	6	
	HC	22	5A-4565	3	RH	16	4T-2974	1	5	
			5A-4566	3	LH		4T-2973	2	6	
Hardware, Repair Parts and Wear Protection										
Type	Description		Part Number	Quantity	Notes					
Hardware	Bolts	5/8-11 x 2	4F-3654	17	Ensure Base Edge is flat and not excessively worn Clean and remove any paint on mating surfaces Torque, Bang, Torque					
	Bolts	5/8-11 x 2-1/4	3F-5108	6						
	Nuts	5/8-11	4K-0367	23						
	Washers	5/8"	5P-8247	23						

D4 XL Blades

Blade Serial Numbers: 2YH

Applies to: D4B, D4C

End Bits and Cutting Edges 6 1/2"										
Type		End Bits				Edges				Notes
		Thickness	End Bits	Hardware	Position	Thickness	Edges	Quantity	Hardware	
	(Precision) Level Cut	18	462-8032 462-8033	3 3	RH LH	18	467-8024	2	6	Equipped from factory GP: (500-3874)
		21	472-4112 472-4113	3 3	RH LH	21	472-4114	2	6	GP: (500-3875)
	(Precision) Level Cut Reversible	18	491-3754 (2 Req'd)	3	RH LH	18	467-8024	2	6	GP: 507-2792*
		21	491-3755 (2 Req'd)	3	RH LH	21	472-4114	2	6	GP: 507-2793*
	Extended Cut Reversible ¹	16	195-7193 (2 Req'd)	3	RH LH	16	4T-6230	2	6	GP: 507-2789*
Specialty										
	Performance End Bits	19	480-8939 480-8940	3 3	RH LH	21	472-4114	2	6	GP: (522-3995)
	A.R.M. ¹	16	477-7839 477-7840	3 3	RH LH					
Hardware, Repair Parts and Wear Protection										
Type	Description		Part Number	Quantity	Notes					
Hardware	Bolts	5/8-11 x 2-1/4	3F-5108	18	Ensure Base Edge is flat and not excessively worn Clean and remove any paint on mating surfaces Torque, Bang, Torque					
	Nuts	5/8-11	4K-0367	18						
	Washers	5/8"	5P-8247	18						

¹Traditional Design





Cat Dozers

PART NUMBERS

D4 LGP Blades

Blade Serial Numbers: 8YP

Applies to: D4C



End Bits and Cutting Edges 6 1/2"										
Type		End Bits				Edges				Notes
		Thickness	End Bits	Hardware	Position	Thickness	Edges	Quantity	Hardware	
	(Precision) Level Cut	16	6Y-5839 6Y-5840	3 3	RH LH	16	141-2238	2	8	Equipped from factory GP: (141-2239)
	Level Cut	19	469-4405 469-4404	3 3	RH LH					
	Level Cut Reversible	16	4T-6229 (2 Req'd)	3	RH LH	16	141-2238	2	8	GP: 507-2810*
	Extended Cut Reversible ¹	16	195-7193 (2 Req'd)	3	RH LH	16	141-2238	2	8	GP: 507-2811*
Specialty										
	A.R.M. ¹	16	477-7839 477-7840	3 3	RH LH					
Hardware, Repair Parts and Wear Protection										
Type	Description		Part Number	Quantity	Notes					
Hardware	Bolts	5/8-11 x 2-1/4	3F-5108	22	Ensure Base Edge is flat and not excessively worn Clean and remove any paint on mating surfaces Torque, Bang, Torque					
	Nuts	5/8-11	4K-0367	22						
	Washers	5/8"	5P-8247	22						

¹Traditional Design

D4 LGP 119" Blades

Blade Serial Numbers: 84E, 19J, 45J

Applies to: D4E

End Bits and Cutting Edges 8"										
Type		End Bits				Edges				Notes
		Thickness	End Bits	Hardware	Position	Thickness	Edges	Quantity	Hardware	
	Level Cut	19	4T-3051	6	RH	16	4T-2972	2	4	Equipped from factory GP: (7J-2791)
			4T-3052	6	LH		4T-2982	1	7	
	HC	22	3G-8321	6	RH	19	4T-3028	2	4	GP: 507-2812*
			3G-8322	6	LH		4T-3029	1	7	
Hardware, Repair Parts and Wear Protection										
Type	Description		Part Number	Quantity	Notes					
Hardware	Bolts	5/8-11 x 2	4F-3654	27	Ensure Base Edge is flat and not excessively worn Clean and remove any paint on mating surfaces Torque, Bang, Torque					
	Nuts	5/8-11	4K-0367	27						
	Washers	5/8"	5P-8247	27						

D4 LGP 122" Blades

Blade Serial Numbers: 52E, 96E, 26F, 95G, 33R

Applies to: D4E

End Bits and Cutting Edges 8"										
Type		End Bits				Edges				Notes
		Thickness	End Bits	Hardware	Position	Thickness	Edges	Quantity	Hardware	
	Level Cut	19	4T-3043	3	RH	16	4T-2974	1	5	Equipped from factory GP: (7J-2777)
			4T-3044	3	LH		4T-2973	2	6	
	HC	22	5A-4565	3	RH	16	4T-2974	1	5	
			5A-4566	3	LH		4T-2973	2	6	
Hardware, Repair Parts and Wear Protection										
Type	Description		Part Number	Quantity	Notes					
Hardware	Bolts	5/8-11 x 2	4F-3654	17	Ensure Base Edge is flat and not excessively worn Clean and remove any paint on mating surfaces Torque, Bang, Torque					
	Bolts	5/8-11 x 2-1/4	3F-5108	6						
	Nuts	5/8-11	4K-0367	23						
	Washers	5/8"	5P-8247	23						





Cat Dozers

PART NUMBERS

D4 XL 115" Blades

Blade Serial Numbers: 6XH

Applies to: D4H





End Bits and Cutting Edges 8"										
Type		End Bits				Edges				Notes
		Thickness	End Bits	Hardware	Position	Thickness	Edges	Quantity	Hardware	
	Level Cut	19	8E-9379 8E-9378	4 4	RH LH	16	8E-9377	2	7	Equipped from factory GP: (8E-9376)
		25	323-4279 323-4280	4 4	RH LH	19	4T-6659	2	7	GP: 507-2814*
	Level Cut Reversible	19	3G-4285 (2 req'd)	4	RH LH	16	8E-9377	2	7	GP: 507-2815*
	GP (HC)	22	140-6787 140-6788	4 4	RH LH	19	4T-6659	2	7	GP: 507-2816*
	EWL	25	462-4828 462-4829	4 4	RH LH	19	4T-6659	2	7	GP: 507-2817*
Specialty										
	A.R.M. ¹	19	473-9970 473-9971		RH LH			2	7	GP: 507-2818*
Hardware, Repair Parts and Wear Protection										
Type	Description		Part Number	Quantity	Notes					
Hardware	Bolts	3/4-10 x 2-1/2	5J-4773	22	Ensure Base Edge is flat and not excessively worn Clean and remove any paint on mating surfaces Torque, Bang, Torque					
	Nuts	3/4-10	2J-3506	22						
	Washers	3/4"	5P-8248	22						

¹Traditional Design

D4 LGP 115" Blades

Blade Serial Numbers: 4AC, 5NH, 7EH, 9ZB

Applies to: D4H

End Bits and Cutting Edges 8"										
Type		End Bits				Edges				Notes
		Thickness	End Bits	Hardware	Position	Thickness	Edges	Quantity	Hardware	
	Level Cut	19	8E-9379 8E-9378	4 4	RH LH	16	3G-9306	2	6	Equipped from factory GP: (3G-9308)
		25	323-4279 323-4280	4 4	RH LH			2	6	
	Level Cut Reversible	19	3G-4285 (2 req'd)	4	RH LH	16	3G-9306	2	6	GP: 507-2819*
	GP (HC)	22	140-6787 140-6788	4 4	RH LH			2	6	
	EWL	25	462-4828 462-4829	4 4	RH LH			2	6	
Specialty										
	A.R.M. ¹	19	473-9970 473-9971		RH LH	19		2	6	
Hardware, Repair Parts and Wear Protection										
Type	Description		Part Number	Quantity	Notes					
Hardware	Bolts	3/4-10 x 2-1/2	5J-4773	20	Ensure Base Edge is flat and not excessively worn Clean and remove any paint on mating surfaces Torque, Bang, Torque					
	Nuts	3/4-10	2J-3506	20						
	Washers	3/4"	5P-8248	20						

¹Traditional Design





Cat Dozers

PART NUMBERS

D4 LGP Blades

Blade Serial Numbers: 4GH, 9YH, 8ZH





Applies to: D4C, D4G, D4K, D4K2, D2

End Bits and Cutting Edges 6 1/2"										
Type		End Bits				Edges				Notes
		Thickness	End Bits	Hardware	Position	Thickness	Edges	Quantity	Hardware	
	(Precision) Level Cut	18	462-8032 462-8033	3 3	RH LH	18	467-7956	2	6	Equipped from factory GP: (467-7953)
		21	472-4112 472-4113	3 3	RH LH	21	472-4122	2	6	GP: 500-3870*
	(Precision) Level Cut Reversible	18	491-3754 (2 Req'd)	3	RH LH	18	467-7956	2	6	GP: (507-2797)
		21	491-3755 (2 Req'd)	3	RH LH	21	472-4122	2	6	GP: (507-2798)
	Extended Cut Reversible ¹	16	195-7193 (2 Req'd)	3	RH LH	16	4T-6232	2	6	GP: (507-2796)
Specialty										
	Performance End Bits	19	480-8939 480-8940	3 3	RH LH	21	472-4122	2	6	GP: (522-3997)
	A.R.M. ¹	16	477-7839 477-7840	3 3	RH LH					
Hardware, Repair Parts and Wear Protection										
Type	Description		Part Number	Quantity	Notes					
Hardware	Bolts	5/8-11 x 2-1/4	3F-5108	18	Ensure Base Edge is flat and not excessively worn Clean and remove any paint on mating surfaces Torque, Bang, Torque					
	Nuts	5/8-11	4K-0367	18						
	Washers	5/8"	5P-8247	18						

¹Traditional Design

D4 LGP Narrow 115" Blades

Applies to: D4G, D4K, D4K2, D2

End Bits and Cutting Edges 6 1/2"										
Type		End Bits				Edges				Notes
		Thickness	End Bits	Hardware	Position	Thickness	Edges	Quantity	Hardware	
	(Precision) Level Cut	18	462-8032 462-8033	3 3	RH LH	18	467-7957	2	7	Equipped from factory GP: (467-7954)
		21	472-4112 472-4113	3 3	RH LH	21	472-4120	2	7	GP: 500-3873*
	(Precision) Level Cut Reversible	18	491-3754 (2 Req'd)	3	RH LH	18	467-7957	2	7	GP: (507-2797)
		21	491-3755 (2 Req'd)	3	RH LH	21	472-4120	2	7	GP: 507-2800*
	Extended Cut Reversible ¹	16	195-7193 (2 Req'd)	3	RH LH	16	157-7338	2	7	GP: 507-2799*
Specialty										
	Performance End Bits	19	480-8939 480-8940	3 3	RH LH	21	472-4120	2	7	GP: (522-3998)
	A.R.M. ¹	16	477-7839 477-7840	3 3	RH LH					
Hardware, Repair Parts and Wear Protection										
Type	Description		Part Number	Quantity	Notes					
Hardware	Bolts	5/8-11 x 2-1/4	3F-5108	18	Ensure Base Edge is flat and not excessively worn Clean and remove any paint on mating surfaces Torque, Bang, Torque					
	Nuts	5/8-11	4K-0367	18						
	Washers	5/8"	5P-8247	18						

¹Traditional Design



Cat Dozers

PART NUMBERS

D5 Angle Blades

Blade Serial Numbers: 96H, 11J, 13J, 93H1-3846





Applies to: D5B

End Bits and Cutting Edges 8"										
Type		End Bits				Edges				Notes
		Thickness	End Bits	Hardware	Position	Thickness	Edges	Quantity	Hardware	
	Level Cut	19	4T-3049 4T-3050	6 6	RH LH	19	4T-3008 4T-3020	1 2	11 9	Equipped from factory GP: 507-2821*
	GP	19	9F-7075 9F-7076	6 6	RH LH					
	HC	22	3G-8295 3G-8296	6 6	RH LH					
Hardware, Repair Parts and Wear Protection										
Type	Description		Part Number	Quantity	Notes					
Hardware	Bolts	5/8-11 x 2-1/4	3F-5108	41	Ensure Base Edge is flat and not excessively worn Clean and remove any paint on mating surfaces Torque, Bang, Torque					
	Nuts	8-May	4K-0367	41						
	Washers	5/8"	5P-8247	41						

D5 Angle Blades

Blade Serial Numbers: 8ZP

Applies to: D5C

End Bits and Cutting Edges 6 1/2"										
Type		End Bits				Edges				Notes
		Thickness	End Bits	Hardware	Position	Thickness	Edges	Quantity	Hardware	
	Level Cut	16	6Y-5839 6Y-5840	3 3	RH LH	16	142-4914	2	8	Equipped from factory GP: (142-4915)
		19	469-4405 469-4404	3 3	RH LH					
	Level Cut Reversible	16	4T-6229 (2 Req'd)	3	RH LH	16	142-4914	2	8	GP: 507-2822*
	Extended Cut Reversible	16	195-7193 (2 Req'd)	3	RH LH	16	142-4914	2	8	GP: 507-2823*
Specialty										
	A.R.M. ¹	16	477-7839 477-7840	3 3	RH LH					
Hardware, Repair Parts and Wear Protection										
Type	Description		Part Number	Quantity	Notes					
Hardware	Bolts	5/8-11 x 2-1/4	3F-5108	22	Ensure Base Edge is flat and not excessively worn Clean and remove any paint on mating surfaces Torque, Bang, Torque					
	Nuts	5/8-11	4K-0367	22						
	Washers	5/8"	5P-8247	22						

¹Traditional Design

Cat Dozers

PART NUMBERS

D5 XL Blades

Blade Serial Numbers: 8GP

Applies to: D5C

End Bits and Cutting Edges 8"										
Type		End Bits				Edges				Notes
		Thickness	End Bits	Hardware	Position	Thickness	Edges	Quantity	Hardware	
	Level Cut	19	8E-7079 8E-7078	4 4	RH LH	16	140-0983	2	6	Equipped from factory GP: 507-2824*
		25	323-4279 323-4280	4 4	RH LH					
Hardware, Repair Parts and Wear Protection										
Type	Description		Part Number	Quantity	Notes					
Hardware	Bolts	3/4-10 x 2-3/4	5J-4771	20	Ensure Base Edge is flat and not excessively worn Clean and remove any paint on mating surfaces Torque, Bang, Torque					
	Nuts	3/4-10	2J-3506	20						
	Washers	3/4"	5P-8248	20						

D5 XL Blades

Blade Serial Numbers: 9WH, 6MH





Applies to: D5C, D5G

End Bits and Cutting Edges 8"										
Type		End Bits				Edges				Notes
		Thickness	End Bits	Hardware	Position	Thickness	Edges	Quantity	Hardware	
	Level Cut	19	8E-7079 8E-7078	4 4	RH LH	16	3G-9306	2	6	Equipped from factory GP: (8E-7088)
		25	323-4279 323-4280	4 4	RH LH					
Hardware, Repair Parts and Wear Protection										
Type	Description		Part Number	Quantity	Notes					
Hardware	Bolts	3/4-10 x 2-3/4	5J-4771	20	Ensure Base Edge is flat and not excessively worn Clean and remove any paint on mating surfaces Torque, Bang, Torque					
	Nuts	3/4-10	2J-3506	20						
	Washers	3/4"	5P-8248	20						
Blade Repair	Edge Support		183-4252*	1						

D5 LGP Blades

Blade Serial Numbers: 6PH, 9XH, 8NP

Applies to: D5G

End Bits and Cutting Edges 6 1/2"										
Type		End Bits				Edges				Notes
		Thickness	End Bits	Hardware	Position	Thickness	Edges	Quantity	Hardware	
	Level Cut	18	462-8032 462-8033	3 3	RH LH	18	467-8029	2	8	Equipped from factory GP: 500-3880*
		21	472-4112 472-4113	3 3	RH LH	21	472-4121	2	8	GP: 500-3881*
	Level Cut Reversible	18	491-3754 (2 Req'd)	3	RH LH	18	467-8029	2	8	GP: 507-2826*
		21	491-3755 (2 Req'd)	3	RH LH	21	472-4121	2	8	GP: 507-2827*
	Extended Cut Reversible ¹	16	195-7193 (2 Req'd)	3	RH LH	16	6Y-5842	2	8	
Specialty										
	Performance End Bits	19	480-8939 480-8940	3 3	RH LH	21	472-4121	2	8	GP: 522-3994*
	A.R.M. ¹	16	477-7839 477-7840	3 3	RH LH					
Hardware, Repair Parts and Wear Protection										
Type	Description		Part Number	Quantity	Notes					
Hardware	Bolts	5/8-11 x 2-1/4	3F-5108	18	Ensure Base Edge is flat and not excessively worn Clean and remove any paint on mating surfaces Torque, Bang, Torque					
	Nuts	5/8-11	4K-0367	18						
	Washers	5/8"	5P-8247	18						
Blade Repair	Edge Support		331-0173	1						



¹Traditional Design

Cat Dozers

PART NUMBERS

D5 XL Blades





Applies to: D5K, D5K2 Forestry, D3

End Bits and Cutting Edges 8"										
Type		End Bits				Edges				Notes
		Thickness	End Bits	Hardware	Position	Thickness	Edges	Quantity	Hardware	
	Level Cut	19	8E-7079 8E-7078	4 4	RH LH	16	331-0162	2	6	Equipped from factory GP: (255-1501)
		25	323-4279 323-4280	4 4	RH LH					
Specialty										
	Performance End Bits	19	485-7965 485-7966	4 4	RH LH	16	331-0162	2	6	GP: 522-4002*
	A.R.M. ¹	19	473-9971 473-9970	4 4	RH LH					
Hardware, Repair Parts and Wear Protection										
Type	Description		Part Number	Quantity	Notes					
Hardware	Bolts	3/4-10 x 2-3/4	5J-4771	20	Ensure Base Edge is flat and not excessively worn Clean and remove any paint on mating surfaces Torque, Bang, Torque					
	Nuts	3/4-10	2J-3506	20						
	Washers	3/4"	5P-8248	20						
Blade Repair	Edge Support		331-0173	1						

¹Traditional Design

D5 LGP Blades

Applies to: D5K, D5K2, D3

End Bits and Cutting Edges 6 1/2"										
Type		End Bits				Edges				Notes
		Thickness	End Bits	Hardware	Position	Thickness	Edges	Quantity	Hardware	
	Precision Level Cut	18	462-8032 462-8033	3 3	RH LH	18	462-8034	2	6	Equipped from factory GP: (467-7950)
		21	472-4112 472-4113	3 3	RH LH	21	472-4119	2	6	GP: 500-3872*
	Precision Level Cut Reversible	18	491-3754 (2 Req'd)	3	RH LH	18	462-8034	2	6	GP: (507-2831)
		21	491-3755 (2 Req'd)	3	RH LH	21	472-4119	2	6	GP: (507-2832)
	Extended Cut Reversible ¹	16	195-7193 (2 Req'd)	3	RH LH	16	255-1474	2	6	GP: (507-2830)
Specialty										
	Performance End Bits	19	480-8939 480-8940	3 3	RH LH	21	472-4119	2	6	GP: (522-4001)
	A.R.M. ¹	16	477-7839 477-7840	3 3	RH LH					
Hardware, Repair Parts and Wear Protection										
Type	Description		Part Number	Quantity	Notes					
Hardware	Bolts	5/8-11 x 2-1/4	3F-5108	18	Ensure Base Edge is flat and not excessively worn Clean and remove any paint on mating surfaces Torque, Bang, Torque					
	Nuts	5/8-11	4K-0367	18						
	Washers	5/8"	5P-8247	18						
Blade Repair	Edge Support		(255-1484)	1						





¹Traditional Design

Cat Dozers

PART NUMBERS

D5 LGP Narrow 115" Blades

Applies to: D5G, D5K, D5K2, D3





End Bits and Cutting Edges 6 1/2"										
Type		End Bits				Edges				Notes
		Thickness	End Bits	Hardware	Position	Thickness	Edges	Quantity	Hardware	
	(Precision) Level Cut	18	462-8032 462-8033	3 3	RH LH	18	467-7957	2	7	Equipped from factory GP: (467-7954)
		21	472-4112 472-4113	3 3	RH LH	21	472-4120	2	7	GP: 500-3873*
	Level Cut Reversible	18	491-3754 (2 Req'd)	3	RH LH	18	467-7957	2	7	GP: 507-2800*
		21	491-3755 (2 Req'd)	3	RH LH	21	472-4120	2	7	GP: 507-2801*
	Extended Cut Reversible ¹	16	195-7193 (2 Req'd)	3	RH LH	16	157-7338	2	7	GP: 507-2799*
Specialty										
	Performance End Bits	19	480-8939 480-8940	3 3	RH LH	21	472-4120	2	7	GP: (522-3998)
	A.R.M. ¹	16	477-7839 477-7840	3 3	RH LH					
Hardware, Repair Parts and Wear Protection										
Type	Description		Part Number	Quantity	Notes					
Hardware	Bolts	5/8-11 x 2-1/4	3F-5108	18	Ensure Base Edge is flat and not excessively worn Clean and remove any paint on mating surfaces Torque, Bang, Torque					
	Nuts	5/8-11	4K-0367	18						
	Washers	5/8"	5P-8247	18						
Blade Repair	Edge Support		(255-1500)	1						

¹Traditional Design

D5 XL Blades

Blade Serial Numbers: 4GP, 6JP, HGP, X1C

Applies to: D5N, D3

End Bits and Cutting Edges 8"										
Type		End Bits				Edges				Notes
		Thickness	End Bits	Hardware	Position	Thickness	Edges	Quantity	Hardware	
	Level Cut	19	8E-9379 8E-9378	4 4	RH LH	16	8E-9377	2	7	Equipped from factory GP: (255-1501)
		25	323-4279 323-4280	4 4	RH LH					
	Level Cut Reversible	19	3G-4285 (2 req'd)	4 4	RH LH	16	8E-9377	2	7	GP: (8E-9376)
	GP (HC)	22	140-6787 140-6788	4 4	RH LH	16	4T-6659	2	7	GP: 507-2816*
	EWL	25	462-4828 462-4829	4 4	RH LH					
Specialty										
	A.R.M. ¹	19	473-9970 473-9971	4 4	RH LH					
Hardware, Repair Parts and Wear Protection										
Type	Description		Part Number	Quantity	Notes					
Hardware	Bolts	3/4-10 x 2-1/2	5J-4773	22	Ensure Base Edge is flat and not excessively worn Clean and remove any paint on mating surfaces Torque, Bang, Torque					
	Nuts	3/4-10	2J-3506	22						
	Washers	3/4"	5P-8248	22						
Blade Repair	Edge Support		8E-9173*	1						

¹Traditional Design





Cat Dozers

PART NUMBERS

D5 XL (Narrow) Blades

Blade Serial Numbers: W5C

Applies to: D5N





End Bits and Cutting Edges 8"										
Type		End Bits				Edges				Notes
		Thickness	End Bits	Hardware	Position	Thickness	Edges	Quantity	Hardware	
	Level Cut	19	8E-9379 8E-9378	4 4	RH LH	16	5Q-8193	2	6	Equipped from factory GP: 5Q-8192*
		25	323-4279 323-4280	4 4	RH LH					
	Level Cut Reversible	19	3G-4285 (2 req'd)	4	RH LH	16	5Q-8193	2	6	GP: 507-2833*
	GP (HC)	22	140-6787 140-6788	4 4	RH LH	16	5Q-8193	2	6	GP: 507-2834*
	EWL	25	462-4828 462-4829	4 4	RH LH					
Specialty										
	A.R.M. ¹	19	473-9970 473-9971	4 4	RH LH					
Hardware, Repair Parts and Wear Protection										
Type	Description		Part Number	Quantity	Notes					
Hardware	Bolts	3/4-10 x 2-1/2	5J-4773	20	Ensure Base Edge is flat and not excessively worn Clean and remove any paint on mating surfaces Torque, Bang, Torque					
	Nuts	3/4-10	2J-3506	20						
	Washers	3/4"	5P-8248	20						
Blade Repair	Edge Support		5Q-8204*	1						

¹Traditional Design

D5 LGP Blades

Blade Serial Numbers: 4FP, BHY, 6KP

Applies to: D5N

End Bits and Cutting Edges 8"										
Type		End Bits				Edges				Notes
		Thickness	End Bits	Hardware	Position	Thickness	Edges	Quantity	Hardware	
	Level Cut	19	8E-9379 8E-9378	4 4	RH LH	16	4T-8940	2	8	Equipped from factory GP: (4T-5261)
		25	323-4279 323-4280	4 4	RH LH					
	Level Cut Reversible	19	3G-4285 (2 req'd)	4	RH LH	16	4T-8940	2	8	GP: 507-2835*
	GP (HC)	22	140-6787 140-6788	4 4	RH LH	16	4T-8940	2	8	GP: 507-2835*
	EWL	25	462-4828 462-4829	4 4	RH LH					
Specialty										
	A.R.M. ¹	19	473-9970 473-9971	4 4	RH LH					
Hardware, Repair Parts and Wear Protection										
Type	Description		Part Number	Quantity	Notes					
Hardware	Bolts	3/4-10 x 2-1/2	5J-4773	24	Ensure Base Edge is flat and not excessively worn Clean and remove any paint on mating surfaces Torque, Bang, Torque					
	Nuts	3/4-10	2J-3506	24						
	Washers	3/4"	5P-8248	24						
Blade Repair	Edge Support		107-8228	1						

¹Traditional Design

Cat Dozers

PART NUMBERS

D5 XL Foldable Blades

Blade Serial Numbers: 4GP, 6JP







Applies to: D5N

End Bits and Cutting Edges 8"										
Type		End Bits				Edges				Notes
		Thickness	End Bits	Hardware	Position	Thickness	Edges	Quantity	Hardware	
	Level Cut	19	8E-9379	4	RH	16	8E-9377	1	7	Equipped from factory GP: 259-6002*
						16	259-6003	1	5	
						16	259-6004	1	6	
Hardware, Repair Parts and Wear Protection										
Type	Description		Part Number	Quantity	Notes					
Hardware	Bolts	3/4-10 x 2-1/2	5J-4773	22	Ensure Base Edge is flat and not excessively worn Clean and remove any paint on mating surfaces Torque, Bang, Torque					
	Nuts	3/4-10	2J-3506	22						
	Washers	3/4"	5P-8248	22						
Blade Repair	Edge Support		259-5972*	1						
			259-5990*	1						

*Traditional Design

D5 Straight Blades

Applies to: D5R2

End Bits and Cutting Edges 8"										
Type		End Bits				Edges				Notes
		Thickness	End Bits	Hardware	Position	Thickness	Edges	Quantity	Hardware	
	Level Cut	19	8E-9379 8E-9378	4 4	RH LH					
		25	323-4279 323-4280	4 4	RH LH					
	Level Cut Reversible	19	3G-4285 (2 req'd)	4 4	RH LH	19	1U-2211	2	9	Equipped from factory GP: 1U-2210 ^x
	GP (HC)	22	140-6787 140-6788	4 4	RH LH					
	EWL	25	462-4828 462-4829	4 4	RH LH					
Specialty										
	Performance End Bits	24	462-4828 462-4829	4 4	RH LH	19	1U-2211	2	9	GP: (522-4008)
	A.R.M. ¹	19	473-9970 473-9971	4 4	RH LH					
Hardware, Repair Parts and Wear Protection										
Type	Description		Part Number	Quantity	Notes					
Hardware	Bolts	3/4-10 x 2-1/2	5J-4773	26	Ensure Base Edge is flat and not excessively worn Clean and remove any paint on mating surfaces Torque, Bang, Torque					
	Nuts	3/4-10	2J-3506	26						
	Washers	3/4"	5P-8248	26						
Blade Repair	Edge Support		(9U-8440) (9U-8439)	2 1						

¹Traditional Design

Cat Dozers

OPTIONS

D5N, D5R/2, D6K/N GET OPTIONS D5, D4

A.R.M.
OPTION
AVAILABLE



- Level Cut / Finish (Factory First Fit)**
- Recommended for finish and semi-finish dozing
 - Matches cutting edge's depth of cut
 - Low-impact, low abrasion materials only



- Level Cut Reversible**
- Reversible finish and semi-finish dozing end bits
 - Used in applications where curbing is not a requirement



- Hot Cupped**
- Forward protruding profile for better penetration than flat plate

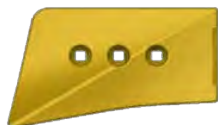

- Performance End Bits**
- Forward profile for penetration in tough soil
 - Excellent blade control in tough production dozing applications
 - Superior finish grading capabilities
 - Match with Extended Wear Life (EWL) cutting edges for long wear life



- EWL**
- Sharpened, forward protruding profile for excellent penetration
 - For fast blade loading, high productivity applications

D6R/T GET OPTIONS D6



- Level Cut / Finish (Factory First Fit)**
- Recommended for finish and semi-finish dozing
 - Matches cutting edge's depth of cut
 - Low-impact, low abrasion materials only



- General Purpose**
- Sharpened, forward protruding profile for excellent penetration
 - For fast blade loading, high productivity applications

A.R.M.
OPTION
AVAILABLE



- Utility**
- Thick cross-section for high face wear applications
 - Recommended for high impact, high abrasion applications

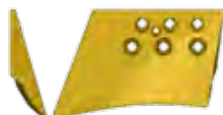

- EWL**
- 25% more usable wear material than General Purpose
 - Prolonged life and excellent penetration in abrasive conditions



- Performance Cutting Edges**
- Superior penetration
 - Requires less ripping
 - Up to 25% larger payload
 - Available on SU blades for D6, D7, and D8





D8T, D8 SU BLADES

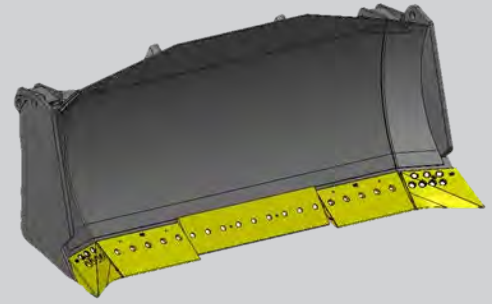

D7E, D7 SU BLADES

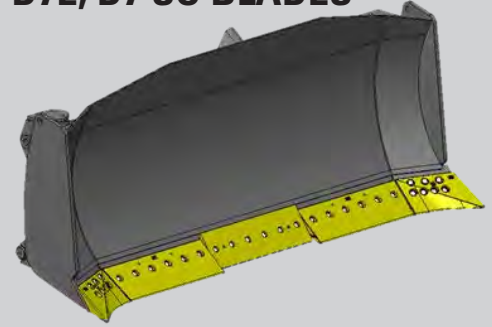

D6 SU BLADES (XL/XW)

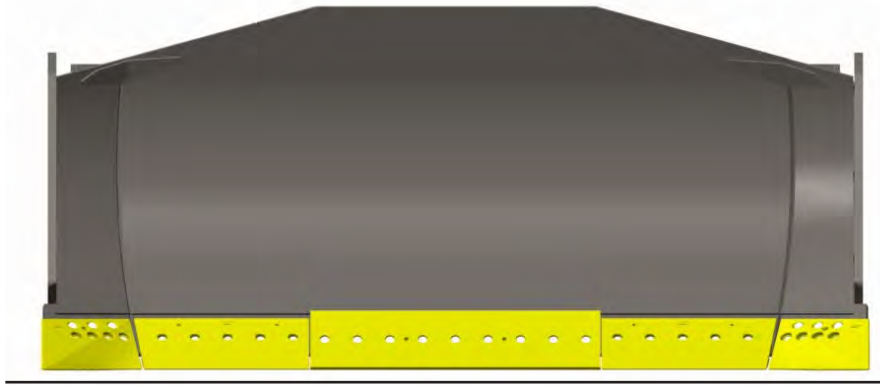
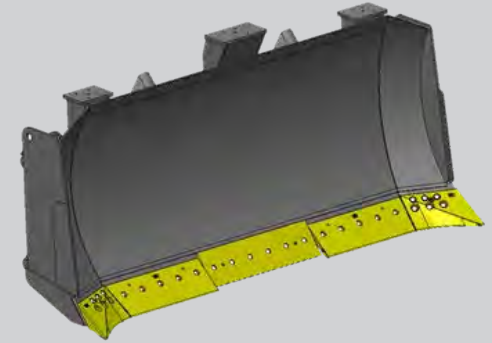

LEVEL CUT

Cat Performance Cutting Edges For Medium Track Type Tractors

Features:





- Wear material equivalent to standard production system
- Up to 35% increased payload mass
- Up to 17% greater productivity
- Increased ground penetration
- Finish dozing capable
- Decreased track slip

Cat Dozers

PART NUMBERS

D6 XL Blades

Applies to: D5N, D6K, D4

End Bits and Cutting Edges 8"										
Type		End Bits				Edges				Notes
		Thickness	End Bits	Hardware	Position	Thickness	Edges	Quantity	Hardware	
	Level Cut	19	8E-9379 8E-9378	4 4	RH LH	16	8E-9377	2	7	Equipped from factory GP: (8E-9376)
		25	323-4279 323-4280	4 4	RH LH					
	Level Cut Reversible	19	3G-4285 (2 req'd)	4	RH LH	16	8E-9377	2	7	GP: 507-2815*
	GP (HC)	22	140-6787 140-6788	4 4	RH LH	19	4T-6659	2	7	GP: 507-2816*
Specialty										
	Performance End Bits	24	462-4828 462-4829	4 4	RH LH	19	4T-6659	2	7	GP: 522-4003*
	A.R.M. ¹	19	473-9970 473-9971	4 4	RH LH					
Hardware, Repair Parts and Wear Protection										
Type	Description		Part Number	Quantity	Notes					
Hardware	Bolts	3/4-10 x 2-1/2	5J-4773	22	Ensure Base Edge is flat and not excessively worn Clean and remove any paint on mating surfaces Torque, Bang, Torque					
	Nuts	3/4-10	2J-3506	22						
	Washers	3/4"	5P-8248	22						
Blade Repair	Edge Support		(240-1507)	1						

¹Traditional Design

D6 XL Foldable Blades

Applies to: D6K, D4





End Bits and Cutting Edges 8"										
Type		End Bits				Edges				Notes
		Thickness	End Bits	Hardware	Position	Thickness	Edges	Quantity	Hardware	
	Level Cut	19	8E-9379	4	RH	16	8E-9377	1	7	Equipped from factory GP: (294-4514)
						16	294-4519	1	5	
						19	300-0168	1	6	
Hardware, Repair Parts and Wear Protection										
Type	Description		Part Number	Quantity	Notes					
Hardware	Bolts	3/4-10 x 2-1/2	5J-4773	22	Ensure Base Edge is flat and not excessively worn Clean and remove any paint on mating surfaces Torque, Bang, Torque					
	Nuts	3/4-10	2J-3506	22						
	Washers	3/4"	5P-8248	22						
Blade Repair	Edge Support		(294-4501) (294-4478)	1 1						

Cat Dozers

PART NUMBERS

D6 XL Blades

Applies to: D6K2, D4

End Bits and Cutting Edges 8"										
Type		End Bits				Edges				Notes
		Thickness	End Bits	Hardware	Position	Thickness	Edges	Quantity	Hardware	
	Level Cut	19	8E-9379 8E-9378	4 4	RH LH	19	342-8851	2	7	Equipped from factory GP: (342-8850)
		25	323-4279 323-4280	4 4	RH LH	25	484-2299	2	7	GP: (507-2841)
	Level Cut Reversible	19	3G-4285 (2 req'd)	4	RH LH	19	342-8851	2	7	GP: (507-2842)
	GP (HC)	22	140-6787 140-6788	4 4	RH LH	19	342-8851	2	7	GP: (507-2843)
Specialty										
	Performance End Bits	24	462-4828 462-4829	4 4	RH LH	25	484-2299	2	7	GP: (522-4004)
	A.R.M. ¹	19	473-9970 473-9971	4 4	RH LH					
Hardware, Repair Parts and Wear Protection										
Type	Description		Part Number	Quantity	Notes					
Hardware	Bolts	3/4-10 x 2-1/2	5J-4773	22	Ensure Base Edge is flat and not excessively worn Clean and remove any paint on mating surfaces Torque, Bang, Torque					
	Nuts	3/4-10	2J-3506	22						
	Washers	3/4"	5P-8248	22						
Blade Repair	Edge Support		(348-6286)	1						

¹Traditional Design

D6 XL Foldable Blades





Applies to: D6K2, D4

End Bits and Cutting Edges 8"										
Type		End Bits				Edges				Notes
		Thickness	End Bits	Hardware	Position	Thickness	Edges	Quantity	Hardware	
	Level Cut	19	8E-9379	4	RH	19	342-8851	1	7	Equipped from factory GP: (371-0759)
							371-0758	1	5	
							300-0168	1	6	
Hardware, Repair Parts and Wear Protection										
Type	Description		Part Number	Quantity	Notes					
Hardware	Bolts	3/4-10 x 2-1/2	5J-4773	22	Ensure Base Edge is flat and not excessively worn Clean and remove any paint on mating surfaces Torque, Bang, Torque					
	Nuts	3/4-10	2J-3506	22						
	Washers	3/4"	5P-8248	22						
Blade Repair	Edge Support		(455-0811) (456-9654)	1 1						

D6 XL VPAT Blades

Blade Serial Numbers: 3WP, 3XP, 5A5, AA9, B6X, G6M, G6N

Applies to: D5R2, D6N, D5

End Bits and Cutting Edges 8"										
Type		End Bits				Edges				Notes
		Thickness	End Bits	Hardware	Position	Thickness	Edges	Quantity	Hardware	
	Level Cut	19	8E-9379 8E-9378	4 4	RH LH	19	3G-4282	2	7	Equipped from factory GP: (8E-9380)
		25	323-4279 323-4280	4 4	RH LH					
	Level Cut Reversible	19	3G-4285 (2 req'd)	4	RH LH	19	3G-4282	2	7	GP: 3G-4210*
	GP (HC)	22	140-6787 140-6788	4 4	RH LH	19	3G-4282	2	7	GP: 507-2847*
Specialty										
	Performance End Bits	24	462-4828 462-4829	4 4	RH LH	19	3G-4282	2	7	GP: (522-4007)
	A.R.M. ¹	19	473-9970 473-9971	4 4	RH LH					
Hardware, Repair Parts and Wear Protection										
Type	Description		Part Number	Quantity	Notes					
Hardware	Bolts	3/4-10 x 2-1/2	5J-4773	22	Ensure Base Edge is flat and not excessively worn Clean and remove any paint on mating surfaces Torque, Bang, Torque					
	Nuts	3/4-10	2J-3506	22						
	Washers		5P-8248	22						
Blade Repair	Edge Support		8E-9502	1						

¹Traditional Design

D6 XL VPAT Foldable Blades





Applies to: D5R2, D6N, D5

End Bits and Cutting Edges 8"										
Type		End Bits				Edges				Notes
		Thickness	End Bits	Hardware	Position	Thickness	Edges	Quantity	Hardware	
	Level Cut	19	8E-9379	4	RH	19	3G-4282	1	7	Equipped from factory GP: (257-0207)
							257-0264	1	5	
							257-0265	1	6	
Hardware, Repair Parts and Wear Protection										
Type	Description		Part Number	Quantity	Notes					
Hardware	Bolts	3/4-10 x 2-1/2	5J-4773	22	Ensure Base Edge is flat and not excessively worn Clean and remove any paint on mating surfaces Torque, Bang, Torque					
	Nuts	3/4-10	2J-3506	22						
	Washers	3/4"	5P-8248	22						
Blade Repair	Edge Support		(257-0215) (257-0232)	1 1						

D6 XL SU Blades

Blade Serial Numbers: 2SP, 6GP, CZ7, ECA, SGD, SS5, TR5

Applies to: D5R2, D6N, D5

End Bits and Cutting Edges 8"										
Type		End Bits				Edges				Notes
		Thickness	End Bits	Hardware	Position	Thickness	Edges	Quantity	Hardware	
	Level Cut	19	8E-9379 8E-9378	4 4	RH LH	19	9U-8057 4T-6659	2 1	4 7	Equipped from factory GP: (9U-8079)
		25	323-4279 323-4280	4 4	RH LH	19	9U-8057 4T-6659	2 1	4 7	GP: 507-2848*
	Level Cut Reversible	19	3G-4285 (2 req'd)	4	RH LH	19	9U-8057 4T-6659	2 1	4 7	GP: 507-2849*
	GP (HC)	22	140-6787 140-6788	4 4	RH LH	19	9U-8057 4T-6659	2 1	4 7	GP: 507-2850*
Specialty										
	A.R.M. ¹	19	473-9970 473-9971	4 4	RH LH					
Hardware, Repair Parts and Wear Protection										
Type	Description		Part Number	Quantity	Notes					
Hardware	Bolts	3/4-10 x 2-1/2	5J-4773	23	Ensure Base Edge is flat and not excessively worn Clean and remove any paint on mating surfaces Torque, Bang, Torque					
	Nuts	3/4-10	2J-3506	23						
	Washers	3/4"	5P-8248	23						
Blade Repair	Edge Support		(9U-8440) (9U-8439)	2 1						

¹Traditional Design

D6 XL VPAT Foldable Blades







Applies to: D5R2, D6N, D5

End Bits and Cutting Edges 8"										
Type		End Bits				Edges				Notes
		Thickness	End Bits	Hardware	Position	Thickness	Edges	Quantity	Hardware	
	Level Cut	19	8E-9379	4	RH	19	278-2168	2	4	Equipped from factory GP: (257-8150)
			8E-9378	4	LH		278-2169	1	6	
							278-2170	1	6	
Hardware, Repair Parts and Wear Protection										
Type	Description		Part Number	Quantity	Notes					
Hardware	Bolts	3/4-10 x 2-1/2	5J-4773	28	Ensure Base Edge is flat and not excessively worn Clean and remove any paint on mating surfaces Torque, Bang, Torque					
	Nuts	3/4-10	2J-3506	28						
	Washers	3/4"	5P-8248	28						
Blade Repair	Edge Support		(456-9686) (257-8118)	1 1						

D6 XL Angle Blades

Blade Serial Numbers: 1XP, 3GP, C4R, 1ZP, 1YP, 3PP, 4BP, 8TP, 1AR, 1RP, 3EP, 1DH600-UP, CLH, 3EP, BHN, P6S, EG3, RTH, RA5







Applies to: D5R2, D6R, D6R2, D6T, D5

End Bits and Cutting Edges 10"										
Type		End Bits				Edges				Notes
		Thickness	End Bits	Hardware	Position	Thickness	Edges	Quantity	Hardware	
	Level Cut	25	9W-8874 9W-8875	6 6	RH LH	19	4T-2952	4	5	Equipped from factory GP: (6Y-2039)
	Utility	35	122-8617 122-8618	6 6	RH LH	25	4T-2985	4	5	GP: (507-2957)
	GP	30	6Y-4411 6Y-4410	6 6	RH LH	25	4T-2985	4	5	GP: (507-2958)
	EWL	30	9W-1875 9W-1876	6 6	RH LH	25	4T-2985	4	5	GP: (507-2959)
Specialty										
	Level Cut A.R.M.	25	433-9637 433-9639	6 6	RH LH					
	EWL A.R.M.	30	283-1027* 283-1028	6 6	RH LH	25	283-1029*	4	5	GP: (521-8463)
Hardware, Repair Parts and Wear Protection										
Type	Description		Part Number	Quantity	Notes					
Hardware	Bolts	3/4-10 x 2-1/2	5J-4773	32	Ensure Base Edge is flat and not excessively worn Clean and remove any paint on mating surfaces Torque, Bang, Torque					
	Nuts	3/4-10	2J-3506	32						
	Washers	3/4"	5P-8248	32						
Blade Repair	Edge Support		6Y-1812*	1						

D6 XL VPAT Blades

Blade Serial Numbers: M1H, EG6







Applies to: D6R, D6T

End Bits and Cutting Edges 10"										
Type		End Bits				Edges				Notes
		Thickness	End Bits	Hardware	Position	Thickness	Edges	Quantity	Hardware	
	Level Cut	25	9W-8874 9W-8875	6 6	RH LH	19	219-4599	2	10	Equipped from factory
	Utility	35	122-8617 122-8618	6 6	RH LH					
	GP	30	6Y-4411 6Y-4410	6 6	RH LH					
	EWL	30	9W-1875 9W-1876	6 6	RH LH					
Specialty										
	Level Cut A.R.M.	25	433-9637 433-9639	6 6	RH LH					
	EWL A.R.M.	30	283-1027* 283-1028	6 6	RH LH					
Hardware, Repair Parts and Wear Protection										
Type	Description		Part Number	Quantity	Notes					
Hardware	Bolts	3/4-10 x 2-1/2	5J-4773	32	Ensure Base Edge is flat and not excessively worn Clean and remove any paint on mating surfaces Torque, Bang, Torque					
	Nuts	3/4-10	2J-3506	32						
	Washers	3/4"	5P-8248	32						
Blade Repair	Edge Support		214-2271	1						

D6 XL Semi U-Blades

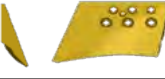
Blade Serial Numbers: 1TP, 3FP, 1WP, 3RP, 4AP, 8SP, BHM, D6C, P6A, D2S, MGH, D4S, C4N, C4L, JNE, KTL, GNH, EG2, RTE, RTF







Applies to: D6R, D6R2, D6T

End Bits and Cutting Edges 10"										
Type		End Bits				Edges				Notes
		Thickness	End Bits	Hardware	Position	Thickness	Edges	Quantity	Hardware	
	Level Cut	25	9W-8874 9W-8875	6 6	RH LH	19	9W-1878	2	8	Equipped from factory GP: (9W-3762)
	Utility	35	122-8617 122-8618	6 6	RH LH	25	6Y-3840	2	8	GP: (507-2855)
	GP	30	6Y-4411 6Y-4410	6 6	RH LH	25	6Y-3840	2	8	GP: (507-2856)
	Performance	25	479-8137 479-8138	6 6	RH LH	25	479-8139 479-8140 479-8141	1 1 1	5 5 6	GP: (479-8150)
	EWL	30	9W-1875 9W-1876	6 6	RH LH	25	6Y-3840	2	8	GP: (507-2857)
Specialty										
	Level Cut A.R.M.	25	433-9637 433-9639	6 6	RH LH					
	EWL A.R.M.	30	283-1027* 283-1028	6 6	RH LH					
Hardware, Repair Parts and Wear Protection										
Type	Description		Part Number	Quantity	Notes					
Hardware	Bolts	3/4-10 x 2-1/2	5J-4773	28	Ensure Base Edge is flat and not excessively worn Clean and remove any paint on mating surfaces Torque, Bang, Torque					
	Nuts	3/4-10	2J-3506	28						
	Washers	3/4"	5P-8248	28						
Blade Repair	Edge		8E-5205	2						
	Support		6Y-1390	1						

D6 XL Straight Blades

Blade Serial Numbers: B9B, 08S, JNC, SJG, GNK, EG5, R6L







Applies to: D6R, D6R2

End Bits and Cutting Edges 10"										
Type		End Bits				Edges				Notes
		Thickness	End Bits	Hardware	Position	Thickness	Edges	Quantity	Hardware	
	Level Cut	25	9W-8874 9W-8875	6 6	RH LH	19	4T-2952	3	5	Equipped from factory GP: (6Y-1744)
	Utility	35	122-8617 122-8618	6 6	RH LH	25	4T-2985	3	5	GP: (507-2862)
	GP	30	6Y-4411 6Y-4410	6 6	RH LH	25	4T-2985	3	5	GP: (507-2863)
	EWL	30	9W-1875 9W-1876	6 6	RH LH	25	4T-2985	3	5	GP: (507-2864)
Specialty										
	Level Cut A.R.M.	25	433-9637 433-9639	6 6	RH LH					
	EWL A.R.M.	30	283-1027* 283-1028	6 6	RH LH	25	283-1029*	3	5	
Hardware, Repair Parts and Wear Protection										
Type	Description		Part Number	Quantity	Notes					
Hardware	Bolts	3/4-10 x 2-1/2	5J-4773	27	Ensure Base Edge is flat and not excessively worn Clean and remove any paint on mating surfaces Torque, Bang, Torque					
	Nuts	3/4-10	2J-3506	27						
	Washers	3/4"	5P-8248	27						
Blade Repair	Edge Support		223-4010	1						

D6 XL Semi U-Blades

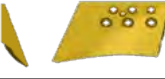
Blade Serial Numbers: GB2, DZ4, E8J







Applies to: D6

End Bits and Cutting Edges 10"										
Type		End Bits				Edges				Notes
		Thickness	End Bits	Hardware	Position	Thickness	Edges	Quantity	Hardware	
	Level Cut	25	9W-8874 9W-8875	6 6	RH LH	19	469-7446	2	8	Equipped from factory GP: (469-7445)
	Utility	35	122-8617 122-8618	6 6	RH LH					
	GP	30	6Y-4411 6Y-4410	6 6	RH LH					
	Performance	25	479-8137 479-8138	6 6	RH LH	25	593-0318 593-0319 479-8141	1 1 1	5 5 6	GP: (610-9748)
	EWL	30	9W-1875 9W-1876	6 6	RH LH					
Specialty										
	Level Cut A.R.M.	25	433-9637 433-9639	6 6	RH LH					
	EWL A.R.M.	30	283-1027* 283-1028	6 6	RH LH					
Hardware, Repair Parts and Wear Protection										
Type	Description		Part Number	Quantity	Notes					
Hardware	Bolts	3/4-10 x 2-1/2	5J-4773	28	Ensure Base Edge is flat and not excessively worn Clean and remove any paint on mating surfaces Torque, Bang, Torque					
	Nuts	3/4-10	2J-3506	28						
	Washers	3/4"	5P-8248	28						
Blade Repair	Edge Support		(463-5853)	1						

D6 XL Angle Blades

Blade Serial Numbers: PF7, E7X, EFX







Applies to: D6

End Bits and Cutting Edges 10"										
Type		End Bits				Edges				Notes
		Thickness	End Bits	Hardware	Position	Thickness	Edges	Quantity	Hardware	
	Level Cut	25	9W-8874 9W-8875	6 6	RH LH	19	473-3020 4T-2945	2 1	9 5	Equipped from factory GP: (562-2655)
	Utility	35	122-8617 122-8618	6 6	RH LH					
	GP	30	6Y-4411 6Y-4410	6 6	RH LH					
	EWL	30	9W-1875 9W-1876	6 6	RH LH					
Specialty										
	Level Cut A.R.M.	25	433-9637 433-9639	6 6	RH LH					
	EWL A.R.M.	30	283-1027* 283-1028	6 6	RH LH					
Hardware, Repair Parts and Wear Protection										
Type	Description		Part Number	Quantity	Notes					
Hardware	Bolts	3/4-10 x 2-1/2	5J-4773	35	Ensure Base Edge is flat and not excessively worn Clean and remove any paint on mating surfaces Torque, Bang, Torque					
	Nuts	3/4-10	2J-3506	35						
	Washers	3/4"	5P-8248	35						
Blade Repair	Edge Support		(556-4510)	1						

D6 XL VPAT Blades





Blade Serial Numbers: GND, EXF, F3R

Applies to: D6

End Bits and Cutting Edges 10"										
Type		End Bits				Edges				Notes
		Thickness	End Bits	Hardware	Position	Thickness	Edges	Quantity	Hardware	
	Level Cut	25	9W-8874 9W-8875	6 6	RH LH	19	473-3020	2	9	GP: (473-3019)
	Utility	35	122-8617 122-8618	6 6	RH LH					
	GP	30	6Y-4411 6Y-4410	6 6	RH LH					
	EWL	30	9W-1875 9W-1876	6 6	RH LH					
Specialty										
	Level Cut A.R.M.	25	433-9637 433-9639	6 6	RH LH					
	EWL A.R.M.	30	283-1027* 283-1028	6 6	RH LH					
Hardware, Repair Parts and Wear Protection										
Type	Description		Part Number	Quantity	Notes					
Hardware	Bolts	3/4-10 x 2-1/2	5J-4773	30	Ensure Base Edge is flat and not excessively worn Clean and remove any paint on mating surfaces Torque, Bang, Torque					
	Nuts	3/4-10	2J-3506	30						
	Washers	3/4"	5P-8248	30						
Blade Repair	Edge Support		(458-2613)	1						

D6 LGP Blades

Applies to: D6K, D4

End Bits and Cutting Edges 8"										
Type		End Bits				Edges				Notes
		Thickness	End Bits	Hardware	Position	Thickness	Edges	Quantity	Hardware	
	Level Cut	19	8E-9379 8E-9378	4 4	RH LH	16	4T-8940	2	8	Equipped from factory GP: (4T-5261)
		25	323-4279 323-4280	4 4	RH LH					
	Level Cut Reversible	19	3G-4285 (2 req'd)	4	RH LH	16	4T-8940	2	8	GP: 507-2835*
	GP (HC)	22	140-6787 140-6788	4 4	RH LH	16	4T-8940	2	8	GP: 507-2836*
Specialty										
	Performance End Bits	24	462-4828 462-4829	4 4	RH LH	16	4T-8940	2	8	GP: 522-4005
	A.R.M. ¹	19	473-9970 473-9971	4 4	RH LH					
Hardware, Repair Parts and Wear Protection										
Type	Description		Part Number	Quantity	Notes					
Hardware	Bolts	3/4-10 x 2-1/2	5J-4773	24	Ensure Base Edge is flat and not excessively worn Clean and remove any paint on mating surfaces Torque, Bang, Torque					
	Nuts	3/4-10	2J-3506	24						
	Washers	3/4"	5P-8248	24						
Blade Repair	Edge Support		240-1523	1						

¹Traditional Design





D6 LGP Foldable Blades

Applies to: D5M, D5N, D6K, D4

End Bits and Cutting Edges 8"										
Type		End Bits				Edges				Notes
		Thickness	End Bits	Hardware	Position	Thickness	Edges	Quantity	Hardware	
	Level Cut	19	8E-9379	4	RH	16	4T-8940	1	8	Equipped from factory GP: 297-1704*
						16	297-1705	1	5	
						19	297-1699	1	7	
Hardware, Repair Parts and Wear Protection										
Type	Description		Part Number	Quantity	Notes					
Hardware	Bolts	3/4-10 x 2-1/2	5J-4773	24	Ensure Base Edge is flat and not excessively worn Clean and remove any paint on mating surfaces Torque, Bang, Torque					
	Nuts	3/4-10	2J-3506	24						
	Washers	3/4"	5P-8248	24						
Blade Repair	Edge Support		297-1682*	1						
			297-1697*	1						

D6 LGP Blades

Applies to: D6K2, D4

End Bits and Cutting Edges 8"										
Type		End Bits				Edges				Notes
		Thickness	End Bits	Hardware	Position	Thickness	Edges	Quantity	Hardware	
	Level Cut	19	8E-9379 8E-9378	4 4	RH LH	16	8E-7245	2	9	Equipped from factory GP: (325-0002)
		25	323-4279 323-4280	4 4	RH LH					
	Level Cut Reversible	19	3G-4285 (2 req'd)	4	RH LH	16	8E-7245	2	9	GP: 507-2845*
	GP (HC)	22	140-6787 140-6788	4 4	RH LH	16	8E-7245	2	9	GP: 507-2846*
Specialty										
	Performance End Bits	24	462-4828 462-4829	4 4	RH LH	16	8E-7245	2	9	GP: (522-4006)
	A.R.M. ¹	19	473-9970 473-9971	4 4	RH LH					
Hardware, Repair Parts and Wear Protection										
Type	Description		Part Number	Quantity	Notes					
Hardware	Bolts	3/4-10 x 2-1/2	5J-4773	26	Ensure Base Edge is flat and not excessively worn Clean and remove any paint on mating surfaces Torque, Bang, Torque					
	Nuts	3/4-10	2J-3506	26						
	Washers	3/4"	5P-8248	26						
Blade Repair	Edge Support		(455-0829)	1						

¹Traditional Design

D6 LGP Foldable Blades





Applies to: D6K2, D4

End Bits and Cutting Edges 8"										
Type		End Bits				Edges				Notes
		Thickness	End Bits	Hardware	Position	Thickness	Edges	Quantity	Hardware	
	Level Cut	19	8E-9379	4	RH	16	8E-7245	1	9	Equipped from factory GP: (371-0808)
						16	371-0786	1	6	
						19	297-1699	1	7	
Hardware, Repair Parts and Wear Protection										
Type	Description		Part Number	Quantity	Notes					
Hardware	Bolts	3/4-10 x 2-1/2	5J-4773	26	Ensure Base Edge is flat and not excessively worn Clean and remove any paint on mating surfaces Torque, Bang, Torque					
	Nuts	3/4-10	2J-3506	26						
	Washers	3/4"	5P-8248	26						
Blade Repair	Edge Support		(456-9689) (456-9695)	1 1						

D6 LGP VPAT Blades

Blade Serial Numbers: 4MP, 5A7, AA3, FLM, B6L, G6G

Applies to: D5R2, D6N, D5







End Bits and Cutting Edges 8"										
Type		End Bits				Edges				Notes
		Thickness	End Bits	Hardware	Position	Thickness	Edges	Quantity	Hardware	
	Level Cut	19	8E-9379 8E-9378	4 4	RH LH	19	4T-2315	2	10	Equipped from factory GP: (4T-2314)
		25	323-4279 323-4280	4 4	RH LH	25	327-7911	2	10	
	Level Cut Reversible	19	3G-4285 (2 req'd)	4	RH LH	19	4T-2315	2	10	GP: 507-2852*
	GP (HC)	22	140-6787 140-6788	4 4	RH LH	19	4T-2315	2	10	GP: 507-2853*
Specialty										
	Performance End Bits	24	462-4828 462-4829	4 4	RH LH	19	4T-2315	2	10	GP: 522-4009*
	A.R.M. ¹	19	473-9970 473-9971	4 4	RH LH					
Hardware, Repair Parts and Wear Protection										
Type	Description		Part Number	Quantity	Notes					
Hardware	Bolts	3/4-10 x 2-1/2	5J-4773	28	Ensure Base Edge is flat and not excessively worn Clean and remove any paint on mating surfaces Torque, Bang, Torque					
	Nuts	3/4-10	2J-3506	28						
	Washers	3/4"	5P-8248	28						
Blade Repair	Edge Support		112-7615*	1						

¹Traditional Design

D6 LGP Straight Blades

Blade Serial Numbers: B9B, 08S, JNC, SJG, GNK, EG5, RTS, DZ6, E8L







Applies to: D6R, D6R2, D6T

End Bits and Cutting Edges 10"										
Type		End Bits				Edges				Notes
		Thickness	End Bits	Hardware	Position	Thickness	Edges	Quantity	Hardware	
	Level Cut	25	9W-8874 9W-8875	6 6	RH LH	19	4T-2950	2	10	Equipped from factory GP: ((229-6957))
	Utility	35	122-8617 122-8618	6 6	RH LH	35	363-2958*	2	10	
	GP	30	6Y-4411 6Y-4410	6 6	RH LH					
	EWL	30	9W-1875 9W-1876	6 6	RH LH					
Specialty										
	Level Cut A.R.M.	25	433-9637 433-9639	6 6	RH LH					
	EWL A.R.M.	30	283-1027* 283-1028	6 6	RH LH					
Hardware, Repair Parts and Wear Protection										
Type	Description		Part Number	Quantity	Notes					
Hardware	Bolts	3/4-10 x 2-1/2	5J-4773	32	Ensure Base Edge is flat and not excessively worn Clean and remove any paint on mating surfaces Torque, Bang, Torque					
	Nuts	3/4-10	2J-3506	32						
	Washers	3/4"	5P-8248	32						
Blade Repair	Edge Support		223-4010	1						

D6 LGP Angle Blades

Blade Serial Numbers: MMX, FLS, EGS







Applies to: D6R, D6T

End Bits and Cutting Edges 10"										
Type		End Bits				Edges				Notes
		Thickness	End Bits	Hardware	Position	Thickness	Edges	Quantity	Hardware	
	Level Cut	25	9W-8874 9W-8875	6 6	RH LH	19	4T-2923	4	7	Equipped from factory GP: (294-8236)
	Utility	35	122-8617 122-8618	6 6	RH LH					
	GP	30	6Y-4411 6Y-4410	6 6	RH LH					
	EWL	30	9W-1875 9W-1876	6 6	RH LH					
Specialty										
	Level Cut A.R.M.	25	433-9637 433-9639	6 6	RH LH					
	EWL A.R.M.	30	283-1027* 283-1028	6 6	RH LH					
Hardware, Repair Parts and Wear Protection										
Type	Description		Part Number	Quantity	Description	Part Number	Quantity	Notes		
Hardware	Bolts	3/4-10 x 2-1/2	5J-4773	12	7/8-9 x 3	5J-2409	28	3/4" hardware for end bits 7/8" hardware for cutting edges		
	Nuts	3/4-10	2J-3506	12	7/8-9	2J-3505	28			
	Washers	3/4"	5P-8248	12	7/8"	5P-8249	28			
Blade Repair	Edge Support		(288-8441)	1						

D6 LGP Angle Blades

Blade Serial Numbers: LJP, E7Z, EFZ







Applies to: D6

End Bits and Cutting Edges 10"										
Type		End Bits				Edges				Notes
		Thickness	End Bits	Hardware	Position	Thickness	Edges	Quantity	Hardware	
	Level Cut	25	9W-8874 9W-8875	6 6	RH LH	19	473-3020 4R-2945	2 2	9 5	Equipped from factory GP: (562-2667)
	Utility	35	122-8617 122-8618	6 6	RH LH					
	GP	30	6Y-4411 6Y-4410	6 6	RH LH					
	EWL	30	9W-1875 9W-1876	6 6	RH LH					
Specialty										
	Level Cut A.R.M.	25	433-9637 433-9639	6 6	RH LH					
	EWL A.R.M.	30	283-1027* 283-1028	6 6	RH LH					
Hardware, Repair Parts and Wear Protection										
Type	Description		Part Number	Quantity						Notes
Hardware	Bolts	3/4-10 x 2-1/2	5J-4773	40						Ensure Base Edge is flat and not excessively worn Clean and remove any paint on mating surfaces Torque, Band, Torque
	Nuts	3/4-10	2J-3506	40						
	Washers	3/4"	5P-8248	40						
Blade Repair	Edge Support		(560-1740)	1						

D6 LGP VPAT Blades

Blade Serial Numbers: K4N, EXH, F3T







Applies to: D6

End Bits and Cutting Edges 10"										
Type		End Bits				Edges				Notes
		Thickness	End Bits	Hardware	Position	Thickness	Edges	Quantity	Hardware	
	Level Cut	25	9W-8874 9W-8875	6 6	RH LH	19	473-3023	2	11	Equipped from factory GP: (473-3022)
	Utility	35	122-8617 122-8618	6 6	RH LH					
	GP	30	6Y-4411 6Y-4410	6 6	RH LH					
	EWL	30	9W-1875 9W-1876	6 6	RH LH					
Specialty										
	Level Cut A.R.M.	25	433-9637 433-9639	6 6	RH LH					
	EWL A.R.M.	30	283-1027* 283-1028	6 6	RH LH					
Hardware, Repair Parts and Wear Protection										
Type	Description		Part Number	Quantity	Notes					
Hardware	Bolts	3/4-10 x 2-1/2	5J-4773	34	Ensure Base Edge is flat and not excessively worn Clean and remove any paint on mating surfaces Torque, Bang, Torque					
	Nuts	3/4-10	2J-3506	34						
	Washers	3/4"	5P-8248	34						
Blade Repair	Edge Support		(458-2618)	1						

D6 XW Angle Blades

Blade Serial Numbers: 6HP, A6B, EG4







Applies to: D6R, D6T

End Bits and Cutting Edges 10"										
Type		End Bits				Edges				Notes
		Thickness	End Bits	Hardware	Position	Thickness	Edges	Quantity	Hardware	
	Level Cut	25	9W-8874 9W-8875	6 6	RH LH	19	109-9093	4	6	Equipped from factory GP: (109-9092)
	Utility	35	122-8617 122-8618	6 6	RH LH					
	GP	30	6Y-4411 6Y-4410	6 6	RH LH					
	EWL	30	9W-1875 9W-1876	6 6	RH LH					
Specialty										
	Level Cut A.R.M.	25	433-9637 433-9639	6 6	RH LH					
	EWL A.R.M.	30	283-1027* 283-1028	6 6	RH LH					
Hardware, Repair Parts and Wear Protection										
Type	Description		Part Number	Quantity	Notes					
Hardware	Bolts	3/4-10 x 2-1/2	5J-4773	36	Ensure Base Edge is flat and not excessively worn Clean and remove any paint on mating surfaces Torque, Bang, Torque					
	Nuts	3/4-10	2J-3506	36						
	Washers	3/4"	5P-8248	36						
Blade Repair	Edge Support		(4Z-9435)	1						

D6 XW VPAT Blades

Blade Serial Numbers: M3H, M4H, EG8







Applies to: D6R, D6T

End Bits and Cutting Edges 10"										
Type		End Bits				Edges				Notes
		Thickness	End Bits	Hardware	Position	Thickness	Edges	Quantity	Hardware	
	Level Cut	25	9W-8874 9W-8875	6 6	RH LH	19	229-6958	2	11	Equipped from factory GP: (223-3290)
	Utility	35	122-8617 122-8618	6 6	RH LH					
	GP	30	6Y-4411 6Y-4410	6 6	RH LH					
	EWL	30	9W-1875 9W-1876	6 6	RH LH					
Specialty										
	Level Cut A.R.M.	25	433-9637 433-9639	6 6	RH LH	19	433-9640	2	11	GP: (507-2858)
	EWL A.R.M.	30	283-1027* 283-1028	6 6	RH LH					
Hardware, Repair Parts and Wear Protection										
Type	Description		Part Number	Quantity	Notes					
Hardware	Bolts	3/4-10 x 2-1/2	5J-4773	34	Ensure Base Edge is flat and not excessively worn Clean and remove any paint on mating surfaces Torque, Bang, Torque					
	Nuts	3/4-10	2J-3506	34						
	Washers	3/4"	5P-8248	34						
Blade Repair	Edge Support		(223-3287)	1						

D6 XW Semi U-Blades

Blade Serial Numbers: 1WP, 9BP, B8B, GGP, GNP, GNL, EG9







Applies to: D6R, D6T

End Bits and Cutting Edges 10"										
Type		End Bits				Edges				Notes
		Thickness	End Bits	Hardware	Position	Thickness	Edges	Quantity	Hardware	
	Level Cut	25	9W-8874 9W-8875	6 6	RH LH	19	106-0956	2	9	Equipped from factory GP: (106-0955)
	Utility	35	122-8617 122-8618	6 6	RH LH	25	229-6599	2	9	GP: (507-2859)
	GP	30	6Y-4411 6Y-4410	6 6	RH LH	25	229-6599	2	9	GP: (507-2860)
	Performance	25	479-8137 479-8138	6 6	RH LH	25	479-8139 479-8140 479-8142	1 1 1	5 5 6	GP: (479-8152)
	EWL	30	9W-1875 9W-1876	6 6	RH LH	25	229-6599	2	9	GP: (507-2861)
Specialty										
	Level Cut A.R.M.	25	433-9637 433-9639	6 6	RH LH					
	EWL A.R.M.	30	283-1027* 283-1028	6 6	RH LH					
Hardware, Repair Parts and Wear Protection										
Type	Description		Part Number	Quantity	Notes					
Hardware	Bolts	3/4-10 x 2-1/2	5J-4773	30	Ensure Base Edge is flat and not excessively worn Clean and remove any paint on mating surfaces Torque, Bang, Torque					
	Nuts	3/4-10	2J-3506	30						
	Washers	3/4"	5P-8248	30						
Blade Repair	Edge		8E-5205	2						
	Support		4Z-9239*	1						

D6 XW Semi U-Blades

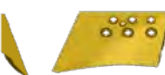
Blade Serial Numbers: GNE, DZ5, E8K







Applies to: D6

End Bits and Cutting Edges 10"										
Type		End Bits				Edges				Notes
		Thickness	End Bits	Hardware	Position	Thickness	Edges	Quantity	Hardware	
	Level Cut	25	9W-8874 9W-8875	6 6	RH LH	19	475-0936	2	9	Equipped from factory GP: (475-0196)
	Utility	35	122-8617 122-8618	6 6	RH LH					
	GP	30	6Y-4411 6Y-4410	6 6	RH LH					
	Performance	25	479-8137 479-8138	6 6	RH LH	25	593-0318 593-0319 479-8142	1 1 1	5 5 6	GP: (610-9750)
	EWL	30	9W-1875 9W-1876	6 6	RH LH					
Specialty										
	Level Cut A.R.M.	25	433-9637 433-9639	6 6	RH LH					
	EWL A.R.M.	30	283-1027* 283-1028	6 6	RH LH					
Hardware, Repair Parts and Wear Protection										
Type	Description		Part Number	Quantity	Notes					
Hardware	Bolts	3/4-10 x 2-1/2	5J-4773	30	Ensure Base Edge is flat and not excessively worn Clean and remove any paint on mating surfaces Torque, Bang, Torque					
	Nuts	3/4-10	2J-3506	30						
	Washers	3/4"	5P-8248	30						
Blade Repair	Edge Support		8E-5205 (463-5853)	2 1						

D6 XW Angle Blades

Blade Serial Numbers: PF9, E7Y, EFY







Applies to: D6

End Bits and Cutting Edges 10"										
Type		End Bits				Edges				Notes
		Thickness	End Bits	Hardware	Position	Thickness	Edges	Quantity	Hardware	
	Level Cut	25	9W-8874 9W-8875	6 6	RH LH	19	4T-2946 4T-2950	2 1	7 10	Equipped from factory GP: (562-2660)
	Utility	35	122-8617 122-8618	6 6	RH LH					
	GP	30	6Y-4411 6Y-4410	6 6	RH LH					
	EWL	30	9W-1875 9W-1876	6 6	RH LH					
Specialty										
	Level Cut A.R.M.	25	433-9637 433-9639	6 6	RH LH					
	EWL A.R.M.	30	283-1027* 283-1028	6 6	RH LH					
Hardware, Repair Parts and Wear Protection										
Type	Description		Part Number	Quantity	Notes					
Hardware	Bolts	3/4-10 x 2-1/2	5J-4773	36	Ensure Base Edge is flat and not excessively worn Clean and remove any paint on mating surfaces Torque, Bang, Torque					
	Nuts	3/4-10	2J-3506	36						
	Washers	3/4"	5P-8248	36						
Blade Repair	Edge Support		(556-4519)	1						

D6 XW VPAT Blades

Blade Serial Numbers: EZS, EXG, F3S

Applies to: D6

End Bits and Cutting Edges 10"										
Type		End Bits				Edges				Notes
		Thickness	End Bits	Hardware	Position	Thickness	Edges	Quantity	Hardware	
	Level Cut	25	9W-8874 9W-8875	6 6	RH LH	19	473-3852	2	10	Equipped from factory GP: (473-3021)
	Utility	35	122-8617 122-8618	6 6	RH LH					
	GP	30	6Y-4411 6Y-4410	6 6	RH LH					
	EWL	30	9W-1875 9W-1876	6 6	RH LH					
Specialty										
	Level Cut A.R.M.	25	433-9637 433-9639	6 6	RH LH					
	EWL A.R.M.	30	283-1027* 283-1028	6 6	RH LH					
Hardware, Repair Parts and Wear Protection										
Type	Description		Part Number	Quantity	Notes					
Hardware	Bolts	3/4-10 x 2-1/2	5J-4773	32	Ensure Base Edge is flat and not excessively worn Clean and remove any paint on mating surfaces Torque, Bang, Torque					
	Nuts	3/4-10	2J-3506	32						
	Washers	3/4"	5P-8248	32						
Blade Repair	Edge Support		(458-2614)	1						

Cat Dozers

OPTIONS

D7-D9 GET OPTIONS

A.R.M.
OPTION
AVAILABLE



Level Cut / Finish

- Recommended for finish and semi-finish dozing
- Matches cutting edge's depth of cut
- Low-impact, low abrasion materials only



A.R.M.
OPTION
AVAILABLE



Utility

- Thick cross-section for high face wear applications
- Acceptable in high impact, high abrasion applications



Hot Cupped

- Forward protruding profile for better penetration than flat plate

A.R.M.
OPTION
AVAILABLE



General Purpose (Factory First Fit)

- Sharpened, forward protruding profile for excellent penetration
- For fast blade loading, high productivity applications

A.R.M.
OPTION
AVAILABLE



EWL

- 25% more usable wear material than General Purpose
- Prolonged life and excellent penetration in abrasive conditions



Performance Cutting Edges

- Superior penetration
- Requires less ripping
- Up to 25% larger payload
- Available on SU blades for D6, D7, and D8



D8T, D8 SU BLADES

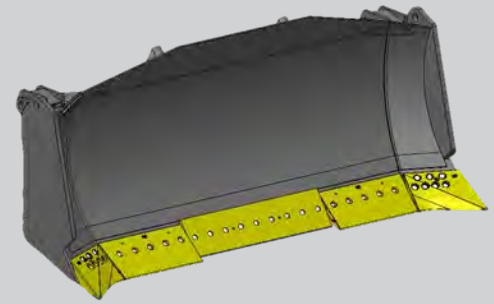

D7E, D7 SU BLADES

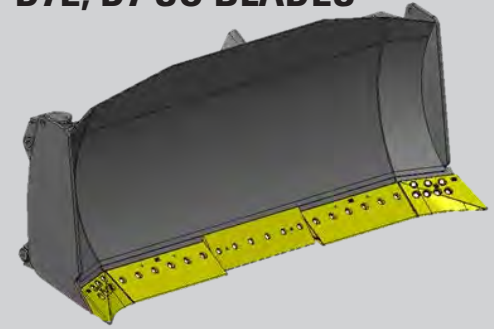

D6 SU BLADES (XL/XW)

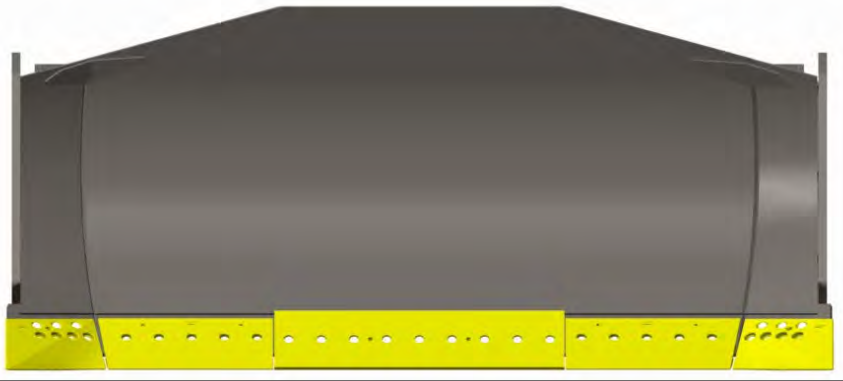
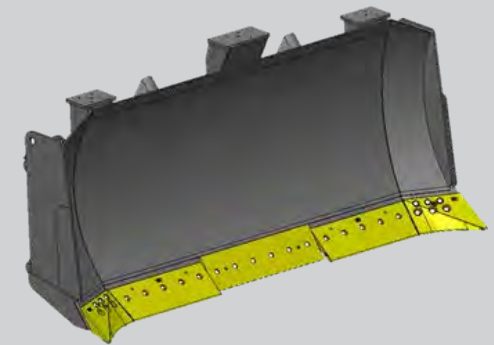

LEVEL CUT

Cat Performance Cutting Edges For Medium Track Type Tractors





Features:

- Wear material equivalent to standard production system
- Up to 35% increased payload mass
- Up to 17% greater productivity
- Increased ground penetration
- Finish dozing capable
- Decreased track slip

D7 LGP Straight-Blades

Blade Serial Numbers: 2RP, 8RH, 5SP, 9KP, J4L, CDN, 8JH (Excludes D7E), TXV





Applies to: D7R, D7

End Bits and Cutting Edges 11"										
Type		End Bits				Edges				Notes
		Thickness	End Bits	Hardware	Position	Thickness	Edges	Quantity	Hardware	
	Level Cut	25	568-9737 568-9738	7 7	RH LH	25	135-6537	3	7	GP: (125-5710)
	Utility	35	105-0575 105-0574	7 7	RH LH	35	145-7846	3	7	GP: (507-2866)
		45	105-0577 105-0576	7 7	RH LH					
	HC	22	421-3139 421-3138	7 7	RH LH	25	135-6537	3	7	GP: (507-2871)
	GP	26	522-6273 522-6272	7 7	RH LH	25	135-6537	3	7	Equipped from factory GP: (135-6538)
Hardware, Repair Parts and Wear Protection										
Type	Description		Part Number	Quantity	Notes					
Hardware	Bolts	7/8-9 x 2-3/4	6F-0196	35	Ensure Base Edge is flat and not excessively worn Clean and remove any paint on mating surfaces Torque, Bang, Torque					
	Nuts	7/8-9	2J-3505	35						
	Washers	7/8"	5P-8249	35						
Blade Repair	Edge Support		(135-6536)	1						
Wear Protection	Wear Bars									
	Wear Plates	12mm	(2J-8523)	5						
	Push Plate	16mm								

D7 LGP Straight-Blades

Blade Serial Numbers: DKC, JG5 (D7E models only)





Applies to: D7E

End Bits and Cutting Edges 11"										
Type		End Bits				Edges				Notes
		Thickness	End Bits	Hardware	Position	Thickness	Edges	Quantity	Hardware	
	Level Cut	25	568-9737 568-9738	7 7	RH LH	25	265-6934	3	7	GP: ((575-1446))
	Utility	35	105-0575 105-0574	7 7	RH LH	35	571-9431	3	7	GP: ((507-2872))
		45	105-0577 105-0576	7 7	RH LH					
	HC	22	421-3139 421-3138	7 7	RH LH	25	265-6934	3	7	GP: ((507-2881))
	GP	26	522-6273 522-6272	7 7	RH LH	25	265-6934	3	7	Equipped from factory GP: ((265-6940))
Hardware, Repair Parts and Wear Protection										
Type	Description		Part Number	Quantity	Notes					
Hardware	Bolts	7/8-9 x 2-3/4	6F-0196	35	Ensure Base Edge is flat and not excessively worn Clean and remove any paint on mating surfaces Torque, Bang, Torque					
	Nuts	7/8-9	2J-3505	35						
	Washers	7/8"	5P-8249	35						
Blade Repair	Edge Support		((264-9796))	1						
Wear Protection	Wear Bars									
	Wear Plates	8mm								
	Push Plate	16mm								

D7 Straight-Blades

Blade Serial Numbers: 6KB, 8ZB, 4XC, 8NH, J8L, CDC, 8GH, DME, JG9





Applies to: D7R, D7E, D7

End Bits and Cutting Edges 11"										
Type		End Bits				Edges				Notes
		Thickness	End Bits	Hardware	Position	Thickness	Edges	Quantity	Hardware	
	Level Cut	25	568-9737 568-9738	7 7	RH LH	25	7T-6678	3	6	GP: ((4T-2360))
	Utility	35	105-0575 105-0574	7 7	RH LH	35	107-3363	3	6	GP: ((507-2882))
		45	105-0577 105-0576	7 7	RH LH					
	HC	22	421-3139 421-3138	7 7	RH LH	25	7T-6678	3	6	GP: ((507-2884))
	GP	26	522-6273 522-6272	7 7	RH LH	25	7T-6678	3	6	Equipped from factory GP: ((7T-6677))
Hardware, Repair Parts and Wear Protection										
Type	Description		Part Number	Quantity	Notes					
Hardware	Bolts	7/8-9 x 2-3/4	6F-0196	32	Ensure Base Edge is flat and not excessively worn Clean and remove any paint on mating surfaces Torque, Bang, Torque					
	Nuts	7/8-9	2J-3505	32						
	Washers	7/8"	5P-8249	32						
Blade Repair	Edge Support		6Y-5701	1						
Wear Protection	Wear Bars									
	Wear Plates	8mm	3J-3142	3						
	Push Plate	16mm	4J-3699	1						

D7 Angling-Blades

Blade Serial Numbers: 4EB, 3CC, 4ZC, DMD, JG6





Applies to: D7R, D7E

End Bits and Cutting Edges 11"										
Type		End Bits				Edges				Notes
		Thickness	End Bits	Hardware	Position	Thickness	Edges	Quantity	Hardware	
	Level Cut	25	568-9737 568-9738	7 7	RH LH	25	7T-6589	3	7	GP: ((4T-3903*))
	Utility	35	105-0575 105-0574	7 7	RH LH	35	135-9778	3	7	GP: ((507-2889))
		45	105-0577 105-0576	7 7	RH LH					
	HC	22	421-3139 421-3138	7 7	RH LH	25	7T-6589	3	7	GP: ((507-2891))
	GP	26	522-6273 522-6272	7 7	RH LH	25	7T-6589	3	7	Equipped from factory GP: ((7T-6585))
Hardware, Repair Parts and Wear Protection										
Type	Description		Part Number	Quantity	Notes					
Hardware	Bolts	7/8-9 x 2-3/4	6F-0196	35	Ensure Base Edge is flat and not excessively worn Clean and remove any paint on mating surfaces Torque, Bang, Torque					
	Nuts	7/8-9	2J-3505	35						
	Washers	7/8"	5P-8249	35						
Blade Repair	Edge Support		((307-6153))	1						
Wear Protection	Wear Bars									
	Wear Plates	8mm	3J-3141	3						

D7 Angling-Blades

Blade Serial Numbers: NDS

Applies to: D7





End Bits and Cutting Edges 11"										
Type		End Bits				Edges				Notes
		Thickness	End Bits	Hardware	Position	Thickness	Edges	Quantity	Hardware	
	Level Cut	25	568-9737 568-9738	7 7	RH LH	25	7T-6678	4	6	Equipped from factory GP: (585-7017)
	Utility	35	105-0575 105-0574	7 7	RH LH	35	107-3363	4	6	
		45	105-0577 105-0576	7 7	RH LH					
	HC	22	421-3139 421-3138	7 7	RH LH	25	7T-6678	4	6	
	GP	26	522-6273 522-6272	7 7	RH LH	25	7T-6678	4	6	

Hardware, Repair Parts and Wear Protection					
Type	Description		Part Number	Quantity	Notes
Hardware	Bolts	7/8-9 x 2-3/4	6F-0196	38	Ensure Base Edge is flat and not excessively worn Clean and remove any paint on mating surfaces Torque, Bang, Torque
	Nuts	7/8-9	2J-3505	38	
	Washers	7/8"	5P-8249	38	
Blade Repair	Edge Support		(585-0945)	1	
Wear Protection	Wear Bars				
	Wear Plates				

D7 LGP Angling-Blades

Blade Serial Numbers: DKE





Applies to: D7E

End Bits and Cutting Edges 11"										
Type		End Bits				Edges				Notes
		Thickness	End Bits	Hardware	Position	Thickness	Edges	Quantity	Hardware	
	Level Cut	25	568-9737 568-9738	7 7	RH LH	25	394-5646	3	8	GP: ((575-1447))
	Utility	35	105-0575 105-0574	7 7	RH LH	35	571-9512	3	8	GP: ((507-2897))
		45	105-0577 105-0576	7 7	RH LH					
	HC	22	421-3139 421-3138	7 7	RH LH	25	394-5646	3	8	GP: ((507-2900))
	GP	26	522-6273 522-6272	7 7	RH LH	25	394-5646	3	8	Equipped from factory GP: ((394-5647))
Hardware, Repair Parts and Wear Protection										
Type	Description		Part Number	Quantity	Notes					
Hardware	Bolts	7/8-9 x 2-3/4	6F-0196	38	Ensure Base Edge is flat and not excessively worn Clean and remove any paint on mating surfaces Torque, Bang, Torque					
	Nuts	7/8-9	2J-3505	38						
	Washers	7/8"	5P-8249	38						
Blade Repair	Edge Support		((394-3838))	1						
Wear Protection	Wear Bars									
	Wear Plates									
	Push Plate									

D7 LGP Angling-Blades

Blade Serial Numbers: ZDS





Applies to: D7

End Bits and Cutting Edges 11"										
Type		End Bits				Edges				Notes
		Thickness	End Bits	Hardware	Position	Thickness	Edges	Quantity	Hardware	
	Level Cut	25	568-9737 568-9738	7 7	RH LH	25	7T-6678 135-6537	2 2	6 7	Equipped from factory GP: (576-6519)
	Utility	35	105-0575 105-0574	7 7	RH LH	35	107-3363 145-7846	2 2	6 7	
		45	105-0577 105-0576	7 7	RH LH					
	HC	22	421-3139 421-3138	7 7	RH LH	25	7T-6678 135-6537	2 2	6 7	
	GP	26	522-6273 522-6272	7 7	RH LH	25	7T-6678 135-6537	2 2	6 7	
Hardware, Repair Parts and Wear Protection										
Type	Description		Part Number	Quantity	Notes					
Hardware	Bolts	7/8-9 x 2-3/4	6F-0196	40	Ensure Base Edge is flat and not excessively worn Clean and remove any paint on mating surfaces Torque, Bang, Torque					
	Nuts	7/8-9	2J-3505	40						
	Washers	7/8"	5P-8249	40						
Blade Repair	Edge Support		(576-6452)	1						
Wear Protection	Wear Bars									
	Wear Plates									
	Push Plate									

D7 LGP Semi U-Blades

Blade Serial Numbers: A4S

Applies to: D7





End Bits and Cutting Edges 11"											
Type		End Bits				Edges					Notes
		Thickness	End Bits	Hardware	Position	Thickness	Edges	Quantity	Position	Hardware	
	Level Cut	25	568-9737 568-9738	7 7	RH LH	25	7T-6936 583-1903	2 1	E C	6 10	
	Utility	35	105-0575 105-0574	7 7	RH LH	35	107-3362 585-8222	2 1	E C	6 10	
		45	105-0577 105-0576	7 7	RH LH						
	HC	22	421-3139 421-3138	7 7	RH LH	25	7T-6936 583-1903	2 1	E C	6 10	
	GP	26	522-6273 522-6272	7 7	RH LH	25	7T-6936 583-1903	2 1	E C	6 10	Equipped from factory GP: (583-1904)
	Performance	25	522-6274	7	RH	35	479-8135	1	RH	6	Equipped from factory GP: (588-3553)
			522-6275	7	LH		479-8136 585-8222	1 1	LH C	6 10	

Hardware, Repair Parts and Wear Protection					
Type	Description	Part Number	Quantity	Notes	
Hardware	Bolts	7/8-9 x 2-3/4	6F-0196	36	Ensure Base Edge is flat and not excessively worn Clean and remove any paint on mating surfaces Torque, Bang, Torque
	Nuts	7/8-9	2J-3505	36	
	Washers	7/8"	5P-8249	36	
Blade Repair	Edge Support	6I-8380 (582-9039)	2 1		
Wear Protection	Wear Bars				
	Wear Plates				
	Push Plate				

D7 Semi U-Blades

Blade Serial Numbers: BBC, JG7





Applies to: D7E

End Bits and Cutting Edges 11"											
Type		End Bits				Edges					Notes
		Thickness	End Bits	Hardware	Position	Thickness	Edges	Quantity	Position	Hardware	
	Level Cut	25	568-9737 568-9738	7 7	RH LH	25	7T-6936 7T-6678	2 1	E C	6 6	GP: ((507-2901))
	Utility	35	105-0575 105-0574	7 7	RH LH	35	107-3362 107-3363	2 1	E C	6 6	GP: ((507-2902))
		45	105-0577 105-0576	7 7	RH LH						
	HC	22	421-3139 421-3138	7 7	RH LH	25	7T-6936 7T-6678	2 1	E C	6 6	GP: ((507-2909))
	GP	26	522-6273 522-6272	7 7	RH LH	25	7T-6936 7T-6678	2 1	E C	6 6	Equipped from factory GP: ((7T-6935))
	Performance	25	479-8133 479-8134	7 7	RH LH	35	479-8135 479-8136 107-3363	1 1 1	RH LH C	6 6 6	GP: ((479-8144))
Hardware, Repair Parts and Wear Protection											
Type	Description		Part Number	Quantity	Notes						
Hardware	Bolts	7/8-9 x 2-3/4	6F-0196	32	Ensure Base Edge is flat and not excessively worn Clean and remove any paint on mating surfaces Torque, Bang, Torque						
	Nuts	7/8-9	2J-3505	32							
	Washers	7/8"	5P-8249	32							
Blade Repair	Edge Support		345-7693 3G-5352	2 1							
Wear Protection	Wear Bars										
	Wear Plates	8mm	3J-3142	4							
		12mm	323-2915	1							
			323-2916 323-2914	1 1							
Push Plate	16mm	4J-3699	1								

D7 Semi U-Blades

Blade Serial Numbers: 4DB, 2FC, 2JH, 1JP, 8LH, CDT, J6L, BHT, 8EH, G32, E7R

Applies to: D7R, D7

End Bits and Cutting Edges 11"											
Type		End Bits				Edges					Notes
		Thickness	End Bits	Hardware	Position	Thickness	Edges	Quantity	Position	Hardware	
	Level Cut	25	568-9737 568-9738	7 7	RH LH	25	7T-6936 7T-6678	2 1	E C	6 6	GP: ((507-2901))
	Utility	35	105-0575 105-0574	7 7	RH LH	35	107-3362 107-3363	2 1	E C	6 6	GP: ((507-2902))
		45	105-0577 105-0576	7 7	RH LH						
	HC	22	421-3139 421-3138	7 7	RH LH	25	7T-6936 7T-6678	2 1	E C	6 6	GP: ((507-2909))
	GP	26	522-6273 522-6272	7 7	RH LH	25	7T-6936 7T-6678	2 1	E C	6 6	Equipped from factory GP: ((7T-6935))
	Performance	25	522-6274 522-6275	7 7	RH LH	35	479-8135 479-8136 107-3363	1 1 1	RH LH C	6 6 6	GP: (585-8890)
Hardware, Repair Parts and Wear Protection											
Type	Description		Part Number	Quantity	Notes						
Hardware	Bolts	7/8-9 x 2-3/4	6F-0196	32	Ensure Base Edge is flat and not excessively worn Clean and remove any paint on mating surfaces Torque, Bang, Torque						
	Nuts	7/8-9	2J-3505	32							
	Washers	7/8"	5P-8249	32							
Blade Repair	Edge Support		345-7693 3G-5352	2 1							
Wear Protection	Wear Bars										
	Wear Plates	8mm	3J-3142	4							
		12mm	323-2915	1							
			323-2916 323-2914	1 1							
Push Plate	16mm	4J-3699	1								





Cat Dozers

PART NUMBERS

D7 U-Blades

Blade Serial Numbers: 9JB, 7AC, 5SB, 8MH, J1L, CDL, DMF, JG8







Applies to: D7R, D7E, D7

End Bits and Cutting Edges 11"											
Type		End Bits				Edges					Notes
		Thickness	End Bits	Hardware	Position	Thickness	Edges	Quantity	Position	Hardware	
	Level Cut	25	568-9737 568-9738	7 7	RH LH	25	7T-6592 7T-6591	2 2	E C	4 6	GP: ((507-2910))
	Utility	35	105-0575 105-0574	7 7	RH LH	35	135-9626 135-9627	2 2	E C	4 6	GP: ((507-2911))
		45	105-0577 105-0576	7 7	RH LH						
	HC	22	421-3139 421-3138	7 7	RH LH	25	7T-6592 7T-6591	2 2	E C	4 6	GP: ((507-2917))
	GP	26	522-6273 522-6272	7 7	RH LH	25	7T-6592 7T-6591	2 2	E C	4 6	Equipped from factory GP: ((7T-6590))
Hardware, Repair Parts and Wear Protection											
Type	Description		Part Number	Quantity	Notes						
Hardware	Bolts	7/8-9 x 2-3/4	6F-0196	34	Ensure Base Edge is flat and not excessively worn Clean and remove any paint on mating surfaces Torque, Bang, Torque						
	Nuts	7/8-9	2J-3505	34							
	Washers	7/8"	5P-8249	34							
Blade Repair	Edge Support		6Y-5700 1U-1440	2 1							
Wear Protection	Wear Bars										
	Wear Plates	8mm	3J-3142	4	4 piece set						
		12mm	(323-2931*)	1	3 piece set						
			(323-2933*) (323-2932*)	1 1							
Push Plate	16mm	4J-3699	1								

D8 Angle-Blades

Blade Serial Numbers: BHR, 9ZP, DZD, D1E, D1F, DK4 , CB4

Applies to: D8R, D8T, D8

End Bits and Cutting Edges 13"										
Type		End Bits				Edges				Notes
		Thickness	End Bits	Hardware	Position	Thickness	Edges	Quantity	Hardware	
	Level Cut	40	6Y-4277 6Y-4278	7 7	RH LH	28	135-9373	3	8	GP: (507-2918)
	Utility	50	100-3139 100-3140	7 7	RH LH	45	135-9629	3	8	GP: (507-2919)
		60	136-8757 136-8756	7 7	RH LH					
	HC	35	3G-8291 3G-8292	7 7	RH LH	28	135-9373	3	8	GP: (507-2920)
		40	3G-8283 3G-8284	7 7	RH LH	35	135-9628	3	8	GP: (507-2921)
	GP	30	8E-4193 8E-4194	7 7	RH LH	28	135-9373	3	8	Equipped from factory GP: (135-9374)
	EWL	35	8E-4537 8E-4538	7 7	RH LH	35	135-9628	3	8	GP: (507-2922)
Specialty										
	Utility A.R.M.	50	379-3173* 379-3174	7 7	RH LH					
	GP A.R.M.	35	455-3704 455-3705 455-3704 455-3705	7 7 7	RH LH RH LH					
Hardware, Repair Parts and Wear Protection										
Type	Description		Part Number	Quantity	Notes					
Hardware	Bolts	1-8 x 3	4F-4042	38	Ensure Base Edge is flat and not excessively worn Clean and remove any paint on mating surfaces Torque, Bang, Torque					
	Nuts	1-8	2J-3507	38						
	Washers	1"	5P-8250	38						
Blade Repair	Edge Support		147-3527	1						







Cat Dozers

PART NUMBERS

D8 LGP Angle-Blades

Blade Serial Numbers: 7HW











Applies to: D8T, D8

End Bits and Cutting Edges 13"											
Type		End Bits				Edges				Notes	
		Thickness	End Bits	Hardware	Position	Thickness	Edges	Quantity	Hardware		
	Level Cut	40	6Y-4277 6Y-4278	7 7	RH LH	28	456-2889	3	9	GP: (565-2195)	
	Utility	50	100-3139 100-3140	7 7	RH LH	45	456-7775	3	9	GP: (565-2196)	
		60	136-8757 136-8756	7 7	RH LH						
	HC	35	3G-8291 3G-8292	7 7	RH LH	28	456-2889	3	9	GP: (565-2197)	
		40	3G-8283 3G-8284	7 7	RH LH	35	456-7774	3	9	GP: (565-2198)	
	GP	30	8E-4193 8E-4194	7 7	RH LH	28	456-2889	3	9	Equipped from factory GP: (456-8297)	
	EWL	35	8E-4537 8E-4538	7 7	RH LH	35	456-7774	3	9	GP: (565-2199)	
Specialty											
	Utility A.R.M.	50	379-3173* 379-3174	7 7	RH LH						
	GP A.R.M.	35	455-3704	7	RH						
			455-3705	7	LH						
			455-3704	7	RH						
			455-3705	7	LH						
Hardware, Repair Parts and Wear Protection											
Type	Description		Part Number	Quantity	Notes						
Hardware	Bolts	1-8 x 3	4F-4042	38	Ensure Base Edge is flat and not excessively worn Clean and remove any paint on mating surfaces Torque, Bang, Torque						
	Nuts	1-8	2J-3507	38							
	Washers	1"	5P-8250	38							
Blade Repair	Edge Support		147-3527	1							

D8 LGP Semi U-Blades

Blade Serial Numbers: KMB, LAA, DZC, DK5, CB6

Applies to: D8R, D8T, D8

End Bits and Cutting Edges 13"											
Type		End Bits				Edges					Notes
		Thickness	End Bits	Hardware	Position	Thickness	Edges	Quantity	Position	Hardware	
	Level Cut	40	6Y-4277 6Y-4278	7 7	RH LH	28	6Y-5540 4Z-9058	2 1	E C	5 13	
	Utility	50	100-3139 100-3140	7 7	RH LH						
		60	136-8757 136-8756	7 7	RH LH						
	HC	35	3G-8291 3G-8292	7 7	RH LH	28	6Y-5540 4Z-9058	2 1	E C	5 13	GP: (507-2926)
		40	3G-8283 3G-8284	7 7	RH LH						
	GP	30	8E-4193 8E-4194	7 7	RH LH	28	6Y-5540 4Z-9058	2 2	E C	5 13	Equipped from factory GP: 4Z-9057
	Performance	35	479-8129 479-8130	7 7	RH LH	35	479-8131 479-8132 522-3986	1 1 1	RH LH C	5 5 13	GP: 497-8143
	EWL	35	8E-4537 8E-4538	7 7	RH LH						
Specialty											
	Utility A.R.M	50	379-3173* 379-3174	7 7							
	GP A.R.M	35	455-3704 455-3705	7 7	RH LH						
			455-3704 455-3705	7 7	RH LH						
Hardware, Repair Parts and Wear Protection											
Type	Description	Part Number	Quantity	Notes							
Hardware	Bolts	1-8 x 3-1/4	4J-9058	36	Ensure Base Edge is flat and not excessively worn Clean and remove any paint on mating surfaces Torque, Bang, Torque						
	Nuts	1-8	2J-3507	36							
	Washers	1"	5P-8250	36							
Blade Repair	Edge Support		239-4172 256-4890	2 1							
	Protector		9J-9600	2	ref PELM1017 D8 and D9 Bulldozer Sidebar Protector ref PELJ1389 Shear Blocks for Sidebar Protectors						
	Shear Block		331-7417	2							
	Adapter Plate		152-0027	2							
	Retainer		8E-6359	4							
	Pin		135-9350	4							
Wear Protection	Wear Bars	25x203x4572	107-3391	2	Provides 2 wear bar coverage full width of blade						
		16mm	9W-2756 9W-2757 9W-2758 9W-2759 9W-2760	1 1 1 1 1	5 piece set						
	Push Plate	16mm	9W-2756	1							











Cat Dozers

PART NUMBERS

D8 Performance Semi U-Blades

Blade Serial Numbers: SN4, P32, ZA9











Applies to: D8T, D8

End Bits and Cutting Edges 13"											
Type		End Bits				Edges					Notes
		Thickness	End Bits	Hardware	Position	Thickness	Edges	Quantity	Position	Hardware	
	Level Cut	40	6Y-4277 6Y-4278	7 7	RH LH	28	6Y-5540 460-4973	2 1	E C	5 9	GP: (565-2190)
	Utility	50	100-3139 100-3140	7 7	RH LH	45	112-2471 474-7182	2 1	E C	5 9	GP: (565-2191)
		60	136-8757 136-8756	7 7	RH LH						
	HC	35	3G-8291 3G-8292	7 7	RH LH	28	6Y-5540 460-4973	2 1	E C	5 9	GP: (565-2192)
		40	3G-8283 3G-8284	7 7	RH LH	35	7T-9125 474-7181	2 1	E C	5 9	GP: (565-2193)
	GP	30	8E-4193 8E-4194	7 7	RH LH	28	6Y-5540 460-4973	2 1	E C	5 9	Equipped from factory GP: (461-2342)
	Performance	35	479-8129 479-8130	7 7	RH LH	35	479-8131 479-8132 474-7181	1 1 1	RH LH C	5 5 9	GP: (517-5504)
	EWL	35	8E-4537 8E-4538	7 7	RH LH	35	7T-9125 474-7181	2 1	E C	5 9	GP: (497-8346)
Specialty											
	Utility A.R.M	50	379-3173* 379-3174	7 7	RH LH						
	GP A.R.M	35	455-3704 455-3705	7 7	RH LH						
			455-3704 455-3705	7 7	RH LH						
Hardware, Repair Parts and Wear Protection											
Type	Description		Part Number	Quantity	Notes						
Hardware	Bolts	1-8 x 3-1/4	4J-9058	36	Ensure Base Edge is flat and not excessively worn Clean and remove any paint on mating surfaces Torque, Bang, Torque						
	Nuts	1-8	2J-3507	36							
	Washers	1"	5P-8250	36							
Blade Repair	Edge Support		239-4172 256-4890	2 1							
	Protector		9J-9600	2	ref PELM1017 D8 and D9 Bulldozer Sidebar Protector ref PELJ1389 Shear Blocks for Sidebar Protectors						
	Shear Block		331-7417	2							
	Adapter Plate		152-0027	2							
	Retainer		8E-6359	4							
	Pin		135-9350	4							
Wear Protection	Wear Bars	25x203x3658	107-3391	2	Provides 2 wear bar coverage full width of blade						
	Wear Plates	14mm	9W-2757	1	3 piece set						
			9W-2760	1							
			9W-1771	1							
	Wear Plates	16mm	9W-2756	1	5 piece set						
			9W-2757	1							
9W-2758			1								
9W-2759			1								
Push Plate	16mm	9W-2756	1								

D8 Semi U-Blades

Blade Serial Numbers: 1KH, 2PP, 3MP, 3WH, 1HP, 6LH, 9BH, 9PH, 2NP, 05A, 9TP, BHW, B8S, DZA, DZX, DK2, CB9

Applies to: D8R, D8T, D8

End Bits and Cutting Edges 13"											
Type		End Bits				Edges					Notes
		Thickness	End Bits	Hardware	Position	Thickness	Edges	Quantity	Position	Hardware	
	Level Cut	40	6Y-4277 6Y-4278	7 7	RH LH	28	6Y-5540 4T-6381	2 1	E C	5 9	GP: (507-2837)
	Utility	50	100-3139 100-3140	7 7	RH LH	45	112-2471 112-2472	2 1	E C	5 9	GP: (507-2838)
		60	136-8757 136-8756	7 7	RH LH						
	HC	35	3G-8291 3G-8292	7 7	RH LH	28	6Y-5540 4T-6381	2 1	E C	5 9	GP: (507-2839)
		40	3G-8283 3G-8284	7 7	RH LH	35	7T-9125 7T-9126	2 1	E C	5 9	GP: (507-2840)
	GP	30	8E-4193 8E-4194	7 7	RH LH	28	6Y-5540 4T-6381	2 1	E C	5 9	Equipped from factory GP: (7T-5558)
	Performance	35	479-8129 479-8130	7 7	RH LH	35	479-8131 479-8132 7T-9126	1 1 1	RH LH C	5 5 9	GP: 497-8143
	EWL	35	8E-4537 8E-4538	7 7	RH LH	35	7T-9125 7T-9126	2 1	E C	5 9	GP: (9W-9096)
Specialty											
	Utility A.R.M	50	379-3173* 379-3174	7 7	RH LH						
	GP A.R.M	35	455-3704 455-3705	7 7	RH LH						
			455-3704 455-3705	7 7	RH LH						
Hardware, Repair Parts and Wear Protection											
Type	Description		Part Number	Quantity	Notes						
Hardware	Bolts	1-8 x 3-1/4	4J-9058	33	Ensure Base Edge is flat and not excessively worn Clean and remove any paint on mating surfaces Torque, Bang, Torque						
	Nuts	1-8	2J-3507	33							
	Washers	1"	5P-8250	33							
Blade Repair	Edge Support		239-4172 239-4176	2 1							
	Protector		9J-9600	2	ref PELM1017 D8 and D9 Bulldozer Sidebar Protector ref PELJ1389 Shear Blocks for Sidebar Protectors						
	Shear Block		331-7417	2							
	Adapter Plate		152-0027	2							
	Retainer		8E-6359	4							
	Pin		135-9350	4							
Wear Protection	Wear Bars	25x203x4572	107-3389	2	Provides 2 wear bar coverage full width of blade						
	Wear Plates	14mm	9W-2757	1	3 piece set						
			9W-2760	1							
			9W-1771	1							
	Wear Plates	16mm	9W-2756	1	5 piece set						
9W-2757			1								
9W-2758 9W-2759 9W-2760			1 1 1								
Push Plate	16mm	9W-2756	1								











Cat Dozers

PART NUMBERS

D8 U-Blades

Blade Serial Numbers: 1JH, 2WP, 6AH, 9CH, 9WP, CXB, A5G, DZB, DK3, CB3, A79











Applies to: D8R, D8T, D8

End Bits and Cutting Edges 13"												
Type		End Bits				Edges					Notes	
		Thickness	End Bits	Hardware	Position	Thickness	Edges	Quantity	Position	Hardware		
	Level Cut	40	6Y-4277 6Y-4278	7 7	RH LH	28	4T-6378 9W-5232	2 2	E C	6 5	GP: (507-2924)	
	Utility	50	100-3139 100-3140	7 7	RH LH	45	112-2475 112-2473	2 2	E C	6 5	GP: (507-2925)	
		60	136-8757 136-8756	7 7	RH LH							
	HC	35	3G-8291 3G-8292	7 7	RH LH	28	4T-6378 9W-5232	2 2	E C	6 5	GP: (507-2926)	
		40	3G-8283 3G-8284	7 7	RH LH	35	9W-6092 7T-9127	2 2	E C	6 5	GP: (507-2927)	
	GP	30	8E-4193 8E-4194	7 7	RH LH	28	4T-6378 9W-5232	2 2	E C	6 5	Equipped from factory GP: (7T-5559)	
	EWL	35	8E-4537 8E-4538	7 7	RH LH	35	9W-6092 7T-9127	2 2	E C	6 5	GP: (9W-9097)	
Specialty												
	Utility A.R.M	50	379-3173* 379-3174	7 7	RH LH							
	GP A.R.M	35	455-3704 455-3705	7 7	RH LH							
			455-3704 455-3705	7 7	RH LH							
	HD Mining		n/a			120 60	113-0343* 113-0323*	2 1	E C	9 14		
Hardware, Repair Parts and Wear Protection												
Type	Description		Part Number	Quantity	Notes							
Hardware	Bolts	1-8 x 3-1/4	4J-9058	36	Ensure Base Edge is flat and not excessively worn Clean and remove any paint on mating surfaces Torque, Bang, Torque							
	Nuts	1-8	2J-3507	36								
	Washers	1"	5P-8250	36								
Blade Repair	Edge Support		255-8188 255-8189	2 1								
	Protector		9J-9600	2	ref PELM1017 D8 and D9 Bulldozer Sidebar Protector ref PELJ1389 Shear Blocks for Sidebar Protectors							
	Shear Block		331-7417	2								
	Adapter Plate		152-0027	2								
	Retainer		8E-6359	4								
	Pin		135-9350	4								
Wear Protection	Wear Bars	25x203x4572	107-3391	2	Provides 2 wear bar coverage full width of blade							
	Wear Plates	14mm	6Y-7244 6Y-7245 6Y-7246	1 1 1	3 piece set							
			16mm	9T-0253* 9T-0254* 4T-9592* 9T-0255* 9T-0256*	1 1 1 1 1	5 piece set						
				Push Plate	16mm	4T-9592*	1					

D9 Semi U-Blades

Blade Serial Numbers: 1MH, 5BH, 1LP, 2LP, 7NH, 2ZP, 2BP, 9LH, 9RP, CLC, CLN, CLY, CMA, T9J, DKX, 9S2

Applies to: D9R, D9T, D9

End Bits and Cutting Edges 13"											
Type		End Bits				Edges					Notes
		Thickness	End Bits	Hardware	Position	Thickness	Edges	Quantity	Position	Hardware	
	Level Cut	40	6Y-4277 6Y-4278	7 7	RH LH	28	6Y-5540 6Y-5539	2 1	E C	5 12	GP: (507-2928)
		60	113-0336 113-0334	7 7	RH LH	60	113-0321 113-0322	2 1	E C	5 12	GP: (507-2929)
	Utility	45	100-3135 100-3136	7 7	RH LH	45	112-2471 9W-7043	2 1	E C	5 12	GP: (507-2930)
		60	100-3137 100-3138	7 7	RH LH	60	113-0321 113-0322	2 1	E C	5 12	GP: (507-2931)
	HC	35	3G-8291 3G-8292	7 7	RH LH	28	6Y-5540 6Y-5539	2 1	E C	5 12	GP: (507-2932)
		40	3G-8283 3G-8284	7 7	RH LH	35	7T-9125 7T-5702	2 1	E C	5 12	GP: (507-2933)
	GP	35	8E-4197 8E-4196	7 7	RH LH	35	7T-9125 7T-5702	2 1	E C	5 12	Equipped from factory GP: (7T-5391)
	EWL	45	8E-4539 8E-4540	7 7	RH LH	45	112-2471 9W-7043	2 1	E C	5 12	Equipped from factory w/ rock guard package GP: (9W-7041)
Specialty											
	Level Cut	40	455-3697 455-3698	7 7	RH LH	28	455-3702 455-3696	2 1	E C	5 12	GP: (507-2934)
		GP A.R.M.	35	275-5993 275-5994	7 7						RH LH
	EWL A.R.M.	45	377-5702 377-5703	7 7	RH LH	45	436-6252 436-6251 436-6250	1 1 1	RE LE C	5 5 12	GP: (507-2936)
			436-6253 436-6254	7 7	RH LH						GP: (507-2937)
	HD Mining	120	113-0332 113-0333	7 7	RH LH	60	113-0321 113-0322	2 1	E C	5 12	GP: (113-0320)
Hardware, Repair Parts and Wear Protection											
Type	Description		Part Number	Quantity	Notes						
Hardware	Bolts	1-8 x 3-1/2	4J-9208	36	Ensure Base Edge is flat and not excessively worn Clean and remove any paint on mating surfaces Torque, Bang, Torque						
	Nuts	1-8	2J-3507	36							
	Washers	1"	5P-8250	36							
Blade Repair	Edge Support		8E-5590 109-6347	2 1							
	Protector		9J-9600	2	ref PELM1017 D8 and D9 Bulldozer Sidebar Protector ref PELJ1389 Shear Blocks for Sidebar Protectors						
	Shear Block		331-7417	2							
	Adapter Plate		152-0027	2							
	Retainer		8E-6359	4							
	Pin		135-9350	4							
Wear Protection	Wear Bars	25x203x3658 25x203x2438	107-3389 107-3386*	2 1	Provides 2 wear bar coverage full width of blade						
	Wear Plates	14mm	218-3885 218-3887 218-3888	1 1 1	3 piece set						
		14mm	218-3885	1	5 piece set						
		16mm	9T-0251	1							
	14mm	7T-5803 9T-0252	1 1								
	Push Plate	16mm	218-3887 7T-5803	1 1							











Cat Dozers

PART NUMBERS

D9 U-Blades

Blade Serial Numbers: 1LH, 2ZH, 1MP, 7PH, 9MP, CMH, CMN, CMS, CMW, CMZ, T9H, DKZ, D9J

Applies to: D9R, D9T, D9

End Bits and Cutting Edges 13"											
Type		End Bits				Edges					Notes
		Thickness	End Bits	Hardware	Position	Thickness	Edges	Quantity	Position	Hardware	
	Level Cut	40	6Y-4277 6Y-4278	7 7	RH LH	28	6Y-5540 6Y-5538	2 1	E C	5 15	GP: (507-2938)
		60	113-0336 113-0334	7 7	RH LH						
	Utility	45	100-3135 100-3136	7 7	RH LH	45	112-2471 9W-7044	2 1	E C	5 15	GP: (507-2939)
		60	100-3137 100-3138	7 7	RH LH						
	HC	35	3G-8291 3G-8292	7 7	RH LH	28	6Y-5540 6Y-5538	2 1	E C	5 15	GP: (507-2940)
		40	3G-8283 3G-8284	7 7	RH LH		35	7T-9125 7T-5701	2 1	E C	
	GP	35	8E-4197 8E-4196	7 7	RH LH	35	7T-9125 7T-5701	2 1	E C	5 15	Equipped from factory GP: (7T-5394)
	EWL	45	8E-4539 8E-4540	7 7	RH LH	45	112-2471 9W-7044	2 1	E C	5 15	Equipped from factory w/ rock guard package GP: (9W-7042)
Specialty											
	GP A.R.M.	35	275-5993 275-5994	7 7	RH LH						
	EWL A.R.M.	45	377-5702 377-5703	7 7	RH LH						
			436-6253 436-6254	7 7	RH LH						
	HD Mining	120	113-0332 113-0333	7 7	RH LH	60	113-0321 113-0322	2 1	E C	5 12	
Hardware, Repair Parts and Wear Protection											
Type	Description		Part Number	Quantity	Notes						
Hardware	Bolts	1-8 x 3-1/2	4J-9208	39	Ensure Base Edge is flat and not excessively worn Clean and remove any paint on mating surfaces Torque, Bang, Torque						
	Nuts	1-8	2J-3507	39							
	Washers	1"	5P-8250	39							
Blade Repair	Edge Support		8E-9228 8E-9227	2 1	ref PELM1017 D8 and D9 Bulldozer Sidebar Protector ref PELJ1389 Shear Blocks for Sidebar Protectors						
	Protector		9J-9600	2							
	Shear Block		331-7417	2							
	Adapter Plate		152-0027	2							
	Retainer		8E-6359	4							
	Pin		135-9350	4							
Wear Protection	Wear Bars	25x203x2438	107-3386*	4	Provides 2 wear bar coverage full width of blade						
	Wear Plates	14mm	217-7155	1							
			217-7156 217-7157	1 1							
	Push Plate	16mm	7T-5803	1							

Cat Dozers

OPTIONS

D10-D11 GET OPTIONS



Level Cut / Finish

- Recommended for finish and semi-finish dozing
- Matches cutting edge's depth of cut
- Low-impact, low abrasion materials only



Utility

- Thick cross-section for high face wear applications
- Acceptable in high impact, high abrasion applications



Hot Cupped

- Forward protruding profile for better penetration than flat plate



General Purpose

- Sharpened, forward protruding profile for excellent penetration
- For fast blade loading, high productivity applications

A.R.M.
OPTION
AVAILABLE



EWL (Factory First Fit)

- 25% more usable wear material than General Purpose
- Prolonged life and excellent penetration in abrasive conditions



EEWL

- 25% more usable wear material than General Purpose
- Prolonged life and excellent penetration in abrasive conditions



High Abrasion

- 25% more usable wear material than General Purpose
- Prolonged life and excellent penetration in abrasive conditions

Cat Dozers

PART NUMBERS

D10 Semi U-Blades

Blade Serial Numbers: 1RH, 7RH, 4KP, 6EP, BHJ, BHA, JGD, EPB

Applies to: D10R, D10T

End Bits and Cutting Edges 16"												
Type	End Bits					Edges					Kits	Notes
	Thickness	End Bits	Hardware	Position	Thickness	Edges	Quantity	Position	Hardware	Edge Kit End Bit Kit		
 Level Cut	35	3G-7763 3G-7764	7 7	RH LH	35	9W-6608 9W-6609	2 2	E C	5 6		GP: (507-2942)	
 Utility	45	100-3131 100-3132	7 7	RH LH	45	9W-6657 9W-6656	2 2	E C	5 6	415-7996 N/A	GP: (507-2943)	
	60	100-3133 100-3134	7 7	RH LH	60	8E-2086 8E-2085	2 2	E C	5 6	415-7997 N/A	GP: (507-2944)	
	75	136-8755 136-8754	7 7	RH LH	75	135-9579 135-9580	2 2	E C	5 6	415-8000 N/A	GP: (507-2945)	
 HC	40	1U-1545 1U-1546	7 7	RH LH	35	9W-6608 9W-6609	2 2	E C	5 6		GP: (507-2946)	
	60	7T-4689 7T-4688	7 7	RH LH	60	8E-2086 8E-2085	2 2	E C	5 6	415-7997 N/A	GP: (507-2947)	
 GP	35	8E-4199 8E-4198	7 7	RH LH	35	9W-6608 9W-6609	2 2	E C	5 6		GP: (7T-8712)	
 EWL	45	8E-4541 8E-4542	7 7	RH LH	45	9W-6657 9W-6656	2 2	E C	5 6	415-7996 415-8003	GP: (9W-5652)	
 EEWL	60	275-5941 275-5942	7 7	RH LH	60	8E-2086 8E-2085	2 2	E C	5 6	415-7997 (415-8004)	GP: (507-2948)	
 HA	50	434-1335	7	RH	50	392-7960	2	E	5		GP: (507-2949)	
		434-1336	7	LH		392-7959	2	C				
Specialty												
 EWL A.R.M.	45	195-7173	7	RH								
		195-7174	7	LH								
 EWL A.R.M.	45	(445-7681)	7	RH								
		(445-7682)	7	LH								
 EEWL A.R.M.					60	201-1230	1	R	5			
						195-9170	1	L	5			
						195-9171	2	C	6			
 HD Mining	120	107-3515 107-3516	6 6	RH LH	60	107-3510	1	C	22		GP: (107-3500)	
Hardware, Repair Parts and Wear Protection												
Type	Description		Part Number	Quantity	Notes							
Hardware	Bolts	1-1/4 - 7 x 4	5P-8823	36	Ensure Base Edge is flat and not excessively worn Clean and remove any paint on mating surfaces Torque, Bang, Torque							
	Nuts	1-1/4 - 7	3K-9770	36								
	Washers	1-1/4	4K-0684	36								
Blade Repair	Edge Support		8E-3581 8E-7430	2 1	ref PELM0918 D10 and D11 Bulldozer Sidebar Protector ref PELJ1389 Shear Blocks for Sidebar Protectors							
Sidebar Protector	Protector		125-0800	2								
	Shear Block		330-4455	2								
	Adapter Plate		135-9794	2								
	Retainer		4T-4707	4								
	Pin		8E-4708	4								
Side Cutter	Weld-On Half Arrow		135-9793	2	ref PELM0918 D10 and D11 Bulldozer Sidebar Protector							
Wear Protection	Wear Bars		25x203x3962 25x203x2438	2 1	Provides 2 wear bar coverage full width of blade							
	Wear Plates		14mm	1 1 1								
	Push Plate		16mm	1								
				1								

Cat Dozers

PART NUMBERS

D10 U-Blades

Blade Serial Numbers: 1SH, 7WH, 4LP, 6FP, BHF, BHP, SRP, EPA







Applies to: D10R, D10T

End Bits and Cutting Edges 16"												
Type	End Bits					Edges					Kits	Notes
	Thickness	End Bits	Hardware	Position	Thickness	Edges	Quantity	Position	Hardware	Edge Kit End Bit Kit		
 Level Cut	35	3G-7763 3G-7764	7 7	RH LH	35	9W-6608 9W-6615	2 3	E C	5 5		GP: (507-2942)	
 Utility	45	100-3131 100-3132	7 7	RH LH	45	9W-6657 9W-6658	2 3	E C	5 5	415-7998 N/A	GP: (507-2943)	
	60	100-3133 100-3134	7 7	RH LH	60	8E-2086 8E-2087	2 3	E C	5 5	415-7999 N/A	GP: (507-2944)	
	75	136-8755 136-8754	7 7	RH LH								GP: (507-2945)
 HC	40	1U-1545 1U-1546	7 7	RH LH	35	9W-6608 9W-6615	2 3	E C	5 5		GP: (507-2946)	
	60	7T-4689 7T-4688	7 7	RH LH	60	8E-2086 8E-2087	2 3	E C	5 5	415-7999 N/A	GP: (507-2947)	
 GP	35	8E-4199 8E-4198	7 7	RH LH	35	9W-6608 9W-6615	2 3	E C	5 5		GP: 7T-8713*	
 EWL	45	8E-4541 8E-4542	7 7	RH LH	45	9W-6657 9W-6658	2 3	E C	5 5	415-7998 415-8003	GP: (9W-5652)	
 EEWL	60	275-5941 275-5942	7 7	RH LH	60	8E-2086 8E-2087	2 3	E C	5 5	415-7999 (415-8004)	GP: (507-2948)	
 HA	50	434-1335 434-1336	7 7	RH LH	50	392-7960 392-7961	2 3	E C	5 5		GP: (507-2949)	
Specialty												
 EWL A.R.M.	45	195-7173 195-7174	7 7	RH LH								
 EWL A.R.M.	45	(445-7681) (445-7682)	7 7	RH LH								
 EEWL A.R.M.					60	201-1230 195-9170 223-8149	1 1 2	R L C	5 5 6			
 HD Mining	120/60	n/a			120 60	113-0338 8E-2087	2 3	E C	9 5		GP: (113-0318)	
Hardware, Repair Parts and Wear Protection												
Type	Description		Part Number	Quantity	Notes							
Hardware	Bolts		1-1/4 - 7 x 4	5P-8823	39	Ensure Base Edge is flat and not excessively worn Clean and remove any paint on mating surfaces Torque, Bang, Torque						
	Nuts		1-1/4 - 7	3K-9770	39							
	Washers		1-1/4	4K-0684	39							
Blade Repair	Edge Support		8E-5080 8E-6867	2 1								
 Sidebar Protector	Protector			125-0800	2	ref PELM0918 D10 and D11 Bulldozer Sidebar Protector ref PELJ1389 Shear Blocks for Sidebar Protectors						
	Shear Block			330-4455	2							
	Adapter Plate			135-9794	2							
	Retainer			4T-4707	4							
	Pin			8E-4708	4							
 Side Cutter	Weld-On Half Arrow			135-9793	2	ref PELM0918 D10 and D11 Bulldozer Sidebar Protector						
Wear Protection	Wear Bars		25x203x2743	107-3387*	4	Provides 2 wear bar coverage full width of blade						
	Wear Plates		14mm	218-3939	1							
				218-3940	1							
			218-3941	1								

D11 Semi U-Blades

Blade Serial Numbers: 4BB, 4KB, 9NH, 1AP, 4XP, 8PP, EPP

Applies to: D11R, D11T, D11

End Bits and Cutting Edges 16"												
Type	End Bits					Edges					Kits	Notes
	Thickness	End Bits	Hardware	Position	Thickness	Edges	Quantity	Position	Hardware	Edge Kit End Bit Kit		
	Utility	60	8E-9785	9	RH	60	9W-4494	2	E	9	415-7991	GP: (521-8468)
			8E-9786	9	LH		9W-4495	2	C	9	N/A	
	GP	45	8E-4543	9	RH	45	9W-2425	2	E	9	415-7992	GP: (521-8466)
			8E-4544	9	LH		9W-2426	2	C	9		
	EWL	60	8E-4545	9	RH	60	9W-4494	2	E	9	415-7991 415-8001	GP: (9W-7604)
			8E-4546	9	LH		9W-4495	2	C	9		
	EEWL	75	275-5445	9	RH	75	135-9577	2	E	9	415-7992	GP: (521-8467)
			275-5446	9	LH		135-9578	2	C	9		
	HA	80	434-1337	9	RH	80	392-7963	2	E	9		GP: (521-8468)
			434-1338	9	LH		392-7964	2	C	9		
Specialty												
	EWL A.R.M.	60	195-7171	9	RH	60	195-9174	1	L	9		GP: (521-8469)
			195-7172	9	LH		201-1231	1	R	9		
	Offset Reversible	45	273-7225	9	RH	45	138-6484*	1	L	9		GP: (521-8471)
			273-7226	9	LH		138-6485*	1	R	9		
	1/2 life End Bits		273-7228	9	RH		138-6486*	2	C	9		GP: (521-8472)
			273-7229	9	LH							
	HD Mining	120	107-3521*	8	RH	60	107-3523	1	C	28		GP: (107-3501)
			107-3522*	8	LH							
Hardware, Repair Parts and Wear Protection												
Type	Description		Part Number	Quantity	Notes							
Hardware	Bolts	1-1/4 - 7 x 4	5P-8823	54	Ensure Base Edge is flat and not excessively worn Clean and remove any paint on mating surfaces Torque, Bang, Torque							
	Nuts	1-1/4 - 7	3K-9770	54								
	Washers	1-1/4	4K-0684	54								
Blade Repair	Edge Support		101-9540 101-9533	2 1								
	Protector		125-0800	2	ref PELM0918 D10 and D11 Bulldozer Sidebar Protector ref PELJ1389 Shear Blocks for Sidebar Protectors							
	Shear Block		330-4455	2								
	Adapter Plate		135-9794	2								
	Retainer		4T-4707	4								
Side Cutter 	Weld-On Half Arrow		135-9793	2	ref PELM0918 D10 and D11 Bulldozer Sidebar Protector							
	Wear Bars	25x203x4572 25x203x2438	107-3391 107-3386*	2 1	Provides 2 wear bar coverage full width of blade							
Wear Protection	Wear Plates	14mm	136-3984 136-3985 136-3986	1 1 1								











Cat Dozers

PART NUMBERS

D11 U-Blade

Blade Serial Numbers: 4CB, 5TB, 9MH, 9ZH, 4YP, 8RP, LWP



Applies to: D11R, D11T, D11

End Bits and Cutting Edges 16"												
Type	End Bits					Edges					Kits	Notes
	Thickness	End Bits	Hardware	Position	Thickness	Edges	Quantity	Position	Hardware	Edge Kit End Bit Kit		
	Utility	60	8E-9785 8E-9786	9 9	RH LH	60	9W-4493 9W-4494 9W-4495	2 2 1	I E C	9 9 9	415-7993 N/A	GP: (521-8473)
		75	8E-9749 8E-9748	9 9	RH LH	75	195-7187 135-9577 135-9578	2 2 1	I E C	9 9 9	415-7994 N/A	GP: (521-8474)
	GP	45	8E-4543 8E-4544	9 9	RH LH	45	9W-2424 9W-2425 9W-2426	2 2 1	I E C	9 9 9		GP: (521-8475)
	EWL	60	8E-4545 8E-4546	9 9	RH LH	60	9W-4493 9W-4494 9W-4495	2 2 1	I E C	9 9 9	415-7993 415-8001	GP: (9W-7605)
	EEWL	75	275-5445 275-5446	9 9	RH LH	75	195-7187 135-9577 135-9578	2 2 1	I E C	9 9 9	415-7994 415-8002	GP: (521-8476)
	HA	80	434-1337 434-1338	9 9	RH LH	80	392-7962 392-7963 392-7964	2 2 1	I E C	9 9 9		GP: (521-8477)
Specialty												
	EWL A.R.M	60	195-7171 195-7172	9 9	RH LH	60	195-9173 195-9174 201-1231 195-9175	2 1 1 1	I RE LE C	9 9 9 9		GP: (208-5182)
			387-8251 387-8252	9 9	RH LH							
	Offset Reversible	45	273-7225 273-7226	9 9	RH LH	45	138-6483* 138-6484* 138-6485* 138-6486*	2 1 1 1	I RE LE C	9 9 9 9		GP: (138-6487)
			273-7228 273-7229	9 9	RH LH							
	HD Mining		n/a	n/a	n/a	120 60	109-9047 109-9050	2 1	E C	12 21		GP: (109-9046)
Hardware, Repair Parts and Wear Protection												
Type	Description		Part Number	Quantity	Notes							
Hardware	Bolts	1-1/4 - 7 x 4	5P-8823	63	Ensure Base Edge is flat and not excessively worn Clean and remove any paint on mating surfaces Torque, Bang, Torque							
	Nuts	1-1/4 - 7	3K-9770	63								
	Washers	1-1/4	4K-0684	63								
Blade Repair	Edge Support		8E-6346 8E-6347	2 1								
	Protector		125-0800	2	ref PELM0918 D10 and D11 Bulldozer Sidebar Protector ref PELJ1389 Shear Blocks for Sidebar Protectors							
	Shear Block		330-4455	2								
	Adapter Plate		135-9794	2								
	Retainer		4T-4707	4								
	Pin		8E-4708	4								
Side Cutter	Weld-On Half Arrow		135-9793	2	ref PELM0918 D10 and D11 Bulldozer Sidebar Protector							
Wear Protection	Wear Bars	25x203x3352	107-3388*	4	Provides 2 wear bar coverage full width of blade							
	Wear Plates	14mm	126-8341 126-8342 126-8343	1 1 1								

D11 Extra Capacity U-Blade

Blade Part Numbers: 576-4925, 579-3271, 583-6249, 583-6247













Applies to: D11R, D11T, D11

End Bits and Cutting Edges 16"												
Type		End Bits				Edges					Notes	
		Thickness	End Bits	Hardware	Position	Thickness	Edges	Quantity	Position	Hardware		
	Utility	60	8E-9785	9	RH	60	6Y-0022	2	I	7		
			8E-9786	9	LH		486-0516	2	E	5		
							9W-4495	1	C	9		
	GD	45	8E-4543	9	RH	45	6Y-0019	2	I	7		
			8E-4544	9	LH		9W-3931	2	E	5		
							9W-2426	1	C	9		
	EWL	60	8E-4545	9	RH	60	6Y-0022	2	I	7		
			8E-4546	9	LH		486-0516	2	E	5		
							9W-4495	2	C	9		
	EEWL	75	275-5445	9	RH	75	602-7457	2	I	7		
			275-5446	9	LH		602-7456	2	E	5		
							135-9578	2	C	9		
Specialty												
	EWL A.R.M.	60	195-7171	9	RH	60	591-3840	2	E	5		
			195-7172	9	LH		509-4393	1	LI	7		
			387-8251	9	RH		605-9074	1	RI	7		
			387-8252	9	LH		195-9175	2	C	9		
Hardware, Repair Parts and Wear Protection												
Type	Description		Part Number	Quantity	Notes							
Hardware	Bolts		1-1/4 - 7 x 4	5P-8823	60	Ensure Base Edge is flat and not excessively worn Clean and remove any paint on mating surfaces Torque, Bang, Torque						
	Nuts		1-1/4 - 7	3K-9770	60							
	Washers		1-1/4	4K-0684	60							
Blade Repair	Edge Support			570-5752	1	D11T: 583-6249, 583-6247						
				570-5753	2							
				590-2635	1	D11: 576-4925, 579-3271						
	590-2636	2										
	Protector			125-0800	2	ref PELM0918 D10 and D11 Bulldozer Sidebar Protector ref PELJ1389 Shear Blocks for Sidebar Protectors						
	Shear Block			330-4455	2							
	Adapter Plate			135-9794	2							
	Retainer			4T-4707	4							
	Pin			8E-4708	4							
Side Cutter	Weld-On Half Arrow			135-9793	2	ref PELM0918 D10 and D11 Bulldozer Sidebar Protector						
Wear Protection	Wear Bars		25x203x3352	107-3388*	4	Provides 2 wear bar coverage full width of blade.						
	Wear Plates		11mm	543-9053	1	Chromium Carbide Liner: 579-3271, 583-6247						
				579-3278	1							
				579-3279	1							
				579-3280	1							
				579-3281	1							
Wear Plates		12mm	519-8141	1	Steel Liner: 576-4925, 583-6249							
			519-8142	1								
			519-8143	1								
			519-8144	1								

D11 Carry Dozer

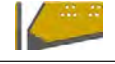
Blade Serial Numbers: 5JP, BHZ, MGP

Applies to: D11R CD, D11T CD, D11

End Bits and Cutting Edges 19"										
Type	End Bits					Edges				Notes
	Thickness	Part Number	Hardware	Position	Thickness	Edges	Quantity	Hardware		
	Short	60	273-7228 273-7229	9 9	RH LH	45	238-3171	5	8	GP: (521-8480)
		75	273-7232 273-7233	9 9	RH LH	60	238-3177	5	8	GP: (273-0141)
	Standard	60	273-7225 273-7226	9 9	RH LH	45	238-3171	5	8	Equipped from factory GP: (273-0140)
	EWL	75	273-7230 273-7231	9 9	RH LH	60	238-3177	5	8	GP: (521-8481)
	Penetration	60	273-7223 273-7224	9 9	RH LH	45	238-3171	5	8	GP: (521-8482)
										
Specialty										
	Sharpened	60	195-5117 195-5116	9 9	RH LH	60	238-3177	5	8	Sharpened leading edge End Bits only GP: (521-8483)
	Standard EWL + A.R.M.	75	273-7234 273-7235	9 9	RH LH	60	268-8751	5	8	GP: (521-8484)
	Penetration A.R.M.	60	223-8127 223-8128	9 9	RH LH	60	268-8751	5	8	GP: (273-0142)
	Non-Reversible	60	273-7225 273-7226	9 9	RH LH	45	229-7052	5	8	GP: (273-0130)
	Non-Reversible EWL	75	273-7230 273-7231	9 9	RH LH	60	267-8654	5	8	GP: (273-0131)
	Non-Reversible EWL A.R.M.	75	273-7234 273-7235	9 9	RH LH	60	268-8750	5	8	GP: (273-0132)
Hardware, Repair Parts and Wear Protection										
Type	Description		Part Number	Quantity	Notes					
Hardware	Bolts	1-1/4 - 7 x 5	5P-8361	58	Ensure Base Edge is flat and not excessively worn Clean and remove any paint on mating surfaces Torque, Bang, Torque					
	Nuts	1-1/4 - 7	3K-9770	58						
	Washers	1-1/4	4K-0684	58						
Blade Repair	Edge Support		135-2107	1						
Sidebar Protector	Protector		125-0800	2	ref PELM0918 D10 and D11 Bulldozer Sidebar Protector ref PELJ1389 Shear Blocks for Sidebar Protectors					
	Shear Block		330-4455	2						
	Adapter Plate		135-9794	2						
	Retainer		4T-4707	4						
	Pin		8E-4708	4						
Side Cutter	Weld-On Half Arrow		135-9793	2	ref PELM0918 D10 and D11 Bulldozer Sidebar Protector					
Wear Protection	Wear Bars									
	Wear Plates									

Cat Dozers

TRACK TYPE TRACTOR CUTTING EDGES

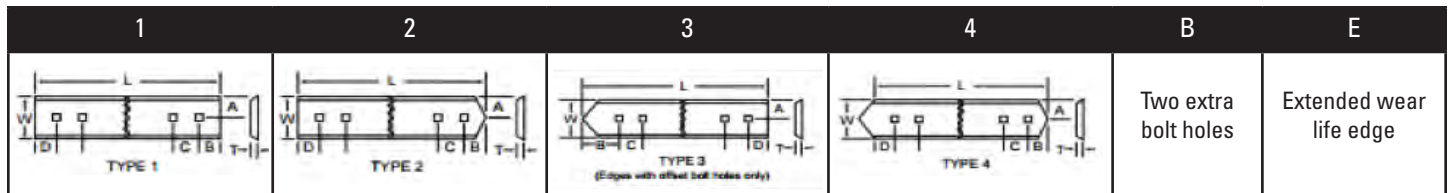

Part Number	Type	Width	Thickness	Length	Dim A	Dim B	Dim C	Dim D	Hole Size	Bolt Diameter	# Holes	Wt. kgs
176-2871*	1	152.4	12.7	1237.0	76.1	85	152.4	85	18	5/8"	8	16.3
5F-3102	1	152.4	16	1415.8	76.2	47.5	101.6	47.5	18	5/8"	14	21.8
255-1429	1	165	16	1029.5	82.5	134	152.4	134	18	5/8"	6	18.0
255-1474	1	165	16	1248.5	82.5	90.7	152.4	91	18	5/8"	8	18.0
4T-6230	1	165	16	869.0	83.0	54	152.4	54	18	5/8"	6	16.5
6Y-5841	1	165	16	912.0	83.0	75	152.4	75	18	5/8"	6	16.5
140-2187	1	165	16	1008.0	83.0	123	152.4	123	18	5/8"	6	18.3
4T-6231	1	165	16	1062.0	83.0	74	152.4	74	18	5/8"	7	20.0
157-7338	1	165	16	1099.2	82.5	92.4	152.4	92.4	18	5/8"	7	19.9
4T-6232	1	165	16	1213.0	83.0	73	152.4	73	18	5/8"	8	23.0
141-0413	1	165	16	1236.0	83.0	84	152.4	84	18	5/8"	8	22.3
6Y-5842	1	165	16	1263.0	83.0	100	152.4	100	18	5/8"	8	22.9
142-4914	1	165	16	1290.0	82.5	112	152.4	112	18	5/8"	8	23.3
141-2238	1	165	16	1309.0	83.0	121	152.4	121	18	5/8"	8	23.8
143-3088	1	165	16	1630.0	82.5	53	152.4	53	18	5/8"	11	29.4
143-3089	1	165	16	1730.0	82.5	103	152.4	103	18	5/8"	11	31.3
104-9634	1	165	16	975.6	83.0	107	152.4	107	18	5/8"	6	17.8
294-4519	6A	201.6	16	831.5	100.8	152.3	152.4	69.6	21	3/4"	5	18.1
255-1505	1	203	16	980.5	100.8	109	152.4	109	21	3/4"	6	18.0
7T-9978	1	203	25	658.2	102.0	101	152.4	101	21	3/4"	4	26.7
7T-9977	1	203	25	1018.9	102.0	52	152.4	52	21	3/4"	7	41.3
7T-9976	1	203	25	1052.5	102.0	69	152.4	69	22	3/4"	7	42.6
3Y-0036	1	203	19	902.0	102.0	70	152.4	70	22	3/4"	6	25.6
3Y-0035	1	203	19	1070.0	102.0	78	152.4	78	22	3/4"	7	31.0
5A-8644	1	203	19	1405.0	102.0	36	101.6	36	18	5/8"	14	39.0
4T-2983	1	203	16	382.8	102.0	39	152.4	39	18	5/8"	3	8.8
364-3546	1	203.2	16	476.3	101.6	76.2	152.4	95.3	18	5/8"	3	11.4
4T-2972	1	203	16	674.1	102.0	109	152.4	109	18	5/8"	4	15.4
4T-2974	1	203	16	807.6	102.0	99	152.4	99	18	5/8"	5	18.6
259-6003	6A	203.2	16	810.8	100.8	131.4	152.4	69.8	21	3/4"	5	17.5
259-6004	6B	203.2	16	829.0	101.6	99	152.4	125	21	3/4"	6	17.0
297-1705	6A	203.2	16	832.8	102.4	129.6	1524.0	64	21	3/4"	5	17.8
4T-3720	1	203	16	857.9	102.0	48	152.4	48	21	3/4"	6	21.5
4T-2973	1	203	16	859.0	102.0	49	152.4	49	18	5/8"	6	19.8
3G-9306	1	203	16	884.0	102.0	61	152.4	61	22	3/4"	6	20.4
5Q-8193	1	203.2	16	891.0	100.8	65	152.4	65	21	3/4"	6	20.9

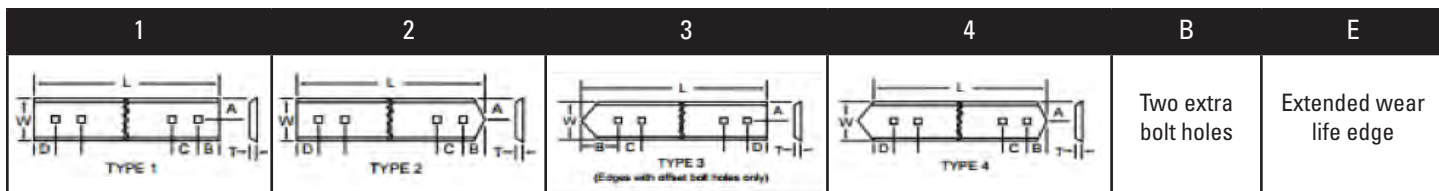

Part Number	Type	Width	Thickness	Length	Dim A	Dim B	Dim C	Dim D	Hole Size	Bolt Diameter	# Holes	Wt. kgs
140-0983	1	203	16	914.0	102.0	76	152.4	76	21	3/4"	6	20.9
331-0162	1	203	16	930.0	100.8	84	152.4	84	21	3/4"	6	21.5
4T-2982	1	203	16	992.5	102.0	39	152.4	39	19	5/8"	7	22.7
371-0786	6A	203.2	16	994.6	100.8	90.3	152.4	69	21	3/4"	6	21.7
8E-9377	1	203	16	1054.0	102.0	70	152.4	70	21	3/4"	7	24.7
100-4578	1	203	16	1079.4	102.0	83	152.4	83	21	3/4"	7	20.4
4T-8940	1	203	16	1194.9	102.0	64	152.4	64	22	3/4"	8	27.5
8E-7245	1	203	16	1357.2	102.0	69	152.4	69	21	3/4"	9	31.9
4T-2980	1	203	16	1521.4	102.0	50	101.6	50	18	5/8"	15	35.1
4T-2977	1	203	16	1824.2	102.0	49	101.6	49	18	5/8"	18	42.1
4T-2979	1	203	16	2027.7	102.0	100	152.4	100	18	5/8"	13	46.8
4T-2975	1	203	16	2230.6	102.0	49	152.4	49	18	5/8"	15	51.5
4T-2976	1	203	16	2230.6	102.0	49	101.6	49	18	5/8"	22	51.5
4T-2981	1	203	16	2334.1	102.0	50	101.6	50	18	5/8"	23	53.8
4T-2978	1	203	16	2433.8	102.0	49	101.6	49	18	5/8"	24	56.1
4T-3027	1	203	19	382.8	102.0	39	152.4	39	18	5/8"	3	10.4
4T-3026	1	203	19	554.2	102.0	49	152.4	49	18	5/8"	4	15.5
301-1073	1	203.2	19	593.2	100.8	60.5	152.4	75.5	21	3/4"	4	16.4
275-6043	0	203	19	603.6	0.0	73.2	152.4	73.2	21	3/4"	4	13.4
425-9011	1	203.2	19	610.0	101.6	76	152.4	76	18	5/8"	4	16.9
9U-8057	1	203	19	627.2	102.0	85	152.4	85	22	3/4"	4	20.4
4T-3010	1	203	19	658.2	102.0	101	152.4	101	21	3/4"	4	18.4
4T-3028	1	203	19	674.1	102.0	109	152.4	109	18	5/8"	4	18.8
278-2168	6A	203.2	19	691.3	101.6	153.3	152.4	80.8	21	3/4"	4	17.2
257-8153	6A	203.2	19	694.3	101.6	143.3	152.4	93.8	21	3/4"	4	17.2
268-9847	0	203	19	769.6	0.0	0	152.4	0	21	3/4"	5	21.3
4T-3006	1	203	19	807.6	102.0	99	152.4	99	18	5/8"	5	22.5
4T-0731	1	203	19	817.6	102.0	104	152.4	104	21	3/4"	5	22.8
4T-3020	1	203	19	858.7	102.0	23	101.6	23	18	5/8"	9	24.0
4T-3005	1	203	19	859.0	102.0	49	152.4	49	18	5/8"	6	24.0
257-0264	6A	203.2	19	864.2	101.6	119	152.4	135.6	21	3/4"	5	22.5
257-0265	6B	203.2	19	877.0	100.7	159.2	IRR	159.2	21	3/4"	6	21.8
5Q-6357*	1	203.2	19	878.0	100.8	52	152.4	52	21	3/4"	6	30.6
371-0758	6A	203.2	19	892.5	100.8	183.4	152.4	99.5	21	3/4"	5	23.3
278-2170	1	203.2	19	921.6	1101.6	79.8	152.4	79.8	21	3/4"	6	25.0
1U-2207	1	203	19	960.9	102.0	100	152.4	100	22	3/4"	6	28.0

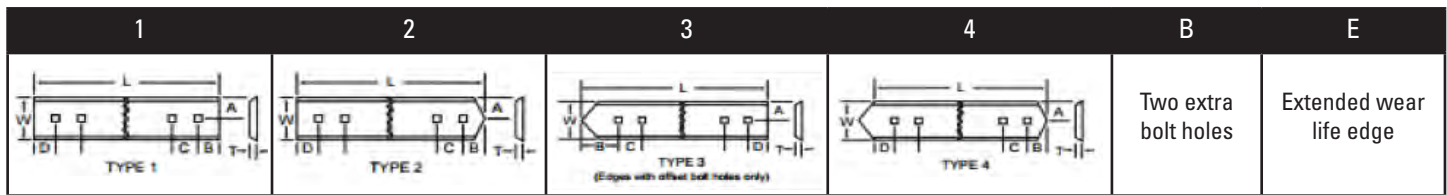

Part Number	Type	Width	Thickness	Length	Dim A	Dim B	Dim C	Dim D	Hole Size	Bolt Diameter	# Holes	Wt. kgs
257-8151	6A	203.2	19	971.0	101.6	115.8	152.4	93.8	21	3/4"	6	24.9
133-1372	0	203	19	990.0	0.0	0	152.4	0	21	3/4"	7	26.9
4T-3029	1	203	19	992.4	102.0	39	152.4	39	18	5/8"	7	27.7
305-9452	2	203.2	19	1009.4	101.6	47.5	152.4	47.5	21	3/4"	7	28.2
4T-3013	1	203	19	1009.5	102.0	48	152.4	48	22	3/4"	7	28.2
4T-6262	1	203	19	1019.0	102.0	52	152.4	52	22	3/4"	7	28.2
278-2169	6C	203.2	19	1021.6	101.6	129.6	152.4	129.6	21	3/4"	6	25.1
3G-6062	1	203	19	1043.4	102.0	65	152.4	65	22	3/4"	7	29.0
4T-6659	1	203	19	1052.4	102.0	69	152.4	69	21	3/4"	7	30.6
5Q-5438	2	203	19	1093.0	102.0	84	134.9	64	22	3/4"	8	32.0
4T-3025	1	203	19	1113.4	102.0	100	152.4	100	19	5/8"	7	31.1
342-8851	1	203.2	19	1113.4	100.8	99.5	152.4	99.5	21	3/4"	7	31.0
3G-4282	1	203	19	1152.4	102.0	119	152.4	119	21	3/4"	7	32.1
4T-3008	1	203	19	1164.0	102.0	74	101.6	74	18	5/8"	11	32.5
4T-3030	1	203	19	1214.6	102.0	49	101.6	49	18	5/8"	12	33.9
425-9012	1	203.2	19	1216.0	101.6	78	152.4	78	18	5/8"	8	33.8
102-4580	1	203	19	1318.8	102.0	126	152.4	126	21	3/4"	8	37.3
1U-2211	1	203	19	1395.3	102.0	88	152.4	88	22	3/4"	9	41.0
169-4089	1	203.2	19	1421.6	100.8	101.2	152.4	101.2	21	3/4"	9	41.0
4T-3004	1	203	19	1441.3	102.0	111	152.4	111	22	3/4"	9	40.3
127-3050	0	203.2	19	1446.6	100.8	37.5	152.4	37.5	21	3/4"	10	39.0
177-4550	1	203.2	19	1495.0	101.6	81	166.6	81	21	3/4"	9	40.6
4T-3012	1	203	19	1495.7	102.0	62	152.4	62	22	3/4"	10	41.8
4T-3009	1	203	19	1519.7	102.0	74	152.4	74	22	3/4"	10	42.5
4T-2315	1	203	19	1557.6	102.0	93	152.4	93	22	3/4"	10	43.6
4T-3011	1	203	19	1619.1	102.0	48	152.4	48	22	3/4"	11	45.2
9W-8335	1	203	19	1722.9	102.0	100	152.4	100	21	3/4"	11	45.8
275-6039*	0	203	19	1822.8	0.0	73.2	152.4	73.2	21	3/4"	12	40.5
4T-3021	1	203	19	1824.2	102.0	49	101.6	49	18	5/8"	18	51.0
5R-8053*	1	203	19	2129.0	102.0	49	101.6	49	18	5/8"	21	59.6
4T-3023	1	203	19	2230.6	102.0	49	101.6	49	18	5/8"	22	62.4
4T-3014	1	203	19	2230.7	102.0	49	152.4	49	19	5/8"	15	62.4
4T-3017	1	203	19	2334.7	102.0	101	152.4	101	22	3/4"	15	65.3
310-1656*	0	203	19	2432.3	0.0	0	152.4	0	25	7/8"	16	53.5
275-6030	0	203	19	2432.4	0.0	73.2	152.4	73.2	21	3/4"	16	54.1
4T-3024	1	203	19	2815.0	102.0	36	101.6	36	18	5/8"	28	78.7

Cat Dozers

TRACK TYPE TRACTOR CUTTING EDGES

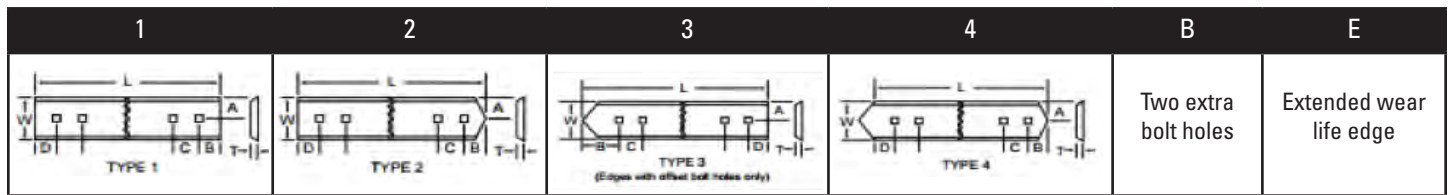

Part Number	Type	Width	Thickness	Length	Dim A	Dim B	Dim C	Dim D	Hole Size	Bolt Diameter	# Holes	Wt. kgs
253-0203*	1	203	25	914.0	100.8	76	152.4	76	21	3/4"	6	34.4
368-1459*	1	203.2	25	1152.4	100.8	119	152.4	119	21	3/4"	7	43.4
327-7911	1	203	25	1557.5	100.7	93	152.4	93	21	3/4"	10	58.6
357-6661*	1	203.2	25.4	1266.8	100.7	100	152.4	100	18	5/8"	8	47.8
4T-7109	1	254	19	567.2	127.0	55	152.4	55	25	7/8"	4	21.3
4T-2945	1	254	19	706.7	127.0	49	152.4	49	22	3/4"	5	25.0
4T-2922	1	254	19	757.7	127.0	74	152.4	74	25	7/8"	5	25.7
4T-2952	1	254	19	801.7	127.0	96	152.4	96	22	3/4"	5	26.0
4T-2916	1	254	19	816.6	127.0	104	152.4	104	25	7/8"	5	28.6
109-9093	1	254	19	890.4	127.0	64	152.4	64	22	3/4"	6	30.7
4T-5318	1	254	19	894.1	127.0	66	152.4	66	25	7/8"	6	31.2
1U-1192	2	254	19	913.1	127.0	71	152.4	80	25	7/8"	6	29.3
4T-7110	2	254	19	988.0	127.0	87	152.4	139	25	7/8"	6	35.8
4T-2923	1	254	19	1029.5	127.0	58	152.4	58	25	7/8"	7	12.8
269-0367	2	254	19	1034.4	127.0	120	152.4	74	21	3/4"	7	35.1
4T-2921	1	254	19	1062.5	127.0	74	152.4	74	25	7/8"	7	35.8
4T-2948	1	254	19	1062.5	127.0	74	152.4	74	22	3/4"	7	35.7
4T-3901	1	254	19	1094.4	127.0	90	152.4	90	25	7/8"	7	37.7
128-5883	1	254	19	1107.6	127.0	97	152.4	97	25	7/8"	7	37.9
4T-2946	1	254	19	1112.5	127.0	99	152.4	99	22	3/4"	7	37.0
50Q-5405	2	254	19	1133.3	126.2	94	139.0	67	22	3/4"	8	38.5
268-1116	2	254	19	1208.0	127.0	141	152.4	74	25	7/8"	8	41.1
9W-1878	2	254	19	1227.4	127.0	87	152.4	74	22	3/4"	8	45.9
4T-2885*	1E	254	19	1318.9	203.0	105.5	IRR	105.5	21	3/4"	6	45.0
4T-2917	2	254	19	1357.3	127.0	69	152.4	69	25	7/8"	9	42.2
4T-2955*	4	254	19	1357.3	127.0	69	152.4	69	22	3/4"	9	43.5
106-0956	2	254	19	1379.8	127.0	87	152.4	74	22	3/4"	9	50.7
219-4599	1	254	19	1466.0	127.0	47	152.4	47	21	3/4"	10	50.5
4T-2949	1	254	19	1519.5	127.0	49	101.6	49	22	3/4"	15	46.5
4T-2950	1	254	19	1560.6	127.0	95	152.4	95	22	3/4"	10	52.0
229-6958	1	254	19	1605.8	127.9	41	152.4	41	21	3/4"	11	55.3
4T-2954	1	254	19	2332.3	127.0	49	101.6	49	22	3/4"	23	75.0
4T-2951	1	254	19	3043.7	127.0	74	152.4	74	25	7/8"	20	102.4
4T-2991	1	254	25	706.7	127.0	49	152.4	49	22	3/4"	5	34.8
253-0195	1	254	25	717.4	126.1	53.9	152.4	53.9	25	7/8"	5	32.8
265-5478	7R	254	25	730.4	126.1	173.2	152.4	100	28	1"	4	31.2

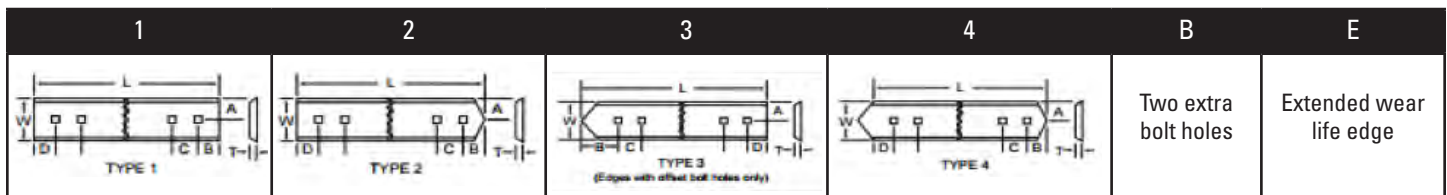

Part Number	Type	Width	Thickness	Length	Dim A	Dim B	Dim C	Dim D	Hole Size	Bolt Diameter	# Holes	Wt. kgs
265-5479	7L	254	25	730.4	126.1	173.2	152.4	100	28	1"	4	31.2
4T-2992	1	254	25	757.7	127.0	74	152.4	74	25	7/8"	5	37.3
332-5565	2	254	25	758.0	126.1	74	152.4	74	25	7/8"	5	34.0
332-5565	2	254	25	758.0	126.1	74	152.4	74	25	7/8"	5	34.0
4T-2986	2	254	25	779.1	127	96	152.4	74	28	1"	5	38.3
4T-2865	1	254	25	801.6	126.1	96	152.4	96	25	7/8"	5	39.4
4T-3417	2	254	25	809.6	127.0	100	152.4	100	28	1"	5	39.8
4T-3420	1	254	25	817.0	127.0	104	152.4	104	25	7/8"	5	40.2
4T-3423	1	254	25	856.1	127.0	47	152.4	47	28	1"	6	42.1
122-9227	1	254	25	894.0	127.0	66	152.4	66	25	7/8"	6	40.9
235-0327	2	254	25	900.0	126.1	64	152.4	74	25	7/8"	6	40.8
4T-2861	1	254	25	904.8	127.0	46	101.6	46	22	3/4"	9	44.5
4T-6532	1	254	25	910.1	127.0	74	152.4	74	25	7/8"	6	44.8
265-5477	5	254	25	923.0	126.1	80.5	152.4	80.5	28	1"	6	41.6
4T-2987	1	254	25	923.1	127.0	81	152.4	81	28	1"	6	45.4
4T-6512	1	254	25	923.1	127.0	81	152.4	81	25	7/8"	6	45.6
270-8083	2	254	25	960.8	126.1	99.4	152.4	99.4	28	1"	6	43.5
253-0196	5	254	25	970.5	126.1	81	152.4	128	25	7/8"	6	44.2
4T-8797	2	254	25	988.0	127.0	87	152.4	139	25	7/8"	6	46.0
4T-2988	1	254	25	1034.4	127.0	60	152.4	60	28	1"	7	50.9
4T-2989	1	254	25	1062.5	127.0	74	152.4	74	22	3/4"	7	52.3
4T-2993	1	254	25	1062.5	127.0	74	152.4	74	25	7/8"	7	52.3
4T-8798	1	254	25	1076.5	127.0	81	152.4	81	25	7/8"	7	50.5
4T-3422	1	254	25	1094.4	127.0	90	152.4	90	28	1"	7	53.9
4T-2990	1	254	25	1112.5	127.0	99	152.4	99	22	3/4"	7	54.7
4T-6238	1	254	25	1199.8	127.0	67	152.4	67	28	1"	8	59.1
4T-3419	1	254	25	1214.7	127.0	49	101.6	49	22	3/4"	12	59.8
4T-2994	1	254	25	1214.9	127.0	74	152.4	74	28	1"	8	59.8
6Y-3840	2	254	25	1227.4	127.0	87	152.4	74	22	3/4"	8	59.0
4T-2860	1	254	25	1316.3	127.0	49	101.6	49	22	3/4"	13	64.8
4T-6649*	1	254	25	1319.0	62.0	152	IRR	152	22	3/4"	4	64.9
4T-3421	2	254	25	1357.3	127.0	69	152.4	69	25	7/8"	9	66.8
4T-2890*	2	254	25	1359.2	127.0	70	152.4	70	22	3/4"	9	66.9
332-5567	7R	254	25	1366.3	126.1	180	152.4	61.3	25	7/8"	9	64.2
229-6599	2	254	25	1379.7	126.2	87	152.4	74	21	3/4"	9	63.7
4T-2889	1	254	25	1408.2	127.0	95	152.4	95	25	7/8"	9	69.3
4T-2862	1	254	25	1417.9	127.0	49	101.6	49	22	3/4"	14	69.8
332-5566	7L	254	25	1460.3	126.1	126.1	152.4	61.3	25	7/8"	9	64.2

Cat Dozers

TRACK TYPE TRACTOR CUTTING EDGES

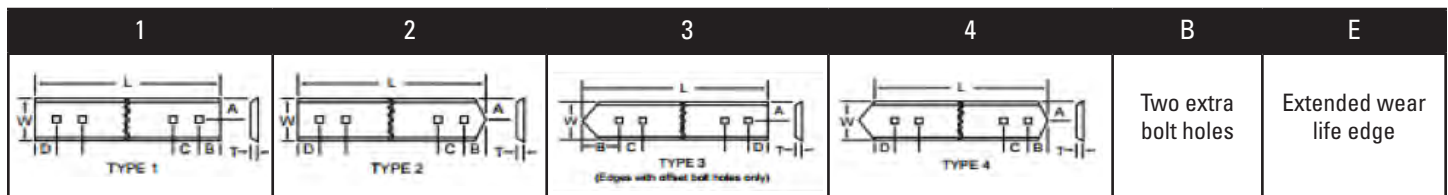

Part Number	Type	Width	Thickness	Length	Dim A	Dim B	Dim C	Dim D	Hole Size	Bolt Diameter	# Holes	Wt. kgs
4T-2863	1	254	25	1519.5	127.0	49	101.6	49	22	3/4"	15	74.8
4T-6513	4	254	25	1519.7	127.0	74	152.4	74	25	7/8"	10	74.8
4T-6531	1	254	25	1519.7	127.0	74	152.4	74	25	7/8"	10	74.8
4T-3418	1	254	25	1532.7	127.0	81	152.4	81	25	7/8"	10	75.4
4T-6514	1	254	25	1557.6	127.0	93	152.4	93	25	7/8"	10	76.7
4T-2888	1	254	25	1621.1	127.0	49	101.6	49	22	3/4"	16	79.8
4T-6515	1	254	25	1773.5	127.0	49	152.4	49	25	7/8"	12	22.5
4T-2864	1	254	25	2332.3	127.0	49	101.6	49	22	3/4"	23	114.8
4T-6509	1	254	25	2534.4	127.0	48	152.4	48	25	7/8"	17	124.8
4T-2866	1	254	25	2789.8	126.1	99.5	152.4	99.5	25	7/8"	18	137.4
257-1851	1	254	35	757.6	126.1	74	152.4	74	25	7/8"	5	49.2
1U-4930	1	254	35	856.0	127.0	47	152.4	47	28	1"	6	55.2
1U-4932	1	254	35	923.1	127.0	81	152.4	81	28	1"	6	59.7
257-1852	1	254	35	1029.4	126.1	57.5	152.4	58	25	7/8"	7	66.7
1U-4933	1	254	35	1034.3	127.0	60	152.4	60	28	1"	7	66.8
1U-4931	1	254	35	1094.3	127.0	90	152.4	90	28	1"	7	70.8
345-6752	1	254	45	127.0	127.0	96.8	203.2	96.8	28	1"	3	50.8
367-2811*	7L	254	45	683.4	126.1	152.3	152.4	74	25	7/8"	4	53.9
367-2812	7R	254	45	683.4	126.1	152.3	152.4	74	25	7/8"	4	53.9
286-2090	1	254	45	757.6	126.1	74	152.4	74	25	7/8"	5	63.6
107-3473	2	254	45	779.5	127.0	97	152.4	74	28	1"	5	63.2
367-2813	2	254	45	786.6	126.1	103.5	152.4	73.5	25	7/8"	5	64.6
107-3480	2	254	45	809.5	127.0	100	152.4	100	28	1"	5	66.3
107-3482	1	254	45	856.0	127.0	47	152.4	47	28	1"	6	72.5
107-3474*	1	254	45	910.0	127.0	74	152.4	74	25	7/8"	6	77.2
107-3475*	1	254	45	921.9	127.0	80	152.4	80	25	7/8"	6	78.2
107-3481	1	254	45	922.0	127.0	80	152.4	80	28	1"	6	77.2
107-3479	1	254	45	1034.3	127.0	60	152.4	60	28	1"	7	87.7
107-3483	1	254	45	1094.3	127.0	90	152.4	90	28	1"	7	92.9
107-3484	1	254	45	1214.8	127.0	74	152.4	74	28	1"	8	103.1
107-3477	1	254	45	1519.6	127.0	74	152.4	74	25	7/8"	10	129.0
107-3478*	4	254	45	1519.7	127.0	74	152.4	74	25	7/8"	10	125.1
107-3476	1	254	45	1531.5	127.0	80	152.4	80	25	7/8"	10	130.0
7T-6592	1	280	25	567.1	139.1	55	152.4	55	25	7/8"	4	31.7
9W-9795	1	280	25	757.5	139.1	74	152.4	74	25	7/8"	5	36.3
9W-9792*	1	280	25	816.5	139.1	104	152.4	104	25	7/8"	5	39.1
7T-6678	1	280	25	894.0	139.1	66	152.4	66	25	7/8"	6	41.9
7T-6936	2	280	25	907.9	139.1	66	152.4	80	25	7/8"	6	49.8

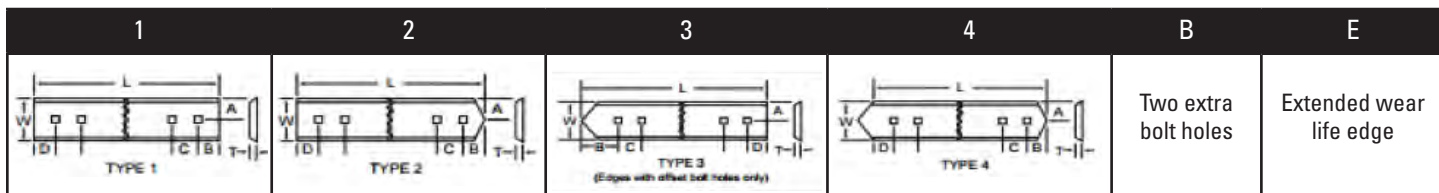

Part Number	Type	Width	Thickness	Length	Dim A	Dim B	Dim C	Dim D	Hole Size	Bolt Diameter	# Holes	Wt. kgs
4T-2890*	2	254	25	1359.2	127.0	70	152.4	70	22	3/4"	9	66.9
332-5567	7R	254	25	1366.3	126.1	180	152.4	61.3	25	7/8"	9	64.2
229-6599	2	254	25	1379.7	126.2	87	152.4	74	21	3/4"	9	63.7
4T-2889	1	254	25	1408.2	127.0	95	152.4	95	25	7/8"	9	69.3
4T-2862	1	254	25	1417.9	127.0	49	101.6	49	22	3/4"	14	69.8
332-5566	7L	254	25	1460.3	126.1	126.1	152.4	61.3	25	7/8"	9	64.2
4T-2863	1	254	25	1519.5	127.0	49	101.6	49	22	3/4"	15	74.8
4T-6513	4	254	25	1519.7	127.0	74	152.4	74	25	7/8"	10	74.8
4T-6531	1	254	25	1519.7	127.0	74	152.4	74	25	7/8"	10	74.8
4T-3418	1	254	25	1532.7	127.0	81	152.4	81	25	7/8"	10	75.4
4T-6514	1	254	25	1557.6	127.0	93	152.4	93	25	7/8"	10	76.7
4T-2888	1	254	25	1621.1	127.0	49	101.6	49	22	3/4"	16	79.8
4T-6515	1	254	25	1773.5	127.0	49	152.4	49	25	7/8"	12	22.5
4T-2864	1	254	25	2332.3	127.0	49	101.6	49	22	3/4"	23	114.8
4T-6509	1	254	25	2534.4	127.0	48	152.4	48	25	7/8"	17	124.8
4T-2866	1	254	25	2789.8	126.1	99.5	152.4	99.5	25	7/8"	18	137.4
257-1851	1	254	35	757.6	126.1	74	152.4	74	25	7/8"	5	49.2
1U-4930	1	254	35	856.0	127.0	47	152.4	47	28	1"	6	55.2
1U-4932	1	254	35	923.1	127.0	81	152.4	81	28	1"	6	59.7
257-1852	1	254	35	1029.4	126.1	57.5	152.4	58	25	7/8"	7	66.7
1U-4933	1	254	35	1034.3	127.0	60	152.4	60	28	1"	7	66.8
1U-4931	1	254	35	1094.3	127.0	90	152.4	90	28	1"	7	70.8
345-6752	1	254	45	127.0	127.0	96.8	203.2	96.8	28	1"	3	50.8
367-2811*	7L	254	45	683.4	126.1	152.3	152.4	74	25	7/8"	4	53.9
367-2812	7R	254	45	683.4	126.1	152.3	152.4	74	25	7/8"	4	53.9
286-2090	1	254	45	757.6	126.1	74	152.4	74	25	7/8"	5	63.6
107-3473	2	254	45	779.5	127.0	97	152.4	74	28	1"	5	63.2
367-2813	2	254	45	786.6	126.1	103.5	152.4	73.5	25	7/8"	5	64.6
107-3480	2	254	45	809.5	127.0	100	152.4	100	28	1"	5	66.3
107-3482	1	254	45	856.0	127.0	47	152.4	47	28	1"	6	72.5
107-3474*	1	254	45	910.0	127.0	74	152.4	74	25	7/8"	6	77.2
107-3475*	1	254	45	921.9	127.0	80	152.4	80	25	7/8"	6	78.2
107-3481	1	254	45	922.0	127.0	80	152.4	80	28	1"	6	77.2
107-3479	1	254	45	1034.3	127.0	60	152.4	60	28	1"	7	87.7
107-3483	1	254	45	1094.3	127.0	90	152.4	90	28	1"	7	92.9
107-3484	1	254	45	1214.8	127.0	74	152.4	74	28	1"	8	103.1
107-3477	1	254	45	1519.6	127.0	74	152.4	74	25	7/8"	10	129.0
107-3478*	4	254	45	1519.7	127.0	74	152.4	74	25	7/8"	10	125.1

Cat Dozers

TRACK TYPE TRACTOR CUTTING EDGES

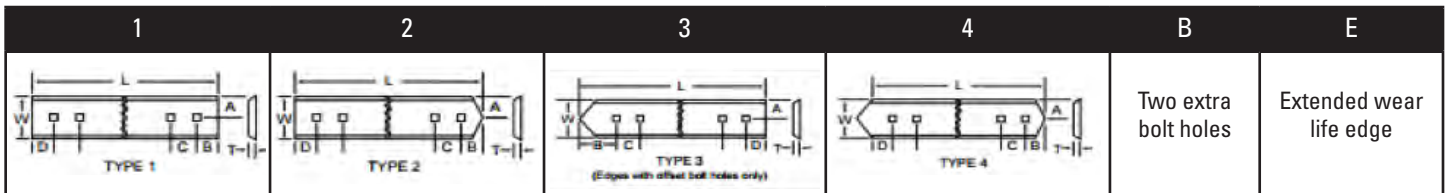

Part Number	Type	Width	Thickness	Length	Dim A	Dim B	Dim C	Dim D	Hole Size	Bolt Diameter	# Holes	Wt. kgs
107-3476	1	254	45	1531.5	127.0	80	152.4	80	25	7/8"	10	130.0
7T-6592	1	280	25	567.1	139.1	55	152.4	55	25	7/8"	4	31.7
9W-9795	1	280	25	757.5	139.1	74	152.4	74	25	7/8"	5	36.3
9W-9792*	1	280	25	816.5	139.1	104	152.4	104	25	7/8"	5	39.1
7T-6678	1	280	25	894.0	139.1	66	152.4	66	25	7/8"	6	41.9
7T-6936	2	280	25	907.9	139.1	66	152.4	80	25	7/8"	6	49.8
7T-6591	2	280	25	983.0	139.1	82	152.4	139	25	7/8"	6	53.9
9W-9794	1	280	25	1062.3	139.1	74	152.4	74	25	7/8"	7	50.9
9W-9796	1	280	25	1062.4	139.1	74	152.4	74	21	3/4"	7	50.9
7T-6589	1	280	25	1094.3	139.1	90	152.4	90	25	7/8"	7	61.1
135-6537	1	280	25	1107.6	139.1	97	152.4	97	25	7/8"	7	51.8
265-6934	1	280	25	1125.0	139.1	105.3	152.4	105.3	25	7/8"	7	53.2
135-9626	1	280	35	567.1	139.1	55	152.4	55	25	7/8"	4	38.4
9W-8656	2	280	35	779.0	139.1	96	152.4	74	28	1"	5	51.9
6Y-6358*	1	280	35	856.0	139.1	47	152.4	47	28	1"	6	57.9
107-3363	1	280	35	894.0	139.1	66	152.4	66	25	7/8"	6	60.7
107-3362	2	280	35	907.9	139.1	66	152.4	80	25	7/8"	6	60.5
6Y-6761*	1	280	35	910.0	139.1	74	152.4	74	25	7/8"	6	61.8
6Y-6762*	1	280	35	921.9	139.1	80	152.4	80	25	7/8"	6	62.6
9W-8655	1	280	35	923.0	139.1	81	152.4	81	28	1"	6	62.6
135-9627	2	280	35	983.0	139.1	82	152.4	139	25	7/8"	6	65.8
9W-8657	1	280	35	1034.3	139.1	60	152.4	60	28	1"	7	70.1
135-9778	1	280	35	1094.3	139.1	90	152.4	90	25	7/8"	7	74.4
145-7846	1	280	35	1107.6	139.1	97	152.4	97	25	7/8"	7	75.3
9W-8658	1	280	35	1214.8	139.1	74	152.4	74	28	1"	8	82.4
6Y-6764	1	280	35	1519.6	139.1	74	152.4	74	25	7/8"	10	103.3
6Y-6765*	1	280	35	1519.6	139.1	74	152.4	74	25	7/8"	10	101.4
6Y-6763	1	280	35	1531.5	139.1	80	152.4	80	25	7/8"	10	104.1
9W-9793*	1	280	25	1357.2	139.1	69	152.4	69	25	7/8"	9	63.6
415-7213	2	280	35	771.0	139.1	28.5	152.4	73.5	28	1"	5	51.3
6Y-6360	1	280	35	1094.4	139.1	90	152.4	90	28	1"	9	74.3
6Z-8197	1	280	25	1114.4	139.1	110	152.4	90	25	7/8"	7	51.0
4T-6457	1	305	28	907.0	153.0	73	152.4	73	28	1"	6	58.0
4T-6456*	1	305	28	950.9	153.0	95	152.4	95	28	1"	6	61.0
4T-6459	1	305	28	1325.1	153.0	53	152.4	53	28	1"	9	85.5
4T-6448	1	305	28	1519.6	153.0	74	152.4	74	28	1"	10	98.0
4T-6453	1	305	28	1973.8	153.0	73	152.4	73	28	1"	13	124.0
4T-6450	1	305	28	2208.6	153.0	38	152.4	38	28	1"	15	143.0

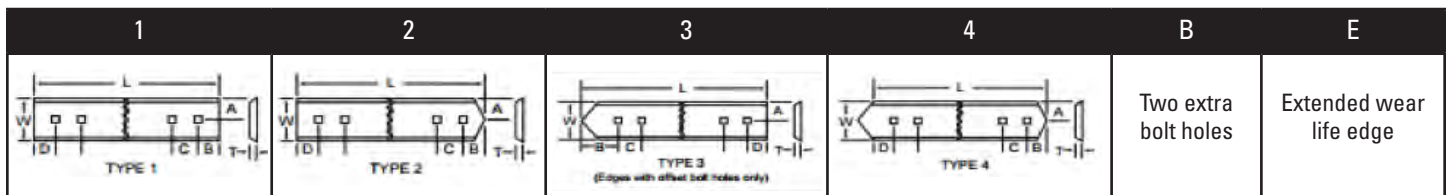

Part Number	Type	Width	Thickness	Length	Dim A	Dim B	Dim C	Dim D	Hole Size	Bolt Diameter	# Holes	Wt. kgs
151-2985	1	330	22	1700.0	100.0	93	IRR	93	28	1"	5	89.4
4T-6377	1	330	28	589.2	165.0	66	152.4	66	28	1"	4	41.0
4T-6379	2	330	28	589.2	165.0	66	152.4	66	28	1"	4	39.5
9W-5232	2	330	28	824.1	165.0	120	152.4	95	28	1"	5	59.2
135-9669	7L	330	28	893.5	164.1	215	152.4	69	28	1"	5	54.4
4T-6386	1	330	28	1039.4	165.0	63	152.4	63	28	1"	7	73.0
4T-6388	1	330	28	1062.4	165.0	74	152.4	74	28	1"	7	75.0
4T-6385	2	330	28	1222.7	165.0	71	152.4	85	28	1"	8	83.5
9W-5432	1	330	28	1240.0	165.0	87	152.4	87	28	1"	8	91.6
4T-6381	1	330	28	1353.2	165.0	67	152.4	67	28	1"	9	96.2
4T-6387	1	330	28	1367.2	165.0	74	152.4	74	28	1"	9	97.0
4T-9586	1	330	28	1693.9	165.0	85	152.4	85	28	1"	11	119.1
6Y-5539	1	330	28	1787.4	165.0	56	152.4	56	28	1"	12	122.7
4Z-9058	1	330	28	1953.1	165.0	62	152.4	62	28	1"	13	137.5
4T-9590	1	330	28	2164.1	165.0	92	152.4	92	28	1"	14	150.0
135-9670	7R	330	28.5	893.5	164.1	215	152.4	69	28	1"	5	54.4
135-9373	1	330	28.5	1268.0	164.1	101	152.4	101	28	1"	8	96.4
9W-9197	2	330	35	589.1	165.0	66	152.4	66	28	1"	4	48.4
9W-4398	2	330	35	800.1	165.0	117	152.4	74	28	1"	5	71.2
7T-9127	2	330	35	824.1	165.0	120	152.4	95	28	1"	5	68.2
9W-9098	1	330	35	1240.0	165.0	87	152.4	87	28	1"	8	105.4
135-9628	1	330	35	1268.0	164.1	101	152.4	101	28	1"	8	107.8
9W-4396	1	330	35	1693.9	165.0	85	152.4	85	28	1"	11	144.0
9W-4397	1	330	35	2164.1	165.0	92	152.4	92	28	1"	14	184.0
7T-5701	1	330	35	2264.1	165.0	65	152.4	65	28	1"	15	192.4
7J-2979	2	330	40	589.2	165.0	66	152.4	66	28	1"	4	55.5
7T-4345	2E	330	40	809.5	140.0	100	152.4	100	28	1"	5	76.5
7T-5235	1E	330	40	856.0	140.0	47	152.4	47	28	1"	6	83.2
135-9672	7R	330	40	866.9	164.1	188	152.4	69	28	1"	5	78.5
135-9673	7L	330	40	866.9	164.1	188	152.4	69	28	1"	5	54.4
7T-4353*	1E	330	40	1034.3	165.0	60	152.4	60	28	1"	7	100.6
7J-2980	1	330	40	1039.4	165.0	63	152.4	63	28	1"	7	101.1
7T-4347*	1E	330	40	1094.3	140.0	90	152.4	90	28	1"	7	106.6
135-9671	5	330	40	1201.0	164.1	67	152.4	67	28	1"	8	255.0
9W-4508	2	330	40	1222.7	165.0	71	152.4	85	28	1"	8	116.7
9W-4507	1	330	40	1353.2	165.0	67	152.4	67	28	1"	9	131.8
7J-2962*	1	330	40	1519.6	165.0	74	152.4	74	28	1"	10	148.0
7J-2963*	1	330	40	1973.8	165.0	73	152.4	73	28	1"	13	188.8

Cat Dozers

TRACK TYPE TRACTOR CUTTING EDGES

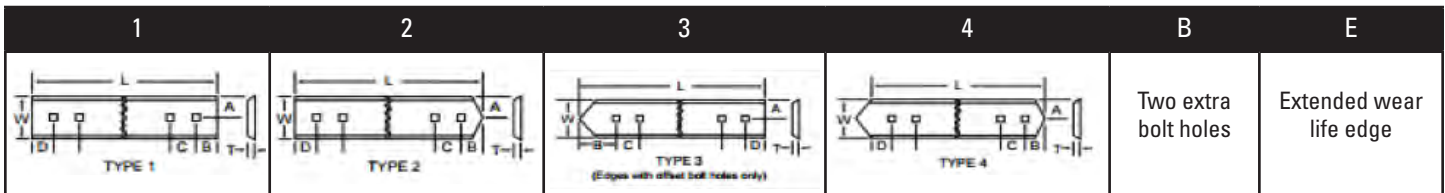

Part Number	Type	Width	Thickness	Length	Dim A	Dim B	Dim C	Dim D	Hole Size	Bolt Diameter	# Holes	Wt. kgs
112-2471	2	330	45	803.0	165.0	120	152.4	74	28	1"	5	85.9
112-2475	1	330	45	900.0	165.0	69	152.4	69	28	1"	6	98.8
112-2474	1	330	45	1240.0	165.0	87	152.4	87	28	1"	8	136.6
135-9629	1	330	45	1268.0	164.1	101	152.4	101	28	1"	8	139.5
151-7476	6C	330	45	1330.0	164.1	284	IRR	284	28	1"	7	139.1
112-2472	1	330	45	1353.2	165.0	67	152.4	67	28	1"	9	148.7
275-5949	1B	330	45	1716.6	140.0	66	IRR	103.5	25	7/8"	11	189.4
136-8313*	1E	330	45	1773.4	140.0	49	152.4	49	25	7/8"	12	195.4
9W-3926	1	330	45	2164.1	165.0	92	152.4	92	28	1"	14	238.3
9W-7044	1	330	45	2264.1	165.0	65	152.4	65	28	1"	15	249.0
364-6552	1	330	60	757.6	140.0	74	152.4	74	25	7/8"	5	112.0
113-0321	2	330	60	800.1	165.0	117	152.4	74	28	1"	5	113.3
366-2152	2	330	60	824.1	165.0	120	152.4	95	28	1"	5	11.9
123-3755	3E	330	60	973.9	140.0	73	152.4	139	25	7/8"	6	140.8
123-3756	2E	330	60	973.9	140.0	73	152.4	139	25	7/8"	6	140.8
135-8213*	2E	330	60	973.9	140.0	73	152.4	139	28	1"	6	138.2
195-7272	1	330	60	1039.4	164.1	62.5	152.4	62.5	28	1"	7	151.1
123-3754	1E	330	60	1076.4	140.0	81	152.4	81	25	7/8"	7	159.4
135-8210*	1E	330	60	1076.4	140.0	81	152.4	81	28	1"	7	159.0
109-9014*	1E	330	60	1557.5	140.0	93	152.4	93	25	7/8"	10	230.8
109-3146*	1E	330	60	1773.4	140.0	49	152.4	49	25	7/8"	12	262.2
113-0322	1	330	60	1787.3	165.0	56	152.4	56	28	1"	12	263.7
4T-6382	2B	330	28	633.4	164.3	50	IRR	50	28	1"	6	42.5
6Y-5540	2	330	28	803.0	165.0	120	152.4	74	28	1"	5	53.2
6Y-5538	1	330	28	2264.2	165.0	66	152.4	66	28	1"	15	156.8
419-5719*	1	330	28.5	1528.6	165.1	78.5	152.4	78.5	28	1"	10	105.1
9W-4503	2B	330	35	633.4	164.1	50	IRR	50	28	1"	8	51.2
9J-3751*	1B	330	35	1218.0	165.0	76	IRR	76	28	1"	10	102.8
9W-4502	2	330	35	1222.8	165.0	71	152.4	85	28	1"	8	101.8
9W-4506	2B	330	40	633.4	164.1	50	IRR	50	28	1"	8	58.7
7T-4346	3E	330	40	809.6	140.0	100	152.4	100	28	1"	0	76.5
7J-2964	1	330	40	907.1	165.0	73	152.4	73	28	1"	6	88.3
7T-4352	1E	330	40	922.0	140.0	80	152.4	80	28	1"	6	89.8
7J-2960	1	330	40	951.0	164.1	94.5	152.4	94.5	28	1"	6	92.7
7J-2966	1	330	40	1062.5	165.0	74	152.4	74	28	1"	7	103.4
7T-4351*	1E	330	40	1214.8	140.0	74	IRR	74	28	1"	8	118.3
7J-2965	1	330	40	1367.3	165.0	74	152.4	74	28	1"	9	133.2
375-4343	2	330	45	803.1	164.1	120	152.4	73.5	37	1-1/4"	5	85.1

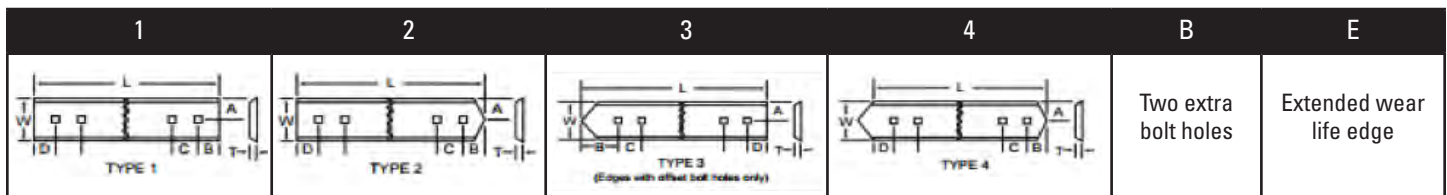

Part Number	Type	Width	Thickness	Length	Dim A	Dim B	Dim C	Dim D	Hole Size	Bolt Diameter	# Holes	Wt. kgs
112-2473	2	330	45	824.1	165.0	120	152.4	95	28	1"	5	88.2
375-4344	1	330	45	900.0	164.1	69	152.4	69	37	1-1/4"	6	97.8
375-4345	1	330	45	1039.4	164.1	62.5	152.4	62.5	37	1-1/4"	7	112.9
151-7477	6C	330	45	1330.0	164.1	284	IRR	284	28	1"	7	139.1
9W-3925	1	330	45	1694.0	165.0	85	152.4	85	28	1"	11	186.3
275-5950	1B	330	45	1716.6	190.0	66	IRR	103.5	25	7/8"	11	189.4
9W-7043	1	330	45	1787.5	165.0	56	152.4	56	28	1"	12	196.4
372-2789	7R	330	60	808.9	140.0	125.8	152.4	73.5	28	1"	5	113.0
372-2790	7L	330	60	808.9	190.0	125.8	152.4	73.5	28	1"	5	113.0
417-2880	2	330	60	814.1	164.1	110	152.4	94.5	28	1"	5	116.7
135-8212*	3E	330	60	974.0	140.0	73	152.4	139	28	1"	6	138.2
370-8741	7R	330	60	994.9	190.0	93.9	152.4	139	25	7/8"	6	143.1
370-8742	7L	330	60	994.9	140.0	93.9	152.4	139	25	7/8"	6	143.1
372-2788	1E	330	60	1034.4	140.0	60	152.4	60	28	1"	7	152.7
417-2881	1	330	60	1039.4	164.1	62.5	152.4	62.5	28	1"	7	153.3
135-9640*	0	330	120	4458.4	0.0	0	2539.7	0	25	7/8"	30	793.9
270-3779	5	330	40	900.0	164.1	69	152.4	69	28	1"	6	85.6
331-8977	6A	330.2	28	1024.6	164.3	188.6	152.4	74	28	1"	6	65.3
4Z-8039*	1	330	28	1214.8	165.0	74	152.4	74	28	1"	8	84.8
113-0338	2B	406	60	1640.9	0.0	0	IRR	0	37	1-1/4"	9	500.6
135-9579	2	406	75	853.0	202.1	132	152.4	111	37	1-1/4"	5	186.8
135-9580	1	406	75	992.0	202.1	115	152.4	115	37	1-1/4"	6	224.4
371-7105*	1B	406	28.5	2489.2	203.0	152.4	IRR	152.4	37	1-1/4"	16	207.6
6Y-0314	2E	406	35	633.3	180.0	50	IRR	50	28	1"	6	62.3
6Y-0315	3E	406	35	633.3	180.0	50	IRR	50	28	1"	6	62.3
9W-0775	1	406	35	756.5	203.0	74	152.4	74	37	1-1/4"	5	80.0
7T-9779	2	406	35	831.6	203.0	127	152.4	95	37	1-1/4"	5	83.2
9W-6615	1	406	35	847.9	203.0	119	152.4	119	37	1-1/4"	5	94.5
9W-6608	4	406	35	859.0	203.0	138	152.4	111	37	1-1/4"	5	96.0
7T-9781	4	406	35	876.6	203.0	127	152.4	140	37	1-1/4"	5	88.0
7T-9782	1	406	35	908.9	203.0	74	152.4	74	37	1-1/4"	6	93.6
275-2490	1	406	35	923.0	202.1	46	152.4	115	37	1-1/4"	6	95.4
9W-6609	1	406	35	991.9	203.0	115	152.4	115	37	1-1/4"	6	110.5
6Y-0310	1E	406	35	1039.4	180.0	63	152.4	63	28	1"	9	108.0
9W-3931	1	406	45	756.5	203.0	74	152.4	74	37	1-1/4"	5	101.0
6Y-0019	2B	406	45	782.6	203.0	93	IRR	80	37	1-1/4"	9	99.3
9W-3930	4	406	45	831.6	203.0	127	152.4	95	37	1-1/4"	5	107.9
9W-6658	1	406	45	847.9	203.0	119	152.4	119	37	1-1/4"	5	113.7

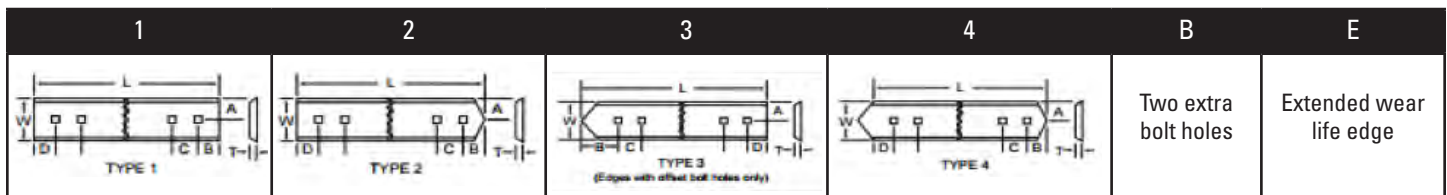

Part Number	Type	Width	Thickness	Length	Dim A	Dim B	Dim C	Dim D	Hole Size	Bolt Diameter	# Holes	Wt. kgs
369-8066	1	406	45	923.0	202.1	46	152.4	115	37	1-1/4"	6	123.6
364-6551	1	406	45	925.5	202.1	81.7	152.4	81.7	37	1-1/4"	6	123.9
9W-6656	1	406	45	991.9	203.0	115	152.4	115	37	1-1/4"	6	132.9
229-7052	1B	406	45	1003.4	127.0	1207	IRR	102.7	37	1-1/4"	8	133.5
9W-2425	2B	406	45	1019.9	203.0	50	IRR	56	37	1-1/4"	11	131.1
9W-2424	1B	406	45	1023.3	203.0	55	IRR	55	37	1-1/4"	9	135.3
6Y-0016	1B	406	45	1029.4	203.0	58	IRR	58	37	1-1/4"	9	136.1
6Y-0476	1E	406	45	1039.4	180.0	63	152.4	63	28	1"	7	140.2
6Y-0018	1B	406	45	1064.4	203.0	75	IRR	75	37	1-1/4"	9	141.0
9W-2426	1B	406	45	1098.4	203.0	92	IRR	92	37	1-1/4"	11	145.6
6Y-0478*	3E	406	45	1222.7	180.0	71	152.4	85	28	1"	8	164.3
6Y-0477	2E	406	45	1222.8	180.0	71	152.4	85	28	1"	8	161.4
6Y-0479	1E	406	45	1353.2	180.0	67	152.4	67	28	1"	9	182.7
373-1117	1B	406	45	3048.0	202.1	111	IRR	1111	37	1-1/4"	25	404.7
288-6084	0	406	60	519.3	0.0	0	76.2	0	37	1-1/4"	5	88.7
6Y-0022	2B	406	60	782.6	203.0	93	IRR	80	37	1-1/4"	9	133.3
6Y-0020	2B	406	60	1023.9	203.0	52	IRR	58	37	1-1/4"	11	176.6
6Y-0021	1B	406	60	1029.4	203.0	58	IRR	58	37	1-1/4"	11	182.9
6Y-0023	1B	406	60	1064.4	203.0	75	IRR	75	37	1-1/4"	11	189.4
275-6051	1B	406	60	1365.6	202.1	73.2	IRR	73.2	37	1-1/4"	11	243.8
109-9050	2	406	60	3155.2	202.1	55	152.4	55	37	1-1/4"	21	566.0
107-3510	4	406	60	3720.8	202.1	138.4	IRR	138.4	37	1-1/4"	22	681.8
107-3523	4	406	60	4259.6	202.1	55	IRR	50	37	1-1/4"	28	782.0
135-9577	2B	406	75	1014.5	202.1	47	IRR	56	37	1-1/4"	11	219.7
195-7187	1B	406	75	1023.4	202.1	55	IRR	55	37	1-1/4"	11	228.1
135-9578	1B	406	75	1098.4	202.1	92	IRR	92	37	1-1/4"	11	245.6
109-9047	2	406	120	1729.9	0.0	0	0.0	0	37	1-1/4"	0	488.9
(366-4328)	1B	406	75	1003.4	127.0	120.7	IRR	120.7	37	1-1/4"	8	202.1
7T-4341*	1E	406	40	900.1	180.0	69	152.4	69	28	1"	6	107.5
9W-6657	4	406	45	859.1	203.0	138	152.4	111	37	1-1/4"	5	111.5
9W-3929	4	406	45	876.6	203.0	127	152.4	140	37	1-1/4"	5	114.1
9W-3928	1	406	45	909.0	203.0	74	152.4	74	37	1-1/4"	6	121.4
128-5904*	1E	457	75	847.9	202.1	119	152.4	119	37	1-1/4"	5	218.3
128-5905*	3	457	75	1065.0	202.1	138	152.4	74	37	1-1/4"	7	263.3
128-5906*	2E	457	75	1065.0	202.1	138	IRR	74	37	1-1/4"	7	263.3
238-3171	10	483	45	1003.4	202.1	102.7	IRR	120.7	37	1-1/4"	16	155.0
195-5118	1	483	45	1023.4	202.1	55	152.4	55	37	1-1/4"	9	155.1
430-4991	2	254	19	1217.3	126.2	109.6	152.4	40.9	21	3/4"	8	41.0

Track Type Tractor Ripper Systems



Cat Track Type Tractors

RIPPER PART NUMBERS

Ripper Shanks

Machine Model	Shank Size	Type	Assembled Length	Part Number	Field Repair		Tip Size
					Adapter	Nose	
D3, D3B, D3C, D4B, D4C, D5C	35mm x 75mm	Straight	438mm	8J-5299 ⁴			J200
			525mm	8J-5299 ⁴			
D3G, D3K, D3K2, D4G, D4K, D4K2, D5G, D5K, D5K2, D1, D2, D3	50mm x 109mm	Curved	477mm	1U-1257 ⁴			J250
D5M, D5N, D6K, D6K2, D4	59mm x 138mm	Straight	533mm	9J-6586 ⁴		8E-7300	R300
		Curved	507mm	9J-8913 ⁴			
D5R, D5R2, D6G, D6M, D6N, D6R, D6R2, D6T, D5, D6	73mm x 176mm	Straight	711mm	484-8282		8E-7350	R350
		Curved	667mm	9J-8923 ⁴			CR350
D7R, D7E, D7	73mm x 228mm	Straight	1238mm	9W-7382 ⁴	9W-7488	8E-7350	R350 CR350
D8L	75mm x 332mm	(MS)	1499mm	8E-5341 ^x	8E-8418	9U-9694	R450 CR450
		(SS)	1909mm	8E-5342			
		(DR)	2459mm	8E-5340			
D8N, D8R, D8T, D8	75mm x 332mm	(MS)	1610mm	8E-5346	8E-8418	9U-9694	R450 CR450
		(SS)	2010mm	8E-5347			
		(DR)	2459mm	8E-5340			
D9N, D9R ² , D9	75mm x 332mm	(MS)	1610mm	8E-5346	8E-8418	9U-9694	R450 CR450
		(SS)	2332mm	8E-5339			
		(DR)	2760mm	8E-5348			
D9R ² , D9T, D9	75mm x 332mm	(MS)	1610mm	8E-5346	8E-8418	9U-9694	R450 / CR450
	90mm x 355mm	(SS)	2325mm	114-4503	103-8115	107-3361	R500
		(DR)	2825mm	109-9114	1U-36301	103-81141	CR500
D9L, D10N ²	90mm x 355mm	(MS)	1819mm	8E-8415	103-8115 1U-3630 ¹	107-3361 103-8114 ¹	R500 CR500
		(SS)	2324mm	8E-8414			
		(DR)	2824mm	8E-8416 [*]			
D10N ²	90mm x 355mm	(MS)	1819mm	8E-8415	103-8115	107-3361	R500 / CR500
	90mm x 380mm	(SS)	2510mm	8E-8411	103-8115	107-3361	R500
		(DR)	2997mm	8E-8417	1U-3630 ¹	103-8114 ¹	CR500
D10R, D10T	90mm x 355mm	(MS)	1819mm	8E-8415	103-8115	107-3361	R500 / CR500
			2719mm	4Z-8937			
	100mm x 400mm	(SS)	2510mm	118-2140	103-8115	107-3361	R500
D10L	100mm x 400mm	(MS)	3017mm	109-3135	103-8115 1U-3630 ¹	107-3361 103-8114 ¹	R500 CR500
			1977mm	8E-8413			
			2812mm	8E-8412 [*]			
		(DR)	3035mm	4Z-8849	103-8115 1U-3630 ¹	107-3361 103-8114 ¹	R500 CR500
			3202mm	4Z-9314			
			4444mm	4Z-5346			
D11N, D11R, D11T, D11	100mm x 400mm	(MS)	1977mm	8E-8413	103-8115	107-3361	R500
		(LP)3	3202mm	4Z-9314	1U-3630 ¹	103-8114 ¹	CR500
		(SS)	2792mm	453-7511 ⁵	104-9279		R550 CR550
(SS)	2733mm	104-9277					
	462-8051 ⁵	104-9275					
(DR)	3292mm	467-7973 ⁵					
	4166mm	4Z-8814 [*]					
(LP)3	4826mm	4Z-9312					
		140-6798 ⁵					

¹ For 1 pin shank protectors

² Single shank ripper size increased on newer machines

³ D11 (LP) uses 2 - 4Z9314 and 1 - 4Z9312

⁴ No accommodations for Shank Protector

⁵ Alternate carriage pin hole locations





(MS) - Multi Shank

(SS) - Single Shank

(DR) - Deep Rip

(LP) - Leach Pad

Ripper Tips

Machine Model	Tip Size	Type	Style	Tips			Hardware		
				Short	Int.	Long	Pin		Qty
D3, D3B, D3C, D4B, D4C, D5C	J200	J200 Pin-on	Centerline		1U-3202		Pin Retainer	8E-6208 6E-6209	1 1
			Penetration		1U-3209				
			Sharp		9W-8209				
D3G, D3K, D4G, D4K, D5G, D5K, D1, D2, D3	J250	J250 Pin-on	Penetration		9J-4259		Pin Retainer	132-4763 149-5733	1 1
			Sharp		9W-8259				
D5M, D5N, D6K, D6K2, D4	R300	R300 Pin-on	Penetration		6Y-0309		Pin Retainer	136-8308 114-0359	1 1
			A.R.M.		168-1309				
			Sharp		9W-7309				
D5R, D5R2, D6G, D6M, D6N, D6R, D6R2, D6T, D5, D6	R350 CR350	R350 Pin-on	Centerline		6Y-0352		Pin Retainer	114-0358 114-0359	1 1
			A.R.M.		159-0355				
			Penetration		6Y-0359				
			A.R.M.		159-0356				
			Sharp		416-0249				
D7R, D7E, D7		 CR350 CapSure	Centerline		472-0824		Pin	473-3816	1
			Penetration		472-0825				
D8L	R450 CR450	R450 Pin-on	Centerline	9W-2451	9W-2452	114-0453	Pin Retainer	6Y-3394 8E-4743	1 1
			A.R.M.		8E-5770				
Penetration			4T-5451	4T-5452					
A.R.M.				8E-5771					
Sharp				416-0250					
D8N, D8R, D8T, D8		 CR450 CapSure	Centerline	380-1218	380-1209		Pin	380-1211	1
			A.R.M.		380-1225				
			Penetration		380-1216				
D9N, D9R, D9			A.R.M.		380-1220				
D9R, D9T, D9	R500 Pin-on		Centerline	4T-4501	4T-4502	8E-8503	Pin Retainer	6Y-1204 6Y-1202	1 1
			A.R.M.		8E-5774				
Penetration			4T-5501	4T-5502	4T-5503				
A.R.M.				8E-5772					
Sharp				159-0377					
A.R.M.				8E-5774					
D9L, D10N			Cat G.E.T. are designed to work with your machine and are backed by our industry leading warranty against breakage						
D10N							Pin	416-0246	1
D10R, D10T	R500 CR500	 CR500 CapSure	Centerline	380-1207	356-6430		Pin	416-0246	1
			A.R.M.		445-2041				
			Penetration		331-3505	331-3506			
D10L			A.R.M.		331-3508				
D11N, D11R, D11T, D11	R550 CR550	 CR550 CapSure	SAFETY FIRST! Hammerless tip replacement is fast and easy with Cat CapSure Ripper Tips						
			Centerline	9W-4551	9W-4552		Pin Retainer	9N-4245 6Y-1205	1 1
			A.R.M.		122-2552				
			Penetration		6Y-3552				
			A.R.M.		135-9552		Pin Retainer	353-2546	1
			Centerline	357-2712	356-6428				
			A.R.M.		445-2039				
Penetration		331-3553							
A.R.M.		421-5417							

Cat Track Type Tractors

RIPPER PART NUMBERS

Shank Protectors

Machine Model	Shank Width	Type	Standard	Sharp	Extended	Multi-Piece ²	Hardware	Qty	
D3, D3B, D3C, D4B, D4C, D5C	35mm								
D3G, D3K, D4G, D4K, D5G, D5K, D1, D2, D3	50mm								
D5M, D5N, D6K, D6K2, D4	73mm								
D5R, D5R2, D6G, D6M, D6N, D6R, D6R2, D6T, D5, D6	75mm	Pin-on	138-0796				Pin Retainer 114-0358 114-0359	1 1	
		CapSure		472-0827			473-3816	1	
D7R, D7E, D7	75mm								
D8L	75mm	Pin-on	6J-8814	8E-1848	132-4716		Pin Retainer 6Y-3394 8E-4743	2 2	
D8N, D8R, D8T, D8		CapSure		380-1214	380-1223		Upper Lower 380-1211 380-1222	1 1	
D9N, D9R ²	90mm	Pin-on	3G-9594 ^{x1}	9W-8365 6Y-9704 ¹	132-1014		109-9061 Pin Retainer 6Y-1204 6Y-1202	2 2	
D9R ² , D9T, D9		CapSure		444-9711	357-2702		Upper Lower 512-5770 353-2548	1 1	
D9L, D10N	90mm	Pin-on	3G-9594 ^{x1}	9W-8365 6Y-9704 ¹	132-1014		109-9061 Pin Retainer 6Y-1204 6Y-1202	2 2	
D10N		CapSure		444-9711	357-2702		Upper Lower 512-5770 353-2548	1 1	
D10R, D10T	Ask your Dealer about our M.A.O. (Made As Ordered) Program								
D10L	100mm	Pin-on	3G-9594 ^{x1}	6Y-8960 6Y-9704 ¹	132-1015	Protector Bar (Stock) ³ Clamp Spacers Bolts Nuts	109-9062 109-9071 109-9067 132-1003 9F-6936 2J-3507	Pin Retainer 6Y-1204 6Y-1202	2 2
		CapSure		331-3510	357-2704		Upper Lower 416-0246 353-2548	1 1	
D11N, D11R, D11T, D11	110mm	Pin-on		9N-4621	132-1016	Protector Bar (Stock) ³ Clamp Spacers Bolts Nuts	109-9063 109-9076 109-9072 132-1004 5B-5473 2J-3507	Pin Retainer 9N-4245 6Y-1205	2 2
		CapSure		331-3560	357-2701		Upper Lower 353-2546 353-2600	1 1	

¹1-pin shank protector

²Single shank protector size increased on newer machines

³Multi-piece Shank Protector – cut bar stock to length required

Discontinued
Canceled
(Reference)

Part is discontinued. Please contact your service representative.
Part is canceled. Please contact your customer service representative.
Part number is not serviceable. For reference only.

Motorgraders



Discontinued
Canceled
(Reference)

Part is discontinued. Please contact your service representative.
Part is canceled. Please contact your customer service representative.
Part number is not serviceable. For reference only.

Cat Motorgraders

OPTIONS

GRADER BIT SYSTEM

Bit Spacing Table				
Aggregate Spacing	Bit Gap	Bit Arrangement	Bit Width	Bit Ratio
0 in	3 mm	Wide bits across the board	63 mm	1:0
0.6 in	17 mm	Alternate Wide and Standard bits	63 and 30 mm	1:0.4
0.8 in	20.5 mm	Alternate Wide and Penetration bits	63 and 23 mm	1:0.5
1 in	24.5 mm	Alternate Wide and Sharp bits	63 and 15.5 mm	1:0.67
1.25 in	31 mm	Standard bits across the board	30 mm	1:1
1.35 in	34.5 mm	Alternate Standard and Penetration bits	30 and 23 mm	1:1.3
1.5 in	38 mm	Penetration bits across the board	23 mm	1:1.65
1.5 in	38.25 mm	Alternate Standard and Sharp bits	30 and 15.5 mm	1:1.7
1.65 in	41.75 mm	Alternate Penetration and Sharp bits	23 and 15.5 mm	1:2.17
1.8 in	45.5 mm	Sharp bits across the board	15.5 mm	1:3
2.5 in	64 mm	Wide bit every other space	63 mm	1:1.1

Bit Ratio: The ratio between the length of the bit and the length of the bit gap.





Cat Motorgraders

PART NUMBERS

12' Blades

Machine Models: 120H, 12H, 135H, 140H

5/8" Bolt Holes

Moldboard Cutting Edges														
Profile	Type	Width Tooth X Gap (mm)	Length	Qty	Hardware	Thickness				End Bits	Hard- ware	Overlay	Hardware	
						13mm	16mm	19mm	25mm					
Curved	Standard	6"	6'	2	13	8D-2786	5D-9553	5D-9556			5	9W-1767	4	
		8"			13	8D-2788	5D-9562	5D-9558	4T-2244			9W-1768	4	
	General Duty	6"			8	9W-2297	7T-1633							
		8"				9W-2313	7T-1636	7T-1634					N/A	N/A
		Serrated			8" - 36x25	13		132-1072						
Flat	Standard	8"	2	13		4T-2968		4T-3007	7T-3499					
	Std. A.R.M.		8					420-2054*			N/A	N/A		
	Serrated	8" - 51X51	2	13				350-0179						
Carbide Edges														
Curved	Tungsten Carbide	4.75"	2'	6	5						5	135-9345	4	
		3'	4	7				208-8862						
		6.75"	2'	6	5			195-7265						
	Tung. Carbide Serrated	6.75" - 62X40	3'	4	7				208-8864					
		6.75" - 62X40	3'	4	7				217-4696					
Flat	Tungsten Carbide	6.75"	3'	4	7				195-7260					
		4'	3	9					195-7262					
	Carbide Insert	5"	3'	4	5					198-2635				
		4"	3	6						198-2659	356-5242			
		6"	3'	4	5					275-2478				
		Trapezoid	4'	3	6					264-2215				
Specialty														
Rotating Bit System														
Type	Width	Length	Qty	Hard- ware	Adapter Board	Bits per Board	Shank Size	Bits	Notes					
Rotating Bit	5.9"	3'	4	7	308-8574	21	7/8"	571-0532						
		4'	3	9	308-8575	28								
	7.2"	3'	4	7	358-9039	21	1"	571-0533						
		4'	3	9	358-9040	28								
Grader Bit System														
Type	Part Number	Name	Length	Hardware	Bits per Board	Adapters per Moldboard	Bit Part Number	Bit Part Name	Width (mm)	Notes				
Grader Bit	552-8520	Left Hand Adapter Board	2'	5	10	2	552-8524	Penetration Bit	15					
							552-8525	Sharp Bit	20					
	552-8521	2' Center Adapter Board	2'	4	10	2	552-8526	Standard Bit	30					
							552-8527	Wide Bit	60					
							552-8528	Standard Mining Bit	30					
							552-8529	Wide Mining Bit	60					
	552-8523	Right Hand Adapter Board	2'	4	10	2	560-8840	SnowBit	60					
						563-1186	BoreSaver	-	552-8528	552-8529	560-8840	563-1186		
Type	Part Number			Angle			Length	Quantity						
Angling Plate	552-9410			0°			1'	12						
	552-9411			5°										
	552-9412			10°										
	552-9413			15°										
	552-9414			20°										
	552-9415			25°										
	552-9416			30°										
Hardware and Wear Protection														
Type	Application	Hardware		Quantity	Bolts	Nuts	Washers	Notes						
Hardware	Standard Edges	Bolts	5/8-11 x 2-1/4	26	3F-5108	4K-0367	5P-8247	Inspect moldboard for excess wear. Ensure moldboard and new edges are free from paint and debris. Torque 5/8" Nuts to 200 +/- 30 ft. lb.						
	Rotating Bits	Bolts	3/4-10 x 2-3/4	24	4F-3657									
	Specialty'	Bolts	5/8-11 x 2-3/4 w/ 3/4 head	24	452-8225									
	End Bits	Bolts	5/8-11 x 2-1/4	10	3F-5108									
	Overlays	Bolts	3/4-10 x 2-3/4	8	4F-3657									
	Front Blade	Bolts	3/4-10 x 2-1/4	see above	4F-7827								2J-3506	5P-8248
	Extension	Bolts		5	4F-3658									
	Grader Bits	Pull Ring	132-3812	1										
Wear Protection	Moldboard Plate	Bearing Sleeve	562-9545	1										
		13.5" Radius	4D-5820	2										
		16.25" Radius	8W-5265	2										

Cat Motorgraders

PART NUMBERS

12' Blades

Machine Models: 120H, 12H, 135H, 140H

5/8" Bolt Holes

Auxiliary Blade Cutting Edges										
Profile	Type	Width	Length	Qty	Hardware	Thickness				Notes
						13mm	16mm	19mm	25mm	
Front Mount Blades	9 ft Blade	8"	26"	2	4			4T-3010		uses 3/4" bolts 
			56"	1	9			169-4089		
	8 ft Blade	8"	18.2"	2	3			4T-8353		
			61.3"	1	10			4T-2315		
9'7" Foldable	8"	18.2"	2	3			4T-8353			
		78.8"	1	13			4T-8378			
2' Extension	Curved	6"	24"	1	4		9W-1835		LH: (452-3133) RH: (243-6685)	
		8"	24"	1	4		109-3137	6G-8623		
Rippers / Scarifiers										
Adapter Size	Shanks			Tips			Pin	Retainer	Misc	
	Type	Part Number		Type	Std	A.R.M.				
Rear Mount J200 ²	Straight	8J-5299	Did you know? Edges with 5/8" bolt holes can be used with 3/4" moldboards. Use bushings: 7/8" - 280-4070 1" - 280-4071	Centerline	1U-3202		8E-6208	6E-6209		
				Penetration	1U-3209					
				Sharp	9W-8209					
Rear Mount R300 ³	Straight	9J-6586		Penetration	6Y-0309	168-1309	136-8308	114-0359	Repair Nose 8E-7300	
				Curved	9J-8913					
Scarifier V-Block ⁴	Standard	195-7218		General Purpose	195-7234		5K-1459	5K-1458 5K-1458	Tip Removal Tool 6B-3260	
				Long	7D-4501					143-3074
Scarifier Straight Block ⁵	Standard	195-7219		General Purpose	195-7234					
				Long						143-3074

¹ 3/4" Bolt Holes – requires special bolts 452-8225

² Used on 120H, 135H

³ Used on 12H, 140H, 143H

⁴ Front Notched

⁵ Rear Notched





Cat Motorgraders

PART NUMBERS

12' Blades

Machine Models: 120K, 12K, 140K, 120M, 12M, 140M, 160M, 140, 150, 160

3/4" Bolt Holes

Moldboard Cutting Edges															
Profile	Type	Width Tooth X Gap (mm)	Length	Qty	Hardware	Thickness				End Bits	Hard- ware	Overlay	Hardware		
						13mm	16mm	19mm	25mm						
Curved	Standard	6"	6'	2	13	9J-3660*	9J-3657				5	232-2142 ¹	4		
		8"					9J-7701	7D-1576	4T-2231			6Y-2805	4		
	General Duty	6"	6'	2	8	7T-1637									
		8"					7T-1639	7T-1638							
		8" - 36X25				6'	2	13				399-2791*			
Serrated	8" - 62X40	2'	6	5					(138-0857)		N/A	N/A			
	8" - 62X40	3'	4	5					(138-0859)						
Flat	Standard	8"	6'	2	13			4T-2971	4T-3033			N/A	N/A		
		10"							7T-3493	4T-6502					
Serrated	8" - 12X62	4'	3	9					7T-3600						
Carbide Edges															
Curved	Tungsten Carbide	4.75"	2'	6	5				208-8863		5	135-9369	4		
			3'	4	7			217-4698							
		6.75"	2'	6	5			195-7266							
			3'	4	7			195-7267							
	Tung. Carbide Serrated	6.75" - 62X40	2'	6	5				208-8865					N/A	N/A
Flat	Carbide Insert	6"	4'	3	6				283-1063			N/A	N/A		
			3'	4	5			330-9491							
		5"	4'	3	6				217-4697*						
			3'	4	5			286-3148							
Specialty															
Rotating Bit System															
Type	Width	Length	Qty	Hard- ware	Adapter Board	Bits per Board	Shank Size	Bits	Notes						
Rotating Bit	5.9"	3'	4	7	307-2613	21	7/8"	571-5032							
		4'	3	9	307-2615	28									
	7.2"	3'	4	7	323-1251	21	1"	571-0533							
		4'	3	9	321-4272	28									
Grader Bit System															
Type	Part Number	Name	Length	Hardware	Bits per Board	Adapters per Moldboard	Bit Part Number	Bit Part Name	Width (mm)	Notes					
Grader Bit	552-8520	Left Hand Adapter Board	2'	5	10	2	552-8524	Penetration Bit	15						
							552-8525	Sharp Bit	20						
	552-8521	2' Center Adapter Board	2'	4	10	2	552-8526	Standard Bit	30						
							552-8527	Wide Bit	60						
	552-8523	Right Hand Adapter Board	2'	4	10	2	552-8528	Standard Mining Bit	30						
							552-8529	Wide Mining Bit	60						
							560-8840	SnowBit	60						
							563-1186	BoreSaver	-						
Angling Plate	Type		Part Number			Angle		Length		Quantity					
			552-9410			0°		1'		12					
			552-9411			5°									
			552-9412			10°									
			552-9413			15°									
			552-9414			20°									
			552-9415			25°									
		552-9416			30°										
Hardware and Wear Protection															
Type	Application	Hardware		Quantity	Bolts	Nuts	Washers	Notes							
Hardware	Standard Edges	Bolts	3/4-10 x 2-1/2	26	5J-4773	2J-3506	5P-8248	Inspect moldboard for excess wear Ensure moldboard and new edges are free from paint and debris. Torque 3/4" Nuts to 350 +/- 45 ft. lb.							
	Specialty	Bolts	3/4-10 x 2-3/4	23	5J-4771										
	End Bits	Bolts	3/4-10 x 2-1/2	10	5J-4773										
	Overlays	Bolts	3/4-10 x 3-3/4	8	5F-8933										
	Front Blade	Bolts	3/4-10 x 2-1/4	17	4F-7827										
	Extension	Bolts	3/4-10 x 2-1/4	4	5J-4773										
	Grader Bits	Pull Ring	132-3812	1											
Wear Protection	Moldboard Plate	Grader Bits	Bearing Sleeve	562-9545	1										
			13.5" Radius	4D-5820	2										
			16.25" Radius	8W-5265	2										

12' Blades

Machine Models: 120K, 12K, 140K, 120M, 12M, 140M, 160M, 140, 150, 160

3/4" Bolt Holes

Auxiliary Blade Cutting Edges										
Profile	Type	Width	Length	Qty	Hardware	Thickness				Notes
						13mm	16mm	19mm	25mm	
Front Mount Blades	9 ft Blade	8"	26"	2	4			4T-3010		
			56"	1	9			169-4089		
2' Extension	Curved	6"	24"	1	4		232-2146			LH: (452-3133)
		8"	24"	1	4		3G-2166	3G-2165		RH: (243-6685)
Rippers / Scarifiers										
Adapter Size	Shanks			Tips			Pin	Retainer	Misc	
	Type	Part Number		Type	Std	A.R.M.				
Rear Mount R300	Straight	9J-6586	Contact your dealer for custom cutting edge combinations.	Penetration	6Y-0309	168-1309	136-8308	114-0359	Repair Nose 8E-7300	
	Curved	9J-8913		Sharp	9W-7309					
Scarifier V-Block ¹	Standard	195-7218		General Purpose	195-7234		5K-1459	5K-1458	Tip Removal Tool 6B-3260	
	Long	7D-4501		High Temp	6Y-5230	143-3074				
Scarifier Straight Block ⁵	Standard	195-7219		General Purpose	195-7234					
	Long			High Temp	6Y-5230	143-3074				

¹ for 6" edges used on 120M, 140M, 12M, 160M

⁴ Front Notched

⁵ Rear Notched







Cat Motorgraders

PART NUMBERS

13' Blades

Machine Models: 120H, 12H, 135H, 140H, 143H, 160H, 163H

5/8" Bolt Holes

Moldboard Cutting Edges															
Profile	Type	Width Tooth X Gap (mm)	Length	Qty	Hardware	Thickness				End Bits	Hardware	Overlay	Hardware		
						13mm	16mm	19mm	25mm						
Curved	Standard	8"	6'	1	13	8D-2788	5D-9562	5D-9558	4T-2244		5	N/A	N/A		
			7'	1	15	8D-2789	5D-9561	5D-9559	4T-2242						
	General Duty	8"	6'	1	8	9W-2297	7T-1633								
		7'	1	9	9W-2299	7T-1645									
	Serrated	6"	6'	1	8	9W-2313	7T-1636	7T-1634	132-1072						
		7'	1	9	9W-2315	7T-1643	7T-1623	4Z-9020	399-2790*						
Flat	Standard	8"	6'	1	13		4T-2968	4T-3007	7T-3499		5	N/A	N/A		
			7'	1	15		4T-2969	4T-3036	7T-3498						
Serrated	8" - 36X25	6'	1	13											
	8" - 36X25	7'	1	15											
Serrated	8" - 24X51	6'	1	13				350-0179							
	8" - 28X51	7'	1	15				350-0181							
Carbide Edges															
Curved	Tungsten Carbide	4.75"	2'	2	5			208-8863			5	N/A	N/A		
		3'	3	7			217-4698								
		6.75"	2'	3	7			195-7265							
	3'	1	9			195-7264									
Tung. Carbide Serrated	6.75" - 62X40	2'	2	5				208-8864							
	6.75" - 62X40	3'	3	7				217-4696							
Flat	Tungsten Carbide	6.75"	3'	3	7			195-7260			5	N/A	N/A		
		4'	1	9			195-7262								
	Carbide Insert	5"	3'	3	5			198-2635							
		4'	1	6			198-2659								
		6"	3'	3	5			275-2478							
Trapezoid	4'	1	6			264-2215									
Flat															
Rotating Bit System															
Type	Width	Length	Qty	Hardware	Adapter Board	Bits per Board	Shank Size	Bits	Notes						
Rotating Bit	5.9"	3'	3	7	308-8574	21	7/8"	571-0532							
		4'	1	9	308-8575	28									
	7.2"	3'	3	7	358-9039	21	1"	571-0533							
		4'	1	9	358-9040	28									
Grader Bit System															
Type	Part Number	Name	Length	Hardware	Bits per Board	Adapters per Moldboard	Bit Part Number	Bit Part Name	Width (mm)	Notes					
Grader Bit	552-8520	Left Hand Adapter Board	2'	5	10	2	552-8524	Penetration Bit	15						
	552-8521	2' Center Adapter Board	2'	4	10	1	552-8525	Sharp Bit	20						
							552-8526	Standard Bit	30						
	552-8522	3' Center Adapter Board	3'	6	15	1	552-8527	Wide Bit	60						
							552-8528	Standard Mining Bit	30						
	552-8523	Right Hand Adapter Board	2'	4	10	2	552-8529	Wide Mining Bit	60						
							560-8840	SnowBit	60						
							563-1186	BoreSaver	-					552-8528	552-8529
Angling Plate															
Type	Part Number	Angle	Length	Quantity											
Angling Plate	552-9410	0°	1'	13											
	552-9411	5°													
	552-9412	10°													
	552-9413	15°													
	552-9414	20°													
	552-9415	25°													
	552-9416	30°													
Hardware and Wear Protection															
Type	Application	Hardware	Quantity	Bolts	Nuts	Washers	Notes								
Hardware	Standard Edges	Bolts	28	3F-5108	4K-0367	5P-8247	Inspect moldboard for excess wear. Ensure moldboard and new edges are free from paint and debris. Torque 5/8 Nuts to 200 +/- 30 ft. lb.								
	Rotating Bits	Bolts	24	4F-3657											
	Specialty ¹	Bolts	24	452-8225											
	End Bits	Bolts	10	3F-5108											
	Overlays	Bolts	8	4F-3657											
	Front Blade	Bolts	see above	4F-7827										2J-3506	5P-8248
	Extension	Bolts	4	4F-3658											
	Grader Bits	Pull Ring	132-3812	1											
	Grader Bits	Bearing Sleeve	562-9545	1											
Wear Protection	Moldboard Plate	13.5" Radius	6'	4D-5820	1										
		16.25" Radius	6'	8W-5265	1										
		13.5" Radius	7'	4D-5821	1										
		16.25" Radius	7'	8W-5266	1										

13' Blades

Machine Models: 120H, 12H, 135H, 140H, 143H, 160H, 163H

5/8" Bolt Holes

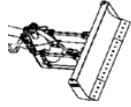
Auxiliary Blade Cutting Edges										
Profile	Type	Width	Length	Qty	Hardware	Thickness				Notes
						13mm	16mm	19mm	25mm	
Front Mount Blades	9 ft Blade	8"	26" 56"	2 1	4 9			4T-3010 169-4089		uses 3/4" bolts 
	8 ft Blade	8"	18.2" 61.3"	2 1	3 10			4T-8353 4T-2315		
	9'7" Foldable	8"	18.2" 78.8"	2 1	3 13			4T-8353 4T-8378		
2' Extension	Curved	6"	24"	1	4			9W-1835		LH: (452-3133) RH: (243-6685)
		8"	24"	1	4			109-3137 6G-8623		
Rippers / Scarifiers										
Adapter Size	Shanks			Tips			Pin	Retainer	Misc	
	Type	Part Number		Type	Std	A.R.M.				
Rear Mount J200 ²	Straight	8J-5299	Don't see what you need? Ask about our MAO program.	Centerline	1U-3202		8E-6208	6E-6209		
				Penetration	1U-3209					
				Sharp	9W-8209					
Rear Mount R300 ³	Curved	9J-8913		Penetration	6Y-0309	168-1309	136-8308	114-0359	Repair Nose 8E-7300	
				Sharp	9W-7309					
Scarifier V-Block ⁴	Long	7D-4501		General Purpose	195-7234		5K-1459	5K-1458	Tip Removal Tool 6B-3260	
			High Temp	6Y-5230	143-3074					
Scarifier Straight Block ⁵	Standard	195-7219	General Purpose	195-7234						
			Long	High Temp	6Y-5230	143-3074				

¹3/4" Bolt Holes - requires special bolts 452-8225

²Used on 120H, 135H

³Used on 12H, 140H, 143H, 14H, 160H, 163H

⁴Front Notched

⁵Rear Notched







Cat Motorgraders

PART NUMBERS

14' Blades

Machine Models: 120H, 12H, 135H, 140H, 143H

5/8" Bolt Holes

Moldboard Cutting Edges																
Profile	Type	Width Tooth X Gap (mm)	Length	Qty	Hardware	Thickness				End Bits	Hard- ware	Overlay	Hardware			
						16mm	19mm	25mm	35mm							
Curved	Standard	6"	7'	2	15	5D-9554	5D-9557				5	9W-1767	4			
		8"				5D-9561	5D-9559	4T-2242	9W-1768			4				
	General Duty	6"				7T-1645 [®]										
		8"				7T-1643 [®]	7T-1623 [®]									
Serrated	8" - 36X25 (Inter Teeth) (Long Teeth)			15		4Z-9020	399-2790* 274-3709* 217-4823*					N/A	N/A			
Flat	Standard	8"	7'	2	15	4T-2969	4T-3036				5	N/A	N/A			
	Serrated	8" - 51x26					15	350-0181							N/A	N/A
Carbide Edges																
Curved	Tungsten Carbide	4.75"	2'	4	5		217-4695				5	135-9345	4			
		3'	2	7		208-8862										
		6.75"	2'	4	5		195-7265								135-9346	4
		3'	2	7		195-7264										
Tung. Carbide Serrated	6.75" - 62X40	2'	4	5				208-8864				N/A	N/A			
	6.75" - 62X40	3'	2	7				217-4696								
Flat	Tungsten Carbide	6.75"	3'	2	7		195-7260				5	N/A	N/A			
		4'	2	9		195-7262										
	Carbide Insert	5"	3'	2	5		198-2635 [®]								N/A	N/A
		4'	2	6		198-2659 [®]										
		3'	2	5		275-2478 [®]										
		6"	4'	2	6		264-2215 [®]									
Specialty																
Rotating Bit System																
Type	Width	Length	Qty	Hard- ware	Adapter Board	Bits per Board	Shank Size	Bits	Notes							
Rotating Bit	5.9"	3'	2	7	308-8574	21	7/8"	571-0532								
		4'	2	9	308-8575	28										
	7.2"	3'	2	7	358-9039	21	1"	571-0533								
		4'	2	9	358-9040	28										
Grader Bit System																
Type	Part Number	Name	Length	Hardware	Bits per Board	Adapters per Moldboard	Bit Part Number	Bit Part Name	Width (mm)	Notes						
Grader Bit	552-8520	Left Hand Adapter Board	2'	5	10	2	552-8524	Penetration Bit	15							
							552-8525	Sharp Bit	20							
							552-8526	Standard Bit	30							
							552-8527	Wide Bit	60							
	552-8522	3' Center Adapter Board	3'	6	15	2	552-8528	Standard Mining Bit	30							
							552-8529	Wide Mining Bit	60							
552-8523	Right Hand Adapter Board	2'	4	10	2	560-8840	SnowBit	60								
						563-1186	BoreSaver	-								
Angling Plate																
Type	Part Number	Name	Length	Hardware	Bits per Board	Adapters per Moldboard	Bit Part Number	Bit Part Name	Width (mm)	Notes						
Angling Plate	552-9410		1'													
														552-9411	0°	
														552-9412	5°	
														552-9413	10°	
														552-9414	15°	
														552-9415	20°	
														552-9416	25°	
	30°															
Hardware and Wear Protection																
Type	Application	Hardware	Quantity	Bolts	Nuts	Washers	Notes									
Hardware	Standard Edges	Bolts	5/8-11 x 2-1/4	30	3F-5108		Inspect moldboard for excess wear Ensure moldboard and new edges are free from paint and debris. Torque 5/8" Nuts to 200 +/- 30 ft. lb.									
	Rotating Bits	Bolts	3/4-10 x 2-3/4	28	4F-3657											
	Specialty ¹	Bolts	5/8-11 x 2-3/4 w/ 3/4 head	30	452-8225	4K-0367								5P-8247		
	End Bits	Bolts	5/8-11 x 2-1/4	10	3F-5108											
	Overlays	Bolts	3/4-10 x 2-3/4	8	4F-3657											
	Front Blade	Bolts	3/4-10 x 2-1/4	see above	4F-7827	2J-3506								5P-8248		
	Extension	Bolts		4	4F-3658											
	Grader Bits	Pull Ring	132-3812	1												
Wear Protection	Moldboard Plate	Bearing Sleeve	562-9545	1												
		13.5" Radius	4D-5821	2												
		16.25" Radius	8W-5266	2												

14' Blades

Machine Models: 120H, 12H, 135H, 140H, 143H

5/8" Bolt Holes

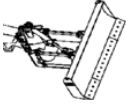
Auxiliary Blade Cutting Edges									
Profile	Type	Width	Length	Qty	Hardware	Thickness			Notes
						13mm	16mm	19mm	
Front Mount Blades	9 ft Blade	8"	26" 56"	2 1	4 9			4T-3010 169-4089	uses 3/4" bolts 
	8 ft Blade	8"	18.2" 61.3"	2 1	3 10			4T-8353 4T-2315	
	9'7" Foldable	8"	18.2" 78.8"	2 1	3 13			4T-8353 4T-8378	
2' Extension	Curved	6"	24"	1	4			9W-1835	LH: (452-3133) RH: (243-6685)
		8"	24"	1	4			109-3137 6G-8623	

Rippers / Scarifiers									
Adapter Size	Shanks			Tips			Pin	Retainer	Misc
	Type	Part Number		Type	Std	A.R.M.			
Rear Mount J200 ²	Straight	8J-5299	Did you know? Edges with 5/8" bolt holes can be used with 3/4" moldboards. Use bushings: 7/8" - 280-4070 1" - 280-4071	Centerline	1U-3202		8E-6208	6E-6209	
				Penetration	1U-3209				
				Sharp	9W-8209				
Rear Mount R300 ³	Straight	9J-6586		Penetration	6Y-0309	168-1309	136-8308	114-0359	Repair Nose 8E-7300
				Curved	9J-8913				
Scarifier V-Block ⁴	Standard	195-7218		General Purpose	195-7234		5K-1459	5K-1458	Tip Removal Tool 6B-3260
				High Temp	6Y-5230	143-3074			
Scarifier Straight Block ⁵	Standard	195-7219		General Purpose	195-7234				
				Long	High Temp	6Y-5230			

Cat Motorgraders

PART NUMBERS

14' Blades

Machine Models: 140H, 14H, 143H, 160H, 163H, 120K, 120M, 12K, 12M, 140K, 140M, 160K, 160M, 12M, 14M, 140, 150, 160, 14

3/4" Bolt Holes

Moldboard Cutting Edges													
Profile	Type	Width Tooth X Gap (mm)	Length	Qty	Hardware	Thickness				End Bits	Hard- ware	Overlay	Hardware
						16mm	19mm	25mm	35mm				
Curved	Standard	6"	7'	2	15	9J-3658				8E-5529	5	6Y-2805	4
		8"				7D-1158	7D-1577	4T-2233					
	General Duty	6"					4Z-8785						
		8"				7T-1626							
	Serrated	8" - 36X25					283-1068	311-7674*					
		8" - 51X26					350-7200	7T-3494					
Flat	Standard	8" - 62X40		217-4833	350-7201				8E-5529	5	N/A	N/A	
		8" - 60x32		4T-2970	4T-3032	4T-6508	4T-8316						
	8"												
	10"												
	11"												
	Serrated	8" - 51X26		350-0180	140-6790								
		10" - 56X33		4Z-8055	4Z-8346								

Carbide Edges													
Curved	Tungsten Carbide	4.75"	2'	4	5		208-8863			8E-5529	5	135-9369	4
			3'	2	7		217-4698						
		6.75"	3'	2	7		217-4699						
		4'	2	9		208-8866							
	Tung. Carbide Serrated	6.75" - 62X40	2'	4	5		208-8865						
		6.75" - 62X40	3'	2	7		217-4697*						
Flat	Carbide Insert	6"	3'	5	5		330-9491						
			4'	2	6		286-3148						

Specialty Rotating Bit System														
Type	Width	Length	Qty	Hard- ware	Adapter Board	Bits per Board	Shank Size	Bits	Notes					
Rotating Bit	5.9"	3'	2	7	307-2613	21	7/8"	571-0532						
		4'	2	9	307-2615	28								
	7.2"	3'	2	7	323-1251	21	1"	571-0533						
		4'	2	9	321-4272	28								

Grader Bit System													
Type	Part Number	Name	Length	Hardware	Bits per Board	Adapters per Moldboard	Bit Part Number	Bit Part Name	Width (mm)	Notes			
Grader Bit	552-8520	Left Hand Adapter Board	2'	5	10	2	552-8524	Penetration Bit	15				
							552-8525	Sharp Bit	20				
							552-8526	Standard Bit	30		552-8524	552-8525	552-8526
							552-8527	Wide Bit	60		552-8527		
	552-8522	3' Center Adapter Board	3'	6	15	2	552-8528	Standard Mining Bit	30				
							552-8529	Wide Mining Bit	60		552-8528	552-8529	560-8840
552-8523	Right Hand Adapter Board	2'	4	10	2	560-8840	SnowBit	60					
						563-1186	BoreSaver	-	563-1186				

Type	Part Number	Angle	Length	Quantity
Angling Plate	552-9410	0°	1'	14
	552-9411	5°		
	552-9412	10°		
	552-9413	15°		
	552-9414	20°		
	552-9415	25°		
	552-9416	30°		

Hardware and Wear Protection														
Type	Application	Hardware	Quantity	Bolts	Nuts	Washers	Notes							
Hardware	Standard Edges	Bolts	3/4-10 x 2-1/2	30	5J-4773	2J-3506	5P-8248	Inspect moldboard for excess wear. Ensure moldboard and new edges are free from paint and debris. Torque 3/4" Nuts to 350 +/- 45 ft. lb.						
	Specialty	Bolts	3/4-10 x 2-3/4	30	5J-4771									
	End Bits	Bolts	3/4-10 x 2-1/2	10	5J-4773									
	Overlays	Bolts	3/4-10 x 3-3/4	8	5F-8933									
	Front Blade	Bolts	3/4-10 x 2-1/4	see above	4F-7827									
	Extension	Bolts	3/4-10 x 2-1/4	4	5J-4773									
	Grader Bits	Pull Ring	132-3812	1										
	Grader Bits	Bearing Sleeve	562-9545	1										
Wear Protection	Moldboard Plate	13.5" Radius	4D-5821	2										
		16.25" Radius	8W-5266	2										

14' Blades

Machine Models: 140H, 14H, 143H, 160H, 163H, 120K, 120M, 12K, 12M, 140K, 140M, 14M, 160K, 160M, 12M, 14M, 140, 150, 160, 14

3/4" Bolt Holes

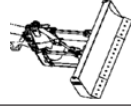
Auxiliary Blade Cutting Edges										
Profile	Type	Width	Length	Qty	Hardware	Thickness				Notes
						13mm	16mm	19mm	25mm	
Front Mount Blades	9 ft Blade	8"	26"	2	4			4T-3010		uses 3/4" bolts 
			56"	1	9			169-4089		
	8 ft Blade	8"	18.2"	2	3			4T-8353		
61.3"			1	10			4T-2315			
9'7" Foldable	8"	8"	18.2"	2	3			4T-8353		
			78.8"	1	13			4T-8378		
2' Extension	Curved	6"	24"	1	4		3G-2166	3G-2165	LH: (265-6743) RH: (265-6744)	

Rippers / Scarifiers									
Adapter Size	Shanks		Don't see what you need? Ask about our MAO program.	Tips			Pin	Retainer	Misc
	Type	Part Number		Type	Std	A.R.M.			
Rear Mount R300	Straight	9J-6586		Penetration	6Y-0309	168-1309	136-8308	114-0359	Repair Nose 8E-7300
	Curved	9J-8913		Sharp	9W-7309				
Scarifier V-Block ⁴	Standard	195-7218		General Purpose	195-7234		5K-1459	5K-1458	Tip Removal Tool 6B-3260
	Long	7D-4501		High Temp	6Y-5230	143-3074			
Scarifier Straight Block ⁵	Standard	195-7219		General Purpose	195-7234				
	Long			High Temp	6Y-5230	143-3074			

¹ 3/4" Bolt Holes – requires special bolts 452-8225

² Used on 120H, 135H

³ Used on 12H, 140H, 143H

⁴ Front Notched

⁵ Rear Notched

⁶ 12" Bolt Hole Spacing

Cat Motorgraders

PART NUMBERS









16' Blades

Machine Models: 160H, 14H, 16G, 16H

5/8" Bolt Holes

Moldboard Cutting Edges													
Profile	Type	Width Tooth X Gap (mm)	Length	Qty	Hardware	Thickness				End Bits	Hard- ware	Overlay	Hardware
						13mm	16mm	19mm	25mm				
Curved	Standard	6"	8'	2	17	8J-7782	8J-4043			17mm LH: 9J-4408	4	6Y-2805	4
	General Duty					9W-2301	7T-1632						
	Standard	8"				8J-8980	5D-9731	5D-9732	4T-2237	17mm RH: 9J-4407		N/A	N/A
	General Duty					9W-2317	7T-1631	7T-1630				N/A	N/A
Flat	Serrated	8" - 36X25	8'	2	17								
	Standard	8"						4T-2966	4T-3035	7T-3496			

Rotating Bit System										
Type	Width	Length	Qty	Hard- ware	Adapter Board	Bits per Board	Shank Size	Bits	Notes	
Rotating Bit	5.9"	4'	4	9	307-2615	28	7/8"	571-0532		
	7.2"	4'	4	9	321-4272	28	1"	571-0533		

Grader Bit System										
Type	Part Number	Name	Length	Hardware	Bits per Board	Adapters per Moldboard	Bit Part Number	Bit Part Name	Width (mm)	Notes
Grader Bit	552-8520	Left Hand Adapter Board	2'	5	10	2	552-8524	Penetration Bit	15	   
							552-8525	Sharp Bit	20	
							552-8526	Standard Bit	30	
							552-8527	Wide Bit	60	
	552-8521	2' Center Adapter Board	2'	4	10	4	552-8528	Standard Mining Bit	30	   
							552-8529	Wide Mining Bit	60	
	552-8523	Right Hand Adapter Board	2'	4	10	2	560-8840	SnowBit	60	
							563-1186	BoreSaver	-	

Type	Part Number	Angle	Length	Quantity
Angling Plate	552-9410	0°	1'	16
	552-9411	5°		
	552-9412	10°		
	552-9413	15°		
	552-9414	20°		
	552-9415	25°		
	552-9416	30°		

Hardware and Wear Protection							
Type	Application	Hardware	Quantity	Bolts	Nuts	Washers	Notes
Hardware	Standard Edges	Bolts	5/8-11 x 2-1/4	34	3F-5108	2J-3506	5P-8248
	Specialty		5/8-11 x 2-3/4 w/ 3/4 head	34	4f-3657		
	End Bits		5/8-11 x 2-1/4	10	3f-5108		
	Overlays		3/4-10 x 2-3/4	8	4f-3657		
	Front Blade		3/4-10 x 2-1/4	see above	4f-7827		
	Extension			4	4f-3658		
	Grader Bits		Pull Ring	132-3812	1		
Grader Bits	Bearing Sleeve	562-9545	1				
Wear Protection	Moldboard Plate	16.25" Radius	385-6748	2			Inspect moldboard for excess wear. Ensure moldboard and new edges are free from paint and debris. Torque 3/4" Nuts to 350 +/- 45 ft. lb.

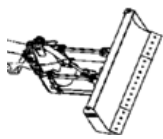
Auxiliary Blade Cutting Edges												
Profile	Type	Width	Length	Qty	Hardware	Thickness				Notes		
						13mm	16mm	19mm	25mm			
Front Mount Blades	9 ft. Blade	8"	26"	2	4			4T-3010		uses 3/4" bolts 		
			56"	1	9			169-4089				
	8 ft. Blade	8"	18.2"	2	3			4T-8353				
			61.3"	1	10			4T-2315				
	9'7" Foldable	8"	18.2"	2	3			4T-8353				
			78.8"	1	13			4T-8378				
2' Extension	Curved	8"	24"	1	4			3G-2166	3G-2165	LH: (281-9455) RH: (456-4448)		

16' Blades

Machine Models: 160H, 14H, 16G, 16H

5/8" Bolt Holes

Adapter Size	Rippers / Scarifiers									Misc	
	Shanks		Protectors		Tips			Pin	Retainer		
	Type	Part Number	Standard	Sharp	Type	Std	A.R.M.				
Rear Mount R300	Straight	9J-6586	-	-	Penetration		6Y-0309	168-1309	136-8308	114-0359	Repair Nose 8E-7300
	Curved	9J-8913	-	-	Sharp		9W-7309				
Rear Mount R350	Straight	484-8282	138-0796	-	Pin-On	Penetration	6Y-0359	159-0356	114-0358	114-0359	Repair Nose 8E-7350
				-		Centerline	6Y-0352	159-0355			
				-	CapSure	Penetration	472-0825	-	473-3816	-	
				-		Centerline	472-0824	-			
Scarifier V-Block ⁵	Standard	195-7218	Don't see what you need? Ask about our MAO program.	General Purpose		195-7234		5K-1459	5K-1458	Tip Removal Tool 6B-3260	
	Long	7D-4501		High Temp		6Y-5230	143-3074				
Scarifier Straight Block ⁶	Standard	195-7219		General Purpose		195-7234					
	Long			High Temp		6Y-5230	143-3074				

⁵Front Notched

⁶Rear Notched

⁷Single Bevel



Cat Motorgraders

PART NUMBERS

16' Blades

Machine Models: 160H, 160M, 14H, 14M, 16H, 16M, 160, 16

3/4" Bolt Holes

Moldboard Cutting Edges																		
Profile	Type	Width Tooth X Gap (mm)	Length	Qty	Hardware	Thickness				End Bits	Hard- ware	Overlay	Hardware					
						19mm	25mm	35mm	45mm									
Curved	Standard		8'	2	17	7D-1949	4T-2236			16mm 8E-5529 ³ 19mm 8E-5530 ⁴	5	6Y-2805	4					
	Std. A.R.M.	8"					375-9887											
	General Duty						7T-1627											
	Serrated	8" - 50X26 8" - 36X25 8" - 62X40					350-7202 217-4821 217-4834							N/A	N/A			
Flat	Standard	8"	8'	2	17	4T-3037	7T-3495				5	N/A	N/A					
		10"					4T-6511	4T-8317	104-3628									
		11"					140-6832 ¹	132-1086										
		12"						4Z-9188										
	Std. A.R.M.	10"				195-7177		554-0845										
		13"				489-6706		554-0846										
		Serrated	10" - 57X33 10" - 62X41 10" - 58X51 10" - 60X60 10" - 78X59 10" - 102X77 10" - 130X57	8'	2	17		4Z-8056	100-4581 253-0198 350-0182 350-0183 350-0184					104-3631 552-8124				
			13" - 90X38.5	8'	2	17			134-1778									
	Serr. A.R.M.		10" - 60X60	8'	2	17			554-0848									
	Carbide Edges																	
	Curved	Tungsten Carbide	4.75"	2'	8	5	208-8863								16mm 8E-55293	5	135-9369	4
6.75"			4'	4	9	208-8866				135-9370 ⁸	4							
	Tung. Carbide Serrated	6.75" - 62X40	2'	8	5		208-8865			19mm 8E-5530 ⁴		N/A	N/A					
Flat	Carbide Insert	6"	4'	4	6	286-3148						N/A	N/A					
Specialty																		
Rotating Bit System																		
Type	Width	Length	Qty	Hard- ware	Adapter Board	Bits per Board	Shank Size	Bits	Notes									
Rotating Bit	5.9"	4'	4	9	307-2615	28	7/8"	571-0532										
	7.2"	4'	4	9	321-4272	28	1"	571-0533										
Grader Bit System																		
Type	Part Number	Name	Length	Hardware	Bits per Board	Adapters per Moldboard	Bit Part Number	Bit Part Name	Width (mm)	Notes								
Grader Bit	552-8520	Left Hand Adapter Board	2'	5	10	2	552-8524	Penetration Bit	15									
							552-8525	Sharp Bit	20									
							552-8526	Standard Bit	30									
	552-8527	Wide Bit	60															
	552-8521	2' Center Adapter Board	2'	4	10	4	552-8528	Standard Mining Bit	30									
							552-8529	Wide Mining Bit	60									
552-8523	Right Hand Adapter Board	2'	4	10	2	560-8840	SnowBit	60										
						563-1186	BoreSaver	-										
Type	Part Number		Angle		Length	Quantity												
Angling Plate	552-9410		0°		1'	16												
	552-9411		5°															
	552-9412		10°															
	552-9413		15°															
	552-9414		20°															
	552-9415		25°															
	552-9416		30°															

16' Blades

Machine Models: 160H, 160M, 14H, 14M, 16H, 16M, 160, 16

3/4" Bolt Holes

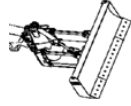
Hardware and Wear Protection												
Type	Application	Hardware		Quantity	Bolts	Nuts	Washers	Notes				
Hardware	Standard Edges ³	160H/M, 14H/M	3/4-10 x 2-1/2	34	5J-4773	2J-3506	5P-8248	Inspect moldboard for excess wear Ensure moldboard and new edges are free from paint and debris. Torque 3/4" Nuts to 350 +/- 45 ft. lb.				
	Specialty ³		3/4-10 x 2-3/4	34	5J-4771							
	End Bits ³		3/4-10 x 2-1/2	10	5J-4773							
	Standard Edges & Specialty ⁴	16H/M	3/4-10 x 3-1/8	20	1J-6762							
			3/4-10 x 3-3/4	14	5F-8933							
			3/4-10 x 3-1/8	4	1J-6762							
	End Bits ⁴	160H/M, 14H/M	3/4-10 x 3-3/4	6	5F-8933							
	Overlays		3/4-10 x 3-3/4	8	5F-8933							
	Front Blade		3/4-10 x 2-1/4	see above	4F-7827							
	Extension		3/4-10 x 2-1/4	4	5J-4773							
Grader Bits	Pull Ring	132-3812	1									
Grader Bits	Bearing Sleeve	562-9545	1									
Wear Protection	Moldboard Plate	16.25" Radius	385-6748	2								
Auxiliary Blade Cutting Edges												
Profile	Type	Width	Length	Qty	Hardware	Thickness				Notes		
						13mm	16mm	19mm	25mm			
Front Mount Blades	9 ft. Blade	8"	26"	2	4			4T-3010		uses 3/4" bolts 		
			56"	1	9			169-4089				
	8 ft. Blade	8"	18.2"	2	3			4T-8353				
			61.3"	1	10			4T-2315				
97" Foldable	8"	18.2"	2	3			4T-8353					
		78.8"	1	13			4T-8378					
2' Extension ¹	Curved	8"	24"	1	4		3G-2166	3G-2165	LH: (281-9455) RH: (456-4448)			
Rippers / Scarifiers												
Adapter Size	Shanks		Protectors		Tips			Pin	Retainer	Misc		
	Type	Part Number	Std.	Sharp	Type	Std	A.R.M.					
Rear Mount R300 ²	Straight	9J-6586	-	-	Penetration	6Y-0309	168-1309	136-8308	114-0359	Repair Nose 8E-7300		
	Curved	9J-8913	-	-	Sharp	9W-7309						
Rear Mount R350 ⁴	Straight	484-8282	138-0796	-	Pin-On	Penetration	6Y-0359	159-0356	114-0358	114-0359	Repair Nose 8E-7350	
				-		Centerline	6Y-0352	159-0355				
				-		CapSure	Penetration	472-0825	-	473-3816		-
				-			Centerline	472-0824	-			
Scarifier V-Block ⁵	Standard	195-7218	Don't see what you need? Ask about our MAO program.	-	General Purpose	195-7234		5K-1459	5K-1458	Tip Removal Tool 6B-3260		
	Long	7D-4501			High Temp	6Y-5230	143-3074					
Scarifier Straight Block ⁶	Standard	195-7219	-	-	General Purpose	195-7234		5K-1459	5K-1458	Tip Removal Tool 6B-3260		
	Long				High Temp	6Y-5230	143-3074					







¹Used on 160H, 160M
²Used on 160H, 160M, 14H, 14M
³Used on 16H, 16M

⁴Front Notched
⁵Rear Notched
⁶Single Bevel

18' Blades

Machine Models: 18M, 18

3/4" Bolt Holes

Moldboard Cutting Edges																			
Profile	Type	Width Tooth X Gap (mm)	Length	Qty	Hardware	Thickness				End Bits	Hard- ware	Overlay	Hardware						
						19mm	25mm	35mm	45mm										
Curved	Standard	8"	6'	3	13		4T-2231				5	6Y-2805	4						
	Std. A.R.M.	8"	6'	3	13		554-0852												
	Serrated	8" - 62X40	6'	3	13		521-2870												
	Serr. A.R.M.	8" - 62X40	6'	3	13		554-0853												
Flat	Standard	8"	6'	3	13		7T-3493				5	N/A	N/A						
		10"					4T-6502	440-5352	521-2871										
	13"			521-2872	521-2873														
	Std. A.R.M.	13"	6'	3	13														
	Serrated	10" - 62X40	6'	3	13			521-2874	521-2875										
Serr. A.R.M.	10" - 62X40	6'	3	13			554-0850												
Carbide Edges																			
Curved	Tungsten Carbide	4.75"	2'	6	5	208-8863					5	135-9369	4						
			3'	4	7	217-4698													
		6.75"	2'	6	5	195-7266													
			3'	4	7	195-7267													
	Tung. Carbide Serrated	6.75" - 62X40	2'	6	5		208-8865												
		6.75" - 62X40	3'	4	7		217-4697*												
Flat	Tung. Carbide	6"	3'	4	5	330-9491													
Specialty																			
Rotating Bit System																			
Type	Width	Length	Qty	Hard- ware	Adapter Board	Bits per Board	Shank Size	Bits	Notes										
Rotating Bit	5.9"	3'	6	7	307-2613	21	7/8"	571-0532											
	7.2"	3'	6	7	323-1251	21	1"	571-0533											
Grader Bit System																			
Type	Part Number	Name	Length	Hardware	Bits per Board	Adapters per Moldboard	Bit Part Number	Bit Part Name	Width (mm)	Notes									
Grader Bit	552-8520	Left Hand Adapter Board	2'	5	10	3	552-8524	Penetration Bit	15		552-8524	552-8525	552-8526	552-8527					
							552-8525	Sharp Bit	20										
							552-8526	Standard Bit	30										
							552-8527	Wide Bit	60										
	552-8521	2' Center Adapter Board	2'	4	10	3	552-8528	Standard Mining Bit	30							552-8528	552-8529	560-8840	563-1186
							552-8529	Wide Mining Bit	60										
	552-8523	Right Hand Adapter Board	2'	4	10	3	560-8840	SnowBit	60										
							563-1186	BoreSaver	-										
Type	Part Number				Angle				Length	Quantity									
Angling Plate	552-9410				0°				1'	18									
	552-9411				5°														
	552-9412				10°														
	552-9413				15°														
	552-9414				20°														
	552-9415				25°														
552-9416				30°															
Hardware and Wear Protection																			
Type	Application	Hardware			Quantity	Bolts	Nuts	Washers	Notes										
Hardware	Standard Edges ¹	Bolts	3/4-10 x 3-1/8	21	1J-6762	2J-3506	5P-8248	Inspect moldboard for excess wear. Ensure moldboard and new edges are free from paint and debris. Torque 3/4" Nuts to 350 +/- 45 ft. lb.											
	Specialty		3/4-10 x 3-3/4	18	5F-8933														
	End Bits ²		3/4-10 x 3-3/4	36	5F-8933														
	Overlays		3/4-10 x 3-1/8	4	1J-6762														
			3/4-10 x 3-3/4	6	5F-8933														
	Grader Bits		Pull Ring	132-3812	1														
Grader Bits	Bearing Sleeve	562-9545	1																
Wear Protection	Moldboard Plate	16.7" Radius	(136-2541)	1															

18' Blades

Machine Models: 18M, 18

3/4" Bolt Holes

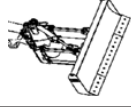
Auxiliary Blade Cutting Edges											
Profile	Type	Width	Length	Qty	Hardware	Thickness				Notes	
						13mm	16mm	19mm	25mm		
Front Mount Blades	9 ft Blade	8"	26" 56"	2 1	4 9			4T-3010 169-4089		uses 3/4" bolts 	
	8 ft Blade	8"	18.2" 61.3"	2 1	3 10			4T-8353 4T-2315			
	9'7" Foldable	8"	18.2" 78.8"	2 1	3 13			4T-8353 4T-8378			
Rippers / Scarifiers											
Adapter Size	Shanks		Protectors		Tips			Pin	Retainer	Misc	
	Type	Part Number	Std.	Sharp	Type	Std	A.R.M.				
Rear Mount R350	Straight	484-8282	138-0796	-	Pin-On	Penetration	6Y-0359	159-0356	114-0358	114-0359	Repair Nose 8E-7350
				-		Centerline	6Y-0352	159-0355			
				-	CapSure	Penetration	472-0825	-	473-3816	-	
				-		Centerline	472-0824	-		-	

¹The middle 21 bolt holes use bolt 1J-6762 the outside 9 on each side of the moldboard use bolts 5F-8933

²The top two bolt holes of each end bit use bolt 1J-6762 the bottom three bolt holes of each end bit use bolt 5F8933

³Multiple tooth spacing options available

24' Blades

Machine Models: 24H, 24M, 24

1" Bolt Holes

Moldboard Cutting Edges														
Profile	Type	Width Tooth X Gap (mm)	Length	Qty	Hardware	Thickness				End Bits	Hardware	Overlay	Hardware	
						28mm	45mm	60mm	75mm					
Flat	Standard	13"	4'	6	9	109-3117	109-3116	132-1019		109-3118	6	N/A	N/A	
		16"		3		17	135-9690	138-6440	135-9349					135-9576
	Std. A.R.M.	13"	4'	6	9			(484-2302)						
		16"	4'	6	9			559-1162						
	Serrated	13" - 61X40	4'	6	9			438-1337	286-2022					
		16" - 61X41						138-6542	132-4753					
		16" - 83X51							135-9796					135-9797
		16" - 101.6X51							356-0889*					
		16" - 140X64							365-5079					
	Serr. A.R.M.	16" - 95X57	8'	3	18				424-7737					
	16" - 101.6X51	4'	6	9			365-5083							
Specialty														
Type	Bit Spacing	Width	Length	Qty	Hardware	Adapter Board	Bits per Board	Bits 40mm	Notes					
Mining Bit	Wide Gap	7.75"	3'	8	7	178-4095	10	357-9643						
Rippers / Scarifiers														
Adapter Size	Shanks		Protectors	Tips			Pin	Retainer	Misc.					
	Type	Part Number	Standard	Type	Std	A.R.M.								
Rear Mount R350	Straight	484-8282	138-0796	Pin-On	Penetration	6Y-0359	159-0356	114-0358	114-0359	Repair Nose 8E-7350				
					Centerline	6Y-0352	159-0355							
				CapSure	Penetration	472-0825	-	473-3816	-					
					Centerline	472-0824	-		-					
Hardware and Wear Protection														
Type	Application	Hardware		Quantity	Bolts	Nuts	Washers	Notes						
Hardware	Edges	Bolts	1-8 x 4-1/2	10	1J-3527	2J-3507	5P-8250	Torque 1" nuts to 850 +/- 110 ft. lb.						
	End Bits	Bolts	1-8 x 3-1/4	44	4J-9058									
	Specialty	Bolts	1-8 x 4-1/2	12	1J-3527									
	Grader Bits	Pull Ring		1				Part Number - 132-3812						
	Grader Bits	Bearing Sleeve		1				Part Number - 562-9545						
Wear Protection	Moldboard Plate	21.65" Radius	139-2404	1										

CAT® GROUND ENGAGING TOOL PLOW BOLT/NUT TORQUE SPECIFICATIONS

PLOW BOLT DIAMETER	NUT PART NUMBER	TORQUE REQUIREMENT
16 mm / 5/8" (.63")	4K0367	200 ± 30 ft. lbs. 270 ± 40 Nm
19 mm / 3/4" (.75")	2J3506	350 ± 45 ft. lbs. 475 ± 60 Nm
22 mm / 7/8" (.88")	2J3505	550 ± 65 ft. lbs. 750 ± 90 Nm
25 mm / 1" (1.00")	2J3507	850 ± 110 ft. lbs. 1150 ± 150 Nm
32 mm / 1-1/4" (1.25")	3K9770	1700 ± 220 ft. lbs. 2300 ± 300 Nm

DO NOT APPLY LUBRICANT OF ANY TYPE TO G.E.T. HARDWARE!

1. Clean all surfaces of rust, paint, nicks, and burrs.
2. Tighten nut to listed torque spec.
3. Carefully strike plow bolt head with a hammer.
4. Retighten nut to listed torque spec.

SAFETY GLASSES MUST BE WORN WHEN STRIKING BOLT HEADS

Cat Motorgraders

TRIP EDGE CONFIGURATIONS

Machine Models: 120M, 12M, 140

12' Blade 3/4" Bolt Holes			12' Blade 5/8" Bolt Holes		
Type	Part Number	Qty	Type	Part Number	Qty
Edge As	562-4670	4	Edge As	562-4670	4
Cutting Edge	4T-2971	2	Cutting Edge	4T-2971	2
Stop As	562-4682	2	Stop As	562-4682	2
Bolt	5J-4773	46	Bolt	452-8225	24
Bolt	5J-4771	4	Full Nut	4K-0367	24
Nut	2J-3506	50	Bolt	5J-4773	20
			Bolt	5J-4771	4
			Full Nut	2J-3506	24

Machine Models: 140M, 14M, 150

14' Blade 3/4" Bolt Holes			14' Blade 5/8" Bolt Holes		
Type	Part Number	Qty	Type	Part Number	Qty
Edge As	562-4670	2	Edge As	562-4670	2
Edge As	562-4648	2	Edge As	562-4648	2
Cutting Edge	4T-2970	2	Cutting Edge	4T-2970	2
Stop As	562-4682	2	Stop As	562-4682	2
Bolt	5J-4773	54	Bolt	452-8225	28
Bolt	5J-4771	4	Full Nut	4K-0367	28
Nut	2J-3506	58	Bolt	5J-4773	24
			Bolt	5J-4771	4
			Full Nut	2J-3506	28

Machine Models: 160M, 160

16' Blade 3/4" Bolt Holes			16' Blade 5/8" Bolt Holes		
Type	Part Number	Qty	Type	Part Number	Qty
Edge As	562-4648	4	Edge As	562-4648	4
Cutting Edge	7T-3495	2	Cutting Edge	7T-3495	2
Stop As	562-4682	2	Stop As	562-4682	2
Bolt	5J-4773	62	Bolt	452-8225	32
Bolt	5J-4771	4	Full Nut	4K-0367	32
Nut	2J-3506	66	Bolt	5J-4773	28
			Bolt	5J-4771	4
			Full Nut	2J-3506	32

Cat Motorgraders

CUTTING EDGES

Part Number	Type	Part Name	Width	Length	Thick-ness	Bolt Hole Dia	Bolt Size	Wt. Kg	ARM	Material	Blade
208-8863	1C-T	EDGE AS-CARB	119.8	609.6	19	21	3/4"	9.80	NO EXCESS	NO EXCESS	
208-8862	1C-T	EDGE AS-CARB	119.8	914.4	19	18	5/8"	14.90	NO EXCESS	NO EXCESS	
217-4698	1C-T	EDGE AS-CARB	119.8	914.4	19	21	3/4"	14.90	N	N	
356-5241	1F-CI	EDGE AS	127	908.4	22	18	5/8"	18.62	N	1E1541C/APPD APRT	SNOW PLOW
349-0879	1F-CI	EDGE AS	127	908.4	22	18	5/8"	19.50	N	1E1541C, APPD PART	
356-5241	1F-CI	EDGE AS	127	908.4	22	18	5/8"	18.63	N	1E1541C, APPD PART	SNOW PLOW
198-2635	1F-CI	EDGE AS	127	914.4	19	18	5/8"	14.60	N	PPAP SUP	
283-1063	1F-CI	CUTTING EDGE	127	1213.2	19	21	3/4"	20.91	N	APPD PART	12'
286-2062*	1F-CI	EDGE AS	127	1213.2	22	18	5/8"	24.93	N	1E1541C/APPD APRT	SNOW PLOW
349-0883	1F-CI	EDGE AS	127	1213.2	22	18	5/8"	26.10	N	1E1541C, APPD PART	
356-5242	1F-CI	EDGE AS	127	1213.2	22	18	5/8"	24.94	N	1E1541C, APPD PART	SNOW PLOW
198-2659	1F-CI	EDGE AS	127	1219.2	19	18	5/8"	19.50	N	PPAP SUP	
351-8479	1F-CI	EDGE AS	127	1518	19	18	5/8"	27.17	N	1E1541C, APPD PART	
217-4695	1C-T	EDGE AS-CARB	151.5	609.6	19	18	5/8"	9.80	N	N	
109-3137	1C	CUTTING EDGE	152	607.2	15.9	18	5/8"	14.04	N	1E2197	
232-2146	1C	CUTTING EDGE	152.4	607	15.9	21	3/4"	10.00	N	1E2195	
9W-1835	1C	CUT EDGE	152.4	607.2	15.9	18	5/8"	9.80	N	1E2195	
275-2478	1F-CI	CUTTING EDGE	152.4	908.4	19	18	5/8"	18.74	N	APPD PART	
360-9784*	1F-CI	EDGE AS	152.4	908.4	19	18	5/8"	18.58	N	1E1541C, APPD PART	
382-9300	1F-D	EDGE AS	152.4	908.4	19	18	5/8"	19.66	N	1E 1541C, APPD PART	no top bevel
330-9491	1F-CI	EDGE AS	152.4	908.4	19	21	3/4"	19.60	N	1E1541C, APPD PART	
375-0253	1F-CI	EDGE AS	152.4	908.4	19	21	3/4"	18.56	N	1E1541C, APPD PART	
394-2429*	1F-CI-D	EDGE AS-CARB	152.4	911.5	19	18	5/8"	21.67	N	1E1541C,APPD PART	no bevel
354-8411*	1F-CI	EDGE AS	152.4	1035.4	19	18	5/8"	22.52	N	1E1541C, APPD PART	
264-2215	1F-CI	EDGE AS	152.4	1213.2	19	18	5/8"	25.07	N	PPAP PART	
360-9782*	1F-CI	EDGE AS	152.4	1213.2	19	18	5/8"	24.84	N	1E1541C, APPD PART	
382-9299	1F-D	EDGE AS-CARB	152.4	1213.2	19	18	5/8"	25.07	N	1E1541C, APPD PART	no top bevel
286-3148	1F-CI	CUTTING EDGE	152.4	1213.2	19	21	3/4"	25.50	N	APPD PART	
399-2795*	1F-CI	EDGE AS	152.4	1213.2	19	21	3/4"	24.83	N	1E1541C,APPD PART	
346-6704	1F-CI	EDGE AS	152.4	1213.2	22	18	5/8"	28.73	N	1E1541C, APPD PART	TRUCK PLOW
3G-8016	1C	EDGE	152.4	1216.8	12.7	18	5/8"	15.42	N	1E2394	
9W-2325*	1C-HC	CUTTING EDGE	152.4	1216.8	15.9	18	5/8"	23.15	N	1E2695	
9W-2326*	1C-HC	CUTTING EDGE	152.4	1216.8	15.9	21	3/4"	23.15	N	1E2695	
373-9282	1F-CI-D	EDGE AS	152.4	1219.2	19	18	5/8"	29.02	N	1E1541C, APPD PART	no top bevel
388-8957*	1F-CI	EDGE AS	152.4	1518	19	18	5/8"	32.92	N	1E1541C, APPD PART	
399-2794*	1F-CI	EDGE AS	152.4	1518	19	21	3/4"	31.08	N	1E1541C, APPD PART	
356-5781	1C	CUTTING EDGE	152.4	1518	19.1	18	5/8"	32.00	N	1E0679	
9J-3862	1C	CUTTING EDGE	152.4	1521.6	12.7	18	5/8"	19.32	N	1E2394	
9W-2295	1C-HC	CUTTING EDGE	152.4	1521.6	12.7	18	5/8"	23.15	N	1E2693	
7D-4508	1C	CUTTING EDGE	152.4	1521.6	15.9	18	5/8"	24.50	N	1E2195	
7T-1640	1C-HC	CUTTING EDGE	152.4	1521.6	15.9	18	5/8"	24.46	N	1E2695	
394-2428*	1F-CI-D	EDGE AS-CARB	152.4	1521.6	19	18	5/8"	36.27	N	1E1541C, APPD PART	no bevel

Part Number	Type	Part Name	Width	Length	Thick-ness	Bolt Hole Dia	Bolt Size	Wt. Kg	ARM	Material	Blade
3G-7966	1C	EDGE	152.4	1521.6	19	18	5/8"	26.40	N	1E2196	
314-7608*	1C	CUTTING EDGE	152.4	1822.8	19.1	18	5/8"	38.44	N	1E0679	
8D-2786	1C	CUTTING-EDGE	152.4	1826.4	12.7	18	5/8"	23.49	N	1E2394	12', 13'
9W-2297	1C-HC	CUTTING EDGE	152.4	1826.4	12.7	18	5/8"	27.80	N	1E2693	12', 13'
5D-9553	1C	EDGE	152.4	1826.4	15.9	18	5/8"	29.93	N	1E2195	12'
7T-1633	1C-HC	CUTTING EDGE	152.4	1826.4	15.9	18	5/8"	29.33	N	1E2695	12', 13'
7T-1637	1C-HC	CUTTING EDGE	152.4	1826.4	15.9	21	3/4"	29.22	N	1E2695	12'
9J-3657	1C	CUTTING EDGE	152.4	1826.4	15.9	21	3/4"	29.50	N	1E2195	12'
5D-9556	1C	EDGE	152.4	1826.4	19	18	5/8"	35.38	N	1E2195	12'
317-0995*	1C	CUTTING EDGE	152.4	2127.6	19.1	18	5/8"	44.88	N	1E0679	
8D2787	1C	CUTTING-EDGE	152.4	2131.2	12.7	18	5/8"	26.30	N	1E2394	13'
9W-2299	1C-HC	CUTTING EDGE	152.4	2131.2	12.7	18	5/8"	32.50	N	1E2693	
9J-3659	1C	CUTTING EDGE	152.4	2131.2	12.7	21	3/4"	2.72	N	1E2394	
9W-2300	1C-HC	CUTTING EDGE	152.4	2131.2	12.7	21	3/4"	32.50	N	1E2693	
5D-9554	1C	EDGE	152.4	2131.2	15.9	18	5/8"	34.50	N	1E2195	14'
7T-1645	1C-HC	CUTTING EDGE	152.4	2131.2	15.9	18	5/8"	34.92	N	1E2695	13', 14'
7T-1626	1C-HC	CUTTING EDGE	152.4	2131.2	15.9	21	3/4"	34.12	N	1E2695	14'
9J-3658	1C	CUTTING EDGE	152.4	2131.2	15.9	21	3/4"	34.00	N	1E2195	14'
5D-9557	1C	EDGE	152.4	2131.2	19	18	5/8"	41.73	N	1E2195	14'
4Z-8785	1C	EDGE	152.4	2131.2	19	21	3/4"	41.70	N	1E2196	
8J-7782	1C	EDGE	152.4	2436	12.7	18	5/8"	29.48	N	1E2394	
9W-2301	1C-HC	CUTTING EDGE	152.4	2436	12.7	18	5/8"	37.00	N	1E2693	
9J-3656	1C	EDGE	152.4	2436	12.7	21	3/4"	31.75	N	1E2394	
9W-2302*	1C-HC	CUTTING EDGE	152.4	2436	12.7	21	3/4"	37.00	N	1E2693	
7T-1632	1C-HC	CUTTING EDGE	152.4	2436	15.9	18	5/8"	39.18	N	1E2695	
8J-4043	1C	EDGE	152.4	2436	15.9	18	5/8"	39.50	N	1E2195	
9J-3655	1C	CUTTING EDGE	152.4	2436	15.9	21	3/4"	39.50	N	1E2195	
388-7243*	1F-D	CUTTING EDGE	152.4	2436	19	18	5/8"	54.65	N	1E1996	no bevel
4Z-8968*	1C-HC	EDGE	152.4	2740.8	12.7	18	5/8"	353.50	NO EXCESS	1E2693	
9W-2303	1C-HC	CUTTING EDGE	152.4	3045.6	12.7	18	5/8"	46.35	N	1E2693	
9W-2304	1C-HC	CUTTING EDGE	152.4	3045.6	12.7	21	3/4"	46.35	N	1E2693	
9W-2305	1C-HC	CUTTING EDGE	152.4	3655.2	12.7	18	5/8"	55.60	N	1E2693	
9W-2307	1C-HC	CUTTING EDGE	152.4	4264.8	12.7	18	5/8"	64.85	N	1E2693	
208-8864	1C-T	EDGE AS-CARB	170.2	609.6	25.4	18	5/8"	17.01	NO EXCESS	NO EXCESS	
208-8865	2C-T	EDGE AS-CARB	170.2	609.6	25.4	21	3/4"	17.01	NO EXCESS	NO EXCESS	
217-4696	2C-T	EDGE AS-CARB	170.2	914.4	25.4	18	5/8"	25.75	N	N	
217-4697*	2C-T	EDGE AS-CARB	170.2	914.4	25.4	21	3/4"	25.70	N	N	
195-7265	1C-T	EDGE AS	172	609.6	19	18	5/8"	14.90	N	N	
195-7266	1C-T	EDGE AS	172	609.6	19	21	3/4"	14.81	N	N	12'
195-7264	1C-T	EDGE AS	172	914	19	18	5/8"	22.40	N	N	
195-7267	1C-T	EDGE AS	172	914.4	19	21	3/4"	22.30	N	N	12'
217-4699	1C-T	EDGE AS-CARB	172	914.4	19	21	3/4"	22.52	N	N	
208-8866	1C-T	EDGE AS-CARB	172	1219.2	19	21	3/4"	30.10	NO EXCESS	NO EXCESS	

Cat Motorgraders

CUTTING EDGES

Part Number	Type	Part Name	Width	Length	Thick-ness	Bolt Hole Dia	Bolt Size	Wt. Kg	ARM	Material	Blade
107-3430*	1F	CUTTING EDGE	202.9	3350.1	19	18	5/8"	93.37	NO EXCESS	NO EXCESS	
132-1011	1F	EDGE	202.9	3655.1	15.9	18	5/8"	83.42	N	1E0427	
7T-3600	2F	CUTTING EDGE	203	1216.8	25.4	21	3/4"	37.00	N	1E2563	12'
7T-3497	1F	CUTTING EDGE	203	1521.6	25.4	18	5/8"	61.70	N	1E2563	
7T-3601	2F	CUTTING EDGE	203	1521.6	25.4	21	3/4"	46.30	N	1E2563	
369-1483	1F-D	CUTTING EDGE	203	1522.6	19	18	5/8"	45.64	N	1E1996	no bevel
314-7609	1C-D	CUTTING EDGE	203	1822.8	18.7	18	5/8"	52.71	N	1E0679	SNOW PLOW
7T-3499	1F	CUTTING EDGE	203	1826.4	25.4	18	5/8"	74.00	N	1E2563	12', 13'
7T-3493	1F	CUTTING EDGE	203	1826.4	25.4	21	3/4"	74.00	N	1E2563	12'
369-1481	1F-D	CUTTING EDGE	203	1827.4	19	18	5/8"	54.65	N	1E1996	no bevel
7T-3498	1F	CUTTING EDGE	203	2131.2	25.4	18	5/8"	78.90	N	1E2563	13' 14'
7T-3494	1F	CUTTING EDGE	203	2131.2	25.4	21	3/4"	89.60	N	1E2563	14'
369-1488	1F-D	CUTTING EDGE	203	2132.2	19	18	5/8"	63.95	N	1E1996	no bevel
7T-3496	1F	CUTTING EDGE	203	2436	25.4	18	5/8"	98.70	N	1E2563	
7T-3495	1F	CUTTING EDGE	203	2436	25.4	21	3/4"	93.00	N	1E2563	16'
369-1482*	1F-D	CUTTING EDGE	203	2437	19	18	5/8"	72.97	N	1E1996	no bevel
384-0961*	1F-D	CUTTING EDGE	203	2741	19	18	5/8"	82.19	N	1E1996	no bevel
377-9854	1F-D	CUTTING EDGE	203	3351.4	19	18	5/8"	100.50	N	1E1995	no bevel
3G-2166	1C	EDGE CUTTING	203.2	607.2	15.9	21	3/4"	13.88	N	1E2197	
6G-8623	1C	EDGE-CUTTING	203.2	607.2	19	18	5/8"	16.46	N	1E2198	
3G-2165	1C	EDGE CUTTING	203.2	607.2	19	21	3/4"	16.78	N	1E2198	
346-6329	1F-CI	EDGE AS	203.2	908.4	22	18	5/8"	29.44	N	1E1541C, APPD PART	TRUCK PLOW
264-2204*	2C	CUTTING EDGE	203.2	908.4	25.4	21	3/4"	29.70	N	1E2565	
399-2792*	2C	EDGE-CUTTING	203.2	908.4	25.4	21	3/4"	27.24	N	1E2565	
4Z-8129	1F	EDGE-CUSTOM	203.2	911.4	19	18	5/8"	25.40	NO EXCESS	1E0471	
253-0215*	1C	EDGE-CUTTING	203.2	911.5	25.1	21	3/4"	34.40	N	1E2565	12'
253-0217	2C	CUTTING EDGE-SERRATED	203.2	911.5	25.4	21	3/4"	26.53	N	1E2565	12'
195-7260	1F-T	EDGE AS	203.2	912	19	18	5/8"	22.19	N	N	
399-2789*	2C	EDGE-CUTTING	203.2	1213.2	19	18	5/8"	26.31	N	1E2198	
311-7676*	2C	CUTTING EDGE	203.2	1213.2	19	18	5/8"	25.11	N	1E2198	
346-6328	1F-CI	EDGE AS	203.2	1213.2	22	18	5/8"	39.36	N	1E1541C, APPD PART	TRUCK PLOW
311-7677*	2C	CUTTING EDGE	203.2	1213.2	25.4	18	5/8"	33.89	N	1E2565	
274-1360*	2C	CUTTING EDGE	203.2	1213.2	25.4	21	3/4"	39.73	N	1E2565	
4Z-8119	1F	EDGE-CUSTOM	203.2	1216.3	19	18	5/8"	33.95	NO EXCESS	1E0471	
135-9692	1F	CUTTING EDGE	203.2	1216.7	25.4	18	5/8"	45.70	N	1E2563	
3G-7965	1C	EDGE	203.2	1216.8	12.7	18	5/8"	22.68	N	1E2395	
9W-2309*	1C-HC	EDGE CUTTING	203.2	1216.8	12.7	18	5/8"	21.96	N	1E2694	
135-6738	1C	CUTTING EDGE	203.2	1216.8	12.7	21	3/4"	22.68	N	1E2395	
132-1088	1C	EDGE AS	203.2	1216.8	15.9	18	5/8"	28.22	N	1E2197	
134-1773	1C	CUTTING EDGE	203.2	1216.8	15.9	21	3/4"	27.85	N	1E2197	
134-1773	1C-HC	CUTTING EDGE	203.2	1216.8	15.9	21	3/4"	30.90	N	1E2697	
132-1087	2C	CUTTING EDGE	203.2	1216.8	19	18	5/8"	28.20	N	1E2198	

Part Number	Type	Part Name	Width	Length	Thick-ness	Bolt Hole Dia	Bolt Size	Wt. Kg	ARM	Material	Blade
195-7262	1F-T	EDGE AS	203.2	1216.8	19	18	5/8"	29.60	N	N	
8D-3428	2C	EDGE	203.2	1216.8	19	18	5/8"	24.95	N	1E2198	
109-3124	1C	CUTTING EDGE	203.2	1216.8	19	21	3/4"	34.03	N	1E2198	
8J-8255	2C	EDGE	203.2	1216.8	19	21	3/4"	23.59	N	1E2198	
253-0218*	2C	CUTTING EDGE-SERRATED	203.2	1216.8	25.4	18	5/8"	35.55	N	1E2565	
109-3150	1C	CUTTING EDGE	203.2	1216.8	25.4	21	3/4"	45.91	N	1E2565	
217-4819*	2C	EDGE	203.2	1216.8	25.4	21	3/4"	35.00	N	1E2565	
4T-3512	2C	CUTTING EDGE	203.2	1216.8	25.4	21	3/4"	39.85	N	1E2565	
352-0648	1F	CUTTING EDGE	203.2	1518	18.7	18	5/8"	43.89	N	1E0679	
350-7193	2F	CUTTING EDGE	203.2	1518	19	18	5/8"	31.80	N	1E0471	
4Z-8120	1F	EDGE-CUTTING	203.2	1521	15.9	21	3/4"	35.27	N	1E0427	
4T-3511	2C	CUTTING EDGE	203.2	1521.1	25.4	21	3/4"	49.80	N	1E2565	
346-3285	1C	CUTTING EDGE	203.2	1521.3	15.9	21	3/4"	35.09	N	1E2197	
9J-3863	1C	CUTTING EDGE	203.2	1521.6	12.7	18	5/8"	27.76	N	1E2395	
9W-2311*	1C-HC	EDGE CUTTING	203.2	1521.6	12.7	18	5/8"	26.50	N	1E2694	
134-1779	1C	CUTTING EDGE	203.2	1521.6	12.7	21	3/4"	24.48	N	1E2395	
9W-2312*	1C-HC	EDGE CUTTING	203.2	1521.6	12.7	21	3/4"	27.40	N	1E2694	
7D-4509	1C	CUTTING EDGE	203.2	1521.6	15.9	18	5/8"	35.40	N	1E2197	
7D-4509	1C-HC	CUTTING EDGE	203.2	1521.6	15.9	18	5/8"	34.01	N	1E2697	
9W-2330	1C-HC	CUTTING EDGE	203.2	1521.6	15.9	21	3/4"	38.60	N	1E2697	
4T-2967	1F	CUTTING EDGE	203.2	1521.6	16	18	5/8"	35.10	N	1E0427	
4T-3034	1F	CUTTING EDGE	203.2	1521.6	19	18	5/8"	42.50	N	1E0471	
8D-3429	2C	EDGE	203.2	1521.6	19	18	5/8"	28.12	N	1E2198	
9W-6252	1C	CUTTING EDGE	203.2	1521.6	19	18	5/8"	46.25	N	1E2198	
4Z-8131	1C	EDGE-CUTTING	203.2	1521.6	19	21	3/4"	43.09	NO EXCESS	1E2198	Reinstated
8J-8256	2C	EDGE	203.2	1521.6	19	21	3/4"	28.12	N	1E2198	
4Z-8131	1C-HC	EDGE CUTTING	203.2	1521.6	19	21	3/4"	43.54	N	1E2698	
4T-2240	1C	CUTTING EDGE	203.2	1521.6	25.4	18	5/8"	55.40	N	1E2565	
311-7678*	2C	CUTTING EDGE	203.2	1822.8	19	18	5/8"	37.74	N	1E2198	12'
350-0179	2F	EDGE-CUTTING	203.2	1822.8	19	18	5/8"	43.32	N	1E0471	12'
420-2054*	1F	EDGE CUTTING	203.2	1822.8	19	18	5/8"	56.00	Y	1E0471	12'
399-2791*	2C	EDGE-CUTTING	203.2	1822.8	19	21	3/4"	44.52	N	1E2198	
8D-2788	1C	CUTTING-EDGE	203.2	1826.4	12.7	18	5/8"	41.73	N	1E2395	12', 13'
9W-2313	1C-HC	EDGE CUTTING	203.2	1826.4	12.7	18	5/8"	33.64	N	1E2694	12', 13'
5D-9562	1C	CUTTING EDGE	203.2	1826.4	15.9	18	5/8"	48.20	N	1E2197	12', 13'
7T-1636	1C-HC	CUTTING EDGE	203.2	1826.4	15.9	18	5/8"	41.90	N	1E2697	12', 13'
7T-1639	1C-HC	CUTTING EDGE	203.2	1826.4	15.9	21	3/4"	41.79	N	1E2697	12'
9J-7701	1C	EDGE	203.2	1826.4	15.9	21	3/4"	42.30	N	1E2197	12'
4T-2968	1F	CUTTING EDGE	203.2	1826.4	16	18	5/8"	42.10	N	1E0427	12', 13'
4T-2971	1F	CUTTING EDGE	203.2	1826.4	16	21	3/4"	42.10	N	1E0427	12'
132-1072	2C	EDGE	203.2	1826.4	19	18	5/8"	37.54	N	1E2198	12', 13'
217-4815*	2C	EDGE	203.2	1826.4	19	18	5/8"	44.70	N	1E2198	12', 13'

Cat Motorgraders

CUTTING EDGES

Part Number	Type	Part Name	Width	Length	Thick-ness	Bolt Hole Dia	Bolt Size	Wt. Kg	ARM	Material	Blade
217-4832*	2C	EDGE	203.2	1826.4	19	18	5/8"	39.80	N	1E2198	12'
5D-9558	1C	EDGE	203.2	1826.4	19	18	5/8"	50.34	N	1E2195	12', 13'
7T-1634	1C-HC	CUTTING EDGE	203.2	1826.4	19	18	5/8"	51.92	N	1E2698	12'
4T-3033	1F	CUTTING EDGE	203.2	1826.4	19	21	3/4"	52.16	N	1E0471	12'
7D-1576	1C	CUTTING EDGE	203.2	1826.4	19	21	3/4"	46.72	N	1E2198	12'
7T-1638	1C-HC	CUTTING EDGE	203.2	1826.4	19	21	3/4"	51.78	N	1E2698	
521-2870	2C	EDGE-CUTTING (SERRATED)	203.2	1826.4	25	21	3/4"	53.51	N	1E2565	18'
554-0853	2C	EDGE-CUTTING (SERRATED)	203.2	1826.4	25	21	3/4"	57.99	BASE 5212870	1E2565	18'
4T-2231	1C	CUTTING EDGE	203.2	1826.4	25.4	21	3/4"	65.90	N	1E2565	12'
554-0852	1C	CUTTING EDGE	203.2	1826.4	25.4	21	3/4"	73.74	BASE 4T2231	1E2565	18'
4T-3007	1F	CUTTING EDGE	203.2	1826.9	19	18	5/8"	53.52	ARM 3500179	1E0471	12', 13'
4T-2244	1C	CUTTING EDGE	203.2	1826.9	25.4	18	5/8"	68.20	N	1E2565	12', 13'
333-2818	1F	CUTTING EDGE	203.2	2127.6	18.7	18	5/8"	61.54	N	1E0679	
286-2058*	1F	CUTTING EDGE ARM	203.2	2127.6	19	18	5/8"	66.76	BASE?	1E0471	
283-1068	2C	CUTTING EDGE	203.2	2127.6	19	21	3/4"	45.56	N	1E2198	14'
286-2016	2C	CUTTING EDGE	203.2	2127.6	19	21	3/4"	47.05	N	1E2198	14'
350-0180	2F	CUTTING EDGE	203.2	2127.6	19	21	3/4"	49.16	N	1E0471	14'
399-2788*	2C	EDGE-CUTTING	203.2	2127.6	19	21	3/4"	51.97	N	1E2198	
350-7200	2C	CUTTING EDGE	203.2	2127.6	19.1	21	3/4"	49.37	N	1E2198	14'
350-0181	2F	CUTTING EDGE	203.2	2127.6	20	18	5/8"	49.36	BASE 4T3036?	1E0471	13', 14'
274-3709*	2C	CUTTING EDGE	203.2	2127.6	25.4	18	5/8"	69.95	N	1E2565	13', 14'
399-2790*	2C	EDGE-CUTTING	203.2	2127.6	25.4	18	5/8"	70.31	N	1E2565	13', 14'
311-7674*	2C	CUTTING EDGE	203.2	2127.6	25.4	21	3/4"	70.52	N	1E2565	14'
350-7201	2C	CUTTING EDGE	203.2	2127.6	25.4	21	3/4"	64.70	BASE 4T2233?	1E2565	14'
8D-2789	1C	CUTTING-EDGE	203.2	2131.2	12.7	18	5/8"	38.20	N	1E2395	13'
9W-2315	1C-HC	EDGE CUTTING	203.2	2131.2	12.7	18	5/8"	39.09	N	1E2694	13'
3G-1627	1C	EDGE CUTTING	203.2	2131.2	12.7	21	3/4"	39.46	N	1E2395	
9W-2316	1C-HC	EDGE CUTTING	203.2	2131.2	12.7	21	3/4"	39.09	N	1E2694	
5D-9561	1C	CUTTING EDGE	203.2	2131.2	15.9	18	5/8"	49.50	N	1E2197	13', 14'
7T-1643	1C-HC	CUTTING EDGE	203.2	2131.2	15.9	18	5/8"	47.71	N	1E2697	13', 14'
7D-1158	1C	CUTTING EDGE	203.2	2131.2	15.9	21	3/4"	47.49	N	1E2197	14'
7T-1624	1C-HC	CUTTING EDGE	203.2	2131.2	15.9	21	3/4"	48.77	N	1E2697	14'
4T-2969	1F	CUTTING EDGE	203.2	2131.2	16	18	5/8"	49.00	N	1E0427	13', 14'
4T-2970	1F	CUTTING EDGE	203.2	2131.2	16	21	3/4"	49.20	N	1E0427	14'
217-4818*	2C	EDGE	203.2	2131.2	19	18	5/8"	52.20	N	1E2198	14'
217-4829*	2C	EDGE	203.2	2131.2	19	18	5/8"	46.50	N	1E2198	14'
4Z-9020	2C	EDGE	203.2	2131.2	19	18	5/8"	50.00	N	1E2198	13', 14'
5D-9559	1C	EDGE	203.2	2131.2	19	18	5/8"	58.06	N	1E2195	13', 14'
7T-1623	1C-HC	CUTTING EDGE	203.2	2131.2	19	18	5/8"	60.60	N	1E2698	14'
217-4820*	2C	EDGE	203.2	2131.2	19	21	3/4"	45.40	N	1E2198	14'
217-4833	2C	EDGE	203.2	2131.2	19	21	3/4"	46.30	N	1E2198	14'

Part Number	Type	Part Name	Width	Length	Thick-ness	Bolt Hole Dia	Bolt Size	Wt. Kg	ARM	Material	Blade
4T-3032	1F	CUTTING EDGE	203.2	2131.2	19	21	3/4"	58.96	N	1E0471	14'
7D-1577	1C	CUTTING EDGE	203.2	2131.2	19	21	3/4"	58.96	N	1E2198	14'
7T-1625	1C-HC	CUTTING EDGE	203.2	2131.2	19	21	3/4"	60.44	N	1E2698	14'
217-4823*	2C	EDGE	203.2	2131.2	25.4	18	5/8"	61.60	N	1E2565	13', 14'
4T-2242	1C	CUTTING EDGE	203.2	2131.2	25.4	18	5/8"	79.10	N	1E2565	13', 14'
4T-2233	1C	CUTTING EDGE	203.2	2131.2	25.4	21	3/4"	80.00	N	1E2565	14'
4T-3036	1F	CUTTING EDGE	203.2	2131.7	19	18	5/8"	59.60	N	1E0471	13', 14'
317-0997	1F	CUTTING EDGE	203.2	2432.4	18.7	18	5/8"	70.37	N	1E0679	
330-4427*	2C	CUTTING EDGE	203.2	2432.4	19.1	21	3/4"	49.93	N	1E2198	16'
350-7202	1C	CUTTING EDGE	203.2	2432.4	19.1	21	3/4"	56.41	BASE 7D1949?	1E2198	16'
8J-8980	1C	EDGE	203.2	2436	12.7	18	5/8"	47.17	N	1E2395	
9W-2317	1C-HC	EDGE CUTTING	203.2	2436	12.7	18	5/8"	43.85	N	1E2694	
3G-1628	1C	EDGE CUTTING	203.2	2436	12.7	21	3/4"	42.64	N	1E2395	
5D-9731	1C	CUTTING EDGE	203.2	2436	15.9	18	5/8"	56.40	N	1E2197	
7T-1631	1C-HC	CUTTING EDGE	203.2	2436	15.9	18	5/8"	55.94	N	1E2697	
7T-1628	1C-HC	CUTTING EDGE	203.2	2436	15.9	21	3/4"	55.75	N	1E2697	
8J-9821	1C	EDGE	203.2	2436	15.9	21	3/4"	55.33	N	1E2197	
4T-2966	1F	CUTTING EDGE	203.2	2436	16	18	5/8"	56.20	N	1E0427	
4T-9603	1F	CUTTING EDGE	203.2	2436	16	21	3/4"	56.50	N	1E0427	
373-1572*	1C	CUTTING EDGE ARM	203.2	2436	18.7	21	3/4"	72.60	BASE 7D1949/7T1627	1E2198	16'
132-1073	2C	EDGE	203.2	2436	19	18	5/8"	52.50	N	1E2198	
4T-3035	1F	CUTTING EDGE	203.2	2436	19	18	5/8"	68.13	N	1E0471	
5D-9732	1C	CUTTING EDGE	203.2	2436	19	18	5/8"	56.40	N	1E2198	
7T-1630	1C-HC	CUTTING EDGE	203.2	2436	19	18	5/8"	69.33	N	1E2698	
217-4810*	2C	CUTTING EDGE-SERRATED	203.2	2436	19	21	3/4"	59.40	N	1E2198	16'
217-4821	2C	EDGE	203.2	2436	19	21	3/4"	51.90	N	1E2198	16'
217-4834	2C	EDGE	203.2	2436	19	21	3/4"	52.90	N	1E2198	16'
4T-3037	1F	CUTTING EDGE	203.2	2436	19	21	3/4"	68.13	N	1E0471	16'
7D-1949	1C	CUTTING EDGE	203.2	2436	19	21	3/4"	68.03	ARM 3731572	1E2198	16'
7T-1627	1C-HC	CUTTING EDGE	203.2	2436	19	21	3/4"	69.10	N	1E2698	16'
4T-2237	1C	CUTTING EDGE	203.2	2436	25.4	18	5/8"	90.40	N	1E2565	
217-4827*	2C	EDGE	203.2	2436	25.4	21	3/4"	71.50	N	1E2565	16'
375-9887	1C	CUTTING EDGE ARM	203.2	2436	25.4	21	3/4"	97.00	BASE 4T2236	1E2565	16'
4T-2236	1C	CUTTING EDGE	203.2	2436	25.4	21	3/4"	88.60	ARM 3759887	1E2565	16'
135-9367	1F	EDGE	203.2	2740.7	19	18	5/8"	76.20	N	1E0471	
195-7269	1F	CUTTING EDGE	203.2	2740.8	19	18	5/8"	77.30	N	1E2198	
109-2699	1F	CUTTING EDGE	203.2	3045.5	15.9	18	5/8"	70.28	N	1E0427	
135-9368	1F	EDGE	203.2	3045.5	19	18	5/8"	84.82	N	1E0471	
9W-2319*	1C-HC	EDGE CUTTING	203.2	3045.6	12.7	18	5/8"	54.82	N	1E2694	
121-9503	1F	CUTTING EDGE	203.2	3349.3	19	18	5/8"	93.84	NO EXCESS	NO EXCESS	
109-2698	1F	CUTTING EDGE	203.2	3350.3	15.9	18	5/8"	77.32	N	1E0427	

Cat Motorgraders

CUTTING EDGES

Part Number	Type	Part Name	Width	Length	Thick-ness	Bolt Hole Dia	Bolt Size	Wt. Kg	ARM	Material	Blade
140-6828	1F	CUTTING EDGE	203.2	3350.3	19	18	5/8"	93.80	N	1E0471	
327-7082*	1F	CUTTING EDGE	203.2	3655.2	16	18	5/8"	85.04	N	1E0427	
107-3431	1F	CUTTING EDGE	203.2	3655.3	19	18	5/8"	102.40	NO EXCESS	NO EXCESS	
4T-8800	2F	CUTTING EDGE	254	1216.8	25	21	3/4"	45.50	N	1E0468	
4T-8801	2F	CUTTING EDGE	254	1521.6	25	21	3/4"	56.90	N	1E0468	
4T-6502	1F	CUTTING EDGE	254	1826.4	25	21	3/4"	89.90	N	1E0468	
521-2874	2F	EDGE-CUTTING (SERRATED)	254	1826.4	35	21	3/4"	93.13	N	1E1432	18'
554-0850	2F	EDGE-CUTTING (SERRATED)	254	1826.4	35	21	3/4"	102.20	BASE 5212874	1E1432	18'
521-2871	1F	EDGE CUTTING	254	1826.4	45	21	3/4"	154.80	N	1E1648	18'
521-2875	2F	EDGE-CUTTING (SERRATED)	254	1826.4	45	21	3/4"	124.70	N	1E1648	18'
4T-6508	1F	CUTTING EDGE	254	2131.2	25	21	3/4"	105.00	N	1E0468	14'
4T-8316	1F	CUTTING EDGE	254	2131.2	35	21	3/4"	139.40	N	1E1432	14'
4Z-8055	2F	EDGE CUTTING	254	2131.3	25	21	3/4"	77.57	N	1E0468	14'
4Z-8346	2F	EDGE CUTTING	254	2131.3	35	21	3/4"	114.10	NO EXCESS	NO EXCESS	14'
350-0182	2F	CUTTING EDGE	254	2432.4	35	21	3/4"	118.60	BASE 4T8317?	1E1432	16'
350-0183	2F	CUTTING EDGE	254	2432.4	35	21	3/4"	119.20	BASE 4T8317?	1E1432	16'
350-0184	2F	CUTTING EDGE	254	2432.4	35	21	3/4"	117.40	BASE 4T8317?	1E1432	16'
357-3123	2F	CUTTING EDGE	254	2432.4	45	21	3/4"	166.00	N	1E1648	16'
552-8124	2F	CUTTING EDGE	254	2432.4	45	21	3/4"	153.70	N	1E1648	16'
554-0848	2F	CUTTING EDGE	254	2432.4	45	21	3/4"	163.40	BASE 5528124	1E1648	16'
195-7177	1F	CUTTING EDGE ARM	254	2435.9	25	21	3/4"	117.40	BASE 4T6511	1E0468	16'
4Z-8056	2F	EDGE CUTTING	254	2435.9	25	21	3/4"	95.26	NO EXCESS	NO EXCESS	16'
4T-6511	1F	CUTTING EDGE	254	2436	25	21	3/4"	120.00	ARM 3534363	1E0468	16'
100-4581	2F	EDGE	254	2436	35	21	3/4"	130.60	N	1E1432	16'
253-0198	2F	CUTTING EDGE	254	2436	35	21	3/4"	119.60	N	1E1432	16'
4T-8317	1F	CUTTING EDGE	254	2436	35	21	3/4"	159.40	N	1E1432	16'
104-3628	1F	EDGE	254	2436	45	21	3/4"	206.60	N	1E1648	16'
554-0845	1F	EDGE-CUTTING	254	2436	45	21	3/4"	222.40	BASE 1043628	1E1648	16'
104-3631	2F	EDGE	254	2436	45	21	3/4"	165.90	N	1E1648	16'
447-0348	1F	CUTTING EDGE	280	1216.8	35	21	3/4"	83.42	N	1E1662	20'
140-6790	1F	CUTTING EDGE	280	2131.2	25	21	3/4"	100.60	N	1E1169	14'
140-6832	1F-S	CUTTING EDGE	280	2436	25	21	3/4"	129.40	N	1E4062	16'
132-1086	1F	CUTTING EDGE	280	2436	35	21	3/4"	167.10	N	1E1662	16'
4Z-9188	1F	CUTTING EDGE	305	2436	35	21	3/4"	167.10	NO EXCESS	NO EXCESS	16'
109-3117	1F	CUTTING EDGE	330	1216.8	28.5	28	1"	83.40	N	1E2112	24'
109-3116	1F	CUTTING EDGE	330	1216.8	45	28	1"	133.30	N	1E1570	24'
138-6542	2F	CUTTING EDGE-SERRATED	330	1216.8	45	28	1"	95.88	0	1E1570	24'
132-1019	1F	CUTTING EDGE	330	1216.8	60	28	1"	178.90	N	1E1932	24'
559-1162	1F	CUTTING EDGE	330	1216.8	60	28	1"	189.70	BASE 1321019	1E1932	24'
132-4753	2F	CUTTING EDGE	330	1216.8	60	28	1"	144.80	N	1E1932	24'

Part Number	Type	Part Name	Width	Length	Thick-ness	Bolt Hole Dia	Bolt Size	Wt. Kg	ARM	Material	Blade
521-2872	1F	EDGE-CUTTING	330	1826.4	35	21	3/4"	156.30	N	1E2145	18'
521-2873	1F	EDGE-CUTTING	330	1826.4	45	21	3/4"	202.60	N	1E1570	18'
554-0847	1F	EDGE-CUTTING	330	1826.4	45	21	3/4"	217.40	BASE 5212873	1E1570	18'
128-2577	1F	CUTTING EDGE	330	2436	45	21	3/4"	270.40	N	1E1570	16'
554-0846	1F	CUTTING EDGE	330	2436	45	21	3/4"	290.70	BASE 1282577	1E1570	16'
134-1778	2F	CUTTING EDGE	330	2436	45	21	3/4"	235.20	N	1E1570	16'
355-5144*	1F-B	EDGE AS	390.2	1216.8	60	-	-	218.50	N	1E1541C	
135-9690	1F	CUTTING EDGE	406	1216.8	28.5	28	1"	102.00	N	1E0540	24'
138-6440	1F	CUTTING EDGE	406	1216.8	45	28	1"	163.80	ARM 3648007	1E1569	24'
365-5079	2F	CUTTING EDGE	406	1216.8	60	28	1"	178.50	N	1E1630	24'
365-5083	2F	CUTTING EDGE	406	1216.8	60	28	1"	186.90	ARM 3655079	1E1630	24'
135-9349	1F	CUTTING EDGE	406	1216.8	60	28	1"	222.40	N	1E1630	24'
135-9796	2F	CUTTING EDGE	406	1216.8	60	28	1"	186.70	N	1E1630	24'
286-2022	1F-L	EDGE-CUTTING (LEAN) (ARM)	406	1216.8	60	28	1"	231.10	BASE 1784106	1E1630	24'
356-0889*	2F	CUTTING EDGE	406	1216.8	60	28	1"	171.70	N	1E1630	24'
376-2335	2F	CUTTING EDGE	406	1216.8	60	28	1"	181.40	N	1E1630	24'
135-9576	1F	CUTTING EDGE	406	1216.8	75	28	1"	276.90	N	1E2831	24'
135-9797	2F	CUTTING EDGE	406	1216.8	75	28	1"	231.90	N	1E2831	24'
138-0675*	2F	EDGE-CUTTING (SERRATED)	406	1216.8	75	28	1"	244.40	N	1E2831	24'
424-7737	2F	EDGE-CUTTING	406	2436	75	28	1"	423.90	N	1E2831	24'
415-8009	KIT	INSTALLATION	1016	1219	238	-	-	252.50	N	N	
415-8006	KIT	INSTALLATION	1016	1219	485	-	-	1019.00	N	N	
415-8008	KIT	INSTALLATION	1016	1219	485	-	-	1323.00	N	N	

1	Standard
2	Serrated
C	Curved
F	Flat
CI	Carbide Insert
T	Tungsten Carbide
HC	High Carbon
S	Single Bevel
L	Lean
B	Chocky Bars
D	Other Shape

Discontinued
Canceled
(Reference)

Part is discontinued. Please contact your service representative.
Part is canceled. Please contact your customer service representative.
Part number is not serviceable. For reference only.

Wheel Tractor Scrapers



Cat Wheel Tractor Scrapers

OPTIONS

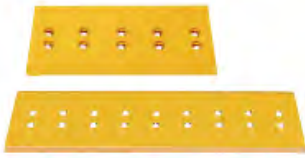

Caterpillar Offers a Complete Line of Scraper Center and End Cutting Edges

Standard center and end-cutting edges

- For use on all scraper models (open bowl, auger and elevating scraper)
- Used in low-to-medium abrasion and low-to-high impact conditions
- Available in various thicknesses and sizes for both stinger and level-cut arrangements
- Can be reversed or propellered for prolonged edge use and improved cost per hour



ARM center and end cutting edges

- For use on all scraper models (open bowl, auger and elevating scraper)
- Used in medium-to-high abrasion and low-to-high impact conditions
- Available in various thicknesses and sizes for both stinger and level-cut arrangements
- Can be reversed or propellered for prolonged edge use and improved cost per hour



ARM serrated center cutting edge

- For use on 620, 630 and 650 Series Scraper (open bowl, auger and elevating scraper)
- Used in medium-to-high abrasion and medium-to-high impact conditions where increased penetration and aggressive digging action is required
- Available in various thicknesses and sizes for both stinger and level-cut arrangements
- Edges can be reversed or propellered around for prolonged edge use and improved cost per hour



Integrated tooth center cutting edge

- For use on 623 and 633 Elevating Scraper, and 620 Series Auger Scraper
- Used in low-to-high abrasion conditions for improved penetration in medium-to-high impact conditions
- Include cast-in-place adapters, which accept pin-on tips



Bolt-on adapters

- For use on Elevating Scraper 613, 615, 623 and 633
- Used in low-to-high abrasion conditions and low-to-medium impact conditions when improved penetration is needed
- Bolt-on adapters accept pin-on tips



Special serrated cutting edges

- For site-specific applications and conditions
- Use on 620, 630 and 650 Series Scraper (open bowl, auger and elevating scraper)
- Custom-designed edges have sharp teeth for low-to-medium abrasion and low-to-medium impact conditions



Sidebowl Protectors

Sidebowl protectors are available in two styles: Bolt-on sidebowl protectors and pin-on sidebowl protectors.

Bolt-on style takes a weld on adapter plate that accepts the bolt on sidebowl protector. This available for 620, 630 and 650 series scrapers.

Pin-on style takes a weld on adapter plate that accepts the pin-on sidebowl protector. This is available for 620, 630 and 650 series scrapers.

Cat Elevated Wheel Tractor Scrapers

OPTIONS

CATERPILLAR WARRANTY

Cat router bits and cutting edges are guaranteed against breakage. If a component breaks during normal operation, it will be replaced free. The warranty is subject to certain terms and conditions. See your Cat dealer for details.



Caterpillar offers parts for 613, 615, 623 and 633 Elevating Scraper

- Flight assemblies
- Chain assemblies
- Sprockets
- Idlers and idler groups
- Rollers and roller groups

In today's competitive environment, machines must operate efficiently. Inspections identify problems that cause machines to burn more fuel and shorten component life.



Two Parts Kits are available for your 613, 615, and 623 Elevating Scraper:

- Parts kit with flight assemblies (hardware not included).
- Parts kit with chain assemblies, sprockets, appropriate sprocket hardware and appropriate flight assembly hardware. Conveniently packaged for transportation and delivery, the kits make ordering easy.



Short Tooth

- Impact Resistant



Long Tooth

- Long Teeth are symmetrical and can be reversed for balanced wear.



Penetration Tooth

- Penetration Teeth are ideal for densely-compacted materials.
- Approximately 50% less cross-sectional area than Long Tooth.



Wide Tooth

- Wide Teeth are used to maintain smooth trench floors and in low abrasion, easy-to-penetrate materials.



Sharp Tooth

- Sharp Teeth are used to achieve maximum penetration, and are typically used in cohesive material.
- Stay sharp during the life of the tooth



Heavy Duty Long Tooth



- Includes approximately 60% more wear material.

Cat Wheel Tractor Scrapers

PART NUMBERS



613C

Machine Models: 613C

Cutting Edges													
Type	Center				End				Router Bits			Notes	
	Thick-ness	Cutting Edges	Quantity	Hard-ware	Thick-ness	Cutting Edges	Quantity	Hard-ware	Router Bits	Quantity	Hard-ware		
GP	Stinger	22	4T-6611	1	7	22	4T-6613	2	4	9W-4903	2	3	Equipped from factory
Tips and Adapters													
Tip Size	Type	Part No.	Pin	Retainer Assembly		Notes							
J250	Bolt-on Adapter	9J-8455	N/A	N/A		Bolt-on adapters use stinger arrangement cutting edge.							
J250	Penetration	9J-4259				Integrated package will need 5 tips, pins, and retainer assemblies. Bolt-on package will need 4 bolt-on adapters, tips, pins, and retainer assemblies.							
	Wide	208-5254											
	Sharp	9W-8259											
	Heavy Duty Long	9N-4252											
	Heavy Duty Abrasion	9N-4253											
Flight Group and Chains													
Description	Part Number		Quantity		Notes								
Chain Assembly	2T-0104		2										
Sprocket	2T-2623		2										
Flight Assembly	2T-0679		15										
Wear Protection													
Type	Description		Protector	Quantity	Adapter Plate	Shear Block	Quantity	Hard-ware	Notes				
Wear Protection	Bowlside Protection		Pin-On	8J-4143	2	152-0034	341-6010	2	8				
			Bolt-On	232-0048	2	232-0049	n/a	2	4				
Hardware													
Type	Description	Hardware			Quantity	Part Number	Nuts	Washers	Notes				
Hardware	Cutting Edge	Bolt	3/4-10 x 2-1/4	15	4F-7827	2J-3506	5P-8248	Bolt-On Tooth Adapters will require (6) 4F-7827 bolts for the cutting edges and router bits and (8) 5F-8922 bolts for the tooth adapters.					
	Router Bit	Bolt	5/8-11 x 2-1/4	6	8S-9092	4K-0367	5P-8247						
	Sprocket	Bolt	5/8-11 x 2-3/4	16	1A-8537	4K-0367	5P-8247						
	Flight Assembly	Bolt	1/2-20 x 1-1/2	120	0S-1603	6B-6684	5P-8245						
	Wear Protection		Bolt-On	1-8 x 3-3/4	8	1J-4948*	2J-3507						5P-8250
			Pin-On	Pin	8	9J-8441	n/a						
		Retainer		8	8E-5559								
Repair Parts													
Type	Description	Position	Thickness	Part Number		Notes							
Bowl Repair	Full Replacement	Left	25.4	4T-7668									
			35.1	7J-4228									
		Right	25.4	4T-7667									
			35.1	7J-4227									
	Partial Replacement	Left	30	229-7147									
		Right	30	229-7148									
	Bolt Hole Area Replacement	Left	35.1	208-5185									
		Right	35.1	208-5186									

620G

Machine Models: 621G, 627G

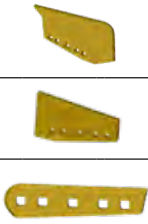
Cutting Edges													
Type	Center				End				Router Bits			Notes	
	Thick-ness	Cutting Edges	Quantity	Hard-ware	Thick-ness	Cutting Edges	Quantity	Hard-ware	Router Bits	Quantity	Hard-ware		
Utility	Stinger	22	4T-6568	1	9	22	4T-6612	2	5	4J-8665	2	5	Equipped from factory
	Level Cut					22	195-5131	2	5	220-9150	2	5	
GP	Stinger	28.5	4T-2896	1	9	28.5	4T-6380	2	5	4J-8665	2	5	
	Level Cut					28.5	4T-2894	2	5	220-9150	2	5	
	Serrated Stinger					195-7279	1	9	28.5	4T-6380	2	5	4J-8665
EEWL	Stinger	40	132-4566	1	9	40	132-4567	2	5	7J-3023	2	5	
Specialty													
GP A.R.M.	Stinger	28.5	140-6779	1	9	28.5	140-6778	2	5	143-3065	2	5	
	Level Cut					28.5	144-1323	2	5	220-9150	2	5	
	Serrated Stinger					140-6767	1	9	28.5	140-6778	2	5	143-3065
Router Bits													
Type	Part Number	Thick-ness	Quantity	Hardware				Notes					
GP	4J-8665	25.5	2	5									
Heavy Duty	7J-3023	32	2	5									
Level Cut	220-9150	25	2	5									
Specialty													
A.R.M. GP	143-3065	19	2	5									
A.R.M. Heavy Duty	143-3079	32	2	5									
Quick Change	4T-0051* (Support) 4J-8665 (Router Bit)	20	2	5				Will also need Pin: 4T-0055* and Retainer Assembly: 8E-6359					
Wear Protection													
Type	Description		Protector	Quantity	Adapter Plate	Shear Block	Quantity	Hard-ware	Notes				
Wear Protection	Bowlside Protection		Pin-On	8J-4143	2	152-0034	341-6010	2	8				
			Bolt-On	232-0048	2	232-0049	n/a	2	4				
Hardware													
Type	Description		Hardware		Quantity	Part Number		Nuts	Washers	Notes			
Hardware	Cutting Edge		Bolt	1-8 x 3	19	4F-4042		2J-3507	5P-8250				
	Router Bit		Bolt	1-8 x 3	10	4F-4042							
	Wear Protection		Bolt-On	1-8 x 3-3/4	8	1J-4948*							
			Pin-On	Pin	8	9J-8441							
				Retainer	8	8E-5559							
Repair Parts													
Type	Description		Position	Thickness	Part Number		Notes						
Bowl Repair	Full Replacement		Left	25.4	4T-7668								
				35.1	7J-4228								
			Right	25.4	4T-7667								
				35.1	7J-4227								
	Partial Replacement		Left	30	229-7147								
			Right	30	229-7148								
Bolt Hole Area Replacement		Left	35.1	208-5185									
		Right	35.1	208-5186									





Cat Wheel Tractor Scrapers

PART NUMBERS

620H & 620K

Machine Models: 621H, 627H, 621K, 627K

Type		Center				End				Router Bits			Notes
		Thick-ness	Cutting Edges	Quantity	Hard-ware	Thick-ness	Cutting Edges	Quantity	Hard-ware	Router Bits	Quantity	Hard-ware	
Utility	Stinger	22	4T-2887	1	10	22	4T-6612	2	5	4J-8665	2	5	Equipped from factory
	Level Cut					22	195-5131	2	5	220-9150	2	5	
GP	Stinger	28.5	4T-2895	1	10	28.5	4T-6380	2	5	4J-8665	2	5	
	Level Cut					28.5	4T-2894	2	5	220-9150	2	5	
	Course Serrated Stinger		201-3439	1	10	28.5	4T-6380	2	5	7J-3023	2	5	
	Fine Serrated Stinger		282-0511		10	28.5	4T-6380	2	5	7J-3023	2	5	
EWL	Level Cut	35	4J-8226*	1	10	35	257-1870	2	5	220-9150	2	5	
Specialty													
GP A.R.M.	Stinger	28.5	140-6847	1	10	28.5	140-6778	2	5	143-3065	2	5	
	Level Cut					28.5	144-1323	2	5				
	Course Serrated Stinger		140-6780	1	10	28.5	140-6778	2	5	143-3079	2	5	
	Fine Serrated Stinger		208-8871	1	10	28.5	140-6778	2	5				
Router Bits													
Type	Part Number	Thick-ness	Quantity	Hardware		Notes							
GP	4J-8665	25.5	2	5									
Heavy Duty	7J-3023	32	2	5									
Level Cut	220-9150	25	2	5									
Specialty													
A.R.M. GP	143-3065	19	2	5									
A.R.M. Heavy Duty	143-3079	32	2	5									
Quick Change	4T-0051* (Support) 4J-8665 (Router Bit)	20	2	5		Will also need Pin: 4T-0055* and Retainer Assembly: 8E-6359							
Wear Protection													

Type	Description	Protector	Quantity	Adapter Plate	Shear Block	Quantity	Hardware	Notes	
Wear Protection	Bowlside Protection	Pin-On	8J-4143	2	152-0034	341-6010	2	8	
		Bolt-On	232-0048	2	232-0049	n/a	2	4	
Hardware									
Type	Description	Hardware	Quantity	Part Number	Nuts	Washers	Notes		
Hardware	Cutting Edge	Bolt	1-8 x 3	20	4F-4042	2J-3507	5P-8250		
	Router Bit	Bolt	1-8 x 3	10	4F-4042				
	Wear Protection	Bolt-On	1-8 x 3-3/4	8	1J-4948*				
		Pin-On	Pin		8	9J-8441	n/a		
	Retainer			8	8E-5559				
Repair Parts									
Type	Description	Position	Thickness	Part Number	Notes				
Bowl Repair	Full Replacement	Left	25.4	4T-7668					
			35.1	7J-4228					
		Right	25.4	4T-7667					
			35.1	7J-4227					
	Partial Replacement	Left	30	229-7147					
		Right	30	229-7148					
	Bolt Hole Area Replacement	Left	35.1	208-5185					
		Right	35.1	208-5186					

Cat Wheel Tractor Scrapers

PART NUMBERS

623

Machine Models: 623G, 623H, 623K

Cutting Edges															
Type	Center				End				Router Bits			Notes			
	Thick-ness	Cutting Edges	Quantity	Hard-ware	Thick-ness	Cutting Edges	Quantity	Hard-ware	Router Bits	Quantity	Hard-ware				
Utility	Stinger	22	4T-2887	1	10	22	4T-6612	2	5	4J-8665	2	5	Equipped from factory		
	Level Cut					22	195-5131	2	5	220-9150	2	5			
GP	Stinger	28.5	4T-2895	1	10	28.5	4T-6380	2	5	4J-8665	2	5			
	Level Cut					28.5	4T-2894	2	5	220-9150	2	5			
	Course Serrated Stinger					201-3439	1	10	28.5	4T-6380	2	5	7J-3023	2	5
	Fine Serrated Stinger					282-0511	1	10	28.5	4T-6380	2	5	7J-3023	2	5
EWL	Level Cut	35	4J-8226*	1	10	35	257-1870	2	5	220-9150	2	5			
Specialty															
GP A.R.M.	Stinger	28.5	140-6847	1	10	28.5	140-6778	2	5	143-3065	2	5			
	Level Cut					28.5	144-1323	2	5	143-3065	2	5			
	Course Serrated Stinger					28.5	140-6778	2	5	143-3079	2	5			
	Fine Serrated Stinger					208-8871	1	10	28.5	140-6778	2	5	143-3079	2	5
Router Bits															
Type	Part Number	Thick-ness	Quantity	Hardware				Notes							
GP	4J-8665	25.5	2	5											
Heavy Duty	7J-3023	32	2	5											
Level Cut	220-9150	25	2	5											
Specialty															
A.R.M. GP	143-3065	19	2	5											
A.R.M. Heavy Duty	143-3079	32	2	5											
Quick Change	4T-0051* (Support) 4J-8665 (Router Bit)	20	2	5				Will also need Pin: 4T-0055* and Retainer Assembly: 8E-6359							





Flight Group and Chains			
Description	Part Number	Quantity	Notes
Chain Assembly	507-9307	2	
Sprocket	316-4419	2	
Flight Assembly	320-6207	15	
Roller Assembly	446-8013	2	
Roller Assembly	446-8017	2	

Tips and Adapters			
Tip Size	Type	Part No.	Retainer Assembly
Tip Adapters	Integrated	1 - 1U-1901 2 - 1U-1902	Bolt-On Tooth Adapters will use (16) 4F-4042 bolts for cutting edges and (8) 1J-3527 bolts for the adapters.
	Bolt-on Tip Adapter	9J-2307	
J300 Tips	Short	1U-3301	Pin - 8E-6358* Retainer Assembly - 8E-6359
	Long	1U-3302	
	Long A.R.M.	144-1302*	
	Penetration	9J-4309	
	Wide	107-3300	
	Sharp	9W-8309	
	Heavy Duty Long	9N-4302	
Heavy Duty Abrasion	9N-4303		

The Bolt-on Tip Adapters will be used with the Utility Stinger Cutting Edge package above (the row that is shaded).

Integrated package will need 5 tips, pins, and retainer assemblies. Bolt-on package will need 4 bolt-on adapters, tips, pins, and retainer assemblies.





Wear Protection										
Type	Description		Protector	Quantity	Adapter Plate	Shear Block	Quantity	Hardware	Notes	
Wear Protection	Bowlside Protection		Pin-On	8J-4143	2	152-0034	341-6010	2	8	
			Bolt-On	232-0048	2	232-0049	n/a	2	4	
Hardware										
Type	Description		Hardware		Quantity	Part Number	Nuts	Washers	Notes	
Hardware	Cutting Edge		Bolt	1-8 x 3	20	4F-4042	2J-3507	5P-8250	Bolt-On Tooth Adapters will require (16) 4F-4042 bolts or the cutting edges and router bits and (8) 1J-3527 bolts for the tooth adapters.	
	Router Bit		Bolt	1-8 x 3	10	4F-4042				
	Sprocket		Bolt	3/4-10 x 4-1/4	16	0S-1756	2J-3506	5P-8248		
	Flight Assembly		Bolt	5/8-18 x 2	120	0S-1576	6B-6683	5P-8247		
	Wear Protection		Bolt-On	1-8 x 3-3/4	8	1J-4948*	2J-3507	5P-8250		
			Pin-On	Pin	8	9J-8441	n/a			
		Retainer	8	8E-5559						
Repair Parts										
Type	Description		Position	Thickness	Part Number		Notes			
Bowl Repair	Full Replacement		Left	25.4	4T-7668					
				35.1	7J-4228					
			Right	25.4	4T-7667					
				35.1	7J-4227					
	Partial Replacement		Left	30	229-7147					
			Right	30	229-7148					
Bolt Hole Area Replacement		Left	35.1	208-5185						
		Right	35.1	208-5186						

Cat Wheel Tractor Scrapers

PART NUMBERS

630G & 630K



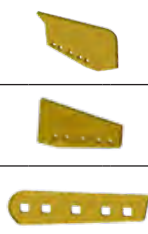

Machine Models: 631G, 637G, 631K, 637K

Type		Center				End				Router Bits			Notes	
		Thick-ness	Cutting Edges	Quantity	Hard-ware	Thick-ness	Cutting Edges	Quantity	Hard-ware	Router Bits	Quantity	Hard-ware		
Utility	Stinger	22	4T-6566	1	10	22	4T-6614	2	6	4J-8665	2	5	Equipped from factory	
	Level Cut					22	195-5131	2	6	220-9150	2	5		
GP	Stinger	28.5	4T-3444	1	10	28.5	4T-6378	2	6	4J-8665	2	5		
	Course Serrated Stinger		201-3439	1	10	28.5	4T-6380	2	6	7J-3023	2	5		
	Fine Serrated Stinger		282-0511	1	10	28.5	4T-6380	2	6	7J-3023	2	5		
EWL	Stinger	35	9J-4369	1	10	35	9W-6092	2	6	7J-3023	2	5		
	Level Cut					35	7J-0225	2	6	220-9150	2	5		
	Course Serrated Stinger		(310-2420)	1	10	35	9W-6092	2	6	7J-3023	2	5		
EEWL	Stinger	40	9J-5899	1	10	40	7J-2959	2	6	7J-3023	2	5		
Specialty														
GP A.R.M.	Stinger	28.5	137-6443	1	10	28.5	138-6444	2	6	143-3065	2	5		
EWL A.R.M.	Stinger	35	138-6445	1	10	35	138-6446	2	6	143-3079	2	5		
Serrated A.R.M.	Course Stinger	35	195-5132	1	10	35	138-6446 ¹	2	6	143-3079	2	5		
	Level Cut					35	286-2086 ²	2	6	143-3079	2	5		
	Course Longer Teeth		208-8873	1	10	35	138-6446 ¹	2	6	143-3079	2	5		
	Fine Stinger		208-8872	1	10	35	138-6446 ¹	2	6	143-3079	2	5		
EEWL A.R.M.	Stinger	40	195-5114*	1	10	40	320-8846*	2	6	143-3079	2	5		
Router Bits														
Type	Part Number	Thick-ness	Quantity	Hardware		Notes								
GP	4J-8665	25.5	2	5										
Heavy Duty	7J-3023	32	2	5										
Level Cut	220-9150	25	2	5										
Specialty														
A.R.M. GP	143-3065	19	2	5										
A.R.M. Heavy Duty	143-3079	32	2	5										
Quick Change	4T-0051* (Support) 4J-8665 (Router Bit)	20	2	5		Will also need Pin: 4T-0055* and Retainer Assembly: 8E-6359								
Wear Protection														
Type	Description	Protector	Quantity	Adapter Plate	Shear Block	Quantity	Hard-ware	Notes						
Wear Protection	Bowlside Protection	Pin-On	8J-4143	2	152-0034	341-6010	2	8						
		Bolt-On	232-0048	2	232-0049	n/a	2	4						
Hardware														
Type	Description	Hardware		Quantity	Part Number	Nuts	Washers	Notes						
Hardware	Cutting Edge	Bolt	1-8 x 3-1/4	22	4J-9058	2J-3507	5P-8250							
	Router Bit	Bolt	1-8 x 3-1/4	10	4J-9058									
	Wear Protection	Bolt-On	1-8 x 3-3/4	8	1J-4948*									
		Pin-On	Pin		8	9J-8441								
			Retainer		8	8E-5559								
Repair Parts														
Type	Description	Position	Thickness	Part Number		Notes								
Bowl Repair	Full Replacement	Left	25.4	4T-7668										
			35.1	7J-4228										
		Right	25.4	4T-7667										
			35.1	7J-4227										
	Partial Replacement	Left	30	229-7147										
		Right	30	229-7148										
Bolt Hole Area Replacement	Left	35.1	208-5185											
	Right	35.1	208-5186											

¹ Only the center cutting edge is serrated
² The center and end cutting edges are serrated

650G

Machine Models: 657G

Cutting Edges													
Type	Center				End				Router Bits			Notes	
	Thick-ness	Cutting Edges	Quantity	Hard-ware	Thick-ness	Cutting Edges	Quantity	Hard-ware	Router Bits	Quantity	Hard-ware		
GP	Stinger	35	9W-4901	1	24	35	9W-4902	2	12	7J-3023	2	5	Equipped from factory
	Serrated		255-0901*	1	24	35							
EWL	Stinger	45	9W-9701	1	24	45	9W-9702	2	12				
Specialty													
EWL A.R.M.	Stinger	45	159-0374	1	24	45	159-0375	2	12	143-3079	2	5	
	Serrated		217-4826	1	24	45	217-4843*	2	12				
Router Bits													
Type	Part Number	Thick-ness	Quantity	Hardware				Notes					
GP	7J-3023	32	2	5									
Specialty													
A.R.M. GP	143-3079	32	2	5									
Wear Protection													
Type	Description		Protector	Quantity	Adapter Plate	Shear Block	Quantity	Hard-ware	Notes				
Wear Protection	Bowlside Protection		Pin-On	8J-4143	2	152-0034	341-6010	2	8				
			Bolt-On	232-0048	2	232-0049	n/a	2	4				
Hardware													
Type	Description		Hardware		Quantity	Part Number		Nuts	Washers	Notes			
Hardware	Cutting Edge		Bolt	1-8 x 3-1/4	48	4J-9058		2J-3507	5P-8250				
	Router Bit		Bolt	1-8 x 3-1/4	10	4J-9058							
	Wear Protection		Bolt-On	1-8 x 3-3/4	8	1J-4948*							
			Pin-On	Pin		8	9J-8441						
				Retainer		8	8E-5559						
Repair Parts													
Type	Description		Position	Thickness	Part Number		Notes						
Bowl Repair	Full Replacement		Left	25.4	4T-7668								
				35.1	7J-4228								
			Right	25.4	4T-7667								
				35.1	7J-4227								
	Partial Replacement		Left	30	229-7147								
			Right	30	229-7148								
Bolt Hole Area Replacement		Left	35.1	208-5185									
		Right	35.1	208-5186									

Discontinued
Canceled
(Reference)

Part is discontinued. Please contact your service representative.
Part is canceled. Please contact your customer service representative.
Part number is not serviceable. For reference only.



Building Construction Products



Cat Skid Steer, Multi Terrain, and Compact Track Loaders

D Series Buckets

Machine Models: 226D, 232D, 236D, 242D, 246D, 262D, 272D, 272D XHP, 2727D2, 272D2 XHP, 239D, 249D, 259D, 279D, 289D, 299D, 299D XHP, 299D2, 299D2 XHP, 257D, 277D, 287D, 297D, 297D XHP, 297D2, 297D2 XHP

Moldboard Cutting Edges							
Profile	Length	Width	Qty	Hard-ware	Thickness		Notes
					16mm	19mm	
Flat	54"	6.5"	1	6	135-9393		
		8"	1	6	174-7965	174-7971	
	60"	6.5"	1	8	135-9394		
		8"	1	8	174-7966	174-7972	
	66"	6.5"	1	8	135-9395		
		8"	1	8	174-7967	174-7973	
	72"	6.5"	1	11	135-9396		
		8"	1	11	174-7968	174-7974	
	78"	6.5"	1	11	135-9397		
		8"	1	11	174-7969	174-7975	
84"	6.5"	1	11	195-5124			
	8"	1	7	174-7970*	174-7976		
Serrated	60"	8"	1	8		319-9599	
	66"	8"	1	8		319-9600	
	72"	8"	1	11		319-9601	
	78"	8"	1	11		319-9602	
	84"	8"	1	7		319-9603	
Specialty							
Type	Length	Number of Teeth	Part Number	Qty	Hardware	Notes	
Bolt-On Tooth Bar for Base Edge Buckets	60"	7	136-8734*	1	2		
	66"	8	136-8735*	1	2		
	72"	8	136-8736	1	2		
	78"	8	217-4878	1	2		
	84"	8	275-5427	1	2		
	90"	8	566-1844	1	2		
Bolt-On Tooth Bar for Bolt-On Buckets	60"	7	159-0330	1	2		
	66"	8	159-0340	1	2		
	72"	8	159-0350	1	2		
	78"	8	195-9160	1	2		
	84"	8	264-2084	1	2		
	90"	8	566-1841	1	2		

D Series Models

Machine Models: 226D, 232D, 236D, 242D, 246D, 262D, 272D, 272D XHP, 2727D2, 272D2 XHP, 239D, 249D, 259D, 279D, 289D, 299D, 299D XHP, 299D2, 299D2 XHP, 257D, 277D, 287D, 297D, 297D XHP, 297D2, 297D2 XHP

Hardware and Wear Protection								
Type	Application	Hardware		Quantity	Bolts	Nuts	Washers	Notes
Hardware	6.5" Edges	Bolts	M16-2 x 50	Above	159-2953	8T-4778	N/A	
	8" Edges	Bolts	5/8 11 x 2"	Above	4F-3654	4K-0367	N/A	
	Bolt-On Tooth Bar	Bolts	1-8 x 2 1/4"	2	8S-9093	2J-3507	5P-8250	Also uses lockwasher 3B-4516
Broom Edges and Accessories								
Part Type	Part Number	Length	Qty	Hardware	Notes			
Buckets BU115 and BP115B								
Cutting Edge	489-6702	64"	1	6				
Poly Bristle Assembly	165-9069	N/A	17	N/A				
Wire Bristle Assembly	165-9070	N/A	18	N/A				
Buckets BU118 and BP118B								
Cutting Edge	489-6703	76"	1	7				
Poly Bristle Assembly	165-9071	N/A	21	N/A				
Wire Bristle Assembly	165-9072	N/A	20	N/A				
Bucket BP115C								
Cutting Edge	452-4148	60.5"	1	6	Use lock washers to install cutting edges.			
Poly Bristle Assembly	165-9069	N/A	17	N/A				
Wire Bristle Assembly	165-9070	N/A	18	N/A				
Bucket BP118C								
Cutting Edge	452-4147	72.5"	1	7	Use lock washers to install cutting edges.			
Poly Bristle Assembly	165-9071	N/A	21	N/A				
Wire Bristle Assembly	165-9072	N/A	20	N/A				
Buckets BA18 and BA118C								
Poly Bristle Assembly	166-0322	N/A	22	N/A				
Wire Bristle Assembly	166-0323	N/A	21	N/A				
All Series Gutter Buckets								
Poly Bristle Assembly	172-4563	N/A	1	N/A				
Wire Bristle Assembly	460-9777	N/A	1	N/A				
Hardware and Wear Protection								
Type	Application	Hardware		Quantity	Bolts	Nuts	Washers	Notes
Hardware	Cutting Edges	Bolts	1/2 - 13 x 2	Above	4F-3649	6V-8188	3B-4508	Only use washers when called out above.

Cat Skid Steer, Multi Terrain, and Compact Track Loaders

AUGER BITS & ACCESSORIES

Auger Bits & Accessories		
Part Class	Type / Size	Part #
Standard Duty Bits	6"	153-4083
	9"	153-4084
	12"	153-4085
	15"	366-7752
	18"	153-4086
	24"	153-4089
	30"	217-3194
	36"	153-4091
Industrial Duty Bits	6"	372-0260
	9"	372-0261
	12"	372-0262
	16"	372-0263
	18"	372-0264
	24"	372-0265
Teeth	Gage Tooth (Outer)	371-3694
	Flat Tooth (Inner)	371-3690
	HF Gage Tooth (Outer)	371-3695
	Flat Carbide Tooth (Inner)	371-3691
	Chisel Tooth (Inner)	371-3696
	Flat Hard Face Tooth HF (Inner)	371-3692
	Chisel Carbide Tooth (Inner)	371-3697
	Flat HF Tooth (HF Both Sides, Inner)	371-3693
	Chisel HF Tooth (Inner)	371-3698
	Standard Duty Tooth	153-4094
	Hard Face Tooth	174-9566
	Carbide Inserted Tooth	174-9567
Tree Bit	24"	153-4092
	36"	153-4095
Rock Heads	6" Bolt-On	372-0230
	9" Bolt-On	372-0231
	Drill Head, 12" Standard	372-0232
	15" Bolt-On	372-0233
	Drill Head, 18" Standard	372-0234
	Drill Head, 24" Standard	372-0235
Adapters	Hex to Round	156-6329
	Round to Hex	217-3191
Extensions	12"	156-6328
	24"	217-3192
Telescoping Extensions	3'	372-0256
	6'	372-0257
Accessories	Retention Pin Kit	372-0258
	Pilot Point	153-4093

Backhoe Loader

D Series

Loader	
Part Number	Part Number
Edge Group - Bolt On	9W-8215
Edge - Cutting	9W-8215
Bolt - Plow	3F-5108
Nut - Full	4K-0367
Washer - Hard	8T-4122
Tooth Group - Bolt On	135-8203
Tooth - Uni (Double strap)	135-8203
Tooth - Uni (Single strap)	132-4720
Bolt - Plow	4F-3657
Nut - Full	4K-0367
The following tips are DRS230 size	
Pin - GET	500-0269
Retainer Assembly	201-1239
Tip - Penetration	208-5235
Tip - Chisel	208-5232
Tip - Soil	208-5234
Tip - Long	208-5236
Tip - Twin Sharp	208-5237
Tip - Sharp	208-5239
Tip - Wide	208-5240
Adapter - Weld on (For use with Rock Buckets)	201-1234
Adapter - 25 mm (Soil excavation edges)	253-0234
Adapter - Weld on	201-1235

Ground engaging tools labeled as a group include mounting hardware.

E and F Series

Loader	
Part Number	Part Number
Edge Group - Bolt On	(9R-5321)
Edge - Cutting	9W-8215
Bolt - Plow	3F-5108
Nut - Full	4K-0367
Washer - Hard	8T-4122
Tooth Group - Bolt On	(9R-5866)
Tooth - Uni (Double strap)	135-8203
Tooth - Uni (Single strap)	132-4720
Bolt - Plow	4F-3657
Nut - Full	4K-0367
The following tips are DRS230 size	
Pin - GET	500-0269
Retainer Assembly	201-1239
Tip - Penetration	208-5235
Tip - Chisel	208-5232
Tip - Soil	208-5234
Tip - Long	208-5236
Tip - Twin Sharp	208-5237
Tip - Sharp	208-5239
Tip - Wide	208-5240
Adapter - Weld on (For use with Rock Buckets)	201-1234
Adapter - 25 mm (Soil excavation edges)	253-0234
Adapter - Weld on	201-1235

Ground engaging tools labeled as a group include mounting hardware.

Backhoe Loader

F2 Series

Loader		
Description (Width)	Qty	Part Number
Edge Group - Bolt-On (2262mm)		
Cutting Edge	2	9W-8215
Hex Head Nut	8	4K-0367
Washer Hard	8	8T-4122
Plow Bolt	8	3F-5108
Edge Group - Bolt-On (2406mm)		
Cutting Edge	2	118-7110
Hex Head Nut	8	4K-0367
Washer Hard	8	8T-4122
Plow Bolt	8	3F-5108
Edge Group - Bolt-On (2434mm)		
Cutting Edge	2	220-4691
Hex Head Nut	8	4K-0367
Washer Hard	8	8T-4122
Plow Bolt	8	3F-5108
Edge Group - Bolt-On (2434mm)		
Cutting Edge	2	9U-9665
Hex Head Nut	12	4K-0367
Plow Bolt	12	3F-5108
Cutting Edge MP (2262mm)	1	233-3757
Cutting Edge MP (2406mm)	1	233-0859
Cutting Edge MP (2434mm)	1	515-9970
Cutting Edge MP (2434mm)	1	517-1305
Tooth Gp-Uni		
Unitooth Tip	8	135-8203
Hex Head Nut	16	4K-0367
Plow Bolt	16	4F-3657

Hoe	
Description (Width)	Part Number
Diagonal Retention System (DRS230)	
Retainer	201-1239
Pin - GET	500-0269
Diagonal Pin Adapter	
Adapter (25mm for Rock Buckets)	201-1234
Adapter (20mm)	201-1235
Adapter (25mm for Soil Buckets)	253-0234
Tip	
Penetration	208-5235
Chisel	208-5232
Soil Digging	208-5234
Long	208-5236
Twin Sharp	208-5237
Sharp	208-5239
Wide	208-5240
Cutting Edge	
Cutting Edge (1200mm)	311-6221
Cutting Edge (1500mm)	311-9239
Cutting Edge (1800mm)	556-3598

Wear Protection



Cat Wear Protection

OPTIONS



Chocky Bars

Cat Chocky Bars are now offered in 6 widths. The new 1.00" Cat Chocky Bar fits even narrower surfaces. All Chocky Bars contain a "V-groove" design that allows for these items to be bent around a radius (i.e. side bucket profiles) or separated to change the length requirement needed.



Wear Buttons

Cat Wear Buttons have been designed for use in applications that lend themselves to optimizing their round profile, or where the round design is needed to cover a specific surface area. The new Cat "Tear Drop" Wear Button fits in with the existing line of circular Wear Buttons. The tear drop shape can extend into corners or follow natural tapers on the protected surface. All Wear Buttons utilizes a "tri-bar" design which traps fine media between three raised bars. The trapped media will provide material-on-material wear, prolonging the life of the product.



Roll Bars

Cat Roll Bars are a unique product designed to protect the sidebar and heel area of earth moving machinery such as dozers, loaders and mining shovels. The new 5" Roll Bar now allows protection on even larger plates. Roll Bars offer impact deflection, penetration, and can be used as weight reduction in place of heavier castings. Their round profile is designed to provide maximum wear protection while minimizing drag as the sidebar proceeds through the media.



Wear Lug

The Cat Wear Lug is a laminated wear part designed for use on earth moving equipment in the sidebar and leading edge of the bucket. The profile shape of the top of the Wear Lug allows this product to be utilized in TTT applications for further traction on track shoes.



Bolt Saver

The Cat Bolt Saver is a circular laminated wear part designed with a hole in the middle to surround and protect bolt heads. It is also large enough to be placed around 3/4" CapSure™ locks as a high abrasion protector.



Mechanically Attached Wear Protection System (MAWPS)

The solid Mechanically Attached Wear Protection System provides a hammerless method for installation and removal of wear plates. MAWPS are available in a variety of sizes. Each size is also available in two different thicknesses: standard and heavy duty. The skeletal MAWPS provides the same hammerless means of installation and removal as the solid MAWPS, but is for use in the rear portion of truck bodies. The skeletal plates are designed to trap material, allowing for material-on-material wear rather than wear on the steel body liner. Skeletal MAWPS, available in standard and heavy duty thicknesses, provide a flexible application while protecting your truck body.



Weld-On Heel Shrouds

Weld-on heel shrouds protect the lower outside corner of all types of Caterpillar and other brand buckets. Protection is given to the bottom and the side of the bucket with extra wear material concentrated in the corner where it's needed most. Straight and curved heel shrouds are available in two different sizes to best match bucket contour and size, and abrasiveness of the application. The inside corner is relieved to eliminate interference with the bucket structure. Shrouds need not be placed tightly together. They can be spaced apart and still provide full protection due to 'shadowing.' Weld-on heel shrouds are especially applicable for LHEX and underground LHD buckets.



Mechanically Attached Wear Protection System (MAWPS) Heel Shrouds

Protect the outside corners of your buckets with these Mechanically Attached Wear Protection System (MAWPS) Heel Shrouds. These heel shrouds are designed to have similar wear life to the Weld-On Heel Shrouds, but don't require any welding during replacements. The system is hammerless, using the same spring retainers as the MAWPS Plate system. Save time and money on these replacements with reduced labor. Bases come in 2 sizes and have a straight and curved option to match the contour of your bucket. These are applicable for Large HEX, Large Wheel Loader, and Underground LHD buckets.

WEAR BLOCKS

Cat Wear Blocks are used in areas where a single piece needs to cover a large or specific surface area. There are several new Wear Blocks in the portfolio that give more flexibility and options for coverage.



6x8" Wear Blocks

Standard Cat 6x8" Wear Blocks are versatile and long lasting.



3x4" Wear Patch Block

The smaller Cat 3x4" Wear Patch Blocks can be plug welded in tight areas. They can also be grouped together where no gaps are desired between parts.



11" Trapezoidal Wear Blocks

The new Cat 11" Trapezoidal Wear Blocks can fill a tapered area or be staggered in a pattern to avoid straight-line channels.



4x8.5" Skid Wear Blocks

Cat 4x8.5" Skid Wear Blocks are rectangular shaped and perimeter welded in place.



Bi-Metallic Wear Blocks

The Cat Bi-Metallic Wear Blocks use a unique mechanical bonding process for the highest impact applications. The mild steel jacket and fingers create a strong bond to the chrome white iron.



Tungsten Sidebars

The Cat Tungsten Sidebars are designed to be installed on the bucket wings of any HMS, ERS, or LHEX bucket. These are an alternative method of protection over OEM cast wing shroud systems. The Tungsten carbide Sidebars strengthen the bucket sidewall and provide a shadowing effect that can protect the sidewall from wear. Each sidebar is made from steel round bar and welded with PTA over 180° of the surface creating a wear face while leaving the back surface for welding to the bucket.



Manganese Wear Bar

The laminated Cat Manganese Wear Bar is the first to market product and is designed for the most impact prone applications, including mining shovel heels and lips, and in fixed plant applications including primary and secondary crushers. The Manganese Bar work hardens from ~200bhn to ~500bhn+ due to the impact found in the application. The Manganese Bar is laminated to a mild steel backing plate, creating a strong bond.



Manganese Wear Block

Like the Cat Manganese Wear Bar, the Cat Manganese Wear Block is also a first to market product designed for the most impact prone applications. The Manganese Block work hardens from ~200bhn to ~500bhn+ due to the impact found in the application. The Manganese Block is laminated to a mild steel backing plate, creating a strong bond.

Cat Wear Protection

PART NUMBERS

Wear Protection Options					
Wear Buttons					
Part Number	Description	A (mm)	B (mm)	Wt (kg)	Notes
280-4092	Circular	64	22	0.5	
280-4093	Circular	89	29	1.2	
280-4094	Circular	114	33	2.3	
280-4095	Circular	152	35	4.2	
494-8981	Tear Drop Shape	76	25	1.0	
Bolt Saver					
Part Number	A (mm) = OD	B (mm)	C (mm) = ID	Wt (kg)	Notes
345-8061	114	33	79	1.1	
Chocky Bars					
Part Number	A (mm)	B (mm)	C (mm)	Wt (kg)	Notes
494-8979	241	25	25	1.1	<p>Note: Chocky Bars can be bent and welded onto curved surfaces.</p>
280-4088			38	1.6	
280-4089			51	2.2	
280-4090			64	2.7	
280-4091			102	4.4	
483-8264			363	165	
Roll Bars					
Part Number	A (mm)	B (mm)	C (mm)	Wt (kg)	Notes
280-4096	229	38	32	1.6	
280-4097	305	32	51	5.1	
280-4098		69	78	10.4	
494-8980		114	127	30.2	
Tungsten Sidebars					
Part Number	Diameter (mm)	Length (mm)	Wt (kg)	Overlay Type	Notes
519-8926	51	1,219	22.3	PTA	
519-8927	76		48.2		
519-8928	127		127.7		

Wear Protection Options

6 x 8" Wear Block

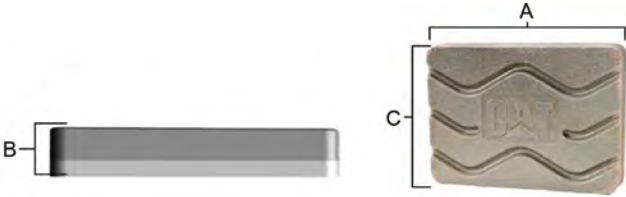
Part Number	A (mm)	B (mm)	C (mm)	Wt (kg)	Notes
280-4099	203	38	152	8.9	

6 x 8" Bi-Metallic Wear Block

Part Number	A (mm)	B (mm)	C (mm)	Wt (kg)	Notes
494-8988	203	38	152	8.2	

11" Trapezoidal Wear Block

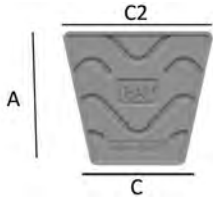
Part Number	A (mm)	B (mm)	C, C2 (mm)	Wt (kg)	Notes
494-8987	279	41	178, 292	19.3	

4 x 8.5" Skid Wear Block

Part Number	A (mm)	B (mm)	C (mm)	Wt (kg)	Notes
494-8985	216	34	102	5.4	

Wear Patch Block

Part Number	A (mm)	B (mm)	C (mm)	Wt (kg)	Notes
494-8984	102	11	76	1.0	 <p>Note: Wear patch blocks can be plug welded to eliminate gaps.</p>

6 x 8" Manganese Wear Block

Part Number	A (mm)	B (mm)	C (mm)	Wt (kg)	Notes
494-8983	203	38	152	9.1	

Manganese Wear Bar

Part Number	A (mm)	B (mm)	C (mm)	Wt (kg)	Notes
494-8982	241	25	51	2.4	

Wear Lug

Part Number	A (mm)	B (mm)	C (mm)	Wt (kg)	Notes
494-8986	152	29	28	0.9	

Cat Wear Protection

PART NUMBERS

Wear Protection Options								
Heel Shrouds								
Part Number	Description	A (mm)	B (mm)	C (mm)	D (mm)	Weight (kg)	Notes	
157-1019	Straight	254	203	269.0	50	31		
157-1027	Curved	254	203	269.0	50	29		
138-6529	Straight	178	152	203	41.0	14		
138-6551	Curved	178	152	203	41.0	14		
280-4078	Straight	119	102	152	25	5		
280-4079	Curved	119	102	152	25	5		
MAWPS (Mechanically Attached Wear Protection System)								
MAWPS Heel Shrouds								
Base								
Part Number	Size	Description	A (mm)	B (mm)	C (mm)	kg	Thickness	Notes
465-2007	Medium	Straight	181	118	103	2.8	20.3	
465-2008	Medium	Curved	181	118	103	2.7	20.3	
465-2004	Large	Straight	234	185	145	8.6	27	
465-2005	Large	Curved	234	185	145	8	27	
Cover								
Part Number	Size	A (mm)	B (mm)	C (mm)	D (mm)	kg	Notes	
465-2009	Medium	159	166	219	36	14		
465-2006	Large	232	211	284	36.5	29.4		
Wear Plate								
Series	Wear Plate Type	Part Number	A (mm)	B (mm)	Thickness (mm)	Weight (kg)	Notes	
10	Standard	378-1960	175	150	35	3.88		
20	Series	138-0022	225	200	35	6.42		
20	Heavy Duty	138-0023	225	200	50	10.85		
20	Heavy Duty (ARM)	264-2195	225	200	50	10.85		
30	Standard	138-0032	275	200	45	9.67		
30	Standard (ARM)	229-7067	275	200	45	9.67		
30	Heavy Duty	138-0033	275	200	60	14.8		
40	Standard	138-0042	275	200	60	13.28		
40	Heavy Duty	138-0043	275	200	75	18.7		
50	Standard	138-0052	300	250	75	25.08		
50	Heavy Duty	138-0053	300	250	100	37.75		
Base Plate								
Series	Part Number	A (mm)	B (mm)	Thickness (mm)	Weight (kg)	Notes		
10	378-1961	155	118	18	1.26			
20	138-0020	200	160	18	2.43			
30	138-0030	225	160	22	3.72			
40	138-0040	235	160	29	4.61			
50	138-0050	235	200	29	6.08			

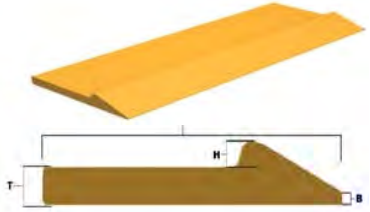
Skeletal							
Series	Part Number	A (mm)	B (mm)	Thickness (mm)	Weight (kg)	Notes	
Standard	138-0024	202	310	35	5.9		
Heavy Duty	138-0025	207	310	45	8.4		
Hardware							
Type	Part Number	Series		Notes			
Retainer	138-0006	10-40					
Retainer	138-0007	50					
Retainer Plug	275-5444	All		Part number 138-0006 is compatible with Skeletal MAWPS			
Wear Protection Options							
Weld-On Half-Arrow Edges							
Part Number	Description	Length (mm)	Width (mm)	Thickness (mm)	Height (mm)	B (mm)	Notes
134-1774	Weld-On Half-Arrow	2438	101	11	10	3.5	
134-1776	Weld-On Half-Arrow	2438	151	16	16	5.5	
8J-8141	Weld-On Half-Arrow	3658	203	19	13	4.0	
8J-8176	Weld-On Half-Arrow	3658	254	28	29	11	
6Y-2107	Weld-On Half-Arrow	3658	254	40	30	25	
109-2696	Weld-On Half-Arrow	5486	254	40	30	25	
416-0255	Weld-On Half-Arrow	1000	295	45	34	12	
Beveled Wear Bars							
Part Number	Description	Length (mm)	Width (mm)	Thickness (mm)	Notes		
5G-3897	Beveled Wear Bars	914	150	16			
5G-3488	Beveled Wear Bars	610	150	16			
5G-4642	Beveled Wear Bars	2500	191	16			
5G-5764	Beveled Wear Bars	2126	191	19			
9R-0316	Beveled Wear Bars	2240	150	19			
5W-7943*	Beveled Wear Bars	914	150	20			
5W-7937*	Beveled Wear Bars	610	150	20			
6K-7099	Beveled Wear Bars	2799	203	20			
107-3386*	Beveled Wear Bars	2438	203	25			
107-3387*	Beveled Wear Bars	2743	203	25			
107-3388*	Beveled Wear Bars	3353	203	25			
107-3389	Beveled Wear Bars	3658	203	25			
107-3390*	Beveled Wear Bars	3962	203	25			
107-3391	Beveled Wear Bars	4572	203	25			
6S-4738	Beveled Wear Bars	2080	150	25			
9R-5317	Beveled Wear Bars	610	203	25			
8K-9916	Beveled Wear Bars	3226	229	25			
1V-3915	Beveled Wear Bars	2686	229	25			
5V-7415*	Beveled Wear Bars	3226	245	25			
5V-7418	Beveled Wear Bars	2890	245	25			

Base Edge End Protector (BEEPs)

Dimensions (mm)

Part #	(C)	Bevel Angle	(A)	(B)	Thickness
286-2128	50	22.5	15	355	25
275-5468	63.5	22.5	22	336	30
275-5465	63.5	22.5	22.4	355	30
275-5466	63.5	35	33	331	30
271-8391	70	22.5	35	325	30
275-5463	70	35	35	384	30
275-5467	70	35	35	456	30
257-1792	70	35	35	370	30
257-1845*	70	35	35	439	30
275-5464	76	22.5	24	308	30
309-1076	76	35	35	379	30
286-2127	90	35	35	400	40
286-2126	90	35	35	469	40

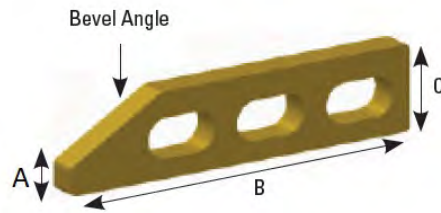

Cat Wear Protection

WEAR PRODUCT STANDS

The specially designed stands are engineered to support over 2,500 pounds of wear products. These stands come with integrated fork lift tubes for easy loading and moving. Reflective decals improve visibility. These stands provide a great means for selling, storing, and showcasing wear options. They can be placed at the point of use (parts store, warehouse, weld shop, fabrication shop) for easy storage or consignment plans. Finished with black gloss paint.

Stands						
Part #	Description	Height (mm)	Depth (mm)	Max Width (mm)	Weight Empty (kg)	Notes
495-0370	5' 5" Full Display Stand	1757	619	1924	282.1	Recommended stocking for a full stand. This allows for display of all types of parts and enough quantity to perform layout checks.
495-0371	3' 0" Half Display Stand	—			174.2	

Part #	Description	Quantity
494-8979	1" Chocky Bar	10
280-4088	1.5" Chocky Bar	10
280-4089	2" Chocky Bar	10
280-4090	2.5" Chocky Bar	10
280-4091	4" Chocky Bar	10
483-8264	6.5" Chocky Bar	4
280-4092	2.5" Wear Button	10
494-8981	3" Tear Drop Wear Button	10
280-4093	3.5" Wear Button	10
280-4094	4.5" Wear Button	8
280-4095	6" Wear Button	4
280-4096	1.5" Roll Bar	10
280-4097	2" Roll Bar	10
280-4098	3" Roll Bar	6
494-8980	5" Roll Bar	2
280-4099	6 x 8" Wear Block	2
494-8984	3 x 4" Wear Patch Block	6
494-8987	11" Trapezoidal Wear Block	2
494-8985	4 x 8.5" Skid Wear Block	6
494-8988	6 x 8" Bi-Metallic Wear Block	2
494-8986	1" Wear Lug	10
345-8061	Bolt Saver	6
494-8982	2" Manganese Wear Bar	10
494-8983	6 x 8" Manganese Wear Block	2



Full Stand



Half Stand





PEBJ0079-14

For more complete information on Cat products, dealer services, and industry solutions, visit us on the web at www.cat.com

©2021 Caterpillar
All Rights Reserved

Materials and specifications are subject to change without notice. Featured machines in photos may include additional equipment. See your Cat dealer for available options.

CAT, CATERPILLAR, LET'S DO THE WORK, their respective logos, "Caterpillar Yellow", the "Power Edge" and Cat "Modern Hex" trade dress as well as corporate and product identity used herein, are trademarks of Caterpillar and may not be used without permission.

