

# 320D2 GC

Hydraulic Excavator

2017



## Engine

Engine Model	Cat® C4.4 ACERT™	
Engine Power (ISO 14396)	93 kW	124 hp
Net Power (SAE J1349/ISO 9249)	85 kW	115 hp

## Weights

Minimum Operating Weight	20 100 kg	44,300 lb
Maximum Operating Weight	20 800 kg	45,900 lb

## 320D2 GC Features

### Engine and Hydraulics

Powered by a Cat C4.4 ACERT engine that meets Brazil emissions regulation MAR-1 combined with a highly efficient hydraulic system, the 320D2 GC delivers competitive performance with low fuel consumption and less sensitivity to low quality fuel.

### Structures

Caterpillar design and manufacturing techniques assure you get outstanding durability and service life in the right applications.

### Operator Station

The spacious cab features excellent visibility and easy-to-access switches. The monitor features a full-color graphical display that is user intuitive and highly visual. Overall, the cab provides you with a comfortable working environment for maximum production and efficiency.

### Reduced Service and Maintenance Cost

Routine service and maintenance can be completed quickly and easily to help you reduce ownership costs. Convenient access points, standard service intervals, and advanced filtration help keep downtime to a minimum.

### Complete Customer Support

Your Cat dealer offers a wide range of services that can be set up under a customer support agreement when you purchase your equipment.

### Cat 320D2 GC Total Solutions

Caterpillar and its extensive dealer network offer a wide variety of solutions designed to meet the unique needs of your business.

### Contents

Operator Station.....	4
Engine .....	6
Hydraulics .....	7
Undercarriage and Structures .....	8
Front Linkage .....	9
Attachments.....	9
Cat Connect Technologies.....	10
Service and Maintenance .....	12
Complete Customer Support.....	13
Safety .....	14
Specifications.....	15
Standard Equipment.....	24
Optional Equipment.....	25
Notes.....	26





**The new Cat 320D2 GC hydraulic excavator is engineered for low owning and operating costs, simple routine maintenance, high productivity and long-term durability. Equipped with a four-cylinder, turbocharged Cat C4.4 ACERT engine, the new model is exceptionally fuel efficient; the fuel saving is up to 17%, compared with 320D2. Fuel saving results may vary depending on applications, conditions, operator behavior, and other external factors.**

# Operator Station

Enhance your comfort, operation, and visibility.



## Operator Station

The ergonomically designed operator station is spacious, quiet, and comfortable, assuring high productivity during a long work day. All switches are located on the right-hand console for convenient access. HAVC console is under the left hand armrest.

## Monitor

The new monitor consists of the master caution lamp, buzzer, monitor display screen, and keypad. It has the capability of displaying information in 42 languages.

## Joystick Control

Low-effort pilot-operated joystick controls are designed to match your natural wrist and arm position for maximum comfort and minimum fatigue.

## Seat

The suspension seat provides a variety of adjustments to accommodate a wide range of operators. All seats include a reclining back, upper and lower seat slide adjustments, and height and tilt adjustments to meet operator needs for comfort and productivity.

The head rest can be adjusted to meet individual height preferences, improving operator comfort and productivity during the course of a day.

## Climate Control

Positive filtered ventilation with a pressurized cab is standard. Fresh air or re-circulated air can be selected with a switch on the left console.

## Cab Structure and Mounts

The cab shell is attached to the frame with viscous rubber cab mounts, which dampen vibrations and sound levels while enhancing operator comfort. Thick steel tubing along the bottom perimeter of the cab improves resistance to fatigue and vibration.

## Windows

To maximize visibility, all glass is affixed directly to the cab, eliminating window frames. The upper front windshield opens, closes, and stores on the roof above the operator with a one-touch release system.

## Wipers

Pillar-mounted wipers increase your operator's viewing area and offer continuous and intermittent modes.



# Engine

A powerful engine with excellent reliability and low fuel consumption delivering more while boosting your bottom line.

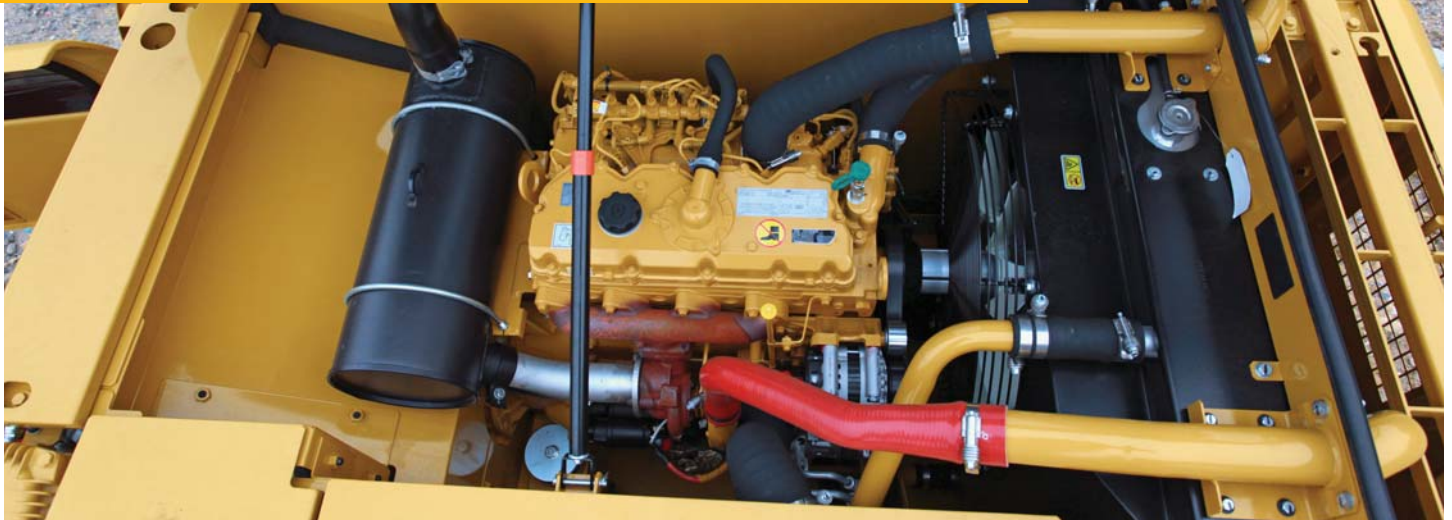

The Cat C4.4 ACERT engine with four cylinders meets Brazil emissions regulation MAR-1. The proven C4.4 ACERT engine incorporates robust components and precision manufacturing you can count on for reliable and efficient operation. Less sensitive to low quality fuel, it boasts improved reliability while delivering reduced fuel consumption.

## Automatic Engine Control

Automatic engine control is activated during no-load conditions; it reduces engine speed to minimize fuel consumption.

## Electric Priming Pump

This pump reduces the risk of fuel contamination by preventing unfiltered fuel from being backfilled during filter changes as was possible with a manual hand priming pump.

## Air Cleaner

The radial seal air filter features a double-layered filter core for more efficient filtration and is located in a compartment behind the cab.

A warning is displayed on the monitor when dust accumulates above a preset level.

## Filtration System

The fuel system features three filters to protect the machine from low-quality fuel. The benefit to you is greater reliability and uptime.

## Low Sound, Low Vibration

The Cat C4.4 ACERT engine improves operator comfort by reducing sound and vibration.

# Hydraulics

Efficient hydraulic system and low-effort joysticks provide precise control regardless of your application.



## Hydraulic System

Hydraulic system pressure of 35 000 kPa (5,076 psi) with 428 L/min (113.1 gal/min) flow from the two hydraulic pumps increases digging performance and productivity. Faster swing and travel speed were improved than last generation product.

## Pilot System

An independent pilot pump enables smooth, precise control for the front linkage, swing, and travel operations.

## Component Layout

The 320D2 GC hydraulic system and component locations have been designed to provide a high level of system efficiency. The main pumps, control valves, and hydraulic tank are located close together to allow for shorter tubes and lines between components, which reduce friction loss and pressure drops.

## Boom and Stick Regeneration Circuits

Boom and stick regeneration circuits save energy during boom-down and stick-in operation to increase efficiency, reduce cycle times and pressure loss for higher productivity, lower operating costs, and increased fuel efficiency.

## Hydraulic Cylinder Snubbers

Snubbers are located at the rod-end of the boom cylinders and both ends of the stick cylinders to cushion shocks while reducing sound levels and extending component life.

## Return Capsule Filter

The return capsule filter has a cartridge inside in order to avoid any contamination when accessing, enabling changing without oil spillage. The capsule filter with little micro meter mesh size is capable of filtering out impurities. A sensor indicates if the filter is clogged and sounds a warning to the operator through the monitor.



## Undercarriage and Structures

Strong and durable, all you expect from Cat excavators.

### Main Frame

The rugged main frame is extremely durable and designed for the toughest applications.

### Standard Undercarriage

Durable Cat undercarriage absorbs stresses and provides excellent stability. The standard undercarriage is well suited for applications that require frequent repositioning of the machine, restricted work space, or uneven rocky terrain.

### Carbody Design and Track Roller Frames

The X-shaped, box-section carbody provides excellent resistance to torsional bending. Robot-welded track roller frames are press-formed, pentagonal units to deliver exceptional strength and service life.

### Rollers and Idlers

Sealed and lubricated track rollers, carrier rollers, and idlers provide excellent service life to keep your machine in the field and working longer.





# Front Linkage

Reliable and durable to meet all your application needs.

Cat front linkages are designed for maximum versatility, productivity, and high efficiency.

## Boom and Sticks

The 320D2 GC is offered with a 5.7 m (18'8") reach boom and two stick configurations to meet your application requirements:

- The 2.5 m (8'2") stick is designed for large, high-volume earthmoving work.
- The 2.9 m (9'6") stick is a very good fit for truck loading and trenching applications.

# Attachments

Efficient for your work.



1



2

- 1) Utility Buckets (UD)
- 2) General Duty Buckets (GD)

## Buckets

Cat buckets and Cat Ground Engaging Tools (GET) are designed and matched to the machine to ensure optimal performance and fuel efficiency.

## Utility Buckets (UD)

These buckets are for digging in low-impact, low-abrasive material such as dirt, loam, and clay.

## General Duty Buckets (GD)

These buckets are designed for digging in low-impact, moderately abrasive materials such as dirt, loam, gravel, and clay.

## E Series Hammers

E Series hydraulic hammers for Cat excavators, and backhoes are matched to Cat machines for optimum performance and durability in a wide variety of demolition and construction applications.

## B Series Hammers

B Series hammers have outstanding field-proven reliability and durability for tough applications. High-grade steel and heat-treatment provides high output and good productivity.



# Cat Connect Technologies

Monitor, manage, and enhance job site operations.



Cat Connect makes smart use of technology and services to improve your job site efficiency. Using the data from technology-equipped machines, you'll get more information and insight into your equipment and operations than ever before.

Cat Connect technologies offer improvements in these key areas:



EQUIPMENT  
MANAGEMENT

**Equipment Management** – increase uptime and reduce operating costs.



PRODUCTIVITY

**Productivity** – monitor production and manage job site efficiency.



SAFETY

**Safety** – enhance job site awareness to keep your people and equipment safe.

## Cat Connect LINK Technologies

LINK technologies wirelessly connect you to your equipment, giving you access to essential information you need to know to run your business. Link data can give you valuable insight into how your machine or fleet is performing so you can make timely, fact-based decisions that can boost job site efficiency and productivity.

### Product Link™/VisionLink®

Product Link is deeply integrated into your machine, helping to take the guesswork out of equipment management. Easy access to timely information like machine location, hours, fuel usage, idle time and event codes via the online VisionLink user interface can help you effectively manage your fleet and lower operating costs.



# Service and Maintenance

Simplified service and maintenance features save you time and money.



## Ground-Level Service

The design and layout of the 320D2 GC was made with the service technician in mind. Most service locations are easily accessible at ground level to allow service and maintenance to get completed quickly and efficiently.

## Air Filter Compartment

The air filter features a double-element construction for superior cleaning efficiency. When the air filter plugs, a warning is displayed on the cab monitor. Maintenance-free batteries are standard along with a battery disconnect switch.

## Pump Compartment

A service door on the right side of the upper structure allows ground-level access to the hydraulic pumps, hydraulic filters, engine oil filter, and fuel filters.

## Radiator Compartment

The left rear service door allows easy access to the engine radiator, hydraulic oil cooler, air-to-air aftercooler, and AC condenser. A reserve tank and drain cock are attached to the radiator for ground level maintenance.

## Greasing Points

A concentrated remote greasing block on the boom allows the greasing of hard-to-reach locations on the boom and stick.

## Diagnostics and Monitoring

The 320D2 GC is equipped with Scheduled Oil Sampling (S·O·S<sup>SM</sup>) ports for the hydraulic system, engine oil, and coolant. Standard hydraulic test ports enable a service technician to quickly and easily find a problem in the event of service issue.



## Complete Customer Support

Cat dealer services offer a wide range of personalized solutions.

### **Product Support**

Cat dealers utilize a worldwide computer network to find in-stock parts to minimize machine downtime. You can also save money with our line of remanufactured components.

### **Machine Selection**

Your Cat dealers can provide specific recommendations with detailed comparisons of the Cat machines you are considering before you buy. This ensures you get the right size machine and appropriate work tools to meet all of your application needs.

### **Maintenance Services**

Repair option programs guarantee the cost of repairs up front. Condition monitoring services and diagnostic programs such as scheduled oil sampling, coolant sampling, and technical analysis help you avoid unscheduled repairs.

### **Customer Support Agreements**

Cat dealers offer a variety of product support agreements which can be tailored to meet your specific needs. These plans can cover the entire machine – including attachments – to help protect your investment.

### **Replacement**

Repair, rebuild, or replace? Your Cat dealers can help you evaluate the costs involved so you can make the right choice.

# Safety

Enhanced safety features.



**Anti-skid plating** covers the entire upper structure and storage box to prevent slipping during maintenance. Safety is further enhanced with the addition of countersunk bolts to reduce trip hazards.

The standard **hydraulic lockout lever** isolates all hydraulic and travel functions in the lowered position. It is specifically designed to not allow the operator to leave the cab without first lowering it.

**Three circuit breakers** protect critical electrical components to increase machine uptime.

A **battery disconnect switch** helps to deter theft by isolating the battery and enhances safety when servicing the machine.

A full length **firewall** separates the engine from the hydraulic pump and offers protection in the event of an incident.

Ground level **shut-off switch** stops all fuel to the engine when activated and shuts down the machine.

The engine radiator fan is enclosed by a steel **fan guard** that provides protection when carrying out routine service and maintenance.

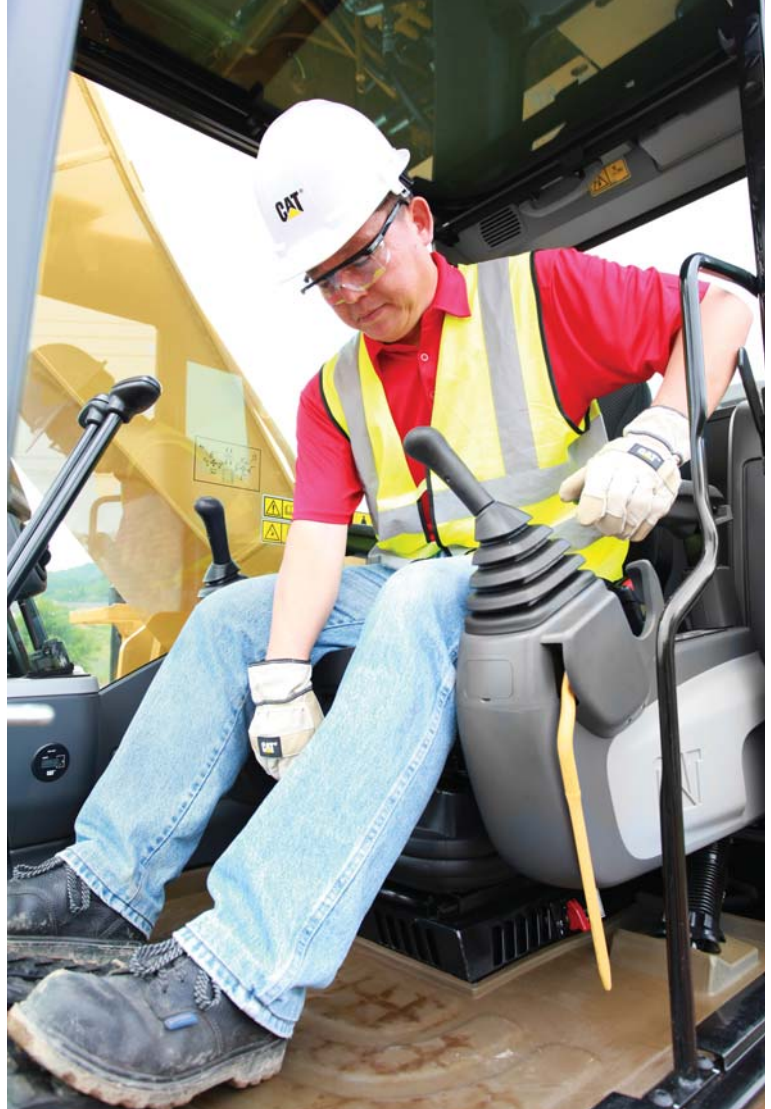

# 320D2 GC Hydraulic Excavator Specifications

## Engine

Engine Model	C4.4 ACERT	
Engine Power – ISO 14396	93 kW	124 hp
Net Power – SAE J1349/ISO 9249	85 kW	115 hp
Engine rpm		
Operation	1,800 rpm	
Travel	1,800 rpm	
Bore	105 mm	4.13 in
Stroke	127 mm	5.00 in
Displacement	4.4 L	269 in <sup>3</sup>

- The 320D2 GC meets Brazil emissions regulation MAR-1.
- No engine power derating required below 3000 m (9,843 ft) altitude.
- Net power advertised is the power available at the flywheel when the engine is equipped with fan, air cleaner, muffler and alternator.
- Power rating at 2,200 rpm.

## Weights

Maximum Operating Weight*	20 800 kg	45,900 lb
Minimum Operating Weight**	20 100 kg	44,300 lb

\*R5.7 (18'8") reach boom, R2.9B1 (9'6") reach stick, GD 1.0 m<sup>3</sup> (1.3 yd<sup>3</sup>) bucket and 790 mm (31") shoes.

\*\*R5.7 (18'8") reach boom, R2.5B1 (8'2") reach stick, GD 1.0 m<sup>3</sup> (1.3 yd<sup>3</sup>) bucket and 600 mm (24") shoes.

## Track

Number of Shoes Each Side	45 pieces	
Number of Track Rollers Each Side	7 pieces	
Number of Carrier Rollers Each Side	2 pieces	

## Swing Mechanism

Swing Speed	11.9 rpm	
Maximum Swing Torque	74 kN·m	54,440 lbf-ft

## Drive

Maximum Gradeability	35°/70%	
Maximum Travel Speed		
High	5.8 km/h	3.6 mph
Low	3.6 km/h	2.2 mph
Maximum Drawbar Pull	206 kN	46,311 lb

## Hydraulic System

Main System – Maximum Flow (total)	428 L/min	113.1 gal/min
Maximum Pressure	35 MPa	5,076 psi
Maximum Pressure – Swing	25 MPa	3,626 psi
Pilot System – Maximum Flow (total)	23.1 L/min	6.1 gal/min
Pilot System – Maximum Pressure	3900 kPa	566 psi
Boom Cylinder – Bore	120 mm	4.7 in
Boom Cylinder – Stroke	1260 mm	49.6 in
Stick Cylinder – Bore	140 mm	5.5 in
Stick Cylinder – Stroke	1504 mm	59.2 in
Bucket Cylinder – Bore	120 mm	4.7 in
Bucket Cylinder – Stroke	1104 mm	43.5 in

## Service Refill Capacities

Fuel Tank Capacity	410 L	108.3 gal
Cooling System	25 L	6.6 gal
Engine Oil	16 L	4.2 gal
Swing Drive	8 L	2.1 gal
Final Drive	8 L	2.1 gal
Hydraulic System Oil (including tank)	260 L	68.7 gal
Hydraulic Tank Oil	138 L	36.5 gal

## Sound Performance

ISO 6395 (External Sound Power Level)	101 dB(A)
ISO 6396 (Interior Sound Pressure Level)	69 dB(A)

- When properly installed and maintained, the cab offered by Caterpillar, when tested with doors and windows closed according to ANSI/SAE J1166 OCT98, meets requirements for operator sound exposure limits in effect at time of manufacture.
- Hearing protection may be needed when operating with an open operator station and cab (when not properly maintained or doors/windows open) for extended periods or in a noisy environment.

## Standards

Brakes	SAE J1026/APR90
Cab/FOGS	SAE J1356 FEB88 ISO 10262:1998

# 320D2 GC Hydraulic Excavator Specifications

## Dimensions

All dimensions are approximate.

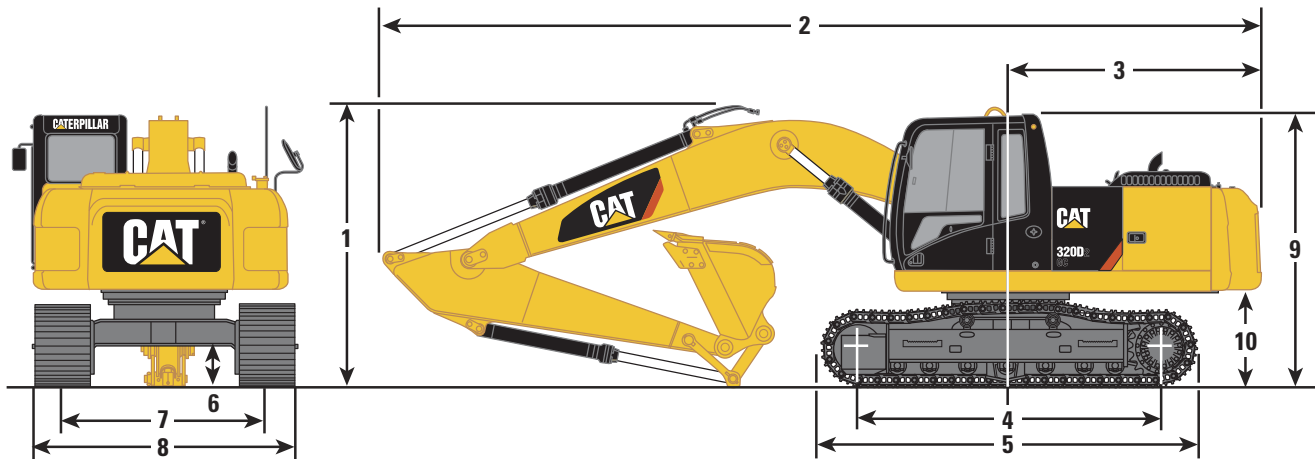

Boom Options	Reach Boom* 5.7 m (18'8")	Reach Boom* 5.7 m (18'8")
<b>Stick Options</b>	<b>R2.9B1 (9'6")</b>	<b>R2.5B1 (8'2")</b>
<b>1</b> Shipping Height**	3030 mm (9'11")	3050 mm (10'0")
<b>2</b> Shipping Length	9460 mm (31'0")	9460 mm (31'0")
<b>3</b> Tail Swing Radius	2750 mm (9'0")	2750 mm (9'0")
<b>4</b> Length to Center of Rollers	3270 mm (10'9")	3270 mm (10'9")
<b>5</b> Track Length	4080 mm (13'5")	4080 mm (13'5")
<b>6</b> Ground Clearance***	450 mm (1'6")	450 mm (1'6")
<b>7</b> Track Gauge		
Standard Undercarriage (shipping)	2200 mm (7'3")	2200 mm (7'3")
<b>8</b> Transport Width		
Standard Undercarriage		
600 mm (24") Shoes	2800 mm (9'2")	2800 mm (9'2")
790 mm (31") Shoes	2990 mm (9'10")	2990 mm (9'10")
<b>9</b> Cab Height***	2950 mm (9'8")	2950 mm (9'8")
<b>10</b> Counterweight Clearance***	1020 mm (3'4")	1020 mm (3'4")
Bucket Type	UD	UD
Bucket Tip Radius	1490 mm (4'11")	1560 mm (5'1")

\*With UD 0.90 m<sup>3</sup> (1.17 yd<sup>3</sup>) bucket.

\*\*Including shoe lug height.

\*\*\*Without shoe lug height.



# 320D2 GC Hydraulic Excavator Specifications

## Working Ranges

All dimensions are approximate.

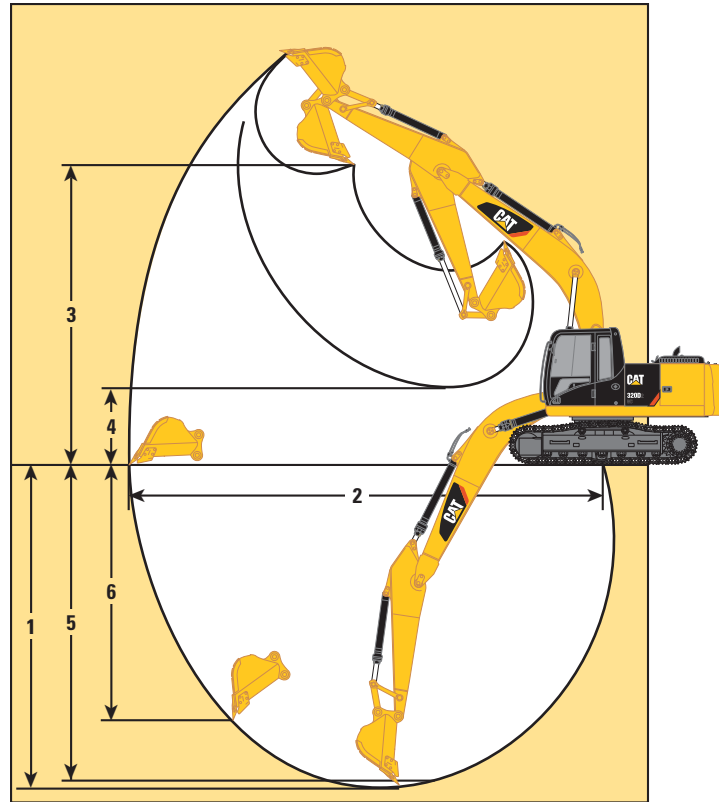

Boom Options	Reach Boom 5.7 m (18'8")	Reach Boom 5.7 m (18'8")	Reach Boom 5.7 m (18'8")
Stick Options	R2.9B1 (9'6")	R2.9B1 (9'6")	R2.5B1 (8'2")
Bucket Type/Capacity	UD 0.9 m <sup>3</sup> (1.17 yd <sup>3</sup> )	GD 1.0 m <sup>3</sup> (1.3 yd <sup>3</sup> )	GD 1.0 m <sup>3</sup> (1.3 yd <sup>3</sup> )
Bucket Tip Radius	1490 mm (4'11")	1560 mm (5'1")	1560 mm (5'1")
1 Maximum Digging Depth	6640 mm (21'9")	6730 mm (22'1")	6310 mm (20'8")
2 Maximum Reach at Ground Line	9780 mm (32'1")	9870 mm (32'5")	9470 mm (31'1")
3 Maximum Loading Height	6570 mm (21'7")	6490 mm (21'4")	6290 mm (20'8")
4 Minimum Loading Height	2250 mm (7'5")	2170 mm (7'1")	2590 mm (8'6")
5 Maximum Depth Cut for 2240 mm (8 ft) Level Bottom	6470 mm (21'3")	6560 mm (21'6")	5960 mm (19'7")
6 Maximum Vertical Wall Digging Depth	6010 mm (19'9")	5750 mm (18'10")	5350 mm (17'7")
Bucket Digging Force (SAE)	132 kN (29,700 lbf)	124 kN (27,900 lbf)	124 kN (27,900 lbf)
Bucket Digging Force (ISO)	147 kN (33,000 lbf)	140 kN (31,500 lbf)	140 kN (31,500 lbf)
Stick Digging Force (SAE)	105 kN (23,600 lbf)	104 kN (23,400 lbf)	114 kN (25,600 lbf)
Stick Digging Force (ISO)	108 kN (24,300 lbf)	107 kN (24,100 lbf)	118 kN (26,500 lbf)

# 320D2 GC Hydraulic Excavator Specifications

## Operating Weight and Ground Pressure

	790 mm (31") Triple Grouser Shoes		600 mm (24") Triple Grouser Shoes	
	Weight	Ground Pressure	Weight	Ground Pressure
Reach Boom – 5.7 m (18'8")				
R2.9 (9'6") Stick, UD 0.9 m <sup>3</sup> (1.17 yd <sup>3</sup> ) Bucket	20 700 kg (45,600 lb)	36.2 kPa (5.2 psi)	20 100 kg (44,300 lb)	46.3 kPa (6.7 psi)
R2.9 (9'6") Stick, GD 1.0 m <sup>3</sup> (1.3 yd <sup>3</sup> ) Bucket	20 800 kg (45,900 lb)	36.4 kPa (5.3 psi)	20 200 kg (44,500 lb)	46.5 kPa (6.7 psi)
R2.5 (8'2") Stick, GD 1.0 m <sup>3</sup> (1.3 yd <sup>3</sup> ) Bucket	20 700 kg (45,600 lb)	36.2 kPa (5.2 psi)	20 100 kg (44,300 lb)	46.3 kPa (6.7 psi)

## Major Component Weights

Base Machine (includes boom cylinders, pins, fluids, operator)	6330 kg (13,960 lb)
Standard Undercarriage	4180 kg (9,220 lb)
Counterweight	3700 kg (8,160 lb)
Boom (includes lines, pins and stick cylinder)	
Reach Boom – 5.7 m (18'8")	1660 kg (3,660 lb)
Stick (includes lines, pins, bucket cylinder and bucket linkage)	
R2.9B1 (9'6")	980 kg (2,160 lb)
R2.5B1 (8'2")	960 kg (2,120 lb)
Track Shoes (Standard/per two track)	
600 mm (24") Triple Grouser Shoes	2460 kg (5,420 lb)
790 mm (31") Triple Grouser Shoes	3060 kg (6,750 lb)
Bucket (with sidecutter and tip)	
UD 0.9 m <sup>3</sup> (1.17 yd <sup>3</sup> )	790 kg (1,740 lb)
GD 1.0 m <sup>3</sup> (1.3 yd <sup>3</sup> )	850 kg (1,870 lb)

ISO 6016 Operating Weight Criteria: Base Machine with fronts, bucket, full fuel tank (and fluids), 75 kg (165 lb) operator. This standard excludes optional attachments.

# 320D2 GC Hydraulic Excavator Specifications

## Bucket Specifications and Compatibility

	Linkage	Width		Capacity		Weight		Fill	Reach Boom		Reach Boom	
		mm	in	m <sup>3</sup>	yd <sup>3</sup>	kg	lb		%	R2.9 (9'6")		R2.5 (8'2")
										600 mm (24") Triple Grouser Shoes	790 mm (31") Triple Grouser Shoes	600 mm (24") Triple Grouser Shoes
<b>Without Pin Grabber Coupler</b>												
Utility Duty (UD)	B	1150	46	0.90	1.18	725	1,598	100%	⊙	●	●	
General Duty (GD)	B	1050	42	1.00	1.31	729	1,607	100%	⊙	⊙	⊙	
Heavy Duty (HD)	B	1050	42	1.00	1.31	942	2,077	100%	⊖	⊙	⊙	
Maximum load pin-on (payload + bucket)								kg	2586	2735	2765	
								lb	5,702	6,029	6,096	

The above loads are in compliance with hydraulic excavator standard EN474, they do not exceed 87% of hydraulic lifting capacity or 75% of tipping capacity with front linkage fully extended at ground line with bucket curled.

Capacity based on ISO 7451.

Bucket weight with Long tips.

### Maximum Material Density:

- 2100 kg/m<sup>3</sup> (3,500 lb/yd<sup>3</sup>)
- ⊙ 1800 kg/m<sup>3</sup> (3,000 lb/yd<sup>3</sup>)
- ⊖ 1500 kg/m<sup>3</sup> (2,500 lb/yd<sup>3</sup>)

## Work Tool Offering Guide\*

Boom Type	Reach
Stick Size	R2.9 (9'6")
Hydraulic Hammer	H115Es H120Es B20**

These work tools are available for the 320D2 GC.  
Consult your Cat dealer for proper match.

\*Offerings not available in all areas. Matches are dependent on excavator configurations. Consult your Cat dealer to determine what is offered in your area and for proper work tool match.

\*\*Match; Pin-on or CW.

# 320D2 GC Hydraulic Excavator Specifications

## Reach Boom Lift Capacities – without Bucket Linkage

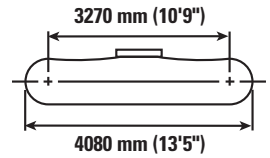
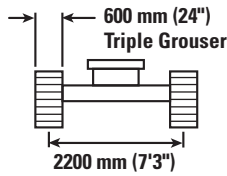
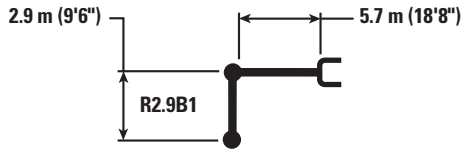

		1500 mm/60 in		3000 mm/120 in		4500 mm/180 in		6000 mm/240 in		7500 mm/300 in		mm in		
7500 mm 300 in	kg lb							*4500 4500				*3900 *8,700	*3900 *8,700	6150 240
6000 mm 240 in	kg lb							*4950 *10,850	4500 9,650			*3650 *8,000	3250 7,200	7290 290
4500 mm 180 in	kg lb							*5450 *11,850	4350 9,350	4500 9,650	3050 6,550	*3550 *7,800	2750 6,050	7990 320
3000 mm 120 in	kg lb					*7950 *17,150	6250 13,500	6200 13,350	4150 8,900	4400 9,450	2950 6,350	*3650 *8,000	2500 5,500	8360 330
1500 mm 60 in	kg lb					9200 19,800	5800 12,500	5950 12,800	3900 8,400	4300 9,200	2850 6,100	3600 7,900	2400 5,250	8450 340
0 mm 0 in	kg lb			*6200 *14,300	*6200 *14,300	8900 19,150	5550 11,950	5800 12,400	3750 8,050	4200 9,050	2750 5,950	3700 8,100	2450 5,350	8260 330
-1500 mm -60 in	kg lb	*6650 *14,850	*6650 *14,850	*10 750 *24,400	10 300 22,100	8850 18,950	5450 11,750	5700 12,250	3700 7,900	4150 9,000	2750 5,900	4000 8,750	2600 5,750	7780 310
-3000 mm -120 in	kg lb	*11 400 *25,600	*11 400 *25,600	*14 150 *30,650	10 450 22,450	8900 19,050	5500 11,850	5750 12,300	3700 8,000			4700 10,400	3100 6,800	6950 280
-4500 mm -180 in	kg lb			*11 300 *24,150	10 800 23,200	*8100 *17,250	5700 12,300					*6150 *13,450	4250 9,550	5600 220



ISO 10567



\*Indicates that the load is limited by hydraulic lifting capacity rather than tipping load. The above loads are in compliance with hydraulic excavator lift capacity standard ISO 10567:2007. They do not exceed 87% of hydraulic lifting capacity or 75% of tipping load. Weight of all lifting accessories must be deducted from the above lifting capacities. Lifting capacities are based on the machine standing on a firm, uniform supporting surface. The use of a work tool attachment point to handle/lift objects, could affect the machine lift performance.

Lift capacity stays with ±5% for all available track shoes.

Always refer to the appropriate Operation and Maintenance Manual for specific product information.

# 320D2 GC Hydraulic Excavator Specifications

## Reach Boom Lift Capacities – without Bucket Linkage

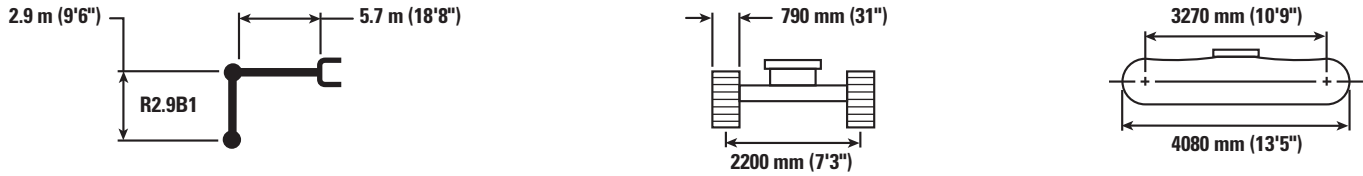

		1500 mm/60 in		3000 mm/120 in		4500 mm/180 in		6000 mm/240 in		7500 mm/300 in		mm in		
7500 mm 300 in	kg lb							*4500	*4500			*3900 *8,700	*3900 *8,700	6150 240
6000 mm 240 in	kg lb							*4950 *10,850	4600 9,900			*3650 *8,000	3350 7,450	7290 290
4500 mm 180 in	kg lb							*5450 *11,850	4500 9,600	4650 9,950	3150 6,750	*3550 *7,800	2850 6,250	7990 320
3000 mm 120 in	kg lb					*7950 *17,150	6450 13,900	*6250 *13,550	4250 9,150	4550 9,750	3050 6,550	*3650 *8,000	2600 5,650	8360 330
1500 mm 60 in	kg lb					9500 20,400	6000 12,900	6150 13,200	4050 8,650	4450 9,500	2950 6,300	3700 8,150	2500 5,450	8450 340
0 mm 0 in	kg lb			*6200 *14,300	*6200 *14,300	9200 19,700	5700 12,300	5950 12,800	3850 8,350	4350 9,300	2850 6,150	3800 8,350	2500 5,500	8260 330
-1500 mm -60 in	kg lb	*6650 *14,850	*6650 *14,850	*10 750 *24,400	10 650 22,800	9100 19,500	5650 12,150	5900 12,650	3800 8,150	4300 9,250	2850 6,100	4100 9,050	2700 5,950	7780 310
-3000 mm -120 in	kg lb	*11 400 *25,600	*11 400 *25,600	*14 150 *30,650	10 800 23,150	9150 19,650	5700 12,250	5900 12,700	3850 8,250			4850 10,700	3200 7,050	6950 280
-4500 mm -180 in	kg lb			*11 300 *24,150	11 100 23,900	*8100 *17,250	5900 12,700					*6150 *13,450	4400 9,850	5600 220



ISO 10567



\*Indicates that the load is limited by hydraulic lifting capacity rather than tipping load. The above loads are in compliance with hydraulic excavator lift capacity standard ISO 10567:2007. They do not exceed 87% of hydraulic lifting capacity or 75% of tipping load. Weight of all lifting accessories must be deducted from the above lifting capacities. Lifting capacities are based on the machine standing on a firm, uniform supporting surface. The use of a work tool attachment point to handle/lift objects, could affect the machine lift performance.

Lift capacity stays with ±5% for all available track shoes.

Always refer to the appropriate Operation and Maintenance Manual for specific product information.

# 320D2 GC Hydraulic Excavator Specifications

## Reach Boom Lift Capacities – without Bucket Linkage

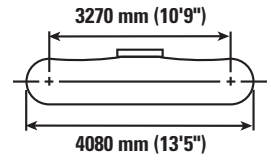
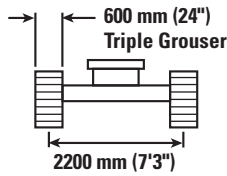
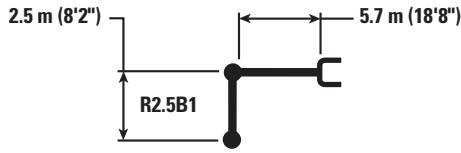

		3000 mm/120 in		4500 mm/180 in		6000 mm/240 in		7500 mm/300 in				mm in
7500 mm 300 in	kg lb									*4750 *10,500	*4750 *10,500	5600 220
6000 mm 240 in	kg lb					*5350 *11,800	4450 9,500			*4350 *9,550	3550 7,950	6830 270
4500 mm 180 in	kg lb			*6750 *14,550	6650 14,350	*5800 *12,600	4300 9,250	4450	3000	*4250 *9,350	2950 6,550	7570 300
3000 mm 120 in	kg lb			*8500 *18,300	6150 13,250	6150 13,200	4100 8,800	4400 9,400	2950 6,300	4000 8,800	2650 5,900	7960 320
1500 mm 60 in	kg lb			9100 19,600	5700 12,350	5900 12,700	3850 8,350	4300 9,200	2850 6,100	3850 8,500	2550 5,650	8050 320
0 mm 0 in	kg lb			8900 19,050	5500 11,850	5750 12,400	3750 8,050	4200 9,050	2800 5,950	3950 8,700	2600 5,750	7860 310
-1500 mm -60 in	kg lb	*11 300 *25,750	10 400 22,300	8850 18,950	5500 11,800	5700 12,300	3700 7,950			4300 9,500	2850 6,250	7350 290
-3000 mm -120 in	kg lb	*13 250 *28,750	10 600 22,700	8950 19,200	5550 12,000	5800 12,450	3750 8,100			5250 11,600	3450 7,600	6470 260
-4500 mm -180 in	kg lb			*7200 *15,050	5800 12,550					*6200 *13,600	5100 11,500	4980 200



ISO 10567



\*Indicates that the load is limited by hydraulic lifting capacity rather than tipping load. The above loads are in compliance with hydraulic excavator lift capacity standard ISO 10567:2007. They do not exceed 87% of hydraulic lifting capacity or 75% of tipping load. Weight of all lifting accessories must be deducted from the above lifting capacities. Lifting capacities are based on the machine standing on a firm, uniform supporting surface. The use of a work tool attachment point to handle/lift objects, could affect the machine lift performance.









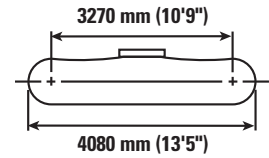
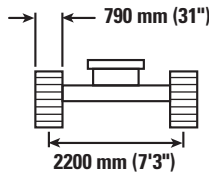
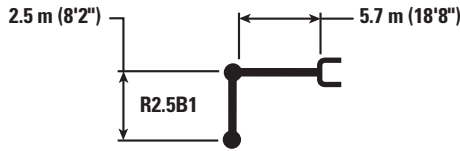

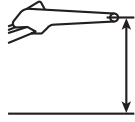

Lift capacity stays with  $\pm 5\%$  for all available track shoes.

Always refer to the appropriate Operation and Maintenance Manual for specific product information.

# 320D2 GC Hydraulic Excavator Specifications

## Reach Boom Lift Capacities – without Bucket Linkage



		3000 mm/120 in		4500 mm/180 in		6000 mm/240 in		7500 mm/300 in				mm in
												
7500 mm 300 in	kg lb									*4750 *10,500	*4750 *10,500	5600 220
6000 mm 240 in	kg lb					*5350 *11,800	4550 9,750			*4350 *9,550	3650 8,150	6830 270
4500 mm 180 in	kg lb			*6750 *14,550	*6750 *14,550	*5800 *12,600	4400 9,450	4600 3100		*4250 *9,350	3050 6,750	7570 300
3000 mm 120 in	kg lb			*8500 *18,300	6300 13,600	6300 13,550	4200 9,000	4500 9,650	3000 6,450	4100 9,050	2750 6,050	7960 320
1500 mm 60 in	kg lb			9350 20,150	5900 12,650	6100 13,050	4000 8,600	4400 9,450	2900 6,300	3950 8,700	2650 5,800	8050 320
0 mm 0 in	kg lb			9150 19,600	5700 12,200	5950 12,750	3850 8,300	4350 9,300	2850 6,150	4050 8,950	2700 5,900	7860 310
-1500 mm -60 in	kg lb	*11 300 *25,750	10 700 22,900	9100 19,500	5650 12,150	5900 12,650	3800 8,200			4450 9,800	2950 6,450	7350 290
-3000 mm -120 in	kg lb	*13 250 *28,750	10 900 23,350	9200 19,750	5750 12,350	5950 12,800	3850 8,350			5400 11,950	3550 7,800	6470 260
-4500 mm -180 in	kg lb			*7200 *15,050	6000 12,900					*6200 *13,600	5200 11,800	4980 200



ISO 10567



\*Indicates that the load is limited by hydraulic lifting capacity rather than tipping load. The above loads are in compliance with hydraulic excavator lift capacity standard ISO 10567:2007. They do not exceed 87% of hydraulic lifting capacity or 75% of tipping load. Weight of all lifting accessories must be deducted from the above lifting capacities. Lifting capacities are based on the machine standing on a firm, uniform supporting surface. The use of a work tool attachment point to handle/lift objects, could affect the machine lift performance.

Lift capacity stays with ±5% for all available track shoes.

Always refer to the appropriate Operation and Maintenance Manual for specific product information.



# 320D2 GC Standard Equipment

## Standard Equipment

Standard equipment may vary. Consult your Cat dealer for details.

### ENGINE

- Cat C4.4 ACERT diesel engine
- Biodiesel capable up to B20
- Meets Brazil emissions regulation MAR-1
- 3000 m (9,843 ft) altitude capability
- Radial seal air filters (primary and secondary filter)
- Glow plugs (for cold weather start)
- Automatic engine speed control with one touch low idle
- High ambient cooling package
- Starting kit, cold weather, <math>-18^{\circ}\text{C}</math> (- Water separator with water level indicator
- Waved fin radiator with space for cleaning
- Two speed travel
- Electric priming pump

### HYDRAULIC SYSTEM

- Regeneration circuit for boom and stick
- Reverse swing dampening valve
- Automatic swing parking brake
- Boom drift reducing valve
- Stick drift reducing valve
- High performance hydraulic return filters

### CAB

- Pressurized cab
- Fully adjustable mechanical suspension seat
- Adjustable armrest
- Flexible seat belt, retractable (51 mm [2 in] width)
- 70/30 split front windshield
- Laminated upper front windshield and tempered other windows
- Sliding upper door window
- Openable front windshield with assist device
- Pillar mounted upper windshield wiper and washer
- Bi-level air conditioner (automatic) with defroster (pressurized function)
- Color LCD display with warning, filter/fluid change, and working hour information
- Control lever joysticks
- Neutral lever (lock out) for all controls
- Travel control pedals with removable hand levers
- Radio mounting (DIN size)
- Two stereo speakers
- Beverage holder
- Coat hook
- Ashtray and lighter
- Storage compartment for lunch box
- Openable roof hatch
- Washable floor mat
- Roll down sunscreen

### UNDERCARRIAGE

- Idler and center section track guiding guard
- Towing eye on base frame
- Grease lubricated track

### ELECTRICAL

- Batteries (2 × 750 CCA)

### FRONT LINKAGE

- R5.7 m (18'8") reach boom with left side light
- Bucket linkage

### LIGHTS

- Left boom working light
- Right working light, storage box mounted
- Interior lighting

### SECURITY

- Cat one key security system
- Door and compartment locks
- Signaling/warning horn
- Rearview mirrors
- Fire wall between engine and pump compartment
- Emergency engine shutoff switch
- Rear window, emergency exit
- Battery disconnect switch

### COUNTERWEIGHT

- 3.7 mt (4.1 t) counterweight

### TECHNOLOGY

- Product Link
- Cat data link receptacle



## Optional Equipment

Optional equipment may vary. Consult your Cat dealer for details.

### ENGINE

- Block heater (dealer installed option)
- Air prefilter for Waste and Forestry application (consult your dealer)
- Electric refueling pump with auto shut off

### HYDRAULIC SYSTEM

- Hammer circuit, foot pedal operated
- Boom and stick high pressure lines
- Multi viscous oil

### UNDERCARRIAGE

- 600 mm (24") triple grouser shoes
- 790 mm (31") triple grouser shoes

### FRONT LINKAGE

- R2.9B1 (9'6") reach stick
- R2.5B1 (8'2") reach stick

### SECURITY

- Travel alarm

### LIGHT

- Halogen cab-mounted working lights





For more complete information on Cat products, dealer services, and industry solutions, visit us on the web at [www.cat.com](http://www.cat.com)

AEHQ7970  
(Brazil)

© 2016 Caterpillar  
All rights reserved

Materials and specifications are subject to change without notice. Featured machines in photos may include additional equipment. See your Cat dealer for available options.

CAT, CATERPILLAR, SAFETY.CAT.COM, their respective logos, "Caterpillar Yellow" and the "Power Edge" trade dress, as well as corporate and product identity used herein, are trademarks of Caterpillar and may not be used without permission.

VisionLink is a trademark of Trimble Navigation Limited, registered in the United States and in other countries.

