

318D L Series 2

Hydraulic Excavator

2017



Engine

Engine Model	C4.4 ACERT™	
Engine Power (ISO 14396)	93 kW	125 hp
Net Power (SAE J1349/ISO 9249)	84 kW	113 hp

Weights

Operating Weight – Long Undercarriage	17 000-	37,490-
	17 800 kg	39,250 lb

318D L Series 2 Features

Engine and Hydraulics

A powerful C4.4 ACERT electrically controlled engine that meets U.S. EPA Tier 3, EU Stage IIIA, Japan 2006 (Tier 3) equivalent or China Stage III Nonroad emission standards, combined with a highly efficient hydraulics system provide excellent machine performance with low fuel consumption.

Structures

Caterpillar design and manufacturing techniques assure outstanding durability and service life in the toughest applications.

Operator Station

The spacious cab features excellent visibility and easy-to-access switches. The monitor features a full-color graphical display that is user intuitive and highly visual with built-in pre-start machine checks. Overall, the new cab provides a comfortable working environment for efficient day-long operation.

Service and Maintenance

This machine has been designed so that routine service and maintenance can be completed quickly and easily to help reduce ownership costs. Convenient access points with extended intervals and advanced filtration keep downtime to a minimum.

Complete Customer Support

Your Cat® dealer offers a wide range of services that can be set up under a customer support agreement when you purchase your equipment.

Cat 318D L Series 2 Total Solutions

Caterpillar and its extensive dealer network offer a wide variety of solutions designed to meet the unique needs of your business.

Contents

Operator Station.....	4
Engine	5
Hydraulics	6
Undercarriage and Structures	7
Front Linkage	7
Work Tools.....	8
Serviceability.....	10
Complete Customer Support.....	11
Specifications.....	12
Standard Equipment.....	31
Optional Equipment.....	32
Notes.....	33





Increased horsepower, improved controllability, and a comfortable operator station help make the Cat 318D L Series 2 hydraulic excavator an industry-leading performer. Easy to operate with unmatched versatility, the 318D L Series 2 will help increase your productivity and lower your operating costs.

Operator Station

New levels of comfort, visibility and operation.

Operator Station

The ergonomically designed operator station is spacious, quiet, and comfortable, assuring high productivity during a long work day. All switches are located on the right-hand console for convenient access.

Monitor

The monitor is a full-color Liquid Crystal Display (LCD) that can be adjusted to minimize sun glare and has the capability of displaying information in 27 languages.

Joystick Control

Low-effort pilot-operated joystick controls are designed to match the operator's natural wrist and arm position for maximum comfort and minimum fatigue.

Seat

The standard suspension seat provides a variety of adjustments to suit the operator's size and weight including fore/aft height and weight. Wide adjustable armrests and a seat belt are also included.

Console

The consoles feature a simple functional design to reduce operator fatigue, ease of switch operation, and excellent visibility. Both consoles have attached armrests with tilting adjustments.

Cab Exterior

The cab shell features thick steel tubing along the bottom perimeter of the cab, improving resistance to fatigue and vibration.

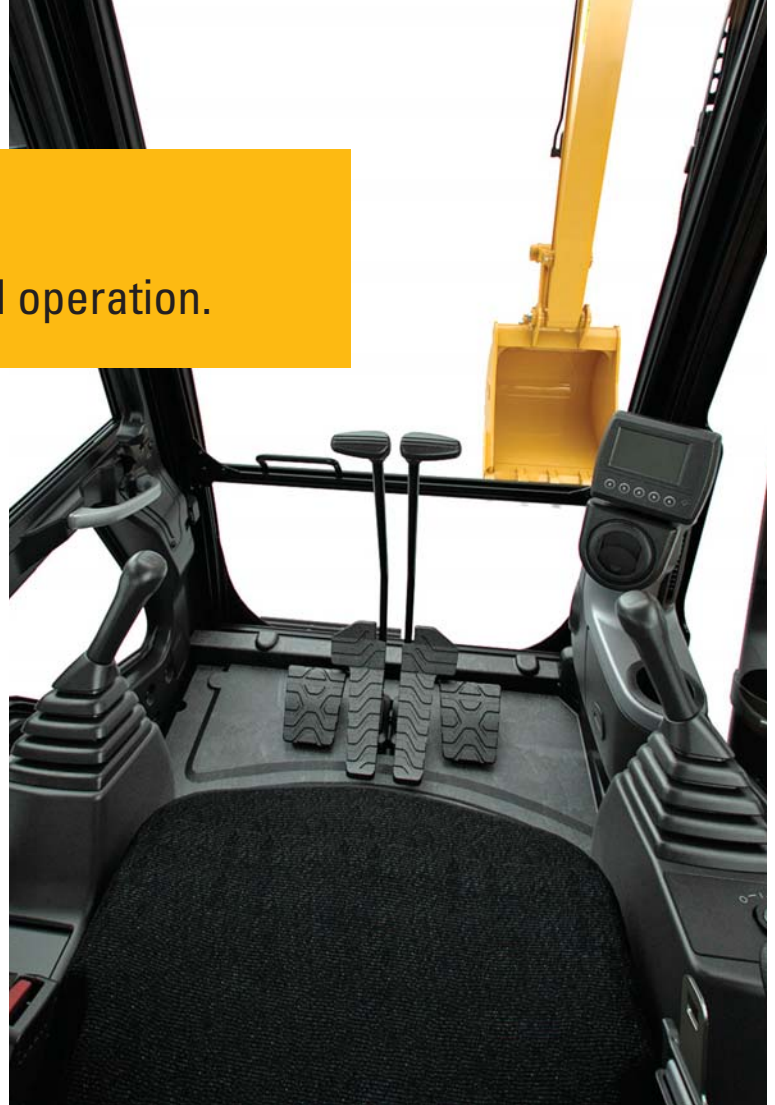

Cab Mounts

The cab shell is attached to the frame with viscous rubber cab mounts, which dampen vibrations and sound levels while enhancing operator comfort.

Windows

To maximize visibility, all glass is affixed directly to the cab, eliminating window frames. The upper front windshield opens, closes, and stores on the roof above the operator with a one-touch action release system.

Wipers

Pillar-mounted wipers increase the operator's viewing area and offer continuous and intermittent modes.

Engine

Delivering the most work per liter/gallon of fuel consumed.

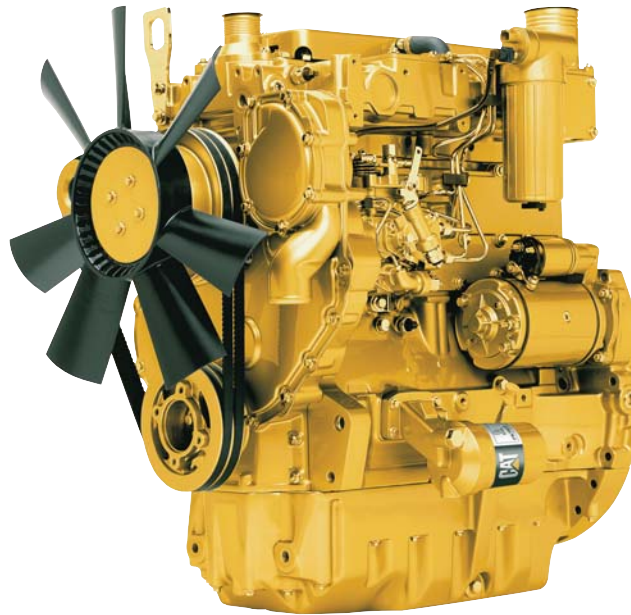

The Cat C4.4 ACERT electronically controlled engine has been designed to meet Tier 3, Stage IIIA, Japan 2006 (Tier 3) equivalent or China Stage III Nonroad emission standards. This engine incorporates a time-proven mechanical governor and a low-pressure fuel injection system that are major contributors to the improvement of fuel system robustness, high fuel efficiency, and ease of troubleshooting. High filtration performance from the primary filter incorporating a water separator and a secondary filter also help to improve fuel filtration system reliability.

Automatic Engine Control and Fuel Delivery

With a net power of 84 kW (113 hp) the 318D L Series 2 has been designed with fuel economy in mind and burns approximately 3% less fuel when compared with the larger 318D L depending on application.

Economy Mode

Available as a standard feature, economy mode allows you to balance the demands of performance and fuel economy while maintaining the breakout forces and lift capacity enjoyed at standard power.



Hydraulics

High efficiency and performance with low effort and precise control.

Outstanding Performance

The 318D L Series 2 hydraulic system is designed for high efficiency and performance. The new compact design utilizes shorter tubes and lines to reduce friction and pressure drops, resulting in a more efficient use of power.

- Hydraulic snubbers at the rod end of the boom cylinders and both ends of the stick cylinders cushion shock, reduce sound, and increase cylinder life.
- A hydraulic cross-sensing system uses two hydraulic pumps under all operating conditions, improving productivity with faster implement speeds and quicker, stronger pivot turns.

Boom and Stick Regeneration Circuit

The boom and stick regeneration circuit saves energy during boom-down and stick-in operation, increasing efficiency and lowering operating cost.

Easy Operation

Operators do not need to learn different modes. An automatic boom and swing priority function automatically selects the best mode based on joystick movement.

Undercarriage and Structures

Excellent stability and maneuverability.

Caterpillar uses advanced engineering and software to analyze all structures, creating a durable, reliable machine for robust applications. More than 70 percent of the structural welds are robotic and achieve additional penetration over manual welds. These structural components and undercarriage are the backbone of the machine's durability.

Carbody Design

X-shaped, box-section carbody provides excellent resistance to torsional bending. Robot-welded track roller frames are press-formed, pentagonal units that deliver exceptional strength and service life. Integral to the track roller frame are the standard idler and center guards, which help maintain track alignment when traveling or working on slopes.

Grease Lubricated Track

Grease lubricated track seals protect the track link and deliver long track link pin and bushing inner wear life.

Travel Motors

Travel motors with automatic speed selection let the 318D L Series 2 automatically change up and down from high and low speeds in a smooth, controlled manner.



Front Linkage

Performance, reliability and durability.

Built for performance and long service life, Cat booms and sticks are welded, box-section structures with thick multi-plate high-strength steel fabrications.

Heavy Duty Stick*

A 2.6 m (8'6") heavy-duty stick has additional plates, new forged parts, and welded joints for increased durability, and digging force.

Reach Stick*

A 2.6 m (8'6") and a 2.9 m (9'6") reach stick maximizes the digging envelope. It is made of high-tensile-strength steel using a large box-section design with interior baffle plates for increased durability.

Reach Boom

The 5.1 m (16'9") reach boom features parts made from a new forging pattern and additional, thicker plates. A light attached to the left side offers improved visibility in dark and low-light conditions.

*Offering varies for different regions.



Work Tools

Dig, hammer, rip, and cut with confidence.

An extensive range of Cat work tools for the 318D L Series 2 includes buckets, compactors, grapples, multi-processors, rippers, crushers, pulverizers, hammers and shears. Each is designed to optimize the versatility and performance of your machine.

Couplers

Quick couplers allow one person to change work tools in seconds for maximum performance and flexibility on a job site. One machine can move rapidly from task to task, and a fleet of similarly equipped machines can share a common work tool inventory.

CW Dedicated Coupler

The CW quick coupler can pick up any work tool and is equipped with a wedge-style locking system that fits the quick coupler tight to the tool hinges. Due to the tapered wedge design, there won't be any play during its entire life. Also it is interchangeable with different machine classes. The CW is highly suitable for harsh applications such as demolition and quarries.

Center-Lock™ Pin Grabber Coupler*

Center-Lock is the pin grabber style coupler and features a patent-pending locking system. A highly visible secondary lock clearly shows the operator when the coupler is engaged or disengaged from the bucket or work tool.

*Offering varies for different regions.



Buckets

Cat Buckets and Cat Ground Engaging Tools (GET) are designed and matched to the machine ensuring optimal performance and fuel consumption.

General Duty Buckets (GD)

These buckets are designed for digging in low-impact, moderately abrasive materials such as dirt, loam, gravel and clay.

Heavy Duty Buckets (HD)

HD buckets are a good starting point when application conditions vary. Especially when conditions include mixed dirt, clay and sand and gravel.

Severe Duty Buckets (SD)

These buckets are best suited to highly abrasive applications such as shot rock, sand stone and granite.

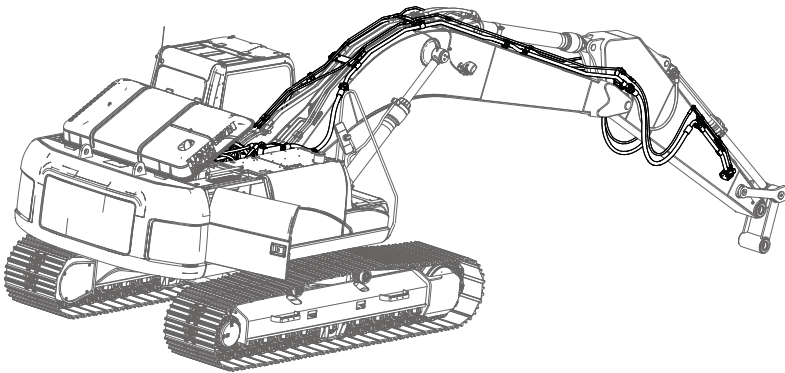

Hydraulic Kits

Caterpillar offers field-installed hydraulic kits that are uniquely designed to integrate Cat Work Tools with Cat excavators. Hoses and tubes are pre-made, pre-shaped, and pre-painted to make installation quick and easy.

Comprehensive Product Support

All Cat work tools are backed up by a world-wide network of well-stocked spare parts depots and highly experienced after-sales service and support personnel.

Work tools available vary by region. Contact your local Cat dealer for more information about the work tools available in your region.



Serviceability

Simplified service and maintenance saves time and money.

Fast, Efficient Service with Extended Intervals

Most service points are at the ground level for easy access with extended intervals to increase machine availability.

Pump Compartment

A service door on the right side of the upper structure allows ground-level access to the pump, pilot filter, drain filter, and the engine oil filter.

Radiator Compartment

The left service door allows easy access to the engine radiator, oil cooler, air-to-air-aftercooler, water separator and first and second fuel filter. A reserve tank and drain cock are attached to the radiator for simplified maintenance.

The air filter features a double-element construction for superior cleaning efficiency. When the air cleaner plugs, a warning is displayed on the monitor screen inside the cab.

Hydraulic Filter

The hydraulic return filter is an in-tank design with a service life of 2,000 hours. A sensor indicates through the in-cab monitor when the filter is plugged and needs to be replaced.

Fan Guard

The engine radiator fan is enclosed by fine wire mesh, reducing the risk of an accident.

Anti-Skid Plate

Anti-skid plate covers top of storage box and upper structure to prevent slipping during maintenance.

Diagnostics and Monitoring

The 318D L Series 2 is equipped with S-O-SSM sampling ports and hydraulic test ports for the hydraulic system, engine oil, and for coolant. A test connection for the Cat Electronic Technician (Cat ET) service tool is located behind the cab.

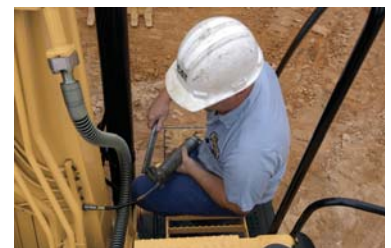
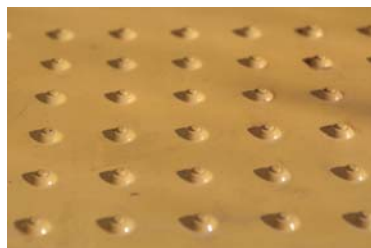



Complete Customer Support
Cat dealer services help you operate longer
with lower costs.

Product Support

You will find nearly all parts at our dealer parts counter. Cat dealers utilize a worldwide computer network to find in-stock parts to minimize machine downtime. Save money with remanufactured components.

Machine Selection

Make detailed comparisons of the machines you are considering before you buy. What are the job requirements, machine attachments and operating hours? What production is needed? Your Cat dealer can provide recommendations.

Maintenance Services

Repair option programs guarantee the cost of repairs up front. Condition monitoring services and diagnostic programs such as scheduled oil sampling, coolant sampling, and technical analysis help you avoid unscheduled repairs.

Customer Support Agreements

Cat dealers offer a variety of product support agreements and work with customers to develop a plan that best meets specific needs. These plans can cover the entire machine, including attachments, to help protect the customer's investment.

Replacement

Repair, rebuild, or replace? Your Cat dealer can help you evaluate the cost involved so you can make the right choice.

318D L Series 2 Hydraulic Excavator Specifications

Engine

Engine Model	C4.4 ACERT	
Engine Power – ISO 14396	93 kW	125 hp
Net Power – SAE J1349/ISO 9249	84 kW	113 hp
Bore	105 mm	4.13 in
Stroke	127 mm	5.00 in
Displacement	4.4 L	269 in ³

- Net power advertised is the power available at the flywheel when the engine is equipped with fan, air cleaner, muffler and alternator.
- No engine derating required below 2300 m (7,545 ft) altitude.
- The 318D L Series 2 with a powerful C4.4 ACERT engine meets the Tier 3, Stage IIIA, Japan 2006 (Tier 3) equivalent or China Stage III Nonroad emission standards.

Weights

Operating Weight –	17 000 kg*	37,490 lb*
Long Undercarriage	18 000 kg**	39,683 lb**

*Reach boom – 5.1 m (16'9"), R2.6 m (8'6") stick, 500 mm (20") triple grousers track shoes, GD 0.76 m³ (1.00 yd³) bucket

**HD boom – 5.1 m (16'9"), HD 2.6 m (8'6") HD stick, 790 mm (31") triple grouser track shoes, SD 0.73 m³ (0.96 yd³) bucket

Swing Mechanism

Swing Speed	8.9 rpm	
Maximum Swing Torque	60 kN·m	44,254 lbf·ft

Drive

Maximum Travel Speed	4.8 km/h	3.0 mph
Maximum Drawbar Pull	156 kN	35,070 lbf
Maximum Slope	35°/70%	

Hydraulic System

Main System – Maximum Flow (Total)	272 L/min	72 gal
Swing System – Maximum Flow	136 L/min	36 gal
Maximum Pressure – Equipment	35 000 kPa	5,080 psi
Maximum Pressure – Swing	22 600 kPa	3,280 psi
Pilot System – Maximum Flow	23.7 L/min	1,450 in ³ /min
Pilot System – Maximum Pressure	4120 kPa	600 psi
Boom Cylinder – Bore	110 mm	4 in
Boom Cylinder – Stroke	1193 mm	47 in
Stick Cylinder – Bore	120 mm	5 in
Stick Cylinder – Stroke	1331 mm	52 in
Bucket Cylinder – Bore	110 mm	4 in
Bucket Cylinder – Stroke	1039 mm	41 in

Service Refill Capacities

Fuel Tank Capacity	300 L	79.3 gal
Cooling System	19.53 L	5.2 gal
Engine Oil (with filter)	16 L	4.3 gal
Swing Drive	3 L	0.8 gal
Final Drive (each)	6 L	1.6 gal
Hydraulic System (including tank)	100 L	26.4 gal
Hydraulic Tank	85 L	22.5 gal

Track

Number of Shoes (each side)	44 pieces
Number of Track Rollers (each side)	7 pieces
Number of Carrier Rollers (each side)	2 pieces

318D L Series 2 Hydraulic Excavator Specifications

Dimensions

All dimensions are approximate.

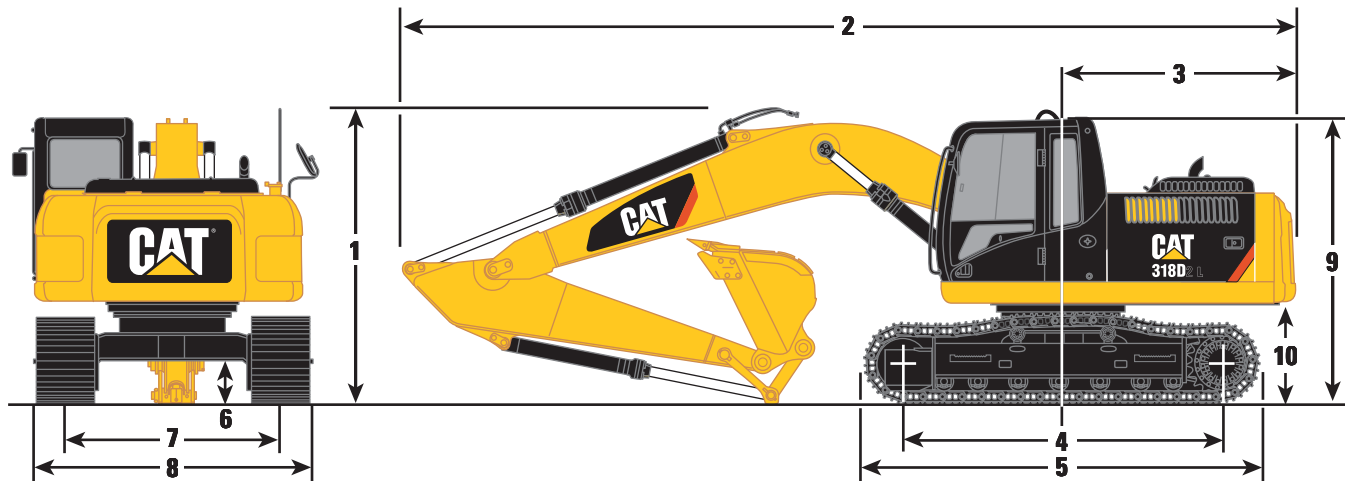

Boom Options

Reach Boom 5.1 m (16'9")

Stick Options

R2.9 m (9'6")

R2.6 m (8'6")

HD 2.6 m (8'6")

Stick Options	R2.9 m (9'6")	R2.6 m (8'6")	HD 2.6 m (8'6")
1 Shipping Height*	3070 mm (10'1")	3030 mm (9'11")	3030 mm (9'11")
Shipping Height with Guard Rail	2940 mm (9'8")	2940 mm (9'8")	2940 mm (9'8")
2 Shipping Length	8560 mm (28'1")	8540 mm (28'0")	8540 mm (28'0")
3 Tail Swing Radius	2500 mm (8'2")	2500 mm (8'2")	2500 mm (8'2")
4 Length to Center of Rollers	3170 mm (10'5")	3170 mm (10'5")	3170 mm (10'5")
5 Track Length	3970 mm (13'0")	3970 mm (13'0")	3970 mm (13'0")
6 Ground Clearance	460 mm (1'6")	460 mm (1'6")	460 mm (1'6")
7 Track Gauge	1990 mm (6'6")	1990 mm (6'6")	1990 mm (6'6")
8 Transport Width			
500 mm (20") Shoes	2490 mm (8'2")	2490 mm (8'2")	2490 mm (8'2")
600 mm (24") Shoes	2590 mm (8'6")	2590 mm (8'6")	2590 mm (8'6")
700 mm (28") Shoes	2690 mm (8'10")	2690 mm (8'10")	2690 mm (8'10")
790 mm (31") Shoes	2870 mm (9'5")	2870 mm (9'5")	2870 mm (9'5")
9 Cab Height	2870 mm (9'5")	2870 mm (9'5")	2870 mm (9'5")
Cab Height with Top Guard	3020 mm (9'11")	3020 mm (9'11")	3020 mm (9'11")
10 Counterweight Clearance**	1000 mm (3'3")	1000 mm (3'3")	1000 mm (3'3")

*Including shoe lug height.

**Without shoe lug height.

318D L Series 2 Hydraulic Excavator Specifications

Working Ranges

All dimensions are approximate.

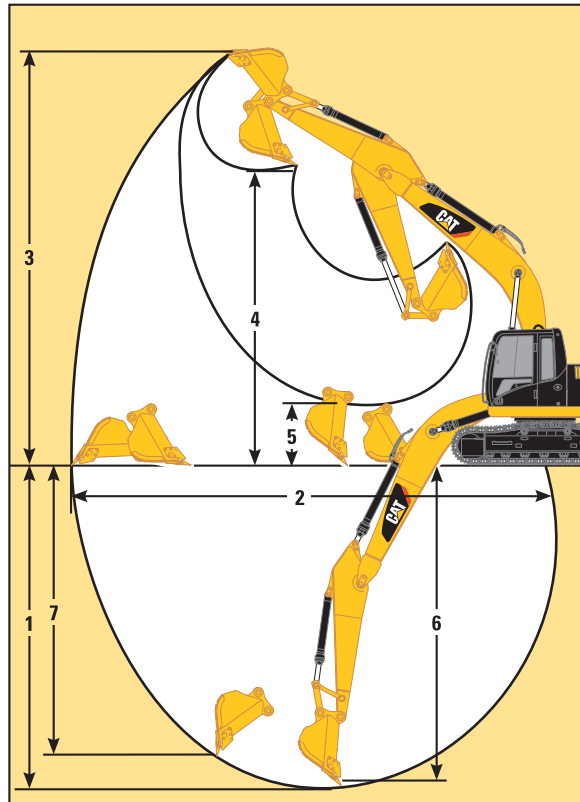

Boom Options		Reach Boom 5.1 m (16'9")		
Stick Options	R2.9 m (9'6")	R2.6 m (8'6")	HD 2.6 m (8'6")	
1 Maximum Digging Depth	6390 mm (21'0")	6090 mm (20'0")	6080 mm (19'11")	
2 Maximum Reach at Ground Level	8990 mm (29'6")	8780 mm (28'10")	8760 mm (28'9")	
3 Maximum Cutting Height	8880 mm (29'2")	8920 mm (29'3")	8900 mm (29'2")	
4 Maximum Loading Height	6270 mm (20'7")	6280 mm (20'7")	6290 mm (20'8")	
5 Minimum Loading Height	2000 mm (6'7")	2300 mm (7'7")	2320 mm (7'7")	
6 Maximum Depth Cut for 2440 mm (8'0") Level Bottom	6160 mm (20'3")	5870 mm (19'3")	5850 mm (19'2")	
7 Maximum Vertical Wall Digging Depth	4910 mm (16'1")	4930 mm (16'3")	5140 mm (16'10")	
Bucket	GD 0.76 m ³ (1.00 yd ³)	GD 0.76 m ³ (1.00 yd ³)	SD 0.73 m ³ (0.96 yd ³)	
Tip Radius	1380 mm (4'6")	1380 mm (4'6")	1360 mm (4'6")	

318D L Series 2 Hydraulic Excavator Specifications

Operating Weight and Ground Pressure

	790 mm (31") Triple Grouser Shoes		700 mm (28") Triple Grouser Shoes		600 mm (24") Triple Grouser Shoes		500 mm (20") Triple Grouser Shoes	
	kg (lb)	kPa (psi)	kg (lb)	kPa (psi)	kg (lb)	kPa (psi)	kg (lb)	kPa (psi)
Reach Boom – 5.1 m (16'9")								
R2.9 m (9'6") ¹	18 000 (39,683)	32.3 (4.68)	17 700 (39,020)	36.0 (5.22)	17 300 (38,150)	41.0 (5.95)	17 100 (37,710)	48.6 (7.05)
R2.6 m (8'6") ¹	17 900 (39,463)	32.2 (4.67)	17 600 (38,810)	35.8 (5.19)	17 200 (37,930)	40.8 (5.92)	17 000 (37,490)	48.3 (7.01)
HD 2.6 m (8'6") ²	18 000 (39,683)	32.3 (4.68)	17 700 (39,020)	36.0 (5.22)	17 800 (39,250)	42.2 (6.12)	17 100 (37,710)	48.6 (7.05)

¹Weights are rounded up to nearest 100 kg (220 lb) including GD 0.76 m³ (1.00 yd³) bucket (610 kg/1,340 lb).

²Weights are rounded up to nearest 100 kg (220 lb) including SD 0.73 m³ (0.96 yd³) bucket (810 kg/1,790 lb).

Major Component Weights

Base Machine (with boom cylinder, without counterweight, front linkage and track)	5330 kg (11,750 lb)
Long Undercarriage	3670 kg (8,090 lb)
Counterweight – 3.2 mt (3.5 t)	3170 kg (6,990 lb)
Boom (includes lines, pins and stick cylinder)	
Reach Boom – 5.1 m (16'9")	1270 kg (2,800 lb)
Stick (includes lines, pins and bucket cylinder)	
R2.9 m (9'6")	850 kg (1,870 lb)
R2.6 m (8'6")	780 kg (1,720 lb)
HD 2.6 m (8'6")	880 kg (1,940 lb)
Track Shoe (Long/per two tracks)	
500 mm (20") Triple Grouser	2200 kg (4,850 lb)
600 mm (24") Triple Grouser	2420 kg (5,340 lb)
700 mm (28") Triple Grouser	2680 kg (5,910 lb)
790 mm (31") Triple Grouser	3040 kg (6,702 lb)

All weights are rounded up to nearest 10 kg and lb except for buckets. Kg and lb were rounded up separately so some of the kg and lb do not match.

Base machine includes 75 kg (170 lb) operator weight, 90% fuel weight, and undercarriage with center guard.

318D L Series 2 Hydraulic Excavator Specifications

Bucket and Stick Forces

Stick Options	Reach Boom 5.1 m (16'9")		
	R2.9 m (9'6")	R2.6 m (8'6")	HD 2.6 m (8'6")
General Duty			
Bucket Digging Force (ISO)	111 kN (25,000 lbf)	111 kN (25,000 lbf)	—
Stick Digging Force (ISO)	75 kN (16,800 lbf)	80 kN (17,900 lbf)	—
Bucket Digging Force (SAE)	98 kN (22,100 lbf)	98 kN (22,000 lbf)	—
Stick Digging Force (SAE)	73 kN (16,300 lbf)	77 kN (17,300 lbf)	—
Severe Duty			
Bucket Digging Force (ISO)	111 kN (25,000 lbf)	111 kN (25,000 lbf)	114 kN (25,600 lbf)
Stick Digging Force (ISO)	75 kN (16,800 lbf)	80 kN (17,900 lbf)	80 kN (18,100 lbf)
Bucket Digging Force (SAE)	97 kN (21,800 lbf)	97 kN (21,800 lbf)	99 kN (22,300 lbf)
Stick Digging Force (SAE)	73 kN (16,400 lbf)	77 kN (17,300 lbf)	78 kN (17,400 lbf)

318D L Series 2 Bucket Specifications and Compatibility – South America

Without Quick Coupler

	Width		Capacity		Weight		Fill	Reach Boom	
	mm	in	m ³	yd ³	kg	lb		2.9 m (9'6")	2.6 m (8'6")
General Duty (GD)	1200	48	0.91	1.19	672	1,480	100	X	⊙
Severe Duty (SD)	1200	48	0.91	1.19	762	1,678	90	X	⊙
Maximum load pin-on (payload + bucket)							kg	2170	2280
							lb	4,783	5,025

With Pin Grabber Quick Coupler

	Width		Capacity		Weight		Fill	Reach Boom	
	mm	in	m ³	yd ³	kg	lb		2.9 m (9'6")	2.6 m (8'6")
General Duty (GD)	1200	48	0.91	1.19	672	1,480	100	○	○
Severe Duty (SD)	1200	48	0.91	1.19	762	1,678	90	○	○
Maximum load pin-on (payload + bucket)							kg	1780	1890
							lb	3,923	4,166

The above loads are in compliance with hydraulic excavator standard EN474, they do not exceed 87% of hydraulic lifting capacity or 75% of tipping capacity with front linkage fully extended at ground line with bucket curled.

Capacity based on ISO 7451.

Bucket weight with General Duty tips.

Maximum Material Density:

- ⊙ 1800 kg/m³ (3,000 lb/yd³)
- 1200 kg/m³ (2,000 lb/yd³)
- X Not Recommended

318D L Series 2 Hydraulic Excavator Specifications

318D L Series 2 Bucket Specifications and Compatibility – Africa, Middle East and CIS

Without Quick Coupler

	Width		Capacity		Weight		Fill	Reach Boom	
	mm	in	m ³	yd ³	kg	lb		2.9 m (9'6")	2.6 m (8'6")
General Duty (GD)	1100	43	0.80	1.04	601	1,325	100	⊙	●
	1300	51	1.00	1.31	682	1,504	100	X	⊖
	1400	55	1.09	1.43	712	1,570	100	X	X
Severe Duty (SD)	1200	48	0.91	1.19	722	1,591	90	X	⊙
Maximum load pin-on (payload + bucket)							kg	2170	2280
							lb	4,783	5,025

With Pin Grabber Quick Coupler

	Width		Capacity		Weight		Fill	Reach Boom	
	mm	in	m ³	yd ³	kg	lb		2.9 m (9'6")	2.6 m (8'6")
General Duty (GD)	1100	43	0.80	1.04	601	1,325	100	⊖	⊖
	1300	51	1.00	1.31	682	1,504	100	◇	○
	1400	55	1.09	1.43	712	1,570	100	X	◇
Severe Duty (SD)	1200	48	0.91	1.19	722	1,591	90	○	⊖
Maximum load pin-on (payload + bucket)							kg	1780	1890
							lb	3,923	4,166

Maximum Material Density:

- 2100 kg/m³ (3,500 lb/yd³)
- ⊙ 1800 kg/m³ (3,000 lb/yd³)
- ⊖ 1500 kg/m³ (2,500 lb/yd³)
- 1200 kg/m³ (2,000 lb/yd³)
- ◇ 900 kg/m³ (1,500 lb/yd³)
- X Not Recommended

The above loads are in compliance with hydraulic excavator standard EN474, they do not exceed 87% of hydraulic lifting capacity or 75% of tipping capacity with front linkage fully extended at ground line with bucket curled.

Capacity based on ISO 7451.

Bucket weight with General Duty tips.

318D L Series 2 Hydraulic Excavator Specifications

318D L Series 2 Bucket Specifications and Compatibility – Asia Pacific

Without Quick Coupler										
	Width		Capacity		Weight		Fill	Reach Boom		
	mm	in	m ³	yd ³	kg	lb		2.9 m (9'6")	HD 2.6 m (8'6")	2.6 m (8'6")
General Duty (GD)	1100	43	0.80	1.04	624	1,376	100	⊙	⊙	●
	1200	48	0.91	1.19	651	1,435	100	X		⊙
Severe Duty (SD)	1050	42	0.76	1.00	692	1,526	90		●	
Maximum load pin-on (payload + bucket)							kg	2210	2170	2305
							lb	4,871	4,783	5,080
With Pin Grabber Quick Coupler										
	Width		Capacity		Weight		Fill	Reach Boom		
	mm	in	m ³	yd ³	kg	lb		2.9 m (9'6")	HD 2.6 m (8'6")	2.6 m (8'6")
General Duty (GD)	1100	43	0.80	1.04	624	1,376	100	⊖		⊖
	1200	48	0.91	1.19	651	1,435	100	○		○
Maximum load pin-on (payload + bucket)							kg	1820	1780	1915
							lb	4,011	3,923	4,221

The above loads are in compliance with hydraulic excavator standard EN474, they do not exceed 87% of hydraulic lifting capacity or 75% of tipping capacity with front linkage fully extended at ground line with bucket curled.

Capacity based on ISO 7451.

Bucket weight with General Duty tips.

Maximum Material Density:

- 2100 kg/m³ (3,500 lb/yd³)
- ⊙ 1800 kg/m³ (3,000 lb/yd³)
- ⊖ 1500 kg/m³ (2,500 lb/yd³)
- 1200 kg/m³ (2,000 lb/yd³)
- X Not Recommended

318D L Series 2 Hydraulic Excavator Specifications

Reach Boom Lift Capacities – Counterweight: 3.2 mt (3.5 t) – without Bucket

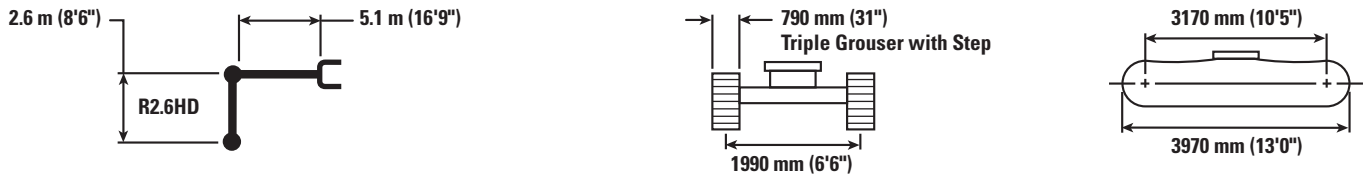

		1500 mm/60 in		3000 mm/120 in		4500 mm/180 in		6000 mm/240 in		7500 mm/300 in		mm in		
7500 mm 300 in	kg lb					*7,400	*7,400					*3250 *7,200	*3250 *7,200	4760 190
6000 mm 240 in	kg lb							*3500 *6,400	3500 *6,400			*2850 *6,250	*2850 *6,250	6180 240
4500 mm 180 in	kg lb					*4600 *9,950	*4600 *9,950	*4250 *9,300	3450 7,350			*2750 *6,000	2650 5,850	7010 280
3000 mm 120 in	kg lb			*8800 *18,750	*8800 *18,750	*5850 *12,600	5000 10,800	*4800 *10,400	3300 7,050			*2800 *6,100	2350 5,200	7450 300
1500 mm 60 in	kg lb					*7150 *15,450	4700 10,050	5050 10,850	3150 6,750	*3400	2250	*3000 *6,550	2250 4,900	7560 300
0 mm 0 in	kg lb			*6250 *14,350	*6250 *14,350	7600 16,300	4450 9,600	4900 10,550	3000 6,500			*3350 *7,400	2300 5,000	7370 290
-1500 mm -60 in	kg lb	*5700 *12,750	*5700 *12,750	*10 100 *23,050	8050 17,300	7500 16,100	4400 9,450	4850 10,450	2950 6,400			4050 8,950	2500 5,500	6840 270
-3000 mm -120 in	kg lb	*9950 *22,300	*9950 *22,300	*10 650 *23,050	8200 17,600	*7400 *15,900	4450 9,550					5050 11,250	3100 6,900	5890 230
-4500 mm -180 in	kg lb			*7650 *16,200	*7650 *16,200							*5350 *11,750	5100 11,650	4230 170



ISO 10567



*Indicates that the load is limited by hydraulic lifting capacity rather than tipping load. The above loads are in compliance with hydraulic excavator lift capacity standard ISO 10567:2007. They do not exceed 87% of hydraulic lifting capacity or 75% of tipping load. Weight of all lifting accessories must be deducted from the above lifting capacities. Lifting capacities are based on the machine standing on a firm, uniform supporting surface. The use of a work tool attachment point to handle/lift objects, could affect the machine lift performance.

Lift capacity stays with ±5% for all available track shoes.

Always refer to the appropriate Operation and Maintenance Manual for specific product information.

318D L Series 2 Hydraulic Excavator Specifications

Reach Boom Lift Capacities – Counterweight: 3.2 mt (3.5 t) – without Bucket

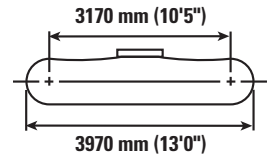
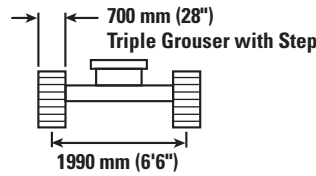
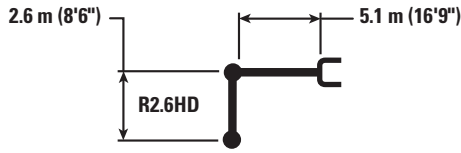

		1500 mm/60 in		3000 mm/120 in		4500 mm/180 in		6000 mm/240 in		7500 mm/300 in		mm in		
7500 mm 300 in	kg lb					*7,400	*7,400					*3250 *7,200	*3250 *7,200	4760 190
6000 mm 240 in	kg lb							*3500 *6,400	3400 *6,400			*2850 *6,250	*2850 *6,250	6180 240
4500 mm 180 in	kg lb					*4600 *9,950	*4600 *9,950	*4250 *9,300	3400 7,250			*2750 *6,000	2600 5,750	7010 280
3000 mm 120 in	kg lb			*8800 *18,750	*8800 *18,750	*5850 *12,600	4950 10,650	*4800 *10,400	3250 6,950			*2800 *6,100	2300 5,100	7450 300
1500 mm 60 in	kg lb					*7150 *15,450	4600 9,900	4950 10,650	3100 6,600	*3400	2250	*3000 *6,550	2200 4,850	7560 300
0 mm 0 in	kg lb			*6250 *14,350	*6250 *14,350	7450 16,000	4400 9,450	4850 10,400	2950 6,350			*3350 *7,400	2250 4,900	7370 290
-1500 mm -60 in	kg lb	*5700 *12,750	*5700 *12,750	*10 100 *23,050	7950 17,000	7350 15,800	4300 9,250	4800 10,250	2900 6,250			4000 8,800	2450 5,400	6840 270
-3000 mm -120 in	kg lb	*9950 *22,300	*9950 *22,300	*10 650 *23,050	8050 17,300	*7400 *15,900	4350 9,400					4950 11,050	3050 6,750	5890 230
-4500 mm -180 in	kg lb			*7650 *16,200	*7650 *16,200							*5350 *11,750	5000 11,450	4230 170



ISO 10567



*Indicates that the load is limited by hydraulic lifting capacity rather than tipping load. The above loads are in compliance with hydraulic excavator lift capacity standard ISO 10567:2007. They do not exceed 87% of hydraulic lifting capacity or 75% of tipping load. Weight of all lifting accessories must be deducted from the above lifting capacities. Lifting capacities are based on the machine standing on a firm, uniform supporting surface. The use of a work tool attachment point to handle/lift objects, could affect the machine lift performance.









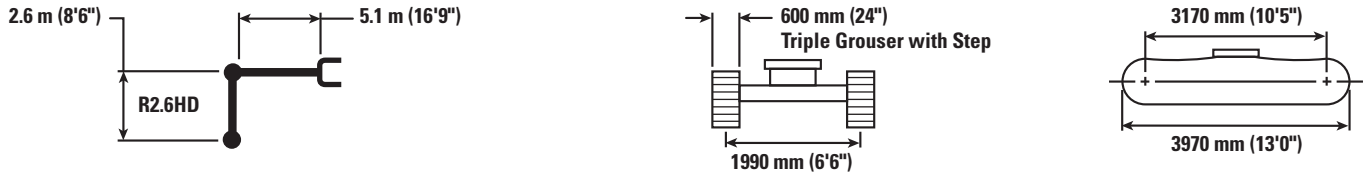



Lift capacity stays with ±5% for all available track shoes.

Always refer to the appropriate Operation and Maintenance Manual for specific product information.

318D L Series 2 Hydraulic Excavator Specifications

Reach Boom Lift Capacities – Counterweight: 3.2 mt (3.5 t) – without Bucket



		1500 mm/60 in		3000 mm/120 in		4500 mm/180 in		6000 mm/240 in		7500 mm/300 in				mm in
														
7500 mm 300 in	kg lb					*7,400	*7,400					*3250 *7,200	*3250 *7,200	4760 190
6000 mm 240 in	kg lb							*3500 *6,400	3400 *6,400			*2850 *6,250	*2850 *6,250	6180 240
4500 mm 180 in	kg lb					*4600 *9,950	*4600 *9,950	*4250 *9,300	3350 7,150			*2750 *6,000	2600 5,700	7010 280
3000 mm 120 in	kg lb			*8800 *18,750	*8800 *18,750	*5850 *12,600	4900 10,500	*4800 *10,400	3200 6,850			*2800 *6,100	2300 5,000	7450 300
1500 mm 60 in	kg lb					*7150 *15,450	4550 9,750	4900 10,500	3050 6,550	*3400	2200	*3000 *6,550	2150 4,750	7560 300
0 mm 0 in	kg lb			*6250 *14,350	*6250 *14,350	7350 15,800	4350 9,300	4750 10,250	2900 6,300			*3350 *7,400	2200 4,850	7370 290
-1500 mm -60 in	kg lb	*5700 *12,750	*5700 *12,750	*10 100 *23,050	7850 16,800	7250 15,600	4250 9,150	4700 10,150	2900 6,200			3950 8,650	2450 5,350	6840 270
-3000 mm -120 in	kg lb	*9950 *22,300	*9950 *22,300	*10 650 *23,050	7950 17,100	7350 15,750	4300 9,250					4900 10,900	3000 6,650	5890 230
-4500 mm -180 in	kg lb			*7650 *16,200	*7650 *16,200							*5350 *11,750	4950 11,300	4230 170



ISO 10567



*Indicates that the load is limited by hydraulic lifting capacity rather than tipping load. The above loads are in compliance with hydraulic excavator lift capacity standard ISO 10567:2007. They do not exceed 87% of hydraulic lifting capacity or 75% of tipping load. Weight of all lifting accessories must be deducted from the above lifting capacities. Lifting capacities are based on the machine standing on a firm, uniform supporting surface. The use of a work tool attachment point to handle/lift objects, could affect the machine lift performance.

Lift capacity stays with ±5% for all available track shoes.

Always refer to the appropriate Operation and Maintenance Manual for specific product information.

318D L Series 2 Hydraulic Excavator Specifications

Reach Boom Lift Capacities – Counterweight: 3.2 mt (3.5 t) – without Bucket

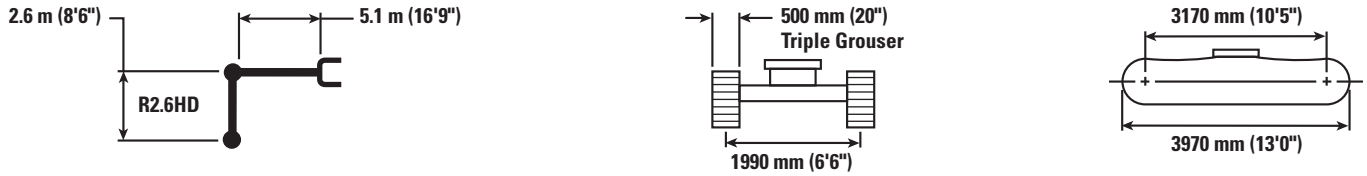

		1500 mm/60 in		3000 mm/120 in		4500 mm/180 in		6000 mm/240 in		7500 mm/300 in		mm in		
7500 mm 300 in	kg lb					*7,400	*7,400					*3250 *7,200	*3250 *7,200	4760 190
6000 mm 240 in	kg lb							*3500 *6,400	3350 *6,400			*2850 *6,250	*2850 *6,250	6180 240
4500 mm 180 in	kg lb					*4600 *9,950	*4600 *9,950	*4250 *9,300	3300 7,050			*2750 *6,000	2550 5,650	7010 280
3000 mm 120 in	kg lb			*8800 *18,750	*8800 *18,750	*5850 *12,600	4850 10,400	*4800 *10,400	3150 6,800			*2800 *6,100	2250 4,950	7450 300
1500 mm 60 in	kg lb					*7150 *15,450	4500 9,650	4850 10,400	3000 6,450	*3400	2150	*3000 *6,550	2150 4,700	7560 300
0 mm 0 in	kg lb			*6250 *14,350	*6250 *14,350	7250 15,600	4250 9,200	4700 10,100	2900 6,200			*3350 *7,400	2200 4,750	7370 290
-1500 mm -60 in	kg lb	*5700 *12,750	*5700 *12,750	*10 100 *23,050	7750 16,550	7150 15,400	4200 9,000	4650 10,000	2850 6,100			3850 8,550	2400 5,250	6840 270
-3000 mm -120 in	kg lb	*9950 *22,300	*9950 *22,300	*10 650 *23,050	7850 16,850	7250 15,500	4250 9,150					4850 10,750	2950 6,550	5890 230
-4500 mm -180 in	kg lb			*7650 *16,200	*7650 *16,200							*5350 *11,750	4850 11,150	4230 170



ISO 10567



*Indicates that the load is limited by hydraulic lifting capacity rather than tipping load. The above loads are in compliance with hydraulic excavator lift capacity standard ISO 10567:2007. They do not exceed 87% of hydraulic lifting capacity or 75% of tipping load. Weight of all lifting accessories must be deducted from the above lifting capacities. Lifting capacities are based on the machine standing on a firm, uniform supporting surface. The use of a work tool attachment point to handle/lift objects, could affect the machine lift performance.

Lift capacity stays with $\pm 5\%$ for all available track shoes.

Always refer to the appropriate Operation and Maintenance Manual for specific product information.

318D L Series 2 Hydraulic Excavator Specifications

Reach Boom Lift Capacities – Counterweight: 3.2 mt (3.5 t) – without Bucket

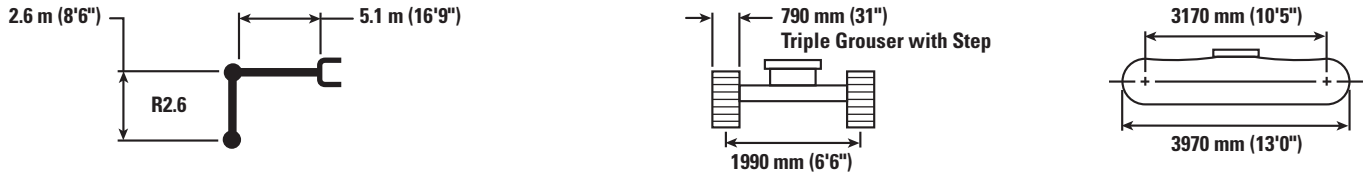

		1500 mm/60 in		3000 mm/120 in		4500 mm/180 in		6000 mm/240 in		7500 mm/300 in				mm in
7500 mm 300 in	kg lb					*7,450	*7,450					*3250	*3250	4760
6000 mm 240 in	kg lb							*3500	*3500			*2850	*2850	6180
4500 mm 180 in	kg lb					*4650	*4650	*4300	3500			*2750	2700	7010
3000 mm 120 in	kg lb			*8900	*8900	*5900	5100	*4850	3350			*2800	2400	7450
1500 mm 60 in	kg lb			*18,950	*18,950	*12,750	10,950	*10,550	7,200			*6,200	5,300	300
0 mm 0 in	kg lb					*7250	4750	5100	3200	*3400	2350	*3000	2300	7560
						*15,600	10,250	11,000	6,850			*6,600	5,050	300
0 mm 0 in	kg lb			*6250	*6250	7700	4550	5000	3100			*3400	2350	7370
				*14,400	*14,400	16,500	9,800	10,700	6,650			*7,450	5,150	290
-1500 mm -60 in	kg lb	*5700	*5700	*10 150	8200	7600	4450	4950	3050			4100	2550	6840
		*12,800	*12,800	*23,100	17,600	16,300	9,600	10,600	6,550			9,050	5,650	270
-3000 mm -120 in	kg lb	*9950	*9950	*10 800	8300	*7450	4500					5100	3150	5890
		*22,350	*22,350	*23,300	17,850	*16,100	9,700					11,400	7,000	230
-4500 mm -180 in	kg lb			*7800	*7800							*5450	5150	4230
				*16,400	*16,400							*11,950	11,800	170



ISO 10567



*Indicates that the load is limited by hydraulic lifting capacity rather than tipping load. The above loads are in compliance with hydraulic excavator lift capacity standard ISO 10567:2007. They do not exceed 87% of hydraulic lifting capacity or 75% of tipping load. Weight of all lifting accessories must be deducted from the above lifting capacities. Lifting capacities are based on the machine standing on a firm, uniform supporting surface. The use of a work tool attachment point to handle/lift objects, could affect the machine lift performance.

Lift capacity stays with ±5% for all available track shoes.

Always refer to the appropriate Operation and Maintenance Manual for specific product information.

318D L Series 2 Hydraulic Excavator Specifications

Reach Boom Lift Capacities – Counterweight: 3.2 mt (3.5 t) – without Bucket

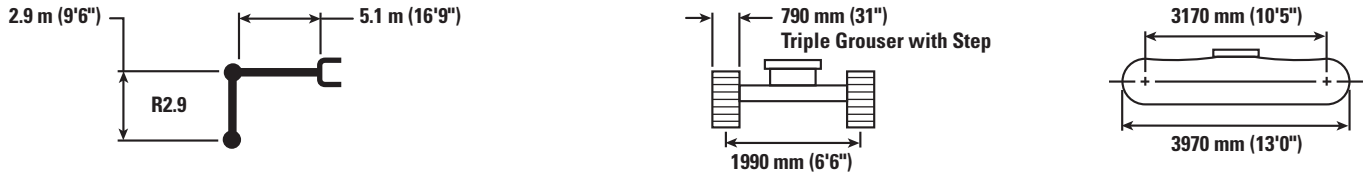

		1500 mm/60 in		3000 mm/120 in		4500 mm/180 in		6000 mm/240 in		7500 mm/300 in		mm in		
7500 mm 300 in	kg lb											*2900 *6,500	*2900 *6,500	5090 200
6000 mm 240 in	kg lb							*3600 *7,350	3550 *7,350			*2650 *5,800	*2650 *5,800	6440 250
4500 mm 180 in	kg lb							*4050 *8,900	3500 7,500			*2550 *5,650	*2550 *5,650	7240 290
3000 mm 120 in	kg lb			*8050 *17,100	*8050 *17,100	*5550 *11,950	5100 11,000	*4600 *10,050	3350 7,200	*3300 *6,050	2400 5,100	*2650 *5,800	2300 5,050	7660 310
1500 mm 60 in	kg lb			*7100 *16,950	*7100 *16,950	*6950 *15,000	4750 10,250	5100 10,950	3200 6,850	3650 *7,850	2300 4,950	*2850 *6,250	2200 4,800	7770 310
0 mm 0 in	kg lb			*7050 *16,150	*7050 *16,150	7650 16,400	4500 9,700	4950 10,650	3050 6,550	3600 7,950	2250 4,850	*3200 *7,050	2200 4,850	7580 300
-1500 mm -60 in	kg lb	*5700 *12,750	*5700 *12,750	*10 050 *22,900	8100 17,350	7550 16,150	4400 9,500	4900 10,500	3000 6,450			3900 8,550	2400 5,300	7070 280
-3000 mm -120 in	kg lb	*9300 *20,850	*9300 *20,850	*11 150 *24,100	8200 17,550	7550 16,250	4450 9,550	4900 10,600	3000 6,500			4750 10,550	2950 6,500	6160 240
-4500 mm -180 in	kg lb			*8550 *18,250	8450 18,200	*5750 12,650	4600 10,150					*5550 *12,250	4500 10,200	4600 180



ISO 10567



*Indicates that the load is limited by hydraulic lifting capacity rather than tipping load. The above loads are in compliance with hydraulic excavator lift capacity standard ISO 10567:2007. They do not exceed 87% of hydraulic lifting capacity or 75% of tipping load. Weight of all lifting accessories must be deducted from the above lifting capacities. Lifting capacities are based on the machine standing on a firm, uniform supporting surface. The use of a work tool attachment point to handle/lift objects, could affect the machine lift performance.

Lift capacity stays with ±5% for all available track shoes.

Always refer to the appropriate Operation and Maintenance Manual for specific product information.

318D L Series 2 Hydraulic Excavator Specifications

Reach Boom Lift Capacities – Counterweight: 3.2 mt (3.5 t) – without Bucket

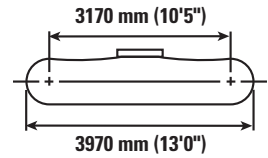
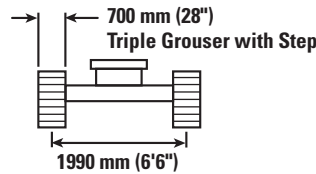
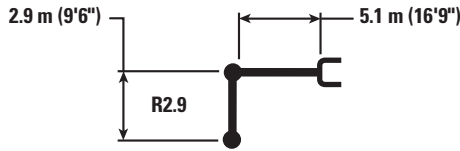

		1500 mm/60 in		3000 mm/120 in		4500 mm/180 in		6000 mm/240 in		7500 mm/300 in				mm in
7500 mm 300 in	kg lb											*2900 *6,500	*2900 *6,500	5090 200
6000 mm 240 in	kg lb							*3600 *7,350	3500 *7,350			*2650 *5,800	*2650 *5,800	6440 250
4500 mm 180 in	kg lb							*4050 *8,900	3450 7,400			*2550 *5,650	2550 5,600	7240 290
3000 mm 120 in	kg lb			*8050 *17,100	*8050 *17,100	*5550 *11,950	5050 10,850	*4600 *10,050	3300 7,100	*3300 *6,050	2350 5,000	*2650 *5,800	2250 4,950	7660 310
1500 mm 60 in	kg lb			*7100 *16,950	*7100 *16,950	*6950 *15,000	4700 10,100	5000 10,800	3150 6,750	3600 7,750	2250 4,850	*2850 *6,250	2150 4,700	7770 310
0 mm 0 in	kg lb			*7050 *16,150	*7050 *16,150	7500 16,150	4450 9,550	4850 10,450	3000 6,450	3550	2200	*3200 *7,050	2200 4,800	7580 300
-1500 mm -60 in	kg lb	*5700 *12,750	*5700 *12,750	*10 050 *22,900	7950 17,050	7400 15,900	4350 9,350	4800 10,300	2950 6,300			3800 8,400	2350 5,200	7070 280
-3000 mm -120 in	kg lb	*9300 *20,850	*9300 *20,850	*11 150 *24,100	8050 17,250	7450 15,950	4350 9,400	4850 10,400	2950 6,400			4650 10,350	2850 6,350	6160 240
-4500 mm -180 in	kg lb			*8550 *18,250	8300 17,900	*5750	4550					*5550 *12,250	4400 10,050	4600 180



ISO 10567



*Indicates that the load is limited by hydraulic lifting capacity rather than tipping load. The above loads are in compliance with hydraulic excavator lift capacity standard ISO 10567:2007. They do not exceed 87% of hydraulic lifting capacity or 75% of tipping load. Weight of all lifting accessories must be deducted from the above lifting capacities. Lifting capacities are based on the machine standing on a firm, uniform supporting surface. The use of a work tool attachment point to handle/lift objects, could affect the machine lift performance.

Lift capacity stays with ±5% for all available track shoes.

Always refer to the appropriate Operation and Maintenance Manual for specific product information.

318D L Series 2 Hydraulic Excavator Specifications

Reach Boom Lift Capacities – Counterweight: 3.2 mt (3.5 t) – without Bucket

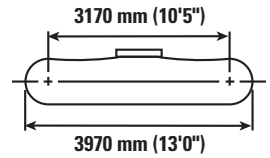
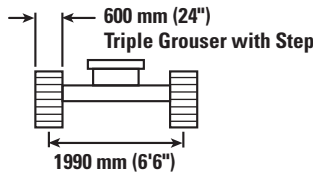
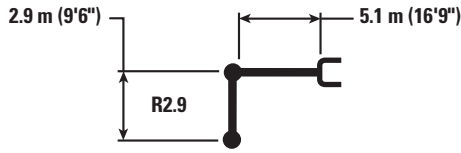

		1500 mm/60 in		3000 mm/120 in		4500 mm/180 in		6000 mm/240 in		7500 mm/300 in		mm in		
7500 mm 300 in	kg lb											*2900 *6,500	*2900 *6,500	5090 200
6000 mm 240 in	kg lb							*3600 *7,350	3450 *7,350			*2650 *5,800	*2650 *5,800	6440 250
4500 mm 180 in	kg lb							*4050 *8,900	3400 7,300			*2550 *5,650	2500 5,550	7240 290
3000 mm 120 in	kg lb			*8050 *17,100	*8050 *17,100	*5550 *11,950	5000 10,750	*4600 *10,050	3250 7,000	*3300 *6,050	2300 4,950	*2650 *5,800	2250 4,900	7660 310
1500 mm 60 in	kg lb			*7100 *16,950	*7100 *16,950	*6950 *15,000	4600 9,950	4950 10,650	3100 6,650	3550 7,600	2250 4,800	*2850 *6,250	2100 4,650	7770 310
0 mm 0 in	kg lb			*7050 *16,150	*7050 *16,150	7400 15,900	4400 9,400	4800 10,350	2950 6,350	3500 7,700	2200 4,850	*3200 *7,050	2150 4,700	7580 300
-1500 mm -60 in	kg lb	*5700 *12,750	*5700 *12,750	*10 050 *22,900	7850 16,800	7300 15,650	4300 9,200	4750 10,200	2900 6,250			3750 8,300	2350 5,150	7070 280
-3000 mm -120 in	kg lb	*9300 *20,850	*9300 *20,850	*11 150 *24,100	7950 17,050	7350 15,750	4300 9,250	4750 10,250	2950 6,300			4600 10,200	2850 6,300	6160 240
-4500 mm -180 in	kg lb			*8550 *18,250	8200 17,650	*5750 12,650	4500					*5550 *12,250	4350 9,900	4600 180



ISO 10567



*Indicates that the load is limited by hydraulic lifting capacity rather than tipping load. The above loads are in compliance with hydraulic excavator lift capacity standard ISO 10567:2007. They do not exceed 87% of hydraulic lifting capacity or 75% of tipping load. Weight of all lifting accessories must be deducted from the above lifting capacities. Lifting capacities are based on the machine standing on a firm, uniform supporting surface. The use of a work tool attachment point to handle/lift objects, could affect the machine lift performance.

Lift capacity stays with ±5% for all available track shoes.

Always refer to the appropriate Operation and Maintenance Manual for specific product information.

318D L Series 2 Hydraulic Excavator Specifications

Reach Boom Lift Capacities – Counterweight: 3.2 mt (3.5 t) – without Bucket

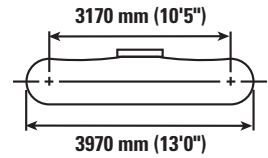
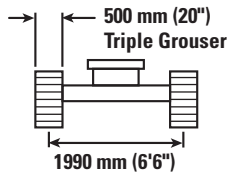
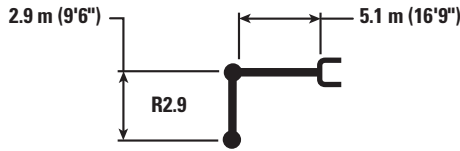

		1500 mm/60 in		3000 mm/120 in		4500 mm/180 in		6000 mm/240 in		7500 mm/300 in		mm in		
7500 mm 300 in	kg lb											*2900 *6,500	*2900 *6,500	5090 200
6000 mm 240 in	kg lb							*3600 *7,350	3400 7,300			*2650 *5,800	*2650 *5,800	6440 250
4500 mm 180 in	kg lb							*4050 *8,900	3350 7,200			*2550 *5,650	2450 5,450	7240 290
3000 mm 120 in	kg lb			*8050 *17,100	*8050 *17,100	*5550 *11,950	4950 10,600	*4600 *10,050	3200 6,900	*3300 *6,050	2300 4,850	*2650 *5,800	2200 4,850	7660 310
1500 mm 60 in	kg lb			*7100 *16,950	*7100 *16,950	*6950 *15,000	4550 9,850	4900 10,500	3050 6,550	3500 7,500	2200 4,700	*2850 *6,250	2100 4,600	7770 310
0 mm 0 in	kg lb			*7050 *16,150	*7050 *16,150	7300 15,700	4300 9,300	4750 10,200	2900 6,300	3450	2150	*3200 *7,050	2100 4,650	7580 300
-1500 mm -60 in	kg lb	*5700 *12,750	*5700 *12,750	*10 050 *22,900	7750 16,600	7200 15,450	4200 9,100	4650 10,050	2850 6,150			3700 8,200	2300 5,050	7070 280
-3000 mm -120 in	kg lb	*9300 *20,850	*9300 *20,850	*11 150 *24,100	7850 16,850	7250 15,500	4250 9,150	4700 10,150	2900 6,200			4550 10,050	2800 6,200	6160 240
-4500 mm -180 in	kg lb			*8550 *18,250	8100 17,450	*5750	4400					*5550 *12,250	4300 9,750	4600 180



ISO 10567



*Indicates that the load is limited by hydraulic lifting capacity rather than tipping load. The above loads are in compliance with hydraulic excavator lift capacity standard ISO 10567:2007. They do not exceed 87% of hydraulic lifting capacity or 75% of tipping load. Weight of all lifting accessories must be deducted from the above lifting capacities. Lifting capacities are based on the machine standing on a firm, uniform supporting surface. The use of a work tool attachment point to handle/lift objects, could affect the machine lift performance.

Lift capacity stays with ±5% for all available track shoes.

Always refer to the appropriate Operation and Maintenance Manual for specific product information.

318D L Series 2 Hydraulic Excavator Specifications

Reach Boom Lift Capacities – Counterweight: 3.2 mt (3.5 t) – without Bucket

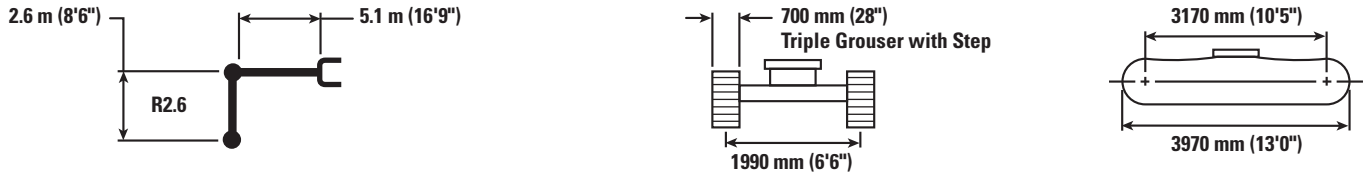

		1500 mm/60 in		3000 mm/120 in		4500 mm/180 in		6000 mm/240 in		7500 mm/300 in				mm in
7500 mm 300 in	kg lb					*7,450	*7,450					*3250 *7,250	*3250 *7,250	4760 190
6000 mm 240 in	kg lb							*3500 *6,450	3500 *6,450			*2850 *6,300	*2850 *6,300	6180 240
4500 mm 180 in	kg lb					*4650 *10,050	*4650 *10,050	*4300 *9,450	3450 7,400			*2750 *6,050	2650 5,900	7010 280
3000 mm 120 in	kg lb			*8900 *18,950	*8900 *18,950	*5900 *12,750	5050 10,850	*4850 *10,550	3300 7,100			*2800 *6,200	2400 5,250	7450 300
1500 mm 60 in	kg lb					*7250 *15,600	4700 10,100	5050 10,850	3150 6,800	*3400	2300	*3000 *6,600	2250 5,000	7560 300
0 mm 0 in	kg lb			*6250 *14,400	*6250 *14,400	7600 16,250	4500 9,650	4900 10,550	3050 6,550			*3400 *7,450	2300 5,050	7370 290
-1500 mm -60 in	kg lb	*5700 *12,800	*5700 *12,800	*10 150 *23,100	8100 17,400	7500 16,050	4400 9,500	4850 10,450	3000 6,450			4050 8,950	2550 5,550	6840 270
-3000 mm -120 in	kg lb	*9950 *22,350	*9950 *22,350	*10 800 *23,300	8200 17,650	*7450 *16,100	4450 9,600					5050 11,250	3100 6,900	5890 230
-4500 mm -180 in	kg lb			*7800 *16,400	*7800 *16,400							*5450 *11,950	5100 11,650	4230 170



ISO 10567



*Indicates that the load is limited by hydraulic lifting capacity rather than tipping load. The above loads are in compliance with hydraulic excavator lift capacity standard ISO 10567:2007. They do not exceed 87% of hydraulic lifting capacity or 75% of tipping load. Weight of all lifting accessories must be deducted from the above lifting capacities. Lifting capacities are based on the machine standing on a firm, uniform supporting surface. The use of a work tool attachment point to handle/lift objects, could affect the machine lift performance.

Lift capacity stays with ±5% for all available track shoes.

Always refer to the appropriate Operation and Maintenance Manual for specific product information.

318D L Series 2 Hydraulic Excavator Specifications

Reach Boom Lift Capacities – Counterweight: 3.2 mt (3.5 t) – without Bucket

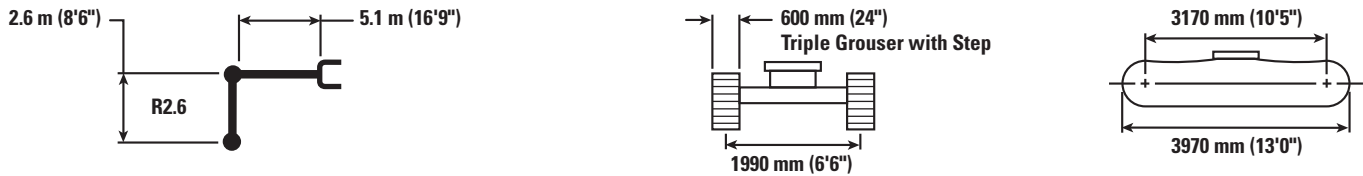

		1500 mm/60 in		3000 mm/120 in		4500 mm/180 in		6000 mm/240 in		7500 mm/300 in		mm in		
7500 mm 300 in	kg lb					*7,450	*7,450					*3250 *7,250	*3250 *7,250	4760 190
6000 mm 240 in	kg lb							*3500 *6,450	3450 *6,450			*2850 *6,300	*2850 *6,300	6180 240
4500 mm 180 in	kg lb					*4650 *10,050	*4650 *10,050	*4300 *9,450	3400 7,300			*2750 *6,050	2650 5,850	7010 280
3000 mm 120 in	kg lb			*8900 *18,950	*8900 *18,950	*5900 *12,750	4950 10,700	*4850 *10,550	3250 7,000			*2800 *6,200	2350 5,150	7450 300
1500 mm 60 in	kg lb					*7250 *15,600	4650 10,000	5000 10,700	3100 6,700	*3400	2250	*3000 *6,600	2250 4,900	7560 300
0 mm 0 in	kg lb			*6250 *14,400	*6250 *14,400	7500 16,050	4450 9,550	4850 10,450	3000 6,450			*3400 *7,450	2300 5,000	7370 290
-1500 mm -60 in	kg lb	*5700 *12,800	*5700 *12,800	*10 150 *23,100	8000 17,150	7400 15,850	4350 9,350	4800 10,300	2950 6,350			4000 8,800	2500 5,500	6840 270
-3000 mm -120 in	kg lb	*9950 *22,350	*9950 *22,350	*10 800 *23,300	8100 17,400	7450 15,950	4400 9,450					5000 11,100	3100 6,850	5890 230
-4500 mm -180 in	kg lb			*7800 *16,400	*7800 *16,400							*5450 *11,950	5050 11,500	4230 170



ISO 10567



*Indicates that the load is limited by hydraulic lifting capacity rather than tipping load. The above loads are in compliance with hydraulic excavator lift capacity standard ISO 10567:2007. They do not exceed 87% of hydraulic lifting capacity or 75% of tipping load. Weight of all lifting accessories must be deducted from the above lifting capacities. Lifting capacities are based on the machine standing on a firm, uniform supporting surface. The use of a work tool attachment point to handle/lift objects, could affect the machine lift performance.

Lift capacity stays with ±5% for all available track shoes.

Always refer to the appropriate Operation and Maintenance Manual for specific product information.

318D L Series 2 Hydraulic Excavator Specifications

Reach Boom Lift Capacities – Counterweight: 3.2 mt (3.5 t) – without Bucket

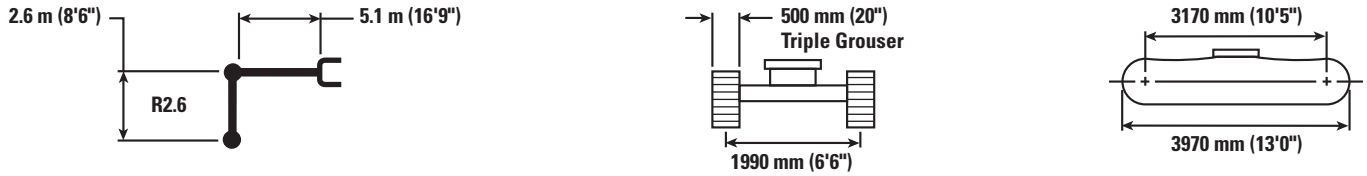

		1500 mm/60 in		3000 mm/120 in		4500 mm/180 in		6000 mm/240 in		7500 mm/300 in		mm in		
7500 mm 300 in	kg lb					*7,450	*7,450					*3250 *7,250	*3250 *7,250	4760 190
6000 mm 240 in	kg lb							*3500 *6,450	3400 *6,450			*2850 *6,300	*2850 *6,300	6180 240
4500 mm 180 in	kg lb					*4650 *10,050	*4650 *10,050	*4300 *9,450	3350 7,200			*2750 *6,050	2600 5,750	7010 280
3000 mm 120 in	kg lb			*8900 *18,950	*8900 *18,950	*5900 *12,750	4900 10,600	*4850 *10,550	3250 6,950			*2800 *6,200	2300 5,100	7450 300
1500 mm 60 in	kg lb					*7250 *15,600	4600 9,850	4900 10,550	3100 6,600	*3400	2250	*3000 *6,600	2200 4,850	7560 300
0 mm 0 in	kg lb			*6250 *14,400	*6250 *14,400	7400 15,850	4400 9,400	4800 10,300	2950 6,350			*3400 *7,450	2250 4,900	7370 290
-1500 mm -60 in	kg lb	*5700 *12,800	*5700 *12,800	*10 150 *23,100	7900 16,950	7300 15,650	4300 9,250	4750 10,200	2900 6,250			3950 8,700	2450 5,400	6840 270
-3000 mm -120 in	kg lb	*9950 *22,350	*9950 *22,350	*10 800 *23,300	8000 17,200	7350 15,750	4350 9,350					4900 10,950	3050 6,750	5890 230
-4500 mm -180 in	kg lb			*7800 *16,400	*7800 *16,400							*5450 *11,950	4950 11,350	4230 170



ISO 10567



*Indicates that the load is limited by hydraulic lifting capacity rather than tipping load. The above loads are in compliance with hydraulic excavator lift capacity standard ISO 10567:2007. They do not exceed 87% of hydraulic lifting capacity or 75% of tipping load. Weight of all lifting accessories must be deducted from the above lifting capacities. Lifting capacities are based on the machine standing on a firm, uniform supporting surface. The use of a work tool attachment point to handle/lift objects, could affect the machine lift performance.

Lift capacity stays with ±5% for all available track shoes.

Always refer to the appropriate Operation and Maintenance Manual for specific product information.

Standard Equipment

Standard equipment may vary. Consult your Cat dealer for details.

ENGINE

- Diesel engine – electronically controlled C4.4 ACERT engine
 - 2300 m (7,545 ft) altitude capability
 - 50 amp alternator, air intake heater
 - Tier 3, Stage IIIA, Japan 2006 (Tier 3) equivalent or China Stage III Nonroad emission package
- 10 micron fuel filter
- 4 micron fuel pre-filter
- One touch low idle with AEC
- Remote engine oil filter
- Radial seal air filter, double element
- Two speed travel
- Water separator in fuel line with indicator
- Waved fin radiator with side by side type oil cooler
- Fix type A/C condenser
- 53° C (127.4° F) High ambient cooling

CAB

- Bolt-on FOGS capability
- Openable front windshield with assist device
- Pillar mounted upper windshield wiper and washer
- Front windshield glass split by 70/30
- Cab sliding upper door window
- Rear window, emergency exit
- Removable lower windshield with in cab storage bracket
- Openable skylight/metal hatch
- Interior lighting
- Standard joystick
- Laminated front upper windshield
- Seat high back, mechanical suspension with head rest

- Seat belt, retractable, 50 mm (2")
- Floor mat
- Bi-level air conditioner (auto) with defroster
- Windshield washer
- Coat hook
- Ashtray and lighter
- Beverage holder
- Literature holder
- Utility space for magazine
- Radio mounting
- Mounting for two stereo speakers
- Antenna flexible type
- Storage compartment suitable for lunch box
- Monitor
 - Language display
 - Full graphic and full color display
 - Warning information
 - Filter/fluid change information
 - Machine condition
 - Error code and tool mode setting information
 - Full time clock on monitor
- Positive filtered ventilation
- Seat integrated control joystick
- Adjustable armrest
- Adjustable console
- Neutral lever (lock out) for all controls
- Travel control pedals with removable hand levers
- Capability of installing two additional pedals

ELECTRICAL

- Circuit breaker
- Cat battery

HYDRAULIC

- Hydraulic main pump
- High performance hydraulic return filter
- Regeneration control for boom and stick
- Boom lowering device for back up
- Boom drift reducing valve
- Stick drift reducing valve
- Reverse swing damping valve
- Automatic swing parking brake
- Auxiliary hydraulic valve
- Capability of stackable valves for main valve
- Capability of auxiliary circuit

SECURITY

- Cat one key security system
- Signaling/warning horn
- Mirrors, rearview (frame – right, cab – left)
- Secondary engine shutoff switch
- Door locks
- Cap locks on fuel and hydraulic tanks
- Lockable external tool/storage box

LIGHTS

- Halogen boom light (left side)
- Exterior lights integrated into storage box

COUNTERWEIGHT

- Counterweight without lifting eye (3170 kg/6,990 lb)

UNDERCARRIAGE

- Grease lubricated track (GLT2)
- Idler and center section track guiding guard
- Towing eye on base frame
- Standard idler tension spring
- Guard, standard bottom

318D L Series 2 Optional Equipment

Optional Equipment

Optional equipment may vary. Consult your Cat dealer for details.

ENGINE

- Cold weather batteries, -25° C (77° F)
- Air precleaner

HYDRAULIC

- Combined circuit
- Combined circuit with medium pressure
- Center-Lock quick coupler lines and control
- Joystick with modulation SW
- Boom and Stick high pressure, medium pressure and quick couple line options

CAB

- Seat with seat heater, high back, air suspension with head rest
- Pull-down sunscreen
- 12V-10A power supply with two cigar lighter type sockets

UNDERCARRIAGE

- 500 mm (20") triple grouser shoes
- 600 mm (24") triple grouser shoes
- 700 mm (28") triple grouser shoes
- 790 mm (31") triple grouser shoes

FRONT LINKAGE

- Boom, 5.1 m (16'9")
- Stick, 2.6 m (8'6")
- Stick, 2.9 m (9'6")
- Heavy duty stick, 2.6 m (8'6")
- Bucket linkage
- Quick coupler

LIGHTS

- Cab lights
- Halogen boom light (right side)

SECURITY

- Travel alarm*
- Rearview camera and right side mirrors
- Cab mirror

TECHNOLOGY

- Product Link™, Satellite or Cellular*

GUARDS

- FOGS (bolt on)
- Guard, heavy duty bottom
- Swivel guard

*Offering varies for different regions.

For more complete information on Cat products, dealer services, and industry solutions, visit us on the web at www.cat.com

© 2016 Caterpillar
All rights reserved

Materials and specifications are subject to change without notice. Featured machines in photos may include additional equipment. See your Cat dealer for available options.

CAT, CATERPILLAR, SAFETY.CAT.COM, their respective logos, "Caterpillar Yellow" and the "Power Edge" trade dress, as well as corporate and product identity used herein, are trademarks of Caterpillar and may not be used without permission.

AEHQ7904
(AME, CIS, Indonesia,
LACD, Southeast Asia)

