

# CAT<sup>®</sup> RM500B

RECLAIMER / STABILIZER



# RM500B

## TECHNOLOGY SIMPLIFIES OPERATION, INCREASES PRODUCTION AND ASSURES QUALITY.

Enhancements and versatility make this durable industry workhorse an exceptional value. High production and excellent production quality go hand-in-hand with low operating and maintenance costs. Rotor and spray system options provide the ability to adapt to a wide range of applications.

- SUPERIOR MIX QUALITY
- SIMPLE TO OPERATE
- OPERATOR IS COMFORTABLE AND IN CONTROL
- EASY TO SERVICE
- ENHANCED PROPEL SYSTEM
- HIGHLY VERSATILE



1. Cat® C15 Engine
2. Reversible Variable Speed Fan
3. Sliding Cab
4. Electronically Controlled Full Time All-wheel Drive
5. Roll Over Protection Structure (ROPS)
6. Remote Grease Fittings
7. Pivoting, Heated Operator's Seat with Integrated LCD Touchscreen Display, Control Console and Handwheel Steering
8. Front Remote Camera
9. Rear Remote Camera
10. Mixing Chamber Remote Camera
11. Rooding Lights (option)
12. Automatic Load Control
13. Water Pump System (option)
14. Emulsion Pump System (option)
15. Direct Rotor Drive
16. Three Rotor Options: Universal, Combination, Soil
17. Variable Volume Mixing Chamber
18. Torque Limiter (option)
19. Flashing Amber Warning Beacon (option)
20. Product Link™
21. Mirror Package
22. Lockable Storage Compartment
23. Bolt-on Counterweight (option)
24. Maintenance-free Cat Batteries





A well-appointed cab provides the operator with a quiet, uncluttered work environment. Everything is within reach and everything is within view, allowing the operator to focus on work, maximizing productivity.



# COMFORT AND CONTROL

THE OPERATOR COMES FIRST.



1. LCD Touchscreen Display
2. Backlit Control Keypad
3. Propel Lever with Thumb Control Buttons
4. Pivoting Adjustable Heated Seat
5. Handwheel Steering Control
6. Remote Camera Monitor
7. 12-volt Power Receptacle
8. Seatbelt
9. Emergency Stop
10. Horn
11. Enable/Disable Regeneration
12. Cupholder
13. Remote Camera System Toggle
14. Climate Controls
15. Speakers for Customer-installed Radio



*Seat rotates 180 degrees for enhanced comfort and visibility*

# FINGERTIP CONTROL

A HIGH PRODUCTION WORKSPACE.

## PROPEL LEVER THUMB CONTROLS

1. Rotor Up
2. Rotor Down
3. Rotor Travel Mode (Full up)
4. Rotor Automatic Depth Set Point (set and return)
5. Mixing Chamber Rear Door Raise
6. Mixing Chamber Rear Door Lower



## OPERATOR'S CONSOLE KEYPAD CONTROLS

7. Cruise Control - Increase Speed
8. Cruise Control - Decrease Speed
9. Travel Mode
10. Throttle Control
11. Steering Mode Select
12. Spray System Control
13. Cab Slide Left
14. Rear Steer Left
15. Front Mixing Chamber Door Raise
16. Front Mixing Chamber Door Close
17. Mixing Chamber Service Mode/Chamber Float
18. Chamber Tilt Back
19. Rotor Speed
20. Rotor Control
21. Cab Slide Right
22. Rear Steer Right





## EXCELLENT VISIBILITY

The RM500B features a sliding cab and rotating seat to provide the operator with an unimpeded view of the cutting path on either side of the machine. Standard front and rear remote cameras supplement the view, and an optional remote camera provides views to the rear door of the mixing chamber so the operator can monitor mix quality.

# HEAVY-DUTY POWERTRAIN

GETS THE JOB DONE EFFICIENTLY AND RELIABLY.



**ABOVE:** In highly regulated countries, the RM500B comes with a C15 engine equipped with an emissions module (CEM) that meets Tier 4 Final/Stage V emission standards.

**BELOW:** In lesser regulated countries, the RM500B is equipped with a C15 engine that meets Tier 3/Stage IIIA emission standards.



## CAT ENGINES DELIVER SMOOTH POWER WITH FEWER EMISSIONS

**In highly regulated countries,** the RM500B is equipped with a Cat C15 engine, a turbocharged, 6-cylinder diesel engine that provides 407 kW (546 hp) of gross power. The engine is designed to meet US EPA Tier 4 Final and EU Stage V emissions standards. Every Tier 4 Final/ Stage V Cat engine is equipped with a combination of proven electronic, fuel, air and aftertreatment components. Applying proven technologies systematically lets us meet our customer's high expectations for productivity, fuel efficiency, reliability and service life.

**In lesser regulated countries,** the RM500B is powered by a Cat C15 engine, a turbocharged, 6-cylinder diesel engine that provides 403 kW (540 hp) of gross power. The engine utilizes an electronic controller to precisely deliver multiple injections of fuel. These multiple injections are combined with a refined air management system in order to generate fewer emissions and optimize fuel combustion while achieving emissions levels equivalent to Tier 3 and Stage IIIA emission standards.

**A robust cooling system** provides cool air intake to maximize fuel efficiency and minimize emissions. An on-demand variable speed fan draws ambient air from a separate compartment in front of the engine through the cooling package. The exhaust air exits from the front of the machine, maintaining a cool engine compartment.

The cooling fan is reversible and automatically performs periodic cycles in reverse to clean the heat exchanger by expelling accumulated dust. This allows the system to cool more efficiently, ensuring that the engine is working optimally. A sensor prevents accidental overheating during a reverse cycle.



## FOUR STEERING MODES

### ALL-WHEEL DRIVE AND FOUR STEERING MODES PROVIDES SURE TRACTION, PRECISE SPEEDS AND HIGH MANEUVERABILITY

Standard electronically controlled all-wheel drive and four steering modes maximize traction and mobility even in poor conditions. The all-wheel drive system continually monitors and balances pressures for maximum traction.

The RM500B is fully hydrostatically driven and features four independent pumps and drive motors. The four pumps provide a dedicated flow to each wheel motor, ensuring sufficient power for traction. Sensors adjust hydraulic flow to balance traction, reducing wheel spin resulting from loss of traction and ensuring that the machine propels in even the most extreme conditions.

Propel is controlled with an electronic joystick on the operator's console. The propel joystick has six thumb buttons that allow the operator to conveniently adjust the rear chamber door opening, manually adjust the rotor depth, and also make a rotor depth set-point for consistent depth when a certain depth is repeatedly required or automatically elevate the rotor for Travel Mode.

The propel system provides four steering modes: Front Steer, Rear Steer, Crab Steer and Coordinated Steer. The ability to change the steering characteristics of the machine provides high maneuverability.

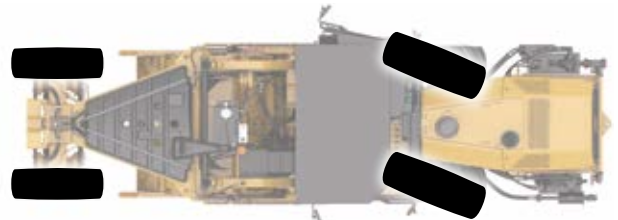

Front Steer Mode



Rear Steer Mode

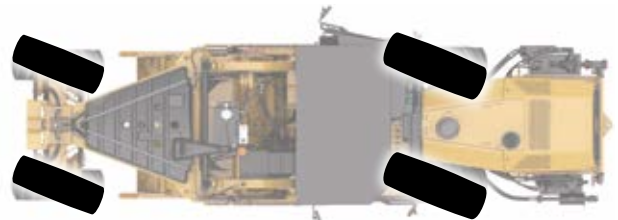

Crab Steer Mode

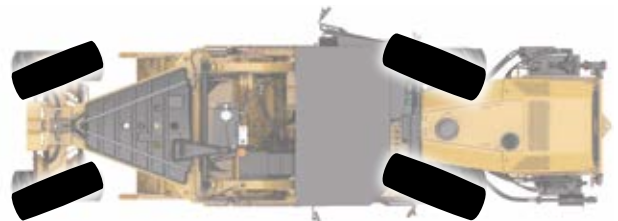

Coordinated Steer Mode



## VERSATILITY ALLOWS **MULTIPLE USES**

Three rotor choices and three rotor speeds powered by a sturdy rotor drive system provide the means to perform a multitude of applications. Combined with four steering modes and electronically controlled full time all-wheel drive, the RM500B is a go-anywhere, do-anything machine.



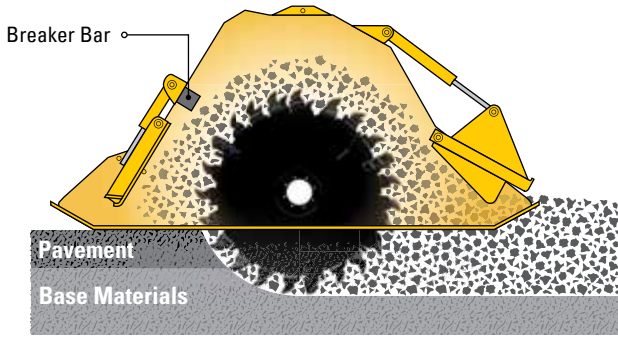

## FULL DEPTH RECLAMATION:

In-place full depth reclamation offers a cost-effective means to recycle the material without the time and expense of removing and replacing it. Existing pavements are pulverized in place along with a portion of the existing base materials to form a new homogenous base. Reclamation also provides the opportunity to introduce water or emulsions, and other virgin aggregates to improve the material design. The result is a new, stronger, more uniform base. Compared with the costs of other rehabilitation methods—overlay or reconstruction—reclamation is the most economical choice over the life of the rehabilitated road.

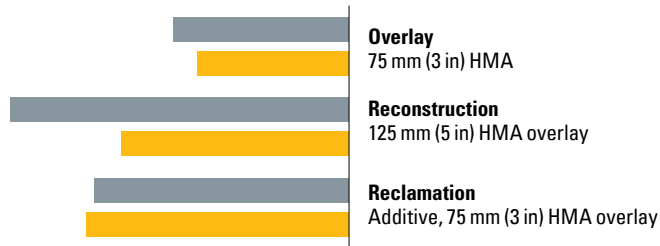

**Relative Unit Cost**  
Per square meter (yard)

**Estimated Service Life**  
Years

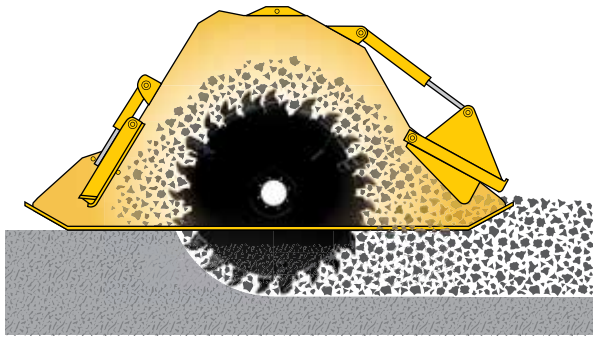

## SOIL STABILIZATION:

Soil stabilization is the process of mechanically or chemically improving the load-bearing characteristics of the soil. Additives such as fly ash, Portland cement and lime are incorporated into cohesive and semi-cohesive native soil to increase compressive strength or reduce plasticity of the subgrade. When performed with the correct additives, stabilization can greatly increase the integrity of the subgrade and provide a material that will have greater support capabilities and moisture resistance.

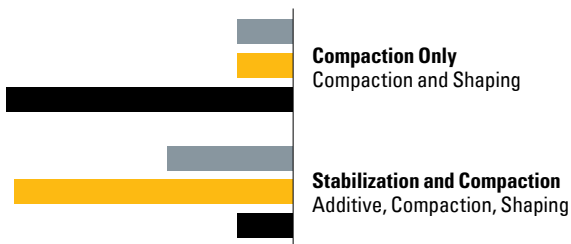

**Relative Unit Cost**  
Per square meter (yard)

**Estimated Service Life**  
Years

**Relative Maintenance Cost**  
Over life of road

## OTHER APPLICATIONS:

- Agriculture
- Bio-remediation
- Haul Roads

# ROTOR OPTIONS

DESIGNED FOR EFFICIENT PRODUCTION.

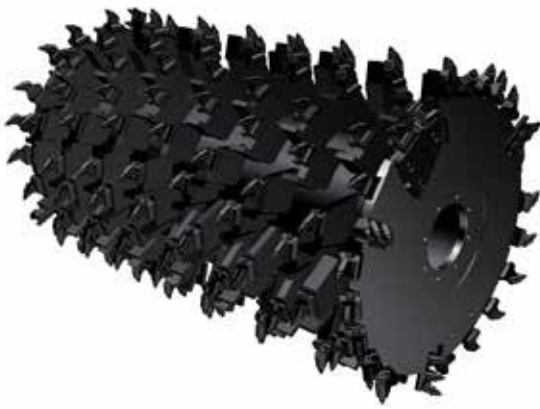

## UNIVERSAL ROTOR

The **Universal 16** rotor is designed to produce maximum breakout force in deep asphalt cuts and on existing soil cement. It also performs well in soil stabilization applications. The kicker paddle design provides material movement and suspension in the mixing chamber and includes a breaker bar for excellent gradation in full-depth reclamation and soil stabilization applications. Triple-tree tool placement on the rotor edges improves side cutting when maneuvering. The Universal 16 rotor may also be used in soil stabilization applications; however, the 200-bit design may result in gradation that is finer than desirable. The large number of bits, along with the kicker paddles, will also cause this rotor to consume the most power for soil applications.

The **Universal 18** rotor is designed to provide maximum mixing depth and has lower breakout force compared to the Universal 16 rotor. This rotor meets European 45 cm mixing depth requirements while providing the highest level of material pulverization and gradation. Secondary application of light asphalt reclamation, where the asphalt layer is thin and deteriorated.



## COMBINATION ROTOR

The Combination rotor is designed for deep-cut soil mixing where pulverization and gradation is of lesser importance and higher working speeds are more important. It performs well in cohesive soils.

The Combination rotor design utilizes a smaller number of bits, which contributes to lower costs associated with bit replacement. Fewer bits mean lower costs for replacement bit purchases, as well as less downtime and labor to replace them. This rotor design results in high production—especially in deep cuts—because less power is required to drive a rotor with fewer bits compared to a rotor with significantly more.

The soil gradation performance of the Combination rotor will result in larger material sizing compared to the Soil rotor due to the smaller number of bits.



**Triple-tree cutting bit placement on rotor ends cleans up loose material and reduces wear on the rotor caused by maneuvering in the cut.**



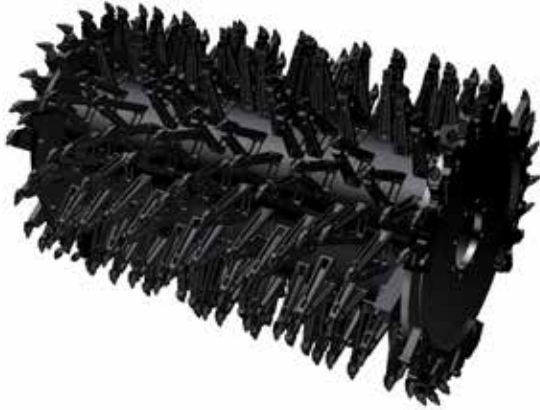

## SOIL ROTOR

The Soil rotor is an ideal choice for mixing additives with semi cohesive or granular materials where soil gradation is critical. It can also handle light reclamation applications where the asphalt layer is thin and deteriorated.

The Soil rotor is standard equipped with cast stand-offs that include bit holders in a single casting. When the cast bit holders become worn or damaged, they can be removed and replaced with weld-on bit holders. Bit life varies depending on soil type.

### Bolt-on Breakaway Cutting Bit Holder

Used on Universal Rotor

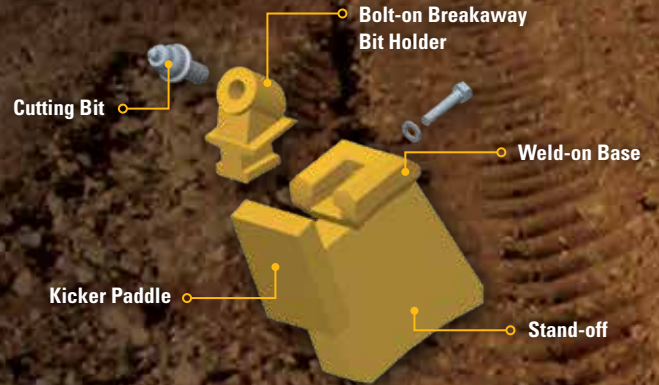

### Bolt-on Breakaway Cutting Bit Holder

Used on Combination Rotor

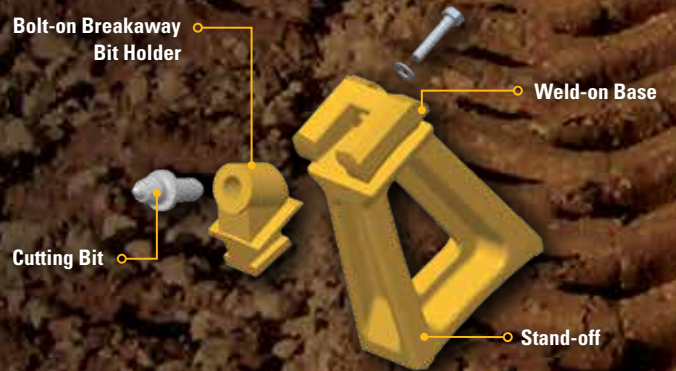

### Weld-on Cutting Bit Holder

Used on Soil Rotor and Spade Rotor

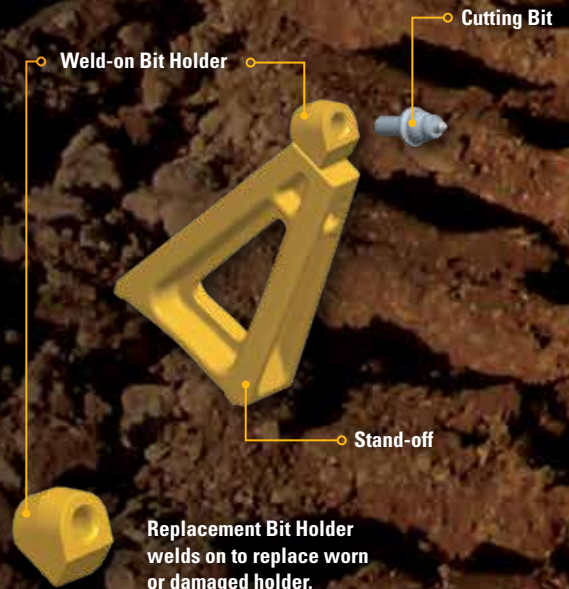



# MAXIMIZE PERFORMANCE

## CHOOSE THE BEST ROTOR FOR THE APPLICATION

Cat rotors are capable of producing good results in many applications, but each is designed to provide maximum efficiency and productivity in specific applications. This chart provides general guidance for choosing a rotor.

JOB TYPE	APPLICATION	UNIVERSAL 16	UNIVERSAL 18	COMBINATION	SOIL
<b>FULL-DEPTH ASPHALT</b>					
<b>RECLAMATION</b>	<b>Thin Asphalt Layer</b> 25-75 mm (1-3 in)	✓	✓	○	○
	<b>Medium Asphalt Layer</b> 75-175 mm (3-7 in)	✓	✓	○	✗
	<b>Thick Asphalt Layer</b> 175-250 mm (7-10 in)	✓	○	✗	✗
	<b>Soil and Cement</b> (fully cured)	✓	✓	○	○
<b>MIXING / STABILIZATION</b>					
<b>SOIL</b>	<b>Granular Soils</b>	✓	✓	○	✓
	<b>Granular with Rocks</b> < 130 mm (5 in), Debris	✓	✓	○	✗
	<b>Light Clay</b>	○	○	✓	○
	<b>Heavy Clay / Gumbo</b>	✓	○	✓	○

### KEY

- ✓ Ideal choice for specific application
- Acceptable, but not ideal
- ✗ Not recommended for this application



	Universal 16	Universal 18	Combination	Soil
<b>Cut Width</b>	2438 mm (96 in)	2438 mm (96 in)	2438 mm (96 in)	2438 mm (96 in)
<b>Rotor Diameter (over bits)</b>	1375 mm (54 in)	1525 mm (60 in)	1625 mm (64 in)	1625 mm (64 in)
<b>Maximum Depth</b>	406 mm (16 in)	457 mm (18 in)	508 mm (20 in)	508 mm (20 in)
<b>Weight</b>	4118 kg (9,079 lbs)	4499 kg (9,919 lbs)	3128 kg (6,894 lbs)	3953 kg (8,715 lbs)
<b>Number of Cutting Bits</b>	200	200	114	238
<b>Bit Impact Spacing</b>	15 mm (0.6 in)	15 mm (0.6 in)	31 mm (1.22 in)	11.5 mm (0.45 in)
<b>Bit Holder Type</b>	Bolt-on Breakaway	Bolt-on Breakaway	Bolt-on Breakaway	Weld-on
<b>Bit Shank Diameter</b>	20 mm*	20 mm*	22 mm*	20 mm
<b>Direction of Cut</b>	Up	Up	Up	Up

\*Toolholders to accommodate 20 mm and 22 mm bit shanks available through your dealer parts department.

# CUTTING BIT COMPATIBILITY

Optimize performance for maximum productivity.

Choosing the right cutting bit for your application can optimize the efficiency of the machine, resulting in more production with ideal material sizing and mixing quality. These charts identify which cutting bits are recommended for common applications.

For more information or cutting tool alternatives, please consult your local Cat dealer or refer to the *Cutter Bit Application Chart (QEXQ2003-04)*.

Rotor Type			Part Number
UNIVERSAL 20 mm Shank	STABILIZATION 20 mm Shank	COMBINATION 22 mm Shank	
		•	533-5760
•			561-8135
•	•		564-1260
•	•		578-4416



533-5760



561-8135



564-1260



578-4416

Application		Depth			Part Number
Soil	Asphalt Reclamation	Shallow 25-50 mm (1-2 in)	Moderate 75-125 mm (3 - 5 in)	Deep +150 mm (+6 in)	
•			•	•	533-5760
	•	•	•		561-8135
	•		•	•	564-1260
•		•	•		578-4416



- |  |  |  |
|--|--|--|
| 1. Reversing Cooling Fan                 | 5. Air Filter                            | 10. Maintenance-free Cat Batteries       |
| 2. Remote Grease Fittings                | 6. Engine Coolant Level Visual Indicator | 11. Hydraulic Oil Level Visual Indicator |
| 3. Fuel/Water Separator Visual Indicator | 7. Main Power Switch                     | 12. LCD Touchscreen                      |
| 4. Engine Oil Dipstick                   | 8. Jump-start Stud                       | 13. Lockable Storage Compartment         |
|  | 9. Fuse Panel                            |  |



**LEFT:**  
Easy access to hydraulic filters and DEF fill port



# SIMPLE TO SERVICE

## MAXIMIZING UPTIME MAXIMIZES PRODUCTION

Cat equipment has built a solid reputation for service ease and low operating costs. The RM500B is no different: features such as ground level access to maintenance items, S.O.S.<sup>SM</sup> oil sampling ports, visual gauges or indicators and remote grease fittings help keep costs low and ensure that maintenance schedules are followed. New technology simplifies even more, as advanced system diagnostics and the LCD touchscreen can alert the operator to conditions that could affect production.

### SIMPLE MAINTENANCE

- Visual indicators for fuel/water, hydraulic oil, coolant and rotor bearing lubrication oil levels
- Ground level access to engine oil dipstick, engine and hydraulic oil filters
- LCD touchscreen provides air restriction indicator and alerts operator to performance issues
- Large doors and removable panels provide unrestricted access to critical components
- Reversing cooling fan ejects dust from cooling package to maintain optimum system performance
- Cat batteries require no maintenance
- Oil sampling and pressure testing ports reduce risk of spillage or contamination
- Grouped drain ports for simplified drainage and reduced spillage
- Product Link will help you track and maintain your fleet
- Lockable storage compartment keeps tools readily accessible



***Grouped Drain Valves***



***Grouped Remote Grease Fittings***



***Visual Indicators***

# ENHANCING CAPABILITY

# OPTIONAL EQUIPMENT

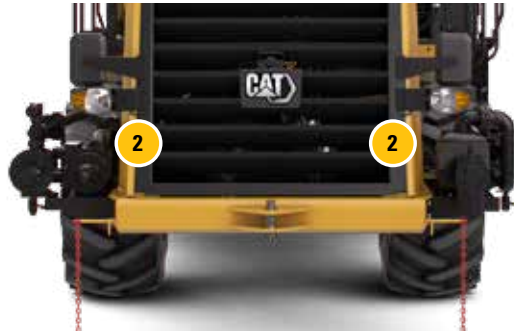

## 1 WATER SPRAY SYSTEM

Water Spray System automates the addition of metered water to the mixing chamber, allowing the machine to easily mix the proper measured amount to the materials. It provides an infinitely variable volume capacity of 114 to 1136 liters (30 to 300 gallons) per minute with three sets of nozzles for low, medium and high flow ranges.

For water use only—not for use with emulsions.

## 1 ULTRA LOW-FLOW WATER SPRAY SYSTEM

Water Spray System automates the addition of metered water to the mixing chamber, allowing the machine to easily mix the proper measured amount to the materials. It provides an infinitely variable volume capacity of 60 to 600 liters (16 to 160 gallons) per minute with two sets of nozzles for low and high flow ranges.

For water use only—not for use with emulsions.

## 2 WATER SPRAY AND EMULSION SPRAY SYSTEM

Both Water Spray System and Emulsion Spray Systems installed to allow simultaneous or individual system operation.

## 3 EMULSION SPRAY SYSTEM

Emulsion Spray System automates the addition of metered emulsion to the mixing chamber, allowing the machine to easily mix the proper measured amount to the materials. This pump unit provides an infinitely variable volume capacity of 114 to 946 liters (30 to 250 gallons) per minute. Three sets of nozzles for the spray bar, ensure proper fan pattern.



#### 4 TORQUE LIMITER

The torque limiter minimizes the amount of torque that can be transferred to the engine. This allows the mechanism to limit potential damage when the rotor strikes an immovable object like a manhole cover.



#### 5 WARNING BEACON

Flashing amber warning beacon required on many job sites. Mounted on retractable pole.



#### 6 BOLT-ON COUNTERWEIGHT

Bolt-on 1600 kg (3,500 lb) counterweight kit enhances machine performance in tough reclamation applications. Recommended for asphalt cuts 25 cm (10 in) deep or greater.



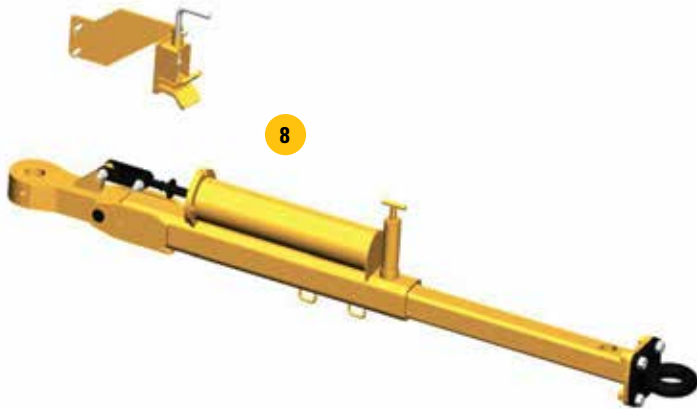

## 7 ROADING LIGHTS

Roading Lights package enables on-highway transportation. Package includes 2 front-facing headlights, side amber turn signal/hazard lamps (2 front, 2 rear), and a slow moving vehicle sign.

## 8 PUSH BAR

Deploys telescopically to provide a firm connection to water or emulsion truck. Folds to storage position against front bumper.

## 9 COMMISSIONING SUPPORT

Certified Caterpillar trainers cover proper machine setup, basic maintenance, operation and application. Training lasts approximately 3 days and is conducted at the customer's location or jobsite.



# ARMOR AGAINST ABRASION AND FRICTION

# WEAR PARTS

## BREAKER BAR

Steel assembly mounts inside rotor chamber. For use with Universal 16 and Universal 18 rotors. Provides more control over material sizing by acting as a crushing agent against which larger chunks of material can be broken down.

Part Number: 193-1039 (Order Quantity: 3)



## WEAR DISC

Disc installs inside rotor chamber on each side of rotor drum to provide protection and guide the depth adjustment of the rotor chain drive while keeping material inside chamber.

Part Number: 231-4209 (Order Quantity: 2)

## CHAMBER GROUP (WEAR SKIS)

Steel skis mount to bottom of rotor chamber. Provides protection from ground friction on main chamber housing.

Part Numbers:

Center Plate 140-1188 (Order Quantity: 2)

Front and Back Plate 140-1187 (Order Quantity: 4)



## REAR DOOR STRIKE OFF

Strike off installs on rear chamber door. Provides protection for rear door from friction caused by dragging in material. Reversible design extends use.

Part Number: 077-7730 (Order Quantity: 1)

# RM500B ROTARY MIXER SPECIFICATIONS

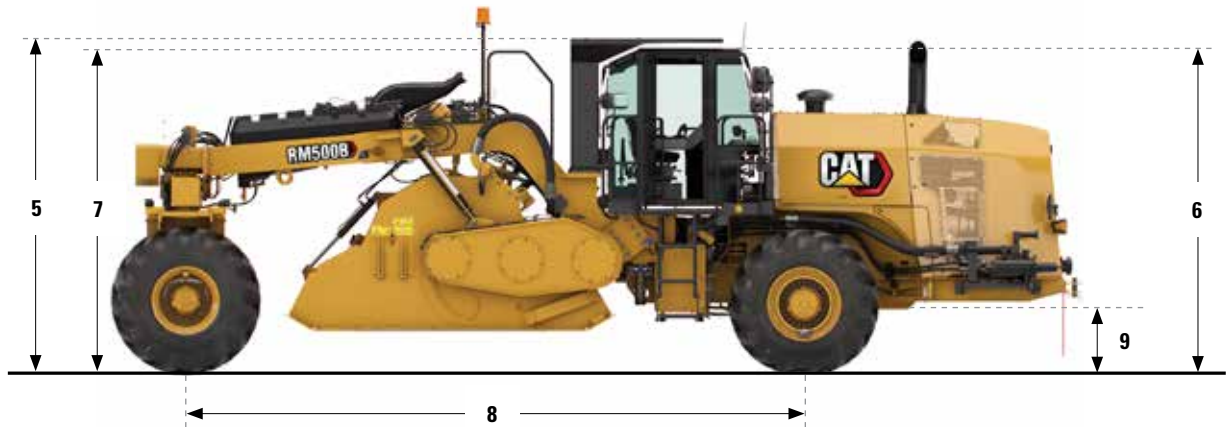
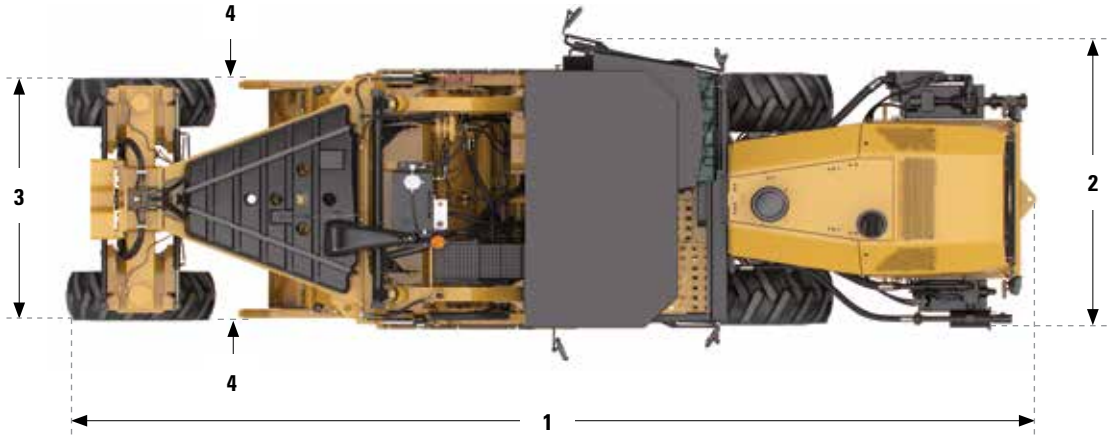

DIMENSIONS			
1 Overall Length	10.32 m 33.83 ft	6 Height at Cab	3.50 m 11.48 ft
2 Overall Width	2.98 m 9.58 ft	7 Height at Handrail	3.47 m 11.38 ft
3 Width at Rear Wheels	2.82 m 9.17 ft	8 Wheelbase	6.55 m 21.33 ft
4 Rotor Hood Width	2.53 m 8.25 ft	9 Ground Clearance	506 mm 19.9 in
5 Height at ROPS	3.59 m 11.78 ft	Inside Turning Radius	4.33 m 14.2 ft



# RM500B ROTARY MIXER SPECIFICATIONS

## RM500B

EUROPE, CANADA, U.S. ONLY

WEIGHTS		
Operating Weight with ROPS cab		
Universal Rotor 16	28 400 kg	62,611 lb
Universal Rotor 18	28 770 kg	63,427 lb
Combination Rotor	27 439 kg	60,493 lb
Soil Rotor	28 261 kg	62,283 lb

ENGINE		
Engine Model	Cat C15	
Emissions	U.S. EPA Tier 4 Final, EU Stage V	
Gross Power – SAE J1995	407 kW	546 hp
Net Power – ISO 14396	402 kW	539 hp
Displacement	15.1 L	923 in <sup>3</sup>
Stroke	171 mm	6.7 in
Bore	137 mm	5.4 in
Max. Travel Speed (Forward or Reverse)	10 km/h	6.2 mph

SERVICE REFILL CAPACITIES		
Fuel Tank, total capacity	1056 L	279 gal
DEF Tank (EU, Canada and US only)	46 L	12.2 gal
Cooling System	70 L	18.5 gal
Engine Oil with Filter	52 L	15.7 gal
Propel Planetary Gear Reducer (each)		
Front	5 L	1.3 gal
Rear	4 L	1 gal
Hydraulic Tank (service refill)	224 L	59.2 gal
Rotor Drive Axle	17 L	4.5 gal
Rotor Bearing Reservoir	12 L	3.2 gal
Chain Case (each)	25.6 L	6.8 gal
Rotor Drive Planetary Gear Reducer (each)	3.8 L	1 gal
Rotor Transmission	12.4 L	3.25 gal

## RM500B

ALL OTHER REGIONS

WEIGHTS		
Operating Weight with ROPS cab		
Universal Rotor 16	27 970 kg	61,663 lb
Universal Rotor 18	28 245 kg	62,263 lb
Combination Rotor	27 009 kg	59,545 lb
Soil Rotor	27 831 kg	61,357 lb

ENGINE		
Engine Model	Cat C15	
Emissions	Equivalent to U.S. EPA Tier 3 and EU Stage IIIA, Brazil MAR-1	
Gross Power – SAE J1995	403 kW	540 hp
Net Power – ISO 14396	398 kW	534 hp
Displacement	15.1 L	923 in <sup>3</sup>
Stroke	171 mm	6.7 in
Bore	137 mm	5.4 in
Max. Travel Speed (Forward or Reverse)	10 km/h	6.2 mph

MISCELLANEOUS		
Electrical System	24 volts	
Tires		
Front	725-70/25 L-4	
Rear	23.1-26 LS-2	

ROTOR DRIVE SPECIFICATIONS		
Rotor Speeds @ 2000 engine rpm		
First	110 rpm	
Second	152 rpm	
Third	205 rpm	

The air conditioning system on this machine contains the fluorinated greenhouse gas refrigerant R134a (Global Warming Potential = 1430). The system contains 1.9 kg of refrigerant which has a CO<sub>2</sub> equivalent 2.717 metric tonne.



For more complete information on Cat products, dealer services and industry solutions, visit us on the web at [www.cat.com](http://www.cat.com)

QEHQ2620-02 (06/2021)

© 2021 Caterpillar. All Rights Reserved.

VisionLink is a trademark of Trimble Navigation Limited, registered in the United States and in other countries.

Materials and specifications are subject to change without notice. Featured machines in photos may include additional equipment. See your Cat dealer for available options.

CAT, CATERPILLAR, LET'S DO THE WORK, their respective logos, "Caterpillar Corporate Yellow", the "Power Edge" and Cat "Modern Hex" trade dress as well as corporate and product identity used herein, are trademarks of Caterpillar and may not be used without permission.

[www.cat.com](http://www.cat.com) [www.caterpillar.com](http://www.caterpillar.com)

