

# 390F L

## Hydraulic Excavator



### Engine

Engine Model	Cat® C18 ACERT™	
Power – ISO 14396	405 kW	543 hp
Power – ISO 14396 (metric)		551 hp
Power – ISO 9249	391 kW	524 hp
Power – ISO 9249 (metric)		532 hp

### Drive

Maximum Travel Speed	4.5 km/h	2.8 mph
Maximum Drawbar Pull	590 kN	132,637 lb

### Operating Weights

Minimum – Reach Configuration	86 275 kg	190,203 lb
Maximum – Mass Configuration	92 020 kg	202,869 lb

**The 390F L is built to keep your production numbers up and your owning and operating costs down.**

*Not only does the machine's C18 ACERT engine meet U.S. EPA Tier 2, EU Stage II, Japan 2001 (Tier 2) equivalent or U.S. EPA Tier 3, EU Stage IIIA, Japan 2006 (Tier 3) equivalent and China Nonroad III emission standards, but it does so while giving you all the power, fuel efficiency, and reliability you need to succeed.*

*Where the real power comes in is through the hydraulic system. You can literally move tons of material all day long with a great deal of speed and precision. In fact, the hydraulic system and engine work together to keep fuel consumption to an absolute minimum – all without impacting your productivity.*

*When you add in a quiet operator environment that keeps you comfortable and productive, service points that make your routine maintenance quick and easy, and multiple Cat work tools that help you take on a variety of jobs, you simply won't find a better 90 ton machine.*

**Contents**

Reliable and Productive.....	4
Fuel Efficient.....	6
Easy to Operate.....	8
Durable Structures.....	10
Durable Linkages.....	11
Versatile.....	12
Integrated Technologies.....	14
Safety.....	16
Serviceable.....	17
Sustainable.....	18
Customer Support.....	18
Specifications.....	19
Standard Equipment.....	32
Optional Equipment.....	33
Notes.....	34





**With a versatile hydraulic system, multiple configurations, and many work tool and tool control options, the 390F L is ideal for customers engaged in quarry and aggregates, road construction, and other large earthmoving projects.**



## Reliable and Productive

Precise power and control to move more material

### Powerful, Efficient Design

When it comes to moving heavy material quickly and efficiently, you need hydraulic horsepower – the type of ground-breaking power the 390F L can deliver. Major hydraulic components like pumps and valves are located close together so shorter tubes and lines can be used. This design leads to less friction loss, reduced pressure drops, and more power to the ground for the work you need to get done.

### Control Like No Other

The new Cat Adaptive Control System (ACS) valve is designed to intelligently manage restrictions and flows. It opens slowly when your range of joystick lever movement is small and opens rapidly when movement is high. It smartly puts flow exactly where you need it when you need it, which means you will experience much smoother operation, greater efficiency, and lower fuel consumption.

## SmartBoom™

### Reduces Stress and Vibrations Transmitted to the Machine

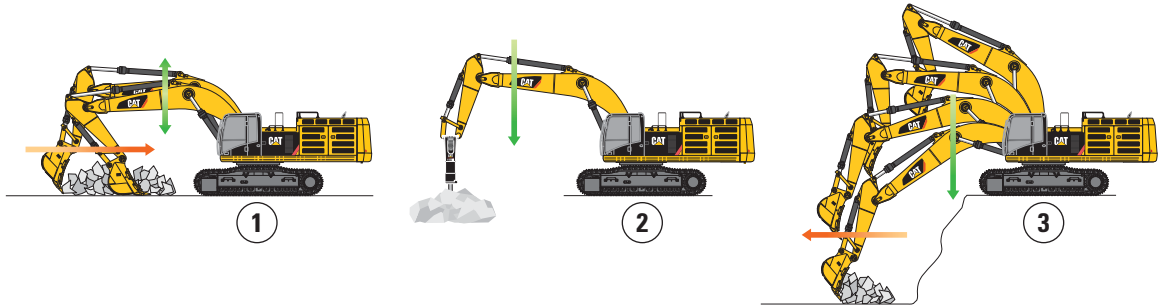

#### Rock Scraping (1)

Scraping rock and finishing work is easy and fast. SmartBoom simplifies the task and allows the operator to fully concentrate on the stick and bucket while the boom freely goes up and down without using pump flow.

#### Hammer Work (2)

It has never been this productive and operator-friendly. The front parts automatically follow the hammer while penetrating the rock. Blank shots or excessive force on the hammer are avoided, resulting in longer life for the hammer and machine. Similar advantages are applicable when using vibratory plates.

#### Truck Loading (3)

Loading trucks from a bench is more productive and fuel efficient as the return cycle is reduced while the boom down function does not require pump flow.

### Auxiliary Hydraulics for Added Versatility

Auxiliary hydraulics give you greater tool versatility so you can take on more work with just one machine, and there are several options from which you can choose. A quick coupler circuit, for example, will allow you to switch from one tool to another in a matter of minutes – all from the comfort and convenience of the cab.

# Fuel Efficient

Engineered to lower your operating costs





The Cat C18 ACERT engine meets Tier 2/Stage II/Japan 2001 (Tier 2) equivalent or Tier 3/Stage IIIA/Japan 2006 (Tier 3)/China Nonroad III equivalent emission standards and it does so without interrupting your job process. Simply turn the engine on and go to work. It will look for opportunities in your work cycle to regenerate itself, and it will give you plenty of power for the task at hand – all to help keep your owning and operating costs to an absolute minimum.

### **More Powerful, Reliable Engine Electronics**

Automatic engine speed control keeps rpm consistent for maximum efficiency, and it will lower rpm when the machine doesn't need it for work. Automatic engine idle shutdown turns the engine off when it's been idling for more than a specified amount of time that you can set through the monitor.

You have a choice of two power modes – standard power and eco mode – to help manage fuel for the task in front of you. Simply change between modes through the console switch panel.

Collectively, the engine fuel-saving features also reduce exhaust and sound emissions, reduce your repair and maintenance costs, and increase engine life.

### **Biodiesel Not a Problem**

The engine can run on up to B20 biodiesel that meets ASTM 6751 – EN14214 standards to give you potential fuel-saving flexibility.

### **A Cool Design for Any Temperature**

The 390F L features a new side-by-side cooling system that allows you to put the machine to work in extremely hot and cold conditions. The system is completely separated from the engine compartment to reduce noise and heat. Plus it features easy-to-clean cores and a new variable-speed fan that reverses to blow out unwanted debris that may accumulate during your work day.

The right technologies fine-tuned for the right applications result in:

- **Improved Fluid Efficiency** – Measurable improvement over 390D (including Diesel Exhaust Fluid consumption).
- **High Performance** across a variety of applications.
- **Enhanced Reliability** through commonality and simplicity of design.
- **Maximized Uptime and Reduced Cost** with world-class Cat dealer support.
- **Minimized Impact of Emission Systems** with no operator interaction required.
- **Durability** with long service life.
- **Better Fuel Economy** with minimized maintenance costs.
- **Same great power and response.**

# Easy to Operate

Comfort and convenience to keep you productive all day long

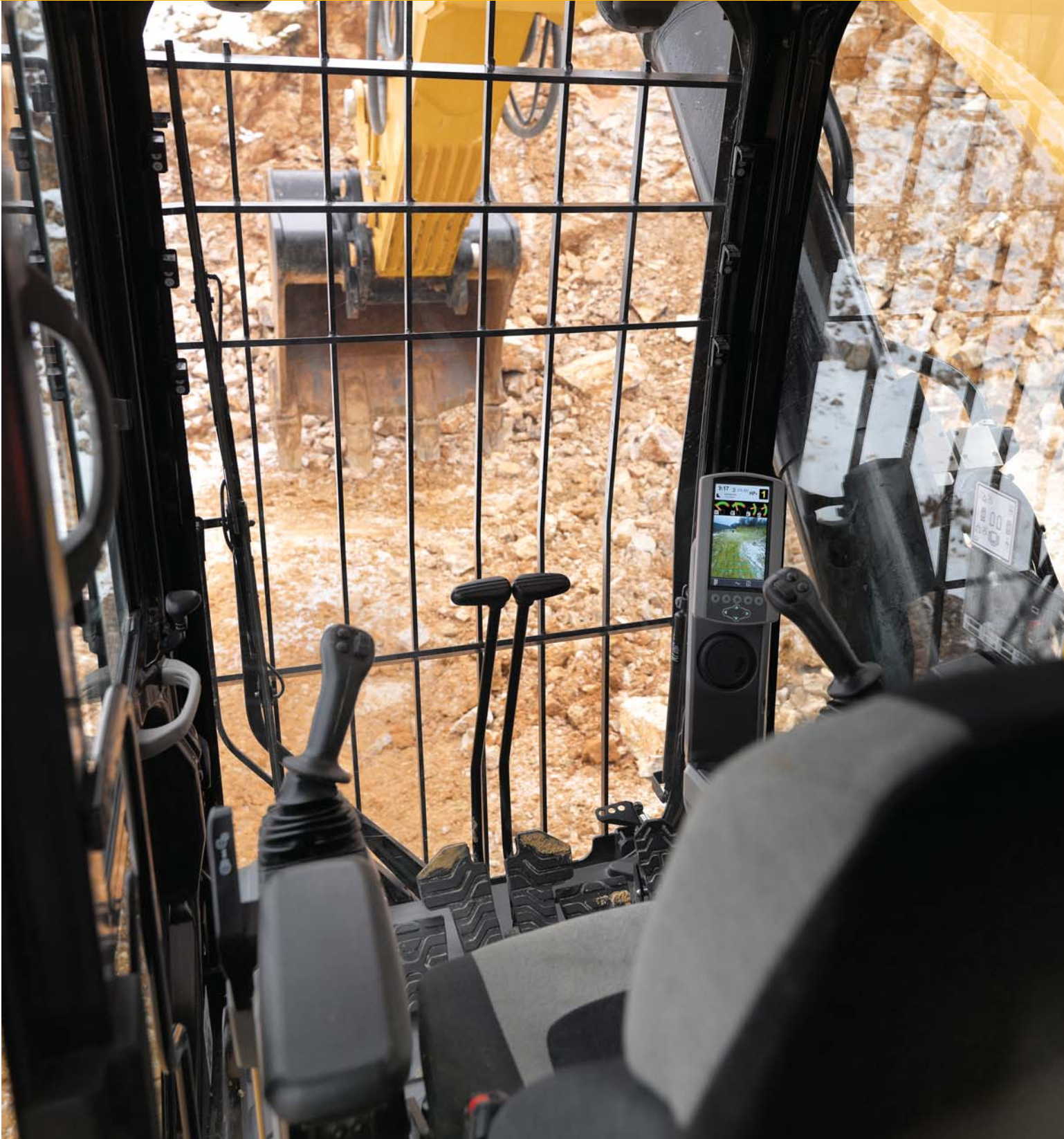



## Safe and Quiet Cab

The cab contributes to your comfort thanks to special viscous mounts and special roof lining and sealing, that limit vibration and unnecessary sound.

Operators will enjoy the quietness and comfort of the all-new cab that's insulated to reduce sound inside by 3 dB(A) over the previous model.

## Excellent Ergonomics

Wide seats with air suspension and heat and cooling options, and a fully automatic climate control system keep operators comfortable and productive all day long in either hot or cold weather.

Not only can the right and left joystick consoles be adjusted to improve your comfort and productivity during the course of a day, the joystick levers themselves can be adjusted for gain and response. Gain is the relationship between the control lever stroke and cylinder speed, and response is the time elapsed from the moment the control lever is operated until the cylinder attains speed.

The right joystick features a button that will reduce engine speed when you are not working to help save fuel. Touch it once and speed reduces; touch it again and speed increases for normal operation.

Large drink holders, storage areas in the front and rear, and auxiliary power outlets are located near key storage areas for convenient charging of MP3 players, cell phones, and laptops.



## Easy to Navigate Monitor

The new LCD monitor is easy to see and navigate. Programmable in up to 42 languages to meet today's diverse workforce, the monitor clearly displays critical information you need to operate efficiently and effectively. It serves as the projector for the standard rearview camera so you can stay safely focused on the job at hand.

# Durable Structures

Built to work in your tough, heavy-duty applications



## Undercarriage

Long variable gauge undercarriage contributes significantly to its outstanding stability and durability, and it adjusts to reduce shipping width.

Track shoes, links, rollers, idlers, and final drives are all built with high-tensile-strength steel for long-term durability.

Cat GLT4 track link protects moving parts by keeping water, debris, and dust out and grease sealed in, which delivers longer wear life and reduced noise when traveling.

## Frame

The 390F L is a robust, well-built machine designed to give you a very long service life. The upper frame includes special mountings made specifically to support the heavy-duty cab. It's also reinforced around areas that take on a lot of stress like the boom foot, skirt, and counterweight removal system.



Positive Pin Retention 2 (PPR2) prevents looseness of the track pin in the track link, reduces stress concentrations, and eliminates pin walking for increased service life.

Optional three-piece guide guards help maintain track alignment to improve your machine's overall performance – whether you're traveling on a flat, heavy bed of rock or a steep, wet field of mud.

## Counterweight

The pressed 12 400 kg (27,337 lb) fixed or removable counterweights are built with thick steel plates and reinforced fabrications to make them less susceptible to damage, and both have curved surfaces that match the machine's sleek, smooth appearance along with integrated housings to help protect the standard rearview camera.



# Durable Linkages

Options to take on your far-reaching or up-close tasks

### Booms, Sticks and Bucket Linkage for Any Job

The 390F L is offered with a range of Reach (R), General Purpose (GP) and Mass (ME) booms and sticks. Each is built with internal baffle plates and is stress relieved for added durability, and each undergoes ultrasound inspection to ensure quality and reliability.

Large box-section structures with thick, multi-plate fabrications, castings, and forgings are used in high-stress areas such as the boom nose, boom foot, boom cylinder, and stick foot to improve durability. Also, the boom nose pin retention method is a captured flag design for enhanced durability.

An extra-long 10.0 m (32'10") Reach boom (with 5.5 m [18'1"] or 4.4 m [14'5"] sticks) or an 8.4 m (27'7") General Purpose boom (with 5.5 m [18'1"], 4.4 m [14'5"] or 3.4 m [11'2"] sticks) offer you excellent all-around versatility for general excavation work like multipurpose digging and loading.

A 7.25 m (23'9") Mass boom (with 3.4 m [11'2"] or 2.92 m [9'7"] sticks) offer you enhanced performance in heavy-duty material like rock. They provide higher digging forces due to special boom and stick geometry, and bucket linkage and cylinders are built for greater durability.

Sticks are matched to the boom. Longer sticks are better when you need to dig deep or load trucks. Shorter sticks provide greater breakout force and increase your productivity when using hydromechanical work tools.

Bucket linkages with or without a lifting eye are available.

### Pins

All front linkage pins have thick chrome plating, giving them high wear resistance. Each pin diameter is made to distribute the shear and bending loads associated with the stick and to help ensure long pin, boom and stick life.

***Talk to your Cat dealer to pick the best front linkage options for your applications.***

# Versatile

Do more jobs with one machine





## Get the Most from One Machine

The Cat combination of machine and tool provides a total solution for just about any application. Work tools can be mounted either directly to the machine or to a quick coupler, making it fast and easy to release one work tool and pick up another.

## Change Jobs Quickly

Cat quick couplers enable the operator to simply release one work tool and pick up another so your hydraulic excavator becomes extremely versatile.

## Dig, Rip and Load

A wide range of buckets dig everything from basic top soil to extreme, harsh material like ore and high quartzite granite. Rip through rock as an alternative to blasting in quarries. High-capacity buckets load trucks in a minimum number of passes for maximum productivity.

## Break, Demolish and Scrap

A hydraulic hammer ably equips your machine for breaking rock in quarries. It will also make taking down bridge pillars and heavily reinforced concrete on road demolition jobs no problem.

Multi-processor and pulverizer attachments make your 390F L ideal for demolition jobs and processing the resulting debris. Shears with 360° rotation mount to the machine for processing scrap steel and metal.

## Set Up Your Machine for Maximum Profit

Your Cat dealer can install hydraulic kits to properly operate all Cat Work Tool attachments, which will maximize the machine's uptime and your profits. All Cat Work Tool attachments are supported by the same Cat dealer network as your Cat machine.

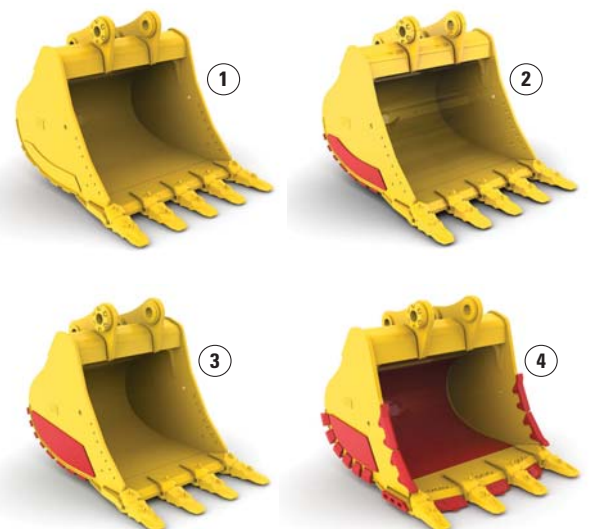

1) General Duty (GD) 2) Heavy Duty (HD)  
3) Severe Duty (SD) 4) Extreme Duty (XD)



# Integrated Technologies

Monitor, manage, and enhance job site operations

Cat Connect makes smart use of technology and services to improve your job site efficiency. Using the data from technology-equipped machines, you'll get more information and insight into your equipment and operations than ever before.

Featured Cat Connect technologies include:

### Cat Connect LINK Technologies

LINK technologies wirelessly connect you to your equipment giving you access to essential information you need to know to run your business. Link data can give you valuable insight into how your machine or fleet is performing so you can make timely, fact-based decisions that can boost job site efficiency and productivity.

Cat Connect technologies offer improvements in these key areas:



**Equipment Management** – increase uptime and reduce operating costs.



**Productivity** – monitor production and manage job site efficiency.



**Safety** – enhance job site awareness to keep your people and equipment safe.



### **Product Link™/VisionLink®**

Product Link is deeply integrated into your machine, helping to take the guesswork out of equipment management. Easy access to timely information like machine location, hours, fuel usage, idle time and event codes via the online VisionLink user interface can help you effectively manage your fleet and lower operating costs.



### **Cat Connect GRADE Technologies**

GRADE technologies combine digital design data, in-cab guidance and automatic machine control to help operators hit target grade faster and finish jobs quickly, accurately, and in fewer passes – improving grading productivity and efficiency with less rework.

### **Cat Grade Control Depth and Slope**

The factory integrated Cat Grade Control system provides depth and slope guidance enabling operators to cut or fill to exact target elevation, saving money on fuel and materials. Real-time bucket tip positioning through the standard cab monitor guides the operator to grade. Immediate feedback helps operators work confidently and efficiently, without the need for a grade checker. Optional integrated joystick controls simplify operation. Easily upgrade to AccuGrade™ 3D.

### **Cat AccuGrade**

The dealer-installed AccuGrade system provides 3D bucket tip position and elevation guidance, indicating precisely where to work and how much to cut or fill. Choose from Global Navigation Satellite System or Universal Total Station systems for large construction projects and complex 3D cuts/contours. AccuGrade eliminates grade staking and checking, reduces labor costs, and improves jobsite safety.



### **Cat Connect DETECT Technologies**

Detect technologies help keep people and equipment safe by enhancing operator awareness of the work area around the equipment, by integrating safety features and by monitoring and reporting unsafe conditions or equipment operation.

### **Rear Vision Camera**

The standard rear vision camera greatly enhances visibility behind the machine to help the operator work more productively. A panoramic rear view is automatically displayed on the new multi-function monitor during reverse travel. As an option, a second display can be added, providing a dedicated full-time rear view of the job site.

# Safety

Features to help protect you day in and day out



Optional Falling Object Guards (FOGS) further protect you from debris coming to the cab.

## Secure Contact Points

Multiple large steps will get you into the cab as well as a leg up to the catwalks and compartments. Extended hand and guard rails allow you to safely climb to the upper deck. Anti-skid plates on the catwalks, the surface of the upper structure, and the top of the storage box area reduce your slipping hazards in all types of weather conditions. And they can be removed for cleaning.

## Smart Lighting

Halogen lights provide plenty of illumination. Cab and boom lights can be programmed to stay on for up to 90 seconds after the engine has been turned off to help you safely exit the machine. Optional High Intensity Discharge (HID) lights are available for enhanced night-time visibility.

## Windows

Ample glass, coupled with the standard parallel wiper system, gives you excellent visibility out front and to the side of the machine.

## Monitor Warning System

The monitor is equipped with a buzzer that will warn you if critical events like pressure drops or temperature spikes happen so you can take immediate action.

## Anti-Skid Plates

Your slipping hazards are reduced with anti-skid plates on the catwalks, the surface of the upper structure, and the top of the storage box area. The plates are effective in all types of weather conditions, and they can be removed for cleaning.





# Serviceable

Designed to make your maintenance quick and easy



## Convenient Access Built In

You can reach routine maintenance items like greasing points and a concentrated remote greasing block on boom foot from ground level.

Compartments feature wide service doors designed to help prevent debris entry, and they also securely latch in place to help make your service work simpler.

Machine's slip-resistant 500 mm wide catwalks stretch the length of the 390F L to provide safe access to major and grouped service points, such as fuel and oil filters, and fluid taps.

## Quick and Convenient Fluids Service

Oil sample and pressure ports provide easy checking of machine condition and are standard on every machine.

You can ensure fast, easy, and secure changing of engine and hydraulic oil with the QuickEvac™ option.

The fuel tank's drain cock makes it easy and simple for you to remove water and sediment during routine maintenance. Plus an integrated fuel level indicator pops up to help you reduce the possibility of fuel tank overfilling.

An optional fast fill port accessible from ground level can make refueling even easier and faster.

## A Cool Design

The 390F L features a new side-by-side cooling system with easy-to-clean cores and a new variable-speed fan that reverses to blow out unwanted debris that may accumulate during your work day.

## A Fresh Idea

Selecting ventilation inside the cab allows outside air to enter through the fresh air filter. The filter is conveniently located on the side of the cab to make it easy to reach and replace, and it is protected by a lockable door that can be opened with the engine key.

# Customer Support

Unmatched support makes the difference



## Renowned Cat Dealer Support

- Your Cat dealer is ready to help you every step of the way. From new or used machine sales, to rental or rebuild options, your Cat dealer can provide an optimal solution to your business needs.
- Unsurpassed worldwide parts availability, trained technicians and customer support agreements maximize your machine uptime.
- Financing options are offered to meet a variety of customer needs.

## Sustainable Generations ahead in every way

The 390F L is designed to compliment your business plan, reduce emissions and minimize the consumption of natural resources.

- The C18 ACERT engine meets Tier 2/Stage II/Japan 2001 (Tier 2) equivalent or Tier 3/Stage IIIA/Japan 2006 (Tier 3)/China Nonroad III equivalent emission standards.
- The 390F L has the flexibility of running on either ultra-low-sulfur diesel (ULSD) fuel with 15 ppm of sulfur or less or biodiesel (up to B20) fuel blended with ULSD.
- An overfill indicator rises when the tank is full to help the operator avoid spilling.
- Quick fill ports with connectors ensure fast, easy, and secure changing of hydraulic oil.
- Major components are rebuildable, eliminating waste and saving money by giving the machine and/or major components a second life – and even a third life.
- Link technologies enable you to collect and analyze equipment and job site data so you can maximize productivity and reduce costs.
- The 390F L is an efficient, productive machine that's designed to conserve our natural resources for generations ahead.

# 390F L Hydraulic Excavator Specifications

## Engine

Engine Model	Cat C18 ACERT	
Power – ISO 14396	405 kW	543 hp
Power – ISO 14396 (metric)		551 hp
Net Power – ISO 9249	391 kW	524 hp
Net Power – ISO 9249 (metric)		532 hp
Net Power – EEC 80/1269	391 kW	524 hp
Net Power – EEC 80/1269 (metric)		532 hp
Bore	145 mm	5.7 in
Stroke	183 mm	7.2 in
Displacement	18.1 L	1,104.5 in <sup>3</sup>

- The 390F L meets Tier 2/Stage II/Japan 2001 (Tier 2) equivalent or Tier 3/Stage IIIA/Japan 2006 (Tier 3)/China Nonroad III equivalent emission standards.
- No engine power derating required below 2300 m (7,546 ft) altitude.
- Rating at 1,700 rpm (Implement).

## Operating Weights

Minimum – Reach Configuration	86 275 kg	190,203 lb
Maximum – Mass Configuration	92 020 kg	202,869 lb

## Drive

Maximum Travel Speed	4.5 km/h	2.8 mph
Maximum Drawbar Pull	590 kN	132,637 lbf

## Track

Standard	900 mm	35 in
Optional	750 mm	30 in
Optional	650 mm	26 in
Number of Shoes Each Side	51	
Number of Track Rollers Each Side	9	
Number of Carrier Rollers Each Side	3	

## Swing Mechanism

Swing Speed	6.2 rpm	
Swing Torque	260 kN·m	191,766 lbf·ft

## Service Refill Capacities

Fuel Tank Capacity	1240 L	328 gal
Cooling System	74 L	20 gal
Engine Oil	60 L	16 gal
Swing Drive (each)	19 L	5.0 gal
Final Drive (each)	21 L	5.5 gal
Hydraulic System Oil Capacity (including tank)	997 L	263 gal
Hydraulic Tank Oil	813 L	215 gal

## Hydraulic System

Main System – Maximum Flow (total)		
Implement	952 L/min	251 gal/min
Travel	1064 L/min	281 gal/min
Swing System – Maximum Flow		
No swing pump		
Maximum Pressure		
Equipment – Normal	35 000 kPa	5,076 psi
Travel	35 000 kPa	5,076 psi
Swing	26 000 kPa	3,771 psi
Pilot System		
Maximum Flow	67 L/min	17.7 gal/min
Maximum Pressure	4.0-4.4 MPa	580-638 psi
Boom Cylinder		
Bore	210 mm	8.3 in
Stroke	1967 mm	77 in
Stick Cylinder		
Bore	220 mm	8.7 in
Stroke	2262 mm	89 in
HB2 – Family Bucket Cylinder		
Bore	200 mm	7.9 in
Stroke	1451 mm	57 in
JC – Family Bucket Cylinder		
Bore	220 mm	8.7 in
Stroke	1586 mm	62 in

## Sound Performance

Operator Sound Pressure Level ISO 6396	74 dB(A)
Exterior Sound Power Level ISO 6395	109 dB(A)*

\* Per European Union Directive 2000/14/EC as amended by 2005/88/EC.

- When properly installed and maintained, the cab offered by Caterpillar, when tested with doors and windows closed according to ANSI/SAE J1166 OCT98, meets OSHA and MSHA requirements for operator sound exposure limits in effect at time of manufacture.
- Hearing protection may be needed when operating with an open operator station and cab (when not properly maintained or doors/windows open) for extended periods or in a noisy environment.

## Standards

Brakes	SAE J1026/APR90
Cab/FOGS	SAE J1356/FEB88 ISO 10262

# 390F L Hydraulic Excavator Specifications

## Dimensions

All dimensions are approximate.

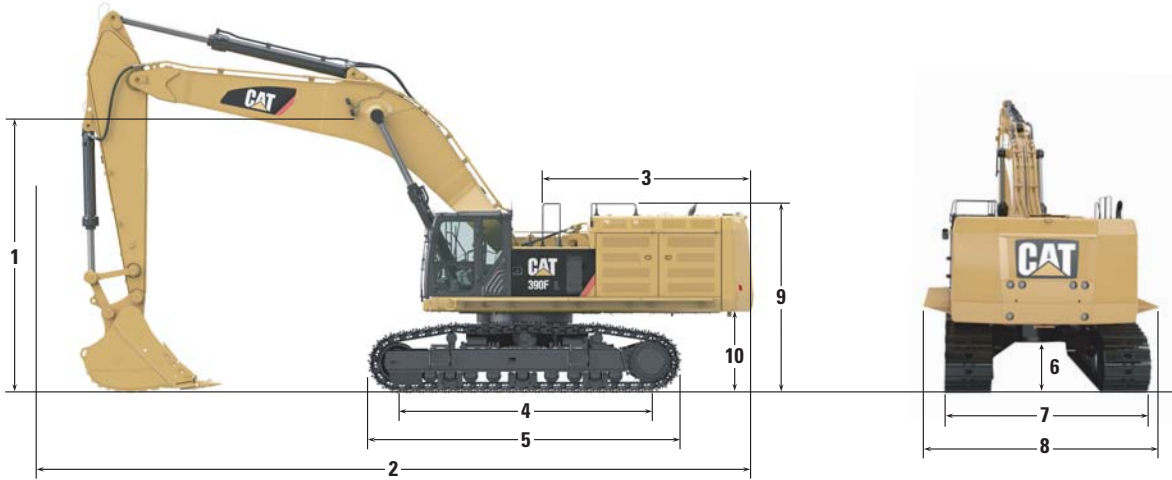

Boom Options		Reach Boom 10.0 m (32'10")		GP Boom 8.4 m (27'7")			Mass Boom 7.25 m (23'9")	
Stick Options		R5.5 m (18'1")	R4.4 m (14'5")	R5.5 m (18'1")	R4.4 m (14'5")	G3.4 m (11'2")	M3.4 m (11'2")	M2.92 m (9'7")
<b>1</b> Shipping Height	mm	5490	5070	5840	5290	5160	5310	5310
	ft/in	(18'0")	(16'8")	(19'2")	(17'4")	(16'11")	(17'5")	(17'5")
<b>2</b> Shipping Length	mm	16 290	16 330	14 500	14 690	14 720	13 550	13 830
	ft/in	(53'5")	(53'7")	(47'7")	(48'2")	(48'4")	(44'6")	(45'4")
<b>3</b> Tail Swing Radius	mm	4700	4700	4700	4700	4700	4700	4700
	ft/in	(15'5")	(15'5")	(15'5")	(15'5")	(15'5")	(15'5")	(15'5")
<b>4</b> Length to Center of Rollers	mm	5120	5120	5120	5120	5120	5120	5120
	ft/in	(16'10")	(16'10")	(16'10")	(16'10")	(16'10")	(16'10")	(16'10")
<b>5</b> Track Length	mm	6358	6358	6358	6358	6358	6358	6358
	ft/in	(20'10")	(20'10")	(20'10")	(20'10")	(20'10")	(20'10")	(20'10")
<b>6</b> Ground Clearance	mm	900	900	900	900	900	900	900
	ft/in	(2'11")	(2'11")	(2'11")	(2'11")	(2'11")	(2'11")	(2'11")
<b>7</b> Track Gauge (Retracted)	mm	2750	2750	2750	2750	2750	2750	2750
	ft/in	(9'0")	(9'0")	(9'0")	(9'0")	(9'0")	(9'0")	(9'0")
Track Gauge (Extended)	mm	3510	3510	3510	3510	3510	3510	3510
	ft/in	(11'6")	(11'6")	(11'6")	(11'6")	(11'6")	(11'6")	(11'6")
<b>8</b> Transport Width								
650 mm (26 in) Shoe	mm	4160	4160	4160	4160	4160	4160	4160
	ft/in	(13'8")	(13'8")	(13'8")	(13'8")	(13'8")	(13'8")	(13'8")
750 mm (30 in) Shoe	mm	4260	4260	4260	4260	4260	4260	4260
	ft/in	(14'0")	(14'0")	(14'0")	(14'0")	(14'0")	(14'0")	(14'0")
900 mm (35 in) Shoe	mm	4410	4410	4410	4410	4410	4410	4410
	ft/in	(14'6")	(14'6")	(14'6")	(14'6")	(14'6")	(14'6")	(14'6")
<b>9</b> Guardrail Height	mm	3830	3830	3830	3830	3830	3830	3830
	ft/in	(12'7")	(12'7")	(12'7")	(12'7")	(12'7")	(12'7")	(12'7")
<b>10</b> Counterweight Clearance	mm	1640	1640	1640	1640	1640	1640	1640
	ft/in	(5'5")	(5'5")	(5'5")	(5'5")	(5'5")	(5'5")	(5'5")
<b>Bucket Type</b>		GD	GD	GD	GD	SD	SDV	SDV
<b>Bucket Capacity</b>	m <sup>3</sup>	3.9	3.9	4.6	4.6	4.6	6.0	6.0
	yd <sup>3</sup>	(5.1)	(5.1)	(6.0)	(6.0)	(6.0)	(7.84)	(7.84)
<b>Bucket Tip Radius</b>	mm	2424	2424	2319	2319	2319	2505	2505
	ft/in	(8'0")	(8'0")	(7'7")	(7'7")	(7'7")	(8'2")	(8'2")

# 390F L Hydraulic Excavator Specifications

## Working Ranges

All dimensions are approximate.

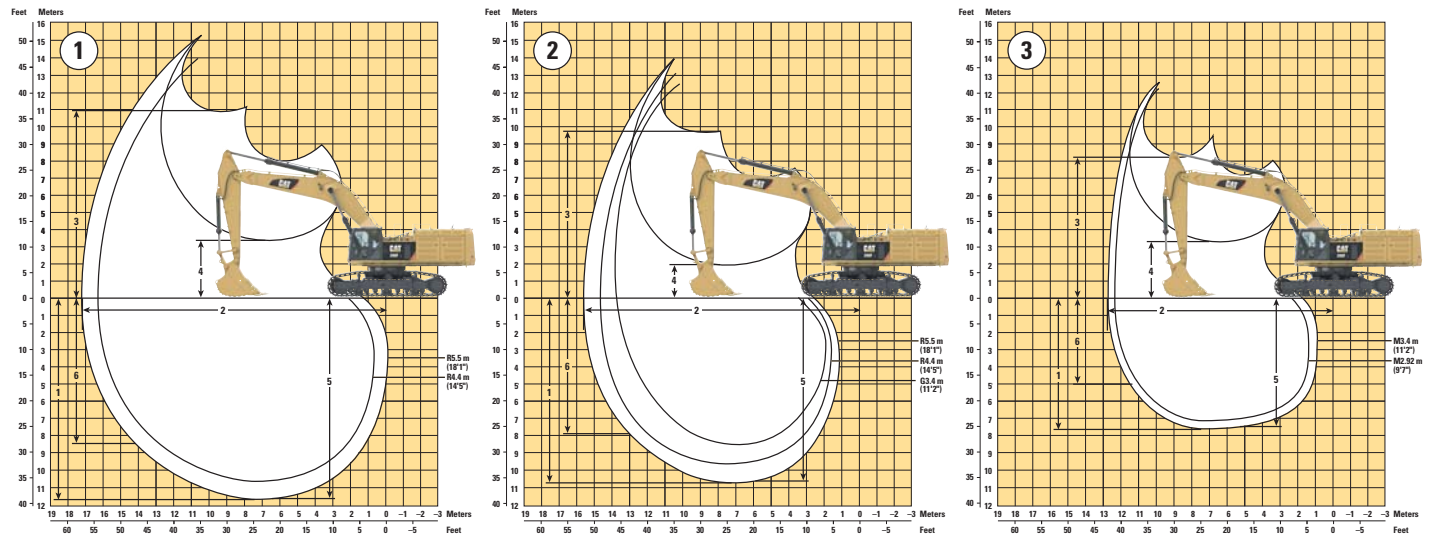

## Boom Options

①

**Reach Boom**  
10.0 m (32'10")

②

**GP Boom**  
8.4 m (27'7")

③

**Mass Boom**  
7.25 m (23'9")

### Stick Options

		<b>R5.5 m</b> <b>(18'1")</b>	<b>R4.4 m</b> <b>(14'5")</b>	<b>R5.5 m</b> <b>(18'1")</b>	<b>R4.4 m</b> <b>(14'5")</b>	<b>G3.4 m</b> <b>(11'2")</b>	<b>M3.4 m</b> <b>(11'2")</b>	<b>M2.92 m</b> <b>(9'7")</b>
<b>1</b> Maximum Digging Depth	mm	11 800	10 700	10 750	9650	8680	7640	7160
	ft/in	(38'9")	(35'1")	(35'3")	(31'8")	(28'6")	(25'1")	(23'6")
<b>2</b> Maximum Reach at Ground Line	mm	17 250	16 230	15 730	14 690	13 910	12 690	12 240
	ft/in	(56'7")	(53'3")	(51'7")	(48'2")	(45'8")	(41'8")	(40'2")
<b>3</b> Maximum Loading Height	mm	10 960	10 530	9730	9280	9100	8210	7990
	ft/in	(36'0")	(34'7")	(31'11")	(30'5")	(29'10")	(26'11")	(26'3")
<b>4</b> Minimum Loading Height	mm	3320	4420	1950	3050	4030	3210	3680
	ft/in	(10'11")	(14'6")	(6'5")	(10'0")	(13'3")	(10'6")	(12'1")
<b>5</b> Maximum Depth Cut for 2240 mm (8 ft) Level Bottom	mm	11 700	10 590	10 650	9540	8550	7510	7020
	ft/in	(38'5")	(34'9")	(34'11")	(31'4")	(28'1")	(24'8")	(23'0")
<b>6</b> Maximum Vertical Wall Digging Depth	mm	8380	7380	7860	6850	6180	5090	4690
	ft/in	(27'6")	(24'3")	(25'9")	(22'6")	(20'3")	(16'8")	(15'5")
Bucket Digging Force (ISO)	kN	364.8	363.3	364.8	363.3	470.9	470.9	470.4
	lbf	(82,010)	(81,673)	(82,010)	(81,673)	(105,862)	(105,863)	(105,750)
Stick Digging Force (ISO)	kN	235.9	276.0	235.9	276.0	325.5	325.5	356.3
	lbf	(53,032)	(62,047)	(53,032)	(62,047)	(73,175)	(73,175)	(80,099)
<b>Bucket Type</b>		GD	GD	GD	GD	SD	SDV	SDV
<b>Bucket Capacity</b>	m <sup>3</sup>	3.9	3.9	4.6	4.6	4.6	6.0	6.0
	yd <sup>3</sup>	(5.1)	(5.1)	(6.0)	(6.0)	(6.0)	(7.84)	(7.84)
<b>Bucket Tip Radius</b>	mm	2424	2424	2319	2319	2319	2505	2505
	ft/in	(8'0")	(8'0")	(7'7")	(7'7")	(7'7")	(8'2")	(8'2")

# 390F L Hydraulic Excavator Specifications

## Operating Weights and Ground Pressures

Boom		Stick		Bucket		900 mm (35 in) Shoe				750 mm (30 in) Shoe				650 mm (26 in) Shoe			
						Weight		Ground Pressure		Weight		Ground Pressure		Weight		Ground Pressure	
						m	ft/in	m	ft/in	m <sup>3</sup>	yd <sup>3</sup>	kg	lb	kPa	psi	kg	lb
R10.0	32'10"	R5.5	18'1"	3.9	5.1	89 827	198,034	88.1	12.8	88 780	195,726	104.5	15.2	87 906	193,800	119.4	17.3
R10.0	32'10"	R4.4	14'5"	3.9	5.1	89 319	196,914	87.6	12.7	88 272	194,606	103.9	15.1	87 398	192,680	118.7	17.2
GP8.4	27'7"	R5.5	18'1"	4.6	6.0	88 704	195,559	87.0	12.6	87 657	193,251	103.2	15.0	86 783	191,324	117.8	17.1
GP8.4	27'7"	R4.4	14'5"	4.6	6.0	88 196	194,439	86.5	12.5	87 149	192,131	102.6	14.9	86 275	190,204	117.2	17.0
GP8.4	27'7"	G3.4	11'2"	4.6	6.0	90 603	199,745	88.9	12.9	89 556	197,437	105.4	15.3	88 682	195,510	120.4	17.5
M7.25	23'9"	M3.4	11'2"	6.0	7.84	92 022	202,874	90.3	13.1	90 975	200,566	107.1	15.5	90 101	198,639	122.4	17.8
M7.25	23'9"	M2.92	9'7"	6.0	7.84	91 764	202,305	90.0	13.1	90 717	199,997	106.8	15.5	89 843	198,070	122.0	17.7









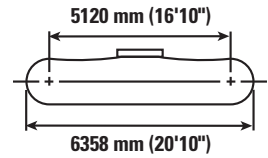
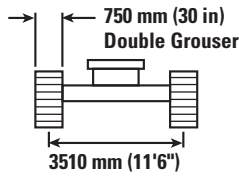
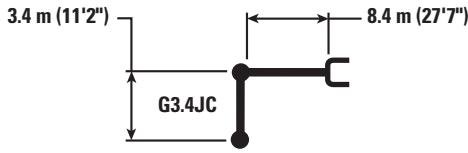

## Major Components Weights

	kg	lb
Base Machine (with counterweight, without front linkage, without bucket)		
650 mm (26 in) Tracks	66 739	147,134
750 mm (30 in) Tracks	67 613	149,061
900 mm (35 in) Tracks	68 660	151,369
Two Boom Cylinders	1804	3,977
Counterweight		
Removal Type	12 400	27,337
Non-removal Type	12 400	27,337
Boom (includes lines, pins, stick cylinder)		
Reach Boom – 10.0 m (32'10")	9839	21,691
General Purpose Boom – 8.4 m (27'7")	8392	18,501
Mass Boom – 7.25 m (23'9")	8437	18,600
Stick (includes lines, pins, bucket cylinder, linkage)		
R5.5 m (18'1")	5430	11,971
R4.4 m (14'5")	4922	10,851
G3.4 m (11'2")	5186	11,433
M3.4 m (11'2")	5447	12,009
M2.92 m (9'7")	5189	11,440
Bucket		
3.9 m <sup>3</sup> (5.1 yd <sup>3</sup> ) GD	4094	90,256
4.6 m <sup>3</sup> (6.0 yd <sup>3</sup> ) GD	4418	9,740
6.0 m <sup>3</sup> (7.84 yd <sup>3</sup> ) SDV	7674	16,918

# 390F L Hydraulic Excavator Specifications

## GP Boom Lift Capacities – Counterweight: 12.4 mt (27,337 lb)



		4.5 m/15.0 ft		6.0 m/20.0 ft		7.5 m/25.0 ft		9.0 m/30.0 ft		10.5 m/35.0 ft		 mm in		
														
10.5 m 35.0 ft	kg lb											*15 450 <b>*34,350</b>	*15 450 <b>*34,350</b>	8740 <b>340</b>
9.0 m 30.0 ft	kg lb							*18 750 <b>*41,150</b>	*18 750 <b>40,550</b>			*14 500 <b>*32,100</b>	*14 500 <b>*32,100</b>	9890 <b>390</b>
7.5 m 25.0 ft	kg lb					*21 450 <b>*46,450</b>	*21 450 <b>*46,450</b>	*19 250 <b>*41,900</b>	18 550 <b>39,850</b>	*17 150 14 200		*14 100 <b>*31,100</b>	13 700 <b>30,450</b>	10 710 <b>420</b>
6.0 m 20.0 ft	kg lb			*28 700 <b>*61,750</b>	*28 700 <b>*61,750</b>	*23 350 <b>*50,500</b>	*23 350 <b>*50,500</b>	*20 200 <b>*43,850</b>	17 950 <b>38,600</b>	*18 250 <b>*39,750</b>	13 950 <b>29,950</b>	*14 050 <b>*30,900</b>	12 350 <b>27,300</b>	11 260 <b>450</b>
4.5 m 15.0 ft	kg lb			*32 800 <b>*70,500</b>	31 350 <b>67,700</b>	*25 500 <b>*55,050</b>	22 600 <b>48,750</b>	*21 400 <b>*46,350</b>	17 200 <b>37,100</b>	*18 800 <b>*40,800</b>	13 550 <b>29,150</b>	*14 250 <b>*31,400</b>	11 500 <b>25,400</b>	11 590 <b>460</b>
3.0 m 10.0 ft	kg lb					*27 300 <b>*58,950</b>	21 500 <b>46,350</b>	*22 450 <b>*48,600</b>	16 550 <b>35,650</b>	*19 300 <b>*41,850</b>	13 150 <b>28,300</b>	*14 800 <b>*32,550</b>	11 100 <b>24,450</b>	11 720 <b>470</b>
1.5 m 5.0 ft	kg lb			*64,950	<b>61,350</b>	*28 250 <b>*61,150</b>	20 700 <b>44,600</b>	*23 100 <b>*50,000</b>	16 000 <b>34,450</b>	19 350 <b>41,600</b>	12 800 <b>27,600</b>	*15 650 <b>*34,500</b>	11 000 <b>24,250</b>	11 650 <b>460</b>
0.0 m 0.0 ft	kg lb			*33 250 <b>*76,750</b>	28 150 <b>60,550</b>	*28 200 <b>*61,150</b>	20 250 <b>43,600</b>	*23 100 <b>*50,050</b>	15 650 <b>33,700</b>	19 100 <b>41,150</b>	12 600 <b>27,150</b>	*17 050 <b>*37,500</b>	11 300 <b>24,850</b>	11 380 <b>450</b>
-1.5 m -5.0 ft	kg lb	*21 450 <b>*49,500</b>	*21 450 <b>*49,500</b>	*33 300 <b>*72,400</b>	28 200 <b>60,550</b>	*27 150 <b>*58,800</b>	20 100 <b>43,250</b>	*22 300 <b>*48,200</b>	15 500 <b>33,400</b>	*18 250 <b>*39,100</b>	12 550 <b>27,100</b>	*17 050 <b>*37,600</b>	12 000 <b>26,450</b>	10 900 <b>430</b>
-3.0 m -10.0 ft	kg lb	*35 400 <b>*77,250</b>	*35 400 <b>*77,250</b>	*30 150 <b>*65,400</b>	28 450 <b>61,150</b>	*24 900 <b>*53,800</b>	20 200 <b>43,550</b>	*20 350 <b>*43,650</b>	15 600 <b>33,650</b>			*16 600 <b>*36,500</b>	13 350 <b>29,500</b>	10 170 <b>400</b>
-4.5 m -15.0 ft	kg lb	*29 450 <b>*63,800</b>	*29 450 <b>*63,800</b>	*25 450 <b>*54,800</b>	*25 450 <b>*54,800</b>	*21 000 <b>*45,000</b>	20 600 <b>44,450</b>	*16 050 <b>*36,500</b>	*16 050			*15 500 <b>*33,900</b>	*15 500 <b>*33,900</b>	9130 <b>360</b>
-6.0 m -20.0 ft	kg lb			*18 000 <b>*37,850</b>	*18 000 <b>*37,850</b>	*13 500 <b>*30,050</b>	*13 500					*13 000 <b>*30,250</b>	*13 000 <b>*30,250</b>	7610 <b>290</b>



ISO 10567



\*Indicates that the load is limited by hydraulic lifting capacity rather than tipping load. The above loads are in compliance with hydraulic excavator lift capacity standard ISO 10567:2007. They do not exceed 87% of hydraulic lifting capacity or 75% of tipping load. Weight of all lifting accessories must be deducted from the above lifting capacities. Lifting capacities are based on the machine standing on a firm, uniform supporting surface. The use of a work tool attachment point to handle/lift objects, could affect the machine lift performance.









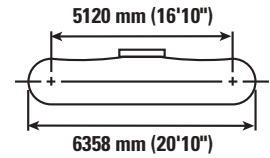
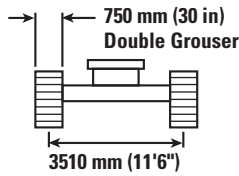
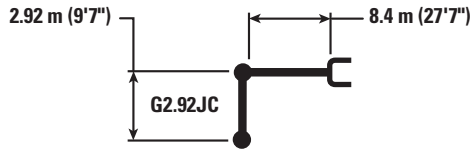



Lift capacity stays with ±5% for all available track shoes.

Always refer to the appropriate Operation and Maintenance Manual for specific product information.

# 390F L Hydraulic Excavator Specifications

## GP Boom Lift Capacities – Counterweight: 12.4 mt (27,337 lb)



		4.5 m/15.0 ft		6.0 m/20.0 ft		7.5 m/25.0 ft		9.0 m/30.0 ft		10.5 m/35.0 ft				mm in
														
10.5 m 35.0 ft	kg lb					*21 250 *47,000	*21 250 *47,000					*18 700 *41,650	*18 700 *41,650	8130 320
9.0 m 30.0 ft	kg lb					*21 300 *46,500	*21 300 *46,500	*19 850 *43,050	18 750 40,100			*17 500 *38,700	17 450 *38,700	9360 370
7.5 m 25.0 ft	kg lb					*22 500 *48,850	*22 500 *48,850	*20 150 *43,900	18 450 39,700			*16 950 *37,400	14 800 33,000	10 220 400
6.0 m 20.0 ft	kg lb			*30 300 *65,150	*30 300 *65,150	*24 400 *52,700	23 700 51,100	*21 000 *45,650	17 900 38,500	*19 000 *41,450	13 950 29,900	*16 900 *37,200	13 250 29,400	10 800 430
4.5 m 15.0 ft	kg lb					*26 400 *57,050	22 450 48,500	*22 100 *47,850	17 200 37,100	*19 350 *42,100	13 600 29,250	*17 200 *37,850	12 350 27,300	11 140 440
3.0 m 10.0 ft	kg lb					*28 000 *60,450	21 450 46,250	*23 000 *49,800	16 600 35,750	*19 750 *42,600	13 250 28,500	17 750 39,150	11 900 26,250	11 280 450
1.5 m 5.0 ft	kg lb					*28 650 *62,000	20 750 44,750	*23 450 *50,800	16 100 34,700	19 500 41,950	12 950 27,900	17 750 39,050	11 850 26,050	11 200 450
0.0 m 0.0 ft	kg lb			*31 000 *74,100	28 450 61,150	*28 250 *61,250	20 400 43,950	*23 250 *50,300	15 800 34,100	19 300 41,600	12 800 27,650	*18 200 *40,100	12 150 26,800	10 920 430
-1.5 m -5.0 ft	kg lb			*32 350 *70,400	28 550 61,350	*26 800 *58,150	20 350 43,850	*22 100 *47,750	15 750 33,950			*17 900 *39,400	13 000 28,700	10 420 410
-3.0 m -10.0 ft	kg lb	*32 300 *70,700	*32 300 *70,700	*28 850 *62,600	*28 850 *62,100	*24 150 *52,150	20 550 44,250	*19 550 *41,800	15 950 34,450			*17 200 *37,850	14 650 32,400	9650 380
-4.5 m -15.0 ft	kg lb	*26 250 *56,950	*26 250 *56,950	*23 550 *50,750	*23 550 *50,750	*19 500 *41,500	*19 500 *41,500					*15 650 *34,250	*15 650 *34,250	8550 340



ISO 10567



\*Indicates that the load is limited by hydraulic lifting capacity rather than tipping load. The above loads are in compliance with hydraulic excavator lift capacity standard ISO 10567:2007. They do not exceed 87% of hydraulic lifting capacity or 75% of tipping load. Weight of all lifting accessories must be deducted from the above lifting capacities. Lifting capacities are based on the machine standing on a firm, uniform supporting surface. The use of a work tool attachment point to handle/lift objects, could affect the machine lift performance.

Lift capacity stays with ±5% for all available track shoes.









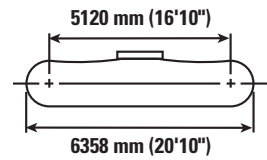
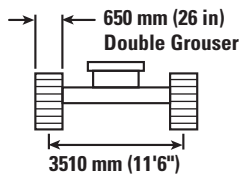
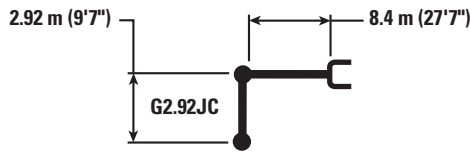



Always refer to the appropriate Operation and Maintenance Manual for specific product information.



# 390F L Hydraulic Excavator Specifications

## GP Boom Lift Capacities – Counterweight: 12.4 mt (27,337 lb)



		4.5 m/15.0 ft		6.0 m/20.0 ft		7.5 m/25.0 ft		9.0 m/30.0 ft		10.5 m/35.0 ft				mm in
														
10.5 m 35.0 ft	kg lb					*21 250 *47,000	*21 250 *47,000					*18 700 *41,650	*18 700 *41,650	8130 320
9.0 m 30.0 ft	kg lb					*21 300 *46,500	*21 300 *46,500	*19 850 *43,050	18 550 39,700			*17 500 *38,700	17 250 *38,700	9360 370
7.5 m 25.0 ft	kg lb					*22 500 *48,850	*22 500 *48,850	*20 150 *43,900	18 300 39,300			*16 950 *37,400	14 650 32,650	10 220 400
6.0 m 20.0 ft	kg lb			*30 300 *65,150	*30 300 *65,150	*24 400 *52,700	23 450 50,600	*21 000 *45,650	17 700 38,150	*19 000 *41,450	13 800 29,550	*16 900 *37,200	13 150 29,100	10 800 430
4.5 m 15.0 ft	kg lb					*26 400 *57,050	22 250 48,000	*22 100 *47,850	17 050 36,700	*19 350 *42,100	13 450 28,950	*17 200 *37,850	12 200 27,000	11 140 440
3.0 m 10.0 ft	kg lb					*28 000 *60,450	21 200 45,750	*23 000 *49,800	16 400 35,350	19 550 42,100	13 100 28,200	17 550 38,700	11 750 25,950	11 280 450
1.5 m 5.0 ft	kg lb					*28 650 *62,000	20 550 44,250	*23 450 *50,800	15 900 34,300	19 250 41,500	12 800 27,600	17 550 38,600	11 700 25,750	11 200 450
0.0 m 0.0 ft	kg lb			*31 000 *74,100	28 150 60,500	*28 250 *61,250	20 200 43,500	*23 250 *50,300	15 650 33,700	19 100 41,150	12 650 27,300	18 100 39,850	12 050 26,500	10 920 430
-1.5 m -5.0 ft	kg lb			*32 350 *70,400	28 250 60,700	*26 800 *58,150	20 150 43,350	*22 100 *47,750	15 550 33,550			*17 900 *39,400	12 850 28,400	10 420 410
-3.0 m -10.0 ft	kg lb	*32 300 *70,700	*32 300 *70,700	*28 850 *62,600	28 600 61,450	*24 150 *52,150	20 350 43,800	*19 550 *41,800	15 750 34,050			*17 200 *37,850	14 450 32,000	9650 380
-4.5 m -15.0 ft	kg lb	*26 250 *56,950	*26 250 *56,950	*23 550 *50,750	*23 550 *50,750	*19 500 *41,500	*19 500 *41,500					*15 650 *34,250	*15 650 *34,250	8550 340



ISO 10567



\*Indicates that the load is limited by hydraulic lifting capacity rather than tipping load. The above loads are in compliance with hydraulic excavator lift capacity standard ISO 10567:2007. They do not exceed 87% of hydraulic lifting capacity or 75% of tipping load. Weight of all lifting accessories must be deducted from the above lifting capacities. Lifting capacities are based on the machine standing on a firm, uniform supporting surface. The use of a work tool attachment point to handle/lift objects, could affect the machine lift performance.

Lift capacity stays with ±5% for all available track shoes.

Always refer to the appropriate Operation and Maintenance Manual for specific product information.

# 390F L Hydraulic Excavator Specifications

## Mass Boom Lift Capacities – Counterweight: 12.4 mt (27,337 lb)

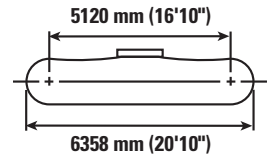
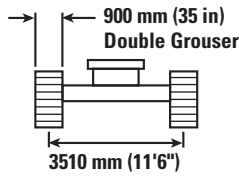
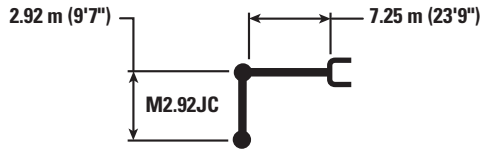

		3.0 m/10.0 ft		4.5 m/15.0 ft		6.0 m/20.0 ft		7.5 m/25.0 ft		9.0 m/30.0 ft		mm in		
10.5 m 35.0 ft	kg lb											*21 000	*21 000	6290
9.0 m 30.0 ft	kg lb							*22 700 *44,500	*22 700 *44,500			*19 000 *42,100	*19 000 *42,100	7820 310
7.5 m 25.0 ft	kg lb							*24 400 *53,150	*24 400 *53,150			*18 200 *40,200	*18 200 *40,200	8830 350
6.0 m 20.0 ft	kg lb			*39 800 *85,250	*39 800 *85,250	*30 550 *65,950	*30 550 *65,950	*25 650 *55,700	24 650 53,100	*22 750 *49,600	18 350 39,400	*18 150 *39,900	16 700 37,100	9500 380
4.5 m 15.0 ft	kg lb					*34 050 *73,400	33 250 71,750	*27 350 *59,200	23 650 50,950	*23 400 *50,800	17 850 38,400	*18 550 *40,850	15 350 33,900	9890 390
3.0 m 10.0 ft	kg lb					*36 700 *79,300	31 450 67,800	*28 800 *62,300	22 650 48,850	*23 950 *52,000	17 300 37,300	*19 550 *42,950	14 700 32,350	10 040 400
1.5 m 5.0 ft	kg lb					*37 450 *81,200	30 350 65,300	*29 400 *63,650	21 900 47,200	*24 100 *52,100	16 900 36,350	*21 150 *46,550	14 600 32,150	9960 400
0.0 m 0.0 ft	kg lb			*26 100 *60,800	*26 100 *60,800	*36 200 *78,600	29 850 64,200	*28 800 *62,300	21 500 46,300	*23 250 *50,100	16 650 35,850	*20 900 *46,100	15 150 33,400	9640 380
-1.5 m -5.0 ft	kg lb	*54,900	*54,900	*40 200 *87,750	*40 200 *87,750	*33 100 *71,850	29 850 64,150	*26 600 *57,400	21 400 46,150	*20 550	16 700	*20 250 *44,600	16 550 36,500	9060 360
-3.0 m -10.0 ft	kg lb			*33 150 *71,950	*33 150 *71,950	*27 850 *60,050	*27 850 *60,050	*21 950 *46,750	21 700 *46,750			*18 800 *41,250	*18 800 *41,250	8170 320
-4.5 m -15.0 ft	kg lb					*18 750 *39,200	*18 750 *39,200					*15 650 *36,400	*15 650 *36,400	6740 260



ISO 10567



\*Indicates that the load is limited by hydraulic lifting capacity rather than tipping load. The above loads are in compliance with hydraulic excavator lift capacity standard ISO 10567:2007. They do not exceed 87% of hydraulic lifting capacity or 75% of tipping load. Weight of all lifting accessories must be deducted from the above lifting capacities. Lifting capacities are based on the machine standing on a firm, uniform supporting surface. The use of a work tool attachment point to handle/lift objects, could affect the machine lift performance.

Lift capacity stays with ±5% for all available track shoes.

Always refer to the appropriate Operation and Maintenance Manual for specific product information.

# 390F L Hydraulic Excavator Specifications

## Mass Boom Lift Capacities – Counterweight: 12.4 mt (27,337 lb)

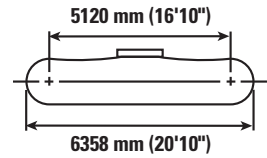
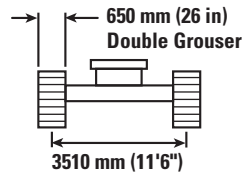
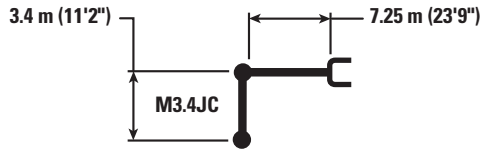

		3.0 m/10.0 ft		4.5 m/15.0 ft		6.0 m/20.0 ft		7.5 m/25.0 ft		9.0 m/30.0 ft		mm in		
10.5 m 35.0 ft	kg lb											*17 250 <b>*38,550</b>	*17 250 <b>*38,550</b>	6970 <b>270</b>
9.0 m 30.0 ft	kg lb							*21 550 <b>*45,550</b>	*21 550 <b>*45,550</b>			*15 800 <b>*34,950</b>	*15 800 <b>*34,950</b>	8380 <b>330</b>
7.5 m 25.0 ft	kg lb							*23 200 <b>*50,500</b>	*23 200 <b>*50,500</b>	*18 850 <b>*36,900</b>	18 400 <b>*36,900</b>	*15 200 <b>*33,500</b>	*15 200 <b>*33,500</b>	9330 <b>370</b>
6.0 m 20.0 ft	kg lb					*29 000 <b>*62,650</b>	*29 000 <b>*62,650</b>	*24 600 <b>*53,350</b>	24 400 <b>52,500</b>	*21 850 <b>*47,650</b>	18 050 <b>38,800</b>	*15 100 <b>*33,250</b>	*15 100 <b>*33,250</b>	9960 <b>390</b>
4.5 m 15.0 ft	kg lb			*45 150 <b>*96,800</b>	*45 150 <b>*96,800</b>	*32 650 <b>*70,500</b>	*32 650 <b>*70,500</b>	*26 450 <b>*57,250</b>	23 350 <b>50,250</b>	*22 700 <b>*49,300</b>	17 500 <b>37,700</b>	*15 450 <b>*33,950</b>	13 950 <b>30,850</b>	10 330 <b>410</b>
3.0 m 10.0 ft	kg lb					*35 800 <b>*77,300</b>	31 100 <b>67,000</b>	*28 100 <b>*60,850</b>	22 250 <b>48,000</b>	*23 500 <b>*50,950</b>	16 950 <b>36,450</b>	*16 200 <b>*35,600</b>	13 350 <b>29,450</b>	10 480 <b>420</b>
1.5 m 5.0 ft	kg lb					*37 200 <b>*80,550</b>	29 750 <b>64,050</b>	*29 050 <b>*62,950</b>	21 400 <b>46,150</b>	*23 850 <b>*51,700</b>	16 400 <b>35,350</b>	*17 450 <b>*38,350</b>	13 300 <b>29,250</b>	10 400 <b>410</b>
0.0 m 0.0 ft	kg lb			*27 900 <b>*64,500</b>	*27 900 <b>*64,500</b>	*36 650 <b>*79,450</b>	29 100 <b>62,550</b>	*28 900 <b>*62,550</b>	20 900 <b>45,000</b>	*23 450 <b>*50,650</b>	16 100 <b>34,650</b>	*19 400 <b>*42,800</b>	13 700 <b>30,200</b>	10 100 <b>400</b>
-1.5 m -5.0 ft	kg lb	*23 500 <b>*53,050</b>	*23 500 <b>*53,050</b>	*41 650 <b>*93,550</b>	*41 650 <b>*93,550</b>	*34 200 <b>*74,100</b>	28 900 <b>62,150</b>	*27 250 <b>*58,850</b>	20 700 <b>44,600</b>	*21 650 <b>*46,350</b>	16 000 <b>34,550</b>	*19 450 <b>*42,850</b>	14 800 <b>32,700</b>	9550 <b>380</b>
-3.0 m -10.0 ft	kg lb	*38 650 <b>*87,350</b>	*38 650 <b>*87,350</b>	*36 350 <b>*78,900</b>	*36 350 <b>*78,900</b>	*29 650 <b>*64,050</b>	29 150 <b>62,700</b>	*23 550 <b>*50,500</b>	20 850 <b>45,000</b>			*18 450 <b>*40,500</b>	17 050 <b>37,800</b>	8700 <b>350</b>
-4.5 m -15.0 ft	kg lb			*26 650 <b>*57,100</b>	*26 650 <b>*57,100</b>	*22 050 <b>*46,750</b>	*22 050 <b>*46,750</b>					*15 900 <b>*34,650</b>	*15 900 <b>*34,650</b>	7450 <b>290</b>



ISO 10567



\*Indicates that the load is limited by hydraulic lifting capacity rather than tipping load. The above loads are in compliance with hydraulic excavator lift capacity standard ISO 10567:2007. They do not exceed 87% of hydraulic lifting capacity or 75% of tipping load. Weight of all lifting accessories must be deducted from the above lifting capacities. Lifting capacities are based on the machine standing on a firm, uniform supporting surface. The use of a work tool attachment point to handle/lift objects, could affect the machine lift performance.

Lift capacity stays with  $\pm 5\%$  for all available track shoes.

Always refer to the appropriate Operation and Maintenance Manual for specific product information.

# 390F L Hydraulic Excavator Specifications

## Mass Boom Lift Capacities – Counterweight: 12.4 mt (27,337 lb)

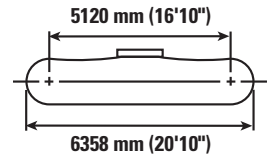
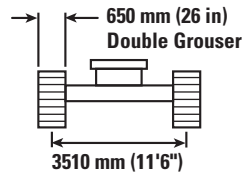
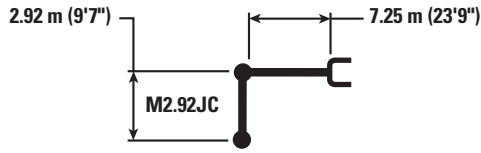

		3.0 m/10.0 ft		4.5 m/15.0 ft		6.0 m/20.0 ft		7.5 m/25.0 ft		9.0 m/30.0 ft		mm in		
10.5 m 35.0 ft	kg lb											*21 000	*21 000	6290
9.0 m 30.0 ft	kg lb							*22 700 *44,500	*22 700 *44,500			*19 000 *42,100	*19 000 *42,100	7820 310
7.5 m 25.0 ft	kg lb							*24 400 *53,150	*24 400 *53,150			*18 200 *40,200	*18 200 *40,200	8830 350
6.0 m 20.0 ft	kg lb			*39 800 *85,250	*39 800 *85,250	*30 550 *65,950	*30 550 *65,950	*25 650 *55,700	24 200 52,050	*22 750 *49,600	17 950 38,550	*18 150 *39,900	16 350 36,300	9500 380
4.5 m 15.0 ft	kg lb					*34 050 *73,400	32 600 70,300	*27 350 *59,200	23 150 49,900	*23 400 *50,800	17 450 37,600	*18 550 *40,850	15 000 33,150	9890 390
3.0 m 10.0 ft	kg lb					*36 700 *79,300	30 800 66,350	*28 800 *62,300	22 200 47,800	*23 950 *52,000	16 950 36,450	*19 550 *42,950	14 350 31,600	10 040 400
1.5 m 5.0 ft	kg lb					*37 450 *81,200	29 650 63,850	*29 400 *63,650	21 450 46,150	*24 100 *52,100	16 500 35,550	*21 150 *46,550	14 250 31,400	9960 400
0.0 m 0.0 ft	kg lb			*26 100 *60,800	*26 100 *60,800	*36 200 *78,600	29 200 62,800	*28 800 *62,300	21 000 45,250	*23 250 *50,100	16 250 35,050	*20 900 *46,100	14 800 32,600	9640 380
-1.5 m -5.0 ft	kg lb	*54,900	*54,900	*40 200 *87,750	*40 200 *87,750	*33 100 *71,850	29 150 62,700	*26 600 *57,400	20 900 45,100	*20 550	16 300	*20 250 *44,600	16 150 35,700	9060 360
-3.0 m -10.0 ft	kg lb			*33 150 *71,950	*33 150 *71,950	*27 850 *60,050	*27 850 *60,050	*21 950 *46,750	21 250 45,800			*18 800 *41,250	*18 800 *41,250	8170 320
-4.5 m -15.0 ft	kg lb					*18 750 *39,200	*18 750 *39,200					*15 650 *36,400	*15 650 *36,400	6740 260



ISO 10567



\*Indicates that the load is limited by hydraulic lifting capacity rather than tipping load. The above loads are in compliance with hydraulic excavator lift capacity standard ISO 10567:2007. They do not exceed 87% of hydraulic lifting capacity or 75% of tipping load. Weight of all lifting accessories must be deducted from the above lifting capacities. Lifting capacities are based on the machine standing on a firm, uniform supporting surface. The use of a work tool attachment point to handle/lift objects, could affect the machine lift performance.

Lift capacity stays with ±5% for all available track shoes.

Always refer to the appropriate Operation and Maintenance Manual for specific product information.

# 390F L Hydraulic Excavator Specifications

## Bucket Specifications and Compatibility

	Linkage	Width		Capacity		Weight		Fill	650 mm (26 in) DG Shoe				650 mm (26 in) DG Shoe				750 mm (30 in) DG Shoe				
		mm	in	m³	yd³	kg	lb		%	General Boom		ME Boom		General Boom		ME Boom		General Boom		ME Boom	
										2.92 m (9'7")	3.4 m (11'2")	2.92 m (9'7")	3.4 m (11'2")	2.92 m (9'7")	3.4 m (11'2")	2.92 m (9'7")	3.4 m (11'2")	2.92 m (9'7")	3.4 m (11'2")	2.92 m (9'7")	3.4 m (11'2")
<b>Without Quick Coupler</b>																					
General Duty (GD)	JC	2300	91	5.7	7.4	5822	12,832	100%	◇	◇	⊖	○	◇	◇	⊖	⊖	◇	◇	⊖	○	
	JC	2420	95	6.0	7.9	6004	13,233	100%	◇	⊗	⊖	○	◇	◇	⊖	○	◇	⊗	⊖	○	
	JC	2575	101	6.5	8.5	6238	13,749	100%	◇	⊗	○	○	◇	⊗	○	○	◇	⊗	○	○	
Heavy Duty (HD)	JC	1750	69	4.1	5.3	4799	10,577	100%	⊖	⊖	●	●	⊖	⊖	●	●	⊖	⊖	●	●	
	JC	2090	82	5.1	6.6	5441	11,992	100%	○	◇	⊖	⊖	○	◇	⊖	⊖	○	◇	⊖	⊖	
	JC	2300	91	5.7	7.4	5892	12,986	100%	◇	◇	⊖	○	◇	◇	⊖	⊖	◇	◇	⊖	○	
Severe Duty (SD)	JC	1960	77	4.6	6.0	6229	13,729	90%	○	◇	●	●	⊖	○	●	●	○	○	●	●	
Severe Duty (SDV)	JC	2200	87	5.4	7.0	6809	15,007	90%	◇	⊗	⊖	⊖	◇	◇	⊖	⊖	◇	◇	⊖	⊖	
	JC	2350	93	5.4	7.6	7015	15,462	90%	◇	⊗	⊖	○	◇	◇	⊖	⊖	◇	⊗	⊖	○	
Extreme Duty (XDV)	JC	2200	87	5.0	6.5	7411	16,334	90%	◇	⊗	⊖	○	◇	◇	⊖	⊖	◇	⊗	⊖	○	
	JC	2350	93	5.4	7.1	7758	17,099	90%	⊗	⊗	⊖	○	◇	⊗	⊖	○	◇	⊗	⊖	○	
	JC	2500	98	5.7	7.5	7993	17,617	90%	⊗	⊗	○	◇	⊗	⊗	⊖	○	X	⊗	○	○	
Extreme Duty Granite (XDG)	JC	2090	82	5.0	6.5	7729	17,035	90%	◇	⊗	⊖	○	◇	⊗	⊖	⊖	◇	⊗	⊖	○	
	JC	2090	82	5.0	6.5	7826	17,249	90%	◇	⊗	⊖	○	◇	⊗	⊖	⊖	◇	⊗	⊖	○	
Maximum load pin on (payload + bucket)									kg	12 117	11 108	15 387	14 126	12 565	11 533	15 912	14 621	12 271	11 255	15 568	14 297
									lb	26,706	24,482	33,913	31,134	27,693	25,419	35,070	32,225	27,045	24,806	34,312	31,511
<b>With Quick Coupler (CW-70)</b>																					
Severe Duty (SD)	JC	2150	85	5.4	7.1	6243	13,760	90%	◇	◇	●	⊖	○	◇	●	⊖	◇	◇	●	⊖	
	JC	2300	90	5.4	7.1	6556	14,449	90%	◇	⊗	⊖	⊖	◇	◇	⊖	⊖	◇	◇	⊖	⊖	
Extreme Duty (XDV)	JC	2350	93	5.4	7.1	7881	17,370	90%	⊗	⊗	○	○	◇	⊗	⊖	○	⊗	⊗	⊖	○	
Maximum load pin on (payload + bucket)									kg	11 871	10 862	15 141	13 880	12 319	11 287	15 666	14 375	12 025	11 009	15 322	14 051
									lb	26,164	23,940	33,371	30,592	27,152	24,877	34,528	31,683	26,504	24,264	33,770	30,969

### Maximum Material Density

- 2100 kg/m³ (3,500 lb/yd³)
- ⊖ 1800 kg/m³ (3,000 lb/yd³)
- 1500 kg/m³ (2,500 lb/yd³)
- ◇ 900 kg/m³ (1,500 lb/yd³)
- ⊗ Not Recommended

The above loads are in compliance with hydraulic excavator standard EN474, they do not exceed 87% of hydraulic lifting capacity or 75% of tipping capacity with front linkage fully extended at ground line with bucket curled.

Capacity based on ISO 7451.

Bucket weight with Long tips.

Caterpillar recommends using appropriate work tools to maximize the value customers receive from our products. Use of work tools, including buckets, which are outside of Caterpillar's recommendations or specifications for weight, dimensions, flows, pressures, etc. may result in less-than-optimal performance, including but not limited to reductions in production, stability, reliability, and component durability. Improper use of a work tool resulting in sweeping, prying, twisting and/or catching of heavy loads will reduce the life of the boom and stick.

# 390F L Hydraulic Excavator Specifications

## Bucket Specifications and Compatibility

	Linkage	Width		Capacity		Weight		Fill	750 mm (30 in) DG Shoe				900 mm (35 in) DG Shoe				900 mm (35 in) DG Shoe				
		mm	in	m <sup>3</sup>	yd <sup>3</sup>	kg	lb		%	General Boom		ME Boom		General Boom		ME Boom		General Boom		ME Boom	
										2.92 m (9'7")	3.4 m (11'2")	2.92 m (9'7")	3.4 m (11'2")	2.92 m (9'7")	3.4 m (11'2")	2.92 m (9'7")	3.4 m (11'2")	2.92 m (9'7")	3.4 m (11'2")	2.92 m (9'7")	3.4 m (11'2")
<b>Without Quick Coupler</b>																					
General Duty (GD)	JC	2300	91	5.7	7.4	5822	12,832	100%	○	◇	●	⊖	◇	◇	⊖	⊖	○	◇	●	⊖	
	JC	2420	95	6.0	7.9	6004	13,233	100%	◇	◇	⊖	○	◇	◇	⊖	○	◇	◇	⊖	○	
	JC	2575	101	6.5	8.5	6238	13,749	100%	◇	⊗	⊖	○	◇	⊗	○	○	◇	⊗	⊖	○	
Heavy Duty (HD)	JC	1750	69	4.1	5.3	4799	10,577	100%	●	⊖	●	●	●	⊖	●	●	●	⊖	●	●	
	JC	2090	82	5.1	6.6	5441	11,992	100%	○	○	●	●	○	◇	●	⊖	○	○	●	●	
	JC	2300	91	5.7	7.4	5892	12,986	100%	◇	◇	⊖	⊖	◇	◇	⊖	⊖	○	◇	●	⊖	
Severe Duty (SD)	JC	1960	77	4.6	6.0	6229	13,729	90%	⊖	○	●	●	⊖	○	●	●	⊖	○	●	●	
Severe Duty (SDV)	JC	2200	87	5.4	7.0	6809	15,007	90%	○	◇	●	⊖	◇	◇	●	⊖	○	◇	●	⊖	
	JC	2350	93	5.4	7.6	7015	15,462	90%	◇	◇	●	⊖	◇	◇	●	⊖	○	◇	●	⊖	
Extreme Duty (XDV)	JC	2200	87	5.0	6.5	7411	16,334	90%	◇	◇	●	⊖	◇	⊗	●	⊖	○	◇	●	⊖	
	JC	2350	93	5.4	7.1	7758	17,099	90%	◇	⊗	⊖	○	◇	⊗	⊖	○	◇	⊗	⊖	○	
	JC	2500	98	5.7	7.5	7993	17,617	90%	◇	⊗	⊖	○	⊗	⊗	⊖	○	◇	⊗	⊖	○	
Extreme Duty Granite (XDG)	JC	2090	82	5.0	6.5	7729	17,035	90%	◇	⊗	●	⊖	◇	⊗	⊖	⊖	◇	◇	●	⊖	
	JC	2090	82	5.0	6.5	7826	17,249	90%	◇	⊗	●	⊖	◇	⊗	⊖	○	◇	⊗	●	⊖	
Maximum load pin on (payload + bucket)									kg	12 719	11 680	16 093	14 791	12 457	11 431	15 785	14 501	12 904	11 856	16 310	14 996
									lb	28,033	25,743	35,469	32,599	27,455	25,194	34,790	31,960	28,440	26,131	35,947	33,051
<b>With Quick Coupler (CW-70)</b>																					
Severe Duty (SD)	JC	2150	85	5.4	7.1	6243	13,760	90%	○	◇	●	⊖	○	◇	●	⊖	○	◇	●	⊖	
	JC	2300	90	5.4	7.1	6556	14,449	90%	○	◇	●	⊖	◇	◇	●	⊖	○	◇	●	⊖	
Extreme Duty (XDV)	JC	2350	93	5.4	7.1	7881	17,370	90%	◇	⊗	⊖	○	⊗	⊗	⊖	○	◇	⊗	⊖	○	
Maximum load pin on (payload + bucket)									kg	12 473	11 434	15 847	14 545	12 211	11 185	15 539	14 255	12 658	11 610	16 064	14 750
									lb	27,491	25,201	34,927	32,058	26,913	24,652	34,248	31,418	27,899	25,589	35,405	32,509

### Maximum Material Density

- 2100 kg/m<sup>3</sup> (3,500 lb/yd<sup>3</sup>)
- 1800 kg/m<sup>3</sup> (3,000 lb/yd<sup>3</sup>)
- ⊖ 1500 kg/m<sup>3</sup> (2,500 lb/yd<sup>3</sup>)
- 1200 kg/m<sup>3</sup> (2,000 lb/yd<sup>3</sup>)
- ◇ 900 kg/m<sup>3</sup> (1,500 lb/yd<sup>3</sup>)
- ⊗ Not Recommended

The above loads are in compliance with hydraulic excavator standard EN474, they do not exceed 87% of hydraulic lifting capacity or 75% of tipping capacity with front linkage fully extended at ground line with bucket curled.

Capacity based on ISO 7451.

Bucket weight with Long tips.

Caterpillar recommends using appropriate work tools to maximize the value customers receive from our products. Use of work tools, including buckets, which are outside of Caterpillar's recommendations or specifications for weight, dimensions, flows, pressures, etc. may result in less-than-optimal performance, including but not limited to reductions in production, stability, reliability, and component durability. Improper use of a work tool resulting in sweeping, prying, twisting and/or catching of heavy loads will reduce the life of the boom and stick.

# 390F L Hydraulic Excavator Specifications

## Work Tool Offering Guide\*

Boom Type	Reach Boom – 10.0 m (32'10")		GP Boom – 8.4 m (27'7")			Mass Boom – 7.25 m (23'9")	
	R5.5 m (18'1")	R4.4 m (14'5")	R5.5 m (18'1")	R4.4 m (14'5")	R3.4 m (11'2")	M3.4 m (11'2")	M2.92 m (9'7")
Multi-Processor	MP40	MP40	MP40	MP40	MP40	MP40	MP40
Mobile Scrap and Demolition Shear	S385C**	S385C**	S385C**	S385C**	S385C**	S385C**	S385C**
CW Quick Coupler	CW70	CW70	CW70	CW70	CW70	CW70	CW70
Rippers	These work tools are available for the 390F L. Consult your Cat dealer for proper match.						

\*Matches are dependent on excavator configurations. Consult your Cat dealer for proper work tool match.

\*\*Pin on only.

# 390F L Standard Equipment

## Standard Equipment

Standard equipment may vary. Consult your Cat dealer for details.

### CAB

- Parallel wiper and washer
- Mirrors
- Pressurized operator station with positive filtration
- Laminated glass front upper window and tempered other windows
- Sliding upper door window (left-hand cab door)
- Removable lower windshield with in cab storage bracket
- Openable skylight
- Interior:
  - Glass-breaking safety hammer
  - Coat hook
  - Beverage holder
  - Literature holder
  - Interior lighting
  - AM/FM radio mounting (DIN size)
  - Two 12V stereo speakers
  - Storage shelf suitable for lunch or toolbox
  - Power supply with 12V, two power outlets (10 amp)
  - Thumb wheel modulation joystick for use with combined auxiliary control
  - Sun screen
  - Air conditioner, heater and defroster with climate control
- Seat:
  - Seatbelt, 76 mm (3 in)
  - Adjustable armrest
  - Height adjustable joystick consoles
  - Neutral lever (lock out) for all controls
  - Travel control pedals with removable hand levers
  - Capability of installing two additional pedals
  - Two speed travel
  - Floor mat, washable
- Monitor:
  - Clock
  - Video ready
  - Color LCD display with warning, filter/fluid change, and working hour information
  - Language display (full graphic and full color display)
  - Machine condition, error code and tool mode setting information
  - Start-up level check for engine oil, engine coolant and hydraulic oil
  - Warning, filter/fluid change and working hour information
  - Fuel consumption meter

### ELECTRICAL

- 80 amp alternator
- Circuit breaker
- Battery, standard

### ENGINE

- C18 ACERT diesel engine
- Tier 2/Stage II/Japan 2001 (Tier 2) equivalent or Tier 3/Stage IIIA/Japan 2006 (Tier 3)/China Nonroad III equivalent emission standards package
- 2300 m (7,546 ft) altitude capability with no derate
- Biodiesel capable
- Automatic engine speed control
- Electric priming pump with switch
- Water separator in fuel line including water level sensor and indicator
- Economy and standard power modes
- Air cleaner
- Side-by-side cooling system
- Steel wall between engine and pump compartment
- Primary filter with water separator and water separator indicator switch
- Starting kit, cold weather,  $-18^{\circ}\text{C}$  ( $-0.4^{\circ}\text{F}$ )
- Primary fuel filter
- Secondary fuel filter
- Tertiary fuel filter

### HYDRAULIC SYSTEM

- Reverse swing dampening valve
- Automatic swing parking brake
- High-performance hydraulic return filter
- Regeneration circuit for boom and stick
- Capability of installing additional auxiliary circuits
- Reversing cooling fan

### LIGHTS

- Cab and boom lights with time delay
- Exterior lights integrated into storage box

### UNDERCARRIAGE/UPPERFRAME

- Grease Lubricated Track with PPR2 GLT4, resin seal
- Heavy duty track roller and idler
- Track motor guards
- Towing eye on base frame
- Heavy duty bottom guards on upperframe

### COUNTERWEIGHT

- Counterweight with lifting eyes

### SAFETY AND SECURITY

- Cat one key security system
- Door locks
- Cap locks on fuel and hydraulic tanks
- Lockable external tool/storage box
- Signaling/warning horn
- Secondary engine shutoff switch
- Mirrors
- Rear window for emergency exit
- Rear vision camera
- Capability to connect a beacon
- Bolt on FOGS capability
- Service walkways

### INTEGRATED TECHNOLOGIES

- Product Link
- Rear vision camera



## Optional Equipment

Optional equipment may vary. Consult your Cat dealer for details.

### FRONT LINKAGE

- Reach boom 10.0 m (32'10") (with or without BLCV/SLCV):
  - R5.5HB2 (18'1") (with or without CGC)
  - R4.4HB2 (14'5") (with or without CGC)
  - HB2 – family bucket linkage (with or without lifting eye)
- General Purpose boom 8.4 m (27'7") (with or without BLCV/SLCV):
  - R5.5HB2 (18'1") (with or without CGC)
  - R4.4HB2 (14'5") (with or without CGC)
  - G3.4JC (11'2")
  - JC – family bucket linkage (with or without lifting eye)
- Mass boom 7.25 m (23'9") (with or without BLCV/SLCV):
  - M3.4JC (11'2")
  - M2.92JC (9'7")
  - JC – family bucket linkage (with or without lifting eye)

### TRACK

- Double grouser, Heavy Duty, 650 mm (26")
- Double grouser, Heavy Duty, 750 mm (30")
- Double grouser, Heavy Duty, 900 mm (35")

### GUARDS

- FOGS (Falling Object Guard System) including overhead and windshield guards
- TOP guard including overhead guards
- Track guiding guards:
  - Full length, 2 pieces
  - Segmented, 3 pieces
  - Center section

### LIGHTS

- Cab working lights, halogen
- Cab working lights, HID
- Boom working lights, halogen
- Boom working lights, HID

### CAB

- Seat:
  - Adjustable high-back, heated seat with air suspension
  - Adjustable high-back, heated and ventilated seat with air suspension
- Cab front rain protector
- Windshield:
  - 70-30 split, sliding
  - One-piece, fixed
- Straight travel pedal

### HYDRAULICS

- Boom and stick lowering control devices with SmartBoom
- Counterweight removal device
- HP hydraulic lines for boom and stick
- MP hydraulic lines for boom and stick
- QC hydraulic lines for boom and stick
- Universal QC control

### ELECTRIC

- Cold weather starting package, 240V
- Travel alarm
- Electric refueling pump

### INTEGRATED TECHNOLOGIES

- Cat Grade Control

### ENGINE

- Quick drains, engine and hydraulic oil (QuickEvac)
- Fast fill port for fuel





For more complete information on Cat products, dealer services, and industry solutions, visit us on the web at [www.cat.com](http://www.cat.com)

AEHQ7321-04 (11-2017)  
Replaces AEHQ7321-03

© 2017 Caterpillar  
All rights reserved

Materials and specifications are subject to change without notice. Featured machines in photos may include additional equipment. See your Cat dealer for available options.

CAT, CATERPILLAR, SAFETY.CAT.COM, their respective logos, "Caterpillar Yellow" and the "Power Edge" trade dress, as well as corporate and product identity used herein, are trademarks of Caterpillar and may not be used without permission.

VisionLink is a trademark of Trimble Navigation Limited, registered in the United States and in other countries.

