

297C

Multi Terrain Loader



Features

The Cat® 297C Multi Terrain Loader, with its vertical lift design, delivers extended reach and lift height for quick and easy truck loading. Its suspended undercarriage system provides superior traction, flotation and the ability to work in a wide range of underfoot conditions.

The 297C features the following:

Sealed and Pressurized Cab. Provides a cleaner and quieter operating environment.

Seat Mounted Adjustable Joystick Controls and available Air Ride Seat. These features make the C-Series the industry leader in operator comfort.

High Performance Power Train. Provides high engine horsepower and torque. Electronic Torque Management and standard foot throttle allow the machine to be operated at part throttle for lower sound levels and fuel consumption.

High Flow XPS Hydraulic System. Available for applications that demand maximum hydraulic work tool performance.

Undercarriages. Single level and dual level suspension undercarriages are available on the 297C.

Serviceability. Easy routine maintenance helps reduce machine downtime for greater productivity.

Work Tools. Caterpillar's broad range of performance matched work tools make the Cat Multi Terrain Loader the most versatile machine on the jobsite.

CATERPILLAR®

297C Specifications

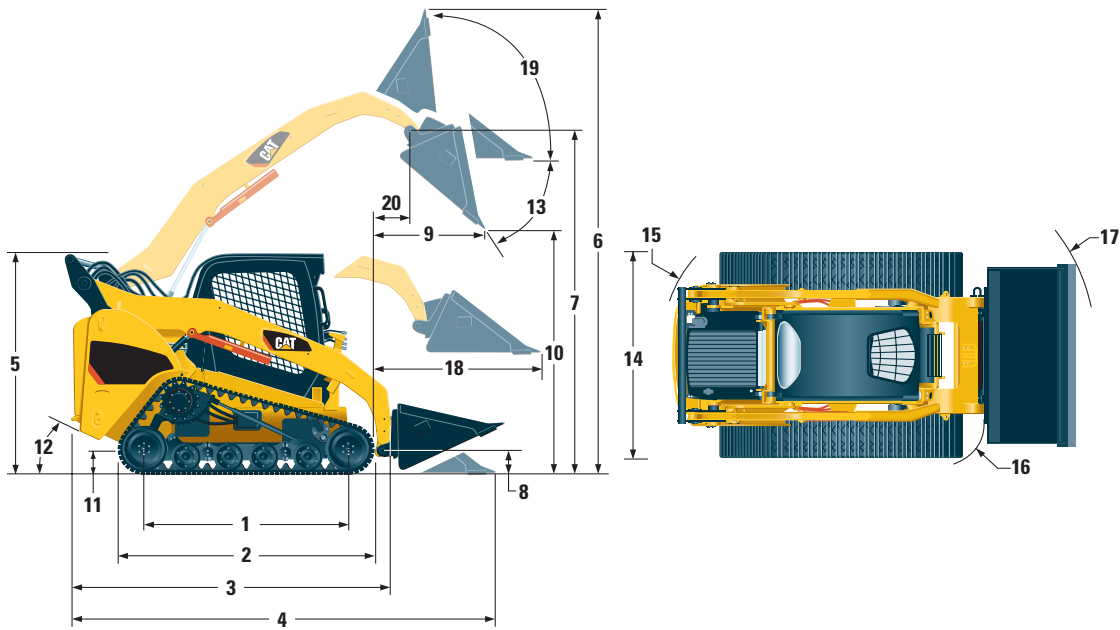

Dimensions

	mm
1 Length of Track on Ground	1808
2 Overall Length of Track	2267
3 Length without Bucket	3265
4 Length with Bucket on Ground	3833
5 Height to Top of Cab	2083
6 Max. Overall Height	4115
7 Bucket Pin Height at Max. Lift	3279
8 Bucket Pin Height at Carry Position	200
9 Reach at Max. Lift and Dump	783
10 Clearance at Max. Lift and Dump	2487
11 Ground Clearance	225
12 Departure Angle	26°
13 Maximum Dump Angle	51°
14 Vehicle Width	1981
15 Turning Radius from Center – Machine Rear	1454
16 Turning Radius from Center – Coupler	1795
17 Turning Radius from Center – Bucket	2634
18 Max. Reach with Arms Parallel to Ground	1288
19 Rack Back Angle at Max. Height	83°
20 Bucket Pin Reach at Max. Lift	391

Engine

Horsepower (hp) are metric

Engine Model	Cat® C3.4 T
Gross Power SAE J1995	70 kW/95 hp
Net Power ISO 9249 at 2600 rpm	68 kW/92 hp
Displacement	3.3 L
Stroke	120 mm
Bore	94 mm

Weight

Operating Weight	4640 kg
------------------	---------

Power Train

Max. Travel Speed (Forward or Reverse):	
One Speed	9 km/h
Two Speed Option	15 km/h

Hydraulic System

Hydraulic Flow – Standard	
Loader Hydraulic Pressure	230 bar
Loader Hydraulic Flow	84 L/min
Hydraulic Power	32 kW/43 hp
Hydraulic Flow – High Flow XPS	
Max. Loader Hydraulic Pressure	280 bar
Max. Loader Hydraulic Flow	125 L/min

Operating Specifications

Rated Operating Capacity	
35% Tipping Load	1344 kg
50% Tipping Load	1920 kg
with Optional Counterweight	2028 kg
Tipping Load	3841 kg
Breakout Force	33 kN
Ground Contact Area	1.64 m ²
Ground Pressure	0.28 bar

Cab

ROPS	ISO 3471:1994
FOPS	ISO 3449:1992 Level I and II

Service Refill Capacities

	Liter
Cooling System	14
Engine Crankcase	10
Fuel Tank	98
Hydraulic System	57
Hydraulic Tank	42

297C Multi Terrain Loader

Work Tools

- Augers
- Angle Blades
- Brooms
- Cold Planers
- Forks & Carriages
- Landscape Tillers
- Material Handling Arms
- Stump Grinders
- Mulchers
- Trenchers
- Snow Blowers
- Vibratory Compactors
- Wheel Saws
- Dozer Blades

Standard Equipment

Electrical

- Electrical System, 12 V
- Alternator, 90 A
- Ignition Key Start/Stop Switch
- Lights: *Gauge Backlighting, Two Rear Tail Lights, Two Rear Working Lights, Two Adjustable Front Halogen Lights, Dome Light*
- Backup Alarm
- Heavy Duty Battery, 850 CCA

Operator Environment

- Gauges: *Fuel Level, Hour Meter*
- Operator Warning System Indicators: *Air Filter Restriction, Alternator Output, Armrest Raised/Operator Out of Seat, Engine Coolant Temperature, Engine Oil Pressure, Glow Plug Activation, Hydraulic Filter Restriction, Hydraulic Oil Temperature, Park Brake Engages*
- Vinyl Seat
- Fold in Ergonomic Contoured Armrest
- Control Interlock System, when operator leaves seat or armrest raised: *Hydraulic System Disables, Hydrostatic Transmission Disables, Parking Brake Engages*
- ROPS Cab, Open, Tilt Up
- FOPS, Level I
- Top and Rear Windows
- Headliner, Deluxe
- Floor Mat
- Interior Rear View Mirror
- 12 volt Electric Socket
- Horn

Mandatory Equipment

- Hydraulics, Standard or High Flow XPS
- Quick Coupler, Mechanical or Hydraulic
- Seat Belt, 50 mm or 75 mm
- EU Preparation Package

Comfort Package (select one of the following):

- Open ROPS (C1): *Cup Holder, Radio Ready, Suspension Seat, (no Heater or Door)*
- Enclosed ROPS with Heater (C2): *Cup Holder, Radio Ready, Seat (choice of Suspension or Air Ride), Heater and Defroster, Side Windows, Door (either Glass or Polycarbonate)*
- Enclosed ROPS with A/C (C3): *C2 and Air Conditioner*

Performance Package (select one of the following):

- Performance Package 1: *Single Level Suspension Undercarriage, One Speed*
- Performance Package 2: *Dual Level Suspension Undercarriage, One Speed, Self Level*
- Performance Package 3: *Dual Level Suspension Undercarriage, Two Speed, Self Level, Advanced Machine Information and Control System (AMICS)*

Power Train

- Cat® C3.4 T Stage IIIA Compliant Diesel Engine
- Air Cleaner, Dual Element, Radial Seal
- S•O•SSM Sampling Valves, Engine Oil and Hydraulic Oil
- Filters, Spin-on, Hydraulic
- Filters, Bayonet-type, Fuel and Water Separator
- Tilt Up Radiator/Hydraulic Oil Cooler
- Spring Applied, Hydraulically Released, Wet Multi Disc Parking Brakes
- Hydrostatic Transmission

Other

- Engine Enclosure, Lockable
- Extended Life Antifreeze, -37°C
- Machine Tie Down Points (4)
- Support, Lift Arm
- Hydraulic Oil Level Sight Gauge
- Radiator Coolant Level Sight Gauge
- Radiator, Expansion Bottle
- Caterpillar XT™ ToughGuard™ Hose
- Auxiliary, Hydraulics, Continuous Flow
- Heavy Duty, Flat Faced Quick Disconnects
- Split D-Ring to Route Work Tool Hoses Along Side of Left Lift Arm
- Electrical Outlet, Beacon
- Belly Pan Cleanout

Optional Attachments

- Counterweight, increases rated operating capacity 90 kg
- Beacon, Rotating
- Engine Block Heater – 120 V or 240 V
- Oil, Hydraulic, Cold Operation
- Paint, Custom

297C Multi Terrain Loader

For more complete information on Cat products, dealer services, and industry solutions, visit us on the web at www.cat.com

HEHL3591-1 (07/2008) hr

© 2007 Caterpillar -- All Rights Reserved

Materials and specifications are subject to change without notice. Featured machines in photos may include additional equipment. See your Caterpillar dealer for available options.

CAT, CATERPILLAR, their respective logos, "Caterpillar Yellow" and the POWER EDGE™ trade dress, as well as corporate and product identity used herein, are trademarks of Caterpillar and may not be used without permission.

CATERPILLAR®
TODAY'S WORK. TOMORROW'S WORLD.™