

# 385C L

## Hydraulic Excavator



### Engine

Engine Model	Caterpillar® C18 ATAAC	
Net Flywheel Power	382 kW	513 hp

### Weights

Operating Weight – Long Undercarriage	84 980 kg	187,360 lb
------------------------------------------	-----------	------------

- General Purpose Boom, R4.4 (14'5") stick, 1678 mm (66") Bucket, and 900 mm (36") shoes.

### Drive

Maximum Travel Speed	4.4 kph	2.8 mph
Maximum Drawbar Pull – Long Undercarriage	592 kN	133,090 lb

# 385C L Hydraulic Excavator

*High performance and rugged durability combine to maximize your productivity.*

---

## Engine

- ✓ The Cat® C18 engine has state-of-the-art ACERT® technology to meet U.S. EPA Tier 3 emission regulations, with exceptional performance capabilities and proven reliability. **pg. 4**

---

## Hydraulics

- ✓ Proportional Priority Pressure Compensated (PPPC) system with state-of-the-art electronic control ensures hydraulic system efficiency and excellent productivity. **pg. 5**

---

## Operator Station

- ✓ An all-new cab provides improved visibility and comfort. The new monitor is a full-color graphical display with enhanced functionality to provide simple, comprehensive machine interface. **pg. 6**

---

## Front Linkage

Caterpillar excavator booms and sticks are built for performance and long service life. Two types of booms and six lengths of sticks are available, offering a range of configurations suitable for a wide variety of applications. All booms and sticks are stress relieved. **pg. 11**

---

## Buckets

A wide variety of bucket types, aggressive bucket designs and larger capacity bucket options take advantage of the powerful digging forces and stable base this is offered with the 385C L. **pg. 12**

*High level of sustained production, higher deep trenching and pipe-laying performance, improved reliability and durability increase your productivity and lower your operating costs.*





---

### Electronic Control System

Engine and machine Electronic Control Modules maximize fuel efficiency and performance by maintaining the optimum balance between engine speed and hydraulic demand. **pg. 8**

---

### Undercarriage

Cat designed excavator undercarriage is stable, durable and low maintenance. The undercarriage is a long, variable gauge type for good machine stability and transportability. New grease-lubricated track provides longer life and quieter operation. **pg. 9**

---

### Structures

Caterpillar design and manufacturing techniques assure outstanding durability and service life from these important components. The 385C L upper frame main channels are box section, connected by a large diameter tube in the boom foot area for strength and rigidity. **pg. 10**

---

### Service and Maintenance

Fast, easy service has been designed in with extended service intervals, advanced filtration, convenient filter access and user-friendly electronic diagnostics for increased productivity and reduced maintenance costs. **pg. 13**

---

### Complete Customer Support

Your Cat dealer offers a wide range of services that can be set up under a customer support agreement when you purchase your equipment. The dealer will help you choose a plan that can cover everything from machine configuration to eventual replacement. **pg. 14**



✓ *New Feature*

## Engine

*A combination of innovations working at the point of combustion, ACERT technology optimizes engine performance while meeting EPA Tier 3 emission regulations.*



**Diesel Engine.** The Caterpillar C18, with ACERT technology, is a 18.1 liter, six-cylinder, 382 kW (513 hp) engine with mechanically actuated electronic fuel injection (MEUI) and overhead camshaft. ACERT technology provides outstanding engine performance through advanced electronic control, precision fuel delivery, and refined air management.

**Fuel Consumption.** The Advanced Diesel Engine Management (A4) controller uses sensors throughout the engine to manage engine load and performance. The A4 controller is the muscle behind engine responsiveness, self-diagnostics, controlling emissions, and fuel economy.

**Fuel System.** C18 engine uses a mechanically actuated electrically controlled unit injection (MEUI) system. The MEUI system combines high-pressure injection and electronic control in a single compact unit. The electronic unit injector is an integral part of the C18 fuel system. Computerized electronic control provides precise metering and timing of fuel injection.

**Cooling System.** High capacity, side-by-side cooling system allows operation in ambient temperatures up to 52 degree C (126 degree F). The Electric Power Control (EPC) controls the fan speed based on coolant temperature and hydraulic oil temperature for optimized cooling.

**Turbocharger.** The C18 engine uses a water-cooled, center-section waste gated turbocharger for improved performance. This turbocharger controls the air volume to the cylinders and works efficiently during low and high load conditions.



**Emissions.** ACERT Technology is a differentiated technology that reduces emissions at the point of combustion. The technology capitalizes on Caterpillar's proven leadership in three core engine systems: fuel, air and electronics.

**Cold Weather Starting Kit.** The kit consists of two additional batteries, heavy-duty harness, large capacity starting motor, and the ether starting aid. With this kit, the 385C L has the capability to start at -32 degree C (-25.6 degree F).

## Hydraulics

*Cat hydraulics deliver power and precise control to keep material moving.*

**PPPC Hydraulics.** Load sensing, Proportional Priority Pressure Compensation (PPPC) system, with Caterpillar-developed electronic actuation, provides high efficiency and excellent controllability.

- Cylinder speed is directly related to operator's movement of joystick from feathering to full speed.
- Flow to cylinders during multifunctional operation is directly controlled by the operator and is not dependent on loads.
- Controller reduces pump output to minimum to save power when joysticks are in neutral position.

**Main Pumps.** Large, heavy-duty main pumps and a separate swing pump provide quick cycle times during multi-function operation.

### **Power Management Control.**

The pump-valve electronic controller is central to power management and provides highly efficient control of the pumps, valves, and engine.

### **Reverse Swing Damping Valve.**

Swing dampening valves reduce swing wag and produce smooth swing stops.



**Auxiliary Hydraulic Valve.** The auxiliary valve is standard on the 385C L. The standard auxiliary valve is for use with optional control arrangements to operate tools such as hammers and shears. Flow settings can be programmed for up to four tools, which the operator can select through the monitor.

**Heavy Lift Standard.** The operator can select the heavy lift mode at the push of a button to boost lifting capability and provide improved controllability of heavy loads.



## Operator Station

*Designed for simple, easy operation and comfort, the 385C L allows the operator to focus on production.*



**Cab Design.** The work station has been designed to be spacious, quiet and comfortable. Operator comfort, and a high level of visibility assure productivity throughout the entire workday. The monitor and switches are conveniently located for easy access and visibility.

**Seat.** The 385C L seat provides a variety of adjustments, including fore/aft, height and weight to suit the operator. Also included are adjustable armrests and a retractable seat belt. For additional comfort, a new heated air suspension seat is available as an attachment.

**Hydraulic Activation Control Lever.** The hydraulic activation control lever deactivates hydraulic functions during engine start-up, and prevents unintentional machine operation.

**Climate Control.** Positive filtered ventilation with a pressurized cab comes standard on the 385C L. Fresh air or re-circulated air can be selected, and the automatic climate control maintains constant, comfortable temperature.

**Windows.** To maximize visibility, all glass is affixed directly to the cab eliminating the use of window frames. The upper front windshield opens, closes and stores on the roof above the operator with a one-touch action release system. The lower front windshield features a rounded design to maximize downward visibility and improves wiper coverage.

**Wipers.** Pillar-mounted parallelogram wiper, including a washer nozzle, increases the operator's viewing area and offers continuous and intermittent modes.

**Skylight.** An enlarged skylight with sunshade provides excellent visibility and good ventilation.



**Consoles.** Redesigned consoles feature a simple, functional design to reduce operator fatigue, ease of switch operation and excellent visibility. Both consoles have attached armrests and allow the height of the armrests to be adjusted.

**Monitor.** The compact, full-color, graphical display monitor is new with the 385C L. The monitor has functions to display machine, maintenance, diagnostic and prognostic information. The angle of the monitor can be adjusted to face the operator and prevent sun glare.

**Cab Mounts.** The cab shell is attached to the frame with viscous rubber cab mounts, which dampen vibrations and sound levels while enhancing operator comfort.

**Standard Cab Equipment.** To enhance operator comfort and productivity, the 385C L cab includes a lighter, drink holder, coat hook, service meter, literature holder, magazine rack and storage compartment. The cab also comes equipped with two, 12V-7 Amp electrical sockets to provide additional electrical resources.

**Machine Security.** An optional Machine Security System (MSS) is available from the factory on the 385C L. MSS uses a special Caterpillar key with an embedded electronic chip for controlling unauthorized machine operation.

**Product Link.** The 385C L is "Product Link Ready" from the factory.

## Electronic Control System

*Manages the engine and hydraulics for maximum performance.*



**Monitor Display Screen.** The monitor is a full color 400 × 234 pixels Liquid Crystal Display (LCD) graphic display.

The Master Caution Lamp the action lamp blinks ON and OFF when one of the critical conditions below occurs:

- Engine oil pressure low
- Coolant temperature high
- Hydraulic oil temperature high

Under the normal condition or the default condition, the monitor display screen is divided into four areas; clock and throttle dial area, gauge area, event display area and multi-information display area.

### **Clock and Throttle Dial Display.**

The clock, throttle dial and gas-station icon with green color are displayed in the area.

**Gauge Display.** Three analog gauges, fuel level, hydraulic oil temperature and coolant temperature, are displayed in the this area.

**Event Display.** Machine event information is displayed in the area along with the icon and language.

**Operator Gain/Response.** Used to suit the operators preference or application.

- Quicker, for fast response and more production
- Slower, for more precision
- Three preset settings with 21 available

**Pattern Control Changer.** The standard hand control pattern changer can be accessed through the monitor, to utilize either the standard excavator control pattern (SAE) or Backhoe-loader pattern (BHL).

**Electronic Joysticks.** Electronic joysticks provide features not possible with hydraulic pilot valves:

- Eliminate pilot lines in cab for quieter operation
- Simple pattern change through the monitor



## Undercarriage

*Durable undercarriage absorbs stresses and provides excellent stability.*



### **Undercarriage Components.**

Large, Caterpillar designed and built undercarriage components offer heavy-duty performance and durability.

**Track Rollers.** Heavy-duty track rollers, carrier rollers and idlers are sealed and lubricated for excellent service life.

### **Idler Guards and Track Guides.**

Standard idler guards and center track guides maintain track alignment. Additional sprocket and idler end guards, as well as two-piece full-length guards are optional for additional protection on steep side slopes.

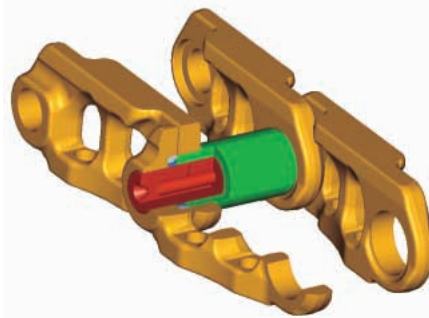

**Track.** The 385C L comes standard with the new grease lubricated track called GLT4. The track links are assembled and sealed with grease to decrease internal bushing wear, reduce travel noise and extend service life lowering operating costs.

**Travel Motor.** Two-speed axial piston hydraulic motors provide the 385C L drive power and automatic speed selection when the high-speed position is selected. This enables the machine to automatically change between computer-controlled high and low speeds depending on drawbar-pull requirements.

**Final Drives.** The final drives are the three-stage reduction planetary types. This design results in a complete drive/brake unit that is compact and delivers excellent performance and reliability.

## Structures

*The 385C L structural components are the backbone of the machine's durability.*

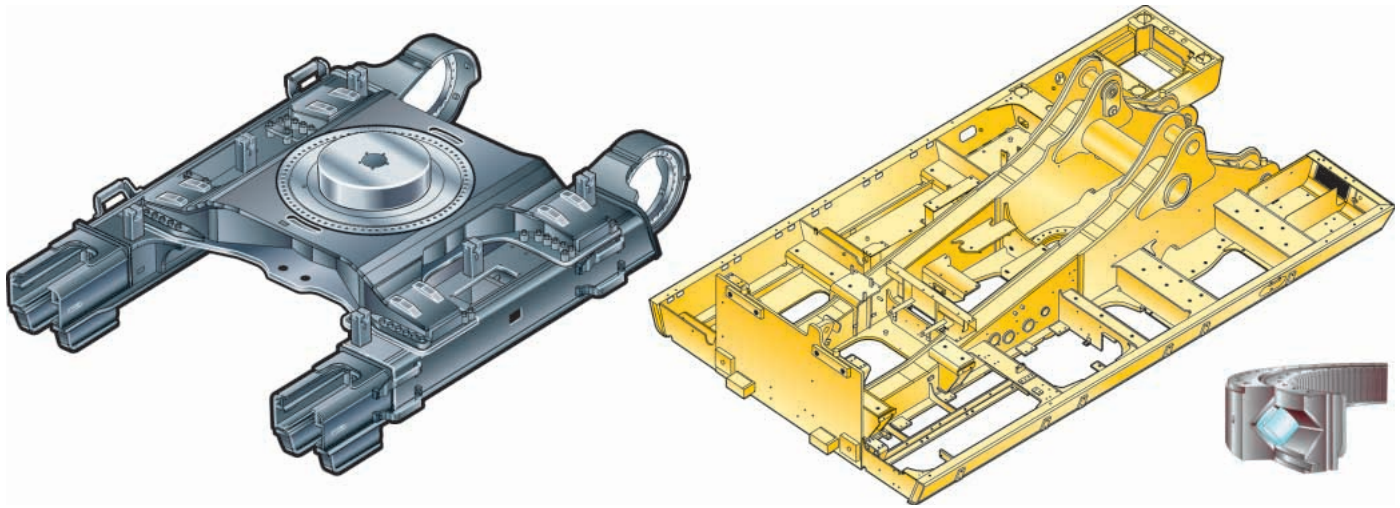

**Carbody Design.** The advanced carbody design stands up to the toughest applications.

- Modified X-shaped, box-section carbody provides excellent resistance to torsional bending.
- Upper structure weight and stresses are distributed evenly across the full length of the track roller frame.
- Robot welding ensures consistent, high-quality welds throughout the manufacturing process.

**Upper Frame.** Rugged main frame is designed for maximum durability and efficient use of materials.

- Robot welding for consistent, high-quality welds.
- Outer frame utilizes curved side rails, which are die-formed, for excellent uniformity and strength throughout the length.
- The main channels are box sections connected by a large diameter tube in the boom foot area to improve rigidity and strength.

**Track Roller Frames.** The track roller frame is made of thick steel plate that is bent into a U-shape and welded to the bottom plate to create a box structure. The box structure design provides increased rigidity and impact resistance.

**Cross-roller Bearing.** The 385C L swing bearing is a cross roller type, with greater contact area than ball type bearings, for increased stability and longer life.

**Variable Gauge Undercarriage.**

The long variable gauge undercarriage is standard. The track roller frames are bolted to the carbody, and can be placed in two positions – wide, for a stable base for operating, or a narrow gauge for reduced shipping width.

## Front Linkage

*Caterpillar excavator booms and sticks are built for performance and long service life. Two types of booms and six lengths of sticks are available, offering a range of configurations suitable for a wide variety of applications. All booms and sticks are stress relieved.*

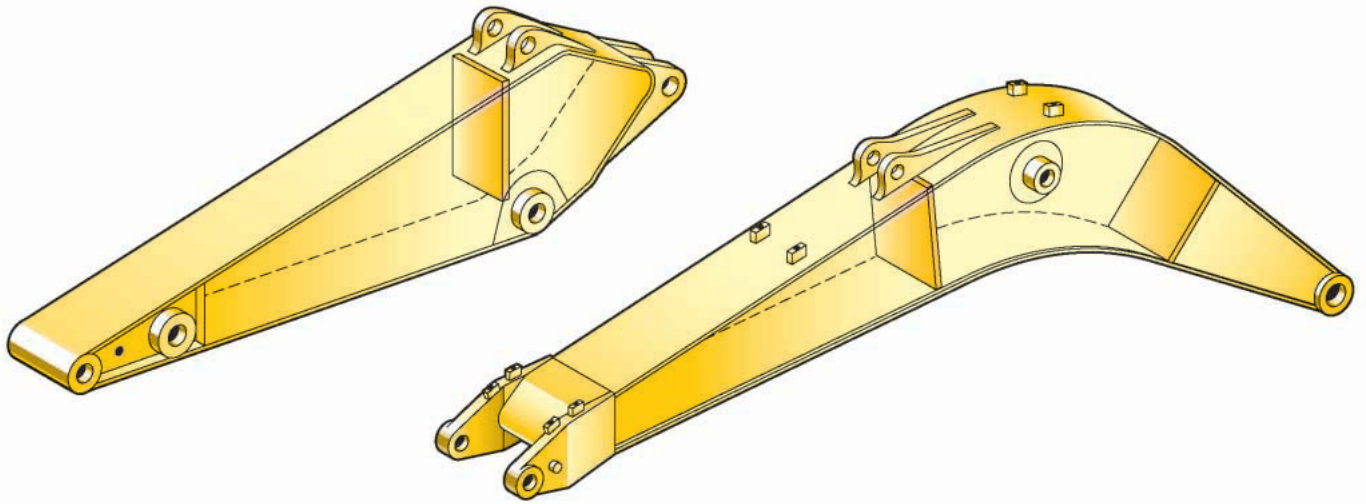

**Front Linkage Attachments.** Select the right combination of front linkage with your Cat dealer to ensure high productivity from the very start of your job. Three types of booms and six sticks are available, offering a range of configurations suitable for a wide variety of applications. The 385C L offers a large combination of reach and digging forces for optimum versatility.

**Boom Construction.** All 385C L booms have large cross-sections and internal baffle plates to provide higher rigidity and less stress. All booms are stress relieved for extended life.

**Reach Boom.** The 10.0 m (32 ft 10 in) Reach Boom is for use in deep trenching applications where long reach and depth are necessary. Two long sticks are available for this boom.

**General Purpose Boom.** The 8.4 m (27 ft 7 in) GP Boom has been designed to balance the reach, digging force and bucket capacity required for a wide range of applications. Four sticks are available for use with the GP boom.

**Mass Excavation Boom.** The 7.25 m (23 ft 9 in) Mass Excavation Boom is most suitable for high production loading where reach and depth are less important. It allows use of the largest buckets. Two sticks are available for this boom.

**Stick Construction.** The 385C L sticks are made of high-tensile strength steel using a large box section design with interior baffle plates and an additional bottom guard to protect against damage. All sticks undergo a stress relieving process for greater durability.

**Sticks.** There are six sticks for maximum versatility in reach, digging forces, and bucket capacity requirements of various applications. Each stick is designed for use in combination with a specific boom and bucket family.

**Bucket Linkage.** Two bucket linkages are available for the 385C L. Both linkages are available with or without a lifting eye on the power link.

- The HB linkage is used with the longer sticks and HB family buckets.
- The JB linkage is used with shorter sticks and JB family buckets.

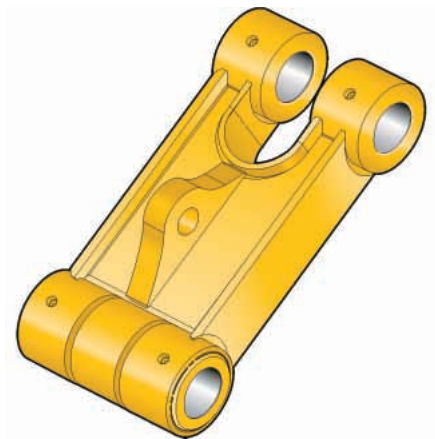

**Power Link.** The new 385C L power link improves durability, increases machine-lifting capability in key lifting positions, and is easier to use compared to the previous lift bar design.

**Linkage Pins.** All pins used in 385C L front linkages have thick chrome plating, giving them high wear and corrosion resistance. The large diameter pins smoothly distribute the shear and bending loads to help ensure long pin, boom and stick life.



## Buckets

*Extensive selection of buckets helps optimize machine performance.*



**Service and Performance.** Caterpillar buckets increase service life and optimize performance.

- High strength and heat treated steel are located in high wear areas.
- Dual radius design for increased heel clearance and reduced wear.
- HB and JB-family buckets include a lift eye.
- A variety of exclusive hydraulic dedicated coupler buckets are also available.

**General Purpose (GP).** General Purpose (GP) buckets are for digging in soft to hard ground with low to moderate abrasive materials.

**Heavy Duty Rock (HDR).** Heavy Duty Rock (HDR) buckets are for aggressive bucket loading in highly abrasive applications such as shot rock and granite. Differences from GP buckets are:

- More robust construction for improved life and durability
- Additional, thicker bottom wear strips for improved wear in abrasive applications
- Larger, thicker side plates for maximum protection in rocky materials
- Smaller tip radius for greater breakout force



**Ground Engaging Tools.** Caterpillar Ground Engaging Tools (GET) include a variety of side cutters, sidebar protectors, and tip options to match operating conditions.

## Service and Maintenance

*Fast, easy service has been designed in with extended service intervals, advanced filtration, convenient filter access and user-friendly electronic diagnostics for increased productivity and reduced maintenance costs.*

**Service Intervals.** Service intervals are extended to reduce maintenance costs.

- Engine oil, oil filter and fuel filters at 500 hours

### **Oil Sample and Pressure Ports.**

Oil sample and pressure ports provide easy checking of machine condition and are standard on every machine.

**Hydraulic Capsule Filters.** The return filters or capsule filters for the hydraulic system are located beside the hydraulic tank. The filter elements are removable without spilling hydraulic oil.

**Service Points.** Service points are centrally located with easy access to facilitate routine maintenance.

### **Pilot Hydraulic System Filter.**

Pilot hydraulic system filter keeps contaminants from the pilot system and is located in the pump compartment.

**Greasing Points.** A concentrated remote greasing block on the boom delivers grease to hard-to-reach locations.

**Radial Seal Cleaner.** Radial seal main air cleaner with pre-cleaner has a double-layered filter element for more efficient filtration. No tools are required to change the element.

**Fuel-Water Separator.** The water separator removes water from fuel, even when under pressure, and water level can be monitored in the cab.



## Complete Customer Support

*Cat dealer services help you operate longer with lower costs.*



**Product Support.** You will find nearly all parts at our dealer parts counter. Cat dealers utilize a worldwide computer network to find in-stock parts to minimize machine downtime. You can save money with Cat remanufactured components.

**Machine Selection.** Make detailed comparisons of the machines you are considering before you buy. What are the job requirements, machine attachments and operating hours? What production is needed? Your Cat dealer can provide recommendations.

**Purchase.** Look past initial price.

Consider the financing options available as well as day-to-day operating costs. This is also the time to look at dealer services that can be included in the cost of the machine to yield lower equipment owning and operating costs over the long run.

**Customer Support Agreements.**

Cat dealers offer a variety of product support agreements, and work with customers to develop a plan the best meets specific needs. These plans can cover the entire machine, including attachments, to help protect the customer's investment.

**Operation.** Improving operating techniques can boost your profits.

Your cat dealer has videotapes, literature and other ideas to help you increase productivity, and Caterpillar offers certified operator training classes to help maximize the return on your investment.

**Maintenance Services.** Repair option programs guarantee the cost of repairs up front. Diagnostic programs such as Scheduled Oil Sampling, Coolant Sampling and Technical Analysis help you avoid unscheduled repairs.

**Replacement.** Repair, rebuild or replace? Your Cat dealer can help you evaluate the cost involved so you can make the right choice.

**SAFETY.CAT.COM™.**



## Engine

Engine Model	Caterpillar C18 ATAAC	
Net Flywheel Power	382 kW	513 hp
ISO 9249	382 kW	513 hp
SAE J1349	382 kW	513 hp
EEC 80/1269	382 kW	513 hp
Bore	145 mm	5.71 in
Stroke	171 mm	7.2 in
Displacement	18.1 L	1,106 in <sup>3</sup>

- The 385C L meets worldwide Tier 3 emission requirements.
- Net power advertised is the power available at the flywheel when the engine is equipped with fan, air cleaner, muffler and alternator.
- No engine power derating required below 2300 m (7,500 ft) altitude.

## Weights

Operating Weight – Long Undercarriage	84 980 kg	187,360 lb
---------------------------------------	-----------	------------

- General Purpose Boom, R4.4 (14'5") stick, 1678 mm (66") Bucket, and 900 mm (36") shoes.

## Track

Standard w/Long Undercarriage	900 mm	36 in
Optional for Long Undercarriage	750 mm	30 in
Number of Shoes Each Side – Long Undercarriage	51	
Number of Track Rollers Each Side – Long Undercarriage	9	
Number of Carrier Rollers Each Side	3	

## Swing Mechanism

Swing Speed	6.5 RPM	
Swing Torque	260 kN•m	191,914 lb ft

## Drive

Maximum Travel Speed	4.4 kph	2.8 mph
Maximum Drawbar Pull – Long Undercarriage	592 kN	133,090 lb

## Hydraulic System

Main System – Maximum Flow (Total)	980 L/min	259 gal/min
Swing System – Maximum Flow	450 L/min	119 gal/min
Maximum Pressure – Equipment – Normal	32 000 kPa	4,640 psi
Maximum Pressure – Equipment – Heavy Lift	35 000 kPa	5,080 psi
Maximum Pressure – Travel	35 000 kPa	5,080 psi
Maximum Pressure – Swing	26 000 kPa	3,770 psi
Pilot System – Maximum Flow	90 L/min	24 gal/min
Pilot System – Maximum Pressure	4120 kPa	600 psi
Boom Cylinder – Bore	210 mm	8.27 in
Boom Cylinder – Stroke	1967 mm	77.4 in
Stick Cylinder – Bore	220 mm	8.66 in
Stick Cylinder – Stroke	2262 mm	89.1 in
HB Family Bucket Cylinder – Bore	200 mm	7.87 in
HB Family Bucket Cylinder – Stroke	1451 mm	57.1 in
JB Family Bucket Cylinder – Bore	220 mm	8.66 in
JB Family Bucket Cylinder – Stroke	1586 mm	62.4 in

## Service Refill Capacities

Fuel Tank Capacity	1240 L	327.6 gal
Cooling System	101 L	26.7 gal
Engine Oil	65 L	17.2 gal
Swing Drive (each)	19 L	5 gal
Final Drive (each)	21 L	5.6 gal
Hydraulic System (including tank)	995 L	263 gal
Hydraulic Tank	810 L	214 gal



# Dimensions

All dimensions are approximate.

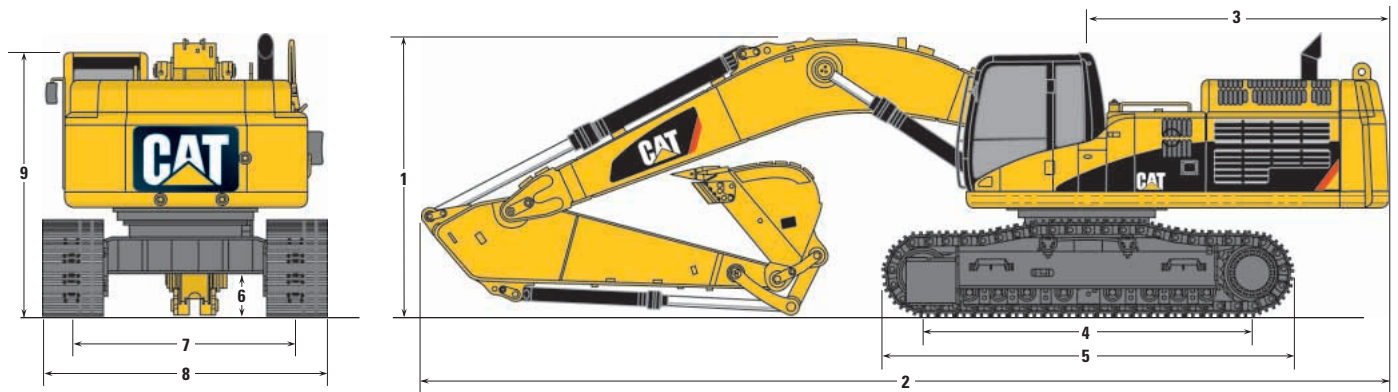

Stick	Reach Boom 10.0 m (32'10")		General Purpose Boom 8.4 m (27'7")				Mass Boom 7.25 m (23'9")	
	5.5 m (18'1")	4.4 m (14'5")	5.5 m (18'1")	4.4 m (14'5")	3.4 m (11'2")	2.92 m (9'7")	3.4 m (11'2")	2.92 m (9'7")
<b>1</b> Shipping Height								
With boom, stick and bucket	5320 mm (17'5")	4960 mm (16'3")	5870 mm (19'3")	5250 mm (17'3")	5060 mm (16'7")	4890 mm (16'1")	4970 mm (16'4")	4800 mm (15'9")
Without stick and bucket	4020 mm (13'2")	4020 mm (13'2")	3760 mm (12'4")	3760 mm (12'4")	3760 mm (12'4")	3760 mm (12'4")	3870 mm (12'8")	3870 mm (12'8")
<b>2</b> Shipping Length								
With boom, stick and bucket	16 230 mm (53'3")	16 290 mm (53'5")	14 420 mm (47'4")	14 660 mm (48'1")	14 220 mm (46'8")	14 750 mm (48'5")	13 520 mm (44'4")	13 510 mm (44'4")
Without stick and bucket	14 620 mm (48'0")	14 620 mm (48'0")	12 950 mm (42'6")	12 950 mm (42'6")	12 950 mm (42'6")	12 950 mm (42'6")	11 750 mm (38'7")	11 750 mm (38'7")
<b>3</b> Tail Swing Radius	4590 mm (15'1")	4590 mm (15'1")	4590 mm (15'1")	4590 mm (15'1")	4590 mm (15'1")	4590 mm (15'1")	4590 mm (15'1")	4590 mm (15'1")
<b>4</b> Length to Center of Rollers*	5120 mm (16'10")	5120 mm (16'10")	5120 mm (16'10")	5120 mm (16'10")	5120 mm (16'10")	5120 mm (16'10")	5120 mm (16'10")	5120 mm (16'10")
<b>5</b> Track Length*	6360 mm (20'10")	6360 mm (20'10")	6360 mm (20'10")	6360 mm (20'10")	6360 mm (20'10")	6360 mm (20'10")	6360 mm (20'10")	6360 mm (20'10")
<b>6</b> Ground Clearance	850 mm (33.5")	850 mm (33.5")	850 mm (33.5")	850 mm (33.5")	850 mm (33.5")	850 mm (33.5")	850 mm (33.5")	850 mm (33.5")
<b>7</b> Track Gauge (Shipping)**								
For 750 mm (30") shoes	2750 mm (9'0")	2750 mm (9'0")	2750 mm (9'0")	2750 mm (9'0")	2750 mm (9'0")	2750 mm (9'0")	2750 mm (9'0")	2750 mm (9'0")
For 900 mm (36") shoes	2940 mm (9'8")	2940 mm (9'8")	2940 mm (9'8")	2940 mm (9'8")	2940 mm (9'8")	2940 mm (9'8")	2940 mm (9'8")	2940 mm (9'8")
<b>8</b> Transport Width								
For 750 mm (30") shoes	3500 mm (11'6")	3500 mm (11'6")	3500 mm (11'6")	3500 mm (11'6")	3500 mm (11'6")	3500 mm (11'6")	3500 mm (11'6")	3500 mm (11'6")
For 900 mm (36") shoes	3840 mm (12'7")	3840 mm (12'7")	3840 mm (12'7")	3840 mm (12'7")	3840 mm (12'7")	3840 mm (12'7")	3840 mm (12'7")	3840 mm (12'7")
<b>9</b> Cab Height	3620 mm (11'11")	3620 mm (11'11")	3620 mm (11'11")	3620 mm (11'11")	3620 mm (11'11")	3620 mm (11'11")	3620 mm (11'11")	3620 mm (11'11")

\* Long Undercarriage

\*\* Track Gauge in extended (working) position: 3510 mm (11'6")



# Working Ranges

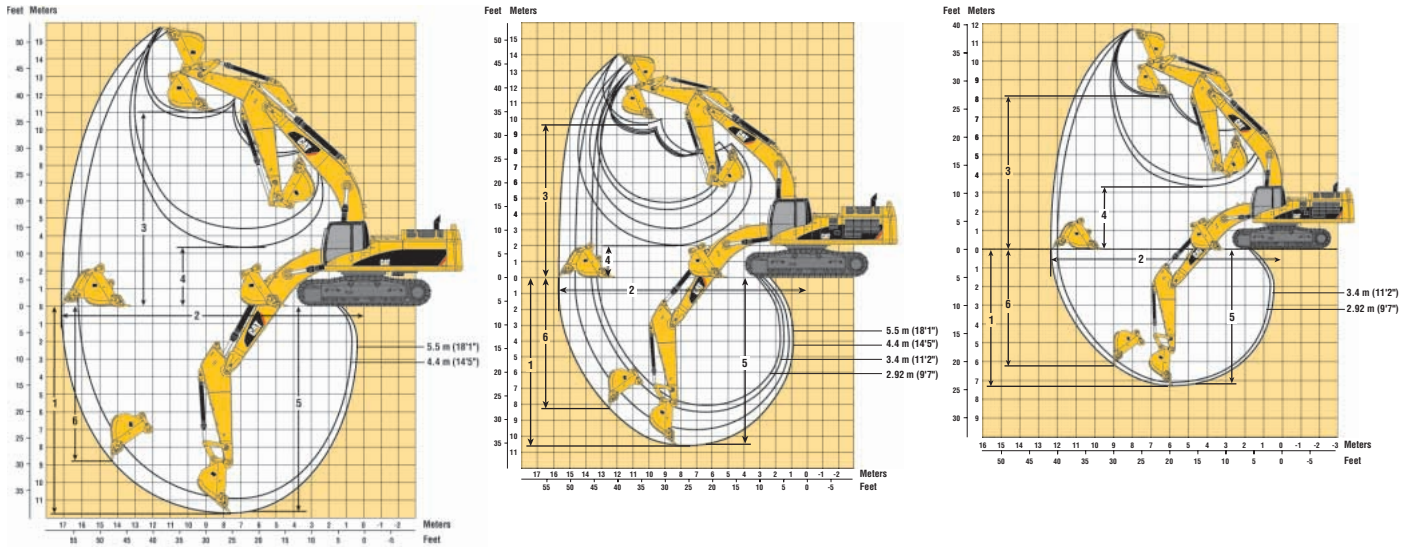

	Reach Boom 10.0 m (32'10")		General Purpose Boom 8.4 m (27'7")				Mass Boom 7.25 m (23'9")	
Stick	5.5 m (18'1")	4.4 m (14'5")	5.5 m (18'1")	4.4 m (14'5")	3.4 m (11'2")	2.92 m (9'7")	3.4 m (11'2")	2.92 m (9'7")
Bucket	GP 2.9 m <sup>3</sup> 3.88 yd <sup>3</sup>	GP 2.9 m <sup>3</sup> 3.88 yd <sup>3</sup>	GP 3.8 m <sup>3</sup> 5.00 yd <sup>3</sup>	GP 3.8 m <sup>3</sup> 5.00 yd <sup>3</sup>	HDR 4.6 m <sup>3</sup> 6.00 yd <sup>3</sup>	HDR 4.6 m <sup>3</sup> 6.00 yd <sup>3</sup>	GP 5.4 m <sup>3</sup> 7.25 yd <sup>3</sup>	GP 5.4 m <sup>3</sup> 7.25 yd <sup>3</sup>
<b>1</b> Maximum Digging Depth	11 750 mm (38'7")	10 650 mm (34'11")	10 700 mm (35'1")	9600 mm (31'6")	8480 mm (27'10")	8000 mm (26'3")	7490 mm (24'7")	7020 mm (23'0")
<b>2</b> Maximum Reach at Ground Level	17 200 mm (56'5")	16 180 mm (53'1")	15 680 mm (51'5")	14 630 mm (48'0")	13 690 mm (44'11")	13 260 mm (43'6")	12 530 mm (41'1")	12 110 mm (39'9")
<b>3</b> Maximum Loading Height	11 000 mm (36'1")	10 580 mm (34'9")	9780 mm (32'1")	9320 mm (30'7")	9300 mm (30'6")	9120 mm (29'11")	8350 mm (27'5")	8180 mm (26'10")
<b>4</b> Minimum Loading Height	3370 mm (11'1")	4470 mm (14'8")	2000 mm (6'7")	3100 mm (10'2")	4230 mm (13'11")	4700 mm (15'5")	3350 mm (11'0")	3830 mm (12'7")
<b>5</b> Maximum Depth Cut for 2240 mm (8') Level Bottom	11 660 mm (38'3")	10 540 mm (34'7")	10 610 mm (34'10")	9490 mm (31'2")	8340 mm (27'4")	7850 mm (25'9")	7360 mm (24'2")	6880 mm (22'7")
<b>6</b> Maximum Vertical Wall Digging Depth	7800 mm (25'7")	8760 mm (28'9")	7600 mm (24'11")	8280 mm (27'2")	7410 mm (24'4")	7060 mm (23'2")	6340 mm (20'10")	6020 mm (19'9")
Bucket Digging Force (SAE)	288 kN (64,700 lb)	287 kN (64,530 lb)	288 kN (64,770 lb)	287 kN (64,530 lb)	401 kN (90,180 lb)	401 kN (90,180 lb)	382 kN (85,960 lb)	382 kN (85,870 lb)
(ISO)	324 kN (72,930 lb)	323 kN (72,660 lb)	324 kN (72,930 lb)	323 kN (72,660 lb)	461 kN (103,570 lb)	460 kN (103,460 lb)	437 kN (98,140 lb)	436 kN (98,040 lb)
Stick Digging Force (SAE)	206 kN (46,400 lb)	246 kN (55,350 lb)	206 kN (46,400 lb)	246 kN (55,350 lb)	297 kN (66,800 lb)	320 kN (71,870 lb)	292 kN (65,540 lb)	313 kN (70,390 lb)
(ISO)	212 kN (47,610 lb)	254 kN (57,020 lb)	212 kN (47,610 lb)	254 kN (57,020 lb)	308 kN (69,190 lb)	332 kN (74,720 lb)	302 kN (67,870 lb)	325 kN (73,160 lb)

## Operating Weight\* and Ground Pressure

Configuration	Track							
	900 mm (36") Shoes				750 mm (30") Shoes			
	Operating Weight		Ground Pressure		Operating Weight		Ground Pressure	
	kg	lb	kPa	psi	kg	lb	kPa	psi
10.0 m (32'10") reach boom 1374 mm (54") GP bucket								
R5.5 m (18'1") stick	86 380	190,430	84.8	12.3	85 230	187,890	100.4	14.6
R4.4 m (14'5") stick	86 060	189,740	84.5	12.2	84 910	187,200	100.0	14.5
8.4 m (27'7") general purpose boom 1678 mm (66") GP bucket								
R5.5 m (18'1") stick	85 290	188,040	83.7	12.1	84 140	185,500	99.1	14.4
R4.4 m (14'5") stick	84 980	187,360	83.4	12.1	83 830	184,820	98.7	14.3
8.4 m (27'7") general purpose boom 2260 mm (89") GP bucket								
G3.4 m (11'2") stick	87 840	193,660	86.2	12.5	86 690	191,120	102.1	14.8
G2.92 m (9'7")	87 680	193,300	86.0	12.5	86 530	190,760	101.9	14.8
7.25 m (23'9") mass boom 2260 mm (89") GP bucket								
M3.4 m (11'2") stick	88 090	194,200	86.4	12.5	86 940	191,660	102.4	14.8
M2.92 m (9'7")	87 950	193,910	86.3	12.5	86 800	191,370	102.2	14.8

\* Operating weight includes full fuel tank and 75 kg (165 lb) operator

## Major Component Weights

	kg	lb
Base machine with counterweight and 900 mm (36") shoes (without front linkage)	67 150	148,000
Two boom cylinders	1656	3700
Counterweight	11 600	25,600
Counterweight Removal Device	734	1600
Boom (includes lines, pins and stick cylinder)		
Reach boom 10.0 m (32'10")	9550	21,100
General Purpose 8.4 m (27'7")	8140	17,900
Mass boom 7.25 m (23'9")	8220	18,100
Stick (includes lines, pins, bucket cylinder and linkage)		
R5.5HB (18'1")	5050	11,100
R4.4HB (14'5")	4740	10,400
G3.4JB (11'2")	4510	9900
G2.92JB (9'7")	4360	9600
M3.4JB (11'2")	5180	11,400
M2.92JB (9'7")	5050	11,100
Track roller frame [includes frame, rollers, idlers, steps, guards, final drive, 900 mm (36") shoes] – each	13 240	29,200

## 385C L Bucket Specifications and Compatibility

	Capacity*		Width		Tip Radius		Weight w/o tips		Teeth Qty	Reach Boom Stick		GP Boom Stick	
	m <sup>3</sup>	yd <sup>3</sup>	mm	in	mm	in	kg	lb		R5.5HB	R4.4HB	R5.5HB	R4.4HB
<b>HB Buckets</b>													
General Purpose	2.1	2.75	1070	42	2372	93.4	2364	5207	3	●	●	●	●
	2.9	3.88	1374	54	2372	93.4	2761	6081	4	○	○	●	●
	3.8	5.00	1678	66	2372	93.4	3085	6795	4	○	○	○	●
	4.6	6.00	1982	78	2372	93.4	3500	7709	5	○	○	○	○
Heavy Duty Rock	2.0	2.63	1070	42	2288	90.1	2551	5619	3	●	●	●	●
	2.7	3.63	1374	54	2288	90.1	3075	6773	4	○	○	●	●
	3.5	4.63	1678	66	2288	90.1	3365	7412	4	○	○	○	●
	4.3	5.63	1982	78	2288	90.1	3887	8562	5	○	○	○	○

	Capacity*		Width		Tip Radius		Weight w/o tips		Teeth Qty	GP Boom Stick		Mass Boom Stick	
	m <sup>3</sup>	yd <sup>3</sup>	mm	in	mm	in	kg	lb		G3.4JB	G2.9JB	M3.4JB	M2.9JB
<b>JB Buckets</b>													
General Purpose	5.4	7.25	2260	89	2350	92.5	5754	12,674	6	○	○	○	●
	5.8	7.75	2390	94	2350	92.5	5893	12,980	6	○	○	○	○
Heavy Duty Rock	4.5	6.00	2260	89	2240	88.2	5458	12,022	6	○	○	●	●
Heavy Duty Rock V-edge	4.7	6.25	2260	89	2377	93.6	5651	12,447	6	○	○	●	●

Assumptions for maximum material density rating

1. Front linkage fully extended at ground line
2. Bucket curled
3. 100% bucket fill factor

\* Capacities based on SAE J296. Some calculations of capacity fall on borderlines. Rounding may allow two buckets to have the same English rating but different metric ratings.

- 2100 kg/m<sup>3</sup> (3500 lb/yd<sup>3</sup>) max material density
- 1800 kg/m<sup>3</sup> (3000 lb/yd<sup>3</sup>) max material density
- 1500 kg/m<sup>3</sup> (2500 lb/yd<sup>3</sup>) max material density
- 1200 kg/m<sup>3</sup> (2000 lb/yd<sup>3</sup>) max material density
- 900 kg/m<sup>3</sup> (1500 lb/yd<sup>3</sup>) max material density
- Not recommended



# Reach Boom Lift Capacities



Load Point Height



Load at Maximum Reach



Load Radius Over Front



Load Radius Over Side

**BOOM** – 10 m (32'10")  
**STICK** – 5500 mm (18'1")

**BUCKET** – 1374 mm (54") GP with HD long tips  
**SHOES** – 900 mm (36") double grouser

**UNDERCARRIAGE** – Long  
**HEAVY LIFT** – On

		6.0 m/20.0 ft		7.5 m/25.0 ft		9.0 m/30.0 ft		10.5 m/35.0 ft		12.0 m/40.0 ft		13.5 m/45.0 ft		15.0 m/50.0 ft				m ft	
13.5 m 45.0 ft	kg lb																*5200 *11,600	*5200 *11,600	13.10 42.30
12.0 m 40.0 ft	kg lb									*8040 *15,600	*8040 *15,600						*4920 *10,900	*4920 *10,900	14.31 46.51
10.5 m 35.0 ft	kg lb									*9730 *20,650	*9730 *20,650						*4780 *10,550	*4780 *10,550	15.24 49.70
9.0 m 30.0 ft	kg lb									*10 250 *22,350	*10 250 *22,350	*8830 *17,750	7780 16,450				*4740 *10,450	*4740 *10,450	15.94 52.10
7.5 m 25.0 ft	kg lb							*11 760 *25,500	*11 760 *25,500	*10 710 *23,250	10 060 21,500	*9900 *21,600	7650 16,250				*4780 *10,500	*4780 *10,500	16.44 53.82
6.0 m 20.0 ft	kg lb					*14 560 *31,450	*14 560 *31,450	*12 670 *27,400	12 600 27,050	*11 300 *24,500	9650 20,650	*10 260 *22,300	7410 15,750	*7680 5600			*4890 *10,750	4420 9800	16.76 54.95
4.5 m 15.0 ft	kg lb	*25 610 *54,950	*25 610 *54,950	*19 640 *42,300	*19 640 *42,300	*16 050 *34,650	15 600 33,600	*13 660 *29,550	11 870 25,500	*11 950 *25,900	9170 19,600	*10 670 *23,150	7100 15,100	*9250 *17,750	5440 11,500		*5080 *11,200	4140 9150	16.93 55.53
3.0 m 10.0 ft	kg lb	*25 180 *62,560	*25 180 *58,250	*21 800 *47,000	19 300 42,650	*17 460 *37,700	14 460 31,150	*14 610 *31,550	11 120 23,900	*12 590 *27,250	8670 18,550	*11 070 *23,950	6780 14,350	9210 19,650	5250 11,100		*5360 *11,800	3980 8800	16.94 55.58
1.5 m 5.0 ft	kg lb	*16 020 *38,400	*16 020 *38,400	*23 390 *50,500	17 790 38,350	*18 600 *40,200	13 460 28,950	*15 400 *33,300	10 440 22,400	*13 120 *28,400	8200 17,550	11 030 23,650	6460 13,750	9010 19,250	5060 10,700		*5730 *12,600	3950 8700	16.80 55.11
Ground Line	kg lb	*15 580 *36,500	*15 580 *36,500	*24 240 *52,400	16 740 36,050	*19 330 *41,800	12 680 27,250	*15 940 *34,450	9870 21,200	13 190 28,300	7800 16,700	10 750 23,000	6190 13,200	8840 18,900	4900 10,400		*6220 *13,700	4040 8900	16.49 54.11
-1.5 m -5.0 ft	kg lb	*18 110 *41,900	*18 110 *41,900	*24 360 *52,700	16 120 34,650	*19 580 *42,350	12 140 26,100	16 010 34,400	9460 20,300	12 870 27,600	7500 16,050	10 530 22,600	5990 12,800				*6870 *15,200	4270 9450	16.02 52.53
-3.0 m -10.0 ft	kg lb	*22 380 *51,500	*22 380 *48,850	*23 800 *51,500	15 830 34,050	*19 310 *41,700	11 850 25,450	15 740 33,800	9210 19,750	12 670 27,200	7310 15,650	10 420 22,350	5890 12,600				*7760 *17,150	4690 10,400	15.36 50.33
-4.5 m -15.0 ft	kg lb	*28 020 *60,650	22 920 49,200	*22 580 *48,800	15 820 34,000	*18 470 *39,850	11 760 25,300	*15 270 *32,850	9130 19,600	12 630 *27,100	7270 15,600	*10 200 *21,450	5910 12,700				*8160 *17,950	5370 11,900	14.50 47.40
-6.0 m -20.0 ft	kg lb	*25 250 *54,500	23 350 50,150	*20 620 *44,400	16 030 34,450	*16 960 *36,400	11 880 25,550	*13 940 *29,800	9220 19,850	*11 230 *23,700	7390 15,900						*7620 *16,700	6460 14,450	13.37 43.59

\* Indicates that the load is limited by hydraulic capacity rather than tipping capacity. Lift capacity ratings are based on SAE standard J1097. Rated loads do not exceed 87% of hydraulic lifting capacity or 75% of tipping capacity.

**BOOM** – 10 m (32'10")  
**STICK** – 4400 mm (14'5")

**BUCKET** – 1374 mm (54") GP with HD long tips  
**SHOES** – 900 mm (36") double grouser

**UNDERCARRIAGE** – Long  
**HEAVY LIFT** – On

		4.5 m/15.0 ft		6.0 m/20.0 ft		7.5 m/25.0 ft		9.0 m/30.0 ft		10.5 m/35.0 ft		12.0 m/40.0 ft		13.5 m/45.0 ft				m ft	
13.5 m 45.0 ft	kg lb																*7050 *15,700	*7050 *15,700	11.69 37.57
12.0 m 40.0 ft	kg lb									*11 670 *23,650	*11 670 *23,650						*6670 *14,800	*6670 *14,800	13.07 42.36
10.5 m 35.0 ft	kg lb									*11 890 *25,950	*11 890 *25,950	*10 330 *19,650	9920 *19,650				*6490 *14,350	*6490 *14,350	14.09 45.90
9.0 m 30.0 ft	kg lb									*12 300 *26,750	*12 300 *26,750	*11 360 *24,800	9920 21,100				*6430 *14,200	6370 *14,200	14.85 48.52
7.5 m 25.0 ft	kg lb							*14 700 *31,800	*14 700 *31,800	*12 980 *28,150	12 750 27,350	*11 730 *25,500	9690 20,650	*10 490 *19,400	7300 15,400		*6480 *14,300	5640 12,550	15.39 50.39
6.0 m 20.0 ft	kg lb			*24 820 *53,150	*24 820 *53,150	*19 340 *41,600	*19 340 *41,600	*16 030 *34,600	*16 030 *34,550	*13 820 *29,900	12 150 26,100	*12 240 *26,550	9340 19,950	*11 080 *24,050	7150 15,150		*6630 *14,600	5150 11,400	15.75 51.60
4.5 m 15.0 ft	kg lb			*27 080 *61,600	*27 080 *60,350	*21 550 *46,400	20 010 43,250	*17 410 *37,550	14 970 32,250	*14 700 *31,800	11 480 24,650	*12 800 *27,700	8920 19,100	*11 380 *24,600	6920 14,700		*6880 *15,150	4830 10,700	15.92 52.23
3.0 m 10.0 ft	kg lb					*23 350 *50,350	18 370 39,650	*18 610 *40,200	13 950 30,050	*15 510 *33,500	10 820 23,250	*13 310 *28,800	8480 18,150	11 230 24,050	6660 14,200		*7230 *15,900	4670 10,300	15.93 52.28
1.5 m 5.0 ft	kg lb					*24 410 *52,750	17 160 37,000	*19 460 *42,050	13 100 28,200	*16 110 *34,800	10 240 22,000	13 490 28,950	8090 17,350	10 970 23,500	6410 13,650		*7710 *17,000	4660 10,250	15.78 51.78
Ground Line	kg lb			*12 660 *29,950	*12 660 *29,950	*24 670 *53,400	16 440 35,400	*19 840 *42,900	12 500 26,900	16 350 35,150	9790 21,000	13 160 28,250	7780 16,650	10 760 23,100	6220 13,300		*8350 *18,400	4800 10,600	15.45 50.69
-1.5 m -5.0 ft	kg lb			*17 640 *40,950	*17 640 *40,950	*24 210 *52,450	16 100 34,650	*19 710 *42,600	12 150 26,100	16 040 34,450	9500 20,400	12 940 27,800	7570 16,250	10 650 22,850	6110 13,050		*9080 *20,050	5130 11,300	14.94 48.99
-3.0 m -10.0 ft	kg lb	*14 820 *33,850	*14 820 *33,850	*24 180 *55,750	23 160 49,700	*23 110 *50,050	16 050 34,500	*19 020 *41,100	12 010 25,800	*15 780 *34,050	9370 20,150	12 850 27,650	7500 16,100				*9090 *20,000	5700 12,600	14.29 46.60
-4.5 m -15.0 ft	kg lb	*21 960 *50,000	*21 960 *50,000	*25 660 *55,600	23 560 50,600	*21 340 *46,100	16 220 34,850	*17 700 *38,150	12 080 25,950	*14 640 *31,400	9420 20,250	*11 560 *25,150	7580 16,300				*8580 *18,850	6640 14,750	13.27 43.38
-6.0 m -20.0 ft	kg lb	*25 980 *56,150	*25 980 *56,150	*22 280 *48,050	*22 280 *48,050	*18 750 *40,300	16 600 35,750	*15 560 *33,300	12 350 26,600	*12 610 *26,650	9660 20,850								

\* Indicates that the load is limited by hydraulic capacity rather than tipping capacity. Lift capacity ratings are based on SAE standard J1097. Rated loads do not exceed 87% of hydraulic lifting capacity or 75% of tipping capacity.

# General Purpose Boom Lift Capacities



Load Point Height



Load at Maximum Reach



Load Radius Over Front



Load Radius Over Side

**BOOM** – 8.4 m (27'7")  
**STICK** – 5500 mm (18'1")

**BUCKET** – 1678 mm (66") GP with HD long tips  
**SHOES** – 900 mm (36") double grouser

**UNDERCARRIAGE** – Long  
**HEAVY LIFT** – On

Load Point Height	4.5 m/15.0 ft		6.0 m/20.0 ft		7.5 m/25.0 ft		9.0 m/30.0 ft		10.5 m/35.0 ft		12.0 m/40.0 ft		13.5 m/45.0 ft		m		
	kg	lb	kg	lb	kg	lb	kg	lb	kg	lb	kg	lb	kg	lb	kg	lb	
12.0 m 40.0 ft									*5670	*5670					*4010	*4010	12.41
															*8950	*8950	40.19
10.5 m 35.0 ft									*18,250	*18,250					*3740	*3740	13.50
															*8300	*8300	43.96
9.0 m 30.0 ft											*7520	*7520			*3620	*3620	14.30
											*14,650	*14,650			*8000	*8000	46.71
7.5 m 25.0 ft									*11 090	*11 090	*9430	*9430			*3590	*3590	14.87
									*24,000	*24,000	*19,600	*19,600			*7900	*7900	48.67
6.0 m 20.0 ft									*12 690	*12 690	*10 980	9980	*6250	*6250	*3660	*3660	15.24
									*27,450	*27,450	*23,200	21,250			*8050	*8050	49.95
4.5 m 15.0 ft					*18 880	*18 880	*16 170	*16 170	*14 300	12 640	*12 710	9670	*8090	7410	*3800	*3800	15.43
					*40,750	*40,750	*35,000	*35,000	*31,000	27,100	*26,900	20,650	*15,150	*15,150	*8350	*8350	50.60
3.0 m 10.0 ft			*27 750	*27 750	*21 620	21 610	*17 890	15 890	*15 400	12 070	*13 610	9320	*9300	7220	*4040	*4040	15.44
			*59,750	*59,750	*46,650	46,500	*38,700	34,150	*33,400	25,900	*29,550	19,500	*17,850	15,350	*8900	*8900	50.64
1.5 m 5.0 ft			*31 450	28 810	*23 980	20 230	*19 440	15 030	*16 410	11 520	*14 220	8970	*9910	7010	*4380	*4380	15.28
			*67,900	62,000	*51,800	43,550	*42,050	32,300	*35,550	24,700	*30,800	19,150	*18,750	14,950	*9650	*9650	50.13
Ground Line	*17 030	*17 030	*33 660	27 160	*25 630	19 150	*20 580	14 310	*17 150	11 040	14 050	8660	*9450	6840	*4850	*4850	14.94
	*39,250	*39,250	*72,750	58,400	*55,400	41,150	*44,500	30,750	*37,100	23,650	30,150	18,500	*16,750	14,600	*10,700	*10,700	49.01
-1.5 m -5.0 ft	*19 830	*19 830	*34 350	26 210	*26 390	18 410	*21 160	13 780	17 260	10 670	13 610	8420			*5500	*5500	14.41
	*45,250	*45,250	*74,350	56,300	*57,100	39,550	*45,750	29,600	37,050	22,900	29,600	18,050			*12,150	*12,150	47.23
-3.0 m -10.0 ft	*24 720	*24 720	*33 690	25 780	*26 200	18 010	*21 050	13 470	17 020	10 450	13 680	8310			*6410	*6410	13.66
	*56,300	*56,300	*72,900	55,350	*56,650	38,700	*45,450	28,900	36,550	22,450	29,400	17,800			*14,200	*14,200	44.72
-4.5 m -15.0 ft	*31 510	*31 510	*31 750	25 770	*24 960	17 910	*20 060	13 370	*16 210	10 410	11 510	8380			*7770	*7770	12.65
	*71,850	*71,850	*68,600	55,350	*53,850	38,500	*43,150	28,750	*34,700	22,350					*17,300	*17,300	41.33
-6.0 m -20.0 ft	*36 700	*36 700	*28 350	26 100	*22 450	18 090	*17 860	13 520	*13 760	10 610					*8670	*8670	11.30
	*79,000	*79,000	*60,950	56,100	*48,150	38,950	*38,050	29,100	*28,700	22,900					*18,750	*18,750	36.76
-7.5 m -25.0 ft	*29 250	*29 250	*22 990	*22 990	*18 060	*18 060	*13 540	*13 540									

\* Indicates that the load is limited by hydraulic capacity rather than tipping capacity. Lift capacity ratings are based on SAE standard J1097. Rated loads do not exceed 87% of hydraulic lifting capacity or 75% of tipping capacity.

**BOOM** – 8.4 m (27'7")  
**STICK** – 4400 mm (14'5")

**BUCKET** – 1678 mm (66") GP with HD long tips  
**SHOES** – 900 mm (36") double grouser

**UNDERCARRIAGE** – Long  
**HEAVY LIFT** – On

Load Point Height	3.0 m/10.0 ft		4.5 m/15.0 ft		6.0 m/20.0 ft		7.5 m/25.0 ft		9.0 m/30.0 ft		10.5 m/35.0 ft		12.0 m/40.0 ft		m		
	kg	lb	kg	lb	kg	lb	kg	lb	kg	lb	kg	lb	kg	lb	kg	lb	
12.0 m 40.0 ft															*5700	*5700	11.04
															*12,700	*12,700	35.59
10.5 m 35.0 ft															*5330	*5330	12.28
															*11,800	*11,800	39.90
9.0 m 30.0 ft											*11 710	*11 710			*5170	*5170	13.17
											*24,000	*24,000			*11,400	*11,400	42.98
7.5 m 25.0 ft									*15 090	*15 090	*13 970	13 050	*8320	*8320	*5140	*5140	13.80
									*32,800	*32,800	*29,750	27,900			*11,300	*11,300	45.14
6.0 m 20.0 ft									*16 380	*16 380	*14 720	12 730	*11 740	9630	*5220	*5220	14.20
									*35,500	*35,500	*32,000	27,250	*23,150	20,500	*11,500	*11,500	46.52
4.5 m 15.0 ft					*26 880	*26 880	*21 290	*21 290	*17 900	16 240	*15 630	12 290	*14 010	9410	*5410	*5410	14.40
					*57,800	*57,800	*45,950	*45,950	*38,750	34,900	*33,900	26,350	*28,900	20,100	*11,900	*11,900	47.23
3.0 m 10.0 ft					*30 920	29 610	*23 700	20 810	*19 400	15 440	*16 550	11 800	*14 500	9140	*5720	*5720	14.41
					*66,600	63,850	*51,150	44,800	*41,950	33,200	*35,850	25,300	*31,200	19,500	*12,600	*12,600	47.29
1.5 m 5.0 ft					*33 600	27 700	*25 550	19 650	*20 620	14 710	*17 300	11 340	14 260	8870	*6170	*6170	14.24
					*72,550	59,650	*55,200	42,300	*44,600	31,600	*37,450	24,300	30,600	18,950	*13,600	*13,600	46.73
Ground Line			*14 670	*14 670	*34 600	26 570	*26 560	18 810	*21 350	14 140	17 550	10 960	14 030	8650	*6790	6690	13.87
			*33,850	*33,850	*74,900	57,150	*57,450	40,450	*46,200	30,400	37,700	23,500	30,100	18,500	*15,000	14,750	45.50
-1.5 m -5.0 ft	*11 810	*11 810	*20 330	*20 330	*34 160	26 060	*26 620	18 330	*21 450	13 770	17 290	10 720	13 900	8530	*7670	7230	13.29
	*26,650	*26,650	*46,400	*46,400	*74,000	56,000	*57,600	39,400	*46,300	29,600	37,150	23,000	*29,450	18,300	*16,950	15,950	43.56
-3.0 m -10.0 ft	*18 720	*18 720	*27 790	*27 790	*32 470	25 990	*25 660	18 150	*20 700	13 620	16 790	10 630			*8940	8180	12.46
	*42,200	*42,200	*63,300	*63,300	*70,300	55,800	*55,450	39,050	*44,650	29,250	*36,000	22,850			*19,850	18,150	40.78
-4.5 m -15.0 ft	*26 600	*26 600	*37 420	*37 420	*29 450	26 250	*23 530	18 260	*18 860	13 690	14 630	10 770			*9040	*9040	11.33
	*60,100	*60,100	*80,950	*80,950	*63,600	56,400	*50,650	39,300	*40,400	29,450	*30,750	23,200			*19,650	*19,650	36.95
-6.0 m -20.0 ft	*36 470	*36 470	*30 830	*30 830	*24 750	*24 750	*19 750	18 670	*15 160	14 070							
	*82,750	*82,750	*66,150	*66,150	*53,000	*53,000	*42,050	40,200	*31,600	30,350							
-7.5 m -25.0 ft					*17 340	*17 340	*12 910	*12 910									
					*35,950	*35,950	*25,700	*25,700									

\* Indicates that the load is limited by hydraulic capacity rather than tipping capacity. Lift capacity ratings are based on SAE standard J1097. Rated loads do not exceed 87% of hydraulic lifting capacity or 75% of tipping capacity.

# General Purpose Boom Lift Capacities



Load Point Height



Load at Maximum Reach



Load Radius Over Front





















Load Radius Over Side

**BOOM** – 8.4 m (27'7")  
**STICK** – 3400 mm (11'2")

**BUCKET** – 2260 mm (89") GP with HD long tips  
**SHOES** – 900 mm (36") double grouser

**UNDERCARRIAGE** – Long  
**HEAVY LIFT** – On

















	3.0 m/10.0 ft		4.5 m/15.0 ft		6.0 m/20.0 ft		7.5 m/25.0 ft		9.0 m/30.0 ft		10.5 m/35.0 ft		12.0 m/40.0 ft				m ft	
																		
12.0 m 40.0 ft	kg lb															*5580 *12,550	*5580 *12,550	9.93 31.85
10.5 m 35.0 ft	kg lb									*12 750	*12 750					*4990 *11,100	*4990 *11,100	11.31 36.68
9.0 m 30.0 ft	kg lb									*13 910 *30,300	*13 910 *30,300					*4700 *10,400	*4700 *10,400	12.28 40.03
7.5 m 25.0 ft	kg lb									*14 700 *31,850	*14 700 *31,850	*13 210 *28,750	10 930 23,150			*4590 *10,150	*4590 *10,150	12.95 42.33
6.0 m 20.0 ft	kg lb					*23 670 *50,800	*23 670 *50,800	*18 860 *40,650	*18 860 *40,650	*15 860 *34,300	15 000 32,100	*13 820 *29,950	10 740 22,850			*4630 *10,200	*4630 *10,200	13.37 43.80
4.5 m 15.0 ft	kg lb					*27 490 *59,050	*27 490 *59,050	*21 020 *45,300	19 860 42,750	*17 150 *37,050	14 230 30,500	*14 560 *31,500	10 360 22,050	*11 900 *19,800	7400 15,600	*4800 *10,550	*4800 *10,550	13.58 44.53
3.0 m 10.0 ft	kg lb					*30 490 *65,650	26 220 56,600	*22 900 *49,400	18 420 39,650	*18 330 *39,600	13 420 28,800	*15 260 *32,950	9910 21,150	12 670 *26,000	7230 15,250	*5110 *11,250	5000 11,050	13.58 44.57
1.5 m 5.0 ft	kg lb					*27,420 *66,850	24 450 52,650	*24 110 *52,050	17 280 37,150	*19 160 *41,350	12 710 27,250	*15 720 *33,950	9500 20,300	12 470 *26,250	7050 14,900	*5580 *12,300	5090 11,210	13.39 43.93
Ground Line	kg lb					*29 590 *68,550	23 670 50,850	*24 440 *52,850	16 560 35,600	*19 440 *42,000	12 210 26,200	*15 790 *33,900	9190 19,650			*6260 *13,800	5460 12,050	12.98 42.58
-1.5 m -5.0 ft	kg lb			*17 180 *39,550	*17 180 *39,550	*30 270 *65,650	23 530 50,500	*23 840 *51,550	16 260 34,900	*19 030 *41,050	11 960 25,650	*15 220 *32,600	9050 19,350			*7240 *16,000	6210 13,750	12.34 40.44
-3.0 m -10.0 ft	kg lb	*18 410 *41,700	*18 410 *41,700	*27 750 *63,550	*27 750 *63,550	*27 820 *60,250	23 840 51,150	*22 220 *47,950	16 320 35,050	*17 680 *37,950	11 980 25,700	*13 530 *28,450	9140 19,650			*8690 *19,200	7550 16,800	11.42 37.36
-4.5 m -15.0 ft	kg lb	*29 110 *66,000	*29 110 *66,000	*29 260 *63,300	*29 260 *63,300	*24 030 *51,800	*24 030 *51,800	*19 280 *41,300	16 720 35,950	*14 860 *31,350	12 310 26,500							
-6.0 m -20.0 ft	kg lb			*21 820 *46,500	*21 820 *46,500	*18 220 *38,600	*18 220 *38,600	*14 090 *29,200	*14 090 *29,200									

\* Indicates that the load is limited by hydraulic capacity rather than tipping capacity. Lift capacity ratings are based on SAE standard J1097. Rated loads do not exceed 87% of hydraulic lifting capacity or 75% of tipping capacity.

**BOOM** – 8.4 m (27'7")  
**STICK** – 2920 mm (9'7")

**BUCKET** – 2260 mm (89") GP with HD long tips  
**SHOES** – 900 mm (36") double grouser

**UNDERCARRIAGE** – Long  
**HEAVY LIFT** – On

	3.0 m/10.0 ft		4.5 m/15.0 ft		6.0 m/20.0 ft		7.5 m/25.0 ft		9.0 m/30.0 ft		10.5 m/35.0 ft				m ft		
																	
12.0 m 40.0 ft	kg lb														*6300 *14,150	*6300 *14,150	9.28 29.67
10.5 m 35.0 ft	kg lb														*5620 *12,500	*5620 *12,500	10.78 34.89
9.0 m 30.0 ft	kg lb									*14 790 *32,250	*14 790 *32,250				*5280 *11,700	*5280 *11,700	11.80 38.44
7.5 m 25.0 ft	kg lb							*17 910 *38,700	*17 910 *38,700	*15 500 *33,600	15 360 32,750	*13 910 *26,900	10 680 22,450	*5150 *11,350	*5150 *11,350	12.50 40.86	
6.0 m 20.0 ft	kg lb					*25 120 *53,900	*25 120 *53,900	*19 840 *42,750	*19 840 *42,750	*16 590 *35,900	14 830 31,750	*14 410 *31,250	10 600 22,500	*5180 *11,400	*5180 *11,400	12.94 42.39	
4.5 m 15.0 ft	kg lb					*28 750 *61,750	28 120 60,800	*21 870 *47,150	19 550 42,100	*17 790 *38,450	14 100 30,250	*15 070 *32,600	10 280 21,900	*5350 *11,750	*5350 *11,750	13.16 43.14	
3.0 m 10.0 ft	kg lb					*27 280 *67,400	24 770 55,000	*23 540 *50,800	18 170 39,100	*18 840 *40,700	13 330 28,600	*15 660 *33,800	9890 21,100	*5660 *12,450	*5660 *12,100	13.16 43.19	
1.5 m 5.0 ft	kg lb					*22 520 *55,350	22 520 51,650	*24 460 *52,850	17 120 36,850	*19 490 *42,100	12 690 27,200	*15 980 *34,500	9530 20,350	*6140 *13,500	5610 12,350	12.96 42.52	
Ground Line	kg lb					*27 810 *66,150	23 490 50,500	*24 480 *52,950	16 530 35,550	*19 570 *42,250	12 260 26,300	*15 850 *34,100	9280 19,850	*6830 *15,050	6050 13,350	12.53 41.12	
-1.5 m -5.0 ft	kg lb			*17 080 *39,550	*17 080 *39,550	*29 400 *63,850	23 580 50,650	*23 560 *50,950	16 350 35,150	*18 890 *40,700	12 090 25,950	*14 940 *31,900	9210 19,750	*7840 *17,300	6930 15,350	11.87 38.89	
-3.0 m -10.0 ft	kg lb	*19 990 *45,350	*19 990 *45,350	*29 890 *68,550	*29 890 *68,550	*26 600 *57,650	24 060 51,650	*21 580 *46,550	16 530 35,500	*17 150 *36,750	12 210 26,200			*8740 *19,150	8530 18,950	10.90 35.64	
-4.5 m -15.0 ft	kg lb			*26 290 *56,900	*26 290 *56,900	*22 390 *48,200	*22 390 *48,200	*18 110 *38,700	17 070 36,750	*13 480 *27,850	12 690 27,400						
-6.0 m -20.0 ft	kg lb					*15 790 *35,250	*15 790 *35,250										

\* Indicates that the load is limited by hydraulic capacity rather than tipping capacity. Lift capacity ratings are based on SAE standard J1097. Rated loads do not exceed 87% of hydraulic lifting capacity or 75% of tipping capacity.



# Mass Boom Lift Capacities



Load Point Height



Load at Maximum Reach



Load Radius Over Front



















Load Radius Over Side

**BOOM** – 7.25 m (23'9")  
**STICK** – 3400 mm (11'2")

**BUCKET** – 2260 mm (89") GP with HD long tips  
**SHOES** – 900 mm (36") double grouser

**UNDERCARRIAGE** – Long  
**HEAVY LIFT** – On















	3.0 m/10.0 ft		4.5 m/15.0 ft		6.0 m/20.0 ft		7.5 m/25.0 ft		9.0 m/30.0 ft		10.5 m/35.0 ft				m ft
															
10.5 m 35.0 ft	kg lb						*12 300	*12 300					*5870 *13,100	*5870 *13,100	9.69 31.28
9.0 m 30.0 ft	kg lb								*10 220	*10 220			*5440 *12,050	*5440 *12,050	10.85 35.29
7.5 m 25.0 ft	kg lb						*18 100 *39,300	*18 100 *39,300	*15 650 *32,650	15 550 *32,650			*5300 *11,700	*5300 *11,700	11.62 37.95
6.0 m 20.0 ft	kg lb						*20 070 *43,450	*20 070 *43,450	*17 380 *37,700	15 300 *32,650	*10 360 *10 360		*5360 *11,800	*5360 *11,800	12.10 39.62
4.5 m 15.0 ft	kg lb		*38 490 *82,500	*38 490 *82,500	*27 820 *59,900	*27 820 *59,900	*22 090 *47,700	20 980 45,050	*18 480 *40,000	14 770 31,600	*15 020 *29,000	10 510 22,300	*5600 *12,300	*5600 *12,300	12.33 40.44
3.0 m 10.0 ft	kg lb		*28 440 *72,200	*28 440 *72,200	*31 170 *67,250	28 890 62,150	*23 990 *51,800	19 730 42,400	*19 520 *42,200	14 120 30,200	*16 340 *35,300	10 230 21,750	*6030 *13,250	*6030 *13,250	12.34 40.49
1.5 m 5.0 ft	kg lb		*19 680 *46,950	*19 680 *46,950	*33 160 *71,650	26 910 57,850	*25 270 *54,600	18 630 40,000	*20 210 *43,650	13 500 28,900	*16 460 *35,400	9940 21,150	*6690 *14,700	*6690 *14,700	12.11 39.77
Ground Line	kg lb		*24 060 *55,800	*24 060 *55,800	*33 350 *72,200	25 750 55,300	*25 570 *55,250	17 850 38,350	*20 220 *43,600	13 040 27,900	*15 890 *33,050	9720 20,750	*7670 *16,900	7460 16,450	11.66 38.24
-1.5 m -5.0 ft	kg lb	*17 910 *40,500	*17 910 *40,500	*33 450 *76,850	*33 450 *76,850	*31 780 *68,800	25 330 54,350	*24 590 *53,100	17 480 37,500	*19 180 *41,150	12 820 27,500		*9150 *20,250	8610 19,050	10.92 35.79
-3.0 m -10.0 ft	kg lb	*28 990 *65,600	*28 990 *65,600	*36 390 *78,800	*36 390 *78,800	*28 360 *61,200	25 490 54,700	*21 980 *47,200	17 520 37,650	*16 340 *34,400	12 930 27,800				
-4.5 m -15.0 ft	kg lb	*34 300 *74,300	*34 300 *74,300	*28 390 *60,900	*28 390 *60,900	*22 490 *47,950	*22 490 *47,950	*16 730 *35,000	*16 730 *35,000						

\* Indicates that the load is limited by hydraulic capacity rather than tipping capacity. Lift capacity ratings are based on SAE standard J1097. Rated loads do not exceed 87% of hydraulic lifting capacity or 75% of tipping capacity.

**BOOM** – 7.25 m (23'9")  
**STICK** – 2920 mm (9'7")

**BUCKET** – 2260 mm (89") GP with HD long tips  
**SHOES** – 900 mm (36") double grouser

**UNDERCARRIAGE** – Long  
**HEAVY LIFT** – On

	3.0 m/10.0 ft		4.5 m/15.0 ft		6.0 m/20.0 ft		7.5 m/25.0 ft		9.0 m/30.0 ft				m ft	
														
10.5 m 35.0 ft	kg lb										*6650 *14,850	*6650 *14,850	9.12 29.34	
9.0 m 30.0 ft	kg lb							*17 810 *37,550	*17 810 *37,550		*6150 *13,650	*6150 *13,650	10.36 33.66	
7.5 m 25.0 ft	kg lb							*19 550 *42,450	*19 550 *42,450	*16 050 *31,600	15 190 *31,600	*5980 *13,200	*5980 *13,200	11.17 36.48
6.0 m 20.0 ft	kg lb				*25 660 *53,300	*25 660 *53,300	*21 120 *45,700	*21 120 *45,700	*18 160 *39,450	15 070 32,150	*6030 *13,250	*6030 *13,250	11.68 38.23	
4.5 m 15.0 ft	kg lb		*40 970 *87,600	*40 970 *87,600	*29 170 *62,850	*29 170 *62,850	*22 990 *49,700	20 700 44,450	*19 130 *41,400	14 610 31,200	*6280 *13,800	*6280 *13,800	11.92 39.08	
3.0 m 10.0 ft	kg lb				*32 120 *69,300	28 300 60,950	*24 670 *53,300	19 500 41,900	*20 020 *43,300	14 010 30,000	*6720 *14,800	*6720 *14,800	11.92 39.13	
1.5 m 5.0 ft	kg lb		*15 360 *37,100	*15 360 *37,100	*33 510 *72,500	26 510 57,050	*25 640 *55,450	18 480 39,700	*20 480 *44,250	13 460 28,850	*7420 *16,300	*7420 *16,300	11.62 38.38	
Ground Line	kg lb		*22 880 *53,150	*22 880 *53,150	*33 080 *71,700	25 580 54,950	*25 560 *55,250	17 820 38,300	*20 170 *43,450	13 080 28,050	*8450 *18,650	8200 18,100	11.21 36.78	
-1.5 m -5.0 ft	kg lb	*18 870 *42,700	*18 870 *42,700	*34 850 *80,150	*34 850 *80,150	*30 920 *66,950	25 370 54,500	*24 120 *52,050	17 580 37,750	*18 620 *39,800	12 960 27,800	*10 020 *22,150	9580 21,200	10.44 34.20
-3.0 m -10.0 ft	kg lb	*32 080 *72,600	*32 080 *72,600	*33 510 *72,650	*33 510 *72,650	*26 840 *57,900	25 740 55,300	*20 840 *44,600	17 770 38,200					
-4.5 m -15.0 ft	kg lb			*24 710 *52,900	*24 710 *52,900	*19 990 *42,400	*19 990 *42,400	*14 050 *28,400	*14 050 *28,400					

\* Indicates that the load is limited by hydraulic capacity rather than tipping capacity. Lift capacity ratings are based on SAE standard J1097. Rated loads do not exceed 87% of hydraulic lifting capacity or 75% of tipping capacity.

## Standard Equipment

*Standard equipment may vary. Consult your Caterpillar dealer for details.*

### Electrical

- Alternator – 75 ampere
- Lights
  - Cab interior
- Power supply in cab – 12V, 7 amp
- Signal/warning horn

### Engine/Powertrain

- Automatic engine speed control
- Automatic swing parking brake
- Automatic travel parking brakes
- Caterpillar C18 ATAAC with ACERT technology
  - Altitude capability to 2300 m (7500 ft) without derating
  - EPA Tier 3 emission compliant
- High ambient cooling, 52° C (126° F) capability
- Side-by-side cooling system with separately mounted AC condenser and variable speed fan
- Two speed travel
- Water separator, with level indicator, for fuel line

### Guards

- Heavy duty bottom guards on upper frame
- Heavy duty swivel guard on undercarriage
- Heavy duty travel motor guards on undercarriage

### Operator Station

- Air conditioner, heater and defroster
  - with automatic climate control
- Ashtray and 24 volt lighter
- AM/FM radio with antenna and two speakers
- Beverage/cup holder
- Cab Glass/Glazing
  - Openable and retractable two-piece front windshield
  - Stationary skylight (polycarbonate)
- Coat hook
- Console mounted electronic type joysticks with adjustable gain and response
- Floor mat
- Instrument panel and gauges with full color graphical display
- Literature compartment
- Lunch box storage with lid
- Neutral lever (lock out) for all controls
- Positive filtered ventilation
- Pressurized cab
- Retractable seat belt 76 mm width (3")
- Sunshade for windshield and skylight
- Travel control pedals with removable hand levers
- Windshield wipers and washers (upper and lower)

### Undercarriage

- Double grouser shoes – 900 mm (36") width
- Grease lubricated track
- Hydraulic track adjusters
- Idler and center section track guards
- Long, variable gauge
- Steps – four

### Other Standard Equipment

- Auxiliary hydraulic valve for hydro-mechanical tools
- Caterpillar one key security system with locks for doors, cab and fuel cap
- Cat walks – left side and right side
- Cross-roller type swing bearing
- Drive for auxiliary pump
- Hand control pattern changer
- Heavy lift mode
- Mirrors – left and right
- S•O•S<sup>SM</sup> quick sampling valves for engine oil and hydraulic oil
- Steel firewall between engine and hydraulic pumps
- Travel alarm with cut off switch
- Wiring provisions for Product Link, Auto-lube System and lighted beacon

## Optional Equipment

*Optional equipment may vary. Consult your Caterpillar dealer for details.*

### Front Linkage

#### Booms

Reach 10 m (32'10")

General Purpose 8.4 m (27'7")

Mass Excavation 7.25 m (23'9")

#### Sticks

R5.5HB (18'1") for reach and GP boom

R4.4HB (14'5") for reach and GP boom

G3.4JB (11'2") for GP boom

G2.92JB (9'7") for GP boom

M3.4JB (11'2") for mass boom

M2.92JB (9'7") for mass boom

#### Bucket Linkages

HB-family for HB sticks

JB-family for JB sticks

Buckets – see chart

Tips, sidecutters and edge protectors

### Track

Double grouser 650 mm (26")

Double grouser 750 mm (30")

### Guards

FOGS (Falling Object Guard System) including overhead and windshield guards

Track guiding guards – full length

Vandal guards for windshield

Wire mesh screen for windshield

### Auxiliary Controls and Lines

#### Basic control arrangements

Combined function for 1-way or 2-way high pressure circuits includes joysticks and modulation switch

Medium pressure circuit

#### Auxiliary boom lines

High pressure for reach and mass booms

#### Auxiliary stick lines

High pressure lines for reach and mass sticks

### Miscellaneous Options

Adjustable high-back heated seat with mechanical suspension

Adjustable high-back seat with air suspension and heat

Boom lowering control device

Counterweight removal system

Electric lubricator with hose reel

Machine security system with programmable keys

Starting aid for cold weather with ether

Stick lowering control device

Straight travel pedal



---

## Notes

# 385C L Hydraulic Excavator

For more complete information on Cat products, dealer services,  
and industry solutions, visit us on the web at [www.cat.com](http://www.cat.com)

© 2008 Caterpillar  
All Rights Reserved  
Printed in U.S.A.

Materials and specifications are subject to change without notice.  
Featured machines in photos may include additional equipment.  
See your Caterpillar dealer for available options.

AEHQ5625-02 (4-08)

Replaces AEHQ5625-01

CAT, CATERPILLAR, SAFETY.CAT.COM, their respective logos, "Caterpillar Yellow"  
and the POWER EDGE trade dress, as well as corporate and product identity used  
herein, are trademarks of Caterpillar and may not be used without permission.

**CATERPILLAR**<sup>®</sup>