

313F L

Hydraulic Excavator



Engine

Engine Model	Cat® C4.4 ACERT™
Net Power – SAE J1349/ISO 9249	68 kW (92 PS)
Gross Power – SAE J1995	74 kW (101 PS)
Engine Power – ISO 14396	74 kW (101 PS)

Drive

Maximum Travel Speed	5.4 km/h
Maximum Drawbar Pull	113 kN

Weights

Minimum Operating Weight	13 200 kg
Maximum Operating Weight	15 600 kg

Introduction

The Cat 313FL is a perfect choice for customers who value reliability, durability, and maximum efficiency to get work done. Powered by a U.S. EPA Tier 4 Final and EU Stage IV C4.4 ACERT engine, the machine features robust structures and a state-of-the-art hydraulic system that enable you to move material all day long with tremendous speed and precision.

The cab is ultra quiet and comes equipped with adjustable controls and seat to keep you comfortable and productive. It has easy-to-reach service points that make your routine maintenance fast and simple. Plus there is a full array of Cat work tools and auxiliary hydraulics to help you take on any task.

You just won't find a better, more efficient 13-ton excavator from any manufacturer – any place, anywhere.

Contents

Engine	4
Hydraulics	5
Operator Station.....	6
Structures & Undercarriage	7
Front Linkage	8
Attachments.....	9
Integrated Technologies.....	10
Serviceability	12
Safety	13
Complete Customer Care.....	14
Sustainability	15
Specifications.....	16
Standard Equipment.....	32
Optional Equipment.....	33
Notes.....	34

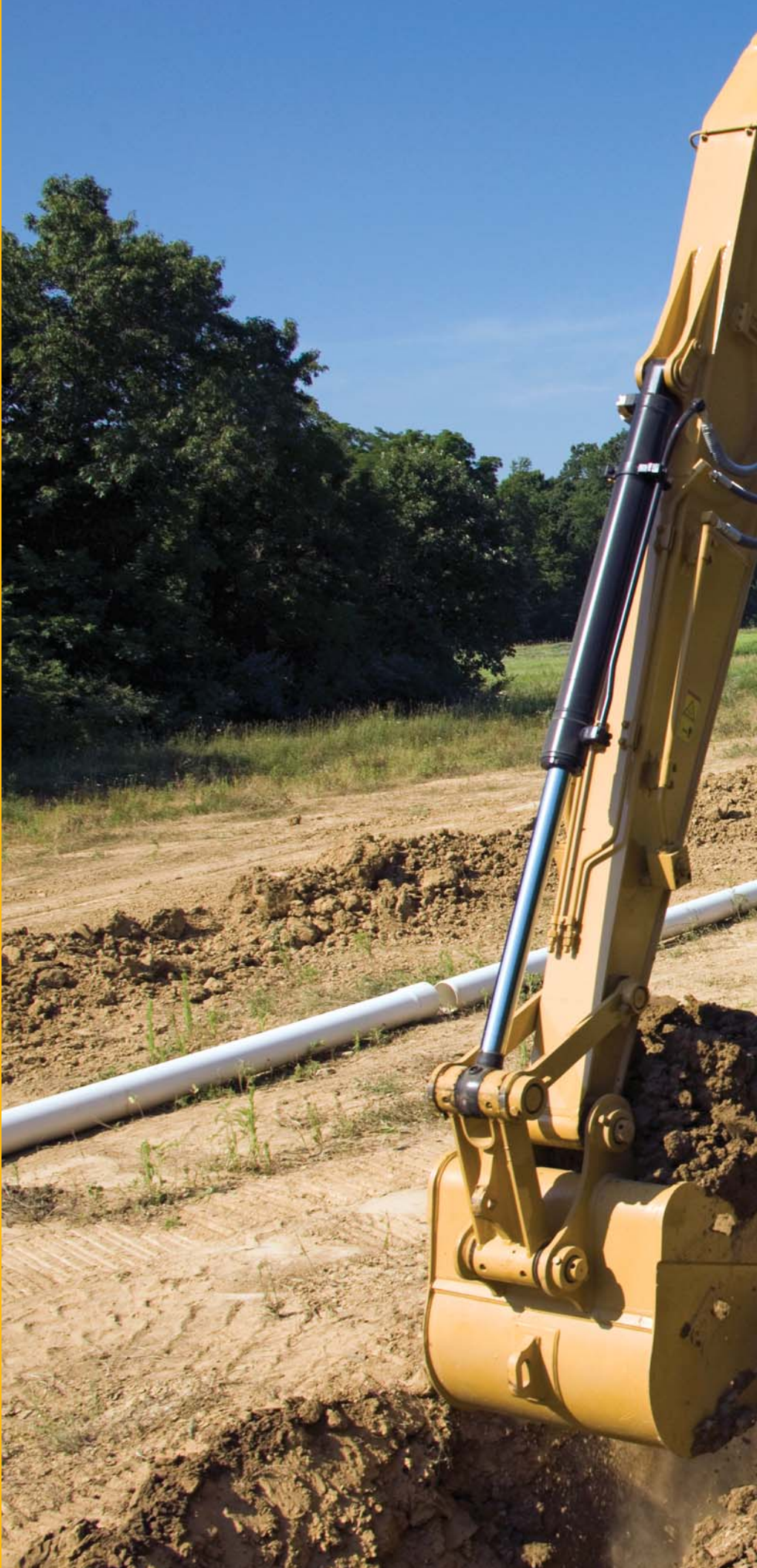



Engine

Powerful and fuel efficient to meet your expectations

Proven Technology

The Cat C4.4 ACERT engine meets Tier 4 Final and Stage IV emission standards, and it does so without interrupting your job process. Simply turn the engine on and go to work. It will look for opportunities in your work cycle to regenerate itself, and it will give you plenty of power for the task at hand – all to help keep your owning and operating costs to an absolute minimum.

Like every Cat Tier 4 Final and Stage IV engine, the C4.4 ACERT engine is equipped with a combination of proven electronic, fuel, air, and aftertreatment components. Applying these time-tested technologies lets us meet your high expectations for productivity, fuel efficiency, reliability, and service life.

Following are the results you can expect:

- **High performance** across a variety of applications.
- **Enhanced reliability** through commonality and simplicity of design.
- **Maximized uptime and reduced cost** with world-class Cat dealer support.
- **Minimized impact** on emission systems – with no operator interaction required.
- **Durability** with long service life.
- **Better fuel economy** with minimized maintenance costs.
- **Same great power** and response.

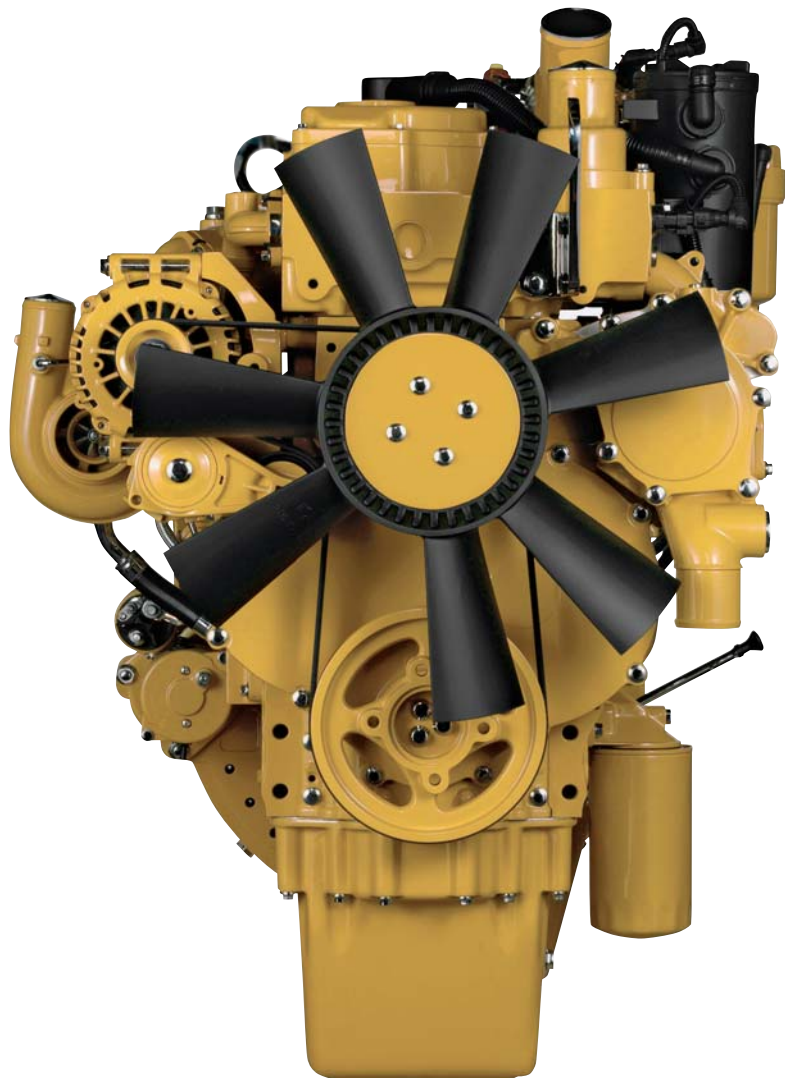



Hydraulics

Power to move your material with speed and precision

A Powerful, Efficient Design

When it comes to moving material quickly and efficiently, you need hydraulic horsepower – the type of ground-breaking power the 313F L can deliver. Major hydraulic components like pumps and valves are located close together so shorter tubes and lines can be used. This design leads to less friction loss, reduced pressure drops, and more power to the ground for the work you need to get done.

Control Like No Other

Controllability is one of the main attributes of Cat excavators, and one of the key contributors to this is the main control valve. The valve opens slowly when your range of joystick lever movement is small and opens rapidly when movement is high. It puts flow where you need it when you need it, which leads to smoother operation, greater efficiency, and lower fuel consumption.

Auxiliary Hydraulics For Added Versatility

Auxiliary hydraulics give you greater tool versatility so you can take on more work with just one machine, and there are several options from which you can choose. A quick coupler circuit, for example, will allow you to switch from one tool to another in a matter of minutes – all from the comfort and convenience of the cab.

Boom & Stick Oil Re-Circulation For Added Efficiency

The 313F L regenerates the flow of oil from the head end of the boom and stick cylinders to the rod end of the boom and stick cylinders during the work cycle to save energy and improve fuel efficiency. It's optimized for any dial speed setting you select, which results in less pressure loss for higher controllability, more productivity, and lower operating costs for you.

Operator Station

Comfort and convenience to keep you productive

A Safe, Quiet Cab

The roll-over protective structure (ROPS) cab provides you with a safe working environment. It also contributes to your comfort because it's attached to a reinforced frame with special viscous mounts that limit vibration and unnecessary sound. Add in special roof lining and sealing and you have a cab that's as quiet inside as today's top pickup trucks.

Comfortable Seat Options

The seat range includes air suspension, heated, and air cooled options. All seats include a reclining back, upper and lower slide adjustments, and height and tilt angle adjustments to meet your needs for maximum comfort.

A Cool & Warm Environment

The automatic climate control system features multiple air outlets with filtered ventilation. Air flows on the floor, behind the seat, and in front of you to make your work in either hot or cold weather much more pleasant and productive.

Controls Just For You

The right and left joystick consoles can be adjusted to improve your comfort and productivity during the course of a day. Also, the right joystick features a button that will reduce engine speed when you are not working to help save fuel. Touch it once and speed reduces; touch it again and speed increases for normal operation.



A Helpful Monitor

The LCD monitor is easy to see and navigate. Programmable in up to 42 languages to meet today's diverse workforce, the monitor clearly displays critical information you need to operate efficiently and effectively. Plus it projects the image from the standard rearview camera to help you see what's going on around you so you can stay safely focused on the job at hand.

Ample Storage & Auxiliary Power

Storage spaces are located in the front, rear, and side consoles of the cab. A drink holder accommodates a large mug, and a shelf behind the seat stores large lunch or toolboxes. Two 12-volt power supply sockets are conveniently located near the key storage areas for charging your electronic devices like an MP3 player, a cell phone, or a tablet.



Structures & Undercarriage

Made to work in your rugged applications



Durable Undercarriage

The standard and long undercarriage contributes significantly to its outstanding stability and durability. Track shoes, links, rollers, idlers, and final drives are all built with long-lasting, high-tensile-strength steel. Cat Grease Lubricated Track 2 (GLT2) track link protects moving parts by keeping water, debris, and dust out and grease sealed in, which delivers longer wear life and reduced noise when traveling. Optional guide guards help maintain track alignment to improve the machine's overall performance – whether you're traveling on a flat, heavy bed of rock or a steep, wet field of mud.

Robust Frame

The 313F L is a well-built machine designed to give you a very long service life. The upper frame has mountings made specifically to support the heavy-duty cab; it is also reinforced around key areas that take on stress like the boom foot and skirt. Larger bolts are used to attach the track frames to the body, and additional bolts are used to increase the machine's digging force, which leads to more productivity for you.

Front Linkage

Options to take on your far-reaching and up-close tasks



Designed To Last

Your uptime and service intervals are increased with high-quality, durable, reliable booms, sticks, and linkage. Each boom and stick is built with internal baffle plates for maximum durability, and each undergoes ultrasound inspection to ensure quality and reliability for the tough work you do.

Booms & Sticks

The 313F L is offered with a reach boom and three stick configurations: R2.1 m, R2.5 m and R3.0 m. For the Europe market, a Variable Angle Boom is also available with two stick options: R2.5 m and R2.1 m. Each boom and stick is built with internal baffle plates for added durability, and each undergoes ultrasound inspection to ensure weld quality and reliability. Talk to your Cat dealer to pick the best front linkage for your specific applications.

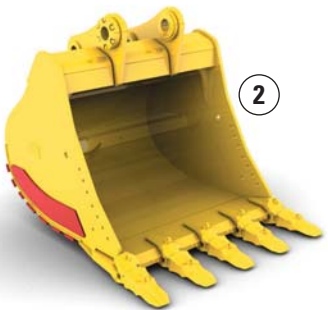
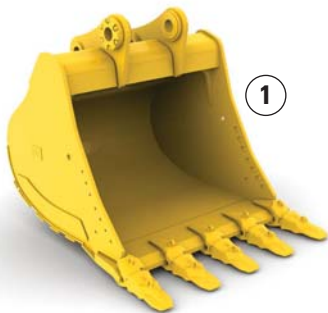

1) General Duty (GD) 2) Heavy Duty (HD)

Attachments

Tools to make you productive and profitable

Change Jobs Quickly

Cat quick coupler brings the ability to quickly change attachments and switch from job to job.

Dig, Finish, or Break

A range of buckets dig everything from top soil to abrasive material. For finishing and grading work, compact and shallow ditch cleaning buckets fit the need.

A hydraulic hammer equips the machine for breaking sidewalks, driveways, and pavement.

Set Up Your Machine For Profitability

Your Cat dealer can install hydraulic kits to properly operate all Cat Work Tool attachments – maximizing the machine’s uptime and your profits. All Cat Work Tool attachments are supported by the same Cat dealer network as your Cat machine.



Integrated Technologies

Monitor, manage, and enhance job site operations



Cat Connect makes smart use of technology and services to improve your job site efficiency. Using the data from technology-equipped machines, you'll get more information and insight into your equipment and operations than ever before.

Cat Connect technologies offer improvements in these key areas:



EQUIPMENT
MANAGEMENT

Equipment Management – increase uptime and reduce operating costs.



PRODUCTIVITY

Productivity – monitor production and manage job site efficiency.



SAFETY

Safety – enhance job site awareness to keep your people and equipment safe.

LINK Technologies

LINK technologies, like Product Link™, are deeply integrated into your machine and wirelessly communicates key information, including location, hours, fuel usage, idle time and event codes.

Product Link/VisionLink®

Easy access to Product Link data via the online VisionLink user interface can help you see how your machine or fleet is performing. You can use this information to make timely, fact based decisions that can boost job site efficiency and productivity, and lower costs.

GRADE Technologies

Grade technologies combine digital design data and in-cab guidance to help you reach target grade quickly and accurately, with minimal staking and checking. That means you'll be more productive, complete jobs faster, in fewer passes, using less fuel, at a lower cost.



Cat Grade Control Depth and Slope

The factory integrated Cat Grade Control system delivers 2D bucket tip elevation guidance to the cab to help operators create precise planes and slopes with ease. Real-time bucket tip elevation guidance on the easy-to-read standard cab monitor indicates how much to cut or fill. Fast response sensors deliver immediate feedback, while optional integrated joystick buttons help operators make quick adjustments to maintain consistent, quality grades. Built-in alerts can be set to warn the operator if the linkage or bucket approaches a predefined elevation or depth, such as when working in areas with low ceilings, or digging near water lines. Staking and checking is minimized, which reduces ground crews and enhances job site safety.

Works best in simple 2D applications, such as digging basements or grading steep embankments. Easily upgrade to AccuGrade™ when 3D guidance is required.

Cat AccuGrade

The dealer-installed AccuGrade system provides 3D guidance for making complex cuts and contours, eliminating the need for staking and checking. A dedicated monitor displays a digital design plan with 3D bucket tip positioning and elevation guidance, indicating precisely where to work and how much to cut or fill.

Plug and play capability on the 313F L simplifies upgrading. Choose from satellite (GNSS) control for large projects with complex designs or total station (UTS) systems in areas with limited reception.



Serviceability

Designed to make your maintenance quick and easy

Safe, Convenient Access

You can reach most routine maintenance items like fluid taps and grease points from the safety and convenience of ground level. You will also find filters banked together for higher service efficiency. Compartments feature wide service doors designed to help prevent debris entry, and they also securely latch in place to help make your service work simpler.

A Smart Design

The high-ambient cooling system features a fuel-saving variable-speed fan and a side-by-side-mounted radiator and oil and air coolers for easy cleaning. Wider clearance between the two makes blowing off debris easy for you, which can help improve your machine's reliability and performance.

A Fresh Idea

When you select ventilation inside the cab, outside air enters through the fresh air filter. The filter is conveniently located on the side of the cab to make it easy to reach and replace, and it is protected by a lockable door that can be opened with the engine key.

More Service Benefits

Filters are banked together to enhance service efficiency. The fuel tank's drain cock makes it easy and simple for you to remove water and sediment during routine maintenance. Plus an integrated fuel level indicator pops up to help you reduce the possibility of fuel tank overfilling.



Safety

Features to help protect you day in and day out



A Safe, Quiet Cab

The ROPS cab provides you with a safe working environment when properly seated and belted. It also contributes to your comfort because it's attached to a reinforced frame with special viscous mounts that limit vibration and unnecessary sound. Add in special roof lining and sealing and you have a cab that's as quiet inside as any of today's top pickup trucks.

Secure Contact Points

Multiple large steps get you into the cab as well as a leg up to the compartments. Extended hand and guard rails allow you to safely climb to the upper deck. Anti-skid plates reduce your slipping hazards in all types of weather conditions, and they can be removed for cleaning.

Great Views

Ample glass gives you excellent visibility out front and to the side, and the standard rearview camera gives you a clear field of view behind the machine through the cab monitor. The available split-configuration windshield features an upper window with handles that make it easy to slide and store above you and a lower window that can be removed and stored on the inside wall of the cab. The large skylight also serves as an emergency exit and provides you with enhanced overhead visibility.

Smart Lighting

Halogen lights provide plenty of illumination, and the cab and boom lights can be programmed to stay on for up to 90 seconds after the engine has been turned off to help you safely exit the machine.





Complete Customer Care

Service you can count on

Parts Where You Work

Cat dealers utilize a worldwide parts network to maximize your machines' uptime. Plus they can help you save money with Cat remanufactured components.

Advice You Can Trust

What are the job requirements and machine attachments? What production is needed? Your Cat dealer can provide recommendations to help you make the right machine choices.

Financial Options Just For You

Consider financing options and day-to-day operating costs. Look at dealer services that can be included in the machine's cost to yield lower owning and operating costs over time.

Support Agreements To Fit Your Needs

Cat dealers offer a variety of customer support agreements and work with you to develop a plan to meet your specific needs. These plans can cover the entire machine, including attachments, to help protect your investment.

Operating Techniques To Boost Your Profits

Improving operating techniques can boost your profits. Your Cat dealer has videos, literature, and other ideas to help you increase productivity. Caterpillar also offers simulators and certified operator training to help maximize the return on your investment.



Sustainability

Generations ahead in every way

- The C4.4 ACERT engine meets Tier 4 Final and Stage IV emission standards.
- The 313F L has the flexibility of running on either ultra-low-sulfur diesel (ULSD) fuel with 15 ppm (10 ppm for EU standards) of sulfur or less or biodiesel (up to B20) fuel blended with ULSD that meets ASTM 6751 standards.
- An overfill indicator rises when the fuel tank is full to help service technicians avoid spilling.
- The QuickEvac™ option ensures fast, easy, and secure changing of engine and hydraulic oil.
- The machine is built to be rebuilt with major structures and components capable of being remanufactured to reduce waste and replacement costs.
- An efficient engine oil filter eliminates the need for painted metal cans and aluminum top plates. The cartridge-style spin-on housing enables the internal filter to be separated and replaced; the used internal element can be incinerated to help reduce waste.
- The 313F L is an efficient, productive machine that's designed to conserve our natural resources for generations ahead.

313F L Hydraulic Excavator Specifications

Engine

Engine Model	Cat C4.4 ACERT
Net Power – SAE J1349/ISO 9249	68 kW (92 PS)
Engine Power – ISO 14396	74 kW (101 PS)
Bore	105 mm
Stroke	127 mm
Displacement	4.4 L

Weights

Long Undercarriage, Reach Boom 4.65 m	
Minimum Operating Weight*	13 400 kg
Maximum Operating Weight**	14 900 kg
Standard Undercarriage, Reach Boom 4.65 m	
Minimum Operating Weight*	13 200 kg
Maximum Operating Weight**	14 600 kg
Long Undercarriage, Variable Angle Boom	
Minimum Operating Weight*	14 200 kg
Maximum Operating Weight**	15 600 kg
Standard Undercarriage, Variable Angle Boom	
Minimum Operating Weight*	13 900 kg
Maximum Operating Weight**	15 200 kg

*2.1 m stick, 2.2 mt counterweight, 0.53 m³ bucket, and 500 mm shoes.

**3.0 m stick, 2.2 mt counterweight, 0.53 m³ bucket and 700 mm shoes with blade.

Hydraulic System

Main System – Maximum Flow (Total)	256 L/min
Swing System – Maximum Flow	128 L/min
Maximum Pressure – Equipment	30 500 kPa
Maximum Pressure – Travel	35 000 kPa
Maximum Pressure – Swing	25 000 kPa
Pilot System – Maximum Flow	21.9 L/min
Pilot System – Maximum Pressure	4120 kPa
Boom Cylinder – Bore	110 mm
Boom Cylinder – Stroke	1015 mm
Stick Cylinder – Bore	120 mm
Stick Cylinder – Stroke	1197 mm
Bucket Cylinder – Bore	100 mm
Bucket Cylinder – Stroke	939 mm

Drive

Gradeability	30°/70%
Maximum Travel Speed	5.4 km/h
Maximum Drawbar Pull	113 kN

Swing Mechanism

Swing Speed	10.9 rpm
Swing Torque	30.9 kN·m

Service Refill Capacities

Fuel Tank Capacity	223 L
DEF Tank Capacity	21 L
Cooling System	22 L
Engine Oil (with filter)	13.5 L
Swing Drive	2.4 L
Final Drive (each)	3 L
Hydraulic System (including tank)	164 L
Hydraulic Tank	90.6 L

Track

Number of Shoes (each side)	
Long Undercarriage	46 pieces
Number of Track Rollers (each side)	
Long Undercarriage	7 pieces
Number of Carrier Rollers (each side)	
Long Undercarriage	2 pieces
Number of Shoes (each side)	
Standard Undercarriage	43 pieces
Number of Track Rollers (each side)	
Standard Undercarriage	6 pieces
Number of Carrier Rollers (each side)	
Standard Undercarriage	1 piece

Sound Performance

Operator Sound Pressure Level (ISO 6396:2008)	69 dB(A)
Exterior Sound Power Level (ISO 6395:2008)*	101 dB(A)

- * European Union Directive “2000/14/EC” as amended by “2005/88/EC,” sound exposure limits in effect at time of manufacture.
- Hearing protection may be needed when operating with an open operator station and cab (when not properly maintained or doors/windows open) for extended periods or in noisy environment.

Standards

Brakes	ISO 10265 2008
ROPS Cab	ISO 12117-2
Cab/OPG	ISO 10262 1998

313F L Hydraulic Excavator Specifications

Dimensions

All dimensions are approximate.

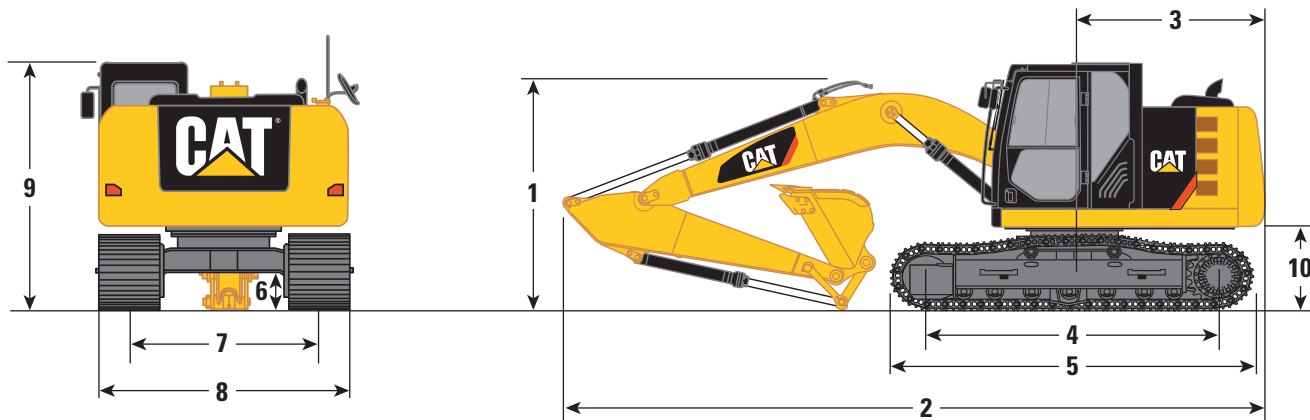

Boom Options	Reach Boom – 4.65 m			Variable Angle Boom	
Stick Options	R3.0 m	R2.5 m	R2.1 m	R2.5 m	R2.1 m
Bucket Type	GD	GD	GD	GD	GD
Bucket Capacity	0.53 m ³	0.53 m ³	0.53 m ³	0.53 m ³	0.53 m ³
Tip Radius	1225 mm (J250)	1225 mm (J250)	1225 mm (J250)	1225 mm (J250)	1225 mm (J250)
1 Shipping Height	2820 mm	2820 mm	2820 mm	2820 mm	2820 mm
2 Shipping Length					
Long Undercarriage	7670 mm	7670 mm	7690 mm	7730 mm	7770 mm
Long Undercarriage with Blade	7960 mm	7950 mm	7970 mm	8010 mm	8050 mm
Standard Undercarriage	7680 mm	7670 mm	7690 mm	7730 mm	7770 mm
Standard Undercarriage with Blade	7900 mm	7890 mm	7910 mm	7950 mm	7990 mm
3 Tail Swing Radius	2160 mm	2160 mm	2160 mm	2160 mm	2160 mm
4 Length to Center of Rollers					
Long Undercarriage	3040 mm	3040 mm	3040 mm	3040 mm	3040 mm
Standard Undercarriage	2780 mm	2780 mm	2780 mm	2780 mm	2780 mm
5 Track Length					
Long Undercarriage	3750 mm	3750 mm	3750 mm	3750 mm	3750 mm
Standard Undercarriage	3490 mm	3490 mm	3490 mm	3490 mm	3490 mm
6 Ground Clearance	440 mm	440 mm	440 mm	440 mm	440 mm
7 Track Gauge	1990 mm	1990 mm	1990 mm	1990 mm	1990 mm
8 Transport Width					
500 mm Shoes	2490 mm	2490 mm	2490 mm	2490 mm	2490 mm
600 mm Shoes	2590 mm	2590 mm	2590 mm	2590 mm	2590 mm
700 mm Shoes	2690 mm	2690 mm	2690 mm	2690 mm	2690 mm
9 Cab Height	2770 mm	2770 mm	2770 mm	2770 mm	2770 mm
Cab Height with Top Guard	2970 mm	2970 mm	2970 mm	2970 mm	2970 mm
10 Counterweight Clearance	890 mm	890 mm	890 mm	890 mm	890 mm

313F L Hydraulic Excavator Specifications

Working Ranges

All dimensions are approximate.

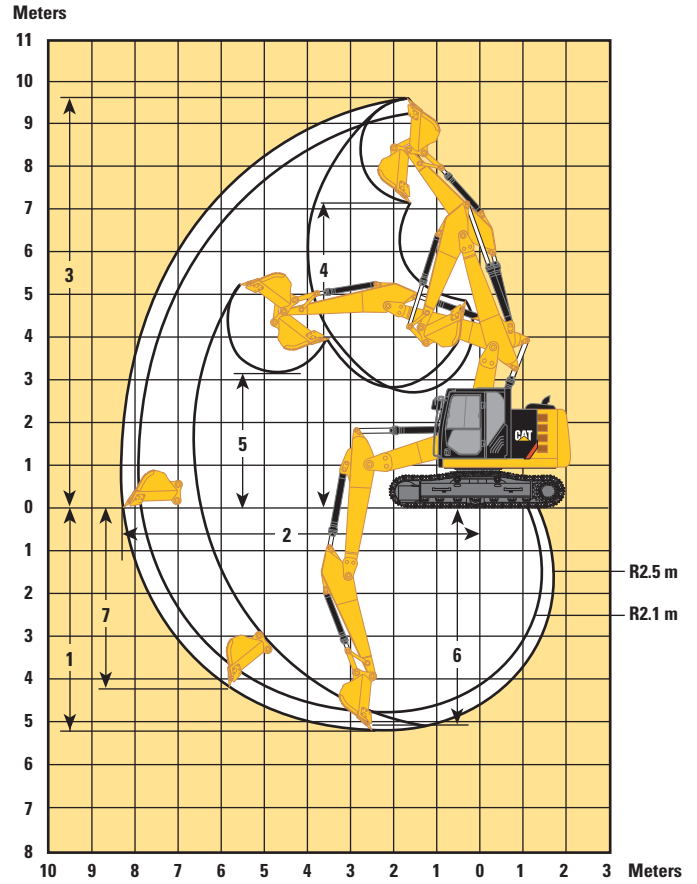
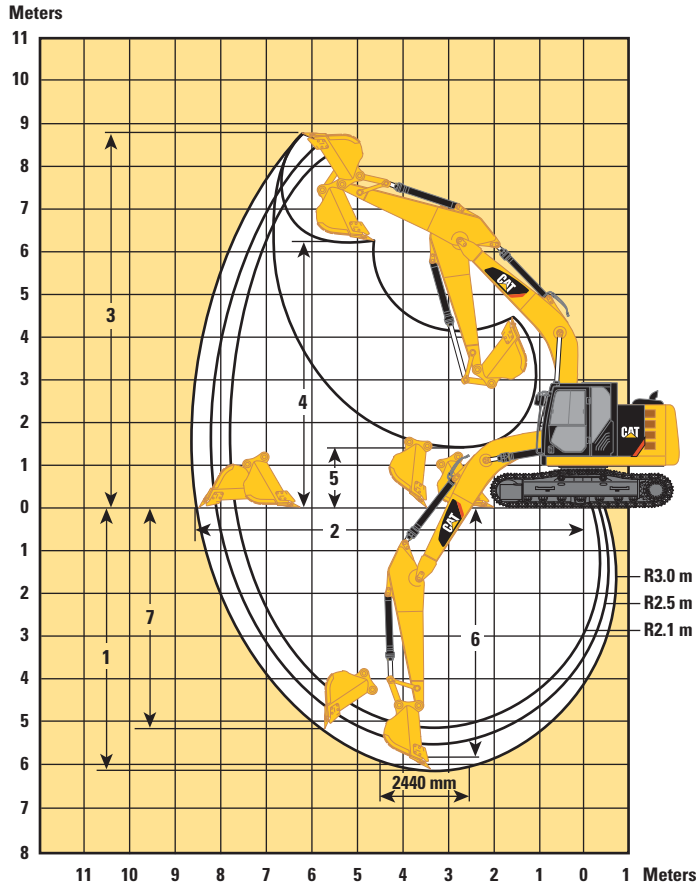

Boom Options	Reach Boom – 4.65 m			Variable Angle Boom	
	R3.0 m	R2.5 m	R2.1 m	R2.5 m	R2.1 m
Stick Options					
Bucket Capacity	0.53 m ³	0.53 m ³	0.53 m ³	0.53 m ³	0.53 m ³
Tip Radius	1225 mm (J250)	1225 mm (J250)	1225 mm (J250)	1225 mm (J250)	1225 mm (J250)
1 Maximum Digging Depth	6040 mm	5540 mm	5140 mm	5210 mm	4820 mm
2 Maximum Reach at Ground Line	8620 mm	8170 mm	7790 mm	8310 mm	7920 mm
3 Maximum Cutting Height	8710 mm	8490 mm	8230 mm	9610 mm	9250 mm
4 Maximum Loading Height	6330 mm	6100 mm	5850 mm	7160 mm	6810 mm
5 Minimum Loading Height	1530 mm	2020 mm	2420 mm	2750 mm	3110 mm
6 Maximum Depth Cut for 2440 mm Level Bottom	5860 mm	5330 mm	4900 mm	5090 mm	4680 mm
7 Maximum Vertical Wall Digging Depth	5200 mm	4840 mm	4380 mm	4260 mm	3840 mm

313F L Hydraulic Excavator Specifications

Operating Weights and Ground Pressures

	700 mm Shoes		600 mm Shoes		500 mm Shoes	
	Weight	Ground Pressure	Weight	Ground Pressure	Weight	Ground Pressure
Long Undercarriage – 2.2 mt Counterweight without Blade						
Reach Boom – 4.65 m						
R3.0 m Stick	14 100 kg	30.0 kPa	13 800 kg	34.3 kPa	13 500 kg	40.3 kPa
R2.5 m Stick	14 000 kg	29.8 kPa	13 700 kg	34.0 kPa	13 400 kg	40.0 kPa
R2.1 m Stick	14 000 kg	29.8 kPa	13 700 kg	34.0 kPa	13 500 kg	40.3 kPa
Variable Angle Boom						
R2.5 m Stick	14 700 kg	31.3 kPa	14 440 kg	35.9 kPa	14 200 kg	42.3 kPa
R2.1 m Stick	14 700 kg	31.3 kPa	14 500 kg	36.0 kPa	14 200 kg	42.3 kPa
Long Undercarriage – 2.2 mt Counterweight with Blade						
Reach Boom – 4.65 m						
R3.0 m Stick	14 900 kg	31.7 kPa	14 600 kg	36.3 kPa	14 400 kg	42.9 kPa
R2.5 m Stick	14 800 kg	31.5 kPa	14 500 kg	36.0 kPa	14 300 kg	42.6 kPa
R2.1 m Stick	14 800 kg	31.5 kPa	14 500 kg	36.0 kPa	14 300 kg	42.6 kPa
Variable Angle Boom						
R2.5 m Stick	15 600 kg	33.2 kPa	15 300 kg	38.0 kPa	15 000 kg	44.7 kPa
R2.1 m Stick	15 600 kg	33.2 kPa	15 300 kg	38.0 kPa	15 000 kg	44.7 kPa
Standard Undercarriage – 2.2 mt Counterweight without Blade						
Reach Boom – 4.65 m						
R3.0 m Stick	13 700 kg	29.2 kPa	13 500 kg	33.5 kPa	13 200 kg	39.4 kPa
R2.5 m Stick	13 600 kg	29.0 kPa	13 400 kg	33.3 kPa	13 200 kg	39.4 kPa
R2.1 m Stick	13 700 kg	29.2 kPa	13 400 kg	33.3 kPa	13 200 kg	39.4 kPa
Variable Angle Boom						
R2.5 m Stick	13 400 kg	28.5 kPa	14 100 kg	35.0 kPa	13 900 kg	41.5 kPa
R2.1 m Stick	13 400 kg	28.5 kPa	14 100 kg	35.0 kPa	13 900 kg	41.5 kPa
Standard Undercarriage – 2.2 mt Counterweight with Blade						
Reach Boom – 4.65 m						
R3.0 m Stick	14 600 kg	31.1 kPa	14 300 kg	35.5 kPa	14 100 kg	42.0 kPa
R2.5 m Stick	14 500 kg	30.9 kPa	14 200 kg	35.3 kPa	14 000 kg	41.7 kPa
R2.1 m Stick	14 500 kg	30.9 kPa	14 200 kg	35.3 kPa	14 000 kg	41.7 kPa
Variable Angle Boom						
R2.5 m Stick	15 200 kg	32.4 kPa	14 900 kg	37.0 kPa	14 700 kg	43.8 kPa
R2.1 m Stick	15 200 kg	32.4 kPa	14 900 kg	37.0 kPa	14 700 kg	43.8 kPa

313F L Hydraulic Excavator Specifications

Major Component Weights

	kg
Base Machine (with boom cylinder, without counterweight, front linkage and track)	5190
Long Undercarriage	2600
Standard Undercarriage	2410
Counterweight 2.2 mt	2200
Boom (includes lines, pins and stick cylinder)	
Reach Boom – 4.65 m	1010
VA Boom	1760
Stick (includes lines, pins, bucket cylinder, and bucket linkage)	
R3.0 m	670
R2.5 m	590
R2.1 m	600
Track Shoe (Long/per two tracks)	
500 mm Triple Grouser	1560
600 mm Triple Grouser	1820
700 mm Triple Grouser	2100
Track Shoe (Standard/per two tracks)	
500 mm Triple Grouser	1460
600 mm Triple Grouser	1700
700 mm Triple Grouser	1950
Quick Coupler (NEW Pin Grabber Coupler) with Pin	210
Blade	
2500 mm	810
2600 mm	810
2700 mm	820
Bucket with Sidecutter and Tip	
GD 0.53 m ³	440

All weights are rounded up to nearest 10 kg except for buckets.

Base machine includes 75 kg operator weight, 90% fuel weight, and undercarriage with center guard.

Bucket and Stick Forces









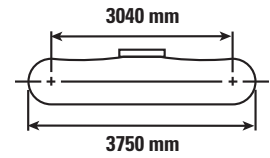
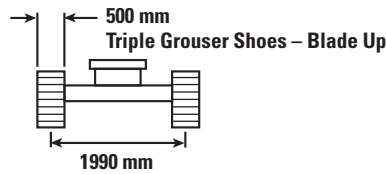
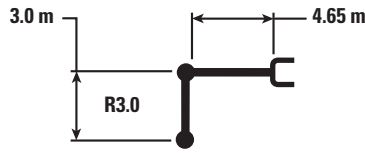

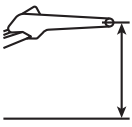



Boom Options	Reach Boom – 4.65 m			Variable Angle Boom	
Stick Options	R3.0 m	R2.5 m	R2.1 m	R2.5 m	R2.1 m
Bucket	0.53 m ³	0.53 m ³	0.53 m ³	0.53 m ³	0.53 m ³
Bucket Digging Force (SAE)	85 kN	85 kN	85 kN	85 kN	85 kN
Bucket Digging Force (ISO)	95 kN	95 kN	95 kN	95 kN	95 kN
Stick Digging Force (SAE)	57 kN	64 kN	71 kN	64 kN	71 kN
Stick Digging Force (ISO)	58 kN	65 kN	74 kN	65 kN	74 kN

313F L Hydraulic Excavator Specifications

Reach Boom Lift Capacities – Counterweight: 2.2 mt – with Bucket Linkages, without Bucket

Long Undercarriage



	1500 mm		3000 mm		4500 mm		6000 mm		7500 mm				mm		
															
7500 mm	kg												*2550	*2550	4370
6000 mm	kg												*2100	*2100	5950
4500 mm	kg							*3150	2650				*2000	*2000	6860
3000 mm	kg				*3850	*3850	*3450	2550					*2000	1850	7360
1500 mm	kg			*7550	6700	*4900	3700	3600	2450	*2150	1750		*2050	1750	7520
0 mm	kg			*7850	6250	5400	3500	3500	2350				*2300	1750	7380
-1500 mm	kg	*4500	*4500	*9300	6150	5300	3400	3450	2300				*2700	1900	6910
-3000 mm	kg	*7500	*7500	*8550	6200	5300	3400	3500	2300				3450	2300	6040
-4500 mm	kg			*6450	6400	*4050	3550						*4000	3500	4530



ISO 10567



*Indicates that the load is limited by hydraulic lifting capacity rather than tipping load. The above loads are in compliance with hydraulic excavator lift capacity standard ISO 10567:2007. They do not exceed 87% of hydraulic lifting capacity or 75% of tipping load. Weight of all lifting accessories must be deducted from the above lifting capacities. Lifting capacities are based on the machine standing on a firm, uniform supporting surface. The use of a work tool attachment point to handle/lift objects, could affect the machine lift performance.

Lift capacity stays with $\pm 5\%$ for all available track shoes.

Always refer to the appropriate Operation and Maintenance Manual for specific product information.

313F L Hydraulic Excavator Specifications

Reach Boom Lift Capacities – Counterweight: 2.2 mt – with Bucket Linkages, without Bucket

Long Undercarriage

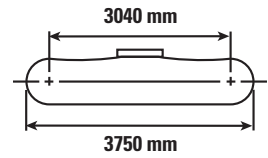
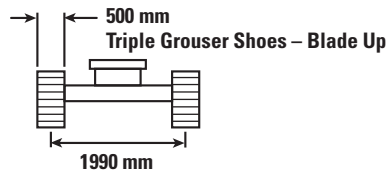
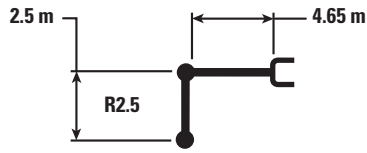

Reach (mm)	Unit	1500 mm		3000 mm		4500 mm		6000 mm		mm		
6000 mm	kg					*3350	*3350			*2450	*2450	5380
4500 mm	kg					*3550	*3550	*3500	2600	*2250	*2250	6370
3000 mm	kg			*5850	*5850	*4350	3900	3750	2550	*2250	2050	6900
1500 mm	kg			*8450	6550	*5300	3650	3600	2450	*2350	1950	7080
0 mm	kg			*6900	6250	5400	3500	3550	2350	*2600	1950	6930
-1500 mm	kg	*4850	*4850	*9200	6250	5350	3450	3500	2350	*3100	2150	6430
-3000 mm	kg	*8750	*8750	*8050	6300	5400	3450			4050	2700	5480



ISO 10567



*Indicates that the load is limited by hydraulic lifting capacity rather than tipping load. The above loads are in compliance with hydraulic excavator lift capacity standard ISO 10567:2007. They do not exceed 87% of hydraulic lifting capacity or 75% of tipping load. Weight of all lifting accessories must be deducted from the above lifting capacities. Lifting capacities are based on the machine standing on a firm, uniform supporting surface. The use of a work tool attachment point to handle/lift objects, could affect the machine lift performance.

Lift capacity stays with ±5% for all available track shoes.

Always refer to the appropriate Operation and Maintenance Manual for specific product information.

313F L Hydraulic Excavator Specifications

Reach Boom Lift Capacities – Counterweight: 2.2 mt – with Bucket Linkages, without Bucket

Long Undercarriage

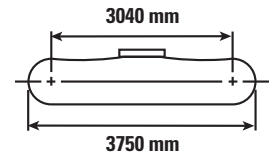
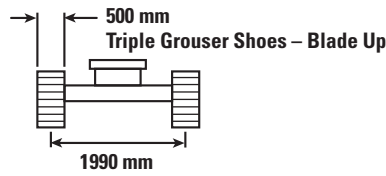
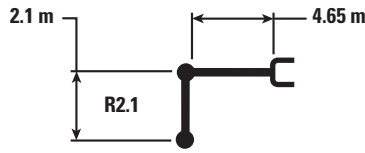

Reach (mm)	Unit	1500 mm		3000 mm		4500 mm		6000 mm		mm		
6000 mm	kg					*3800	*3800			*3000	*3000	4870
4500 mm	kg					*3900	3800			*2750	2450	5950
3000 mm	kg			*6550	*6550	*4650	3650	3650	2350	*2700	2100	6520
1500 mm	kg					5500	3400	3550	2300	*2850	1950	6700
0 mm	kg			*6250	5850	5350	3250	3500	2200	3100	2000	6550
-1500 mm	kg	*5300	*5300	*8900	5850	5300	3200	3500	2200	3500	2200	6010
-3000 mm	kg			*7450	6000	*5100	3300			*4350	2900	4980



ISO 10567



*Indicates that the load is limited by hydraulic lifting capacity rather than tipping load. The above loads are in compliance with hydraulic excavator lift capacity standard ISO 10567:2007. They do not exceed 87% of hydraulic lifting capacity or 75% of tipping load. Weight of all lifting accessories must be deducted from the above lifting capacities. Lifting capacities are based on the machine standing on a firm, uniform supporting surface. The use of a work tool attachment point to handle/lift objects, could affect the machine lift performance.

Lift capacity stays with ±5% for all available track shoes.

Always refer to the appropriate Operation and Maintenance Manual for specific product information.

313F L Hydraulic Excavator Specifications

Variable Angle Boom Lift Capacities – Counterweight: 2.2 mt – with Bucket Linkages, without Bucket

Long Undercarriage

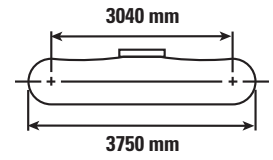
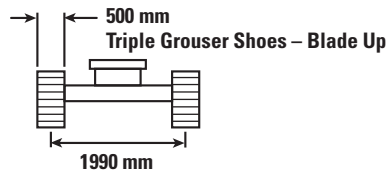
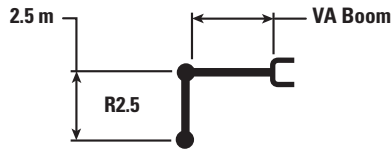

Boom Length	Unit	1500 mm		3000 mm		4500 mm		6000 mm		mm		
		Diagram	Diagram	Diagram	Diagram	Diagram	Diagram	Diagram	Diagram	Diagram	Diagram	
7500 mm	kg			*2850	*2850					*2750	*2750	3800
6000 mm	kg			*4350	*4350	*2250	*2250			*2150	*2150	5550
4500 mm	kg			*4550	*4550	*2900	*2900	*2000	*2000	*2000	*2000	6520
3000 mm	kg	*11 300	*11 300	*5200	*5200	*3600	*3600	*2100	*2100	*1950	1900	7040
1500 mm	kg	*4450	*4450	*6000	*6000	*4250	3550	*2350	2350	*2050	1800	7210
0 mm	kg	*3850	*3850	*6200	5950	5300	3300	*2700	2250	*2200	1800	7060
-1500 mm	kg	*5900	*5900	*6900	5900	*5100	3250	*3150	2200	*2600	2000	6570
-3000 mm	kg	*11 050	*11 050	*5450	*5450	*3450	3300			*2850	2600	5390



ISO 10567



*Indicates that the load is limited by hydraulic lifting capacity rather than tipping load. The above loads are in compliance with hydraulic excavator lift capacity standard ISO 10567:2007. They do not exceed 87% of hydraulic lifting capacity or 75% of tipping load. Weight of all lifting accessories must be deducted from the above lifting capacities. Lifting capacities are based on the machine standing on a firm, uniform supporting surface. The use of a work tool attachment point to handle/lift objects, could affect the machine lift performance.

VA cylinder is flexible.

Lift capacity stays with ±5% for all available track shoes.









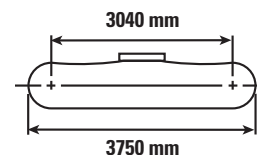
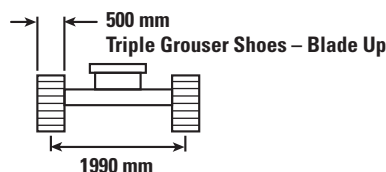
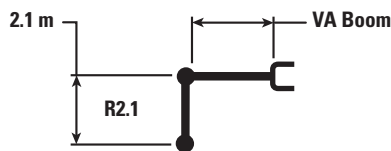

Always refer to the appropriate Operation and Maintenance Manual for specific product information.

313F L Hydraulic Excavator Specifications

Variable Angle Boom Lift Capacities – Counterweight: 2.2 mt – with Bucket Linkages, without Bucket

Long Undercarriage



Reach (mm)	Unit	1500 mm		3000 mm		4500 mm		6000 mm				mm
												
7500 mm	kg									*3700	*3700	3000
6000 mm	kg			*5300	*5300	*2700	*2700			*2700	*2700	5040
4500 mm	kg			*5300	*5300	*2500	*2500	*2500	*2500	*2450	2400	6090
3000 mm	kg	*11 000	*11 000	*5100	*5100	*3850	3750	*2550	2450	*2400	2050	6650
1500 mm	kg			*6800	6200	*4550	3450	*2850	2300	*2500	1900	6830
0 mm	kg	*5050	*5050	*5550	*5550	5250	3250	*3300	2250	*2750	1950	6670
-1500 mm	kg	*7500	*7500	*6050	5900	*4750	3250	*3150	2200	*2850	2150	6150
-3000 mm	kg	*11 900	*11 900	*5400	*5400	*3500	3350			*3350	3200	4660



ISO 10567



*Indicates that the load is limited by hydraulic lifting capacity rather than tipping load. The above loads are in compliance with hydraulic excavator lift capacity standard ISO 10567:2007. They do not exceed 87% of hydraulic lifting capacity or 75% of tipping load. Weight of all lifting accessories must be deducted from the above lifting capacities. Lifting capacities are based on the machine standing on a firm, uniform supporting surface. The use of a work tool attachment point to handle/lift objects, could affect the machine lift performance.

VA cylinder is flexible.

Lift capacity stays with ±5% for all available track shoes.

Always refer to the appropriate Operation and Maintenance Manual for specific product information.

313F L Hydraulic Excavator Specifications

Reach Boom Lift Capacities – Counterweight: 2.2 mt – with Bucket Linkages, without Bucket

Standard Undercarriage

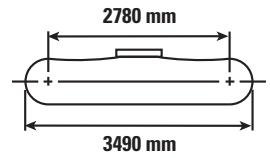
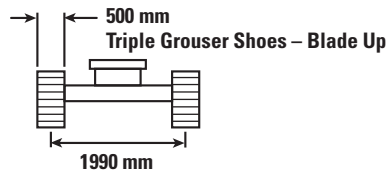
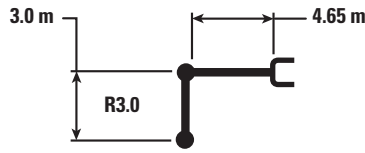

Reach (mm)	Unit	1500 mm		3000 mm		4500 mm		6000 mm		7500 mm		mm		
		Diagram 1	Diagram 2	Diagram 1	Diagram 2	Diagram 1	Diagram 2	Diagram 1	Diagram 2	Diagram 1	Diagram 2	Diagram 1	Diagram 2	
7500 mm	kg											*2550	*2550	4370
6000 mm	kg											*2100	*2100	5950
4500 mm	kg							*3150	2450			*2000	1950	6860
3000 mm	kg					*3850	3650	3250	2350			*2000	1700	7360
1500 mm	kg			*7550	6200	4850	3400	3150	2250	*2150	1600	*2050	1600	7520
0 mm	kg			*7850	5750	4600	3200	3050	2150			2250	1600	7380
-1500 mm	kg	*4500	*4500	8850	5650	4500	3100	2950	2100			2450	1750	6910
-3000 mm	kg	*7500	*7500	*8550	5700	4500	3100	3000	2100			2950	2100	6040
-4500 mm	kg			*6450	5900	*4050	3250					*4000	3200	4530



ISO 10567



*Indicates that the load is limited by hydraulic lifting capacity rather than tipping load. The above loads are in compliance with hydraulic excavator lift capacity standard ISO 10567:2007. They do not exceed 87% of hydraulic lifting capacity or 75% of tipping load. Weight of all lifting accessories must be deducted from the above lifting capacities. Lifting capacities are based on the machine standing on a firm, uniform supporting surface. The use of a work tool attachment point to handle/lift objects, could affect the machine lift performance.

Lift capacity stays with ±5% for all available track shoes.

Always refer to the appropriate Operation and Maintenance Manual for specific product information.

313F L Hydraulic Excavator Specifications

Reach Boom Lift Capacities – Counterweight: 2.2 mt – with Bucket Linkages, without Bucket

Standard Undercarriage

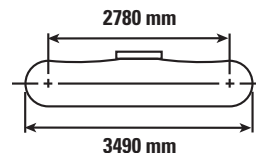
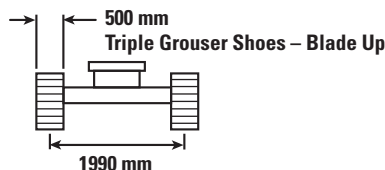
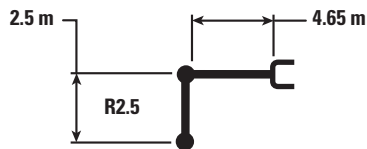

Reach (mm)	Unit	1500 mm		3000 mm		4500 mm		6000 mm		mm		
6000 mm	kg					*3350	*3350			*2450	*2450	5380
4500 mm	kg					*3550	*3550	3300	2400	*2250	2200	6370
3000 mm	kg			*5850	*5850	*4350	3650	3250	2350	*2250	1900	6900
1500 mm	kg			*8450	6100	4800	3400	3150	2250	*2350	1750	7080
0 mm	kg			*6900	5800	4650	3200	3050	2200	2500	1800	6930
-1500 mm	kg	*4850	*4850	8950	5750	4550	3150	3000	2150	2750	1950	6430
-3000 mm	kg	*8750	*8750	*8050	5850	4600	3200			3500	2500	5480



ISO 10567



*Indicates that the load is limited by hydraulic lifting capacity rather than tipping load. The above loads are in compliance with hydraulic excavator lift capacity standard ISO 10567:2007. They do not exceed 87% of hydraulic lifting capacity or 75% of tipping load. Weight of all lifting accessories must be deducted from the above lifting capacities. Lifting capacities are based on the machine standing on a firm, uniform supporting surface. The use of a work tool attachment point to handle/lift objects, could affect the machine lift performance.

Lift capacity stays with ±5% for all available track shoes.

Always refer to the appropriate Operation and Maintenance Manual for specific product information.

313F L Hydraulic Excavator Specifications

Reach Boom Lift Capacities – Counterweight: 2.2 mt – with Bucket Linkages, without Bucket

Standard Undercarriage

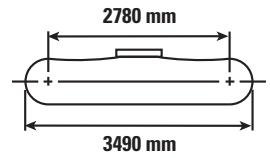
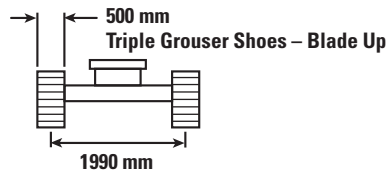
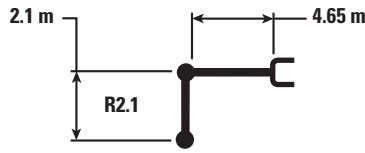

Reach (mm)	Unit	1500 mm		3000 mm		4500 mm		6000 mm		mm		
		Diagram 1	Diagram 2	Diagram 1	Diagram 2	Diagram 1	Diagram 2	Diagram 1	Diagram 2	Diagram 1	Diagram 2	
6000 mm	kg					*3800	3800			*3000	*3000	4870
4500 mm	kg					*3900	3750			*2750	2400	5950
3000 mm	kg			*6550	6550	*4650	3550	3200	2300	*2700	2050	6520
1500 mm	kg					4750	3350	3100	2250	2650	1900	6700
0 mm	kg			*6250	5700	4600	3200	3050	2150	2700	1950	6550
-1500 mm	kg	*5300	*5300	*8900	5700	4550	3150	3050	2150	3050	2150	6010
-3000 mm	kg			*7450	5850	4600	3200			4000	2850	4980



ISO 10567



*Indicates that the load is limited by hydraulic lifting capacity rather than tipping load. The above loads are in compliance with hydraulic excavator lift capacity standard ISO 10567:2007. They do not exceed 87% of hydraulic lifting capacity or 75% of tipping load. Weight of all lifting accessories must be deducted from the above lifting capacities. Lifting capacities are based on the machine standing on a firm, uniform supporting surface. The use of a work tool attachment point to handle/lift objects, could affect the machine lift performance.

Lift capacity stays with $\pm 5\%$ for all available track shoes.

Always refer to the appropriate Operation and Maintenance Manual for specific product information.

313F L Hydraulic Excavator Specifications

Work Tool Offering Guide* – Europe

Boom Type	Reach Boom			Variable Angle Boom	
Stick Size	R3.0 m	R2.5 m	R2.1 m	R2.5 m	R2.1 m
Hydraulic Hammer	H110Es H115Es	H110Es H115Es	H110Es H115Es	H110Es H115Es***	H110Es H115Es***
Demolition and Sorting Grapple	G310B (pin-on only)	G310B	G310B		
Mobile Scrap and Demolition Shear	S320B**	S320B**	S320B**	S320B**	S320B**
Compactor (Vibratory Plate)	CVP75	CVP75	CVP75	CVP75	CVP75
Contractors' Grapple	G112B	G112B	G112B	G112B	G112B
Orange Peel Grapple					
Trash Grapple					
Center-Lock™ Pin Grabber Coupler					
Dedicated Quick Coupler					

These work tools are available for the 313F L.
Consult your Cat dealer for proper match.

*Matches are dependent on excavator configurations. Consult your Cat dealer for proper work tool match.

**Boom mount.

***Pin-on or CW coupler.

Work Tool Offering Guide* – Australia/New Zealand

Boom Type	Reach Boom	
Stick Size	R3.0 m	R2.5 m
Hydraulic Hammer	H95Es H110Es H115Es	H95Es H110Es H115Es
Demolition & Sorting Grapple	G310B***#	G310B***##
Mobile Scrap and Demolition Shear	S320B##	S320B##
Compactor (Vibratory Plate)	CVP75	CVP75
Contractors' Grapple	G112B	G112B
Orange Peel Grapple		
Trash Grapple		
Thumbs		
Rakes		
Center-Lock Pin Grabber Coupler		
Dedicated Quick Coupler		

These work tools are available for the 313F L.
Consult your Cat dealer for proper match.

*Offerings not available in all areas. Matches are dependent on excavator configurations. Consult your Cat dealer to determine what is offered in your area and for proper work tool match.

**Pin-on or CW coupler.

***Pin-on only.

#Over the front only.

##Boom mount.

###Over the front only with CW coupler.

313F L Hydraulic Excavator Specifications

Bucket Specifications and Compatibility – Europe

	Width	Capacity	Weight	Fill	Reach Boom			VA Boom	
	mm	m ³	kg	%	R3.0 m	R2.5 m	R2.1 m	R2.5 m	R2.1 m
Without Quick Coupler									
General Duty (GD)	600	0.31	315	100%	●	●	●	●	●
	750	0.41	362	100%	●	●	●	●	●
	900	0.53	411	100%	●	●	●	●	●
	1000	0.60	436	100%	●	●	●	●	●
	1100	0.68	470	100%	⊙	●	●	⊙	●
	1200	0.76	499	100%	⊖	⊙	●	⊖	⊙
Heavy Duty (HD)	450	0.20	276	100%	●	●	●	●	●
	1200	0.76	506	100%	⊖	⊙	●	⊖	⊙
Maximum load pin-on (payload + bucket)				kg	1745	1970	2125	1760	1895
With Center-Lock Quick Coupler									
General Duty (GD)	600	0.31	315	100%	●	●	●	●	●
	750	0.41	362	100%	●	●	●	●	●
	900	0.53	411	100%	●	●	●	●	●
	1000	0.60	436	100%	●	●	●	●	●
	1100	0.68	470	100%	⊙	●	●	⊙	●
	1200	0.76	499	100%	⊖	⊙	●	⊖	⊙
Heavy Duty (HD)	450	0.20	276	100%	●	●	●	●	●
	1200	0.76	506	100%	⊖	⊙	●	⊖	⊙
Maximum load with coupler (payload + bucket)				kg	1499	1724	1879	1514	1649

The above loads are in compliance with hydraulic excavator standard EN474, they do not exceed 87% of hydraulic lifting capacity or 75% of tipping capacity with front linkage fully extended at ground line with bucket curled.

Capacity based on ISO 7451.

Bucket weight with Long tips.

Maximum Material Density:

- 2100 kg/m³
- ⊙ 1800 kg/m³
- ⊖ 1500 kg/m³

Caterpillar recommends using appropriate work tools to maximize the value customers receive from our products. Use of work tools, including buckets, which are outside of Caterpillar's recommendations or specifications for weight, dimensions, flows, pressures, etc. may result in less-than-optimal performance, including but not limited to reductions in production, stability, reliability, and component durability. Improper use of a work tool resulting in sweeping, prying, twisting and/or catching of heavy loads will reduce the life of the boom and stick.

313F L Hydraulic Excavator Specifications

Bucket Specifications and Compatibility – Europe

	Width	Capacity	Weight	Fill	Reach Boom			VA Boom	
	mm	m ³	kg	%	R3.0 m	R2.5 m	R2.1 m	R2.5 m	R2.1 m
With Quick Coupler (CW20/CW20s)									
General Duty (GD)	450	0.20	300	100%	●	●	●	●	●
	500	0.24	309	100%	●	●	●	●	●
	600	0.31	328	100%	●	●	●	●	●
	750	0.41	374	100%	●	●	●	●	●
	900	0.53	423	100%	●	●	●	●	●
	1000	0.60	452	100%	⊙	●	●	⊙	●
	1100	0.68	482	100%	⊖	⊙	●	⊖	⊙
	1200	0.76	511	100%	○	⊖	⊙	○	⊖
Heavy Duty (HD)	500	0.24	319	100%	●	●	●	●	●
	1200	0.76	511	100%	○	⊖	⊙	○	⊖
Maximum load with coupler (payload + bucket)				kg	1534	1759	1914	1549	1684

Bucket Specifications and Compatibility – Australia/New Zealand

	Width	Capacity	Weight	Fill	313F		313F L		
					Reach Boom		Reach Boom		
	mm	m ³	kg	%	R3.0 m	R2.5 m	R3.0 m	R2.5 m	
With Center-Lock Quick Coupler									
General Duty (GD)	450	0.20	235	100%	●	●	●	●	
	500	0.24	285	100%	●	●	●	●	
	600	0.31	308	100%	●	●	●	●	
	750	0.41	355	100%	●	●	●	●	
	900	0.53	404	100%	⊙	●	⊙	●	
	1050	0.65	452	100%	⊖	⊖	⊖	⊙	
	1200	0.76	492	100%	○	○	○	⊖	
Maximum load with coupler (payload + bucket)				kg	1379	1469	1429	1644	

The above loads are in compliance with hydraulic excavator standard EN474, they do not exceed 87% of hydraulic lifting capacity or 75% of tipping capacity with front linkage fully extended at ground line with bucket curled.

Capacity based on ISO 7451.

Bucket weight with Long tips.

Maximum Material Density:

- 2100 kg/m³
- ⊙ 1800 kg/m³
- ⊖ 1500 kg/m³
- 1200 kg/m³

Caterpillar recommends using appropriate work tools to maximize the value customers receive from our products. Use of work tools, including buckets, which are outside of Caterpillar's recommendations or specifications for weight, dimensions, flows, pressures, etc. may result in less-than-optimal performance, including but not limited to reductions in production, stability, reliability, and component durability. Improper use of a work tool resulting in sweeping, prying, twisting and/or catching of heavy loads will reduce the life of the boom and stick.

313F L Standard Equipment

Standard Equipment

Standard equipment may vary. Consult your Cat dealer for details.

ENGINE

- C4.4 ACERT diesel engine
- Biodiesel capable up to B20
- Meets Tier 4 Final and Stage IV emission standards
- 2300 m altitude capability
- Electric priming pump
- Automatic engine speed control
- Economy and high power modes
- Two-speed travel
- Side-by-side cooling system
- Radial seal air filter
- Primary filter with water separator and water separator indicator
- Secondary filter
- Screen filter in fuel line
- Cold weather battery –25° C
- Jump start receptacle
- Engine idle shutdown function

HYDRAULIC SYSTEM

- Regeneration circuit for boom and stick
- Reverse swing dampening valve
- Automatic swing parking brake
- High-performance hydraulic return filter
- Capability of installing HP stackable valve and medium and QC valve
- Capability of installing additional auxiliary pump and circuit
- Capability of installing boom lowering control device and stick lowering check valve
- Fine swing control

CAB

- Seat, high-back air suspension with heater
- Pressurized operator station with positive filtration
- Sliding upper door window (left-hand cab door)
- Glass-breaking safety hammer
- Removable lower windshield with in cab storage bracket
- Coat hook
- Beverage holder
- Literature holder
- Two 12V stereo speakers
- Storage shelf suitable for lunch or toolbox
- Color LCD display with indicators, filter/fluid change, and working hour information
- Adjustable armrest
- Height adjustable joystick consoles
- Neutral lever (lock out) for all controls
- Travel control pedals with removable hand levers
- Capability of installing two additional pedals
- Two power outlets, 10 amp (total)
- Laminated glass front upper window and tempered other windows

UNDERCARRIAGE

- Grease Lubricated Track GLT2, resin seal
- Towing eye on base frame

COUNTERWEIGHT

- 2.2 mt

ELECTRICAL

- Circuit breaker
- Capability to electrically connect a beacon
- Capability of installing electric fuel lifting pump

LIGHTS

- Halogen boom light (left side)
- Time delay function for boom light and cab light
- Exterior lights integrated into storage box

SECURITY

- Cat one key security system
- Door locks
- Cap locks on fuel and hydraulic tanks
- Lockable external tool/storage box
- Signaling/warning horn
- Secondary engine shutoff switch
- Openable skylight for emergency exit
- Rearview camera

TECHNOLOGY

- Product Link

Optional Equipment

Optional equipment may vary. Consult your Cat dealer for details.

ENGINE

- Quick drains, engine and hydraulic oil

HYDRAULIC SYSTEM

- Control pattern quick-changer, two way
- Auxiliary hydraulics
- Boom and stick lines
- High-pressure line
- Medium-pressure line
- Cat quick coupler line – high-pressure capable
- Boom lowering and stick lowering control device
- Cat Bio hydraulic oil
- Electric refueling pumping

CAB

- Seat, high-back air suspension with heater and cooling
- Seat, high-back mechanical suspension (Europe only)
- Windshield wiper, lower with washer
- Air pre-filter
- Left foot switch
- Left pedal
- Straight travel pedal
- Rain protector
- Roll-down sun screen
- AM/FM radio (ANZ only)

UNDERCARRIAGE

- Standard undercarriage (Europe only)
- Long undercarriage
- 500 mm triple grouser shoes
- 500 mm triple grouser shoes (with/without rubber pad)
- 600 mm triple grouser shoes (Long undercarriage only)
- 700 mm triple grouser shoes
- Guard, heavy-duty bottom (ANZ only)
- Guard, standard bottom (Europe only)
- Center track guiding guard
- 2500 mm blade with replaceable cutting edge
- 2600 mm blade with replaceable cutting edge
- 2700 mm blade with replaceable cutting edge
- Swivel guard

FRONT LINKAGE

- Quick coupler
- Bucket linkage, with lifting eyes
- 4.65 m Reach boom
 - 3.0 m stick
 - 2.5 m stick
 - 2.5 m stick with Cat grade control
 - 2.1 m stick
- Variable Angle boom
 - 2.5 m stick
 - 2.1 m stick

LIGHTS

- Working lights, cab mounted with time delay
- HID lights, cab mounted with time delay
- Halogen boom lights (right side)

SECURITY

- FOGS, bolt-on
- Side steel bumper
- Guard rail
- Guard, cab front, mesh
- Guard, vandalism
- Rearview camera

TECHNOLOGY

- Cat Grade Control Depth and Slope

For more complete information on Cat products, dealer services, and industry solutions, visit us on the web at www.cat.com

© 2016 Caterpillar
All rights reserved

Materials and specifications are subject to change without notice. Featured machines in photos may include additional equipment. See your Cat dealer for available options.

CAT, CATERPILLAR, SAFETY.CAT.COM, their respective logos, "Caterpillar Yellow" and the "Power Edge" trade dress, as well as corporate and product identity used herein, are trademarks of Caterpillar and may not be used without permission.

VisionLink is a trademark of Trimble Navigation Limited, registered in the United States and in other countries.

AEHQ7804-01 (05-2016)
Replaces AEHQ7804
(ANZ, EU)

