

311F RR

Hydraulic Excavator



Engine

Engine Model	Cat® C3.4B	
Net Power – SAE J1349	52 kW	70 hp
Gross Power – SAE J1995	55 kW	74 hp

Drive

Maximum Travel Speed	5.4 km/h	3.4 mph
Maximum Drawbar Pull	114 kN	25,700 lbf

Weight

Minimum Operating Weight	12 400 kg	27,300 lb
Maximum Operating Weight	13 900 kg	30,600 lb

Introduction

Get your work done with a lot less fuel.

If you want a machine with the power to match your jobs but owning and operating costs to fit your business, then the Cat 311F RR excavator is your answer. Its reduced radius will get you into some pretty tight spots, and its reasonable price and miserly fuel burn will help you operate on a tight budget.

The machine's C3.4B engine meets U.S. EPA Tier 4 Final emissions standards and comes equipped with fuel savers like engine idle shutdown and eco mode to help you manage consumption. It also comes with an extremely quiet and comfortable cab to help you stay productive all day long.

Whether you are truck loading or stockpiling, trenching or digging, leveling or grading, you will be pleased with the reliable, fuel-saving performance you will get from the all-new Cat 311F RR.

Contents

Reduced Radius	4
Engine	5
Hydraulics	6
Structures and Undercarriage	7
Operator Station.....	8
Front Linkage	10
Integrated Technologies.....	11
Attachments.....	12
Safety	14
Serviceability	15
Complete Customer Care.....	16
Sustainability	17
Specifications.....	18
Standard Equipment.....	29
Optional Equipment.....	30





The Cat 311F RR delivers fuel savings and performance – two attributes you need to be successful in your business.

Reduced Radius

The right choice for your space-restricted work



Tight Job, Right Machine

With more and more jobs requiring work in tight spaces, a reduced radius machine is the right choice for you. The 311F RR's tail swing radius is just 1750 mm (5'9"). When rotated 90 degrees and working over the side, only 505 mm (1'8") hangs over the side – ideal when you are working up against a wall, on a narrow road, or other space-restricted area.

Stable Platform

The 311F RR offers a stable platform for all applications. One of the main contributors is the 2.45 mt (5,400 lb) counterweight. This allows the shorter 311F RR to perform like a longer tail swing machine.

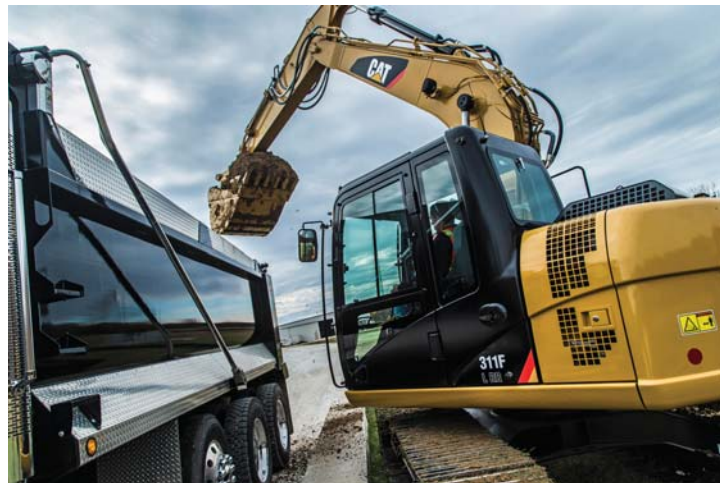

Comfortable Full-Size Cab

While the length of the upper structure is reduced to accommodate the work at hand, the cab of the 311F RR is not. It's the same size as our standard machines with all the amenities you've come to expect.

Engine

Powerful and fuel efficient to meet your expectations

A Unique Emissions Solution

The Cat C3.4B engine meets U.S. EPA Tier 4 Final emission standards. It provides plenty of power for the utility work you do and won't consume a lot of fuel to do it – all to help keep your owning and operating costs to an absolute minimum.

Fuel-Saving Features

One built-in fuel-saving feature is engine idle shutdown, which automatically turns the engine off when it's been idling for more than a specified amount of time. You can also choose eco mode to more actively manage fuel consumption for the job at hand. Both will help you save fuel, reduce emissions, and extend your service intervals.

Biodiesel Ready

The C3.4B engine can run on up to B20 biodiesel fuel that meets ASTM 6751 standards – all to give you more potential fuel-saving flexibility.



Proven Technology

Every U.S. EPA Tier 4 Final ACERT™ engine is equipped with a combination of proven electronic, fuel, air, and aftertreatment components. Applying proven technologies lets us meet your high expectations for productivity, fuel efficiency, reliability, and service life. The right technologies fine tuned for the right applications results in:

- **High performance** across a variety of applications
- **Maximized uptime and reduced cost** with world-class support from the Cat dealer network
- **Minimized impact** of emission systems – designed to be transparent to the operator without requiring interaction
- **Durable** designs with long life to overhaul
- **Better fuel economy** with minimized maintenance costs while providing the same great power and response

More Powerful, Reliable Engine Electronics

The electronics used in Cat Tier 4 Final engines are more powerful and robust than ever. Enhanced features increase quality and reliability, which improves your owning and operating experience.

Next Generation Fuel Systems

As a key component of Cat Tier 4 Technology, injection timing provides more control of combustion for the cleanest, most efficient fuel burn. To maximize your value, Caterpillar engineers specified fuel systems based on the power and performance demands for each engine.

Innovative Air Management

Cat Tier 4 Final engines feature innovative air management systems that optimize airflow and enhance power, efficiency, and reliability. We apply a range of simple, reliable turbo charging solutions based on engine size and application. This allows us to match turbo performance to rated output for high productivity, excellent fuel efficiency, long life, and low operating costs for you.

Hydraulics

Made to move your material with speed and precision

Efficient Design

Major hydraulic components like pumps and valves are located close together to make it possible to use shorter tubes and lines. This design leads to less friction loss in the lines, reduced pressure drops, and more power to the ground for the work you need to get done.

Control Like No Other

Controllability is one of the main attributes of Cat excavators, and one of the key contributors to this is the main control valve. The valve opens slowly when your range of joystick lever movement is small and opens rapidly when movement is high. It puts flow where you need it when you need it, which leads to smoother operation, greater efficiency, and lower fuel consumption.

Auxiliary Hydraulics for Added Versatility

Auxiliary hydraulics give you greater tool versatility so you can take on more work with just one machine, and there are several options from which you can choose. A quick coupler circuit, for example, will allow you to switch from one tool to another in a matter of minutes – all from the comfort and convenience of the cab.

Electric Boom and Stick Regeneration for Added Efficiency

The 311F regenerates the flow of oil from the head end of the boom cylinder to the rod end of the boom cylinder during the work cycle to save energy and improve fuel efficiency. It's optimized for any dial speed setting you select, which results in less pressure loss for higher controllability, more productivity, and lower operating costs. The machine also regenerates the flow of oil from the rod end of the stick cylinder to the head end of the stick cylinder during operation to increase speed.





Structures and Undercarriage

Built to work in your tough utility applications

Robust Frames

The 311F is a well-built machine that's designed to give you a long service life. The upper frame includes special mountings made specifically to support the heavy-duty cab; the lower frame is reinforced to enhance component durability so you can count on the machine doing the work you need done.

Durable Undercarriage

Long undercarriage is standard and works extremely well in various work applications and conditions. Track shoes, links, rollers, idlers, and final drives are all built with high-tensile-strength steel for long-term durability.

Great Weight

The available 2.45 mt (5,400 lb) counterweight has a surface that matches the 311F RR's overall sleek appearance. It provides plenty of balance for your heavy lifting and is bolted directly to the main frame to ensure rigidity. It also has an integrated housing to protect the optional rearview camera.



Operator Station

Comfort and convenience to keep you productive



A Safe and Quiet Cab

The Roll-Over Protective Structure (ROPS) certified cab is not only a safety feature, but it is also a sound suppressor due to its special sealing and insulation. With the door and windows closed, you will experience a machine that's as quiet as the truck you drive to work.

A Cool (and Warm) Environment

The automatic climate control system features multiple air outlets with filtered ventilation. Air flows on the floor, behind the seat, and in front of you to make your work in either hot or cold weather much more pleasant and productive.

Comfortable Seat Options

The seat range includes air suspension, heated, and cooled options. All seats include a reclining back, upper and lower slide adjustments, and height and tilt angle adjustments to meet your needs for maximum comfort.



Controls Just for You

The right and left joystick consoles can be adjusted to improve your comfort and productivity during the course of a day. Also, the right joystick features a button that will reduce engine speed when you are not working to help save fuel. Touch it once and speed reduces; touch it again and speed increases for normal operation.



An Easy-to-Use Monitor

The LCD monitor is easy to see and navigate. Programmable in up to 42 languages to meet today's diverse workforce, the monitor clearly displays critical information you need to operate efficiently. Plus it projects the image from the optional rearview camera to help you see what's going on around you so you can stay safely focused on the job.



Ample Storage and Auxiliary Power

Storage spaces are located in the front, rear, and side consoles of the cab. A drink holder accommodates a large mug with handle, and a shelf behind the seat stores large lunch or toolboxes. Power supply sockets are conveniently located near the key storage areas for charging your electronic devices like an MP3 player, a cell phone, or a tablet.





Front Linkage

Take on your far-reaching or up-close tasks

Boom and Stick

The 311F RR is offered with a 4.3 m (14'1") reach boom and a R2.8 m (9'2") stick. This configuration offers you excellent all-around versatility and a large working envelope.

Built to Last

All Cat booms and sticks are built with internal baffle plates for added durability, and all undergo ultrasound inspection to ensure weld quality and reliability. Large box-section structures with thick multi-plate fabrications, castings, and forgings are used in high-stress areas such as the boom nose, boom foot, boom cylinder, and stick foot to improve durability. Also, the front linkage pins' inner bearing surfaces are welded with a self-lubricated bearing used to extend service intervals and increase uptime.



Integrated Technologies

Monitor, manage, and enhance your job site operations



Cat Connect makes smart use of technology and services to improve your job site efficiency. Using the data from technology-equipped machines, you'll get more information and insight into your equipment and operations than ever before.

Cat Connect technologies offer improvements in these key areas:



EQUIPMENT
MANAGEMENT

Equipment Management – increase uptime and reduce operating costs.



PRODUCTIVITY

Productivity – monitor production and manage job site efficiency.



SAFETY

Safety – enhance job site awareness to keep your people and equipment safe.



Featured Cat Connect technologies include:

Link

Link technologies provide wireless capability to machines to enable two-way transfer of information collected by on-board sensors, control modules, and other Cat Connect technologies using off-board apps such as our VisionLink® software.

Manage Your Machine Remotely

Cat Product Link™ is an optional system that is deeply integrated into the machine monitoring system to take the guesswork out of managing your equipment. The system tracks location, hours, fuel usage, productivity, idle time, and diagnostic codes through the online VisionLink interface to help you maximize efficiency, improve productivity, and lower operating costs. Manage the data yourself or get expert advice from your Cat dealer to keep your equipment operating at peak performance.

CAT® CONNECT



EQUIPMENT
MANAGEMENT



PRODUCTIVITY



SAFETY



SUSTAINABILITY

Attachments

Tools to make you productive and profitable



Get the Most Out of One Machine

The 311F RR is a highly versatile machine that packs a lot of performance into a small package. You can easily expand that performance by utilizing any of the variety of attachments offered by Cat Work Tools.

Change Jobs Quickly

A quick coupler brings the ability to quickly change attachments and switch from job to job. The Cat Pin Grabber coupler is the secure way to decrease downtime and increase job site flexibility and overall productivity.

Dig, Finish and Compact

A wide range of buckets dig everything from top soil to highly abrasive material. For finishing and grading work, compact and shallow ditch cleaning buckets fit the need. A Cat compactor prepares the area for the next phase of construction.

Break, Demolish and Scrap

A hydraulic hammer equips the 311F for breaking sidewalks, driveways, and pavement. A shear allows you to cut metal down to size for recycling or transport.

Move and Handle All Sorts of Material

Choose a thumb to work with your bucket and gain the instant ability to move and handle brush, rocks, and debris at your construction site. When your job requires constant material handling, a grapple may be your solution. Choose from three different grapple styles for loading, sorting and picking – whether it be trash, demolition debris or recyclables.

Set Up Your Machine for Maximum Profitability

Your Cat dealer can install hydraulic kits to properly operate all Cat Work Tool attachments – maximizing the machine's uptime and your profits.

GRAB, SORT, LOAD



Pro Series Hydraulic Thumbs



Stiff Link Thumbs



Contractors' Grapples



Trash Grapples

SWAP TOOLS



Center-Lock™ Pin Grabber Coupler

DIG & PACK



Ditch Cleaning and Tilt Buckets



General Duty Buckets



Heavy Duty Buckets



Severe Duty Buckets



Vibratory Plate Compactors

CUT, CRUSH, BREAK & RIP



Multi-Processors



Scrap & Demolition Shears



Secondary Pulverizers



Hydraulic Hammers



Rippers

Safety

Features to help protect you day in and day out

A Safe and Quiet Cab

You will benefit from the enhanced protection of a ROPS-certified cab. Not only is it safe, but its special roof lining and sealing make the sound inside comparable to any of today's top pickup trucks. In fact, it's so quiet you won't believe the machine is running.

Secure Contact Points

Your slipping hazards are reduced with anti-skid plates on the surface of the upper structure and the top of the storage box area. The plates are effective in all types of weather conditions, and they can be removed for cleaning. Large steps as well as hand rails allow you to confidently and safely work with the machine. Steps on the track frame will get you into the cab as well as a leg up to the compartments. Extended hand rails allow you to safely climb to the upper deck. An additional hand rail above the air cleaner compartment gives you a holding point while standing on the track.

Great Visibility

Ample glass gives you excellent visibility out front and to the side, and the available rearview camera gives you a clear field of view behind the machine through the cab monitor. The split-configuration windshield features an upper window with handles that make it easy to slide and store above you and a lower window that can be removed and stored on the inside wall of the cab. The large skylight provides you with enhanced visibility and also serves as an emergency exit. Halogen lights provide plenty of illumination and can be programmed to stay on for up to 90 seconds after the engine has been turned off to help you safely exit the machine.

A Worthwhile Guard Option

Easy-to-install front and door window vandal guards are available to help protect your machine from unwanted attention. They conveniently store in the lockable box that serves as an anti-skid step up to the engine platform.



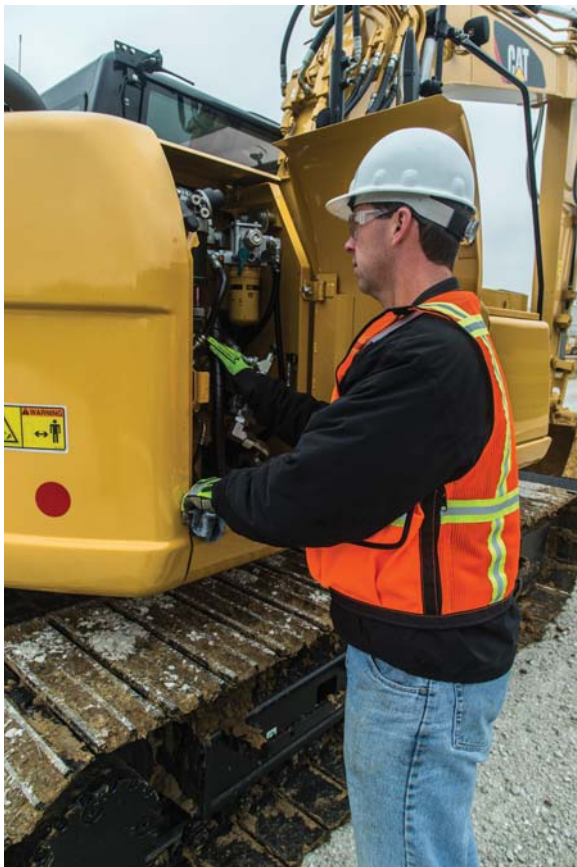

Serviceability

Designed to make your maintenance quick and easy

Ground-Level Access Built In

You can easily reach most routine maintenance items like fluid taps and grease points from the safety and convenience of ground level. Not only do compartments feature wide service doors designed to help prevent debris entry, but they also securely latch in place to help make your service work simpler.

A Cool Design

The unique cooling package includes a screen between the radiator and AC condenser to prevent plugging. In addition, wider clearance is provided between the radiator and AC condenser to help make blowing off debris easy for you, which can help improve your machine's reliability and performance in high ambient conditions.

A Fresh Idea

When you select ventilation inside the cab, outside air enters through the fresh air filter. The filter is conveniently located on the side of the cab to make it easy to reach and replace, and it is protected by a lockable door that can be opened with the engine key.

Other Service Benefits

The fuel tank's drain cock makes it easy and simple for you to remove water and sediment during routine maintenance. Plus an integrated fuel level indicator pops up to help you reduce the possibility of fuel tank overfilling.

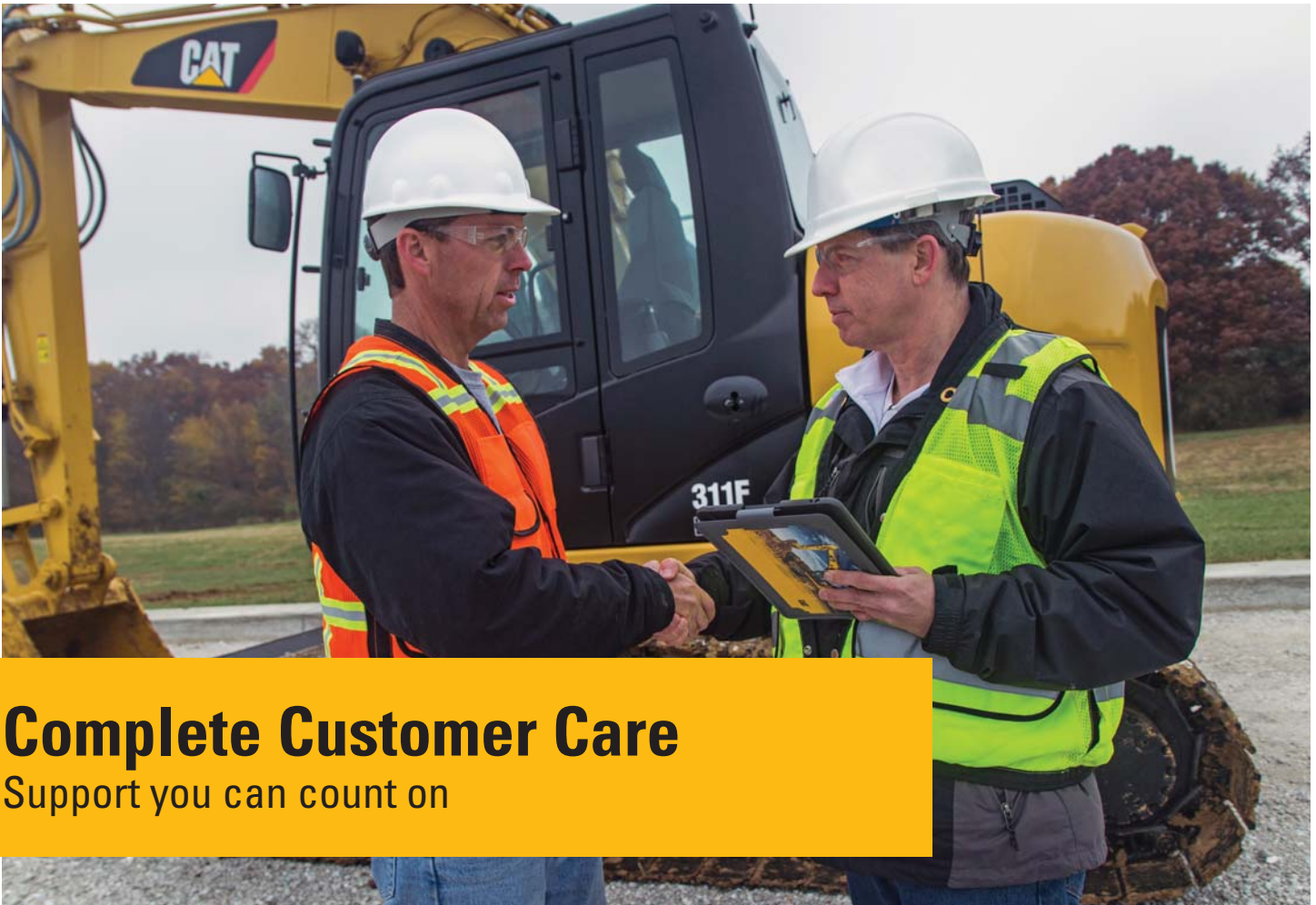

Complete Customer Care

Support you can count on

Worldwide Parts Availability

Cat dealers utilize a worldwide parts network to maximize your machines' uptime. Plus they can help you save money with Cat remanufactured components.

Advice You Can Trust

What are the job requirements and machine attachments? What production is needed? Your Cat dealer can provide recommendations to help you make the right machine choices.

Financial Options Just for You

Consider financing options and day-to-day operating costs. Look at dealer services that can be included in the machine's cost to yield lower owning and operating costs over time.

Support Agreements to Fit Your Needs

Cat dealers offer a variety of customer support agreements and work with you to develop a plan to meet your specific needs. These plans can cover the entire machine, including attachments, to help protect your investment.

Operating Techniques to Boost Your Profits

Improving operating techniques can boost your profits. Your Cat dealer has videos, literature, and other ideas to help you increase productivity. Caterpillar also offers simulators and certified operator training to help maximize the return on your investment.

What's Best for You Today...and Tomorrow

Repair, rebuild, or replace? Your Cat dealer can help you evaluate the cost involved so you can make the best choice for your business.



Sustainability

Generations ahead in every way

- The C3.4B engine meets U.S. EPA Tier 4 Final emission standards.
- The 311F RR performs a similar amount of work while burning less fuel than the previous D Series model. This means more efficiency, less resources consumed, and fewer emissions.
- The 311F has the flexibility of running on either ultra-low-sulfur diesel (ULSD) fuel with 15 ppm of sulfur or less or biodiesel (B20) fuel blended with ULSD that meets ASTM 6751 standards.
- An overfill indicator rises when the fuel tank is full to help service technicians avoid spilling.
- The 311F RR is built to be rebuilt with major structures and components capable of being remanufactured to reduce waste and replacement costs.
- An efficient engine oil filter eliminates the need for painted metal cans and aluminum top plates. The cartridge-style spin-on housing enables the internal filter to be separated and replaced; the used internal element can be incinerated to help reduce waste.
- The 311F is an efficient, productive machine that's designed to conserve our natural resources for the generations ahead.

311F RR Hydraulic Excavator Specifications

Engine

Gross Power – SAE J1995	55 kW	74 hp
Net Power – SAE J1349	52 kW	70 hp
Bore	99 mm	3.90 in
Stroke	110 mm	4.33 in
Displacement	3.4 L	207 in ³

Hydraulic System

Main System – Maximum Flow (Total)	125 × 2 L/min	33 × 2 gal/min
Maximum Pressure – Equipment	30.5 MPa	4,424 psi
Maximum Pressure – Travel	35 MPa	5,076 psi
Maximum Pressure – Swing	23 MPa	3,336 psi
Pilot System – Maximum Flow	21.9 L/min	1,336 in ³ /min
Pilot System – Maximum Pressure	4120 kPa	598 psi
Boom Cylinder – Bore	100 mm	4 in
Boom Cylinder – Stroke	1002 mm	39 in
Stick Cylinder – Bore	110 mm	4 in
Stick Cylinder – Stroke	1194 mm	47 in
Bucket Cylinder – Bore	100 mm	4 in
Bucket Cylinder – Stroke	939 mm	37 in

Drive

Maximum Travel Speed – High	5.4 km/h	3.4 mph
Maximum Travel Speed – Low	3.6 km/h	2.2 mph
Maximum Drawbar Pull	114.3 kN	25,696 lb

Swing

Swing Speed	10 rpm	10 rpm
Swing Torque	30.9 kN·m	22,791 lbf-ft

Service Refill Capacities

Fuel Tank Capacity	210 L	55.48 gal
Cooling System	18 L	4.76 gal
Engine Oil (with filter)	8 L	2.1 gal
Swing Drive (each)	3 L	0.79 gal
Final Drive (each)	3 L	0.79 gal
Hydraulic System (including tank)	160 L	42.3 gal
Hydraulic Tank	95 L	25.1 gal

Track

Number of Shoes (each side)	43 pieces	43 pieces
Number of Track Rollers (each side)	6 pieces	6 pieces
Number of Carrier Rollers (each side)	1 piece	1 piece

Sound

ISO 6396		
Operator Noise (Closed)	72 dB(A)	72 dB(A)
ISO 6395		
Spectator Noise	99 dB(A)	99 dB(A)

311F RR Hydraulic Excavator Specifications

Dimensions

All dimensions are approximate.

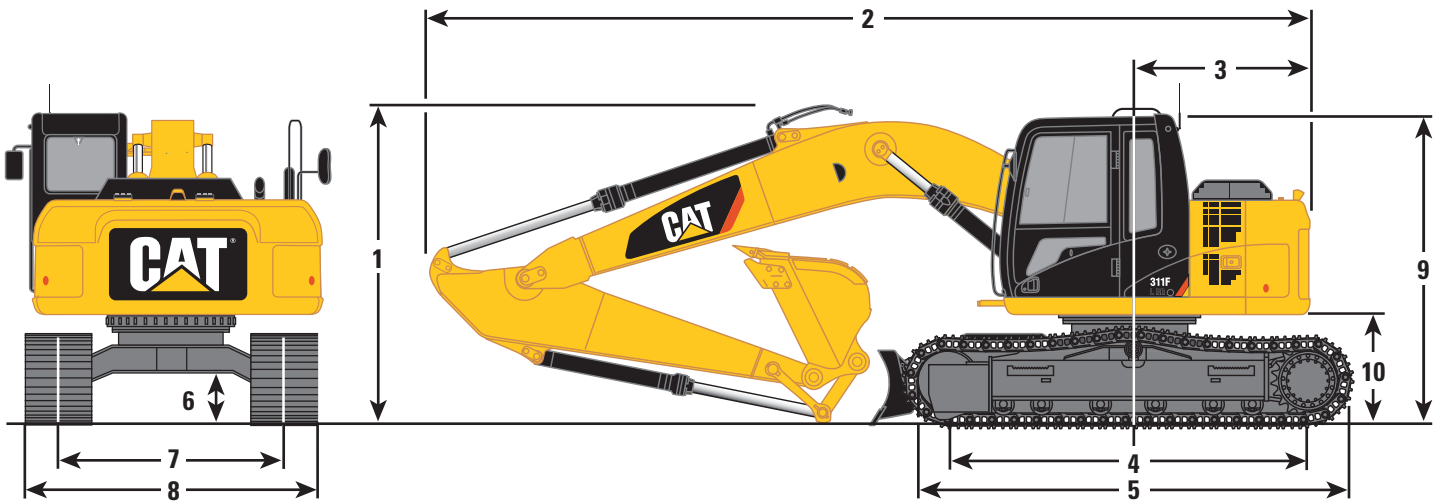

Reach Boom
4.3 m (14'1")

R2.8 m
(9'2")

Stick			
1 Shipping Height*	2820 mm		9'3"
Shipping Height at Boom Top	2760 mm		9'1"
Handrail Height	2820 mm		9'3"
2 Shipping Length			
Long Undercarriage	6910 mm		22'8"
Long Undercarriage with Blade	7530 mm		24'8"
3 Tail Swing Radius	1750 mm		5'9"
4 Length to Center of Rollers	2780 mm		9'1"
5 Track Length	3490 mm		11'5"
6 Ground Clearance	440 mm		1'5"
7 Track Gauge	1990 mm		6'6"
8 Transport Width			
500 mm (20") Shoes	2490 mm		8'2"
600 mm (24") Shoes	2590 mm		8'6"
700 mm (28") Shoes	2690 mm		8'10"
770 mm (30") Shoes	2760 mm		9'1"
9 Cab Height	2760 mm		9'1"
Cab Height with Top Guard	2900 mm		9'6"
10 Counterweight Clearance**	910 mm		3'0"
Bucket			
Ref.	Type		GD
	Capacity	0.53 m ³	0.69 yd ³
	Tip Radius	1200 mm	3'11"

Notes: All dimensions based on bucket A (see table).

*Including shoe lug height.

**Without shoe lug height.

311F RR Hydraulic Excavator Specifications

Working Ranges

All dimensions are approximate.

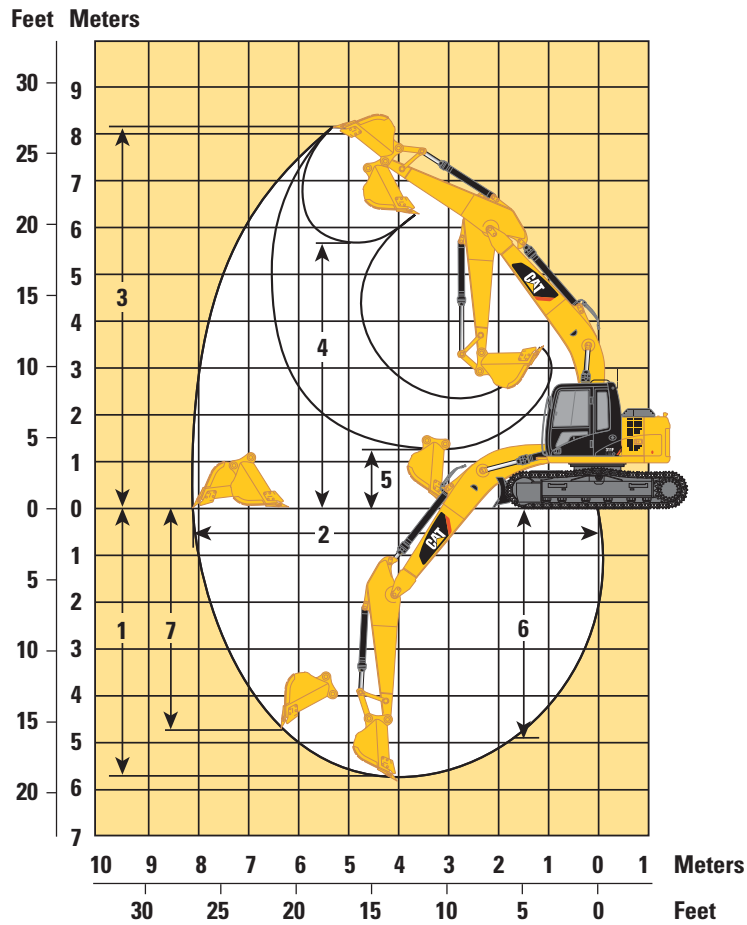

		Reach Boom 4.3 m (14'1")	
		R2.8 m (9'2")	
Stick			
1	Maximum Digging Depth	5590 mm	18'4"
2	Maximum Reach at Ground Level	8100 mm	26'7"
3	Maximum Cutting Height	8140 mm	26'8"
4	Maximum Loading Height	5770 mm	18'11"
5	Minimum Loading Height	1330 mm	4'4"
6	Maximum Depth Cut for 2440 mm (8'0") Level Bottom	4990 mm	16'4"
7	Maximum Vertical Wall Digging Depth	4880 mm	16'0"
Bucket Ref.	Type	GD	
	Capacity	0.53 m ³	0.69 yd ³
	Tip Radius	1200 mm	3'11"

311F RR Hydraulic Excavator Specifications

Blade

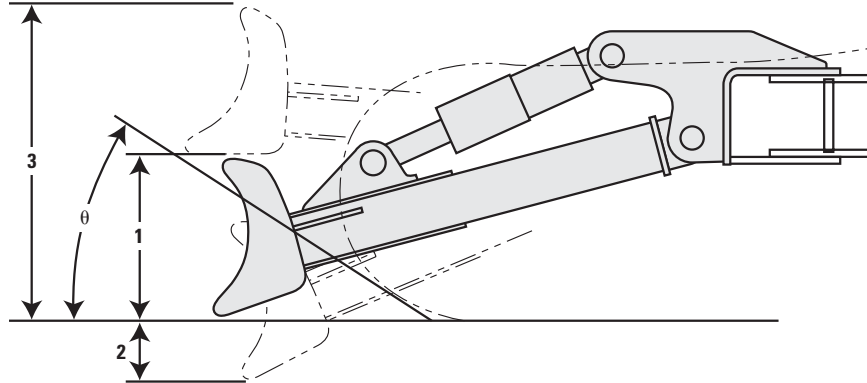

Blade Options	2500 mm (8'2")	2600 mm (8'6")	2700 mm (8'10")
Recommended Track Shoe Width	500 mm (20")	600 mm (24")	700 mm (28")
1 Blade Height		630 mm (2'1")	
2 Maximum Lowering Depth from Ground		570 mm (1'10")	
3 Maximum Raising Height above Ground		1000 mm (3'3")	
Approach Angle		23 degrees	

Major Component Weights

Base Machine (with boom cylinder, without counterweight, front linkage and track)	4050 kg	8,930 lb
Long Undercarriage	2430 kg	5,360 lb
Counterweight (2.45 mt/5,400 lb)	2450 kg	5,400 lb
Boom (includes lines, pins and stick cylinder)		
Reach Boom (4.3 m/14'1")	930 kg	2,050 lb
Stick (includes lines, pins and bucket cylinder)		
R2.8 m (9'2")	610 kg	1,350 lb
Track Shoe (long/per two track)		
500 mm (20") Triple Grouser	1460 kg	3,220 lb
600 mm (24") Triple Grouser	1700 kg	3,750 lb
700 mm (28") Triple Grouser	1960 kg	4,320 lb
770 mm (30") Triple Grouser	2100 kg	4,630 lb
Quick Coupler		
Center Lock with Pin	480 kg	1,060 lb
Blade		
2500 mm (8'2")	810 kg	1,790 lb
2600 mm (8'6")	810 kg	1,790 lb
2700 mm (8'10")	820 kg	1,810 lb

All weights are rounded up to nearest 10 kg and lb. Kg and lb were rounded up separately so some of the kg and lb do not match.

Base machine includes 75 kg (165 lb) operator weight and 90% fuel weight.

311F RR Hydraulic Excavator Specifications

Operating Weights and Ground Pressures

	770 mm (30") Triple Grouser Shoes				700 mm (28") Triple Grouser Shoes				600 mm (24") Triple Grouser Shoes				500 mm (20") Triple Grouser Shoes			
	kg	lb	kPa	psi	kg	lb	kPa	psi	kg	lb	kPa	psi	kg	lb	kPa	psi
Long Undercarriage without Blade																
Reach Boom – 4.65 m (14'1")																
R2.8 m (9'2")	13 100	28,900	27.5	4.0	12 900	28,400	29.8	4.3	12 700	28,000	34.2	5.0	12 500	27,600	40.4	5.9
Long Undercarriage with Blade																
Reach Boom – 4.65 m (14'1")																
R2.8 m (9'2")	13 900	30,600	29.2	4.2	13 800	30,400	31.9	4.6	13 500	29,800	36.4	5.3	13 300	29,300	43.0	6.2









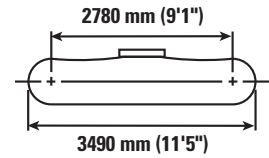
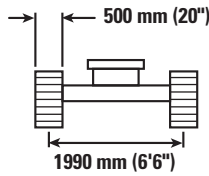
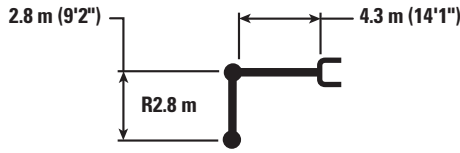

Bucket and Stick Forces

	Reach Boom 4.3 m (14'1")	
	R2.8 m (9'2")	
Pin On		
General Duty		
Bucket Digging Force (SAE)	79 kN	17,900 lb
Stick Digging Force (SAE)	51 kN	11,400 lb
Heavy Duty		
Bucket Digging Force (SAE)	79 kN	17,900 lb
Stick Digging Force (SAE)	51 kN	11,400 lb
Severe Duty		
Bucket Digging Force (SAE)	77 kN	17,300 lb
Stick Digging Force (SAE)	50 kN	11,300 lb

311F RR Hydraulic Excavator Specifications

Reach Boom Lift Capacities – Counterweight: 2.45 mt (5,400 lb) – Blade Down



		1500 mm/60 in		3000 mm/120 in		4500 mm/180 in		6000 mm/240 in				
												mm in
6000 mm 240 in	kg lb									*1650 *3,600	*1650 *3,600	5280 210
4500 mm 180 in	kg lb							*2300 *4,350	*2300 *4,350	*1500 *3,250	*1500 *3,250	6290 250
3000 mm 120 in	kg lb					*3250 *7,050	*3250 *7,050	*2950 *6,450	2300 4,950	*1450 *3,200	*1450 *3,200	6830 270
1500 mm 60 in	kg lb			*6100 *13,150	*6100 *13,150	*4100 *8,800	3400 7,300	*3300 *7,150	2200 4,750	*1550 *3,350	*1550 *3,350	7010 280
0 mm 0 in	kg lb			*7500 *16,150	5900 12,600	*4750 *10,300	3200 6,900	*3600 *7,800	2150 4,600	*1700 *3,700	*1700 *3,700	6850 270
-1500 mm -60 in	kg lb	*4800 *10,700	*4800 *10,700	*7650 *16,550	5750 12,350	*5000 *10,750	3100 6,700	*3600 *7,750	2100 4,500	*2050 *4,500	1950 4,300	6350 250
-3000 mm -120 in	kg lb	*7950 *17,900	*7950 *17,900	*6850 *14,700	5800 12,450	*4500 *9,700	3150 6,750			*2850 *6,400	2450 5,500	5380 210



ISO 10567



*Indicates that the load is limited by hydraulic lifting capacity rather than tipping load. The above loads are in compliance with hydraulic excavator lift capacity standard ISO 10567:2007. They do not exceed 87% of hydraulic lifting capacity or 75% of tipping load. Weight of all lifting accessories must be deducted from the above lifting capacities. Lifting capacities are based on the machine standing on a firm, uniform supporting surface. The use of a work tool attachment point to handle/lift objects, could affect the machine lift performance.









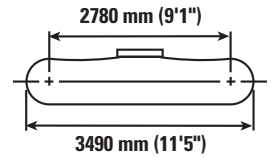
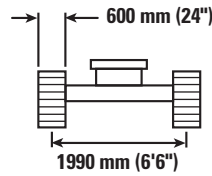
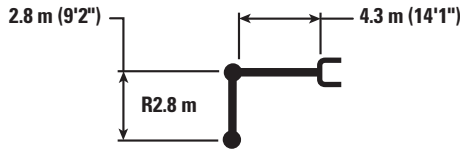

Lift capacity stays with ±5% for all available track shoes.

Always refer to the appropriate Operation and Maintenance Manual for specific product information.

311F RR Hydraulic Excavator Specifications

Reach Boom Lift Capacities – Counterweight: 2.45 mt (5,400 lb) – Blade Down



		1500 mm/60 in		3000 mm/120 in		4500 mm/180 in		6000 mm/240 in				
												mm in
6000 mm 240 in	kg lb									*1650 *3,600	*1650 *3,600	5280 210
4500 mm 180 in	kg lb							*2300 *4,350	*2300 *4,350	*1500 *3,250	*1500 *3,250	6290 250
3000 mm 120 in	kg lb					*3250 *7,050	*3250 *7,050	*2950 *6,450	2400 5,150	*1450 *3,200	*1450 *3,200	6830 270
1500 mm 60 in	kg lb			*6100 *13,150	*6100 *13,150	*4100 *8,800	3550 7,600	*3300 *7,150	2300 4,950	*1550 *3,350	*1550 *3,350	7010 280
0 mm 0 in	kg lb			*7500 *16,150	6150 13,200	*4750 *10,300	3350 7,200	*3600 *7,800	2250 4,800	*1700 *3,700	*1700 *3,700	6850 270
-1500 mm -60 in	kg lb	*4800 *10,700	*4800 *10,700	*7650 *16,550	6050 12,950	*5000 *10,750	3250 7,000	*3600 *7,750	2200 4,700	*2050 *4,500	*2050 *4,500	6350 250
-3000 mm -120 in	kg lb	*7950 *17,900	*7950 *17,900	*6850 *14,700	6100 13,050	*4500 *9,700	3250 7,050			*2850 *6,400	2600 5,700	5380 210



ISO 10567



*Indicates that the load is limited by hydraulic lifting capacity rather than tipping load. The above loads are in compliance with hydraulic excavator lift capacity standard ISO 10567:2007. They do not exceed 87% of hydraulic lifting capacity or 75% of tipping load. Weight of all lifting accessories must be deducted from the above lifting capacities. Lifting capacities are based on the machine standing on a firm, uniform supporting surface. The use of a work tool attachment point to handle/lift objects, could affect the machine lift performance.









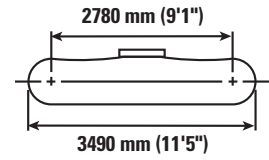
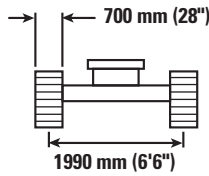
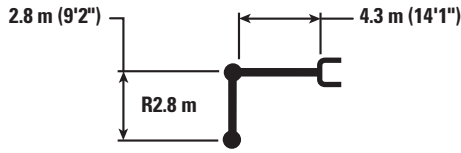

Lift capacity stays with ±5% for all available track shoes.

Always refer to the appropriate Operation and Maintenance Manual for specific product information.

311F RR Hydraulic Excavator Specifications

Reach Boom Lift Capacities – Counterweight: 2.45 mt (5,400 lb) – Blade Down



		1500 mm/60 in		3000 mm/120 in		4500 mm/180 in		6000 mm/240 in				mm in
												
6000 mm 240 in	kg lb									*1650 *3,600	*1650 *3,600	5280 210
4500 mm 180 in	kg lb							*2300 *4,350	*2300 *4,350	*1500 *3,250	*1500 *3,250	6290 250
3000 mm 120 in	kg lb					*3250 *7,050	*3250 *7,050	*2950 *6,450	2500 5,350	*1450 *3,200	*1450 *3,200	6830 270
1500 mm 60 in	kg lb			*6100 *13,150	*6100 *13,150	*4100 *8,800	3700 7,900	*3300 *7,150	2400 5,150	*1550 *3,350	*1550 *3,350	7010 280
0 mm 0 in	kg lb			*7500 *16,150	6450 13,850	*4750 *10,300	3500 7,500	*3600 *7,800	2350 5,000	*1700 *3,700	*1700 *3,700	6850 270
-1500 mm -60 in	kg lb	*4800 *10,700	*4800 *10,700	*7650 *16,550	6350 13,550	*5000 *10,750	3400 7,300	*3600 *7,750	2300 4,900	*2050 *4,500	*2050 *4,500	6350 250
-3000 mm -120 in	kg lb	*7950 *17,900	*7950 *17,900	*6850 *14,700	6400 13,700	*4500 *9,700	3400 7,350			*2850 *6,400	2700 6,000	5380 210



ISO 10567



*Indicates that the load is limited by hydraulic lifting capacity rather than tipping load. The above loads are in compliance with hydraulic excavator lift capacity standard ISO 10567:2007. They do not exceed 87% of hydraulic lifting capacity or 75% of tipping load. Weight of all lifting accessories must be deducted from the above lifting capacities. Lifting capacities are based on the machine standing on a firm, uniform supporting surface. The use of a work tool attachment point to handle/lift objects, could affect the machine lift performance.









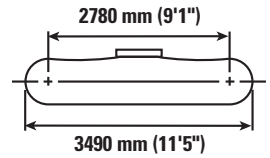
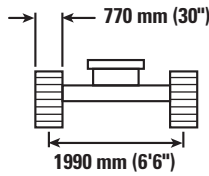
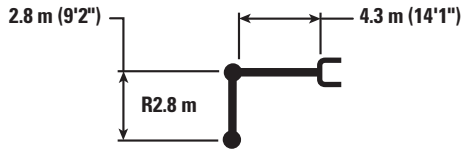

Lift capacity stays with ±5% for all available track shoes.

Always refer to the appropriate Operation and Maintenance Manual for specific product information.

311F RR Hydraulic Excavator Specifications

Reach Boom Lift Capacities – Counterweight: 2.45 mt (5,400 lb) – Blade Down



		1500 mm/60 in		3000 mm/120 in		4500 mm/180 in		6000 mm/240 in				
												mm in
6000 mm 240 in	kg lb									*1650 *3,600	*1650 *3,600	5280 210
4500 mm 180 in	kg lb							*2300 *4,350	*2300 *4,350	*1500 *3,250	*1500 *3,250	6290 250
3000 mm 120 in	kg lb					*3250 *7,050	*3250 *7,050	*2950 *6,450	2500 5,400	*1450 *3,200	*1450 *3,200	6830 270
1500 mm 60 in	kg lb			*6100 *13,150	*6100 *13,150	*4100 *8,800	3700 8,000	*3300 *7,150	2450 5,200	*1550 *3,350	*1550 *3,350	7010 280
0 mm 0 in	kg lb			*7500 *16,150	6500 14,000	*4750 *10,300	3550 7,600	*3600 *7,800	2350 5,050	*1700 *3,700	*1700 *3,700	6850 270
-1500 mm -60 in	kg lb	*4800 *10,700	*4800 *10,700	*7650 *16,550	6400 13,700	*5000 *10,750	3450 7,400	*3600 *7,750	2300 4,950	*2050 *4,500	*2050 *4,500	6350 250
-3000 mm -120 in	kg lb	*7950 *17,900	*7950 *17,900	*6850 *14,700	6450 13,800	*4500 *9,700	3450 7,450			*2850 *6,400	2700 6,050	5380 210



ISO 10567



*Indicates that the load is limited by hydraulic lifting capacity rather than tipping load. The above loads are in compliance with hydraulic excavator lift capacity standard ISO 10567:2007. They do not exceed 87% of hydraulic lifting capacity or 75% of tipping load. Weight of all lifting accessories must be deducted from the above lifting capacities. Lifting capacities are based on the machine standing on a firm, uniform supporting surface. The use of a work tool attachment point to handle/lift objects, could affect the machine lift performance.

Lift capacity stays with ±5% for all available track shoes.

Always refer to the appropriate Operation and Maintenance Manual for specific product information.

311F RR Hydraulic Excavator Specifications

311F L RR Work Tool Offering Guide*

Boom Type	Reach Boom
Stick Size	R2.8 m (9'2")
Hydraulic Hammer	H95Es H110Es**
Demolition and Sorting Grapple	NA
Mobile Scrap and Demolition Shear	NA
Compactor (Vibratory Plate)	CVP75
Contractors' Grapple	G112B
Orange Peel Grapple	
Trash Grapple	
Thumbs	
Rakes	
Center-Lock™ Pin Grabber Coupler	
Dedicated Quick Coupler	

These work tools are available for the 311F L RR.
Consult your Cat dealer for proper match.

*Offerings not available in all areas. Maximum weight limitation for ROPS certification is (14,712 kg/32,440 lb). Matches are dependent on excavator configurations. Consult your Cat dealer to determine what is offered in your area, and, for proper work tool match.

**Pin on only.

311F RR Hydraulic Excavator Specifications

Bucket Specifications and Compatibility

	Width		Capacity		Weight		Fill	Reach Booms – No Blade Installed				Reach Booms – Blade Installed			
	mm	in	m ³	yd ³	kg	lb		500 mm	600 mm	700 mm	770 mm	500 mm	600 mm	700 mm	770 mm
								(20") TG	(24") TG	(28") TG	(30") TG	(20") TG	(24") TG	(28") TG	(30") TG
								2.8 m (9'2")	2.8 m (9'2")	2.8 m (9'2")	2.8 m (9'2")	2.8 m (9'2")	2.8 m (9'2")	2.8 m (9'2")	2.8 m (9'2")
Without Quick Coupler															
General Duty (GD)	450	18	0.20	0.27	276	608	100	●	●	●	●	●	●	●#	●#
	600	24	0.31	0.40	326	719	100	●	●	●	●	●	●	●#	●#
	750	30	0.41	0.54	374	823	100	●	●	●	●	●	●	●#	●#
	900	36	0.53	0.69	423	932	100	●	●	●	●	●	●	●#	●#
	1050	42	0.65	0.84	469	1,034	100	⊖*	⊖*	⊙*	⊙*	⊙*	⊙*#	⊙*#	⊙*#
	1200	48	0.76	1.00	510	1,125	100	○*	○*	⊖*	⊖*	⊖*	⊖*#	⊖*#	⊖*#
Severe Duty (SD)	600	24	0.31	0.40	367	810	90	●	●	●	●	●	●	●#	●#
	750	30	0.41	0.54	425	936	90	●	●	●	●	●	●	●#	●#
	900	36	0.53	0.69	483	1,065	90	●	●	●	●	●	●#	●#	
	1050	42	0.65	0.84	529	1,166	90	⊙	⊙	⊙	⊙	⊙	●#	●#	
Maximum load pin on (payload + bucket)							kg	1538	1574	1612	1634	1656	1693	1734	1755
							lb	3,390	3,469	3,553	3,601	3,650	3,731	3,822	3,868
	Width		Capacity		Weight		Fill	Reach Booms – No Blade Installed				Reach Booms – Blade Installed			
	mm	in	m ³	yd ³	kg	lb		500 mm	600 mm	700 mm	770 mm	500 mm	600 mm	700 mm	770 mm
								(20") TG	(24") TG	(28") TG	(30") TG	(20") TG	(24") TG	(28") TG	(30") TG
								2.8 m (9'2")	2.8 m (9'2")	2.8 m (9'2")	2.8 m (9'2")	2.8 m (9'2")	2.8 m (9'2")	2.8 m (9'2")	2.8 m (9'2")
With Center-Lock Quick Coupler															
General Duty (GD)	450	18	0.20	0.27	276	608	100	●	●	●	●	●#	●#	●#	●#
	600	24	0.31	0.40	326	719	100	●	●	●	●	●#	●#	●#	●#
	750	30	0.41	0.54	374	823	100	●	●	●	●	●#	●#	●#	●#
	900	36	0.53	0.69	423	932	100	⊖	⊖	⊙	⊙	⊙#	⊙#	●#	●#
	1050	42	0.65	0.84	469	1,034	100	○	○	○	○	⊖#	⊖#	⊖#	⊖#
	1200	48	0.76	1.00	510	1,125	100	◇*	◇*	◇*	○*	○*#	○*#	○*#	○*#
Severe Duty (SD)	600	24	0.31	0.40	367	810	90	●	●	●	●	●	●#	●#	●#
	750	30	0.41	0.54	425	936	90	●	●	●	●	●	●#	●#	●#
	900	36	0.53	0.69	483	1,065	90	⊖	⊙	⊙	⊙	⊙	●#	●#	●#
	1050	42	0.65	0.84	529	1,166	90	○	○	⊖	⊖	⊖#	⊖#	⊖#	⊖#
Maximum load pin on (payload + bucket)							kg	1292	1328	1366	1388	1410	1447	1488	1509
							lb	2,848	2,927	3,011	3,060	3,108	3,190	3,280	3,326

The above loads are in compliance with hydraulic excavator standard EN474, they do not exceed 87% of hydraulic lifting capacity or 75% of tipping capacity with front linkage fully extended at ground line with bucket curled.

Capacity based on ISO 7451.

Bucket weight with long tips.

*For General Duty applications.

#Consult dealer for maximum weight limitation (14 712 kg/32,440 lb) of ROPS certification.

Maximum Material Density:

- 2100 kg/m³ (3,500 lb/yd³)
- ⊙ 1800 kg/m³ (3,000 lb/yd³)
- ⊖ 1500 kg/m³ (2,500 lb/yd³)
- 1200 kg/m³ (2,000 lb/yd³)
- ◇ 900 kg/m³ (1,500 lb/yd³)

Caterpillar recommends using appropriate work tools to maximize the value customers receive from our products. Use of work tools, including buckets, which are outside of Caterpillar's recommendations or specifications for weight, dimensions, flows, pressures, etc. may result in less-than-optimal performance, including but not limited to reductions in production, stability, reliability, and component durability. Improper use of a work tool resulting in sweeping, prying, twisting and/or catching of heavy loads will reduce the life of the boom and stick.

Standard Equipment

Standard equipment may vary. Consult your Cat dealer for details.

CAB

- Pressurized operator station with positive filtration
- Sliding upper door window (left-hand cab door)
- Removable lower windshield with in cab storage bracket
- Coat hook
- Beverage holder
- Literature holder
- AM/FM radio
- Radio with MP3 auxiliary audio port
- Two stereo speakers
- Storage shelf suitable for lunch or toolbox
- Color LCD display with indicators, filter/fluid change, and working hour information
- Adjustable armrest
- Height adjustable joystick consoles
- Neutral lever (lock out) for all controls
- Travel control pedals with removable hand levers
- Capability of installing additional pedal
- Two power outlets, 10 amp (total)
- Travel alarm
- Laminated glass front upper window and tempered other windows

COUNTERWEIGHT

- 2.45 mt (2.7 t) without lifting eye

ELECTRICAL

- 80 amp alternator
- Circuit breaker
- Capability to electrically connect a beacon

ENGINE

- C3.4B diesel engine
- Biodiesel capable
- Meets EPA Tier 4 Final emission standards
- 2300 m (7,500 ft) altitude capability
- Manual priming pump
- Automatic engine speed control
- Economy and high power modes
- Two-speed travel
- Side-by-side cooling system
- Radial seal air filter
- Primary filter with water separator and water separator indicator
- Secondary filter
- Standard battery –18° C (0° F)

HYDRAULIC SYSTEM

- Regeneration circuit for boom and stick
- Reverse swing dampening valve
- Automatic swing parking brake
- High-performance hydraulic return filter
- Fine swing control

LIGHTS

- Halogen boom light (left side)
- Time delay function for boom light and cab light
- Exterior light

UNDERCARRIAGE

- Center track guiding guard
- Grease Lubricated Track GLT2, resin seal
- Towing eye on base frame

SECURITY

- Cat one key security system
- Door locks
- Cap locks on fuel and hydraulic tanks
- Lockable external tool/storage box
- Signaling/warning horn
- Secondary engine shutoff switch
- Openable skylight for emergency exit
- Rearview camera-ready

311F RR Optional Equipment

Optional Equipment

Optional equipment may vary. Consult your Cat dealer for details.

CAB

- Rear window for emergency exit
- Seat, high-back air suspension with heater and cooling
- Seat, high-back mechanical suspension
- Straight travel pedal
- Rain protector
- Cab mirror
- Ashtray
- Sunscreen

ENGINE

- Cold weather battery -25°C (-13°F)
- Jump start receptacle

FRONT LINKAGE

- Quick coupler
- Bucket linkage
- 4.3 m (14'1") Reach Boom
- 2.8 m (9'2") stick

HYDRAULIC SYSTEM

- Control pattern quick-changer, two way
- Auxiliary hydraulics
- Boom and stick lines
- High-pressure line
- Medium-pressure line
- Quick coupler line
- Boom lowering and stick lowering control valve

SECURITY

- FOGS, bolt-on
- Guard, cab front, mesh
- Guard, vandalism
- Side steel bumper
- Security system fitted (MSS)
- Bottom guards, heavy duty
- Rearview camera

TECHNOLOGY

- Product Link

LIGHTS

- Working light, cab mounted with time delay
- Halogen boom lights (right side)

UNDERCARRIAGE

- 500 mm (20") triple grouser shoes
- 600 mm (24") triple grouser shoes
- 700 mm (28") triple grouser shoes
- 770 mm (30") triple grouser shoes
- Rubber pad for 500 mm (20") triple grouser shoes
- 2500 mm (8'2") blade with replaceable cutting edge
- 2600 mm (8'6") blade with replaceable cutting edge
- 2700 mm (8'10") blade with replaceable cutting edge
- Swivel guard

For more complete information on Cat products, dealer services, and industry solutions, visit us on the web at www.cat.com

AEHQ7188-01 (11-2015)
Replaces AEHQ7188

© 2015 Caterpillar
All rights reserved

Materials and specifications are subject to change without notice. Featured machines in photos may include additional equipment. See your Cat dealer for available options.

CAT, CATERPILLAR, SAFETY.CAT.COM, their respective logos, "Caterpillar Yellow" and the "Power Edge" trade dress, as well as corporate and product identity used herein, are trademarks of Caterpillar and may not be used without permission.

VisionLink is a trademark of Trimble Navigation Limited, registered in the United States and in other countries.

